

HEIZKÖRPER NACH MASS

Bitte ausfüllen und zurück an Fax 062 797 25 07

Firma/Adresse
Firmenstempel

Name des Bearbeiters

Kundennummer

Ihre Auftragsnummer/Kommission

Lieferadresse (falls sie von der Rechnungsadresse abweicht)

Maße

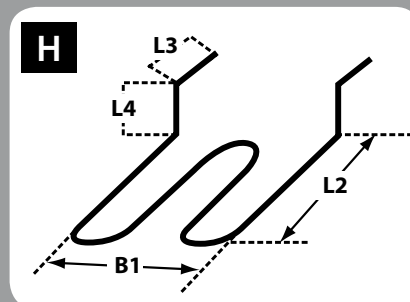
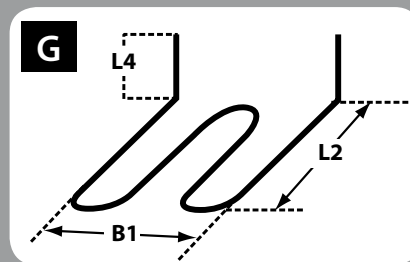
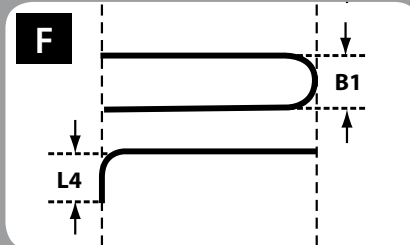
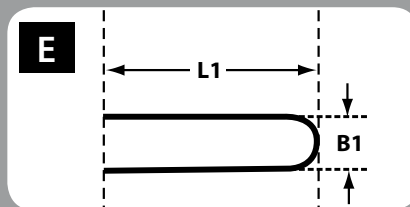
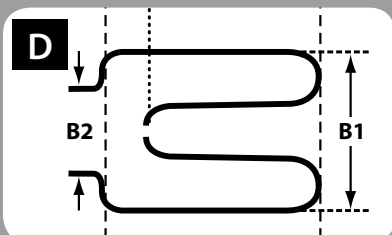
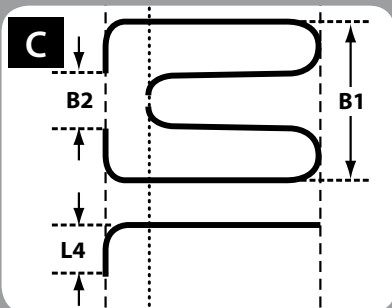
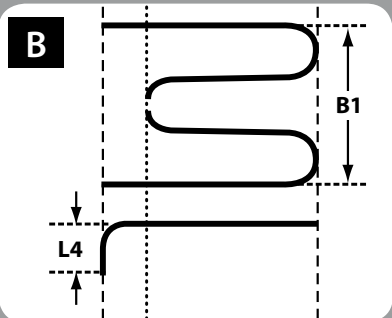
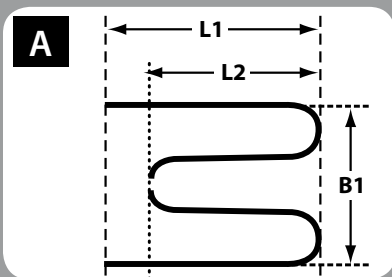

Anzahl:

..... Stück

Version:



Maße :

(Rohrende – ohne Keramik)

L1: mm

L2: mm

L3: mm

L4: mm

B1: mm

B2: mm

HEIZKÖRPER NACH MASS

Bitte ausfüllen und zurück an Fax 062 797 25 07

Anschlussstyp

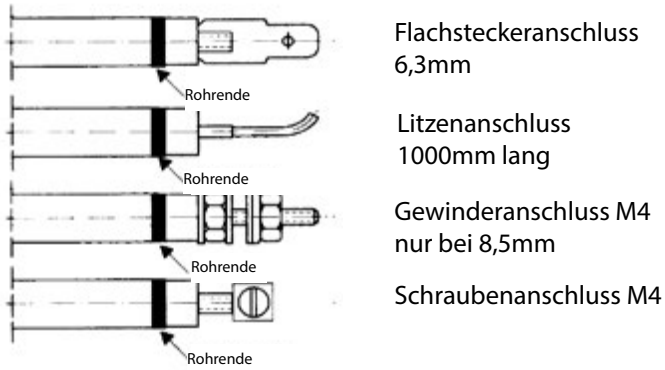

Technische Daten

MEDIUM:

In Wasser:
Material AISI 316TI 6,5mm 8,5mm

In Öl/Lauge/Salzwasser:
Material INCOLOY 825 6,5mm 8,5mm

In Luft:
Material AISI 309F 6,5mm 8,5mm
Material Kupfer
verchromt

Spannung: 230V 400V

Leistung: W

Anzahl Windungen:
(z. B. E = 1 Windung, A = 2 Windungen)

Verschraubungsvariante

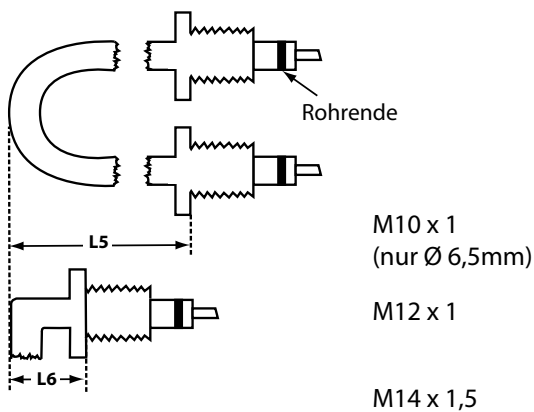

L5:mm

L6:mm