

Société/Adresse  
 Tampon de la société

Contact

N° de client

N° de votre commande

Adresse de livraison  
 (si différente de l'adresse de facturation)

### Dimensions

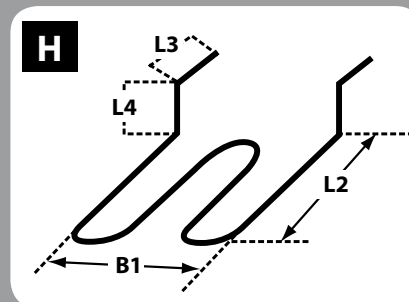
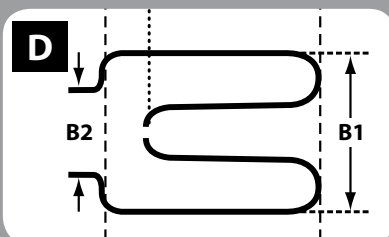
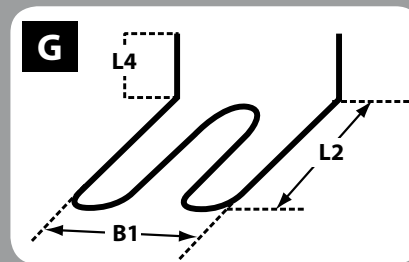
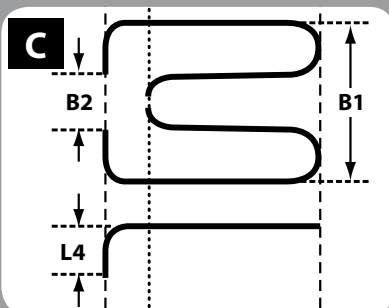
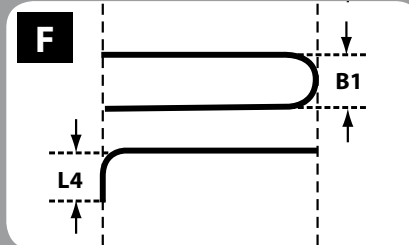
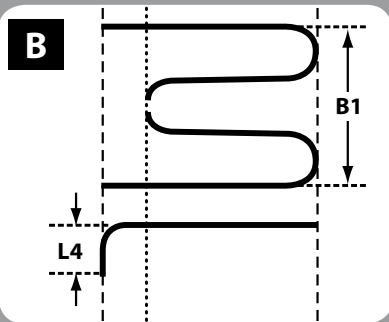
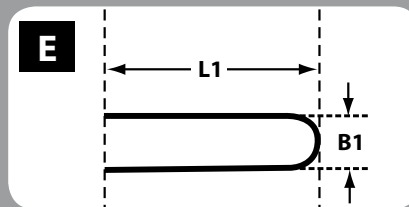
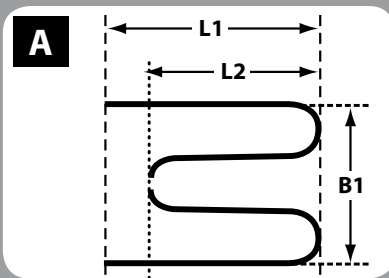

Quantité: ..... pièce(s)

Version:

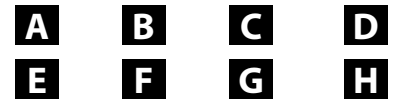

Dimensions :  
 (fin de tube sans céramique)

L1: ..... mm

L2: ..... mm

L3: ..... mm

L4: ..... mm

B1: ..... mm

B2: ..... mm

### type de raccordement

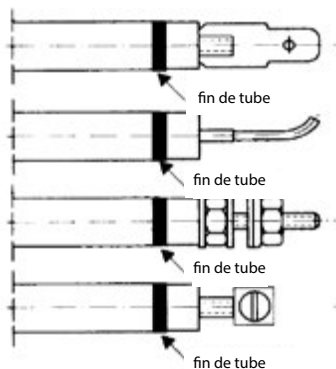

raccord taston 6,3mm

raccord fil de 1000mm

raccord vissé M4  
uniquement 8,5mm

raccord avec visse M4

### divers raccords à visse

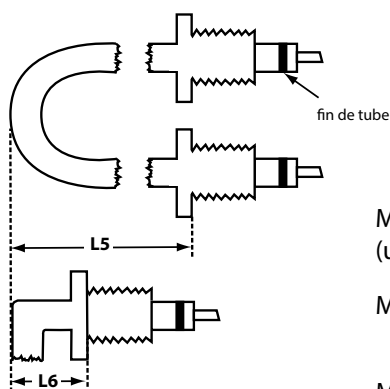

M10 x 1  
(uniquement Ø 6,5mm)

M12 x 1

M14 x 1,5

L5: .....mm

L6: .....mm

### données techniques

#### MEDIUM:

**eau :**  
**matériau AISI 316TI**                      6,5mm              8,5mm

**huile - eau avec détergent-eau salée :**  
**matériau INCOLOY 825**                      6,5mm              8,5mm

**air :**  
**matériau AISI 309F**                      6,5mm              8,5mm  
**matériau cuivre chromé**                      8,5mm

**tension :**    230V              400V

**puissance :**    ..... W

**nombre de boucles:**                                      .....  
(exemple : Modèle E = 1 boucle, A = 2 boucles)