

- ANFRAGE
- BESTELLUNG



# HEIZKÖRPER NACH MASS

Bitte ausfüllen und zurück an Fax 08142 6522-649

Firma/Adresse Firmenstempel	.....
	Name des Bearbeiters
	.....
	Kundennummer
.....	Ihre Auftragsnummer/Kommission
.....	Lieferadresse (falls sie von der Rechnungsadresse abweicht)

## Maße

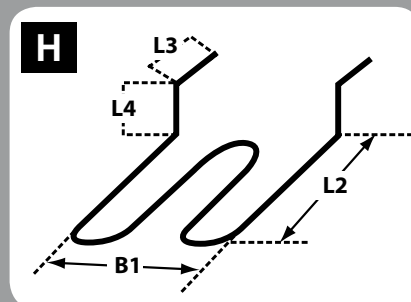
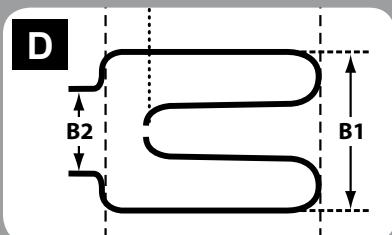
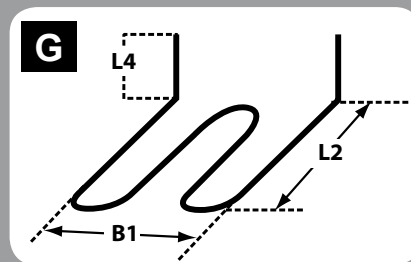
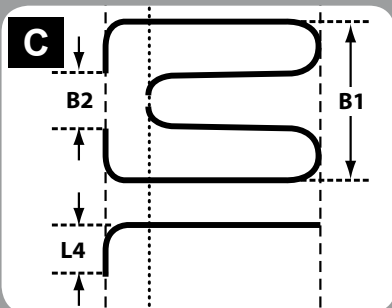
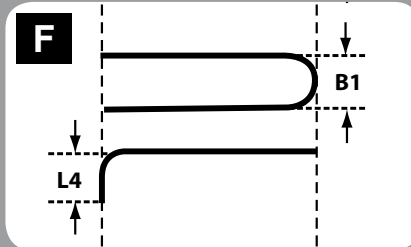
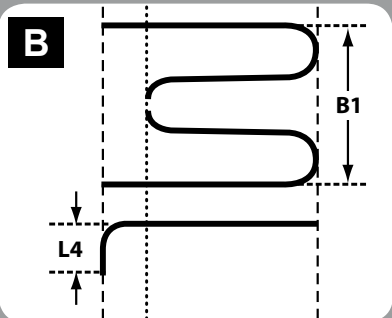
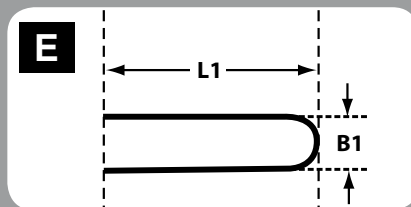
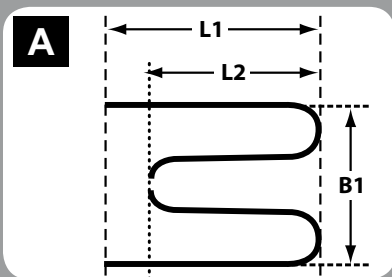

Anzahl: ..... Stück

Version:

<input type="checkbox"/> A	<input type="checkbox"/> B	<input type="checkbox"/> C	<input type="checkbox"/> D
<input type="checkbox"/> E	<input type="checkbox"/> F	<input type="checkbox"/> G	<input type="checkbox"/> H

Maße :

(Rohrende – ohne Keramik)

L1: ..... mm  
 L2: ..... mm  
 L3: ..... mm  
 L4: ..... mm

B1: ..... mm (außen)  
 B2: ..... mm (außen)

- ANFRAGE  
 BESTELLUNG

## HEIZKÖRPER NACH MASS



Bitte ausfüllen und zurück an Fax 08142 6522-649

### Anschlussstyp

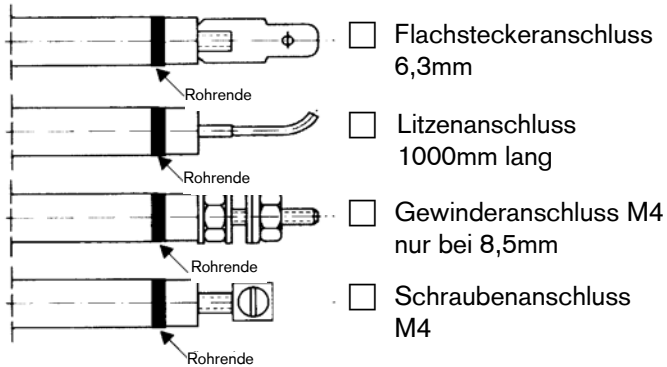

### Verschraubungsvariante

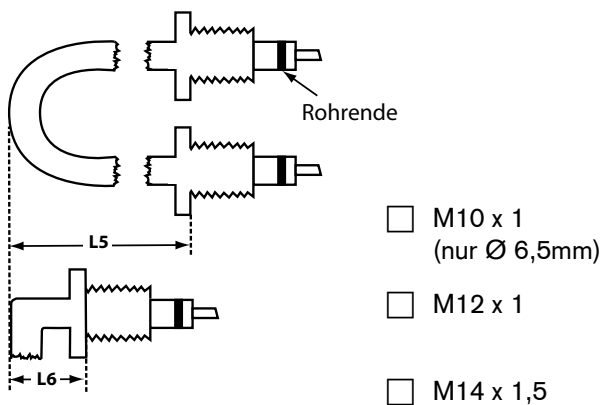

L5: .....mm

L6: .....mm

Länge des Gewindes: .....mm

Material vom Gewinde (z.B. Messing, Edelstahl): .....mm

### Technische Daten

**MEDIUM:**

**In Wasser:**  
**Material AISI 316TI**     6,5mm     8,5mm

**In Öl/Lauge/Salzwasser:**  
**Material INCOLOY 825**     6,5mm     8,5mm

**In Luft:**  
**Material AISI 309F**     6,5mm     8,5mm  
**Material Kupfer**  
**verchromt**     8,5mm

**Spannung:**     230V     400V

**Leistung:**    ..... W

**Anzahl Windungen:**    .....  
 (z. B. E = 1 Windung, A = 2 Windungen)