

## HEIZKÖRPER NACH MASS

Bitte ausfüllen und zurück an [bestellung@gev-online.de](mailto:bestellung@gev-online.de)

Firma/Adresse  
Firmenstempel

Name des Bearbeiters

Kundennummer

Ihre Auftragsnummer/Kommission

Lieferadresse (falls sie von der Rechnungsadresse abweicht)

### Maße

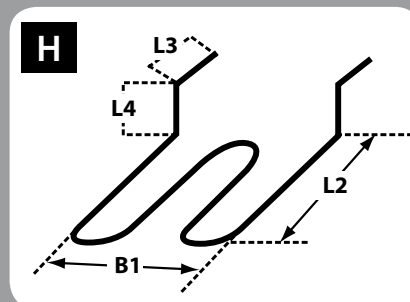
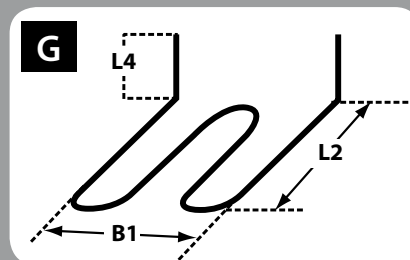
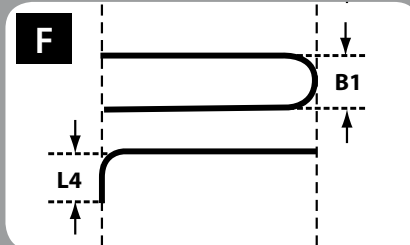
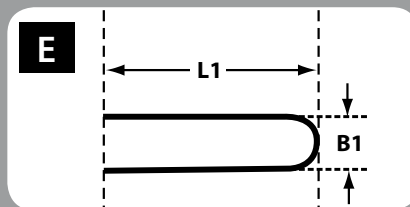
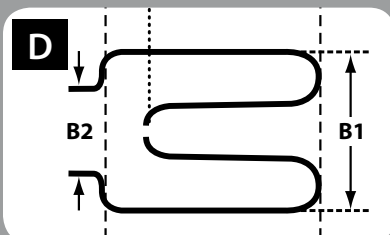
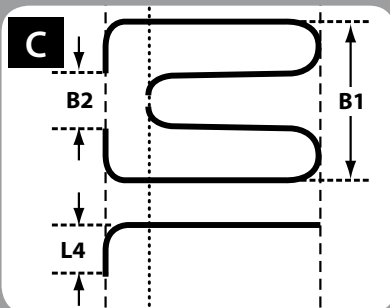
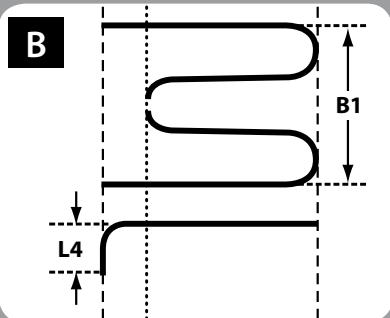
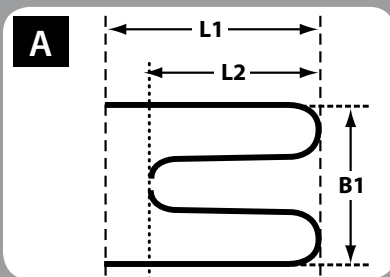

Anzahl:

..... Stück

Version:

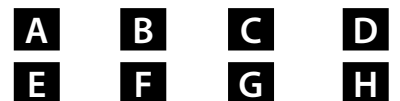

Maße :

(Rohrende – ohne Keramik)

L1: ..... mm

L2: ..... mm

L3: ..... mm

L4: ..... mm

B1: ..... mm

B2: ..... mm

Bitte ausfüllen und zurück an [bestellung@gev-online.de](mailto:bestellung@gev-online.de)

### Anschlussstyp

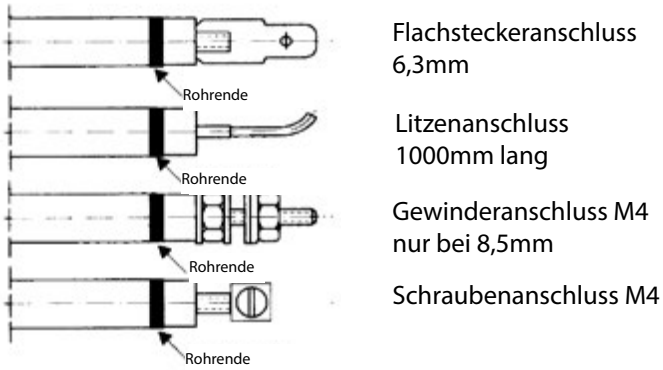

### Technische Daten

#### MEDIUM:

**In Wasser:**  
Material AISI 316TI                      6,5mm      8,5mm

**In Öl/Lauge/Salzwasser:**  
Material INCOLOY 825                      6,5mm      8,5mm

**In Luft:**  
Material AISI 309F                      6,5mm      8,5mm  
Material Kupfer  
verchromt

**Spannung:**                                      230V      400V

**Leistung:**                                      ..... W

**Anzahl Windungen:**                      .....  
(z. B. E = 1 Windung, A = 2 Windungen)

### Verschraubungsvariante

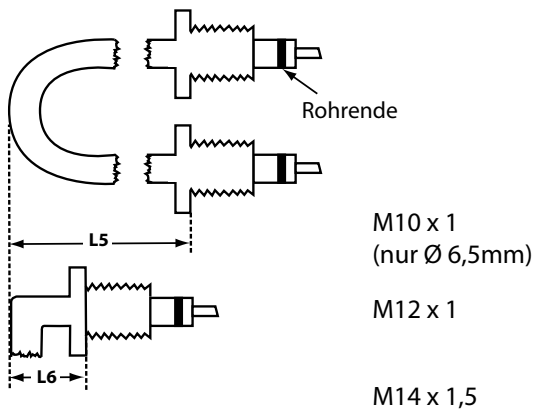

L5: .....mm

L6: .....mm