



# CUSTOM MADE HEATING ELEMENTS

**ENQUIRY**

**ORDER**

Please fill out and return to Fax: 01476 514640

Company/address Company stamp	Contact
	Customer number
	Your order number/reference
	Delivery address

## Dimensions

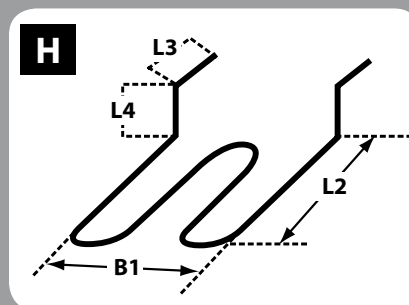
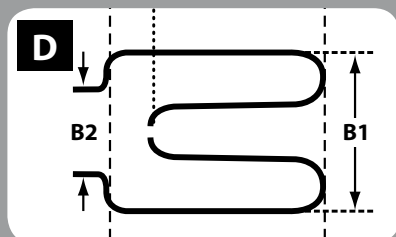
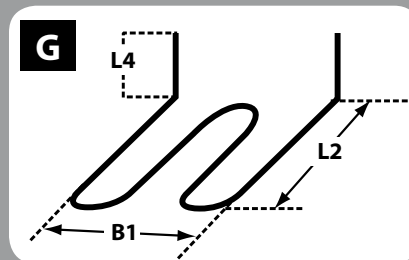
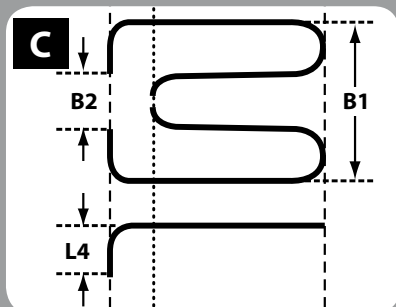
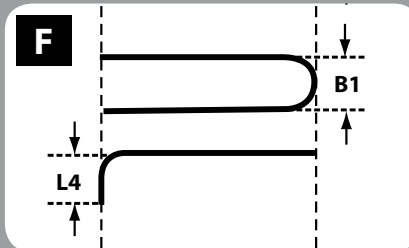
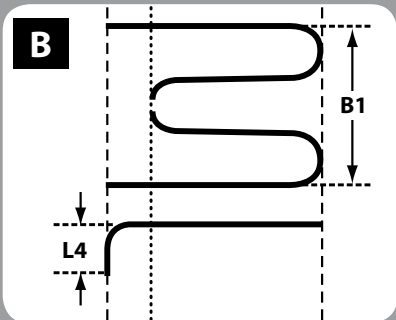
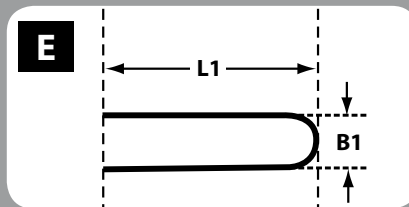
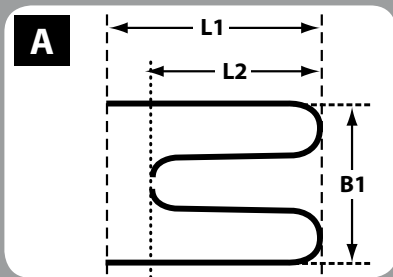

Quantity ..... Pcs

Type:

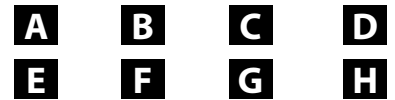

**Measurements :**

Element length  
(excluding ceramic connection)

L1: ..... mm

L2: ..... mm

L3: ..... mm

L4: ..... mm

B1: ..... mm

B2: ..... mm



# CUSTOM MADE HEATING ELEMENTS

—second page—

Please fill out and return to Fax: 01476 514640

## Connection type

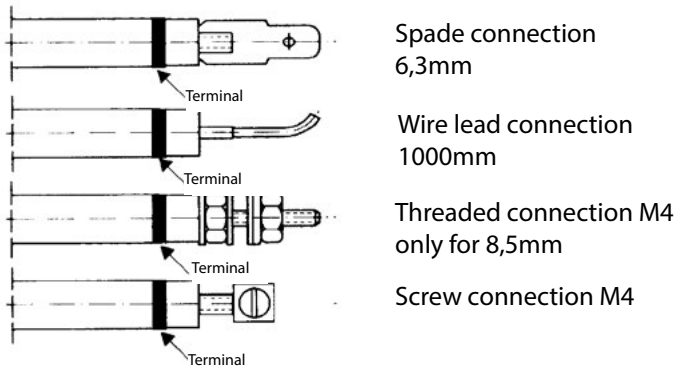

Spade connection  
6,3mm

Wire lead connection  
1000mm

Threaded connection M4  
only for 8,5mm

Screw connection M4

## Thread sizes

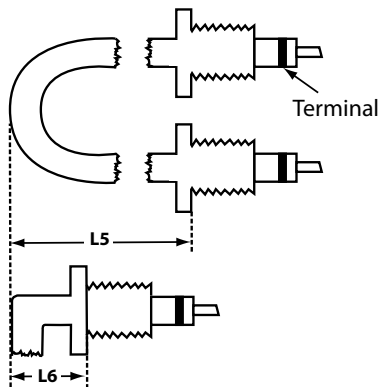

M10 x 1  
(only Ø 6,5mm)

M12 x 1

M14 x 1,5

L5: .....mm

L6: .....mm

## Technical data

### MEDIUM:

**Water:**  
AISI material 316Ti                      6,5mm              8,5mm

**Oil/salt solution/salt water:**  
Incoloy material 825                      6,5mm              8,5mm

**Air:**  
AISI material 309F                      6,5mm              8,5mm  
Copper material  
chrome-plated                      8,5mm

**Voltage:**                      230V              400V

**Rating:**                      ..... W

**Number of returns:**                      .....  
(e.g. E=1 return A=2 returns)