



RESISTANCES SUR MESURE

DEMANDE PRIX

COMMANDE

Société/Adresse
 Tampon de la société

Contact

N° de client

N° de votre commande

Adresse de livraison
 (si différente de l'adresse de facturation)

Dimensions

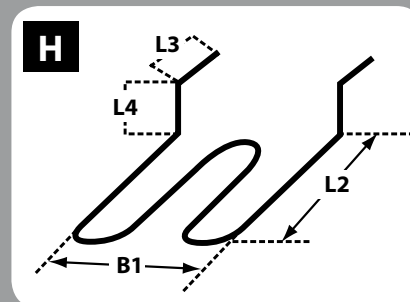
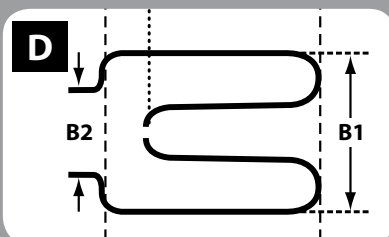
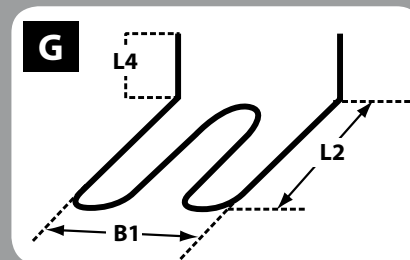
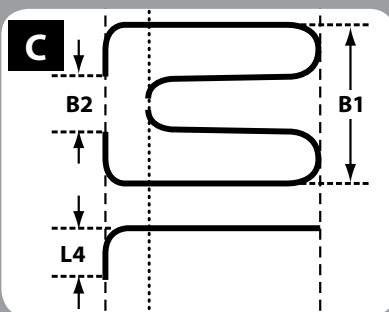
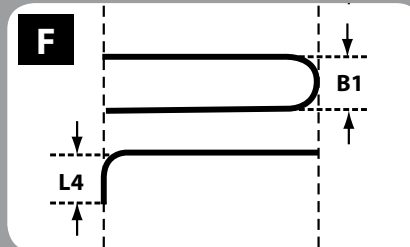
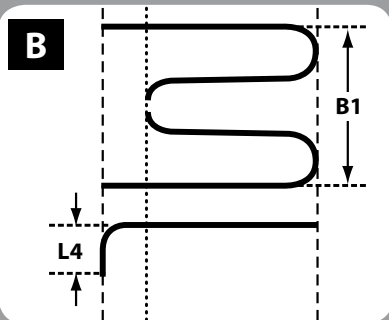
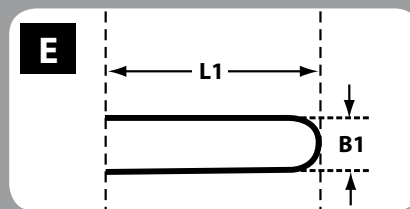
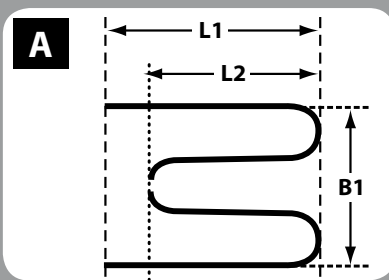

Quantité: pièce(s)

Version:



Dimensions :
 (fin de tube sans céramique)

L1: mm

L2: mm

L3: mm

L4: mm

B1: mm

B2: mm

type de raccordement

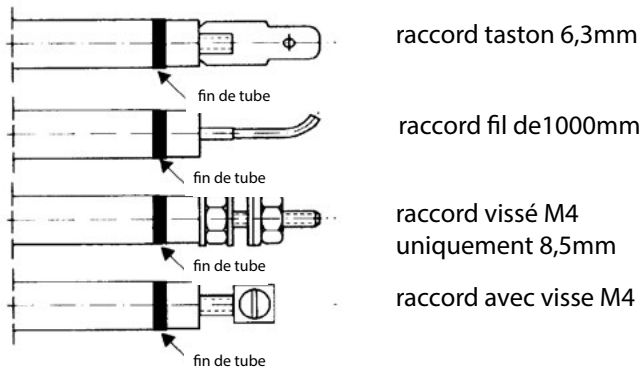

données techniques

MEDIUM:

eau :
matériau AISI 316TI 6,5mm 8,5mm

huile - eau avec détergent-eau salée :
matériau INCOLOY 825 6,5mm 8,5mm

air :
matériau AISI 309F 6,5mm 8,5mm
matériau cuivre chromé 8,5mm

tension : 230V 400V

puissance : W

nombre de boucles:
 (exemple : Modèle E = 1 boucle, A = 2 boucles)

divers raccords à visse

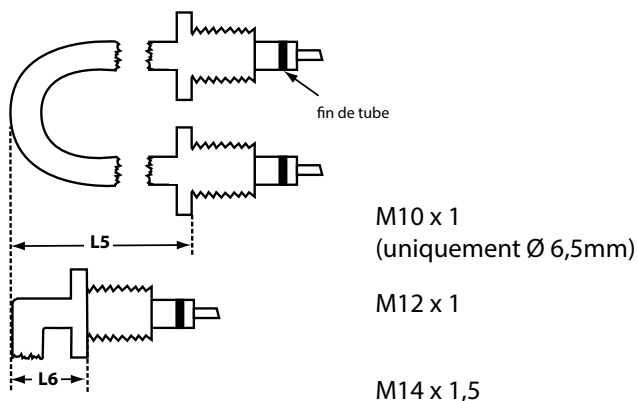

M10 x 1
 (uniquement Ø 6,5mm)

M12 x 1

M14 x 1,5

L5:mm

L6:mm