

RESISTENZE TUBOLARI SU MISURA

Società/Indirizzo
Timbro

Nome e cognome

Codice cliente

Indirizzo destinazione merce (se diverso da indirizzo di fatturazione)

Misure

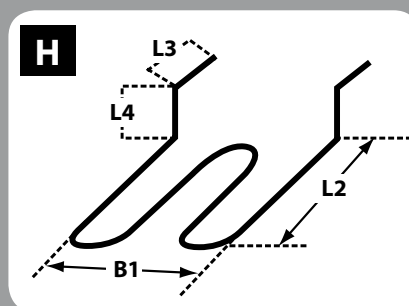
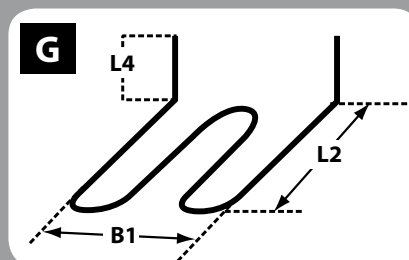
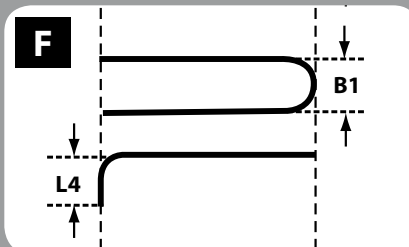
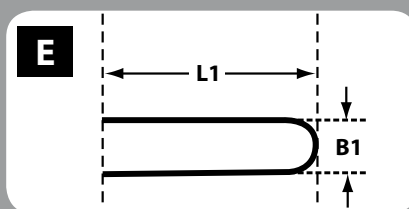
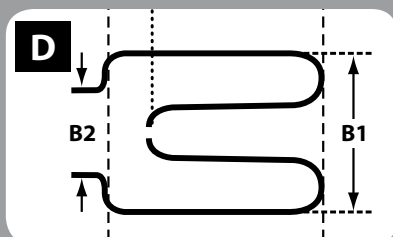
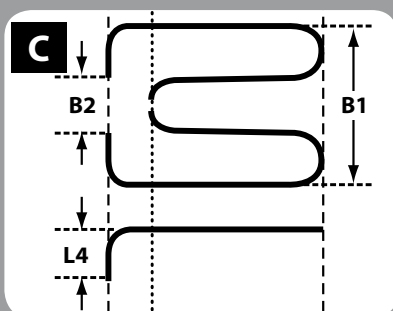
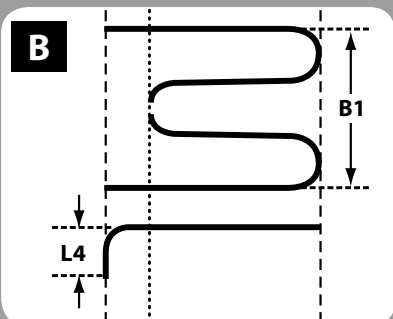
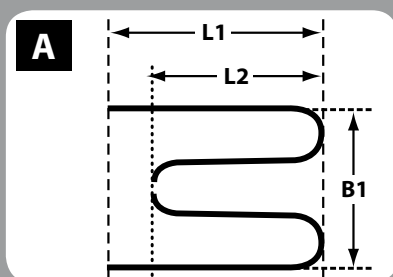

Quantità: Pz.....

Versione:

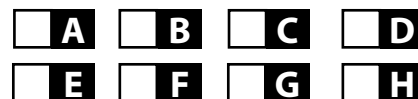

Misure:

(Tubo-senza ceramica)

L1: mm

L2: mm

L3: mm

L4: mm

B1: mm

B2: mm

Tipo di collegamento

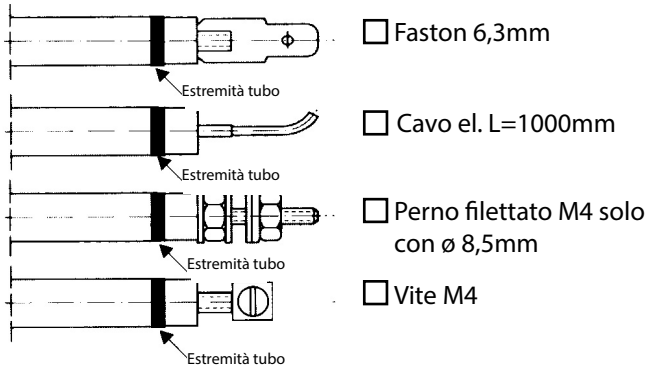

Fissaggio a raccordo

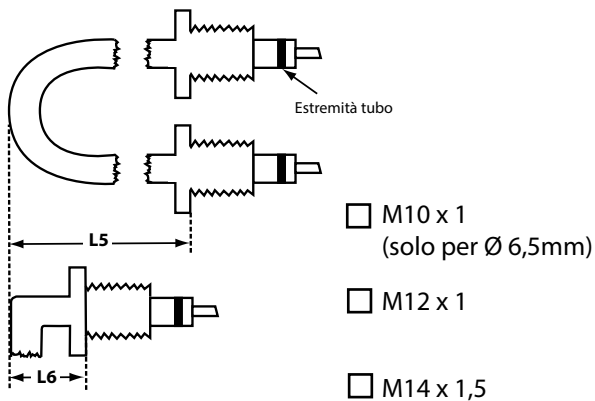

L5:mm

L6:mm

Dati tecnici

MEDIUM:

In acqua:
Materiale AISI 316TI 6,5mm 8,5mm

In Olio/Acqua/Acqua salata:
Materiale INCOLOY 825 6,5mm 8,5mm

In Aria:
Materiale AISI 309F 6,5mm 8,5mm
Materiale rame cromato 8,5mm

Voltaggio: 230V 400V

Potenza: W

numero spirali:
 (es. E=1 spirale, A= 2 spirali)