



Magnetventile

20

Magnetventile Wasser.....	648
Ablaufventile.....	664
Magnetventile Gas.....	665
Magnetventile Kälte.....	666
Magnetventile für Vakuumgeräte.....	668



Magnetventile

Magnetventile Wasser

EATON/INVENSYS

Temperatur Medium: 90°C 90°C 60°C
Temperatur Umgebung: 60°C 25°C 60°C
Einschaltdauer: 40% 100% 100%



Abb.	GEV-Nr.	Ausführung	Spng. (V)	Eingang	Ausgang (mm)	Nennweite
1	370723	1-fach	24	3/4"	11,5	DN10
1	370753	1-fach	24	3/4"	6	DN10
1	372017	1-fach	230	3/4"	11,5	DN10
1	372018	1-fach	230	3/4"	14	DN10
1	372046	1-fach	230	3/4"	14	DN10
2	372003	1-fach	230	3/4"	10	DN10
3	370724	2-fach	24	3/4"	11,5	DN10
3	372021	2-fach	230	3/4"	11,5	DN10
3	372022	2-fach	230	3/4"	14	DN10



Abb.	GEV-Nr.	Ausführung	Spng. (V)	Eingang	Ausgang (mm)	Nennweite
4	372025	3-fach	230	3/4"	11,5	DN10



Abb.	GEV-Nr.	Ausführung	Spng. (V)	Eingang	Ausgang (mm)	Nennweite
1	372015	1-fach	230	3/4"	11,5	DN10
1	372016	1-fach	230	3/4"	14	DN10
2	372019	2-fach	230	3/4"	11,5	DN10
2	372020	2-fach	230	3/4"	14	DN10
3	372023	3-fach	230	3/4"	11,5	DN10



Abb.	GEV-Nr.	Ausführung	Spng. (V)	Eingang	Ausgang (mm)	Nennweite	KL (mm)
1	370370	1-fach	230	3/4"	11,5	DN10	2000
2	370372	1-fach	230	3/4"	11,5	DN10	2000
3	370371	2-fach	230	3/4"	11,5	DN10	2000

mit kodierter Spule

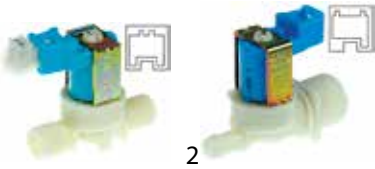

Technische Daten:
Spannung 230V

Abb.	GEV-Nr.	Ausführung	Eingang	Ausgang (mm)	Nennweite
1	370270	1-fach	3/8"	3/8"	DN10
2	370267	1-fach	3/4"	11,5	DN10

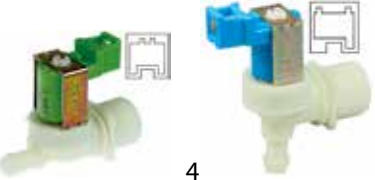

Technische Daten:
Spannung 230V

Abb.	GEV-Nr.	Ausführung	Eingang	Ausgang (mm)	Nennweite
3	370268	1-fach	3/4"	11,5	DN10
4	370355	1-fach	3/4"	11,5	DN10

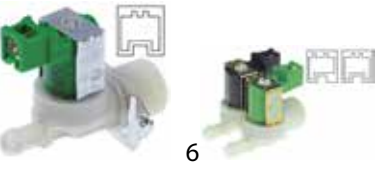

Technische Daten:
Spannung 230V

Abb.	GEV-Nr.	Ausführung	Eingang	Ausgang (mm)	Nennweite
5	370671	1-fach	3/4"	11,5	DN10
6	370266	2-fach	3/4"	11,5	DN10



Technische Daten:
Spannung 230V

Abb.	GEV-Nr.	Ausführung	Eingang	Ausgang (mm)	Nennweite
7	370269	2-fach	3/4"	11,5	DN10

Ersatzteile und Zubehör

Magnetspulen



Abb.	GEV-Nr.	Spng. (V)	Spannung	Abb.	GEV-Nr.	Spng. (V)	Spannung
1	371132	24	AC	2	371081	230	AC
1	371131	230	AC				



Magnetspulen kodiert

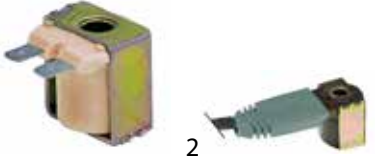

Abb.	GEV-Nr.	Spng. (V)	Spannung	Abb.	GEV-Nr.	Spng. (V)	Spannung
1	371133	230	AC	3	371174	230	AC
2	371134	230	AC				



Abb.	GEV-Nr.	Spng. (V)	Spannung
4	371175	230	AC

Reduzierungen

Ausgangsseite



Technische Daten:
Druckbereich 0 bis 10bar
Toleranz ±15/25%

Abb.	GEV-Nr.	Durchflussrate (l/min)	Farbe
1	371250	0,25	weiß
1	371251	0,5	gelb
1	371252	1,2	blau
1	371253	2,5	braun
1	371254	3,3	violett
1	371255	5	schwarz

Eingangsseite



Technische Daten:
Typ EATON (INVENSYS)
Toleranz ±15/25%

Abb.	GEV-Nr.	Durchflussrate (l/min)	Druckbereich (bar)	Farbe
1	371241	5,5	1-10	gelb
1	371243	10	1-10	weiß
1	371244	12	0 bis 10	weiß

ELBI

Temperatur Medium: 90°C 90°C 60°C
Temperatur Umgebung: 60°C 25°C 60°C
Einschaltdauer: 40% 100% 100%

gerade



Abb.	GEV-Nr.	Ausführung	Spng. (V)	Eingang	Ausgang (mm)	Nennweite
1	373017	1-fach	230	3/4"	11,5	DN10
1	373018	1-fach	230	3/4"	14	DN10
2	373021	2-fach	230	3/4"	11,5	DN10
2	373022	2-fach	230	3/4"	14	DN10
3	373025	3-fach	230	3/4"	11,5	DN10

gewinkelt



Abb.	GEV-Nr.	Ausführung	Spng. (V)	Eingang	Ausgang (mm)	Nennweite
1	374072	1-fach	24	3/4"	11,5	
2	370733	1-fach	24	3/4"	11,5	DN10
2	373015	1-fach	230	3/4"	11,5	DN10
2	373016	1-fach	230	3/4"	14	DN10
3	370712	2-fach	24	3/4"	11,5	DN10
3	373019	2-fach	230	3/4"	11,5	DN10



Abb.	GEV-Nr.	Ausführung	Spng. (V)	Eingang	Ausgang (mm)	Nennweite
4	373023	3-fach	230	3/4"	11,5	DN10

Ersatzteile und Zubehör

Magnetspulen



Abb.	GEV-Nr.	Spng. (V)	Spannung	Abb.	GEV-Nr.	Spng. (V)	Spannung
1	371014	24	AC	2	371016	230	AC



ELTEK

Temperatur Medium: 90°C 90°C 60°C
 Temperatur Umgebung: 60°C 25°C 60°C
 Einschaltdauer: 40% 100% 100%



Abb.	GEV-Nr.	Ausführung	Spng. (V)	Eingang	Ausgang (mm)	Nennweite
1	370750	1-fach	230	3/4"	11,5	DN10
1	370779	1-fach	230	3/4"	11,5	DN10
2	370781	2-fach	230	3/4"	11,5	DN10
3	370780	2-fach	230	3/4"	11,5	DN10
3	370778	2-fach	230	3/4"	11,5	DN10

INTERELEKTRIK

Temperatur Medium: 90°C 90°C 60°C
 Temperatur Umgebung: 60°C 25°C 60°C
 Einschaltdauer: 40% 100% 100%



Abb.	GEV-Nr.	Spng. (V)	Eingang	Ausgang (mm)
1	370688	220/240	3/4"	13,5

mit Reduzierung

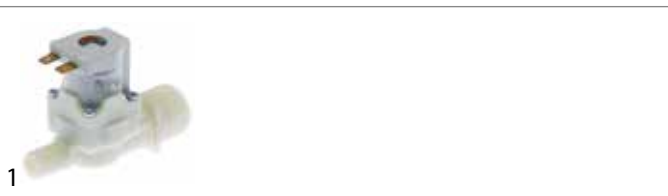

Abb.	GEV-Nr.	Spng. (V)	Eingang	Ausgang (mm)	Red. Eing. (l/min)	Red. Ausg. (l/min)
1	370675	230	3/4"	10,5	5	
1	370676	230	3/4"	10,5	15	
1	370746	220/240	3/4"	10,5		3
2	370747	220/240	3/4"	10,5		

MÜLLER

Temperatur-Medium: 90°C
 Einschaltdauer: 100%



Abb.	GEV-Nr.	Ausführung	Spng. (V)	Eingang	Ausgang (mm)	Nennweite
1	370751	1-fach	24	3/4"	3/4"	DN10
1	370005	1-fach	230	1/2"	1/2"	DN10
1	370007	1-fach	230	3/4"	3/4"	DN10
1	370173	1-fach	230	3/4"	3/4"	DN17
2	370002	1-fach	230	3/4"	14,5	DN10
2	370117	1-fach	230	3/4"	11,5	DN10
3	370715	1-fach	230	3/4"	3/8"	DN10



Abb.	GEV-Nr.	Ausführung	Spng. (V)	Eingang	Ausgang (mm)	Nennweite
4	370004	2-fach	230	3/4"	14,5	DN10
4	370158	2-fach	230	3/4"	11,5	DN10
5	370008	3-fach	230	3/4"	14,5	DN10
5	370172	3-fach	230	3/4"	11,5	DN10



Technische Daten:
Spannung 230V

Abb.	GEV-Nr.	Ausführung	Eingang	Ausgang (mm)	Nennweite
1	370001	1-fach	3/4"	14,5	DN10
1	370074	1-fach	3/4"	11,5	DN10
2	370003	2-fach	3/4"	14,5	DN10
2	370094	2-fach	3/4"	11,5	DN10

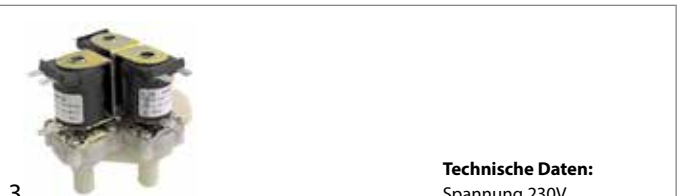

Technische Daten:
Spannung 230V

Abb.	GEV-Nr.	Ausführung	Eingang	Ausgang (mm)	Nennweite
3	370000	3-fach	3/4"	14,5	DN10



mit Kabelanschluss



1

Technische Daten:
Spannung 230V

Abb.	GEV-Nr.	Ausführung	Eingang	Ausgang (mm)	Nennweite	KL (mm)
1	370006	3-fach	3/4"	12,5	DN10	2000



1

Technische Daten:
Spannung 230V

Abb.	GEV-Nr.	Ausführung	Eingang	Ausgang (mm)	Nennweite	KL (mm)
1	370369	1-fach	3/4"	14,5	DN10	2000

Ersatzteile und Zubehör

Ventilkörper



1 2 3

Abb.	GEV-Nr.	Ausführung	Eingang	Ausgang (mm)	Nennweite
1	370127	1-fach	3/4"	14,5	DN10
1	370133	1-fach	3/4"	11,5	DN10
2	370667	1-fach	3/4"	3/4"	DN10
3	370179	1-fach	3/4"	3/4"	DN17



4 5

Abb.	GEV-Nr.	Ausführung	Eingang	Ausgang (mm)	Nennweite
4	370129	2-fach	3/4"	14,5	DN10
4	370195	2-fach	3/4"	11,5	DN10
5	370131	3-fach	3/4"	14,5	DN10
5	370132	3-fach	3/4"	11,5	DN10



1 2

Technische Daten:
Spannung 230V

Abb.	GEV-Nr.	Ausführung	Eingang	Ausgang (mm)	Nennweite
1	370126	1-fach	3/4"	14,5	DN10
1	370193	1-fach	3/4"	11,5	DN10
2	370128	2-fach	3/4"	14,5	DN10

Ersatzteilsets



1

Abb.	GEV-Nr.	Beschreibung
1	371011	Ersatzteilkit Membrane mit langem Stern

Magnetspulen



1 2

Abb.	GEV-Nr.	Spng. (V)	Spannung	Anschluss
1	371037	24	AC	F6,3
1	370570	24	DC	F6,3
1	371017	230	AC	F6,3
2	371038	230	AC	Gerätestecker

Reduzierungen

Ausgangsseite



1

Technische Daten:
Typ MR05
Einbaumaß 9,5mm
Nenndurchfluss bei 4bar
Druckbereich 1-10bar
Zulassung KTW

Abb.	GEV-Nr.	Durchflussrate (l/min)	Toleranz (%)	Farbe
1	371275	3	±20	violett
1	371277	5	±20	rot

Eingangsseite



1

Technische Daten:
Typ MR04
Einbaumaß 19mm
Nenndurchfluss bei 4bar
Zulassung KTW

Abb.	GEV-Nr.	Durchflussrate (l/min)	Druckbereich (bar)	Toleranz (%)	Farbe
1	371200	5	0 bis 10	±15	rot
1	371201	8	0 bis 10	±15	schwarz
1	371202	10	0 bis 10	±15	weiß
1	371203	12	1-10	±15	orange
1	371204	14	1-10	±15	hellblau
1	371205	15	1-10	±15	violett



1

Technische Daten:
Typ MR06
Einbaumaß 19mm
Nenndurchfluss bei 4bar
Zulassung KTW

Abb.	GEV-Nr.	Durchflussrate (l/min)	Druckbereich (bar)	Toleranz (%)	Farbe
1	371210	0,5	1-10	±50	gelb
1	371211	1	1-10	±30	pink
1	371213	1,9	1-10	±25	schwarz
1	371214	2,5	1-10	±20	grün
1	371215	3	1-10	±20	violett
1	371216	3,5	0 bis 10	±20	dunkelblau



Siebe



Abb.	GEV-Nr.	Beschreibung
1	501064	Magnetventilsieb
2	371122	Magnetventilsieb ø 19mm H 10mm für Müller
3	370551	Sieb für Magnetventil ø 12mm L 24mm

Sonstige



Abb.	GEV-Nr.	Beschreibung
1	371009	Druckfeder für Magnetspule
2	371002	Magnetventilhalter

RPE

Temperatur Medium: 90°C 90°C 60°C
 Temperatur Umgebung: 60°C 25°C 60°C
 Einschaltdauer: 40% 100% 100%



Abb.	GEV-Nr.	Ausführung	Spng. (V)	Eingang	Ausgang (mm)	Nennweite
1	374067	1-fach	230	3/8"	3/8"	DN10
1	370123	1-fach	230	1/2"	1/2"	DN10
1	374068	1-fach	230	3/4"	3/4"	DN10
2	374063	1-fach	230	3/8" IG	3/8" IG	DN11
3	370009	1-fach	230	3/4"	3/4"	DN10



Abb.	GEV-Nr.	Ausführung	Spng. (V)	Eingang	Ausgang (mm)	Nennweite
4	374017	1-fach	230	3/4"	10	DN10
4	374006	1-fach	230	3/4"	13	DN10
5	370441	1-fach	-	3/4"		
6	370758	2-fach	24	3/4"	10	DN10
6	374021	2-fach	230	3/4"	10	DN10
6	374022	2-fach	230	3/4"	13	DN10



Abb.	GEV-Nr.	Ausführung	Spng. (V)	Eingang	Ausgang (mm)	Nennweite
7	370760	2-fach	24	3/4"	10	DN10
8	370379	2-fach	230	3/4"	1/4"	DN10
9	374025	3-fach	230	3/4"	10	DN10



Abb.	GEV-Nr.	Ausführung	Spng. (V)	Eingang	Ausgang (mm)	Nennweite
1	374060	1-fach	24	3/4"	13	DN10
1	374016	1-fach	230	3/4"	13	DN10
2	374015	1-fach	230	3/4"	10	DN10
3	374019	2-fach	230	3/4"	10	DN10
3	374020	2-fach	230	3/4"	13	DN10



Abb.	GEV-Nr.	Ausführung	Spng. (V)	Eingang	Ausgang (mm)	Nennweite
4	371148	3-fach	230	3/4"	13	DN10
5	374027	4-fach	230	3/4"	10	DN10

JOHN GUEST



Abb.	GEV-Nr.	Ausführung	Spng. (V)	Eingang	Ausgang (mm)
1	370771	1-fach	230	3/4"	JG 8
1	374064	1-fach	230	3/4"	JG 10
2	374070	1-fach	230	JG 10	JG 10
2	374069	1-fach	230	JG 8	JG 8
3	370772	2-fach	230	3/4"	JG 8
3	374065	2-fach	230	3/4"	JG 10



Abb.	GEV-Nr.	Ausführung	Spng. (V)	Eingang	Ausgang (mm)
4	370773	3-fach	230	3/4"	JG 8
4	374066	3-fach	230	3/4"	JG 10



Abb.	GEV-Nr.	Ausführung	Spng. (V)	Eingang	Ausgang (mm)
1	370768 ¹	1-fach	230	3/4"	10
2	370769 ¹	2-fach	230	3/4"	10
3	374077 ¹	2-fach	230	3/4"	10

¹Ausgang zylindrisch



Abb.	GEV-Nr.	Ausführung	Spng. (V)	Eingang	Ausgang (mm)
4	370770 ¹	3-fach	230	3/4"	10

¹Ausgang zylindrisch

Spezialausgang



Abb.	GEV-Nr.	Ausführung	Spng. (V)	Eingang	Ausgang (mm)
1	371229	1-fach	24	3/4"	6,5
2	371228	2-fach	24	3/4"	6,5
3	371227	3-fach	24	3/4"	6,5





Abb.	GEV-Nr.	Ausführung	Spng. (V)	Eingang	Ausgang (mm)
4	370453	1-fach	230	11,5	11,5

Reduzierungen

Ausgangsseite

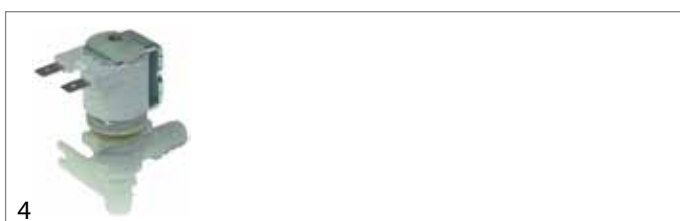

Pos.	GEV-Nr.	Durchflussrate (l/min)	Farbe
1	371269	0,15	braun
2	371266	0,2	rot
3	371268	0,25	grün
4	371265	3	schwarz
5	374084	7-10	orange
6	374088	0,6-0,7	grau
7	371249	0,7-1	hellgrau

Pos.	GEV-Nr.	Durchflussrate (l/min)	Farbe
8	371248	1,0-1,25	weiß
9	374087	1,5-1,85	gelb
10	374086	1,85-2,35	violett
11	374085	4,5-6	blau

Eingangsseite



Abb.	GEV-Nr.	Durchflussrate (l/min)	Farbe
1	371256	10-12	weiß
1	374083	18,5-20	schwarz
1	374080	4-4,5	gelb
1	374081	6-7	rot
1	374082	7-8,5	braun
2	371257	18,5-20	grau

Magnetspulen



Abb.	GEV-Nr.	Spng. (V)	Spannung	Abb.	GEV-Nr.	Spng. (V)	Spannung
1	370774	24	AC	1	371015	230	AC

TP

Temperatur Medium: 90°C 90°C 60°C
 Temperatur Umgebung: 60°C 25°C 60°C
 Einschaltdauer: 40% 100% 100%



Abb.	GEV-Nr.	Ausführung	Spng. (V)	Eingang	Ausgang (mm)	Nennweite
1	370029	1-fach	24	3/4"	11,5	DN10
1	370032	1-fach	24	3/4"	14	DN10
1	370017	1-fach	230	3/4"	11,5	DN10
1	370018	1-fach	230	3/4"	14	DN10
2	370111	2-fach	24	3/4"	11,5	DN10
2	370112	2-fach	24	3/4"	14	DN10
2	370022	2-fach	230	3/4"	14	DN10
2	370021	2-fach	230	3/4"	11,5	DN10
3	370115	3-fach	24	3/4"	11,5	DN10
3	370025	3-fach	230	3/4"	11,5	DN10
3	370026	3-fach	230	3/4"	14	DN10



Abb.	GEV-Nr.	Ausführung	Spng. (V)	Eingang	Ausgang (mm)	Nennweite
1	370030	1-fach	24	3/4"	11,5	DN10
1	370031	1-fach	24	3/4"	14	DN10
1	370015	1-fach	230	3/4"	11,5	DN10
1	370016	1-fach	230	3/4"	14	DN10
2	370109	2-fach	24	3/4"	11,5	DN10
2	370110	2-fach	24	3/4"	14	DN10
2	370019	2-fach	230	3/4"	11,5	DN10
2	370020	2-fach	230	3/4"	14	DN10
3	370113	3-fach	24	3/4"	11,5	DN10
3	370023	3-fach	230	3/4"	11,5	DN10
3	370024	3-fach	230	3/4"	14	DN10

Ersatzteile und Zubehör

Magnetspulen



Abb.	GEV-Nr.	Spng. (V)	Spannung	Abb.	GEV-Nr.	Spng. (V)	Spannung
1	371035	24	AC	1	371013	230	AC
1	371156	24	DC	1	371199	230	AC

Reduzierungen

Ausgangsseite



Abb.	GEV-Nr.	Durchflussrate (l/min)	Toleranz (%)	Farbe
1	691081	0,25	±25	grün
1	691080	3	±25	hellgrün
1	691082	8	±25	violett
2	371230	0,25	±25	rot
2	371233	0,8	±25	weiß
2	371234	1	±25	hellblau
2	371235	1,2	±25	braun
2	371236	1,5	±25	hellbraun
2	371237	2,5	±25	gelb
2	371238	3,4	±25	dunkelgrün
2	371239	5	±25	schwarz

Eingangsseite



Abb.	GEV-Nr.	Durchflussrate (l/min)	Toleranz (%)	Farbe
1	371220	3	±15	rot
1	371221	5,5	±15	gelb
1	371222	6	±15	grau
1	371223	10	±15	weiß
1	371224	12	±15	blau
1	371226	20	±15	brillantrot
1	371218	20	±15	orange

Diverse



Abb.	GEV-Nr.	Beschreibung
1	370636	Magnetventil 1-fach 2-Wege spezial Wechselausgang 230V Eingang 10,5mm Ausgang 10,5mm MILANO 00168401
2	370156	Magnetventil 1-fach gerade
3	370487	Magnetventil 1-fach gerade 24V AC Eingang 3/4" Ausgang 11,5mm DN10 T.max. 25°C



Abb.	GEV-Nr.	Beschreibung
4	372216	Magnetventil 1-fach gewinkelt 230V 3/4" ø11mm mit Pressostat
5	371141	Magnetventil 1-fach gewinkelt 240V Eingang 15mm Ausgang 11,5mm
6	370493	Magnetventil 1-fach gewinkelt 24V Eingang 5/8" UNFmm Ausgang 11,5mm Kunststoff



Abb.	GEV-Nr.	Beschreibung
7	370726	Magnetventil 2-fach gerade 220-240V AC Eingang 11 Ausgang 11mm Kunststoff MILANO Ausgang B rot
8	370310	Magnetventil 2-fach gerade mit Reduzierung
9	370673	Magnetventil 3-Wege 230V BÜRKERT



Abb.	GEV-Nr.	Beschreibung
10	370650	Magnetventil einfach gewinkelt 220/240V Ausgang 11mm Eingang 12,4mm 50/60Hz
11	370641	Magnetventil Kunststoff 220-240V Eingang 10mm Ausgang 10mm
12	370596	Magnetventil Kunststoff 230V AC

Metall

ASCO

2-Wege



Abb.	GEV-Nr.	Versorgung	Anschluss	DN (mm)	Steckbuchse	Temp. (°C)	Spulentyp	Membrane	p max (bar)
1	370509	24 VAC	1/2"	12,5	DIN	-20° bis +85		NBR (Wasser)	7
2	370786	230 VAC	1/2"				238613-059		
3	370121	230 VAC	1/2"	16	DIN	-20° bis +85	400425-217	NBR (Wasser)	9
3	370198	230 VAC	3/4"	19	DIN	-20° bis +85	400425-117	NBR (Wasser)	20
4	370124	230VAC		16	DIN	-20° bis +85	400325-110	NBR (Wasser)	10

3-Wege



Technische Daten:
 Temperaturbereich -20 bis +90°C
 Membrane NBR (Wasser)
 Druck max 3bar

Abb.	GEV-Nr.	Beschreibung	Versorgung	Anschluss	L (mm)	DN (mm)
1	370510	Magnetventil Material Messing Wegeanzahl 3 24V AC	24 VAC	1/4"	43	4,4

Magnetventile Dampf (Wasser)

2-Wege



Technische Daten:
 Steckbuchse DIN

Abb.	GEV-Nr.	Versorgung	Anschluss	DN (mm)	Temp. (°C)	Spulentyp	Membrane	p max (bar)
1	370728	24 VAC	1/2"	12	-10 bis +85	43005421	NBR	10
2	370134 ¹	230 VAC	1/2"	9,5	-20° bis 135	400425-117	PTFE (Wasser/Dampf)	2
3	370260	230 VAC	1/2"	16	-20° bis 184	400426-217	PTFE (Wasser/Dampf)	9
3	370258 ¹	230 VAC	3/4"	19	-20° bis 184	400425-117	PTFE (Wasser/Dampf)	9

¹stromlos offen



Ersatzteile und Zubehör

Magnetspulen



1

Abb.	GEV-Nr.	Spng. (V)	Spannung	Spulentyp
1	371136	230	AC	400425-217

O-Ringe



1

2

Abb.	GEV-Nr.	ID ø (mm)	VPE (Stück)	Abb.	GEV-Nr.	ID ø (mm)	VPE (Stück)
1	371095	6,07	1	2	371100	6,07	1

Steckdosen



1

Abb.	GEV-Nr.	Steckertyp	KL (mm)	Eigenschaft
1	371093	kompakt	1100	klein

BÜRKERT

2-Wege

Serie 6213



1

2

Technische Daten:
Steckbuchse DIN
Temperaturbereich -30° bis 120°C
Membrane EPDM
Druck max 10bar

Abb.	GEV-Nr.	Versorgung	Anschluss	DN (mm)
1	370274	230 VAC	1/2"	10
2	370275	230 VAC	3/4"	13

Magnetventile Dampf (Wasser)

2-Wege

Serie 0406



1

Technische Daten:
Steckbuchse
Temperaturbereich 180°C
Druck max bar

Abb.	GEV-Nr.	Versorgung	Anschluss	DN (mm)	Membrane
1	370276	230 VAC	1/2"	12	PTFE

Magnetventile diverse



1

2

3

Abb.	GEV-Nr.	Beschreibung
1	370143	Magnetventil 2-Wege 196V DC BÜRKERT
2	370741	Magnetventil 2-Wege 230 VAC Eingang 1/2" IG
3	370464	Magnetventil Messing 2-Wege 24V AC Anschluss 1/2"



4

Abb.	GEV-Nr.	Beschreibung
4	370544	Magnetventil Messing 2-Wege 24V Eingang 1/2"

CEME

Magnetventile



1

2

3

Abb.	GEV-Nr.	Beschreibung
1	370348	Magnetventil 2-Wege 230 VAC Anschluss 1/2" L 60mm
2	370352	Magnetventil 2-Wege 230 VAC Eingang 1/2" IG
3	370238	Magnetventil Messing 3-Wege



4

Abb.	GEV-Nr.	Beschreibung
4	370633	Magnetventil Messing 3-Wege 230V AC Anschluss 1/8"

Zubehör



1

2

3

Abb.	GEV-Nr.	Beschreibung
1	371189	Magnetspule 240V Aufnahme ø 13mm
2	371154	Magnetspule CEME Typ 1W7 230V AC 50Hz
3	371188	Magnetspule Typ H 230V 17VA 50Hz Aufnahme ø 13mm



LUCIFER

2-Wege

Serie 121K



Technische Daten:
Temperaturbereich -20° bis +130°C

Abb.	GEV-Nr.	Versorgung	Anschluss	DN (mm)	Spulentyp	Membrane	p max (bar)
1	370224	24 VAC	1/8"	3	DZ02A2	FKM (Wasser)	10
1	370072	230 VAC	1/8"	3	DZ06S6	FKM (Wasser)	10
1	370088	230 VAC	1/4"	3	DZ06S6	FKM (Wasser)	10
2	370708	230 VAC	1/4"	5		EPDM	7

Serie 121Z



Technische Daten:
Länge mm
Nennweite 2,5mm
Steckbuchse DIN
Temperaturbereich -20° bis +130°C
Druck max 10bar

Abb.	GEV-Nr.	Versorgung	Anschluss	Spulentyp	Membrane
1	370230	24VDC	1/8"	DZ02C2	FKM (Wasser)
1	370071	230 VAC	1/8"	DZ06S6	FKM (Wasser)

Serie 7321(PM133)



Technische Daten:
Länge 100mm
Nennweite 20mm
Steckbuchse DIN
Temperaturbereich fest 90°C
Druck max 20bar

Abb.	GEV-Nr.	Versorgung	Anschluss	Spulentyp	Membrane
1	371184	24 VAC	3/4"	DZ02A2	NBR (Wasser)
1	371183	230 VAC	3/4"	DZ06S6	NBR (Wasser)

2-Wege

Serie 121F



Technische Daten:
Wegeanzahl 2-Wege
Versorgung 230 VAC
Nennweite 3,5mm
Steckbuchse DIN
Temperaturbereich -10 bis +140°C
Druck max 10bar
Flanschmaß 32x32mm

Abb.	GEV-Nr.	Spulentyp	Membrane
1	370211	DZ06S6	Rubin

Serie 7321(PM143)



Technische Daten:
Steckbuchse DIN
Temperaturbereich fest 140°C
Membrane EPDM (Dampf/Wasser)
Druck max 10bar

Abb.	GEV-Nr.	Versorgung	Anschluss	DN (mm)	Spulentyp
1	371186	230 VAC	1/2"	12	DZ06S6
1	371187	230 VAC	3/4"	20	DZ06S6



Technische Daten:
Steckbuchse DIN
Temperaturbereich fest 90°C
Membrane NBR (Wasser)
Druck max 20bar

Abb.	GEV-Nr.	Versorgung	Anschluss	DN (mm)	Spulentyp
1	371182	24 VAC	1/2"	12	DZ02A2
1	371179	230 VAC	3/8"	12	DZ06S6
1	371181	230 VAC	1/2"	12	DZ06S6

3-Wege

Serie 131F



Technische Daten:
Temperaturbereich -10 bis +140°C
Druck max 10bar
Flanschmaß 32x32mm

Abb.	GEV-Nr.	Versorgung	DN (mm)	Spulentyp	Membrane
1	370054	24 VAC	2,5	DZ06P0	FKM(Wasser/Dampf)
1	370051	24VDC	2,5	DZ02C2	FKM(Wasser/Dampf)
2	370593 ¹	24 VAC	1,5/2,5	483510P0 XS03M F	Rubin

¹vernickelt



Technische Daten:
Temperaturbereich -10 bis +140°C
Druck max 10bar
Flanschmaß 32x32mm

Abb.	GEV-Nr.	Versorgung	DN (mm)	Spulentyp	Membrane
3	370053	230 VAC	2,5	DZ06S6	FKM(Wasser/Dampf)
4	370776	230 VAC	1,5/2,5	DZ06S6	Rubin



Ersatzteile und Zubehör

Magnetspulen



Abb.	GEV-Nr.	Spng. (V)	Spannung	Leistung (VA)	Spulentyp
1	371031	230	AC	9	DZ06S6
1	371032	24	AC	9	DZ06P0
1	371043	24	DC	9	DZ02C2
2	371083	24	AC	9	DZ02A2
3	371258	220	AC	14	EZ92A7

Ventilkörper



Abb.	GEV-Nr.	Beschreibung
1	370061	Magnetventilkörper LUCIFER-PARKER 3-Wege

M&M

2-Wege

Serie B-240



Technische Daten:
 Temperaturbereich -20° bis +130°C
 Spulentyp 2700
 Membrane FKM (Wasser)
 Druck max 18bar
 Druck min 0bar

Abb.	GEV-Nr.	Versorgung	DN (mm)	Flansch (mm)
1	370068	230 VAC	1,5	32x32

Serie B-297



Technische Daten:
 Temperaturbereich -10 bis +130°C
 Spulentyp 2700
 Membrane FKM (Wasser)
 Druck max 5bar
 Druck min 0bar

Abb.	GEV-Nr.	Versorgung	Anschluss	L (mm)	DN (mm)
1	370096	230 VAC	1/8"	30	2,5

Serie B204/205/206



Technische Daten:
 Temperaturbereich -10 bis +90°C
 Spulentyp 2700
 Membrane NBR (Wasser)
 Druck max 16bar
 Druck min 0,3bar

Abb.	GEV-Nr.	Versorgung	Anschluss	L (mm)	DN (mm)
1	370075	230 VAC	1/2"	67	12
1	370076	230 VAC	3/4"	82	25

Serie D-249



Technische Daten:
 Temperaturbereich -20° bis +130°C
 Spulentyp 8700
 Membrane FKM (Wasser)
 Druck max 8bar
 Druck min 0bar

Abb.	GEV-Nr.	Versorgung	Anschluss	L (mm)	DN (mm)
1	370098	230 VAC	1/4"	38	3

Serie D-287/288/289/290/292/293



Technische Daten:
 Temperaturbereich -10 bis +130°C
 Spulentyp 7700
 Membrane FKM (Wasser)
 Druck max 16bar
 Druck min 0bar

Abb.	GEV-Nr.	Versorgung	Anschluss	L (mm)	DN (mm)
1	370044	230 VAC	3/4"	85	15

3-Wege

Serie B-397



Technische Daten:
 Temperaturbereich -20° bis +130°C
 Spulentyp 2700
 Membrane FKM (Wasser)
 Druck max 10bar
 Druck min 0bar

Abb.	GEV-Nr.	Versorgung	Anschluss	L (mm)	DN (mm)
1	370214	230 VAC	1/8"	30	1,5



Ersatzteile und Zubehör					
Magnetspulen					
Abb.	GEV-Nr.	Spng. (V)	Spannung	Leistung (VA)	Spulentyp
1	371023	24	AC	10	2200
1	371027	24	AC	18	7200/7201
1	371022	230	AC	10	2700
1	371026	230	AC	18	7700
2	371024	230	AC	12	8700

MÜLLER						
2-Wege						
Abb.	GEV-Nr.	Versorgung	Eingang	Ausgang	L (mm)	Ausführung
1	370069 ¹	230 VAC	1/8" IG	1/8" IG	30	Wasser
2	370036	230 VAC	3/4" AG	1/2" IG	57	Wasser

¹mit Stellschraube

ODE					
2-Wege					
Technische Daten: Versorgung 230 VAC Temperaturbereich -10 bis +90°C					
Abb.	GEV-Nr.	Anschluss	L (mm)	DN (mm)	
1	370653	1/2"	66	13	

Magnetventile Dampf (Wasser)						
Serie 212A						
Technische Daten: Länge 46mm Temperaturbereich °C Druck max 5bar Druck min bar						
Abb.	GEV-Nr.	Versorgung	Anschluss	DN (mm)	Spulentyp	Membrane
1	370719	230 VAC	Flachsteckhülse 6,3mm	4,5	BDA	

Serie 21A						
Technische Daten: Länge 40mm Temperaturbereich -10 bis +140°C Membrane FKM(Wasser/ Dampf)						
Abb.	GEV-Nr.	Versorgung	Anschluss	DN (mm)	Spulentyp	p max (bar)
1	370208	230 VAC	1/8"	2,5	BDA	14
1	370145	230 VAC	1/4"	3	BDV	10

Serie 21J					
Technische Daten: Länge 30mm Temperaturbereich -10 bis +140°C Druck max 18bar					
Abb.	GEV-Nr.	Versorgung	Anschluss	DN (mm)	Membrane
1	370232	230 VAC	1/8"	2,3	FKM

Serie 31A					
Technische Daten: Länge 40mm Temperaturbereich -10 bis +140°C Membrane FKM(Wasser/ Dampf) Druck max 10bar Druck min bar					
Abb.	GEV-Nr.	Versorgung	Anschluss	DN (mm)	Spulentyp
1	370616	230 VAC	1/4"	2	BDA

Serie 31A1						
Technische Daten: Temperaturbereich -10 bis +140°C Flanschmaß 32x32mm						
Abb.	GEV-Nr.	Versorgung	DN (mm)	Spulentyp	Membrane	p max (bar)
1	370583	24 VAC	1,5	BDA	Rubin	15
1	370125	24VDC	2,5	BDA	FKM(Wasser/Dampf)	6
1	370203	230 VAC	2,5	BDV	FKM(Wasser/Dampf)	6

Serie 5005A					
Technische Daten: Membrane FKM(Wasser/ Dampf) Druck max 15bar					
Abb.	GEV-Nr.	Versorgung	DN (mm)	Temp. (°C)	Spulentyp
1	370541	230VAC	1,5	-10 bis +140	BDA



Ersatzteile und Zubehör

Dichtungen



Abb.	GEV-Nr.	ø (mm)	Anwendung
1	371196	12	für Ventilkörper

Magnetspulen



Abb.	GEV-Nr.	Spng. (V)	Spannung	Leistung (VA)	Aufnahme ø (mm)
1	371152	24	DC	8	12
1	371150	230	AC	8	13,5
1	371191	230	AC	10	10

Ventileinsätze



Abb.	GEV-Nr.	L (mm)	ø (mm)	Dichtung	Abb.	GEV-Nr.	L (mm)	ø (mm)	Dichtung
1	371195	24	9	Viton	2	371193	30	12	Viton

Ventilkörper



Abb.	GEV-Nr.	Beschreibung	ø (mm)
1	371194	Magnetventilkörper ø 10mm	10
2	371192	Magnetventilkörper ø 13mm	13

PARKER

2-Wege

Serie 7121



Abb.	GEV-Nr.	Versorgung	Anschluss	DN (mm)	Spulentyp
1	370584	230 VAC	1/8"	1,5	BDA
2	370767	220-240VAC	1/8"	1,5	483510S6 XS03XS6 F

Technische Daten:
Druck max 15bar

Serie N74.BV



Technische Daten:
Temperaturbereich -10 bis +140°C
Druck max 15bar

Abb.	GEV-Nr.	Versorgung	Anschluss	DN (mm)	Spulentyp	Membrane
1	374061	230VAC	1/8"	2	WB4.5	FKM(Wasser/Dampf)

Serie VE-123



Technische Daten:
Temperaturbereich -10 bis +140°C
Membrane Viton
Druck max 5bar

Abb.	GEV-Nr.	Versorgung	Anschluss	L (mm)	DN (mm)	Spulentyp
1	370727	230 VAC	1/2"	72	13	ZB09

Serie VE-125



Technische Daten:
Steckbuchse DIN
Temperaturbereich -20° bis +130°C
Membrane FKM (Wasser)
Druck max 10bar

Abb.	GEV-Nr.	Versorgung	Anschluss	DN (mm)	Spulentyp
1	370202	230 VAC	-	2,5	ZB09

Serie VE-131



Technische Daten:
Steckbuchse
Temperaturbereich °C
Membrane
Druck max bar

Abb.	GEV-Nr.	Versorgung	Anschluss	DN (mm)	Spulentyp
1	370549	230 VAC	-	-	KT09

Serie VE-140



Technische Daten:
Steckbuchse DIN
Temperaturbereich -10 bis +140°C
Spulentyp ZB09
Membrane Rubin

Abb.	GEV-Nr.	Versorgung	Anschluss	DN (mm)	p max (bar)
1	370140	230 VAC	1/8"	2,5	
2	370220	230 VAC	1/8"	2,5	30

3

Technische Daten:
Steckbuchse DIN
Temperaturbereich -10 bis +140°C
Spulentyp ZB09
Membrane Rubin

Abb.	GEV-Nr.	Versorgung	Anschluss	DN (mm)	p max (bar)
3	370141 ¹	230 VAC	1/4"	3	8

¹Edelstahlgehäuse

Serie VE-146



1

Technische Daten:
Steckbuchse DIN
Temperaturbereich -20° bis +130°C
Membrane FKM (Wasser)

Abb.	GEV-Nr.	Versorgung	Anschluss	DN (mm)	Spulentyp	p max (bar)
1	370066	24 VAC	1/8"	2,5	ZB09	15
1	370034	24 VAC	1/4"	3	ZB09	10
1	370221	24VDC	1/4"	3	ZB12	8
1	370206	230 VAC	1/8"	2,5	ZB09	15
1	370303	230 VAC	1/8"	3	ZB09	10
1	370067	230 VAC	1/4"	3	ZB09	7

Serie VE-161



1

Technische Daten:
Steckbuchse
Temperaturbereich -10 bis +140°C
Membrane FKM
Druck max 10bar

Abb.	GEV-Nr.	Versorgung	Anschluss	DN (mm)	Spulentyp
1	370566	230 VAC	1/4"	2,20	KT09

Serie VE-175BV



1

Technische Daten:
Temperaturbereich -10 bis +140°C
Membrane FKM(Wasser/ Dampf)
Druck max 15bar
Druck min 0bar

Abb.	GEV-Nr.	Versorgung	Anschluss	DN (mm)	Spulentyp
1	370576	230 VAC	-	2	WB4.5

3-Wege

Serie 121 KS8358



1

Abb.	GEV-Nr.	Beschreibung
1	370709	Magnetventil Messing 3-Wege 230V AC

Serie 301X



1

Abb.	GEV-Nr.	Versorgung	Anschluss	DN (mm)	Temp. (°C)
1	370785	24 VAC	-	-	-10° bis +140

Serie N79.6QV



1

Technische Daten:
Steckbuchse
Temperaturbereich -10 bis +140°C
Membrane FKM(Wasser/ Dampf)
Druck max 15bar

Abb.	GEV-Nr.	Versorgung	DN (mm)	Spulentyp
1	374062	230VAC	1	WB4.5

Serie VE-128



1 **2**

Technische Daten:
Steckbuchse DIN
Temperaturbereich -20° bis 140°C
Druck max 10bar

Abb.	GEV-Nr.	Versorgung	DN (mm)	Spulentyp	Membrane
1	370050	24 VAC	1,2	ZB09	Rubin
1	370058	24VDC	1,2	ZB12	Rubin
1	370057	230 VAC	1,2	ZB09	Rubin
2	370587	230 VAC	1,20	ZB09	Rubin

Serie VE-175BV



3 **4**

Technische Daten:
Steckbuchse DIN
Temperaturbereich -20° bis 140°C
Druck max 10bar

Abb.	GEV-Nr.	Versorgung	DN (mm)	Spulentyp	Membrane
3	370060	230 VAC	1,2	YB09 mit Kabel	Viton
4	370759	230 VAC	1,2	ZB09	Rubin



Serie VE-141



Technische Daten:
Steckbuchse DIN
Temperaturbereich -20° bis +130°C
Membrane FKM (Wasser)

Abb.	GEV-Nr.	Versorgung	Anschluss	DN (mm)	Spulentyp	p max (bar)
1	370212	230 VAC	1/8"	2	ZB09	10
1	370059	230 VAC	1/4"	2	ZB09	10
1	370550	230 VAC	1/4"	3	ZB09	3
1	374076	230VAC	1/4"	2,5	ZB09	0

Serie VE-148



Technische Daten:
Temperaturbereich -10° bis +140°C

Abb.	GEV-Nr.	Versorgung	Anschluss	L (mm)	DN (mm)
1	370718	230 VAC	1/8"	30	-

Magnetventile diverse



Abb.	GEV-Nr.	Beschreibung
1	370497	Magnetventil 2-Wege 230 VAC Anschluss 1/8" L 30mm
1	370749	Magnetventil 2-Wege 230 VAC Eingang 1/8"
2	526331	Magnetventil 2-Wege 230 VAC Anschluss 1/8" L 68mm
3	370525	Magnetventil Messing 3-Wege 110V AC

Ersatzteile und Zubehör

Magnetspulen



Abb.	GEV-Nr.	Beschreibung
1	371082	Magnetspule 110V AC 9VA 60Hz Spulentyp ZB09UL
2	371098	Magnetspule 230V 14W Kabellänge 1000mm
3	371036	Magnetspule 24V AC 9VA Spulentyp ZB09
3	371030	Magnetspule 24V DC 12VA Spulentyp ZB12
4	371033	Magnetspule PARKER 230V 9VA



5

Abb.	GEV-Nr.	Beschreibung
5	371029	Magnetspule PARKER 230V 9VA Spulentyp ZB09

Ventilkörper



1

2

Abb.	GEV-Nr.	Beschreibung
1	370062	Magnetventilkörper PARKER 3-Wege Außenkonus
2	370063	Magnetventilkörper PARKER 3-Wege Innenkonus

SIRAI

2-Wege

Serie L140-B



1

Technische Daten:
Temperaturbereich -10 bis +90°C
Membrane NBR (Wasser)
Druck max 12bar
Druck min 0,35bar

Abb.	GEV-Nr.	Versorgung	Anschluss	L (mm)	DN (mm)	Spulentyp
1	370320	24 VAC	1/2"	41	10	Z610A
1	370239	230 VAC	1/2"	41	10	Z610A

Serie L171-D



1

Technische Daten:
Temperaturbereich -10 bis +100°C
Membrane EPDM(Wasser)
Druck max 7bar
Druck min 0bar

Abb.	GEV-Nr.	Versorgung	Anschluss	L (mm)	DN (mm)	Spulentyp
1	370086	24 VAC	1/4"	43	3	Z610A
1	370083	230 VAC	1/4"	43	3	Z610A

Serie L177-B



1

Technische Daten:
Temperaturbereich -10 bis +90°C
Membrane NBR (Wasser)
Druck max 30bar
Druck min 0bar

Abb.	GEV-Nr.	Versorgung	Anschluss	L (mm)	DN (mm)	Spulentyp
1	370082	230 VAC	1/8"	26,5	2,3	Z610A



Serie L180-B



Technische Daten:
 Temperaturbereich -10 bis +90°C
 Membrane NBR (Wasser)
 Druck max 12bar
 Druck min 0,35bar

Abb.	GEV-Nr.	Versorgung	Anschluss	L (mm)	DN (mm)	Spulentyp
1	370328	24 VAC	3/8"	60	11,5	Z610A
1	370329	24 VAC	1/2"	66	13,5	Z610A
1	370391	24 VAC	3/4"	79	18	Z610A
1	370305	24VDC	1/2"	66	13,5	Z610A
1	370046	230 VAC	3/8"	60	11,5	Z610A
1	370047	230 VAC	1/2"	66	13,5	Z610A
1	370048	230 VAC	3/4"	79	18	Z610A

Serie L182_B



Technische Daten:
 Temperaturbereich -10 bis +90°C
 Membrane NBR (Wasser)
 Druck max 12bar
 Druck min 0,35bar

Abb.	GEV-Nr.	Versorgung	Anschluss	L (mm)	DN (mm)	Spulentyp
1	370480	230 VAC	1"	105		ZB10A

3-Wege

Serie L334-V



Technische Daten:
 Temperaturbereich 0 bis +130°C
 Membrane FPM
 Druck max 10bar
 Druck min 0bar

Abb.	GEV-Nr.	Versorgung	DN (mm)	Spulentyp
1	370080	230 VAC	2,3	ZA30A

Serie L377-B



Technische Daten:
 Temperaturbereich -10 bis +90°C
 Membrane NBR (Wasser)
 Druck max bar
 Druck min bar

Abb.	GEV-Nr.	Versorgung	Anschluss	L (mm)	DN (mm)	Spulentyp
1	370210	230 VAC	1/8"	26,5	1,6	Z610A

Magnetventile Dampf (Wasser)

2-Wege

Serie L120-Vo2



Technische Daten:
 Temperaturbereich -10 bis +155°C
 Spulentyp Z110A
 Membrane FPM
 Druck max 20bar
 Druck min bar

Abb.	GEV-Nr.	Versorgung	Anschluss	L (mm)	DN (mm)
1	370064	24 VAC	1/8"	32	2,3

Serie L121



Technische Daten:
 Temperaturbereich -10 bis +140°C
 Druck max 8bar
 Druck min 0,1bar

Abb.	GEV-Nr.	Versorgung	Anschluss	L (mm)	DN (mm)	Spulentyp	Membrane
1	370228	230 VAC	1/4"	42	2,3	ZA30A	Viton
1	370084	230 VAC	1/4"	42	3,2	ZA34A	EPDM

Serie L140-D



Technische Daten:
 Temperaturbereich -10 bis +100°C
 Spulentyp Z610A
 Membrane EPDM

Abb.	GEV-Nr.	Versorgung	Anschluss	L (mm)	DN (mm)	p max (bar)	p min (bar)
1	370705	24 VAC	3/4"	61	10	10	0,35
1	370729	24 VAC	3/4"	61	10	10	0,35
1	370731	24 VAC	3/4"	61	10	10	0,35
1	370730	230 VAC	3/4"	61	10	10	0,35

Serie L145-R



Technische Daten:
 Temperaturbereich -60 bis +170°C
 Membrane PTFE (Dampf)
 Druck min 0,4bar

Abb.	GEV-Nr.	Versorgung	Anschluss	L (mm)	DN (mm)	Spulentyp	p max (bar)
1	370324	24 VAC	3/4"	79	16	Z534A	6
1	370077	230 VAC	3/8"	60	10	Z614A	8
1	370322	230 VAC	1/2"	66	10	Z614A	8
1	370323	230 VAC	3/4"	79	16	Z534A	6
2	370085	230 VAC	1"	105	18,5	Z534A	8



Serie L153-D



Technische Daten:
 Temperaturbereich -10 bis +140°C
 Spulentyp Z134A
 Membrane EPDM (Dampf/Wasser)
 Druck max 8bar
 Druck min 0,1bar

Abb.	GEV-Nr.	Versorgung	Anschluss	L (mm)	DN (mm)
1	370314	24 VAC	1/2"	66	11,5
1	370325	24 VAC	3/4"	79	17
1	370264	230 VAC	1/2"	66	11,5
1	370079	230 VAC	3/4"	79	17

Ersatzteile und Zubehör

Magnetspulen



Abb.	GEV-Nr.	Versorgung	Leistung (VA)	Spulentyp	Aufnahme ø (mm)
1	371086	24 VAC	4	ZB10A	10
1	371070	24 VAC	10	Z610A	10
1	371158	24 VAC	10	Z614A	10
1	371075	24 VAC	14	Z530A	12
1	371068	24 VAC	14	Z534A	12
1	371178	24 VAC	24	Z110A/Z114A/Z134A	14
1	371099	24VDC	5,5	ZB10A	10
1	371069	24VDC	6	Z610A	10
1	371049	24VDC	12	ZA30E	14
1	371078	24VDC	13	Z110A/Z114A/Z134A	14
1	371076	24VDC	14	Z530A	12
1	371085	230 VAC	4	ZB10A	10
1	371071	230 VAC	10	Z610A	10
1	371159	230 VAC	10	Z614A	10
1	371074	230 VAC	14	Z530A	12
1	371067	230 VAC	14	Z534A	12
1	371047	230 VAC	14	ZA30A	14
1	371176	230 VAC	14	ZA34A	14
1	371077	230 VAC	24	Z110A/Z114A/Z134A	14

Membranen



Abb.	GEV-Nr.	Anschluss	Serie	Membrantyp
1	371171	1/2"	L180-B	NBR (Wasser)
1	371172	3/4"	L180-B	NBR (Wasser)
2	371163	1/2"	L140-B	NBR (Wasser)

Magnetventile diverse



Abb.	GEV-Nr.	Versorgung	Eingang	pass. für	Vergl.-Nr.
1	370665	24 VAC	1/8"	Bonnet Roller Grill	1049474 SB10018
2	370523	230 VAC		Cookmax Melitta	11753 11753
3	370748	230 VAC	1/8"	MKN	201141



Abb.	GEV-Nr.	Versorgung	Eingang	pass. für	Vergl.-Nr.
4	370236	230 VAC	1/4"	NuovaSimonelli	04100024
5	370634	230 VAC	1/4"	NuovaSimonelli	04100005
6	370713	230 VAC	3/8"	MIWE	505212.45



Abb.	GEV-Nr.	Versorgung	Eingang	pass. für	Vergl.-Nr.
7	370378	230 VAC	1/2"	Electrolux Sirai Zanussi	0C2390 L621B03 1L ZA34A 0C2390
8	370738	230 VAC	3/4" AG	Elframo	00065310

Ablaufventile





Abb.	GEV-Nr.	Spng. (V)	Eingang (mm)	Ausgang (mm)	pass. für
1	401889	12	40	40	Fagor FIBER Rational
2	370790 ¹	24	12,5	15,5	Icematic
3	371107	24	50	50	ATA Bonnet

¹mit Zubehör



					
4	5	6	7		
Abb.	GEV-Nr.	Spng. (V)	Eingang (mm)	Ausgang (mm)	pass. für
4	370621	230	17	17	Hobart
5	370720	230	17	19	Hobart
6	370642	230	40	40	Hobart
7	370629	230	46	1½" AG	Winterhalter

					
8	9	10			
Abb.	GEV-Nr.	Spng. (V)	Eingang (mm)	Ausgang (mm)	pass. für
8	371109	230	50	50	Lamber
9	371146	230	77	80	Grandimpianti
10	370721	240	17	19	Hobart

					
11	12				
Abb.	GEV-Nr.	Spng. (V)	Eingang (mm)	Ausgang (mm)	pass. für
11	370789	220-240			Fagor
12	371106	208/230	17,5	16	Icematic Scotsman



Magnetventile Gas

ASCO

	Technische Daten: Druck max 15bar Membrane FPM			
1				
Abb.	GEV-Nr.	Anschluss	L (mm)	Spulentyp
1	370710	1/8"	33	400127-197

BRAHMA

Magnetventile

		Technische Daten: CE Reg.Nr. 63AQ0626				
1	2					
Abb.	GEV-Nr.	DN (mm)	Anschluss	L (mm)	Spulentyp	p max (bar)
1	101486	10	3/8"	56	13747002	0,5
1	101487	10	1/2"	56	13747002	0,5
2	101488 ¹	15	1/2"	72	13922051	0,25
2	101490 ¹	25	3/4"	96	13932000	0,3
2	101493 ¹	40	1½"	138	13950200	0,2

¹Aluminium-Gehäuse

	Technische Daten: CE Reg.Nr. 63AQ0626					
3						
Abb.	GEV-Nr.	DN (mm)	Anschluss	L (mm)	Spulentyp	p max (bar)
3	101948 ¹	15	1/2"	72	18811003	0,5
3	106069 ¹	25	3/4"	96	18813004	0,5
3	106071 ¹	30	1"	111	18813014	0,5

¹Aluminium-Gehäuse

Ersatzteile und Zubehör

Magnetspulen

					
1	2				
Abb.	GEV-Nr.	Versorgung	Leistung (VA)	Aufnahme ø (mm)	Spulentyp
1	101521	230 VAC	20	17	13742002
1	101968	230 VAC	20	17	13902001
1	101522	230 VAC	20	17	13922051
2	101524	230 VAC	35	30	13942000
2	106070	230 VAC	37	30	18813004
2	106072	230 VAC	37	30	18813014



BÜRKERT



Technische Daten:
Druck max 0,5bar
CE Reg.Nr. CE-0085AS0391
Membrane NBR

Abb.	GEV-Nr.	DN (mm)	Anschluss	L (mm)	Abb.	GEV-Nr.	DN (mm)	Anschluss	L (mm)
1	370281	12	1/2"	74,5	2	370282	20	3/4"	100

Zubehör



Abb.	GEV-Nr.	Beschreibung
1	107348	Magnetspule TECNOCONTROL 230V AC 9VA
1	107349	Magnetspule TECNOCONTROL 24V AC 17VA

DUNGS



Technische Daten:
CE Reg.Nr. 63AQ0626

Abb.	GEV-Nr.	Spng. (V)	Anschluss	L (mm)	p max (bar)
1	107534	230	1/2"	65	0,36
1	107535	230	1"	75	0,36

Magnetventile Kälte

CASTEL

Ventile



Technische Daten:
Spannung 230V
Temperaturbereich -35 bis 110°C

Pos.	GEV-Nr.	Bauart	Typ	p max (bar)	Anschluss
1	370765	NC	1028/3	45	3/8"

TECNOCONTROL

Magnetventile



Technische Daten:
Druck max 0,55bar
Membrane NBR

Abb.	GEV-Nr.	Bauart	Spng. (V)	Anschluss	CE Reg.Nr.
1	104648	NC	230	3/4"	0068
1	104539	NC	230	1"	0068

Ventilkörper



Technische Daten:
Bauart NC
Druck max 45bar
Temperaturbereich -35 bis 105°C

Pos.	GEV-Nr.	Typ	DN (mm)	Anschluss
1	370151	1028/2 S	2,2	1/4" Lötanschluss
2	370382	1028/M10S	3	10mm Lötanschluss
3	370383	1068/M10S	7	10mm Lötanschluss
4	370384	1068/M12S	7	12mm Lötanschluss
5	370386	1078/5S	12,5	16mm Lötanschluss
6	370385	1078/M12S	12,5	12mm Lötanschluss
7	370387	1079/7S	12,5	22mm Lötanschluss



Technische Daten:
Druck max 0,55bar
Membrane NBR

Abb.	GEV-Nr.	Bauart	Spng. (V)	Anschluss	CE Reg.Nr.
2	102941	NO	230	1/2"	-
2	102942	NO	230	3/4"	-
2	102943	NO	230	1"	0497

Technische Daten:
 Bauart NC
 Druck max 45bar
 Temperaturbereich -35 bis 105°C

Pos.	GEV-Nr.	Typ	DN (mm)	Anschluss
1	370150	1020/2 S	2,5	1/4" SAE
2	370788	1020/3S	2,5	3/8" SAE
3	370152	1064/3 S	7	3/8" SAE
4	370153	1070/4 S	12,5	1/2" SAE
5	370381	1090/5 S	16,5	5/8" SAE
6	370154	1090/6 S	16,5	3/4" SAE





Abb.	GEV-Nr.	Versorgung	Leistung (VA)	Freq. (Hz)	Anschluss
1	371042	24VAC	8	50/60	DIN-Stecker groß
1	371301	110VAC	8	50/60	DIN-Stecker groß
1	371041	230VAC	8	50/60	DIN-Stecker groß
2	371084	230VAC	8	50/60	Kabel 1000mm

DANFOSS

Ventilkörper

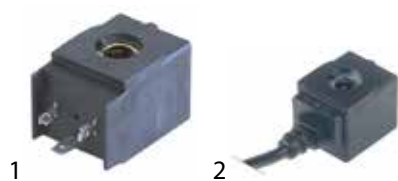

Technische Daten:
 Temperaturbereich -40° bis 105°C

Pos.	GEV-Nr.	Typ	p max (bar)	DN (mm)	Anschluss
1	370159	EVR 3	45,2	3,2	7/16" UNF (1/4" SAE)

Ersatzteile und Zubehör



Abb.	GEV-Nr.	Beschreibung
1	371004	Magnetspule DANFOSS 220/230V AC 10VA 50/60Hz
2	371040	Magnetspule DANFOSS Typ EVR 230V

PARKER

Ventile



Abb.	GEV-Nr.	Spng. (V)	Anschluss
1	370782	230	16mm Lötanschluss
2	370415	230	4mm Lötanschluss
3	370783	230	6mm Lötanschluss



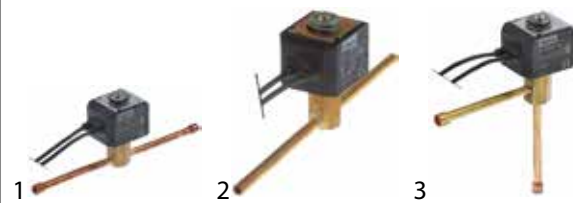

Abb.	GEV-Nr.	Spng. (V)	Anschluss
4	370784	230	6mm Lötanschluss

Diverse

Ventile



Technische Daten:
 Versorgung 230 VAC

Abb.	GEV-Nr.	Typ	p max (bar)	Anschluss
1	370757	MDF-A03-6H001	4,5	Lötanschluss 10mm
2	370666	NEV-202DXF 2251 J		6mm Lötanschluss

Ventilkörper



Abb.	GEV-Nr.	Typ	Anschluss
1	370478		6mm Lötanschluss
2	370191	CLS 2,5	6mm Lötanschluss
2	370190	ILS 1,5	6mm Lötanschluss
2	370192	RLS 1,9	6mm Lötanschluss

Ersatzteile und Zubehör

Magnetspulen



Abb.	GEV-Nr.	Spng. (V)	Freq. (Hz)
1	371045	230	50/60



Zubehör

Überwurfmuttern



Abb.	GEV-Nr.	Typ	Größe	Rohr ø	int. Code
1	750050	7010/22	1/4" SAE	1/4" - 6mm	NS4-4
1	750460	7010/33	3/8" SAE	3/8"	NS4-6
1	750463	7010/44	1/2" SAE	1/2"	NS4-8
1	750065	7010/55	5/8" SAE	5/8" - 16mm	NS4-10
2	750057	7020/32	3/8" SAE	1/4" - 6mm	NRS4-64
2	750462	7020/43	1/2" SAE	3/8"	NRS4-86
2	750461	7020/54	5/8" SAE	1/2"	NRS4-108
3	750051	7030/3M8	3/8" SAE	8mm	-
3	750052	7030/3M10	3/8" SAE	10mm	-
3	750053	7030/4M10	1/2" SAE	10mm	-
3	750054	7030/4M12	1/4" SAE	12mm	-
3	750063	7030/5M12	5/8" SAE	12mm	-
3	750064	7030/5M14	5/8" SAE	14mm	-
3	750055	7030/6M14	3/4" SAE	14mm	-
3	750056	7030/6M18	3/4" SAE	18mm	-

Magnetventile für Vakuumgeräte



Abb.	GEV-Nr.	Beschreibung
1	370507	Magnetventil 2-Wege 24 VAC L 31mm DN 3,3mm 1/8" Messing
2	370520	Magnetventil 2-Wege 24 VACV Eingang 1/4"mm Ausgang ø4 Vakuumgerät
3	370506	Magnetventil Material Messing Wegezanzahl 3 1/8" 24V Nennweite 2,8mm Körper Innenkonus L 35mm



Abb.	GEV-Nr.	Beschreibung
4	370505	Magnetventileinheit 1/2" Schlauchanschluss ø 21mm 24V Spulentyp VA12 für Gerät B42(XL)+SA 3 Spulen
5	692064	Magnetventileinheit 1/2" Schlauchanschluss ø 6mm 24V für Gerät H200
6	370513	Magnetventileinheit 24 VAC Eingang 1/2" Ausgang 10,5mm 2 Spulen Spulentyp VA12 1/2"



Abb.	GEV-Nr.	Beschreibung
7	370511	Magnetventileinheit 24 VAC Eingang 1/2" Ausgang 7,5mm 2 Spulen Spulentyp VA12 1/2"
8	370787	Magnetventileinheit 24 VAC Eingang 1/2" Ausgang 7,5mm 2 Spulen Spulentyp VA12 1/2"
9	370501	Magnetventileinheit G 1/2" Schlauchanschluss ø 10mm 24V Spulentyp VA12 JP
9	370500	Magnetventileinheit G 1/2" Schlauchanschluss ø 7,5mm 24V Spulentyp VA12 MJ



Abb.	GEV-Nr.	Beschreibung
10	370504	Magnetventileinheit G 1/2" Schlauchanschluss ø 21mm 24V Spulentyp VA12
11	370512	Magnetventileinheit G 1/2" Schlauchanschluss ø 21mm 24V Spulentyp VA12
12	370514	Magnetventileinheit G 1/2" Schlauchanschluss ø 21mm 24V Spulentyp VA12



Abb.	GEV-Nr.	Beschreibung
13	370502	Magnetventileinheit G 1/2" Schlauchanschluss ø 21mm 24V Spulentyp VA12 J35
13	370503	Magnetventileinheit G 1/2" Schlauchanschluss ø 21mm 24V Spulentyp VA12 J42