



Lampen

8

Signallampen.....	374
LEDs.....	383
Leuchtmittel für Steck-/Schraubfassungen.....	384
Stablampen.....	386
Hartglas-Infrarotlampen.....	388
Leuchtstofflampen.....	388
Kühlschranklampen.....	390
Mikrowellenlampen.....	391
Backofenlampen.....	392
Restwärmeanzeigen.....	401
Handlampen.....	401



Lampen

Signallampen

Signallampen 2-teilig (Linse und Signalelement)

Signallampenkappen

ø 6mm (Typ SQ-20)



Abb.	GEV-Nr.	Farbe	VPE (Stück)	Abb.	GEV-Nr.	Farbe	VPE (Stück)
1	359804	gelb	1	3	359806	klar	1
2	359803	grün	1	4	359805	rot	1

ø 8mm (Typ RL-2)



Abb.	GEV-Nr.	Farbe	VPE (Stück)	Abb.	GEV-Nr.	Farbe	VPE (Stück)
1	359820	gelb	1	3	359948	klar	1
2	359819	grün	1	4	359833	rot	1

ø 9mm (Typ SA-4)



Abb.	GEV-Nr.	Farbe	VPE (Stück)	Abb.	GEV-Nr.	Farbe	VPE (Stück)
1	359953	gelb	1	3	359956	klar	1
2	359954	grün	1	4	359955	rot	1

ø 9mm (Typ SA-7)



Abb.	GEV-Nr.	Farbe	VPE (Stück)	Abb.	GEV-Nr.	Farbe	VPE (Stück)
1	359949	gelb	1	3	359952	klar	1
1	357029	gelb	10	3	357032	klar	10
2	359950	grün	1	4	359951	rot	1
2	357030	grün	10	4	357031	rot	10

ø10mm (Typ SC-1)



Abb.	GEV-Nr.	Farbe	VPE (Stück)	Abb.	GEV-Nr.	Farbe	VPE (Stück)
1	359962	gelb	1	3	359965	klar	1
2	359963	grün	1	4	359964	rot	1

ø10mm (Typ SC-3)



Abb.	GEV-Nr.	Farbe	VPE (Stück)	Abb.	GEV-Nr.	Farbe	VPE (Stück)
1	359966	gelb	1	3	359969	klar	1
1	357037	gelb	10	3	357040	klar	10
2	359967	grün	1	4	359968	rot	1
2	357038	grün	10	4	357039	rot	10

ø10mm (Typ SR-3)



Abb.	GEV-Nr.	Farbe	VPE (Stück)	Abb.	GEV-Nr.	Farbe	VPE (Stück)
1	359414	gelb	1	3	357036	klar	10
2	359816	grün	1	4	359957	rot	1
3	359815	klar	1				

ø10mm (Typ SR-6)



Abb.	GEV-Nr.	Farbe	VPE (Stück)	Abb.	GEV-Nr.	Farbe	VPE (Stück)
1	359958	gelb	1	3	359961	klar	1
2	359959	grün	1	4	359960	rot	1

ø10mm (Typ SRZ-3)

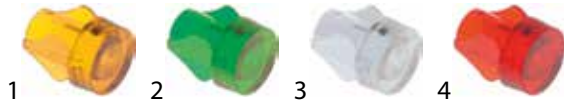

Abb.	GEV-Nr.	Farbe	VPE (Stück)	Abb.	GEV-Nr.	Farbe	VPE (Stück)
1	359124	gelb	1	3	359228	klar	1
2	359123	grün	1	4	359125	rot	1

ø10mm (Typ SRZ-4)



Abb.	GEV-Nr.	Farbe	VPE (Stück)	Abb.	GEV-Nr.	Farbe	VPE (Stück)
1	359121	gelb	1	3	359122	rot	1
2	359120	grün	1				

ø12mm (Typ SD-3)



Abb.	GEV-Nr.	Farbe	VPE (Stück)	Abb.	GEV-Nr.	Farbe	VPE (Stück)
1	359970	gelb	1	2	359971	grün	1
1	357041	gelb	10	2	357042	grün	10

Tabellenfortsetzung auf der nächsten Seite



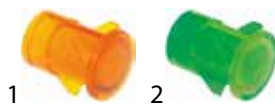

Abb.	GEV-Nr.	Farbe	VPE (Stück)	Abb.	GEV-Nr.	Farbe	VPE (Stück)
3	359973	klar	1	4	359972	rot	1
3	357044	klar	10	4	357043	rot	10

ø12mm (Typ SDK-3)



Abb.	GEV-Nr.	Farbe	VPE (Stück)	Abb.	GEV-Nr.	Farbe	VPE (Stück)
1	359792	blau	1	4	359275	klar	1
2	359278	gelb	1	5	359276	rot	1
3	359277	grün	1				

ø12mm (Typ SDK-4)



Abb.	GEV-Nr.	Farbe	VPE (Stück)	Abb.	GEV-Nr.	Farbe	VPE (Stück)
1	357229	gelb	1	2	357230	grün	1

ø12mm (Typ SDY-3)



Abb.	GEV-Nr.	Farbe	VPE (Stück)	Abb.	GEV-Nr.	Farbe	VPE (Stück)
1	359260	gelb	1	3	359280	klar	1
2	359262	grün	1	4	359261	rot	1

ø13mm (Typ SF-2)



Abb.	GEV-Nr.	Farbe	VPE (Stück)	Abb.	GEV-Nr.	Farbe	VPE (Stück)
1	359978	gelb	1	3	359981	klar	1
2	359979	grün	1	4	359980	rot	1

ø13mm (Typ SF-3)



Abb.	GEV-Nr.	Farbe	VPE (Stück)	Abb.	GEV-Nr.	Farbe	VPE (Stück)
1	359974	gelb	1	3	359977	klar	1
1	357045	gelb	10	3	357048	klar	10
2	359975	grün	1	4	359976	rot	1
2	357046	grün	10	4	357047	rot	10

ø13mm (Typ SFK-3)



Abb.	GEV-Nr.	Farbe	VPE (Stück)	Abb.	GEV-Nr.	Farbe	VPE (Stück)
1	359127	gelb	1	3	359225	klar	1
2	359126	grün	1	4	359128	rot	1

Signalelemente für Fassungsstyp SQ



Abb.	GEV-Nr.	Spng. (V)	Farbe	Anschluss
1	347476	5	grün	Kabel 170mm
2	359801	12	weiß	F6,3
2	359802	24	weiß	F6,3
2	359109	230	grün	F6,3
2	359110	230	weiß	F6,3
3	359931	230	grün	Kabel 400mm
3	359930	230	weiß	Kabel 400mm
4	359747	250	grün	Klemmanschluss
4	360638	250	weiß	Klemmanschluss

Signalelemente für Fassungsstyp RL



Abb.	GEV-Nr.	Spng. (V)	Farbe	Anschluss
1	357228	230	grün	Kabel 250mm
1	357227	230	klar	Kabel 250mm
2	359817	230	grün	F6,3
2	359818	230	klar	F6,3

Signalelemente für Fassungsstyp SA / SC / SD / SF / SR



Abb.	GEV-Nr.	Spng. (V)	Farbe	Anschluss	VPE (Stück)
1	359987	230	grün	Kabel 400mm	1
1	359814	230	klar	Kabel 400mm	1
1	359520	400	grün	Kabel 400mm	1
1	359521	400	klar	Kabel 400mm	1
2	359985	230	grün	F4,8	1
2	359984	230	klar	F4,8	1
3	359983	230	grün	F6,3	1
3	357050	230	grün	F6,3	10
3	359982	230	klar	F6,3	1
3	357049	230	klar	F6,3	10
3	359522	400	grün	F6,3	1
3	359523	400	klar	F6,3	1



Signalelemente für Fassungsyp SRZ / SDK / SDY / SFK



Abb.	GEV-Nr.	Spng. (V)	Farbe	Anschluss
1	359279	12	klar	F6,3
1	359129	24	klar	F6,3
1	359130	230	klar	F6,3
1	359132	250	grün	F6,3
1	359133	400	grün	F6,3
1	359131	400	klar	F6,3
2	359350	230	blau	F6,3
3	359431	230	grün	Kabel 400mm
3	359430	230	klar	Kabel 400mm
3	359435	400	klar	Kabel 400mm

Blenden für Fassungsyp SC-1



Abb.	GEV-Nr.	Beschreibung
1	359242	Ring verchromt

Signallampen 3-teilig (Fassung, Linse und Glimm-/Glühlampe)

ø16,2mm



Abb.	GEV-Nr.	Beschreibung
1	359832	Lampenfassung ø16,2mm Fassung Ba9s Anschluss Flachstecker 6,3mm
1	359060	Lampenfassung ø16,2mm E10 Anschluss Schraubanschluss
2	359070	Signallampenkappe gelb
3	359071	Signallampenkappe grün
4	359073	Signallampenkappe klar
5	359072	Signallampenkappe rot



Abb.	GEV-Nr.	Beschreibung
1	359685	Lampenfassung E10 ø16,2mm
2	359687	Signallampenkappe gelb
3	359688	Signallampenkappe grün
4	359686	Signallampenkappe klar
5	359689	Signallampenkappe rot

ø18,2mm



Abb.	GEV-Nr.	Beschreibung
1	359853	Lampenfassung ø18,2mm Fassung Ba9s Anschluss Flachstecker 6,3mm
2	359856	Signallampenkappe gelb
3	359857	Signallampenkappe grün
4	359989	Signallampenkappe klar
5	358502	Signallampenkappe rot mit Dichtung

ø19,2mm



Abb.	GEV-Nr.	Beschreibung
1	359063	Signallampenfassung E14 ø19,2mm ohne Blende und Lampe Schraubanschluss
2	359080	Signallampenkappe gelb
3	359081	Signallampenkappe grün
4	359083	Signallampenkappe klar
5	359082	Signallampenkappe rot

ø22,3mm



Abb.	GEV-Nr.	Beschreibung
1	359064	Signallampenfassung ø22,3mm E14 Anschluss Schraubanschluss 250/380V
2	359085	Signallampenkappe gelb
3	359086	Signallampenkappe grün
4	359088	Signallampenkappe klar
5	359087	Signallampenkappe rot

ø30,5mm



Abb.	GEV-Nr.	Beschreibung
1	359988	Lampenfassung ø30,5mm 250V Anschluss F6,3 55°C E14
2	359990	Signallampenkappe gelb
3	359991	Signallampenkappe grün
4	359993	Signallampenkappe klar
5	359992	Signallampenkappe rot



Leuchtmittel

Glühlampen

Abb.	GEV-Nr.	Fassung	Spng. (V)	Leist. (W)	ø (mm)	L (mm)
1	359597	T10	24	2	10	28
2	359598	Ba15d	230	5-7	16	35
3	359609	Ba15d	220-260	10/15	16	50

Abb.	GEV-Nr.	Fassung	Spng. (V)	Leist. (W)	ø (mm)	L (mm)
4	359868	Ba9s	12	2	10	28
4	359807	Ba9s	24	2	10	28
4	359869	Ba9s	48	2	10	28
4	359656	Ba9s	130	2	10	28
5	359236	E10	24	3	10	28
6	359608	E14	230	10/15	16	51
6	359587	E14	220-260	6-10	16	51

Abb.	GEV-Nr.	Fassung	Spng. (V)	Leist. (W)	ø (mm)	L (mm)
7	359055	T1 1/2	12	-	4,9	13
8	357005	T1 3/4	24	-	5	15
9	359592	T5.5K	12	3	5,5	22
9	359590	T5.5K	24	3	5,5	22
9	359591	T5.5K	48	3	5,5	22

Glimmlampen

Abb.	GEV-Nr.	Fassung	Spng. (V)	Farbe	ø (mm)	L (mm)
1	359000	Ba9s	24	klar	10	24
2	359606	Ba9s	220	klar	10	28
2	359607	Ba9s	380	klar	10	28
3	359600	E10	220	klar	10	28
3	359585	E10	230	grün	10	28
3	359601	E10	380	klar	10	28
4	359604	E14	220	klar	16	54
4	359605	E14	380	klar	16	54

Abb.	GEV-Nr.	Fassung	Spng. (V)	Farbe	ø (mm)	L (mm)
5	359588	E14	230	grün	14	30
5	359602	E14	230	klar	14	30
5	359603	E14	380	klar	14	30
5	359589	E14	400	grün	14	30
6	357006	T1 3/4	230	klar	4	15

Signallampen komplett

ø 6mm

Abb.	GEV-Nr.	Farbe	Spng. (V)	KL (mm)	Abb.	GEV-Nr.	Farbe	Spng. (V)	KL (mm)
1	359285	gelb	24	150	2	359004	grün	230	400
1	359569	gelb	230	250	3	359037	klar	230	400
1	359005	gelb	230	400	4	359009	rot	230	400
2	359284	grün	24	150					

Abb.	GEV-Nr.	Spng. (V)	Farbe	Anschluss
1	357016	230	grün	Klemmanschluss
2	357017	230	rot	Klemmanschluss

ø 9mm





Abb.	GEV-Nr.	Farbe	Spng. (V)	Anschluss	Abb.	GEV-Nr.	Farbe	Spng. (V)	Anschluss
1	359137	gelb	230	F6,3	2	345597	grün	400	F6,3
1	345598	gelb	400	F6,3	3	359134	klar	230	F6,3
2	359136	grün	230	F6,3	4	359135	rot	230	F6,3





Abb.	GEV-Nr.	Farbe	Spng. (V)	Anschluss	Abb.	GEV-Nr.	Farbe	Spng. (V)	Anschluss
1	359319	gelb	24	2-adrig	2	359318	grün	24	2-adrig







ø10mm



mit Schraubfassung

									
1	2	3	4						
Abb.	GEV-Nr.	Farbe	Spng. (V)	Anschluss	Abb.	GEV-Nr.	Farbe	Spng. (V)	Anschluss
1	359871	gelb	230	F4,8	3	359867	klar	230	F4,8
1	359379	gelb	230	F6,3	3	359995	klar	230	F6,3
1	359526	gelb	400	F6,3	3	359529	klar	400	F6,3
2	359870	grün	230	F4,8	4	359872	rot	230	F4,8
2	359378	grün	230	F6,3	4	359380	rot	230	F6,3
2	359527	grün	400	F6,3	4	359528	rot	400	F6,3

									
1	2	3	4						
Abb.	GEV-Nr.	Farbe	Spng. (V)	Anschluss	Abb.	GEV-Nr.	Farbe	Spng. (V)	Anschluss
1	359524	gelb	230	F6,3	3	359525	klar	230	F6,3
2	359238	grün	230	F6,3	4	359237	rot	230	F6,3





									
1	2	3	4						
Abb.	GEV-Nr.	Farbe	Spng. (V)	Anschluss	Abb.	GEV-Nr.	Farbe	Spng. (V)	Anschluss
1	360512	blau	230	F6,3	3	346882	grün	230	
2	346883	gelb	230		4	346881	rot	230	F6,3

				
1	2			
Abb.	GEV-Nr.	Farbe	Spng. (V)	Anschluss
1	359475	grün	125	F6,3
2	359476	rot	110/250	F6,3

							
1	2	3					
Abb.	GEV-Nr.	Farbe	Spng. (V)	Abb.	GEV-Nr.	Farbe	Spng. (V)
1	360502	gelb	24	3	360111	rot	24
2	360148	grün	24				

									
1	2								
Abb.	GEV-Nr.	Farbe	Spng. (V)	Anschluss	Abb.	GEV-Nr.	Farbe	Spng. (V)	Anschluss
1	360579	gelb	24	Kabel	2	360578	weiß	24	Kabel

mit Steckfassung

					
1	2	3	4		
Abb.	GEV-Nr.	Farbe	Spng. (V)	Anschluss	VPE (Stück)
1	360480	gelb	6	F2,8	1
1	359334	gelb	24	F6,3	1
1	359231	gelb	230	F2,8	1
1	359140	gelb	230	F6,3	1
1	357057	gelb	230	F6,3	5
1	359034	gelb	400	F6,3	1
1	357059	gelb	400	F6,3	5
2	360479	grün	6	F2,8	1
2	359422	grün	12	F2,8	1
2	359216	grün	24	F6,3	1
2	359230	grün	230	F2,8	1
2	359139	grün	230	F6,3	1
2	357056	grün	230	F6,3	5
2	359019	grün	400	F6,3	1
2	357060	grün	400	F6,3	5
3	359227	klar	24	F6,3	1
3	359232	klar	230	F2,8	1
3	359036	klar	230	F6,3	1
3	357058	klar	230	F6,3	5
3	359035	klar	400	F6,3	1
3	357062	klar	400	F6,3	5
4	359219	rot	24	F6,3	1
4	359040	rot	230	F2,8	1
4	359138	rot	230	F6,3	1
4	357055	rot	230	F6,3	5
4	359020	rot	400	F6,3	1
4	357061	rot	400	F6,3	5

ø12mm

mit Schraubfassung

									
1	2	3	4						
Abb.	GEV-Nr.	Farbe	Spng. (V)	Anschluss	Abb.	GEV-Nr.	Farbe	Spng. (V)	Anschluss
1	359025	gelb	24	F6,3	3	359047	klar	24	F6,3
1	359048	gelb	230	F6,3	3	359021	klar	230	F6,3
1	359290	gelb	400	F6,3	3	359994	klar	400	F6,3
2	359023	grün	24	F6,3	4	359024	rot	24	F6,3
2	359027	grün	250	F6,3	4	359026	rot	230	F6,3
2	359291	grün	400	F6,3	4	359292	rot	400	F6,3



1		2		3	
Abb.	GEV-Nr.	Farbe	Spng. (V)	Anschluss	
1	359892	gelb	24	Kabel 200mm	
1	359895	gelb	400	Kabel 2000mm	
2	359890	grün	24	Kabel 200mm	
2	359893	grün	400	Kabel 200mm	
3	359891	rot	24	Kabel 200mm	
3	359894	rot	400	Kabel 200mm	

mit Steckfassung

1		2		3		4	
Abb.	GEV-Nr.	Farbe	Spng. (V)	Anschluss	VPE (Stück)		
1	359042	gelb	230	F6,3	1		
1	357070	gelb	230	F6,3	5		
2	359041	grün	230	F6,3	1		
2	357069	grün	230	F6,3	5		
2	359494	grün	400	F6,3	1		
3	359044	klar	230	F6,3	1		
3	357064	klar	230	F6,3	5		
4	359043	rot	230	F6,3	1		
4	357063	rot	230	F6,3	5		

1		2		3		4	
Abb.	GEV-Nr.	Farbe	Spng. (V)	Anschluss	Symbol		
1	360509	gelb	230	F6,3	Thermometer		
1	357111	gelb	400	F6,3	Thermometer		
2	359571	grün	230	F6,3	Beschwädung		
3	359846	grün	230	F6,3	Sinus		
4	359570	grün	230	F6,3	Temperatur		

5		6			
Abb.	GEV-Nr.	Farbe	Spng. (V)	Anschluss	Symbol
5	359572	grün	230	F6,3	Timer
6	357110	grün	400	F6,3	Bereit/Ein

ø12,5mm

1		2		3		4			
Abb.	GEV-Nr.	Farbe	Spng. (V)	Anschluss	Abb.	GEV-Nr.	Farbe	Spng. (V)	Anschluss
1	359996	gelb	230	F6,3	3	359999	klar	230	F6,3
2	359997	grün	230	F6,3	4	359998	rot	230	F6,3

1				
Abb.	GEV-Nr.	Farbe	Spng. (V)	Anschluss
1	357009	grün	230	F4,8

ø13mm
mit Schraubfassung

1		2		3		4			
Abb.	GEV-Nr.	Farbe	Spng. (V)	Anschluss	Abb.	GEV-Nr.	Farbe	Spng. (V)	Anschluss
1	357077	gelb	400	Schraub	3	357135	rot	240	Schraub
2	357076	grün	400	Schraub	4	357137	rot	380	F6,3
3	357136	rot	24	Schraub					

1				
Abb.	GEV-Nr.	Farbe	Spng. (V)	Anschluss
1	357125	rot	400	Schraubklemme

mit Steckfassung

1		2		3		4	
Abb.	GEV-Nr.	Farbe	Spng. (V)	Anschluss	VPE (Stück)		
1	359143	gelb	230	F6,3	1		
1	357067	gelb	230	F6,3	5		
2	359119	grün	24	F6,3	1		
2	359142	grün	230	F6,3	1		
2	357066	grün	230	F6,3	5		
3	359045	klar	230	F6,3	1		
3	357068	klar	230	F6,3	5		
4	359141	rot	230	F6,3	1		
4	357065	rot	230	F6,3	5		

ø14mm
mit Schraubfassung

1		2							
Abb.	GEV-Nr.	Farbe	Spng. (V)	Anschluss	Abb.	GEV-Nr.	Farbe	Spng. (V)	Anschluss
1	360621	gelb	24	F4,8	2	360622	grün	24	F4,8

mit Steckfassung

1		2		3		4			
Abb.	GEV-Nr.	Farbe	Spng. (V)	Anschluss	Abb.	GEV-Nr.	Farbe	Spng. (V)	Anschluss
1	359149	gelb	230	F6,3	3	359342	klar	230	F6,3
2	359148	grün	230	F6,3	4	359147	rot	230	F6,3



1		2		3										
Abb.	GEV-Nr.	Farbe	Spng. (V)	Anschluss	Abb.	GEV-Nr.	Farbe	Spng. (V)	Anschluss	Abb.	GEV-Nr.	Farbe	Spng. (V)	Anschluss
1	359152	gelb	400	F6,3	3	359150	rot	400	F6,3					
2	359151	grün	400	F6,3										

1				
Abb.	GEV-Nr.	Farbe	Spng. (V)	Anschluss
1	357073	rot	250	F4,8

ø16mm
mit Schraubfassung

1		2		3		4									
Abb.	GEV-Nr.	Farbe	Spng. (V)	Anschluss	Abb.	GEV-Nr.	Farbe	Spng. (V)	Anschluss	Abb.	GEV-Nr.	Farbe	Spng. (V)	Anschluss	
1	359834	gelb	230	F6,3	3	359831	rot	230	F6,3						
1	359830	gelb	400	F6,3	3	359903	rot	400	F6,3						
2	359835	grün	230	F6,3	4	359829	weiß	230	F6,3						
2	359901	grün	400	F6,3	4	359902	weiß	400	F6,3						

ø22mm

1		2		3		4									
Abb.	GEV-Nr.	Farbe	Spng. (V)	Anschluss	Abb.	GEV-Nr.	Farbe	Spng. (V)	Anschluss	Abb.	GEV-Nr.	Farbe	Spng. (V)	Anschluss	
1	359505	gelb	230	Schraub	3	359508	klar	230	Schraub						
1	359509	gelb	400	Schraub	3	359512	klar	400	Schraub						
2	359506	grün	230	Schraub	4	359511	rot	400	Schraub						
2	359510	grün	400	Schraub											

mit Steckfassung

1		2		3		4									
Abb.	GEV-Nr.	Farbe	Spng. (V)	KL (mm)	Abb.	GEV-Nr.	Farbe	Spng. (V)	KL (mm)	Abb.	GEV-Nr.	Farbe	Spng. (V)	KL (mm)	
1	359908	gelb	230	200	3	359910	rot	230	200						
1	359094	gelb	400	200	3	359905	rot	400	200						
2	359909	grün	230	200	4	359093	weiß	400	200						
2	359828	grün	400	200											

1		2					
Abb.	GEV-Nr.	Farbe	Spng. (V)	Anschluss			
1	357021	gelb	230-440	Schraub			
2	357020	weiß	230-440	Schraub			

1		2		3		4													
Abb.	GEV-Nr.	Farbe	Spng. (V)	Anschluss	Abb.	GEV-Nr.	Farbe	Spng. (V)	Anschluss	Abb.	GEV-Nr.	Farbe	Spng. (V)	Anschluss	Abb.	GEV-Nr.	Farbe	Spng. (V)	Anschluss
1	359345	blau	230	F6,3	4	359790	klar	230	F6,3										
2	359789	gelb	230	F6,3	5	359344	rot	230	F6,3										
3	359788	grün	230	F6,3															

ø25mm

1		2		3		4									
Abb.	GEV-Nr.	Farbe	Spng. (V)	Anschluss	Abb.	GEV-Nr.	Farbe	Spng. (V)	Anschluss	Abb.	GEV-Nr.	Farbe	Spng. (V)	Anschluss	
1	359203	gelb	230	F6,3	3	359202	rot	230	F6,3						
2	359204	grün	230	F6,3	4	360551	weiß	230	F6,3						

1		2		3										
Abb.	GEV-Nr.	Farbe	Spng. (V)	Anschluss	Abb.	GEV-Nr.	Farbe	Spng. (V)	Anschluss	Abb.	GEV-Nr.	Farbe	Spng. (V)	Anschluss
1	359473	gelb	230	F6,3	3	359472	rot	230	F6,3					
2	359474	grün	230	F6,3										

1				
Abb.	GEV-Nr.	Farbe	Spng. (V)	Anschluss
1	359079	weiß	230	F6,3

ø20mm

1				
Abb.	GEV-Nr.	Farbe	Spng. (V)	Anschluss
1	359514	grün	230	F6,3

14x11mm

1		2							
Abb.	GEV-Nr.	Farbe	Spng. (V)	Anschluss	Abb.	GEV-Nr.	Farbe	Spng. (V)	Anschluss
1	359218	gelb	230	F6,3	2	359270	grün	230	F6,3



19x13mm



Abb.	GEV-Nr.	Farbe	Spng. (V)	Anschluss	Abb.	GEV-Nr.	Farbe	Spng. (V)	Anschluss
1	359201	grün	230	F6,3	2	359200	rot	230	F6,3

22x10mm



Abb.	GEV-Nr.	Farbe	Spng. (V)	Anschluss	Abb.	GEV-Nr.	Farbe	Spng. (V)	Anschluss
1	359213	gelb	230	F6,3	3	359215	klar	230	F6,3
2	359214	grün	230	F6,3					

25x11mm



Abb.	GEV-Nr.	Farbe	Spng. (V)	Anschluss	Abb.	GEV-Nr.	Farbe	Spng. (V)	Anschluss
1	359224	gelb	230	F6,3	2	359223	grün	230	F6,3

26,5x25,6mm



Abb.	GEV-Nr.	Farbe	Spng. (V)	Anschluss
1	357172	blau	250	F6,3
2	359010	gelb	230	F6,3
3	359011	gelb	230	F6,3
4	359012	gelb	230	F6,3



Abb.	GEV-Nr.	Farbe	Spng. (V)	Anschluss
5	345853	grün	230	F6,3
6	345854	grün	230	F6,3
7	345855	grün	230	F6,3
8	358102	grün	220-250	F6,3



Abb.	GEV-Nr.	Farbe	Spng. (V)	Anschluss
9	357173	rot	230	F6,3
10	345796	weiß	230	F6,3
11	347446	weiß	250	F6,3
12	347869	weiß	250	F6,3

27,2x22,2mm

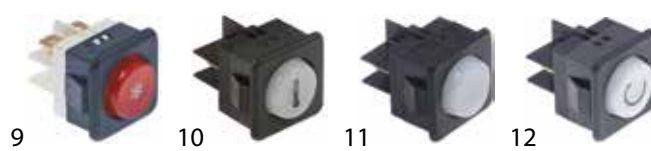

Abb.	GEV-Nr.	Farbe	Spng. (V)	Anschluss	Abb.	GEV-Nr.	Farbe	Spng. (V)	Anschluss
1	359631	gelb	230	F6,3	3	359209	rot	230	F6,3
2	359911	gelb	230	F6,3					

27x12mm



Abb.	GEV-Nr.	Farbe	Spng. (V)	Anschluss	Abb.	GEV-Nr.	Farbe	Spng. (V)	Anschluss
1	348056	rot	28	F6,3	2	348057	weiß	28	F6,3

28,5x28,5mm



Abb.	GEV-Nr.	Beschreibung
1	345926	Signallampenfassung 28,5x28,5mm orange Anschluss Zyklus
2	345927	Signallampenfassung 28,5x28,5mm rot Niveau



Abb.	GEV-Nr.	Beschreibung
1	345610	Signallampenkappe 23x23 orange Betrieb
2	345728	Signallampenkappe 23x23 orange defrost
3	345616	Signallampenkappe 23x23 orange Sinus
4	345614	Signallampenkappe orange Heizen
5	345617	Signallampenkappe orange Thermometer



Abb.	GEV-Nr.	Beschreibung
1	359798	Signallampenfassung 28,5x28,5mm gelb
2	359799	Signallampenfassung 28,5x28,5mm rot

28,5x52,6mm



Abb.	GEV-Nr.	Farbe	Spng. (V)	Anschluss
1	345877	grün	230	F6,3

28,5x77,5mm



Abb.	GEV-Nr.	Farbe	Spng. (V)	Anschluss
1	345873	grün	230	F6,3
2	359008	weiß/blau/grün	230	F6,3

30x11mm



Abb.	GEV-Nr.	Farbe	Spng. (V)	Anschluss	Abb.	GEV-Nr.	Farbe	Spng. (V)	Anschluss
1	359159	gelb	230	F6,3	3	359158	rot	230	F6,3
2	359160	grün	230	F6,3					

30x13mm



Abb.	GEV-Nr.	Farbe	Spng. (V)	Anschluss	Abb.	GEV-Nr.	Farbe	Spng. (V)	Anschluss
1	346548	grün	220	F6,3	2	346547	rot	230	F6,3

30x22mm



Abb.	GEV-Nr.	Farbe	Spng. (V)	Anschluss	Abb.	GEV-Nr.	Farbe	Spng. (V)	Anschluss
1	359180	gelb	230	F6,3	3	359179	klar	230	F6,3
2	359178	grün	230	F6,3	4	359177	rot	230	F6,3



Abb.	GEV-Nr.	Farbe	Spng. (V)	Anschluss	Abb.	GEV-Nr.	Farbe	Spng. (V)	Anschluss
5	359251	gelb	24	F6,3	6	359157	grün	230	F6,3
5	359156	gelb	230	F6,3	7	359155	rot	230	F6,3
6	359250	grün	24	F6,3	8	359154	weiß	230	F6,3



Abb.	GEV-Nr.	Farbe	Spng. (V)	Anschluss
9	359354	blau	230	F6,3



Abb.	GEV-Nr.	Farbe	Spng. (V)	Anschluss	Abb.	GEV-Nr.	Farbe	Spng. (V)	Anschluss
10	357011	weiß	230	F6,3	12	347641	rot	230	F6,3
11	359409	weiß	230	F6,3					



Abb.	GEV-Nr.	Farbe	Spng. (V)	Anschluss	Symbol
1	359407	weiß	230	F6,3	Temperatur
2	359406	weiß	230	F6,3	Programm
3	359029	grün	230	F6,3	Blitz
4	359030	grün	230	F6,3	Maschine bereit





Abb.	GEV-Nr.	Farbe	Spng. (V)	Anschluss	Symbol
5	357022	gelb	250	F6,3	Kaffee





				
1	2	3		
Abb.	GEV-Nr.	Farbe	Spng. (V)	Anschluss
1	359164	grün/weiß	230	F6,3
2	301138	rot/grün	230	F6,3
3	346968	gelb/rot	230	F6,3

33x10mm

									
1	2								
Abb.	GEV-Nr.	Farbe	Spng. (V)	Anschluss	Abb.	GEV-Nr.	Farbe	Spng. (V)	Anschluss
1	359451	gelb	400	F6,3	2	359452	grün	400	F6,3

34,1x23,1mm

									
1	2	3							
Abb.	GEV-Nr.	Farbe	Spng. (V)	Anschluss	Abb.	GEV-Nr.	Farbe	Spng. (V)	Anschluss
1	347313	grün	230	F6,3	3	347314	rot	230	F6,3
2	347559	grün	230	F6,3					

34x10mm

									
1	2	3							
Abb.	GEV-Nr.	Farbe	Spng. (V)	Anschluss	Abb.	GEV-Nr.	Farbe	Spng. (V)	Anschluss
1	359210	gelb	230	F6,3	3	359239	rot	230	F6,3
2	359211	grün	230	F6,3	3	359899	rot	380	F6,3

Sonstige

			
1	2	3	4
Abb.	GEV-Nr.	Beschreibung	pass. für
1	359887	Lampenfassung ø21mm E10	Kreff Küppersbusch Rational
2	359429	Signallampe 230V Anschluss Flachstecker 6,3mm Einbau ø 18mm	Palux
3	357124	Signallampe 230V grün/rot Anschluss Schraubanschluss	Repagas
4	359066	Signallampe 30x21mm grün 230V	Kreff Rational
4	359065	Signallampe 30x21mm weiß 230V	Kreff Rational

			
5	6	7	
Abb.	GEV-Nr.	Beschreibung	pass. für
5	359851	Signallampe 32,5x8,5mm weiß 230V	Cookmax Sirman
6	360619	Signallampe grün 125/250V Anschluss Flachstecker 6,3mm Pitco	
7	359273	Signallampe spezial 230V klar gelb leuchtend	Giorik



LEDs

Signalelemente



Einbaudurchmesser 6mm

				
1	2			
Abb.	GEV-Nr.	Farbe	Spannung	Anschluss
1	358098	gelb	5VDC	Kabel 200mm
2	359404	grün	5VDC	Kabel 200mm

Einbaudurchmesser 8mm

				
1	2	3		
Abb.	GEV-Nr.	Farbe	Spannung	Anschluss
1	360651	gelb	12VDC	F2,8x0,8
1	359402	gelb	24VDC	F2,8x0,8
2	359357	grün	24VDC	F2,8x0,8
3	360650	rot	12VDC	F2,8x0,8
3	359403	rot	24VDC	F2,8x0,8

Einbaudurchmesser 14mm

				
1	2	3		
Abb.	GEV-Nr.	Farbe	Spannung	Anschluss
1	359397	gelb	230VAC	F2,8x0,8
2	359382	grün	230VAC	F2,8x0,8
3	359398	rot	230VAC	F2,8x0,8

Einbaudurchmesser 24mm

				
1	2			
Abb.	GEV-Nr.	Farbe	Spannung	Anschluss
1	360602	gelb	230VAC	F2,8
2	360603	grün	230VAC	F2,8



Einbaudurchmesser 25mm



Abb.	GEV-Nr.	Farbe	Spannung	Anschluss
1	360584	blau	3VDC	Kabel 1000mm
2	360585	grün	3VDC	Kabel 1000mm
3	360583	rot	3VDC	Kabel 1000mm



Abb.	GEV-Nr.	Farbe	Spannung	Anschluss
1	360605	grün	24VDC	F2,8
2	360604	rot	24VDC	F2,8

Sonstige



Abb.	GEV-Nr.	Ausführung	Spannung	Farbe	Anschluss
1	359217	LED	220-240	grün	Ba9s

LED-Leisten

Frenox



Abb.	GEV-Nr.	L (mm)	B (mm)	H (mm)	Abb.	GEV-Nr.	L (mm)	B (mm)	H (mm)
1	357212	300	20	20	1	357216	1200	20	20
1	357215	500	19	7	1	357211	1230	20	20
1	357214	690	20	20	1	357213	1435	15	7
1	357218	700	20	20	1	357217	1600	20	20

Horeca-Select



Abb.	GEV-Nr.	L (mm)	B (mm)	H (mm)
1	357138	698	13	13

Zubehör



Abb.	GEV-Nr.	Beschreibung
1	357178	Netzteil für LEDs 3W primär 100-240V sekundär 0,35A 50/60Hz KPB-3F351 VPE 1 Stück
2	357152	Netzteil für LEDs RT-130-2-24cm VPE 1Stück

Leuchtmittel für Steck-/Schraubfassungen

Glimmlampen



Abb.	GEV-Nr.	Fassung	Spng. (V)	Farbe	ø (mm)	L (mm)
1	359000	Ba9s	24	klar	10	24
2	359606	Ba9s	220	klar	10	28
2	359607	Ba9s	380	klar	10	28
3	359600	E10	220	klar	10	28
3	359585	E10	230	grün	10	28
3	359601	E10	380	klar	10	28
4	359604	E14	220	klar	16	54
4	359605	E14	380	klar	16	54



Abb.	GEV-Nr.	Fassung	Spng. (V)	Farbe	ø (mm)	L (mm)
5	359588	E14	230	grün	14	30
5	359602	E14	230	klar	14	30
5	359603	E14	380	klar	14	30
5	359589	E14	400	grün	14	30
6	357006	T1 3/4	230	klar	4	15

Glühlampen

für Beleuchtungstechnik



Abb.	GEV-Nr.	Fassung	Spng. (V)	Leist. (W)	ø (mm)	L (mm)	VPE (Stück)
1	359613	E27	230	25	45	71	1
1	359614	E27	230	40	45	71	1
1	357102	E27	220-260	25	45	72	1
1	357103	E27	220-260	40	45	72	1
2	357177	E27	230	40	45	75	10
3	359849	E27	230	60	48	102	1



Abb.	GEV-Nr.	Fassung	Spng. (V)	Leist. (W)	ø (mm)	L (mm)	VPE (Stück)
4	357219	E27	250	40	47	88	1



für Backöfen

Abb.	GEV-Nr.	T.max. (°C)	Leist. (W)	Spng. (V)	ø (mm)	L (mm)	Typ
1	359740	300	15	230	22	20	IMPORT
1	359610	300	15	230	22	46	Philips
1	357153	300	25	230	25	55	-
1	359612	300	25	230	25	55	Philips
1	357099	500	15	235	22	50	-
1	359448	500	25	230	26	57	-
2	359615	300	25	230	45	76	IMPORT
2	359611	300	40	230	45	75	IMPORT
2	357154	300	40	230	45	75	Philips
2	357100	500	25	220-260	45	75	K4500
2	357101	500	40	220-260	45	75	K4500
3	357118	500	40	230/240	25	70	-

für Signallampen

Abb.	GEV-Nr.	Fassung	Spng. (V)	Leist. (W)	ø (mm)	L (mm)
1	359597	T10	24	2	10	28
2	359598	Ba15d	230	5-7	16	35
3	359609	Ba15d	220-260	10/15	16	50

Abb.	GEV-Nr.	Fassung	Spng. (V)	Leist. (W)	ø (mm)	L (mm)
4	359868	Ba9s	12	2	10	28
4	359807	Ba9s	24	2	10	28
4	359869	Ba9s	48	2	10	28
4	359656	Ba9s	130	2	10	28
5	359236	E10	24	3	10	28
6	359608	E14	230	10/15	16	51
6	359587	E14	220-260	6-10	16	51

Abb.	GEV-Nr.	Fassung	Spng. (V)	Leist. (W)	ø (mm)	L (mm)
7	359055	T1 1/2	12	-	4,9	13
8	357005	T1 3/4	24	-	5	15
9	359592	T5.5K	12	3	5,5	22
9	359590	T5.5K	24	3	5,5	22
9	359591	T5.5K	48	3	5,5	22

Halogenleuchtmittel

für Fassung E14 / E27

Abb.	GEV-Nr.	Fassung	Spng. (V)	Leist. (W)	Hersteller	VPE
1	357197	E14	230	25	OSRAM	1
1	359728	E14	230	40	-	1
2	359683	E27	240	60	-	1

für Fassung G4 / G6,35 / G9

Abb.	GEV-Nr.	Fassung	Spng. (V)	Leist. (W)	Temp.Best. (°C)	Hersteller
1	357188	G4	12	5	300	OSRAM
1	359579	G4	12	5	500	-
1	357189	G4	12	5	-	OSRAM
1	357191	G4	12	10	300	OSRAM
1	359596	G4	12	10	500	-
1	357190	G4	12	10	-	OSRAM
1	357193	G4	12	20	300	OSRAM
1	359599	G4	12	20	500	-
1	357192	G4	12	20	-	OSRAM
2	359074	G6,35	12	35	500	-
2	357194	G6,35	12	35	-	OSRAM
3	359945	G9	230	25	300	-
3	357195	G9	230	25	300	OSRAM
3	359946	G9	230	40	300	-
3	357196	G9	230	40	300	OSRAM

für Fassung GU5,3 / GU10 / GZ5,3

Abb.	GEV-Nr.	Fassung	Spng. (V)	Leist. (W)	Temp.Best. (°C)
1	359665	GU10	230	50	-
2	357054	GU5,3	12	20	-
2	359496	GU5,3	12	50	-

Abb.	GEV-Nr.	Fassung	Spng. (V)	Leist. (W)	Temp.Best. (°C)
3	359300	GZ5,3	235	25	400



Stablampen

Halogenlampen



Abb.	GEV-Nr.	Fassung	L (mm)	Spng. (V)	Leist. (W)	Hersteller
1	357198	R7s	74,9	230	48	OSRAM
1	360556	R7s	74,9	230	80	OSRAM
1	357199	R7s	74,9	230	120	OSRAM
1	357090	R7s	117,6	230	120	OSRAM
1	357200	R7s	117,6	230	160	OSRAM
1	357201	R7s	117,6	230	230	OSRAM
1	357202	R7s	117,6	230	400	OSRAM



Abb.	GEV-Nr.	Fassung	L (mm)	Spng. (V)	Leist. (W)	Hersteller
2	359305	R7s	78,3	230	60	IMPORT
2	359616	R7s	78,3	230	150	IMPORT
2	359313	R7s	117,6	230	150	IMPORT
2	359647	R7s	117,6	230	200	IMPORT
2	359620	R7s	117,6	230	300	IMPORT
2	359621	R7s	117,6	230	500	IMPORT

Infrarotlampen

mit Sockeltyp KSSV



Abb.	GEV-Nr.	L (mm)	Spng. (V)	Leist. (W)	Abb.	GEV-Nr.	L (mm)	Spng. (V)	Leist. (W)
1	359632	260	230	500	1	359638	330	230	1000
1	359629	260	230	650	1	359624 ¹	340	230	1000

¹mit Reflektor

mit Sockeltyp R7s



Abb.	GEV-Nr.	L (mm)	Spng. (V)	Leist. (W)	Hersteller
1	359628	117,6	240	300	IMPORT
1	357075	190	230	200	IMPORT
1	359676	190	230	350	IMPORT
1	357233	190	235	200	OSRAM
1	359331	220	230	300	IMPORT
1	359693	220	230	400	IMPORT
1	359627	220	230	500	IMPORT
1	357019	254	235	500	IMPORT
1	357207	254	235	500	OSRAM

Abb.	GEV-Nr.	L (mm)	Spng. (V)	Leist. (W)	Hersteller
2	357210	214	235	500	OSRAM

Abb.	GEV-Nr.	L (mm)	Spng. (V)	Leist. (W)	Hersteller
3	360507 ¹	255	240	1300	IMPORT

¹mit Goldbeschichtung

Pos.	GEV-Nr.	L (mm)	Spng. (V)	Leist. (W)	Pos.	GEV-Nr.	L (mm)	Spng. (V)	Leist. (W)
1	359750	117,6	240	300	4	358116	349	240	365
2	359535	218	240	300	5	359537	349	240	1000
3	359536	218	240	500	6	358115	650	240	765

Pos.	GEV-Nr.	L (mm)	Spng. (V)	Leist. (W)	KL (mm)
1	359622	428	230	1000	100

mit Sockeltyp X-Lasche

Pos.	GEV-Nr.	L (mm)	Spng. (V)	Leist. (W)	Hersteller
1	359618	214	110	500	-
2	359617	340	220	1000	-
3	357208	365	235	1000	OSRAM

mit Sockeltyp Z-Keramik

Abb.	GEV-Nr.	L (mm)	Spng. (V)	Leist. (W)	KL (mm)	Hersteller
1	359694	122	220-240	300	300	IMPORT
1	359581	218	240	300	205	IMPORT
1	359625	226	220-250	500	195	IMPORT
1	357209	349	235	1000	200	OSRAM
1	359626	349	220-250	1000	195	IMPORT

Abb.	GEV-Nr.	L (mm)	Spng. (V)	Leist. (W)	KL (mm)	Hersteller
2	359582	218	240	500	205	IMPORT





Abb.	GEV-Nr.	L (mm)	Spng. (V)	Leist. (W)	KL (mm)	Hersteller
3	357206 ¹	251	240	1300		OSRAM
3	347971 ¹	290	240	1300	600	IMPORT

¹mit Goldbeschichtung



Pos.	GEV-Nr.	L (mm)	Spng. (V)	Leist. (W)	KL (mm)
1	359539	218	240	500	205
2	359678	349	230	365	205
3	359679	640	240	833	1300

Fassungen für Stablampen

KSSV



Abb.	GEV-Nr.	Beschreibung	ø (mm)	H (mm)
1	359650	Lampenhalter	12	25

R7s



Abb.	GEV-Nr.	Beschreibung	ø (mm)	H (mm)	Anschluss	BA (mm)
1	359726	Lampenfassung	18	28	Kabel 230mm	-
1	357234	Lampenfassung	18	27	Kabel 2000mm	-
2	359445	Halter				36



Abb.	GEV-Nr.	Beschreibung	ø (mm)	H (mm)	Anschluss	BA (mm)
3	359717	Lampenfassung	18	31	Kabel 320mm	28
4	359734	Lampenfassung	18	32	Kabel 200mm	27
5	359733	Lampenfassung	18	40	Kabel 230mm	27
5	360555	Lampenfassung	20	36	Kabel 400mm	28



Abb.	GEV-Nr.	Beschreibung	ø (mm)	H (mm)	Anschluss	BA (mm)
6	359648	Lampenfassung	20	32	Kabel 320mm	24/33
7	359727	Lampenfassung	22	45	Kabel 300mm	30
8	359732	Lampenfassung	22	45	Kabel 320mm	30



Abb.	GEV-Nr.	Beschreibung	ø (mm)	H (mm)	Anschluss	BA (mm)
9	359649	Lampenfassung	-	35	Kabel 350mm	8/35
10	359735	Lampenfassung	-	40	Kabel 230mm	-



Abb.	GEV-Nr.	Beschreibung	für Lampenlänge (mm)	H (mm)	Anschluss	BA (mm)
1	359753 ¹	Lampenfassung	117,6	62	Kabel 450mm	175

¹nur für Halogenstablampen bis max. 150W geeignet



Abb.	GEV-Nr.	Beschreibung	für Lampenlänge (mm)	H (mm)	Anschluss	BA (mm)
2	359544	Lampenfassung	117,6	40	Kabel 230mm	70
3	359545	Reflektor				



Abb.	GEV-Nr.	Beschreibung	für Lampenlänge (mm)	H (mm)	Anschluss	BA (mm)
4	359542	Lampenfassung	78,3	50	Kabel 150mm	15
4	359663	Lampenfassung	117,6	47	Kabel 150mm	65
5	359547	Lampenfassung	78,3	43	Kabel 250mm	
5	359543	Lampenfassung	117,6	43	Kabel 150mm	64



Abb.	GEV-Nr.	Beschreibung	für Lampenlänge (mm)	H (mm)	Anschluss	BA (mm)
6	359583	Lampenfassung	218	62	Kabel 200mm	120
6	359584	Lampenfassung	349	62	Kabel 200mm	250

X-Lasche

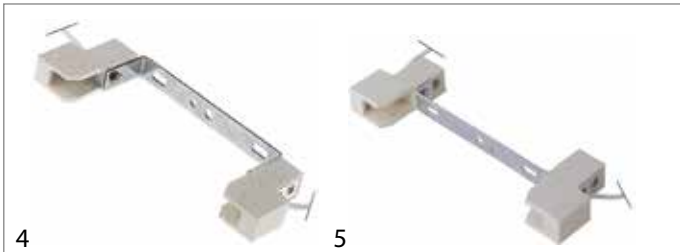

Abb.	GEV-Nr.	Beschreibung	L (mm)	B (mm)	H (mm)	BA (mm)
1	359710	Lampenfassung	70	70	49	50

Z-Keramik



Abb.	GEV-Nr.	Beschreibung	für Lampenlänge (mm)	L (mm)	B (mm)	H (mm)	BA (mm)
1	359658	Lampenfassung	218	220	47	62	120
2	359541	Lampenfassung	349	349	47	62	250



Abb.	GEV-Nr.	Beschreibung	für Lampenlänge (mm)	L (mm)	B (mm)	H (mm)	BA (mm)
3	359546	Lampenfassung		45	28	20	20

Hartglas-Infrarotlampen



Abb.	GEV-Nr.	Spng. (V)	Leist. (W)	ø (mm)	L (mm)
1	357205	240	275	125	170
1	360623	240	300	125	180
1	360539	240	375	120	180
1	357095	240	150	125	173
1	358097	240	250	125	173
2	357094	240	150	125	173
2	359463	240	250	125	173

Leuchtstofflampen

Leuchtstofflampen

G5



Pos.	GEV-Nr.	L (mm)	Leist. (W)	Spng. (V)	VPE (Stück)
1	357132	212	6	230	1
2	357156	285	8	230	1
3	357155	285	8	230	5
4	359384	287	8	230	1
5	357148	547	14	230	1
6	357140	547	14	230	5
7	357203	549	14	230	1
8	359745	560	18	230	1
9	357204	849	21	230	1
10	359746	860	21	230	1

G13



Pos.	GEV-Nr.	L (mm)	Leist. (W)	Spng. (V)	VPE (Stück)
1	359385	360	14	230	1
2	357145	438	15	230	1
3	359383	438	15	230	1
4	357112	438	15	230	10
5	359737	516	13	230	1

Tabellenfortsetzung auf der nächsten Seite



Pos.	GEV-Nr.	L (mm)	Leist. (W)	Spng. (V)	VPE (Stück)
6	359371	590	18	230	1
7	357007	895	30	230	1
8	357146	895	30	230	1
9	357147	895	30	230	1
10	359372	895	30	230	1
11	357113	895	30	230	5
12	357139	895	30	230	10
13	359738	970	23	230	1
14	357008	1198	36	230	1
15	359386	1198	36	230	1
16	359390	1500	58	230	1

G23



Pos.	GEV-Nr.	L (mm)	Leist. (W)	Spng. (V)	Pos.	GEV-Nr.	L (mm)	Leist. (W)	Spng. (V)
1	357024	108	5	230	2	359933	237	11	230

2G11



Pos.	GEV-Nr.	L (mm)	Leist. (W)	Spng. (V)	Pos.	GEV-Nr.	L (mm)	Leist. (W)	Spng. (V)
1	359640	217	18	230	3	359634	411	36	230
2	359635	310	24	230					

komplett mit Halterung



1

Abb.	GEV-Nr.	L (mm)	B (mm)	Leist. (W)	Spng. (V)	pass. für
1	360610	343	23	8	220-240	Fagor

2



Abb.	GEV-Nr.	L (mm)	B (mm)	Leist. (W)	Spng. (V)	pass. für
2	359743	600	42	18	230	Inomak
2	359744	900	42	21	230	Inomak
2	359481	1204		28	230	Öztiryakiler

3



Abb.	GEV-Nr.	L (mm)	B (mm)	Leist. (W)	Spng. (V)	pass. für
3	357115	1224	23	28	220/240	Izmaak Philips



4

Abb.	GEV-Nr.	L (mm)	B (mm)	Leist. (W)	Spng. (V)	pass. für
4	359391	1245	37	36		Emainox GE General Electric
4	359392	1545	37	58		Emainox

Zubehör

Fassungen



1

2

3

Abb.	GEV-Nr.	Fassung	pass. für	Abb.	GEV-Nr.	Fassung	pass. für
1	359730	2G11	Mercury	3	357025	G23	Marco
2	381156	2G11	Eloma				



4

5

6

Abb.	GEV-Nr.	Fassung	pass. für	Abb.	GEV-Nr.	Fassung	pass. für
4	359684	G5	Scholl	6	381169	G13	Dukers Horeca-Select
5	359395	G13	CB				



7

8

Abb.	GEV-Nr.	Fassung	pass. für	Abb.	GEV-Nr.	Fassung	pass. für
7	358176	G13	Emainox	8	358175	G13	Emainox



9



10

Abb.	GEV-Nr.	Fassung	pass. für	Abb.	GEV-Nr.	Fassung	pass. für
9	359389	G13	—	10	359388	G13	—



							
11	12						
Abb.	GEV-Nr.	Fassung	pass. für	Abb.	GEV-Nr.	Fassung	pass. für
11	359682	G13	Scholl	12	359681	G13	Scholl



Starterfassungen



							
1	2	3					
Abb.	GEV-Nr.	Leist. (W)	pass. für	Abb.	GEV-Nr.	Leist. (W)	pass. für
1	359394		CB	3	381170		Dukers Horeca-Select
2	380466		Desmon Scholl				

Starter



					
1	2				
Abb.	GEV-Nr.	Leist. (W)	Abb.	GEV-Nr.	Leist. (W)
1	357150	11	2	380464	4-65

Vorschaltgeräte

					
1	2	3			
Abb.	GEV-Nr.	Leist. (W)	Spng. (V)	VPE (Stück)	pass. für
1	403191	9	220	1	Dukers Horeca-Select
1	403176	9	220	5	Dukers Horeca-Select
2	402063	15	230	1	Cookmax Mafrol
3	403192	15	220-240	1	Dukers Horeca-Select

					
4	5	6			
Abb.	GEV-Nr.	Leist. (W)	Spng. (V)	VPE (Stück)	pass. für
4	403177	15	220-240	5	Dukers Horeca-Select
5	401504	18	230	1	CB Cookmax Fagor IARP Mafrol
6	402064	25	230	1	Cookmax Mafrol

					
7	8	9			
Abb.	GEV-Nr.	Leist. (W)	Spng. (V)	VPE (Stück)	pass. für
7	401141	30	230	1	Coldmaster Desmon Emainox Scholl
8	402065	30	230	1	Cookmax Mafrol
9	403190	30	220-240	1	Dukers Horeca-Select
9	403175	30	220-240	5	Dukers Horeca-Select
9	358134	76	230	1	Dukers Horeca-Select
9	358124	76	230	5	Dukers Horeca-Select

					
10	11				
Abb.	GEV-Nr.	Leist. (W)	Spng. (V)	VPE (Stück)	pass. für
10	401505	36	230	1	CB Cookmax Fagor IARP Ilsa Mafrol
11	402066	58	230	1	Cookmax Mafrol

Kühlschränklampen

							
1							
Abb.	GEV-Nr.	Beschreibung	Fassung	Leist. (W)	Spng. (V)	ø (mm)	L (mm)
1	359595	Glühlampe	E14	15	230-240	25	56



Herstellerspezifische Kühlschrankschranklampen

ELECTROLUX



1

Abb. GEV-Nr. Beschreibung

1 357106 Lampenglas L 103mm B 65mm Kunststoff

NINGBO ROTOR



1

2

3

Abb. GEV-Nr. Beschreibung Vergl.-Nr.

1 357127 LED Kühlschrank für Gerät GHR1040 weiß 220V Platine Spannung AC —

2 357143 Abdeckung für Lampe Kunststoff ø 62mm klar VPE 1Stück RW40.38

3 357144 Lampenhalter für LEDs ø 84mm VPE 1Stück RW40.37



1

Abb. GEV-Nr. Beschreibung Vergl.-Nr.

1 357149 Lampenfassung T140 250V 500W LA 254mm L 34,5mm H 31mm Kunststoff VPE 1Stück GGC1078-32

NINGBO ROTOR



1

Abb. GEV-Nr. Beschreibung

1 357149 Lampenfassung T140 250V 500W LA 254mm L 34,5mm H 31mm Kunststoff VPE 1Stück

RWA



1

2

3

Abb. GEV-Nr. Beschreibung

1 357144 Lampenhalter für LEDs ø 84mm VPE 1Stück

2 357127 LED Kühlschrank für Gerät GHR1040 weiß 220V Platine Spannung AC

3 357143 Abdeckung für Lampe Kunststoff ø 62mm klar VPE 1Stück

Mikrowellenlampen

Lampen komplett



1

2

3

Abb.	GEV-Nr.	Fassung	Spng. (V)	Leist. (W)	ø (mm)	L (mm)	VPE (Stück)	pass. für
1	359561	-	220-240	25	25	67	1	—
2	358149	E14	250	75	25	125	1	ACP
3	357221	Flansch 52x27mm	240	25	25	62	1	ACP

Fassungen



1

2

Abb.	GEV-Nr.	Fassung	Spng. (V)	Leist. (W)	ø (mm)	L (mm)	VPE (Stück)	pass. für
1	357141	E14	250	26	37	1	Galanz Horeca-Select	
2	360597	E14	250	75	27	44	1	ACP

Glühlampen



1

2

3

Abb.	GEV-Nr.	Fassung	Spng. (V)	Leist. (W)	ø (mm)	L (mm)	VPE (Stück)
1	357142	E14	230	20	22	58	1
1	357134	E14	230	20	22	58	5
1	357175	E14	230	20	25	63	1
1	357174	E14	230	20	25	63	50
1	359549	E14	220-240	25	25	60	1
2	357220	E14	240	20	25	40	1
3	357222	E14	240	25	24,8	81,5	1



4

5

Abb.	GEV-Nr.	Fassung	Spng. (V)	Leist. (W)	ø (mm)	L (mm)	VPE (Stück)
4	359551	E14	240	15	26	57	1
5	359559	F4,8	220-240	20	24	80	1



Backofenlampen

Universale Backofenlampen

Einbaudurchmesser 28,5mm



Abb.	GEV-Nr.	Beschreibung
1	359317	Backofenlampe Einbau ø 28,5mm 12V 5W Fassung G4 Kabellänge 300mm
2	359308	Linsennippel

Einbaudurchmesser 35,5mm



Abb.	GEV-Nr.	Spng. (V)	Leist. (W)	Fassung	Anschluss	Ausführung
1	357162	12	20	G4	Kabel 450mm	Borosilikatglas
2	359720	230	15	E14	F6,3	Borosilikatglas
3	359718	230	15	E14	F6,3	Hartglas



Abb.	GEV-Nr.	Spng. (V)	Leist. (W)	Fassung	Anschluss	Ausführung
4	359660	230	25	E14	F6,3	Hartglas
5	359934	230	25	E14	F6,3	Hartglas
5	359457	230	25	G9	F6,3	Borosilikatglas
6	360601	230	25	G4	F6,3	Hartglas



Abb.	GEV-Nr.	Spng. (V)	Leist. (W)	Fassung	Anschluss	Ausführung
7	357232	230	40	G9	Kabel 85mm	Borosilikatglas
8	359259	230	40	G9	Kabel 380mm	Borosilikatglas



Abb.	GEV-Nr.	Beschreibung	Fassung	Anschluss
1	359701	Lampenfassung	E14	F6,3
2	359762	Lampenfassung	G4	Kabel 350mm
2	357080	Lampenfassung	G4	Kabel 2400mm
2	359841	Lampenfassung	G4	Kabel 3500mm
3	357160	Lampenfassung	G9	Kabel 100mm
3	357161	Lampenfassung	G9	Kabel 380mm

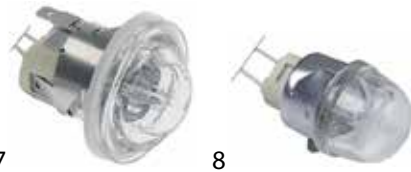

Abb.	GEV-Nr.	Beschreibung	Fassung	Anschluss
4	359427	Lampenfassung	G9	F6,3



Abb.	GEV-Nr.	Beschreibung	ø (mm)	Ausführung	Temp.Best. (°C)
1	359033	Linsennippel	41	Hartglas	350
2	359942	Linsennippel	41	Hartglas	350
3	359709	Linsennippel	42	Hartglas	350



Abb.	GEV-Nr.	Beschreibung	ø (mm)	Ausführung	Temp.Best. (°C)
4	359723	Linsennippel	51	Borosilikatglas	550
5	359705	Linsennippel	52	Borosilikatglas	550
6	359661	Linsennippel	58	Hartglas	350



Abb.	GEV-Nr.	Beschreibung	Material	ID ø (mm)	AD ø (mm)	t (mm)
1	359700	Dichtung	Fiberglas	32,5	55	5
2	358135 ¹	Dichtung	PTFE	44	53	3
3	358128	Dichtung	Silikon	30	38	2
4	359721	Dichtung	Silikon	48	39,5	5

¹mit Silikon O-Ring



Einbaudurchmesser 47,8mm

Abb.	GEV-Nr.	Spng. (V)	Leist. (W)	Fassung	Anschluss	Ausführung
1	357187	230	15	E14	F6,3	Hartglas
2	359711	230	25	E14	F6,3	Hartglas

Abb.	GEV-Nr.	Spng. (V)	Leist. (W)	Fassung	Anschluss	Ausführung
3	357167	230	40	G9	F6,3	Borosilikatglas

Abb.	GEV-Nr.	Spng. (V)	Leist. (W)	Fassung	Anschluss	Ausführung
3	359703	230	15	E14	F6,3	Hartglas
4	357165	230	40	G9	F6,3	Hartglas

Abb.	GEV-Nr.	Beschreibung	Fassung	Anschluss
1	359022	Lampenfassung	E14	F6,3
2	357002	Lampenfassung	G9	F6,3

Abb.	GEV-Nr.	Beschreibung	Fassung	Anschluss
1	359499	Lampenfassung	E14	F6,3
2	360541	Lampenfassung	G9	F6,3

Abb.	GEV-Nr.	Beschreibung	ø (mm)	Ausführung	Temp.Best. (°C)
1	359724	Linsennippel	74	Hartglas	350

Abb.	GEV-Nr.	Beschreibung	ø (mm)	Ausführung	Temp.Best. (°C)
1	357166	Linsennippel	54	Hartglas	350
2	359725	Linsennippel	54	Hartglas	350

Abb.	GEV-Nr.	Beschreibung	Material	ID ø (mm)	AD ø (mm)	t (mm)
1	357083	Dichtring	Metall	63	78	3
2	359729	Dichtung	PTFE	57	67	5
3	359722	Dichtung	Silikon	57,5	68	2

Einbaudurchmesser 65,5mm

Abb.	GEV-Nr.	Spng. (V)	Leist. (W)	Fassung	Anschluss	Ausführung
1	357078	230	40	E14	F6,3	Hartglas
2	359712	230	40	E14	F6,3	Hartglas

30x70mm

Abb.	GEV-Nr.	Beschreibung
1	359337	Backofenlampe Anschluss Faston 6,3mm
2	359338	Lampenglas



55x70mm



1 2

Abb.	GEV-Nr.	Spng. (V)	Leist. (W)	Fassung	Anschluss
1	358111	12	20	G4	Kabel 135mm
2	359659	230	25	E14	F6,3



1 2

Abb.	GEV-Nr.	Beschreibung
1	360608	Lampe L 95mm B 80mm 230-240V 25W E14 komplett 300°C Anschluss F6,3
2	357105	Lampenfassung Fassung G9 250V 55x70mm Anschluss Flachstecker 6,3mm H 32mm



3

Abb.	GEV-Nr.	Spng. (V)	Leist. (W)	Fassung	Anschluss
3	358130	230	25	G9	Kabel 300mm

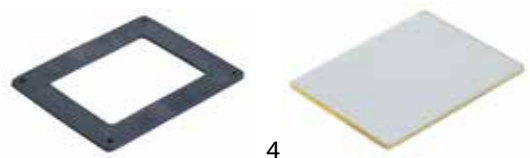

3 4

Abb.	GEV-Nr.	Beschreibung
3	359299	Dichtung L 91mm B 77mm Loch ø 3mm für Backofenlampe
4	359296	Lampenglas L 74mm B 58mm Materialstärke 3mm



1 2

Abb.	GEV-Nr.	Fassung	Anschluss
1	357159	E14	F6,3
2	358148	G4	Kabel 135mm



5 6

Abb.	GEV-Nr.	Beschreibung
5	358147	Dichtung für Backofenlampe L 75mm B 65mm Materialstärke 1mm
6	359297	Rahmen L 95mm B 81mm Stärke 6mm BA 68/83mm



3 4

Abb.	GEV-Nr.	Fassung	Anschluss
3	358131	G9	Kabel 300mm
4	357105	G9	F6,3

55x100mm



1 2

Abb.	GEV-Nr.	Beschreibung
1	359696	Backofenlampe komplett 25W 230V L 100mm B 55mm E14 Temperaturbeständigkeit 300°C
2	359698	Lampenfassung E14 L 100mm B 55mm Anschluss Flachstecker 6,3mm



1

Abb.	GEV-Nr.	Beschreibung
1	359937	Lampenglas L 80mm B 65mm 52x67mm



3

Abb.	GEV-Nr.	Beschreibung
3	359938	Borosilikatglas L 115mm B 69mm



1 2

Abb.	GEV-Nr.	Beschreibung
1	357171	Backofenlampe komplett 230V 25W Fassung G9 L 70mm B 55mm 55x70mm Anschluss Flachstecker 6,3mm
2	359937	Lampenglas L 80mm B 65mm 52x67mm



1 2

Abb.	GEV-Nr.	Beschreibung
1	101372	Backofenlampe komplett 25W 230V L 100mm B 55mm E14 rechteckig 300°C Anschluss Flachstecker 6,3mm
2	359698	Lampenfassung E14 L 100mm B 55mm Anschluss Flachstecker 6,3mm



3 4

Abb.	GEV-Nr.	Beschreibung
3	359715	Lampenglas L 110mm B 65mm Materialstärke 5mm
4	359714	Dichtung für Lampenfassung



5

Abb.	GEV-Nr.	Beschreibung
5	359716	Rahmen für Lampenfassung

60x100mm



1 2

Abb.	GEV-Nr.	Beschreibung
1	359767	Backofenlampe 300°C Anschluss Flachstecker 6,3mm
2	359944	Borosilikatglas

50x75,5mm



1 2 3

Abb.	GEV-Nr.	Beschreibung
1	359309	Backofenlampe L 75mm B 50mm 230V 40W E14 300°C Anschluss Flachstecker 6,3mm
2	360484	Lampenfassung L 75mm B 50mm 230V 40W Fassung E14 300°C Anschluss Flachstecker 6,3mm für Pizzaofen
3	359303	Linsennippel L 88mm B 54mm für Backofenlampe

Herstellerspezifische Backofenlampen

ANGELO PO



1 2 3

Abb.	GEV-Nr.	Beschreibung	Vergl.-Nr.
1	359701	Lampenfassung Fassung E14 220-230V Einbau ø 35,5mm Anschluss Flachstecker 6,3mm 15W	32W2561
2	359340	Glasscheibe ø78x3mm	3036650
3	359339	Dichtung 65x80x1mm	37Q7840

BERTO'S



1 2 3

Abb.	GEV-Nr.	Beschreibung	Vergl.-Nr.
1	359839	Lampenfassung G4 für Halogenlampe	10867
2	359840	Rahmen für Backofenlampe	40863
3	359299	Dichtung L 91mm B 77mm Loch ø 3mm für Backofenlampe	10304



4 5

Abb.	GEV-Nr.	Beschreibung	Vergl.-Nr.
4	359296	Lampenglas L 74mm B 58mm Materialstärke 3mm	10305
5	359297	Rahmen L 95mm B 81mm Stärke 6mm BA 68/83mm	24289500

BOURGEOIS



1 2 3

Abb.	GEV-Nr.	Beschreibung	Vergl.-Nr.
1	359580	Lampenfassung für Halogenlampe	Lamp012
2	360530	Lampenglas L 47,4mm B 32,8mm Glas Materialstärke 3,2mm	HUBL009
3	511690	Dichtung für Lampe L 78mm B 42mm Silikon Materialstärke 3mm LA 66,5mm	JOIN109

CONVOTHERM



1 2

Abb.	GEV-Nr.	Beschreibung
1	360639	Backofenlampe komplett 230V 25W Fassung G9 55x70mm Anschluss Flachstecker 6,3mm
2	359488	Backofenlampe komplett 55x70mm 230V 15W Fassung E14 rechteckig



Abb.	GEV-Nr.	Beschreibung
3	357105	Lampenfassung Fassung G9 250V 55x70mm Anschluss Flachstecker 6,3mm H 32mm
4	357159	Lampenfassung Fassung E14 55x70mm Anschluss Flachstecker 6,3mm VPE 1 Stück



Abb.	GEV-Nr.	Beschreibung
5	358180	Dichtung für Backofenlampe L 94mm B 78mm Materialstärke 3mm PTFE
6	694335	Lampenglas L 87mm B 72mm Materialstärke 3mm



Abb.	GEV-Nr.	Beschreibung
7	360641	Dichtung für Backofenlampe L 86mm B 71mm Materialstärke 0,5mm PTFE
8	360640	Rahmen L 98mm B 83mm Stärke 6,5mm BA 83x68mm Edelstahl

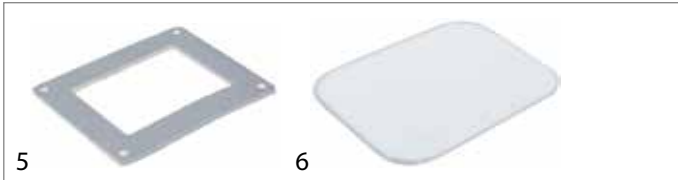

Abb.	GEV-Nr.	Beschreibung	Vergl.-Nr.
1	359701	Lampenfassung Fassung E14 220-230V Einbau ø 35,5mm Anschluss Flachstecker 6,3mm 15W	5005016
2	359643	Lampenglas ø 69mm Materialstärke 4mm	—
3	359642	Dichtung Materialstärke 5,5mm Graphit ID ø 62mm AD ø 70mm	6005013

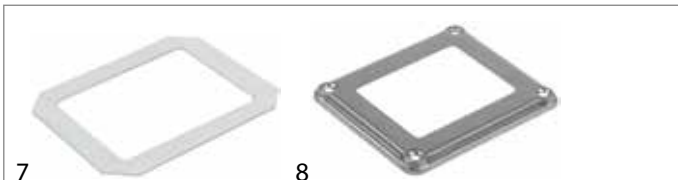

Abb.	GEV-Nr.	Beschreibung	Vergl.-Nr.
4	692171	Rahmen für Lampenglas Bohrung ø 6,3mm D1 ø 72mm D2 ø 56mm L 83mm B 83mm Materialstärke 1mm	5005020

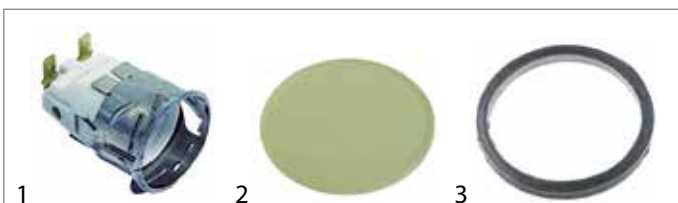

Abb.	GEV-Nr.	Beschreibung	Vergl.-Nr.
1	360629	Backofenlampe inkl. Dichtung Einbau ø 10mm 12V 10W Fassung G4 CONVOTHERM 300°C	2628501

ELECTROLUX



Abb.	GEV-Nr.	Beschreibung	Vergl.-Nr.
1	359841	Lampenfassung Fassung G4 Einbau ø 35,5mm Anschluss Kabel 3500mm	007105
1	359762	Lampenfassung Fassung G4 Einbau ø 35,5mm Anschluss Kabel 350mm	0C1555
2	359764	Lampenglas ø 44mm	002627
3	359763	Rahmen ohne Fassung	002626
4	359765	Lampenhalter Innenø38mm Außenø76mm	002628



Abb.	GEV-Nr.	Beschreibung	Vergl.-Nr.
1	359376	Lampenfassung E14	054320
2	359377	Linse nippel H 30mm ø 47mm	054318

FAGE



Abb.	GEV-Nr.	Beschreibung	Vergl.-Nr.
1	359690	Lampenfassung E27 ø52mm	PORLAM27
2	693486	Glasscheibe 81x81x4mm	VETRO85

FAGOR



Abb.	GEV-Nr.	Beschreibung	Vergl.-Nr.
1	359432	Lampenfassung Fassung G4 25V H 18mm Anschluss Flachstecker 4,8mm BA 16mm	12019933
2	359433	Dichtung	12017827



Abb.	GEV-Nr.	Beschreibung	Vergl.-Nr.
1	359432	Lampenfassung Fassung G4 25V H 18mm Anschluss Flachstecker 4,8mm BA 16mm	12019933
2	359428	Reflektor	12012053
3	359426	Lampenglas L 38mm B 38mm Materialstärke 3mm	12016678



Abb.	GEV-Nr.	Beschreibung	Vergl.-Nr.
4	359425	Dichtung für Backofenlampe L 71mm B 71mm Materialstärke 1,5mm Gummi	12020892
5	359424	Rahmen L 75mm B 75mm Befestigungsabstand 61mm	12012381



Abb.	GEV-Nr.	Beschreibung	Vergl.-Nr.
1	359295	Lampenfassung für Halogenlampe 12V 20W G4 55 x 70mm Kabellänge 135mm	12024545
2	359405	Dichtung L 95mm B 80mm Materialstärke 2mm	12023578
3	359408	Glasscheibe L 74mm B 59mm Materialstärke 3mm	12023668



Abb.	GEV-Nr.	Beschreibung	Vergl.-Nr.
4	359415	Dichtung für Backofenlampe L 78mm B 62mm Materialstärke 1mm Graphit	12023532
5	359423	Rahmen für Backofenlampe L 95mm B 80mm Stärke 6mm	12024464

FOINOX



Abb.	GEV-Nr.	Beschreibung	Vergl.-Nr.
1	359839	Lampenfassung G4 für Halogenlampe	10867
2	359840	Rahmen für Backofenlampe	—
3	359299	Dichtung L 91mm B 77mm Loch ø 3mm für Backofenlampe 10304	10304



Abb.	GEV-Nr.	Beschreibung	Vergl.-Nr.
4	359296	Lampenglas L 74mm B 58mm Materialstärke 3mm	10305
5	359297	Rahmen L 95mm B 81mm Stärke 6mm BA 68/83mm	10306

FORNITALIA



Abb.	GEV-Nr.	Beschreibung	Vergl.-Nr.
1	359369	Lampenfassung Fassung G4/G5,3/G6,35 24V ø 17mm H 10mm Anschluss Kabel 730mm BA 11,5mm	—
2	359495	Rahmen ohne Fassung	65/65Z11
3	359496	Halogenlampe GU5,3 12V 50W	K65/65



Abb.	GEV-Nr.	Beschreibung	Vergl.-Nr.
4	359497	Lampenglas ø 52mm	K65/6509
5	359498	Feder für Lampenglas	K65/6507

GEMINI FORNI



Abb.	GEV-Nr.	Beschreibung	Vergl.-Nr.
1	359698	Lampenfassung E14 L 100mm B 55mm Anschluss Flachstecker 6,3mm	550181
2	358122	Dichtung für Lampenfassung L 112mm B 68mm Materialstärke 3mm Silikon	233054
3	358123	Lampenglas L 112mm B 68mm	233186



Abb.	GEV-Nr.	Beschreibung	Vergl.-Nr.
4	358119	Rahmen für Lampenfassung L 118mm B 72mm BA 143mm	233185

GIORIK



Abb.	GEV-Nr.	Beschreibung	Vergl.-Nr.
1	359499	Lampenfassung Fassung E14 Einbau ø 47,8mm Anschluss Flachstecker 6,3mm	—
2	532649	O-Ring Viton Materialstärke 2,62mm ID ø 63,17mm VPE 1Stück	—
3	360552	Borosilikatglas ø 88mm H 28mm Materialstärke 4mm	—



Abb.	GEV-Nr.	Beschreibung	Vergl.-Nr.
4	525313	O-Ring Viton Materialstärke 3,53mm ID ø 60,33mm VPE 1 Stück	—



HATCO



Abb.	GEV-Nr.	Beschreibung	Vergl.-Nr.
1	359500	Lampenfassung Fassung E27 250V ø 35mm H 38mm Anschluss Kabel 250mm VPE 1 Stück	X02.30.102.00
2	359847	Lampenfassung E27 für HATCO Wärmebrücke GR	02.30.044.00
3	359848	Lampenfassung E27 doppelt für HATCO Wärmebrücke GR	02.30.045.00

HOUNÖ



Abb.	GEV-Nr.	Beschreibung	Vergl.-Nr.
1	357092	Lampenfassung G4 ø 17mm Litzenlänge 450mm mit 2-Lochbefestigung BA 12mm H 9mm	066019
2	360618	Lampenglas mit Dichtgummi Einbau ø 85mm	20120131



Abb.	GEV-Nr.	Beschreibung	Vergl.-Nr.
1	357092	Lampenfassung G4 ø 17mm Litzenlänge 450mm mit 2-Lochbefestigung BA 12mm H 9mm	066019
2	694503	Dichtung für Lampenglas ø 82mm Loch ø 51mm	014575
3	694502	Lampenglas Metall Glas mit Rahmen und Dichtung ø 85mm	037519

IZMAK



Abb.	GEV-Nr.	Beschreibung	Vergl.-Nr.
1	357098	Lampenfassung E14 L 150mm BA 124mm H 45mm	101011
2	694500	Glasscheibe L 85mm B 85mm Materialstärke 5mm	101012

LAINOX



Abb.	GEV-Nr.	Beschreibung	Vergl.-Nr.
1	359674	Lampenfassung Fassung G4 24V H 16mm Anschluss Kabel 100mm BA 20mm	LAR65270450
2	359670	Lampenglas L 105mm B 40mm Materialstärke 4mm	LAR71500150
3	359671	Dichtung	LAR70044200
4	359672	Rahmen	LAR11401450



Abb.	GEV-Nr.	Beschreibung	Vergl.-Nr.
1	359669	Lampenfassung G4 für Halogenlampe	LAR50304510
2	357131	Lampenfassung Fassung G4 L 90mm B 65mm H 21mm Anschluss Kabel 100mm BA 20mm	LAR65270400
3	359667	Reflektor L 141mm	LAR10400150



Abb.	GEV-Nr.	Beschreibung	Vergl.-Nr.
4	359668	Dichtung	LAR70040800

MKN



Abb.	GEV-Nr.	Beschreibung	Vergl.-Nr.
1	357184	Lampenfassung Fassung G4 ø 17mm H 9mm Anschluss Flachstecker 6,3mm BA 12mm	203678
2	693050	Dichtung Graphit D1 ø 71mm D2 ø 94mm Materialstärke 1mm für MKN	211128
3	694294	Glasscheibe ø 90mm Materialstärke 8mm	216115

OEM



Abb.	GEV-Nr.	Beschreibung	Vergl.-Nr.
1	359639	Lampenfassung E14 mit Klemmbefestigung	EL06900
2	698562	Reflektor L 120mm B 108mm H 33mm ø 120mm	QAT2200
3	359700	Dichtung für Pizzaofen Fiberglas ID ø 32,5mm AD ø 55mm Materialstärke 5mm	AL26600
4	359661	Linsennippel Gewinde 32,1 ø 58mm Hartglas 350°C	AL20100



Abb.	GEV-Nr.	Beschreibung	Vergl.-Nr.
1	359320	Lampenfassung Fassung G6,35 24V ø 16mm H 10mm Anschluss Flachstecker 6,3mm BA 26mm	EL05600
2	698561	Halterung für Lampe L 178mm B 98mm H 40mm	HAT6400
3	698562	Reflektor L 120mm B 108mm H 33mm ø 120mm	QAT2200
4	359700	Dichtung für Pizzaofen Fiberglas ID ø 32,5mm AD ø 55mm Materialstärke 5mm	AL26600



Abb.	GEV-Nr.	Beschreibung	Vergl.-Nr.
5	359661	Linsennippel Gewinde 32,1 ø 58mm Hartglas 350°C	AL20100



Abb.	GEV-Nr.	Beschreibung	Vergl.-Nr.
1	359320	Lampenfassung Fassung G6,35 24V ø 16mm H 10mm Anschluss Flachstecker 6,3mm BA 26mm	EL05600
2	359322	Lampenhalter für Lampenfassung	HAT5910

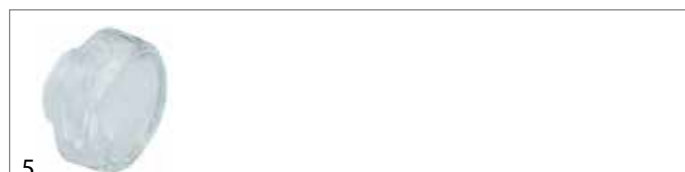

Abb.	GEV-Nr.	Beschreibung	Vergl.-Nr.
1	359639	Lampenfassung E14 mit Klemmbefestigung	EL06900
2	359323	Lampenglas mit Dichtung L 154mm B 63mm Materialstärke 8mm	AL04000
3	359325	Dichtung für Lampenglas	AL03220

RATIONAL



Abb.	GEV-Nr.	Beschreibung	Vergl.-Nr.
1	359873	Lampenfassung G4 für Halogenlampen	8514.1018
2	359879	Dichtung für Lampe 100x76mm	5110.1023
3	359877	Lampenglas L 95mm B 72mm Materialstärke 4mm	5201.1000



Abb.	GEV-Nr.	Beschreibung	Vergl.-Nr.
4	359880	Dichtung für Lampe 95xx72mm	5110.1022
5	359876	Rahmen für Lampenglas	8514.1017



Abb.	GEV-Nr.	Beschreibung	Vergl.-Nr.
1	359874	Lampenfassung G4 für Halogenlampen	40.00.098
2	359881	Dichtung für Lampe 85x70mm	40.00.094
3	359878	Lampenglas L 80mm B 65mm Materialstärke 4mm	40.00.095



Abb.	GEV-Nr.	Beschreibung	Vergl.-Nr.
4	359882	Dichtung für Lampe 81x65mm	40.00.093
5	359875	Lampenglas mit Dichtung und Rahmen	40.00.091

RETIGO



Abb.	GEV-Nr.	Beschreibung	Vergl.-Nr.
1	359922	Lampenfassung mit 2-Lochbefestigung 25V Fassung G4 Anschluss Kabel 140mm ø 17mm H 10mm BA 11,5mm	EA13-0101
2	357182	Lampenglas ø 37mm Materialstärke 3mm	AX07-0001
3	357183	Dichtung für Lampenfassung Materialstärke 1,5mm ø 37mm Graphit ID ø 31mm	AX07-0002



Abb.	GEV-Nr.	Beschreibung	Vergl.-Nr.
1	359922	Lampenfassung mit 2-Lochbefestigung 25V Fassung G4 Anschluss Kabel 140mm ø 17mm H 10mm BA 11,5mm	EA13-0101
2	680001	Lampenglas ø 69mm Materialstärke 2,9mm	AX07-0004
3	680000	Dichtung Garraumbeleuchtung ø 92mm ID ø 58mm Gummi Materialstärke 7,6mm geeignet für RETIGO	AX07-0006

**SALVA**

Abb.	GEV-Nr.	Beschreibung	Vergl.-Nr.
1	359922	Lampenfassung mit 2-Lochbefestigung 25V Fassung G4 Anschluss Kabel 140mm ø 17mm H 10mm BA 11,5mm	—
2	357107	Lampenglas L 126mm B 37mm Materialstärke 4mm	—

ZANOLLI

Abb.	GEV-Nr.	Beschreibung	Vergl.-Nr.
1	359666	Lampenfassung Fassung E27 250V ø 40mm H 46mm Anschluss Schraubanschluss mit Befestigungswinkel	ELET0227
2	693380	Glasscheibe 100x100x6mm (Mattglas)	CRIS0023



Abb.	GEV-Nr.	Beschreibung	Vergl.-Nr.
1	359664	Lampenfassung B 21mm Fassung GU10 Anschluss Klemmanschluss ø 17mm H 12mm	LAMP0021
2	359665	Halogenlampe GU10 230V 50W	LAMP0037
3	693379	Glasscheibe 180x90x6mm	CRIS0006

Leuchtmittel**Glühlampen**

Abb.	GEV-Nr.	Fassung	Spng. (V)	Leist. (W)	T.max. (°C)
1	359610	E14	230	15	300
1	359740	E14	230	15	300
1	357153	E14	230	25	300
1	359612	E14	230	25	300
1	359448	E14	230	25	500
1	357099	E14	235	15	500
2	357118	E14	230/240	40	500
3	359615	E14	230	25	300
3	357154	E14	230	40	300
3	359611	E14	230	40	300
3	357100	E14	220-260	25	500
3	357101	E14	220-260	40	500
4	359613	E27	230	25	300
4	359614	E27	230	40	300
4	357102	E27	220-260	25	500
4	357103	E27	220-260	40	500



Abb.	GEV-Nr.	Fassung	Spng. (V)	Leist. (W)	T.max. (°C)
5	359849	E27	230	60	-

Halogenlampen**für Fassung E14 / E27**

Abb.	GEV-Nr.	Fassung	Spng. (V)	Leist. (W)	Hersteller	VPE
1	359728	E14	230	40	-	1
2	359683	E27	240	60	-	1

für Fassung G4 / G6,35 / G9

Abb.	GEV-Nr.	Fassung	Spng. (V)	Leist. (W)	Temp.Best. (°C)	Hersteller
1	357188	G4	12	5	300	OSRAM
1	359579	G4	12	5	500	-
1	357189	G4	12	5	-	OSRAM
1	357191	G4	12	10	300	OSRAM
1	359596	G4	12	10	500	-
1	357190	G4	12	10	-	OSRAM
1	357193	G4	12	20	300	OSRAM
1	359599	G4	12	20	500	-
1	357192	G4	12	20	-	OSRAM
2	359074	G6,35	12	35	500	-
2	357194	G6,35	12	35	-	OSRAM
3	359945	G9	230	25	300	-
3	357195	G9	230	25	300	OSRAM
3	359946	G9	230	40	300	-
3	357196	G9	230	40	300	OSRAM

für Fassung GU5,3 / GU10

Abb.	GEV-Nr.	Fassung	Spng. (V)	Leist. (W)	Temp.Best. (°C)
1	359665	GU10	230	50	-
2	357054	GU5,3	12	20	-
2	359496	GU5,3	12	50	-
3	359300	GZ5,3	235	25	400



Fassungen

G4 / G5,3 / G6,35



Abb.	GEV-Nr.	Fassung	ø (mm)	H (mm)	BA (mm)	KL (mm)
1	359304	G4	17	9	12	120
1	357185	G4/G5,3/G6,35	17	9	12	750
2	359369	G4/G5,3/G6,35	17	10	11,5	730
3	359923	G4/G5,3/G6,35	17	10	26	140
3	359646	G4/G5,3/G6,35	17	15	26	130

E14



Technische Daten:
Durchmesser 43,5mm
Anschluss Schraubanschluss

Abb.	GEV-Nr.	H (mm)	BA (mm)
1	357130	46,5	-

E27



Technische Daten:
Anschluss Schraubanschluss

Abb.	GEV-Nr.	ø (mm)	H (mm)	BA (mm)	Abb.	GEV-Nr.	ø (mm)	H (mm)	BA (mm)
1	359917	45	56	-	2	359921	52	52	54
1	359918	45	63	-	3	359919	53	38	-

Restwärmeanzeigen



Abb.	GEV-Nr.	Ausführung	Spng. (V)	Anschluss	Einbau ø (mm)
1	359429		230	F6,3	18
2	357003	1-fach	250	F6,3	14

Handlampen



Abb.	GEV-Nr.	Beschreibung
1	550441	Stableuchte Kabel PVC Kabellänge 5m



Abb.	GEV-Nr.	Beschreibung
2	801398	Taschenlampe LED 1W ø 27mm Griff ø 19mm L 155mm



Abb.	GEV-Nr.	Beschreibung
3	801327	Taschenlampe LED 1W ø 35mm Griff ø 27mm L 143mm

