



# Spare Parts for Combi Ovens



Spare parts suitable for

# HOBART

# 2017

Find the complete and up-to-date range of products in our GEV Webshop



## heating elements

## immersion heating elements

3 hole flange ø57.5mm

<b>GEV No.</b>	418140	<b>Ref. No.</b>	1235430
<b>description</b>	heating element 7500W 230V mounting ø 57.5mm heating circuits 3 L 295mm W 34mm H 45mm number of thermostat sleeves 1 thermostat sleeves ø 7mm length thermostat sleeves 275mm thermostat sleeve not clinging hole distance 72mm hole ø 8mm connection M4 3 hole flange immersion heater		





## miscellaneous

<b>GEV No.</b>	416502	<b>Ref. No.</b>	322158 322158-04 322158-4 845370-01 845370-1
<b>description</b>	heating element 8000W 240V heating circuits 3 L 305mm W 40mm Hmm number of thermostat sleeves thermostat sleeves ømm length thermostat sleevesmm tube ø 6.3mm hole distance 44.9mm hole ø 10mm connection length 23mm connection male faston 6.3mm 4 hole flange immersion heater flange width 63.5mm flange length 63.5mm ø 40mm		
<b>For models:</b>	CO-0611E, CO-1011E, CO-2011E, CS-0611E, CS-0612E, CS-0612E-A, CS-1011E, CS-1012E, CS-1012E-A, CS-1022E, CS-1022E-A, CS-2011E, CS-2012E, CS-2012E-A, CS-2022E, CS-2022E-A, CSD-0611E, CSD-0612E, CSD-0612E-A, CSD-1011E, CSD-1012E, CSD-1012E-A, CSD-1022E, CSD-1022E-A, CSD-2011E, CSD-2012E, CSD-2012E-A, CSD-2022E, CSD-2022E-A		
<b>accessories for</b>	416502		
	<b>GEV No.</b>	505180	<b>Ref. No.</b> 00-233982-001 00-276903-021 233982-1 276903-21
O-ring EPDM thickness 3.53mm ID ø 47.22mm Qty 1 pcs			



## heating elements for convection

<b>GEV No.</b>	418916	<b>Ref. No.</b>	845265-02 845265-1
<b>description</b>	heating element 12000W 240V heating circuits 3 ID ø 390mm ED ø 410mm L 410mm H 100mm H1 25mm H2 75mm thread M12x1 6 hole fixing connection male faston 6.3mm tube ø 8.5mm convection heating element		
<b>For models:</b>	CSL-10E, CSM-1011IE, CSM-1011N, CSM-1021IE, CSM-1021N, CSM-2021IE, CSM-2021N		
<b>accessories for</b>	418916		
	<b>GEV No.</b>	101566	<b>Ref. No.</b> —
nut thread M12x1 H 10mm WS 19 SS Qty 1 pcs			
	<b>GEV No.</b>	506046	<b>Ref. No.</b> —
flat gasket FIBER ED ø 19.5mm ID ø 13mm thickness 2mm Qty 1 pcs			
	<b>GEV No.</b>	528622	<b>Ref. No.</b> —
spring ø 15.3mm L 25mm wire gauge ø 1.25mm for water filling			
<b>GEV No.</b>	418929	<b>Ref. No.</b>	845265-05
<b>description</b>	heating element 6000W 240V heating circuits 3 ID ø 395mm ED ø 415mm L 415mm H 100mm H1 15mm H2 85mm thread M12x1 6 hole fixing connection male faston 6.3mm tube ø 8.5mm convection oven convection heating element		
<b>For models:</b>	CSM-2011IE, CSM-2011N		
<b>accessories for</b>	418929		
	<b>GEV No.</b>	101566	<b>Ref. No.</b> —
nut thread M12x1 H 10mm WS 19 SS Qty 1 pcs			
	<b>GEV No.</b>	506046	<b>Ref. No.</b> —
flat gasket FIBER ED ø 19.5mm ID ø 13mm thickness 2mm Qty 1 pcs			
	<b>GEV No.</b>	528662	<b>Ref. No.</b> —
flat gasket copper ED ø 16mm ID ø 12mm thickness 1.5mm			



 <p>1</p>			
<b>GEV No.</b>	418930	<b>Ref. No.</b>	845265-04
<b>description</b>	heating element 6000W 240V heating circuits 3 ID ø 430mm ED ø 450mm L 470mm H 115mm H1 43mm H2 72mm thread M12x1 6 hole fixing connection male faston 6.3mm tube ø 8.5mm convection oven convection heating element		
<b>For models:</b>	CSM-2011IE, CSM-2011N		
<b>accessories for</b>	418930		
	<b>GEV No.</b>	101566	<b>Ref. No.</b> —
	nut thread M12x1 H 10mm WS 19 SS Qty 1 pcs		
	<b>GEV No.</b>	506046	<b>Ref. No.</b> —
	flat gasket FIBER ED ø 19.5mm ID ø 13mm thickness 2mm Qty 1 pcs		
	<b>GEV No.</b>	528662	<b>Ref. No.</b> —
	flat gasket copper ED ø 16mm ID ø 12mm thickness 1.5mm		

 <p>1</p>			
<b>GEV No.</b>	418926	<b>Ref. No.</b>	845265-03
<b>description</b>	heating element 8000W 240V heating circuits 3 ID ø 301mm ED ø 317mm L 328mm H 95mm L1 11mm H1 12mm H2 83mm thread M12x1 6 hole fixing connection male faston 6.3mm tube ø 8.5mm convection oven convection heating element		
<b>For models:</b>	CSL-06E, CSM-0611IE, CSM-0611N		

 <p>1</p>			
<b>GEV No.</b>	418925	<b>Ref. No.</b>	233848-2
<b>description</b>	heating element 1500W 230V heating circuits 1 L 293mm W 106mm L1 32mm L2 261mm W2 83mm flange length 50mm flange width 26mm connection length 63mm connection male faston 6.3mm tube ø 8.5mm hole ø 6.2mm W1 23mm convection heating element convection oven INCOLOY windings 2		
<b>For models:</b>	CO-0611E, CO-1011E, CO-2011E, CS-0611E, CS-1011E, CS-2011E, CSD-0611E, CSD-1011E, CSD-2011E		
<b>accessories for</b>	418925		
	<b>GEV No.</b>	520588	<b>Ref. No.</b> —
	gasket L 46mm W 22mm hole distance 24.5mm silicone for heating element		

accessories

sealing washers

O-rings

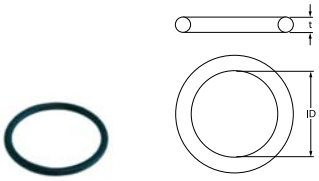
 <p>1</p>			
<b>GEV No.</b>	510409	<b>Ref. No.</b>	00-276903-053 00-67500-016 00-67500-118 276903-53 670500-118 67500-16
<b>description</b>	O-ring EPDM thickness 5.34mm ID ø 56.52mm Qty 1 pcs		
<b>For models:</b>	CR-F, CX, ECW, EWB-S, FTN, FTT, FTX, FUX, ML-104674, ML-104683, ML-104686, UW-135, UW-135H, UWX, UX-60, UX-60B, UX-60E, UX-60EB, UX-60EH, UX-60EHB, UX-60H, UX-60HB, UXT, UXTH, UXTHL, UXTHLS, UXTHS, UXTL, UXTLH, UXTLHS, UXTLS, UXTS, V1401		

energy regulators

EGO

1-circuit

 <p>1</p>			
<b>GEV No.</b>	380015	<b>Ref. No.</b>	301200 T301200
<b>description</b>	energy regulator 230V 13A single-circuit turn direction right shaft ø 6x4.6mm shaft L 23mm mounting thread M4 power release 6-100% no. 50.57021.010		

thermostats

bi-metal thermostats

bi-metal thermostats

 <p>1</p>			
<b>GEV No.</b>	390504	<b>Ref. No.</b>	236052 E236052
<b>description</b>	bi-metal thermostat hole distance 23.8mm switch-off temp. 90°C 1NO 1-pole 16A 250V connection F6.3 2 hole fixing probe ø 16mm		



control and safety thermostats

EGO

safety thermostats

55.32\_ series



<b>GEV No.</b>	375984	<b>Ref. No.</b>	301061 T301061
<b>description</b>	safety thermostat switch-off temp. 225°C 3-pole 3NC 20A probe ø 6mm probe L 94mm capillary pipe 900mm capillary pipe isolated 670mm gland nut M10x1 probe SS		

56.\_ series



<b>GEV No.</b>	375442	<b>Ref. No.</b>	301066
<b>description</b>	safety thermostat capillary pipe 1760mm probe ø 4mm 1-pole probe L 100mm 16A capillary pipe isolated 1600mm gland nut switch-off temp. 320°C probe M10x1		
<b>accessories for</b>	375442		
	<b>GEV No.</b>	101860	<b>Ref. No.</b> —
	nut thread M10x1 H 4mm WS 14 chrome-plated brass Qty 1 pcs		

control thermostats with operation switch

55.34\_ series

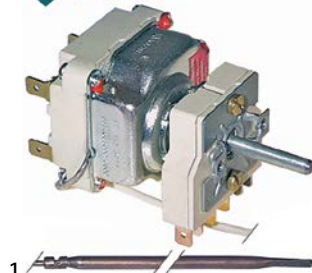

<b>GEV No.</b>	375246	<b>Ref. No.</b>	301034 T301034
<b>description</b>	thermostat t.max. 645°C temperature range 100-615/645°C 2-pole 2NO 16A probe ø 4mm probe L 230mm capillary pipe 1100mm capillary pipe isolated 600mm gland nut shaft ø 6x4.6mm shaft L 25mm shaft position lower rotation 270° outer switch 2NO probe material copper		

IMIT / TEMPOMATIC / ARATHERMO

control thermostats



<b>GEV No.</b>	375847	<b>Ref. No.</b>	E929044
<b>description</b>	thermostat t.max. 90°C temperature range 0-90°C 1-pole 1CO 15A probe ø 6.5mm probe L 100mm capillary pipe 1500mm capillary pipe isolatedmm gland nut shaft ø 6x4.6mm shaft L 18mm shaft position +135° rotation 270° 250V		

COTHERM



<b>GEV No.</b>	390440	<b>Ref. No.</b>	154344 492105
<b>description</b>	safety thermostat t.max. 220°C temperature range°C 1-pole 1NC 25A probe ø 3mm probe L 130mm capillary pipe 1720mm capillary pipe isolatedmm gland nut switch-off temp. 220°C probe SS		
<b>For models:</b>	CS-0612E-A, CSD-0612E-A, CSD-0612ET, CSD-0612-UC, CSD-1012ET, CSD-1012-UC, CSD-1013G, CSD-1022-UC, CSD-2012ET, CSD-2012-UC, CSD-2013G, CSD-2022-UC, CSL-0423E, CSL-0423EK, CSL-0523E, CSL-0523EK, CSL-06E, CSL-10E, CSL-423E, CSL-423K, CSM-0611IE, CSM-0611N, CSM-1011IE, CSM-1011N, CSM-1021IE, CSM-1021N, CSM-2011IE, CSM-2011N, CSM-2021IE, CSM-2021N		

accessories

connecting bows



<b>GEV No.</b>	550060	<b>Ref. No.</b>	300177 T300177
<b>description</b>	connecting bow long for thermostat Qty 1 pcs		



switches and momentary switches

rocker/momentary rocker switches

30x22mm



<b>GEV No.</b>	301003	<b>Ref. No.</b>	15243565 F15243565
<b>description</b>	rocker switch mounting measurements 30x22mm green 2NO 250V 16A illuminated 0-I connection male faston 6.3mm ambient temperature max. 125/55°C protection IP65		
<b>accessories for</b>	301003		
	<b>GEV No.</b>	301036	<b>Ref. No.</b> —
	protective cover internal size 30x22mm for rocker switch mounting measurementsmm		

system switches (ROLD)



<b>GEV No.</b>	345606	<b>Ref. No.</b>	139321-455 E226071
<b>description</b>	momentary switch unit 2CO 250V 16A connection male faston 6.3mm		
<b>For models:</b>	CLG-25		

cam switches

operation switches



<b>GEV No.</b>	300080	<b>Ref. No.</b>	491175
<b>description</b>	cam switch 2 operating positions 4NO 16A sequence 0-1 shaft $\phi$ 6x4.6mm shaft L 23mm connection screw operation switch ceramic ambient temperature max. 150°C		
<b>accessories for</b>	300080		
	<b>GEV No.</b>	551456	<b>Ref. No.</b> —
	gasket for switch ED $\phi$ 14mm ID $\phi$ 2.5mm thickness 3.5mm white		

magnetic switches

50x19mm

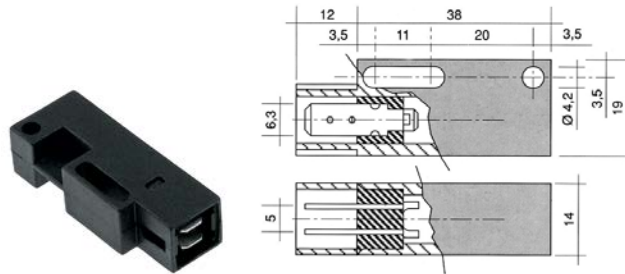

<b>GEV No.</b>	345821	<b>Ref. No.</b>	775491-1
<b>description</b>	magnetic switch L 50mm W 19mm 1NO 250V 1A P max. 50W connection male faston 6.3mm		
<b>For models:</b>	AM-700, AM900, AMS900, AMX, AMX-900, AMX-E, AMX-ER, AMX-R, AMXR-900, AMXS-900, AMXX-1300, AMXXR-1300, AMXXS-1300, AMXXT, AUX, AUX-E, AUX-ER, AUX-R, AUXX-1300, AUXXL, AUXXR-1300, AUXXS-1300, AUXXT, CNA, CNR, ECOMAX-650, ECOMAX-700, FX, GX, UX-30, UX-30B, UX-30E, UX-30EB, UX-30EH, UX-30ES, UX-30ESB, UX-30ESH, UX-30H, UX-30-McDonalds, UX-30S, UX-30SB, UX-30SH, UXD-30		
<b>accessories for</b>	345821		
	<b>GEV No.</b>	519049	<b>Ref. No.</b> —
	magnet $\phi$ mm L 63mm H 10.7mm W 18.8mm hole distance 52mm M2 hole $\phi$ 2mm		

80x30mm

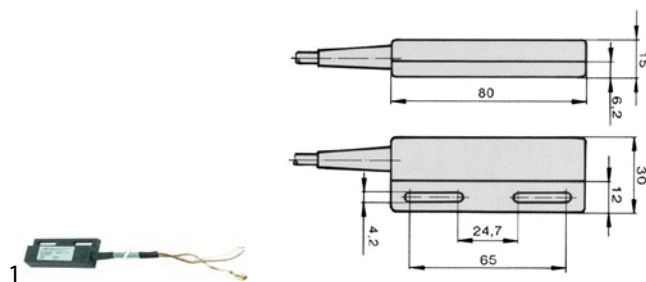

<b>GEV No.</b>	345919	<b>Ref. No.</b>	297980-3
<b>description</b>	magnetic switch L 80mm W 30mm connection cable		
<b>For models:</b>	HX, HX-30E, HX-30ES, HX-40E, HX-40ES, HX-E, HX-ES, HX-S		

accessories

magnets

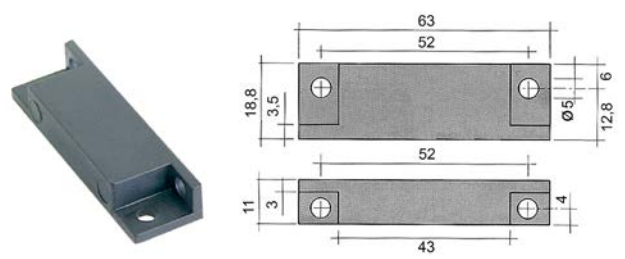

<b>GEV No.</b>	345336	<b>Ref. No.</b>	E926014
<b>description</b>	magnet $\phi$ 4.8mm L 63mm H 11mm W 18.8mm hole distance 51mm M4		

→ electric components



## lamps

## indicator lights

## indicator lights 2-piece (lens and indicator lamp)

## indicator light lenses

ø12mm (type SDY-3)



1

<b>GEV No.</b>	359262	<b>Ref. No.</b>	E926114
<b>description</b>	indicator light housings mounting measurements ø12mm green round Qty 1 pcs		

## indicator lamps for socket type SRZ / SDK / SDY / SFK



1

<b>GEV No.</b>	359130	<b>Ref. No.</b>	216006 E216006
<b>description</b>	indicator lamp 230V clear connection male faston 6.3mm ø 8mm		

## screw-on/push-on fit

## halogen lamp

for socket G4 / G6.35 / G9



1

<b>GEV No.</b>	357193	<b>Ref. No.</b>	1235342
<b>description</b>	halogen lamp socket G4 12V 20W temp.-resist. 300°C OSRAM HALOSTAR OVEN		



1

<b>GEV No.</b>	359599	<b>Ref. No.</b>	01-235542 844952
<b>description</b>	halogen lamp socket G4 12V 20W temp.-resist. 500°C		

## fluorescent lamps

## fluorescent lamps

G23

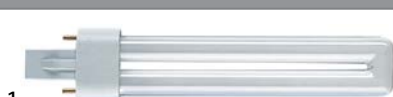

1

<b>GEV No.</b>	359933	<b>Ref. No.</b>	371120-399 491761-001 491761-1
<b>description</b>	fluorescent lamp socket G23 L 237mm 11W 230V		

## oven lamps

## lamps

## halogen lamps

for socket G4 / G6.35 / G9



1

<b>GEV No.</b>	357193	<b>Ref. No.</b>	1235342
<b>description</b>	halogen lamp socket G4 12V 20W temp.-resist. 300°C OSRAM HALOSTAR OVEN		



1

<b>GEV No.</b>	359599	<b>Ref. No.</b>	01-235542 844952
<b>description</b>	halogen lamp socket G4 12V 20W temp.-resist. 500°C		

## alarm devices

## buzzers



1

<b>GEV No.</b>	350050	<b>Ref. No.</b>	173864
<b>description</b>	buzzer 230VAC connection male faston 6.3mm screw mounting thread M4 60dB		
<b>For models:</b>	CO-0611E, CO-0612E, CO-1011E, CO-1012E, CO-2011E, CS-0423E, CS-0423EK, CS-0523E, CS-0523EK, CS-0611E, CS-0612E, CS-1011E, CS-1012E, CS-2011E, CS-2012E, CS-2022E, CS-423E, CS-423K, CSD-0611E, CSD-0612E, CSD-1011E, CSD-1012E, CSD-2011E, CSD-2012E, CSD-2022E, CSL-06E, CSL-10E, CSM-0611E, CSM-0611N, CSM-1011E, CSM-1011N, CSM-1021E, CSM-1021N, CSM-2011E, CSM-2011N, CSM-2021E, CSM-2021N		

## contactors

## GENERAL ELECTRIC (AEG)

## power contactors



1

<b>GEV No.</b>	380239	<b>Ref. No.</b>	00-695507-001
<b>description</b>	power contactor resistive load 20A 230VAC (AC3/400V) 8.4A/4kW main contacts 3NO auxiliary contacts 1NC connection screw connection type LS05 01A type AEG LS05 01A type GE MC1A 301A		



SIEMENS

power contactors



1

<b>GEV No.</b>	380389	<b>Ref. No.</b>	E229037
<b>description</b>	power contactor resistive load 22A 230VAC (AC3/400V) 9A/4kW main contacts 3NO auxiliary contacts 1NO connection screw connection type 3RT10-16-1AP01		



1

<b>GEV No.</b>	380957	<b>Ref. No.</b>	E927160
<b>description</b>	power contactor resistive load 22A 24VAC (AC3/400V) 12A/5.5kW main contacts 3NO auxiliary contacts 1NO connection screw connection type 3RT10-17-1AB01 50/60Hz		

TELEMECANIQUE (Schneider Electric)

power contactors



1

<b>GEV No.</b>	380820	<b>Ref. No.</b>	00-695527-002
<b>description</b>	power contactor resistive load 25A 230VAC (AC3/400V) 9A/4kW main contacts 3NO auxiliary contacts 1NO/1NC connection screw connection type LC1D0900M7		



1

<b>GEV No.</b>	380976	<b>Ref. No.</b>	296926-2
<b>description</b>	power contactor resistive load 32A 230VAC (AC3/400V) 18A/7.5kW main contacts 3NO auxiliary contacts 1NO/1NC connection screw connection		

relays

power relays

with bracket mounting



1

<b>GEV No.</b>	380312	<b>Ref. No.</b>	00-139321-354 229023
<b>description</b>	power relays FINDER 230VAC 10A 3CO connection male faston 4.8mm bracket mounting dimensions 52x32.2x36.5mm manuf. no. 60.63.8.230.0000		

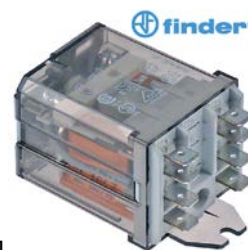

1

<b>GEV No.</b>	380139	<b>Ref. No.</b>	929115
<b>description</b>	power relays FINDER 230VAC 16A 2CO connection F6.3 bracket mounting dimensions 68x38.2x35.8mm manuf. no. 62.82.8.230.0000		



1

<b>GEV No.</b>	380403	<b>Ref. No.</b>	900073
<b>description</b>	power relays FINDER 230VAC 16A 3CO connection F6.3 bracket mounting manuf. no. 62.83.8.230.0500		

1

<b>GEV No.</b>	380702	<b>Ref. No.</b>	139321-528
<b>description</b>	power relays FINDER 230VAC 16A 3NO connection male faston 6.3mm flange dimensions 36x38x68mm manuf. no. 62.83.8.230.0300 230V		



1

<b>GEV No.</b>	380185	<b>Ref. No.</b>	139321-686 371450-010
<b>description</b>	power relays Italiana Relè 230VAC 30A 1NO connection F6.3 bracket mounting dimensions 36.5x32.2x51.8mm manuf. no. A10-230AC-FA		
<b>For models:</b>	CHH-50, CHH-60D, EH-60		

## electronic controllers

### LOREME

#### analogue



1

<b>GEV No.</b>	379745	<b>Ref. No.</b>	480978 845246 845379-1
<b>description</b>	electronic controller kit LOREME type Dsl 94 mounting measurements 66x32mm 230V voltage AC TC/J 0-250°C display without display relay outputs 2 front measurements 70x34mm built-in depth 95mm cable length 2530mm probe L 20mm probe ø 4mm with probe and fastening material		
<b>For models:</b>	CSL-06E, CSL-10E, CSM-0611IE, CSM-0611N, CSM-1011IE, CSM-1011N, CSM-1021IE, CSM-1021N, CSM-2011IE, CSM-2011N, CSM-2021IE, CSM-2021N		
<b>spare parts for</b>	379745		
	<b>GEV No.</b>	379744	<b>Ref. No.</b> 480974
<b>description</b>	electronic controller LOREME type Dsl 94 mounting measurements 66x32mm 230V voltage AC TC/J 0-250°C display without display relay outputs 2 front measurements 70x34mm built-in depth 95mm		

## electronics

### PCBs



1

<b>GEV No.</b>	403041	<b>Ref. No.</b>	00-895401-016 895401-16
<b>description</b>	PCB cable length 220mm with relay		
<b>For models:</b>	CSD-0612-UC, CSD-1012-UC, CSD-1022-UC, CSD-2012-UC, CSD-2022-UC		

## solenoïd valves

### solenoïd valves (water)

#### ELBI

#### straight



1

<b>GEV No.</b>	373017	<b>Ref. No.</b>	371450-021
<b>description</b>	solenoid valve single straight 230VAC inlet 3/4" outlet 11.5mm DN10 ELBI		
<b>spare parts for</b>	373017		
	<b>GEV No.</b>	370467	<b>Ref. No.</b> —
<b>description</b>	solenoid valve filter suitable for ELBI		

#### spare parts and accessories

#### reducers

#### outlet side



1











<b>GEV No.</b>	371260	<b>Ref. No.</b>	E133009
<b>description</b>	reducer type ELBI flow rate 0.5l/min pressure range 0 up to 10bar tolerance ±15/25% red		













## MÜLLER

medium temperature: 90°C  
duty cycle: 100%

 <p>1</p>			
<b>GEV No.</b>	370003	<b>Ref. No.</b>	324208-4
<b>description</b>	solenoid valve double angled 230VAC inlet 3/4" outlet 14.5mm DN10 t.max. 90°C duty cycle 100% MÜLLER		
<b>For models:</b>	FX		
<b>spare parts for</b>	370003		
	<b>GEV No.</b>	370128	<b>Ref. No.</b> —
	solenoid valve body double angled inlet 3/4" outlet 14.5mm DN10 t.max. 90°C duty cycle 100% MÜLLER 230V double-ways		
	<b>GEV No.</b>	371002	<b>Ref. No.</b> —
	solenoid valve holder MÜLLER flange support		
	<b>GEV No.</b>	371009	<b>Ref. No.</b> —
	compression spring for solenoid coil		
	<b>GEV No.</b>	371011	<b>Ref. No.</b> —
	spare parts kit membrane with long star star hight 8mm MÜLLER		
	<b>GEV No.</b>	371017	<b>Ref. No.</b> —
	solenoid coil MÜLLER 230VAC connection male faston 6.3mm		
	<b>GEV No.</b>	371122	<b>Ref. No.</b> —
	solenoid valve filter ø 19mm H 10mm suitable for MÜLLER		
	<b>GEV No.</b>	501161	<b>Ref. No.</b> —
	tap head for solenoid valve holder for solenoid coils		
<b>accessories for</b>	370003		
	<b>GEV No.</b>	371010	<b>Ref. No.</b> —
	solenoid coil 230VAC connection with cable cable length 2000mm		
	<b>GEV No.</b>	371037	<b>Ref. No.</b> —
	solenoid coil 24VAC 50/60Hz connection male faston 6.3mm		
	<b>GEV No.</b>	371038	<b>Ref. No.</b> —
	solenoid coil 230VAC connection appliance plug		

 <p>1</p>			
<b>GEV No.</b>	370001	<b>Ref. No.</b>	324207-1
<b>description</b>	solenoid valve single angled 230VAC inlet 3/4" outlet 14.5mm DN10 t.max. 90°C duty cycle 100% MÜLLER		
<b>For models:</b>	AM3, AMX, AMX-E, AMX-ER, AMX-R, AUX, AUX_, AUX-E, AUX-ER, AUX-R, FE, FX, GX, HE, HE-P, HX, HX-30, HX-30E, HX-40, HX-40E, HX-60-EHL, HX-E, HX-ES, HX-S, UX-30, UX-30B, UX-30E, UX-30EB, UX-30EH, UX-30H, UX-30-McDonalds, UX-60, UX-60B, UX-60E, UX-60EB, UX-60EH, UX-60EHB, UX-60H, UX-60HB, UXD-30		
<b>spare parts for</b>	370001		
	<b>GEV No.</b>	370126	<b>Ref. No.</b> —
	solenoid valve body single angled inlet 3/4" outlet 14.5mm DN10 t.max. 90°C duty cycle 100% MÜLLER plastic		
	<b>GEV No.</b>	371002	<b>Ref. No.</b> —
	solenoid valve holder MÜLLER flange support		
	<b>GEV No.</b>	371009	<b>Ref. No.</b> —
	compression spring for solenoid coil		
	<b>GEV No.</b>	371011	<b>Ref. No.</b> —
	spare parts kit membrane with long star star hight 8mm MÜLLER		
	<b>GEV No.</b>	371017	<b>Ref. No.</b> —
	solenoid coil MÜLLER 230VAC connection male faston 6.3mm		
	<b>GEV No.</b>	371122	<b>Ref. No.</b> —
	solenoid valve filter ø 19mm H 10mm suitable for MÜLLER		
<b>accessories for</b>	370001		
	<b>GEV No.</b>	371010	<b>Ref. No.</b> —
	solenoid coil 230VAC connection with cable cable length 2000mm		
	<b>GEV No.</b>	371037	<b>Ref. No.</b> —
	solenoid coil 24VAC 50/60Hz connection male faston 6.3mm		
	<b>GEV No.</b>	371038	<b>Ref. No.</b> —
	solenoid coil 230VAC connection appliance plug		



<h2>TP</h2>  <p>1</p>			
<b>GEV No.</b>	370111	<b>Ref. No.</b>	E927001
<b>description</b>	solenoid valve double straight 24VAC inlet 3/4" outlet 11.5mm DN10 TP		
<b>spare parts for</b>	370111		
	<b>GEV No.</b>	371035	<b>Ref. No.</b> —
	solenoid coil 24VAC		

Table continues overleaf



accessories for		370111		
GEV No.	371220	Ref. No.	—	
	reducer TP flow rate 3l/min red tolerance ±15%			
	reducer TP flow rate 5.5l/min yellow tolerance ±15%			
	reducer TP flow rate 6l/min grey tolerance ±15%			
	reducer TP flow rate 10l/min white tolerance ±15%			
	reducer TP flow rate 12l/min bronze tolerance ±15%			
	reducer TP flow rate 16l/min light brown tolerance ±15%			
	reducer TP flow rate 20l/min red tolerance ±15%			
	reducer TP flow rate 0.25l/min red tolerance ±25%			
	reducer TP flow rate 0.35l/min violet tolerance ±25%			
	reducer TP flow rate 0.5l/min orange tolerance ±25%			
	reducer TP flow rate 0.8l/min white tolerance ±25%			
	reducer TP flow rate 1l/min light blue tolerance ±25%			
	reducer TP flow rate 1.2l/min brown tolerance ±25%			
	reducer TP flow rate 1.5l/min light brown tolerance ±25%			
	reducer TP flow rate 2.5l/min yellow tolerance ±25%			
	reducer TP flow rate 3.4l/min dark green tolerance ±25%			
	reducer TP flow rate 5l/min black tolerance ±25%			
	reducer TP flow rate 8l/min blue tolerance ±20%			

solenoid valves with reducers			
	1		
<b>GEV No.</b>	370628	<b>Ref. No.</b>	00-139321-65
<b>description</b>	solenoid valve double straight 230VAC inlet 3/4" input 16l/min DN10 TP plastic outlet 11.5mm		

	1		
<b>GEV No.</b>	370245	<b>Ref. No.</b>	E927242
<b>description</b>	solenoid valve single straight 24VAC inlet 3/4" outlet 11.5mm input 16l/min t.max. 90°C TP plastic flow regulating valve inlet light brown		

metal			
ASCO			
spare parts and accessories			
kits			
	1		
<b>GEV No.</b>	371110	<b>Ref. No.</b>	173863-11
<b>description</b>	valve insert type A size 1/2" service kit		
<b>For models:</b>	2226, 2227, AM-12E, AM-12EC, AM-12EF, AM-12ER, AM-600, AM-600C, AM-600CR, AM-600R		

fans

axial fans

import				
	1			
<b>GEV No.</b>	601080 <sup>1</sup>	<b>Ref. No.</b>	00-230324-001	
<b>description</b>	axial fan L 119mm W 119mm H 38mm 230VAC 50/60Hz 23/20W bearing ball bearing connection male faston 2.8mm metal ADDA fan wheel ø 110mm temp.-resist. 70°C			
<b>accessories for</b>	601080			
	<b>GEV No.</b>	550898	<b>Ref. No.</b>	—
	connecting cable cable length 2000mm connection F 2.8 connection distance 7.9mm for axial flow fan			

<sup>1</sup>with ball bearings  
Table continues overleaf

<b>accessories for</b>	601080		
	<b>GEV No.</b>	692519	<b>Ref. No.</b>
			—
	guard L 120mm W 120mm plastic		

## hot air motors

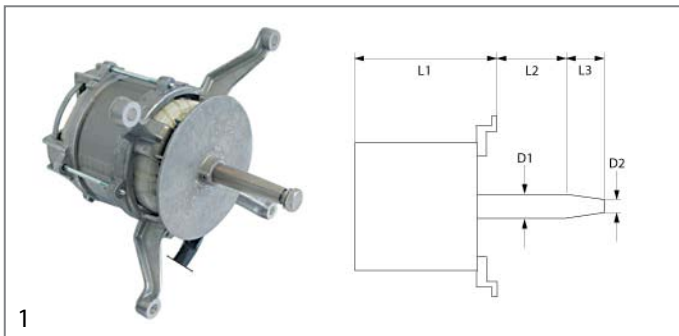

<b>GEV No.</b>	500812	<b>Ref. No.</b>	150443-54 233800-04
<b>description</b>	fan motor 220-240/380-415V 3 phase 50Hz 0.26kW 1440rpm speeds 1 D1 ø 17mm D2 ø 13.5mm		
<b>For models:</b>	CO-0612E, CO-1012E, CS-0612E, CS-1012E		

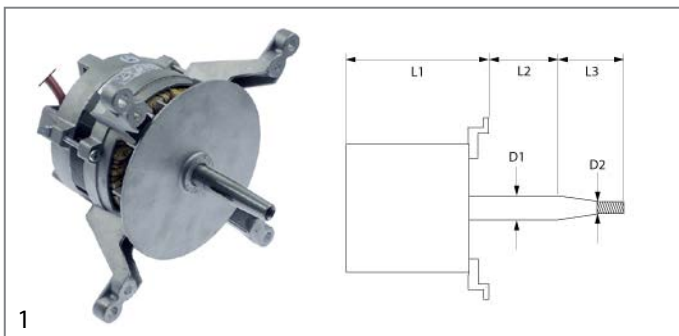



<b>GEV No.</b>	601805	<b>Ref. No.</b>	07426 844955-01
<b>description</b>	fan motor 230V 1 phase 50/60Hz 0.185kW 1400/1680rpm speeds 2 L1 130mm L2 27mm L3 37mm D1 ø 17mm D2 ø 13.5mm 1A suitable capacitor 5µF/450V Cos(φ) 0.93 type 1079GA2350		
<b>For models:</b>	CS-0612E, CS-1012E, CS-1022E, CS-2012E, CS-2022E, CSD-0612E, CSD-1012E, CSD-1013G, CSD-1022E, CSD-2012E, CSD-2013G, CSD-2022E, CSL-06E, CSL-10E, CSM-0611IE, CSM-0611N, CSM-1011IE, CSM-1011N, CSM-1021IE, CSM-1021N, CSM-2011IE, CSM-2011N, CSM-2021IE, CSM-2021N		

<b>accessories for</b>	601805		
	<b>GEV No.</b>	511605	<b>Ref. No.</b>
			322190-1
	shaft seal		

## hot air fans

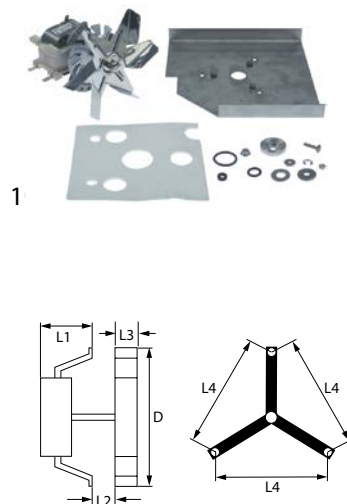
### ebm-papst



<b>GEV No.</b>	601807	<b>Ref. No.</b>	494069
<b>description</b>	hot air fan kit 230V 50W L1 69mm L4 87mm fan wheel ø 151mm type RRL152/0020A92-3030LH-197 ebm-papst		
<b>For models:</b>	CS-0423E, CS-0423EK, CS-0523E, CS-0523EK, CS-423E, CS-423K, CSL-0423E, CSL-0423EK, CSL-0523E, CSL-0523EK, CSL-423E, CSL-423K		
<b>spare parts for</b>	601807		
	<b>GEV No.</b>	601808	<b>Ref. No.</b>
			—
	hot air fan 230/240V 50W L1 69mm L2mm L3mm L4 87mm fan wheel ø 150mm type RRL152/0020A92-3030LH-197 ebm-papst		

## pumps

### drain pumps

#### ASKOLL



<b>GEV No.</b>	500346	<b>Ref. No.</b>	130105
<b>description</b>	drain pump inlet ø 30mm outlet ø 22mm 230V 40W 50Hz ASKOLL type M231 XP with holder		



HANNING

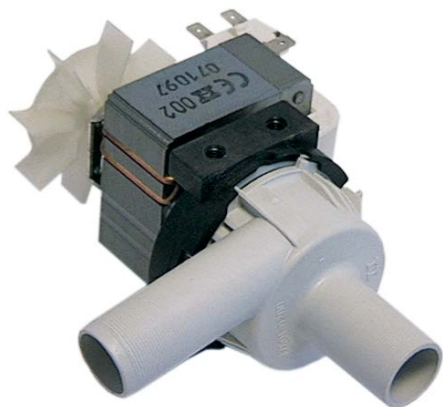

1

<b>GEV No.</b>	500042	<b>Ref. No.</b>	165653-1 old version
<b>description</b>	drain pump 80W 230V inlet ø 24mm outlet ø 24mm 50Hz type KD22B3-679 HANNING		
<b>spare parts for</b>	500042		
	<b>GEV No.</b>	510168	<b>Ref. No.</b> —
	fan wheel shaft intake ø 5mm ø 62mm H 14mm		

booster pumps II

accessories



1

<b>GEV No.</b>	365017	<b>Ref. No.</b>	00-226568-009 01-235398 01-235399 139321-941 226568-9
<b>description</b>	operating capacitor capacity 5µF 450V tolerance 5% 50/60Hz ambient temperature max. -25 to +85°C ø 28mm L 54mm M8 plastic connection male faston 6.3mm 16.10.08 protection		
<b>For models:</b>	AMX, AMX-900, AMX-E, AMX-ER, AMX-R, AMXR-900, AMXS-900, AMXX-1300, AMXXR-1300, AMXXS-1300, AMXXT, AUX, AUX_, AUX-E, AUX-ER, AUX-R, AUXX-1300, AUXXL, AUXXR-1300, AUXXS-1300, AUXXT, CHH-70D, ECOMAX-402, ECOMAX-650, ECOMAX-700, EH-70, FE, FE-W, FX, GX, HX-30, HX-30E, HX-30ES, HX-30S, HX-40, HX-40E, HX-40ES, HX-40S, UX, UX-30, UX-30B, UX-30E, UX-30EB, UX-30EH, UX-30ES, UX-30ESB, UX-30H, UX-30-McDonalds, UX-30S, UX-30SB...(Other models you can see in the webshop)		



1

<b>GEV No.</b>	365012	<b>Ref. No.</b>	206009
<b>description</b>	operating capacitor capacity 6.3µF 450V tolerance 5% 50Hz ambient temperature max. -25 to +85°C ø 30mm L 61mm M8 plastic connection male faston 6.3mm protection		

condensators & interference suppression filters

operating capacitors

plastic



1

<b>GEV No.</b>	365165	<b>Ref. No.</b>	226568-008 226568-8
<b>description</b>	capacitor capacity 12.5µF 450V tolerance 5% 50Hz ambient temperature max. -25 to +85°C ø 35mm L 60mm M8 plastic connection male faston 6.3mm protection		
<b>For models:</b>	FE, FE-W, FX, GX, HE, HE600-HL, HE-P, HX, HX-30, HX-30E, HX-30ES, HX-30S, HX-40, HX-40E, HX-40ES, HX-40S, HX-60-EHL, HX-E, HX-ES, HX-S		



1

<b>GEV No.</b>	365167	<b>Ref. No.</b>	226568-3
<b>description</b>	capacitor capacity 6µF 450V tolerance 5% 50Hz ambient temperature max. -25 to +85°C ø 30mm L 58mm M8 plastic connection male faston 6.3mm		
<b>For models:</b>	FE, G10R, G5R, HE-P, HX, HX-60-EHL, HX-E, HX-ES, HX-S, UX-30, UX-30B, UX-30E, UX-30EB, UX-30EH, UX-30ES, UX-30ESB, UX-30ESH, UX-30H, UX-30-McDonalds, UX-30S, UX-30SB, UX-30SH, UX-60, UX-60B, UX-60E, UX-60EB, UX-60EH, UX-60EHB, UX-60H, UX-60HB		



 <p>1</p>			
<b>GEV No.</b>	365021	<b>Ref. No.</b>	00-226568-013 139321-448 139321-884 226568-13
<b>description</b>	operating capacitor capacity 16µF 425V tolerance 5% 50/60Hz ambient temperature max. -25 to +85°C ø 35mm L 73mm single M8 plastic connection male faston 6.3mm 416.10.99 protection		
<b>For models:</b>	AM-700, AM900, AM900-10N, AM900-90, AMS900, AMS900-10N, AMX, AMX-10HL, AMX-90, AMX-900, AMXR, AMXR-900, AMXS, AMXS-900, AMXT, AMXTS, CHF45, ECOMAX-600, ECOMAX-612-10, ECOMAX-612S-10, ECOMAX-650, EF-40		

 <p>1</p>			
<b>GEV No.</b>	365013	<b>Ref. No.</b>	00-226568-014 00-226568-017 226568-14 226568-17
<b>description</b>	operating capacitor capacity 8µF 400V tolerance 5%Hz ambient temperature max. -25 to +85°C ø 31.5mm L 55mm M8 plastic connection male faston 6.3mm protection		
<b>For models:</b>	FP, FX, FX-McDonalds, GP, GX		

 <p>2</p>			
<b>GEV No.</b>	365017	<b>Ref. No.</b>	00-226568-009 01-235398 01-235399 139321-941 226568-9
<b>description</b>	operating capacitor capacity 5µF 450V tolerance 5% 50/60Hz ambient temperature max. -25 to +85°C ø 28mm L 54mm M8 plastic connection male faston 6.3mm 16.10.08 protection		
<b>For models:</b>	AMX, AMX-900, AMX-E, AMX-ER, AMX-R, AMXR-900, AMXS-900, AMXX-1300, AMXXR-1300, AMXXS-1300, AMXXT, AUX, AUX_, AUX-E, AUX-ER, AUX-R, AUXX-1300, AUXXL, AUXXR-1300, AUXXS-1300, AUXXT, CHH-70D, ECOMAX-402, ECOMAX-650, ECOMAX-700, EH-70, FE, FE-W, FX, GX, HX-30, HX-30E, HX-30ES, HX-30S, HX-40, HX-40E, HX-40ES, HX-40S, UX, UX-30, UX-30B, UX-30E, UX-30EB, UX-30EH, UX-30ES, UX-30ESB, UX-30H, UX-30-McDonalds, UX-30S, UX-30SB...(Other models you can see in the webshop)		

<p>metal</p>  <p>1</p>			
<b>GEV No.</b>	365139	<b>Ref. No.</b>	206002
<b>description</b>	operating capacitor capacity 10µF 450V tolerance 5% 60Hz ambient temperature max. -25 up to +70°C ø 40mm L 83mm M8 aluminium connection male faston 6.3mm C.87.8BF2 MKP protection		

<p>filters</p>			
<p>interference suppression filters</p>			
 <p>1</p>			
<b>GEV No.</b>	365044	<b>Ref. No.</b>	926144 E926144
<b>description</b>	interference suppression filter type FC701Y2F 250V 50-60Hz conductor 2 with E connection cable 200mm L 42mm ø 23mm Hmm Wmm plastic Qty 1 pcs		

 <p>1</p>			
<b>GEV No.</b>	365012	<b>Ref. No.</b>	206009
<b>description</b>	operating capacitor capacity 6.3µF 450V tolerance 5% 50Hz ambient temperature max. -25 to +85°C ø 30mm L 61mm M8 plastic connection male faston 6.3mm protection		

<p>fuses</p>			
<p>fine fuses</p>			
 <p>1</p>			
<b>GEV No.</b>	358666	<b>Ref. No.</b>	926283 E926283
<b>description</b>	fine fuse size ø5x20mm 0.315A fast-acting rated 250V Qty 10 pcs		

 <p>1</p>			
<b>GEV No.</b>	358530	<b>Ref. No.</b>	139321-902
<b>description</b>	fine fuse size ø5x20mm 0.8A fast-acting rated 250V Qty 10 pcs		
<b>For models:</b>	CHH-50, CHH-60D, EH-60		



<b>GEV No.</b>	358677	<b>Ref. No.</b>	139321-690 E228004
<b>description</b>	fine fuse size ø5x20mm 4A fast-acting rated 250V Qty 10 pcs		
<b>For models:</b>	CHH-50, CHH-60D, CHH-70D, EH-60, EH-70		

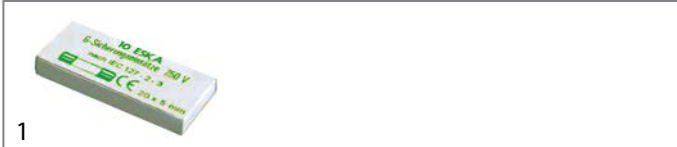

<b>GEV No.</b>	358594	<b>Ref. No.</b>	228012
<b>description</b>	fine fuse size ø5x20mm 0.16A slow-acting rated 250V Qty 10 pcs		



<b>GEV No.</b>	358606	<b>Ref. No.</b>	228010 E228010
<b>description</b>	fine fuse size ø5x20mm 4A slow-acting rated 250V Qty 10 pcs		



<b>GEV No.</b>	358752	<b>Ref. No.</b>	3090506
<b>description</b>	fine fuse size ø6.3x32mm 10A fast-acting rated 500V Qty 10 pcs		

## electric accessories

### terminals

#### connection terminals with screw/faston connections

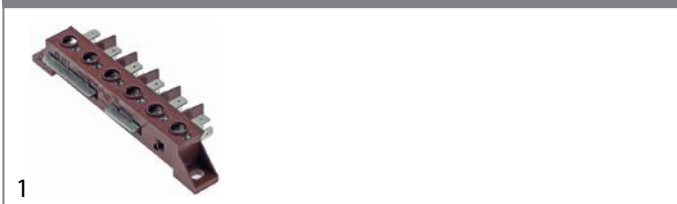

<b>GEV No.</b>	550411	<b>Ref. No.</b>	139321-582 774055-1
<b>description</b>	power terminal block 6-pole max. 40A max 450V connection ø6mm <sup>2</sup> / F6.3 temp.-resist. 150°C cross section 6mm <sup>2</sup>		
<b>For models:</b>	AMX-900, AMXS-900, AMXX-1300, AMXXT, AUXX-1300, AUXXT, CHF45, CHH-50, CHH-60D, CHH-70D, ECOMAX-650, EF-40, EH-60, EH-70, FE, FE-W, FX, GC, GC11, GC12, GC31, GC32, GC41, GC42, GX, HE, HE600-HL, HE-P, UX, UXL, UXLS, UXS, UXT, UXTH, UXTHL, UXTHLS, UXTHS, UXTL, UXTLS, UXTS		

## gas thermostats

### PEL

#### 25ST series



<b>GEV No.</b>	101172	<b>Ref. No.</b>	310137 T310137
----------------	--------	-----------------	-------------------

**description** gas thermostat PEL type 25ST 100-300°C gas inlet M16x1.5 (tube ø 10mm) bypass nozzle ø 0.35mm gas outlet M16x1.5 (tube ø 10/8mm) thermocouple connection M9x1 pilot connection M10x1 capillary pipe 1200mm probe ø 6mm shaft L 100mm shaft ø 8x6.5mm shaft L 21/15mm shaft flat upper

**spare parts for** 101172

	<b>GEV No.</b>	100259	<b>Ref. No.</b>	—
bypass nozzle type PEL22 bore ø 0.35mm thread M6x0.5				
	<b>GEV No.</b>	101060	<b>Ref. No.</b>	—
magnet unit standard L 39mm D1 ø 15.4mm D2 ø 11mm suitable for PEL20-21/JUNKERS/EGA				
	<b>GEV No.</b>	106200	<b>Ref. No.</b>	—
nut thread M9x1 suitable for PEL 24/25S				

**accessories for** 101172

	<b>GEV No.</b>	100908	<b>Ref. No.</b>	—
union screw thread M10x1 for pipe ø 4mm Qty 1 pcs				
	<b>GEV No.</b>	100909	<b>Ref. No.</b>	—
union screw thread M10x1 for pipe ø 6mm Qty 1 pcs				
	<b>GEV No.</b>	101246	<b>Ref. No.</b>	—
olive for pipe ø 4mm Qty 1 pcs				
	<b>GEV No.</b>	101278	<b>Ref. No.</b>	—
olive for pipe ø 10mm Qty 1 pcs				
	<b>GEV No.</b>	101286	<b>Ref. No.</b>	—
olive ID ø 6mm Qty 1 pcs				
	<b>GEV No.</b>	101300	<b>Ref. No.</b>	—
union nut thread M16x1.5 tube ø 10mm				
	<b>GEV No.</b>	101450	<b>Ref. No.</b>	—
olive for pipe ø 8mm L 12.7mm Qty 1 pcs ED ø 10mm				
	<b>GEV No.</b>	101451	<b>Ref. No.</b>	—
union nut thread M16x1.5 tube ø 8mm				
	<b>GEV No.</b>	110079	<b>Ref. No.</b>	—
knob dial plate gas thermostat 1-8 silver				
	<b>GEV No.</b>	110081	<b>Ref. No.</b>	—
knob ø 70mm shaft ø 8x6.5mm shaft flat universal				



## ignition parts

### electrodes



 <p>1</p>			
<b>GEV No.</b>	100906	<b>Ref. No.</b>	317980 T317980
<b>description</b>	screw connection thread M10x1 for ignition electrode brass Qty 1 pcs WS 10		

### ignition units

 <p>1</p>			
<b>GEV No.</b>	102388	<b>Ref. No.</b>	308488 T308488
<b>description</b>	ignition unit outputs 4 230VAC dimensions 111x23x34mm mounting distance 100mm inlet F6.3x0.8 outlet F2.8x0.8 type WAC-T4 0.6VA 50/60Hz		

### screw connections

#### olives

 <p>1</p>			
<b>GEV No.</b>	100898	<b>Ref. No.</b>	MRTCU800183
<b>description</b>	olive for pipe ø 6mm Qty 1 pcs for pilot burner		
<b>accessories for</b>	100898		
			
<b>GEV No.</b>	100909	<b>Ref. No.</b>	—
<b>description</b>	union screw thread M10x1 for pipe ø 6mm Qty 1 pcs		

 <p>1</p>			
<b>GEV No.</b>	101857	<b>Ref. No.</b>	310275 T310275
<b>description</b>	olive for pipe ø 6mm Qty 1 pcs suitable for 160 series for pilot burner		

### union screws

 <p>1</p>			
<b>GEV No.</b>	100906	<b>Ref. No.</b>	317980 T317980
<b>description</b>	screw connection thread M10x1 for ignition electrode brass Qty 1 pcs WS 10		

### brewing units

#### filter holder gaskets

#### O-rings

 <p>1</p>			
<b>GEV No.</b>	510409	<b>Ref. No.</b>	00-276903-053 00-67500-016 00-67500-118 276903-53 670500-118 67500-16
<b>description</b>	O-ring EPDM thickness 5.34mm ID ø 56.52mm Qty 1 pcs		
<b>For models:</b>	CR-F, CX, ECW, EWB-S, FTN, FTT, FTX, FUX, ML-104674, ML-104683, ML-104686, UW-135, UW-135H, UWX, UX-60, UX-60B, UX-60E, UX-60EB, UX-60EH, UX-60EHB, UX-60H, UX-60HB, UXT, UXTH, UXTHL, UXTHLS, UXTHS, UXTL, UXTLH, UXTLHS, UXTLS, UXTS, V1401		

### miscellaneous

 <p>1</p>			
<b>GEV No.</b>	698316	<b>Ref. No.</b>	491760
<b>description</b>	duct for glass plate D1 ø 10mm D2 ø 8mm rubber		
<b>For models:</b>	CO-0612E, CO-1012E, CS-0612E, CS-0612E-A, CS-1012E, CS-1012E-A, CS-1012G, CS-1022E, CS-1022E-A, CS-2012E, CS-2012E-A, CS-2012G, CS-2022E, CS-2022E-A, CSD-0612E, CSD-0612E-A, CSD-0612ET, CSD-0612-UC, CSD-1012E, CSD-1012E-A, CSD-1012ET, CSD-1012-UC, CSD-1013G, CSD-1022E, CSD-1022E-A, CSD-1022-UC, CSD-2012E, CSD-2012E-A, CSD-2012ET, CSD-2012-UC, CSD-2013G, CSD-2022E, CSD-2022E-A, CSD-2022-UC, CSL-0423E, CSL-0423EK, CSL-0523E, CSL-0523EK, CSL-06E, CSL-10E, CSL-423E, CSL-423K, CSM-0611IE, CSM-0611N, CSM-1011IE, CSM-1011N, CSM-1021IE, CSM-1021N, CSM-2011IE, CSM-2011N...(Other models you can see in the webshop)		

2 gas components



for dishwashers

drain and intake components

HOBART

drain /intake bodies



<b>GEV No.</b>	511677	<b>Ref. No.</b>	00-324053-000 00-886639-000
<b>description</b>	flange with gasket ED ø 107mm ID ø 70mm for pump		
<b>For models:</b>	CN-Protronic, CN-Smartronic, CP-Protronic, CR-F, CS-Easytronic, ECOMAX-402, ECOMAX-502, FE-W, FX, GC, GC11, GC12, GC31, GC32, GC41, GC42, GX, HX, HX-30, HX-30E, HX-30ES, HX-30S, HX-40, HX-40E, HX-40ES, HX-40S, HX-60-EHL, HX-E, HX-ES, HX-S		

overflow pipes



<b>GEV No.</b>	510409	<b>Ref. No.</b>	00-276903-053 00-67500-016 00-67500-118 276903-53 670500-118 67500-16
<b>description</b>	O-ring EPDM thickness 5.34mm ID ø 56.52mm Qty 1 pcs		
<b>For models:</b>	CR-F, CX, ECW, EWB-S, FTN, FTT, FTX, FUX, ML-104674, ML-104683, ML-104686, UW-135, UW-135H, UWX, UX-60, UX-60B, UX-60E, UX-60EB, UX-60EH, UX-60EHB, UX-60H, UX-60HB, UXT, UXTH, UXTHL, UXTHLS, UXTHS, UXTL, UXTLH, UXTLHS, UXTLS, UXTS, V1401		

housing and bezels

miscellaneous



<b>GEV No.</b>	513048	<b>Ref. No.</b>	00-886756-001 886756-1
<b>description</b>	duct ID ø 41mm ED ø 50mm		
<b>For models:</b>	AM-10, AM-11, AM-141, AM-700, AM900, AM900-10N, AM900-90, AMS900, AMS900-10N, AMX, AMX-10HL, AMX-90, AMX-900, AMX-E, AMX-ER, AMXR, AMX-R, AMXR-900, AMXS, AMXS-900, AMXT, AMXTS, AMXX, AMXX-1300, AMXXR, AMXXR-1300, AMXXS, AMXXS-1300, AMXXT, AUP, AUP-90, AUPS, AUX, AUX-E, AUX-ER, AUX-R, AUXX, AUXX-1300, AUXXL, AUXXL-11N, AUXXLS-11N, AUXXR, AUXXR-1300, AUXXS, AUXXS-1300, AUXXT, AUXXTS, CN-Protronic, CN-Smartronic, CS-Easytronic...(Other models you can see in the webshop)		

locks

miscellaneous



<b>GEV No.</b>	696420	<b>Ref. No.</b>	03811C
<b>description</b>	door catch with microswitch L 80mm W 46mm mounting distance 60mm		
<b>spare parts for</b>	696420		
	<b>GEV No.</b>	347567	<b>Ref. No.</b> —
momentary push switch mounting ø 12mm white 1NO 250V 4A connection male faston 6.3mm ambient temperature max. 85°C protection IP40			

gaskets

gaskets for heated units

door seals

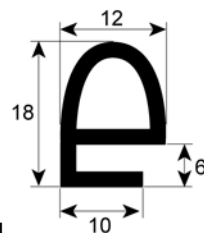

<b>GEV No.</b>	901417	<b>Ref. No.</b>	492439 845052
<b>description</b>	door seal profile 2215 L 2010mm suitable for HOBART Qty 1		
<b>For models:</b>	CO-0612E, CS-0612E, CS-0612E-A, CSD-0612E, CSD-0612E-A, CSD-0612-UC, CSL-06E, CSM-0611IE, CSM-0611N		

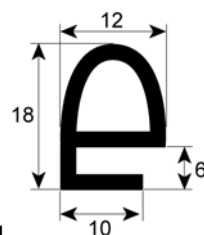

<b>GEV No.</b>	901366	<b>Ref. No.</b>	492466
<b>description</b>	door seal profile 2215 L 2530mm Qty 1 suitable for HOBART		
<b>For models:</b>	CO-1012E, CS-1012E, CS-1012E-A, CS-1012G, CS-1022E, CS-1022E-A, CSD-1012E, CSD-1012E-A, CSD-1012-UC, CSD-1013G, CSD-1022E, CSD-1022E-A, CSD-1022-UC, CSL-10E, CSM-1011IE, CSM-1011N, CSM-1021IE, CSM-1021N		





<b>GEV No.</b>	902444	<b>Ref. No.</b>	01-235313 1235313 162007
<b>description</b>	door seal profile 2510 W 670mm L 775mm external size		

<b>GEV No.</b>	518126	<b>Ref. No.</b>	492455
<b>description</b>	door seal profile 2980 L 2820mm		
<b>For models:</b>	CO-1012E, CS-1012E, CS-1012E-A, CS-1022E, CS-1022E-A, CSD-1012E, CSD-1012E-A, CSD-1013G, CSD-1022E, CSD-1022E-A, CSL-10E, CSM-1011IE, CSM-1011N, CSM-1021IE, CSM-1021N		

### O-rings

EPDM

ø3.00mm

<b>GEV No.</b>	510419	<b>Ref. No.</b>	00-276903-019 276903-19
<b>description</b>	O-ring EPDM thickness 3mm ID ø 150mm Qty 1 pcs		
<b>For models:</b>	FE-W, FX, GX, HX, HX-30, HX-30E, HX-30ES, HX-30S, HX-40, HX-40E, HX-40ES, HX-40S, HX-60-EHL, HX-E, HX-ES, HX-S		

ø5.34mm

<b>GEV No.</b>	510409	<b>Ref. No.</b>	00-276903-053 00-67500-016 00-67500-118 276903-53 670500-118 67500-16
<b>description</b>	O-ring EPDM thickness 5.34mm ID ø 56.52mm Qty 1 pcs		
<b>For models:</b>	CR-F, CX, ECW, EWB-S, FTN, FTT, FTX, FUX, ML-104674, ML-104683, ML-104686, UW-135, UW-135H, UWX, UX-60, UX-60B, UX-60E, UX-60EB, UX-60EH, UX-60EHB, UX-60H, UX-60HB, UXT, UXTH, UXTHL, UXTHLS, UXTHS, UXTL, UXTLH, UXTLHS, UXTLS, UXTS, V1401		

### shaft gaskets

#### miscellaneous

<b>GEV No.</b>	511605	<b>Ref. No.</b>	322190-1
<b>description</b>	shaft seal		
<b>For models:</b>	CO-0611E, CO-1011E, CO-2011E, CS-0611E, CS-0612E-A, CS-1011E, CS-1012E-A, CS-1022E-A, CS-2011E, CS-2012E-A, CS-2022E-A, CSD-0611E, CSD-0612E-A, CSD-0612ET, CSD-1011E, CSD-1012E-A, CSD-1012ET, CSD-1022E-A, CSD-2011E, CSD-2012E-A, CSD-2012ET, CSD-2022E-A		

### special gaskets

#### miscellaneous

<b>GEV No.</b>	511600	<b>Ref. No.</b>	844617
<b>description</b>	gasket ED ø 80mm		
<b>For models:</b>	CS-0612E, CS-0612E-A, CS-1012E, CS-1012E-A, CS-1012G, CS-1022E, CS-1022E-A, CS-2012E, CS-2012E-A, CS-2012G, CS-2022E, CS-2022E-A, CSD-0612E, CSD-0612E-A, CSD-1012E, CSD-1012E-A, CSD-1013G, CSD-1022E, CSD-1022E-A, CSD-2012E, CSD-2012E-A, CSD-2013G, CSD-2022E, CSD-2022E-A, CSL-06E, CSL-10E, CSM-0611IE, CSM-0611N, CSM-1011IE, CSM-1011N, CSM-1021IE, CSM-1021N, CSM-2011IE, CSM-2011N, CSM-2021IE, CSM-2021N		

## transmission technology and ball bearings

### ball bearings

#### deep-groove ball bearings 2RS

<b>GEV No.</b>	523511	<b>Ref. No.</b>	603273 BB-20-18
<b>description</b>	deep-groove ball bearing type 6203-2RS shaft ø 17mm ED ø 40mm W 12mm with sealing discs deep-groove ball bearing DIN 625-1		





## hoses

### supply hoses

#### PVC supply hoses



1

<b>GEV No.</b>	520010	<b>Ref. No.</b>	E143170
<b>description</b>	supply hose PVC straight-curved DN13 connections 3/4" L 1500mm operating p. 10bar burst p. 32bar t.max. 90°C blue approval VDE flat seal		
<b>accessories for</b>	520010		
	<b>GEV No.</b>	520053	<b>Ref. No.</b> —
	screen connection 3/4" D1 ø 26mm D2 ø 15mm Qty 10 pcs rubber thickness 8mm		
	<b>GEV No.</b>	520054	<b>Ref. No.</b> —
	flat gasket rubber ED ø 23.5mm ID ø 14mm thickness 2.3mm Qty 10 pcs		



1

<b>GEV No.</b>	520011	<b>Ref. No.</b>	139321-1030 139321-1034
<b>description</b>	supply hose PVC straight-curved DN13 connections 3/4" L 2000mm operating p. 10bar burst p. 32bar t.max. 90°C approval VDE flat seal		

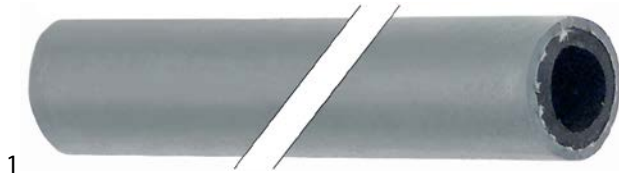

1

<b>GEV No.</b>	520015	<b>Ref. No.</b>	00-775559-007 00-775559-008 00-775559-013 00-775559-016 139321-125 139321-611 775559-13 775559-16 775559-7 775559-8
<b>description</b>	supply hose ID ø 10mm ED ø 17mm L 5m operating p. 20bar burst p. 60bar t.max. 95°C grey Qty 5m		
<b>For models:</b>	AM-10, AM-11, AM-141, AM-700, AM900, AM900-10N, AM900-90, AMS900, AMS900-10N, AMX, AMX-10HL, AMX-90, AMX-900, AMXR, AMXR-900, AMXS, AMXS-900, AMXT, AMXTS, AMXX, AMXX-1300, AMXXR, AMXXR-1300, AMXXS, AMXXS-1300, AMXXT, AUP, AUP-90, AUPS, AUXX, AUXX-1300, AUXXL, AUXXL-11N, AUXXLS-11N, AUXXR, AUXXR-1300, AUXXS, AUXXS-1300, AUXXT, AUXXTS, CHF45, CHH-70D, ECOMAX-600, ECOMAX-602-10, ECOMAX-602-11, ECOMAX-602S-11, ECOMAX-612-10, ECOMAX-612S-10, EF-40, EH-70...(Other models you can see in the webshop)		
<b>accessories for</b>	520015		
	<b>GEV No.</b>	504377	<b>Ref. No.</b> 01-240159-001 01-240159-1
	hose connector grommet ø 23mm grommet length 25mm total length 55mm for water filling		

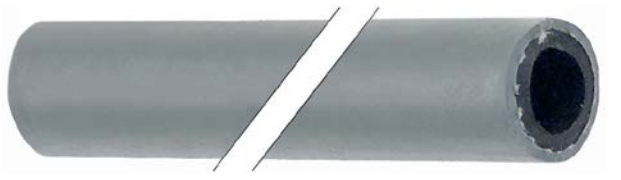
	<b>GEV No.</b>	520016	<b>Ref. No.</b>	143010
<b>description</b>	supply hose ID ø 13mm ED ø 20mm L 40m operating p. 20bar burst p. 60bar t.max. 95°C grey Qty 40m			

## industrial hoses

### PVC hoses

#### PVC hoses without fabric



1

<b>GEV No.</b>	520029	<b>Ref. No.</b>	00-165168-001
<b>description</b>	PVC hose ID ø 6mm ED ø 9mm L 10m thickness 1.5mm t.max. 60°C transparent		

## water cycle components

### supply filters



1

<b>GEV No.</b>	520261	<b>Ref. No.</b>	E927078
<b>description</b>	supply filter thread 1/2" IT - 1/2" IT total length 58mm red brass mesh opening 0.4mm		

## ancillary products

### clamps

#### hose clamps

#### DIN 3017 - W2



1

<b>GEV No.</b>	520114	<b>Ref. No.</b>	423008
<b>description</b>	hose clamp ø 20-32mm width 9mm Qty 10 pcs DIN 3017		



## fastening material

### screws

#### hexagonal screws



1			
<b>GEV No.</b>	550528	<b>Ref. No.</b>	00-609782-000
<b>description</b>	safety screw thread M5 WS 8 Qty 10 pcs L 8mm head ø 11mm		
<b>For models:</b>	AM-10, AM-11, AM-141, AM900-10N, AM900-90, AMS900-10N, AMX, AMX-10HL, AMX-90, AMXR, AMXS, AMXT, AMXTS, AMXX, AMXXR, AMXXS, AUP, AUP-90, AUPS, AUXX, AUXXL-11N, AUXXLS-11N, AUXXR, AUXXS, AUXXT, AUXXTS, ECOMAX-602-10, ECOMAX-602-11, ECOMAX-602S-11, ECOMAX-612-10, ECOMAX-612S-10		

### grub screws

#### DIN 913/ISO 4026



1			
<b>GEV No.</b>	504733	<b>Ref. No.</b>	VA-261-1
<b>description</b>	grub screw thread M4 L 5mm stainless steel DIN 913 intake internal hexagon WS 2 Qty 1 pcs		

### washers

#### washers

#### miscellaneous



1			
<b>GEV No.</b>	524117	<b>Ref. No.</b>	602286
<b>description</b>	plain washer ID ø 6.4mm ED ø 12mm thickness 1.6mm SS Qty 1 pcs		

### fasteners

#### clamps

#### hose clamps

#### DIN 3017 - W2



1			
<b>GEV No.</b>	520114	<b>Ref. No.</b>	423008
<b>description</b>	hose clamp ø 20-32mm width 9mm Qty 10 pcs DIN 3017		

## consumables

### fuses

#### fine fuses



1			
<b>GEV No.</b>	358666	<b>Ref. No.</b>	926283 E926283
<b>description</b>	fine fuse size ø5x20mm 0.315A fast-acting rated 250V Qty 10 pcs		



1			
<b>GEV No.</b>	358530	<b>Ref. No.</b>	139321-902
<b>description</b>	fine fuse size ø5x20mm 0.8A fast-acting rated 250V Qty 10 pcs		
<b>For models:</b>	CHH-50, CHH-60D, EH-60		



1			
<b>GEV No.</b>	358677	<b>Ref. No.</b>	139321-690 E228004
<b>description</b>	fine fuse size ø5x20mm 4A fast-acting rated 250V Qty 10 pcs		
<b>For models:</b>	CHH-50, CHH-60D, CHH-70D, EH-60, EH-70		



1			
<b>GEV No.</b>	358594	<b>Ref. No.</b>	228012
<b>description</b>	fine fuse size ø5x20mm 0.16A slow-acting rated 250V Qty 10 pcs		



1			
<b>GEV No.</b>	358606	<b>Ref. No.</b>	228010 E228010
<b>description</b>	fine fuse size ø5x20mm 4A slow-acting rated 250V Qty 10 pcs		

#### ø6.3x32mm 500V



1			
<b>GEV No.</b>	358752	<b>Ref. No.</b>	3090506
<b>description</b>	fine fuse size ø6.3x32mm 10A fast-acting rated 500V Qty 10 pcs		



<b>A</b>		
alarm devices	6	
axial fans	10	
<b>B</b>		
bi-metal thermostats	3, 3	
booster pumps II	12	
<b>C</b>		
cam switches	5	
clamps	18, 19	
condensators & interference suppression filters	12	
consumables	19	
contactors	6	
control thermostats	4	
<b>D</b>		
door seals	16	
drain pumps	11	
<b>E</b>		
electric accessories	14	
electronic controllers	8	
energy regulators	3	
<b>F</b>		
fans	10	
fasteners	19	
fastening material	19	
filters	13	
fine fuses	19	
fluorescent lamps	6, 6	
fuses	13, 19	
<b>G</b>		
gas thermostats	14	
gaskets for heated units	16	
grub screws	19	
<b>H</b>		
halogen lamp	6	
heating elements	2	
heating elements for convection	2	
hexagonal screws	19	
hose clamps	18, 19	
hoses	18	
hot air fans	11	
hot air motors	11	
<b>I</b>		
ignition units	15	
immersion heating elements	2	
indicator lights	6	
industrial hoses	18	
<b>L</b>		
lamps	6	
<b>M</b>		
magnetic switches	5	
<b>O</b>		
operating capacitors	12	
O-rings	17	
oven lamps	6	
<b>P</b>		
pumps	11	
PVC hoses	18	
PVC supply hoses	18	
<b>R</b>		
relays	7	
rocker/momentary rocker switches	5	
<b>S</b>		
safety thermostats	4	
screws	19	
shaft gaskets	17	
solenoid valves	8	
supply filters	18, 18	
supply hoses	18	
switches and momentary switches	5	
system switches (ROLD)	5	
<b>T</b>		
terminals	14	
thermostats	3	
<b>W</b>		
washers	19	
water cycle components	18	