



# Spare Parts for Combi Ovens



Spare parts suitable for

# CONVOTHERM

# 2018

Find the complete and up-to-date range of products in our GEV Webshop



# heating elements

## immersion heating elements

### 3 hole flange ø47.5mm

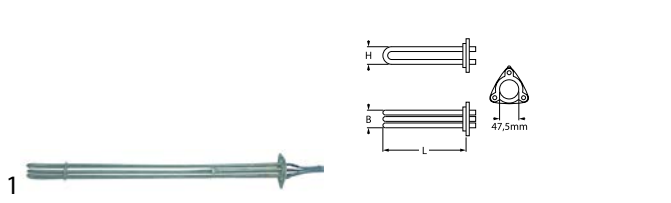

<b>GEV No.</b>	415931	<b>Ref. No.</b>	5007076 5007076K
<b>description</b>	heating element 12000W 220V mounting ø 47.5mm heating circuits 3 L 585mm W 28mm H 28mm number of thermostat sleeves 1 thermostat sleeves ø 6.5mm length thermostat sleeves 170mm thermostat sleeve clinging tube ø 6.3mm hole distance 63mm hole ø 8mm cable length 950mm 3 hole flange immersion heater		
<b>For models:</b>	OD20.20, OS20.20, OSC20.20, OSP20.20		
<b>accessories for</b>	415931		
	<b>GEV No.</b>	510408	<b>Ref. No.</b> 6005015
	O-ring EPDM thickness 5.34mm ID ø 47mm Qty 1 pcs		
	<b>GEV No.</b>	510562	<b>Ref. No.</b> —
	O-ring silicone thickness 5.34mm ID ø 47mm Qty 1 pcs		

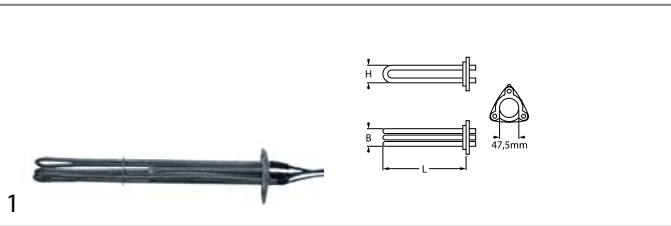

<b>GEV No.</b>	415803	<b>Ref. No.</b>	5007062 5007062K
<b>description</b>	heating element 6000W 230V mounting ø 47.5mm heating circuits 3 L 325mm W 26mm H 38mm number of thermostat sleeves 1 thermostat sleeves ø 6mm length thermostat sleeves 160mm thermostat sleeve clinging tube ø 6.3mm hole distance 62mm hole ø 8mm cable length 790mm connection cable 3 hole flange immersion heater		
<b>For models:</b>	OD10.10, OD10.20, OS10.10, OS10.20, OSC10.10, OSC10.20, OSP10.10, OSP10.20		
<b>spare parts for</b>	415803		
	<b>GEV No.</b>	510408	<b>Ref. No.</b> 6005015
	O-ring EPDM thickness 5.34mm ID ø 47mm Qty 1 pcs		
<b>accessories for</b>	415803		
	<b>GEV No.</b>	510562	<b>Ref. No.</b> —
	O-ring silicone thickness 5.34mm ID ø 47mm Qty 1 pcs		

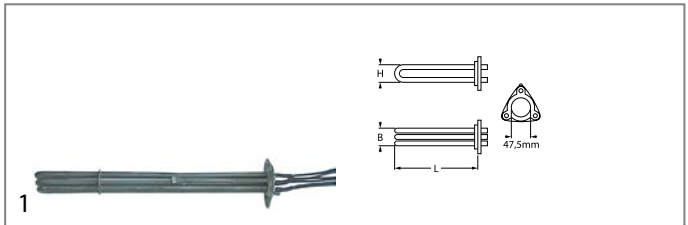

<b>GEV No.</b>	415802	<b>Ref. No.</b>	5007071 5007071K 5030632
<b>description</b>	heating element 9000W 230V mounting ø 47.5mm heating circuits 3 L 385mm W 35mm H 46mm number of thermostat sleeves 1 thermostat sleeves ø 6mm length thermostat sleeves 160mm thermostat sleeve clinging tube ø 8.5mm hole distance 62mm hole ø 8mm cable length 800mm 3 hole flange immersion heater		
<b>For models:</b>	OD10.10, OD10.20, OD12.20, OD20.10, OD20.20, OD6.10, OS10.10, OS10.20, OS12.20, OS20.10, OS6.10, OSC10.10, OSC10.20, OSC12.20, OSC20.10, OSC6.10, OSP10.10, OSP10.20, OSP12.20, OSP20.10, OSP6.10		
<b>accessories for</b>	415802		
	<b>GEV No.</b>	510562	<b>Ref. No.</b> —
	O-ring silicone thickness 5.34mm ID ø 47mm Qty 1 pcs		

### miscellaneous



<b>GEV No.</b>	420042	<b>Ref. No.</b>	2619180 5017003
<b>description</b>	heating element 13200W 230V heating circuits 3 L 545mm W 65mm H 33mm number of thermostat sleeves 1 thermostat sleeves ø 8mm length thermostat sleeves 160mm tube ø 8.5mm hole distance 71mm hole ø 7mm cable length 1000mm flange connection immersion heater flange width 57mm flange length 88mm		
<b>For models:</b>	OEB20.20, OES20.20		





<b>GEV No.</b>	417733	<b>Ref. No.</b>	5056321
<b>description</b>	heating element 13300W 230V heating circuits 3 L 275mm W 35mm H 70mm number of thermostat sleeves 2 thermostat sleeves ø 3.5/8mm length thermostat sleeves 120/140mm thermostat sleeve eccentric, clinging tube ø 8.5mm hole distance 67mm hole ø 8mm combi-steamer flange width 82mm flange length 82mm with gasket and nut		







<b>GEV No.</b>	420043	<b>Ref. No.</b>	2619178 5017001
<b>description</b>	heating element 6600W 230V heating circuits 3 L 275mm W 65mm H 37mm number of thermostat sleeves 1 thermostat sleeves ø 7.8mm length thermostat sleeves 150mm tube ø 8.5mm hole distance 71mm hole ø 7mm cable length 1050mm flange connection immersion heater flange width 57mm flange length 88mm		
<b>For models:</b>	OEB10.10, OEB10.20, OEB6.20, OES10.10, OES10.20, OES6.20		
<b>accessories for</b>	420043		
	<b>GEV No.</b>	550992	<b>Ref. No.</b> 6015023
	gasket L 87mm W 57mm hole ø 6mm hole distance 70/40mm 4 holes thickness 3mm suitable for CONVOTHERM		















			
1			
<b>GEV No.</b>	417601	<b>Ref. No.</b>	2619187 5017012
<b>description</b>	heating element 6600W 230V heating circuits 3 L 275mm W 70mm H 25mm hole distance 40x70mm hole ø 6.5mm cable length 1050mm tube ø 8.5mm flange length 87mm flange width 56mm thermostat sleeves ø 6mm number of thermostat sleeves 1 length thermostat sleeves 170mm		
<b>For models:</b>	OEB10.10, OEB10.20, OEB6.20, OES10.10, OES10.20, OES6.20		
<b>accessories for</b>	417601		
		<b>GEV No.</b>	550992 <b>Ref. No.</b> 6015023
	gasket L 87mm W 57mm hole ø 6mm hole distance 70/40mm 4 holes thickness 3mm suitable for CONVOTHERM		

			
1			
<b>GEV No.</b>	417734	<b>Ref. No.</b>	5056320
<b>description</b>	heating element 9000W 230V heating circuits 3 L 210mm W 40mm H 70mm number of thermostat sleeves 2 thermostat sleeves ø 3.5/8mm length thermostat sleeves 119/139mm thermostat sleeve eccentric, clinging tube ø 8.5mm hole distance 67mm hole ø 8mm flange combi-steamer flange width 82mm flange length 82mm		

			
1			
<b>GEV No.</b>	417719	<b>Ref. No.</b>	2619188 5017013
<b>description</b>	heating element 9900W 230V heating circuits 3 L 415mm W 52mm H 37mm number of thermostat sleeves 1 thermostat sleeves ø 7.5mm length thermostat sleeves 160mm thermostat sleeve eccentric, clinging tube ø 8.5mm hole distance 71mm hole ø 7mm 4 hole flange immersion heater flange width 57mm flange length 88mm		
<b>For models:</b>	OEB10.10, OEB10.20, OEB12.20, OEB20.10, OEB20.20, OEB6.10, OEB6.20, OES10.10, OES10.20, OES12.20, OES20.10, OES6.10, OES6.20		
<b>accessories for</b>	417719		
		<b>GEV No.</b>	550992 <b>Ref. No.</b> 6015023
	gasket L 87mm W 57mm hole ø 6mm hole distance 70/40mm 4 holes thickness 3mm suitable for CONVOTHERM		



			
1			
<b>GEV No.</b>	418685	<b>Ref. No.</b>	2619179 5017002
<b>description</b>	heating element 9900W 230V heating circuits 3 L 415mm W 65mm H 37mm number of thermostat sleeves 1 thermostat sleeves ø 6.5mm length thermostat sleeves 160mm tube ø 8.5mm hole distance 72mm hole ø 7mm flange width 58mm flange length 88mm		
<b>For models:</b>	OEB10.10, OEB10.20, OEB12.20, OEB20.10, OEB6.10, OEB6.20, OES10.10, OES10.20, OES12.20, OES20.10, OES6.10, OES6.20		
<b>accessories for</b>	418685		
		<b>GEV No.</b>	550992 <b>Ref. No.</b> 6015023
	gasket L 87mm W 57mm hole ø 6mm hole distance 70/40mm 4 holes thickness 3mm suitable for CONVOTHERM		

<p>1½"</p> 			
1			
<b>GEV No.</b>	415874	<b>Ref. No.</b>	5007067 5007068 5007068K 5030631
<b>description</b>	heating element 12000/14300W 220/240V heating circuits 3 thread 1½" L 585mm W 40mm H 30mm thermostat sleeves ø 6.5mm length thermostat sleeves 160mm thermostat sleeve eccentric, clinging tube ø 6.3mm cable length 750mm connection cable immersion heater flange with thread hole distance 63mm mounting ø 47.5mm hole ø 8/10mm number of thermostat sleeves 1		
<b>For models:</b>	HUD20.20		
<b>spare parts for</b>	415874		
		<b>GEV No.</b>	510406 <b>Ref. No.</b> 6005065
	flat gasket fibre ED ø 60mm ID ø 48mm thickness 3mm for thread 1½" Qty 1 pcs		
<b>accessories for</b>	415874		
		<b>GEV No.</b>	510424 <b>Ref. No.</b> —
	gasket copper ED ø 55mm ID ø 48mm thickness 2.2mm Centellen for thread 1½"		
		<b>GEV No.</b>	520211 <b>Ref. No.</b> —
	reducer thread 2" ET - 1½" IT brass		
		<b>GEV No.</b>	520212 <b>Ref. No.</b> —
	hexagonal nut thread 1½" brass WS 60 H 8mm		
		<b>GEV No.</b>	550361 <b>Ref. No.</b> —
	blind flange ø 58mm thread 1½"		

			
1			
<b>GEV No.</b>	415500	<b>Ref. No.</b>	5007061 5007061K 5007063 5007063K 5030629
<b>description</b>	heating element 7500W 220V heating circuits 3 thread 1½" L 435mm W 33mm H 25mm tube ø 6.3mm cable length 780mm immersion heater flange with thread		
<b>For models:</b>	HUD10.10		
<b>accessories for</b>	415500		
		<b>GEV No.</b>	510406 <b>Ref. No.</b> 6005065
	flat gasket fibre ED ø 60mm ID ø 48mm thickness 3mm for thread 1½" Qty 1 pcs		
		<b>GEV No.</b>	510424 <b>Ref. No.</b> —
	gasket copper ED ø 55mm ID ø 48mm thickness 2.2mm Centellen for thread 1½"		
		<b>GEV No.</b>	520211 <b>Ref. No.</b> —
	reducer thread 2" ET - 1½" IT brass		
		<b>GEV No.</b>	520212 <b>Ref. No.</b> —
	hexagonal nut thread 1½" brass WS 60 H 8mm		
		<b>GEV No.</b>	550361 <b>Ref. No.</b> —
	blind flange ø 58mm thread 1½"		

			
1			
<b>GEV No.</b>	415501	<b>Ref. No.</b>	5007066 5007066K 5030630
<b>description</b>	heating element 9000W 230V heating circuits 3 thread 1½" L 430mm W 32mm H 26mm tube ø 6.3mm cable length 820mm connection cable immersion heater flange with thread		
<b>For models:</b>	HUD10.10, HUD12.20, HUD20.10, HUD6.10, OD10.10, OD10.20, OD12.20, OD20.10, OD20.20, OD6.10		
<b>accessories for</b>	415501		
	GEV No. 510406	Ref. No.	6005065
	flat gasket fibre ED ø 60mm ID ø 48mm thickness 3mm for thread 1½" Qty 1 pcs		
	GEV No. 510424	Ref. No.	—
	gasket copper ED ø 55mm ID ø 48mm thickness 2.2mm Centellen for thread 1½"		
	GEV No. 520211	Ref. No.	—
	reducer thread 2" ET - 1½" IT brass		
	GEV No. 520212	Ref. No.	—
	hexagonal nut thread 1½" brass WS 60 H 8mm		
	GEV No. 550361	Ref. No.	—
	blind flange ø 58mm thread 1½"		

heating elements for convection

			
1			
<b>GEV No.</b>	420524	<b>Ref. No.</b>	2625104K 2630606
<b>description</b>	heating element 10200W 230V heating circuits 3 ID ø 250mm ED ø 320mm L 350mm H 58mm L1 70mm H1 8mm H2 58mm flange length 90mm flange width 70mm tube ø 8.5mm threaded		
<b>spare parts for</b>	420524		
	GEV No. 521013	Ref. No.	2623226 6015025
	gasket set suitable for CONVOTHERM for heating element L 90mm W 71mm Qty 1m graphite hole distance 54/74mm		

			
1			
<b>GEV No.</b>	420558	<b>Ref. No.</b>	5056330
<b>description</b>	heating element 10500W 230V heating circuits 3 ID ø 400mm ED ø 417mm L 472mm H 100mm H1 15mm H2 83mm flange length 90mm flange width 70mm hole distance 55mm connection M5 tube ø 8.5mm cable length 180mm convection heating element flange for combi-steamer series CONVOTHERM 4		

			
1			
<b>GEV No.</b>	418684	<b>Ref. No.</b>	2619192 5017005 5017018
<b>description</b>	heating element 10500W 230V heating circuits 3 ID ø 402mm ED ø 420mm L 475mm H 100mm L1 55mm W1 29mm H1 25mm H2 75mm flange length 90mm flange width 70mm hole distance 74mm connection M5 tube ø 8.5mm convection heating element mounting thread M5 rectangular flange with bolt		
<b>For models:</b>	OEB6.10, OES6.10		

			
1			
<b>GEV No.</b>	417718	<b>Ref. No.</b>	5007035 5007035K 5030625
<b>description</b>	heating element 12000W 220V heating circuits 3 ID ø 387mm ED ø 400mm L 430mm H 90mm H1 23mm H2 67mm thread M14 3 hole fixing connection male faston tube ø 6.5mm mounting pos. outer for combi-steamer		
<b>For models:</b>	AR100, AR108, AR28, AR30, AR40, AR50, AR54, HUD10.10, HUD20.10, OD6.10, OSC6.10, OSP10.10, OSP6.10, UG6.10		

			
1			
<b>GEV No.</b>	415385	<b>Ref. No.</b>	5007036 5007036K 5030626
<b>description</b>	heating element 15000W 220V heating circuits 3 ID ø 390mm ED ø 405mm L 435mm H 110mm L1 22mm W1 300mm H1 22mm H2 84mm thread M14x1.5 6 hole fixing connection M5 tube ø 8.5mm convection heating element		
<b>For models:</b>	OD10.10, OD20.10, OS10.10, OS20.10, OSC10.10, OSC20.10, OSP10.10, OSP20.10		
<b>accessories for</b>	415385		
	GEV No. 361182	Ref. No.	—
	nut thread 1/4" H 5mm nickel-plated brass WS 17 Qty 1 pcs		
	GEV No. 510417	Ref. No.	—
	flat gasket fibre ED ø 20mm ID ø 14mm thickness 2mm Qty 1 pcs		
	GEV No. 520228	Ref. No.	—
	tooth lock washer ID ø 15.3mm ED ø 24mm steel Qty 1 pcs for thread M14		

Table continues overleaf



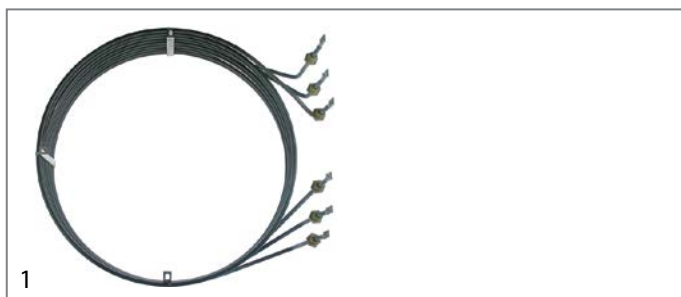

<b>accessories for</b> 415385			
	<b>GEV No.</b> 550262	<b>Ref. No.</b>	—
flat gasket copper ED ø 20mm ID ø 14mm thickness 2mm			



<b>GEV No.</b>	418886	<b>Ref. No.</b>	5007038 5007038K 5007042K
<b>description</b>	heating element 18000W 380V heating circuits 3 ID ø 380mm ED ø 393mm L 435mm H 120mm L1 50mm H1 15mm thread M14x1.5 screw mounting tube ø 6.5mm convection heating element		
<b>For models:</b>	AR72, HUD10.10, HUD20.10, UG10.10, UG20.10		



<b>GEV No.</b>	418768	<b>Ref. No.</b>	2619181 5017004
<b>description</b>	heating element 18900W 230V heating circuits 3 ID ø 467mm ED ø 484mm L 545mm H 99mm L1 6mm W1 28mm H1 14mm H2 85mm flange length 90mm flange width 70mm connection M4 connection length 112mm tube ø 8.5mm convection heating element with counterflange and cable		
<b>For models:</b>	OEB10.10, OEB20.10, OEB6.20, OES10.10, OES20.10, OES6.20		
<b>spare parts for</b>	418768		
	<b>GEV No.</b> 521013	<b>Ref. No.</b>	2623226 6015025
gasket set suitable for CONVOTHERM for heating element L 90mm W 71mm Qty 1m graphite hole distance 54/74mm			
	<b>GEV No.</b> 692931	<b>Ref. No.</b>	2623218
connection set with fixing kit suitable for CONVOTHERM for heating element			





<b>GEV No.</b>	418876	<b>Ref. No.</b>	2619190 5017016
<b>description</b>	heating element 18900W 230V heating circuits 3 ID ø 470mm ED ø 486mm L 540mm H 100mm L1 48mm H1 27mm H2 73mm flange length 90mm flange width 70mm hole distance 55mm connection M5 connection length 115mm tube ø 8.5mm convection heating element		
<b>For models:</b>	OEB10.10, OEB20.10, OEB6.20, OES10.10, OES20.10, OES6.20		

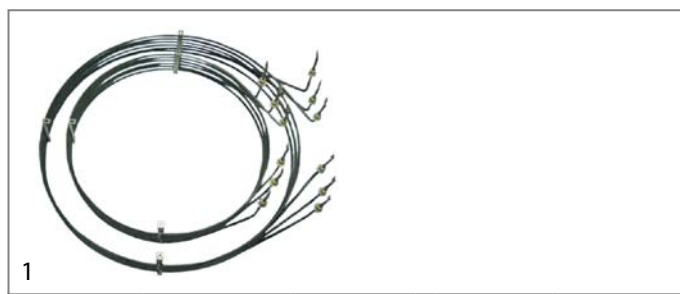

<b>GEV No.</b>	420557	<b>Ref. No.</b>	5056331
<b>description</b>	heating element 18900W 230V heating circuits 3 ID ø 470mm ED ø 487mm L 540mm H 100mm H1 16mm H2 83mm flange length 90mm flange width 70mm hole distance 55mm connection M5 tube ø 8.5mm cable length 1300mm convection heating element flange connection for combi-steamer series CONVOTHERM 4		



<b>GEV No.</b>	415386	<b>Ref. No.</b>	5007043 5007043K
<b>description</b>	heating element 24000W 220V thread M14x1.5 12 hole fixing		
<b>For models:</b>	OD10.20, OS10.20, OSC10.20, OSP10.20		

<b>spare parts for</b> 415386			
	<b>GEV No.</b> 416027	<b>Ref. No.</b>	—
heating element 12000W 230V heating circuits 3 ID ø 438mm ED ø 450mm L 480mm H 100mm L1 30mm W1 330mm H1 35mm H2 65mm thread M14x1.5 6 hole fixing connection M5 tube ø 6.5mm mounting pos. inner convection heating element			
	<b>GEV No.</b> 416028	<b>Ref. No.</b>	—
heating element 12000W 220V heating circuits 3 ID ø 558mm ED ø 572mm L 610mm H 85mm L1 38mm H1 20mm H2 65mm thread M14x1.5 6 hole fixing connection M5 tube ø 8.5mm mounting pos. outer convection heating element			

<b>accessories for</b> 415386			
	<b>GEV No.</b> 510417	<b>Ref. No.</b>	—
flat gasket fibre ED ø 20mm ID ø 14mm thickness 2mm Qty 1 pcs			
	<b>GEV No.</b> 520228	<b>Ref. No.</b>	—
tooth lock washer ID ø 15.3mm ED ø 24mm steel Qty 1 pcs for thread M14			
	<b>GEV No.</b> 520230	<b>Ref. No.</b>	—
nut thread M14x1.5 H 5mm WS 19 zinc-coated steel Qty 1 pcs			
	<b>GEV No.</b> 521101	<b>Ref. No.</b>	—
nut thread M14x1.5 H 5mm WS 19 SS Qty 1 pcs			
	<b>GEV No.</b> 550262	<b>Ref. No.</b>	—
flat gasket copper ED ø 20mm ID ø 14mm thickness 2mm			





1

<b>GEV No.</b>	420559	<b>Ref. No.</b>	5056332
<b>description</b>	heating element 2x16500W 230V heating circuits 6 ID ø 485mm ED ø 570mm L 590mm H 134mm H1 22mm H2 108mm flange length 175mm flange width 105mm hole distance 80mm connection length M5mm tube ø 8.5mm cable length 1500mm convection heating element flange for combi-steamer series CONVOTHERM		



1

<b>GEV No.</b>	415129	<b>Ref. No.</b>	5007044 5007044K 5030627
<b>description</b>	heating element 30000W		
<b>For models:</b>	HUD12.20, HUD20.20, OD12.20, OD20.10, OD20.20, OS12.20, OS20.20, OSC12.20, OSC20.20, OSP12.20, OSP20.20		
<b>spare parts for</b>	415129		
	<b>GEV No.</b>	<b>Ref. No.</b>	—
			
	<b>GEV No.</b>	<b>Ref. No.</b>	—
			



1

<b>GEV No.</b>	419102	<b>Ref. No.</b>	2619177 5017000
<b>description</b>	heating element 33000W 230/400V heating circuits 6 ID ø 480mm ED ø 570mm L 590mm H 140mm flange length 175mm flange width 105mm		
<b>For models:</b>	OEB10.20, OEB12.20, OEB20.20, OES10.20, OES12.20, OES20.20		





1

<b>GEV No.</b>	419233	<b>Ref. No.</b>	2618805
<b>description</b>	heating element 5400W 230V heating circuits 2 ID ø 252mm ED ø 269mm L 297mm H 62mm L1 11mm W1 65mm H1 12mm H2 50mm flange length 100mm flange width 22mm hole distance 87mm connection 6.3x0.8 tube ø 8.5mm for combi-steamer mounting thread M5 with mounting accessories OES6.06 Mini P3		
<b>For models:</b>	OES6.06		



1

<b>GEV No.</b>	420156	<b>Ref. No.</b>	2123634 2625181 5017084
<b>description</b>	heating element 6800W 230V heating circuits 2 ID ø 250mm ED ø 265mm L 300mm H 65mm L1 38mm H1 7mm H2 56mm flange length 90mm flange width 70mm connection male faston 6.3mm connection length 77mm tube ø 8.5mm convection heating element flange connection		
<b>spare parts for</b>	420156		
	<b>GEV No.</b>	<b>Ref. No.</b>	2623226 6015025
			



1







<b>GEV No.</b>	415384	<b>Ref. No.</b>	5007033 5007033K
<b>description</b>	heating element 9000W 230V heating circuits 3 ID ø 390mm ED ø 403mm L 440mm H 88mm L1 30mm W1 300mm H1 18mm H2 70mm thread M14x1.5 6 hole fixing connection M5 convection heating element		
<b>For models:</b>	AR28, AR40, OD10.10, OD10.20, OD6.10, OS6.10, OSC6.10, OSP6.10		
<b>spare parts for</b>	415384		
	<b>GEV No.</b>	<b>Ref. No.</b>	—
			
<b>accessories for</b>	415384		
	<b>GEV No.</b>	<b>Ref. No.</b>	—
			

Table continues overleaf



<b>accessories for</b> 415384	
	GEV No. 520230 Ref. No. — nut thread M14x1.5 H 5mm WS 19 zinc-coated steel Qty 1 pcs
	GEV No. 521101 Ref. No. — nut thread M14x1.5 H 5mm WS 19 SS Qty 1 pcs
	GEV No. 550262 Ref. No. — flat gasket copper ED ø 20mm ID ø 14mm thickness 2mm

	
<b>GEV No.</b>	420075 <b>Ref. No.</b> 5007022
<b>description</b>	mounting set suitable for convection heating element
<b>For models:</b>	AR100, AR108, AR28, AR30, AR40, AR50, AR54, AR72, HUD10.10, HUD20.10, HUD6.10, OD10.10, OD20.10, OD6.10, OS10.10, OS6.10, OSC10.10, OSC6.10, OSP10.10, OSP6.10, UG10.10, UG20.10, UG6.10

	
<b>GEV No.</b>	692737 <b>Ref. No.</b> 2623227 6015024
<b>description</b>	mounting set suitable for for combi-steamer L 175mm W 105mm mounting pos. CONVOTHERM
<b>For models:</b>	OEB10.20, OEB12.20, OEB20.20, OES10.20, OES12.20, OES20.20

## accessories

### sealing washers

### fibre gaskets

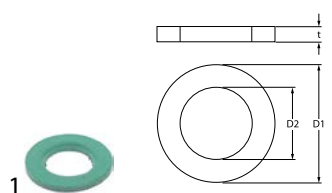
	
<b>GEV No.</b>	510416 <b>Ref. No.</b> 6005016
<b>description</b>	flat gasket fibre ED ø 19mm ID ø 10.5mm thickness 1.5mm for thread M10 Qty 1 pcs
<b>For models:</b>	OD10.10, OD10.20, OD12.20, OD20.10, OD20.20, OD6.10, OEB10.10, OEB10.20, OEB12.20, OEB20.10, OEB20.20, OEB6.10, OEB6.20, OES10.10, OES10.20, OES12.20, OES20.10, OES20.20, OES6.10, OES6.20, OGB10.10, OGB10.20, OGB12.20, OGB20.10, OGB20.20, OGB6.10, OGB6.20, OGS10.10, OGS10.20, OGS12.20, OGS20.10, OGS20.20, OGS6.10, OGS6.20, OS10.10, OS10.20, OS12.20, OS20.10, OS20.20, OS6.10, OSP10.10, OSP10.20, OSP12.20, OSP20.10, OSP20.20, OSP6.10

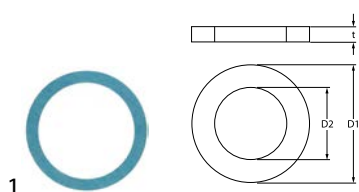
	
<b>GEV No.</b>	510406 <b>Ref. No.</b> 6005065
<b>description</b>	flat gasket fibre ED ø 60mm ID ø 48mm thickness 3mm for thread 1½" Qty 1 pcs
<b>For models:</b>	HUD10.10, HUD12.20, HUD20.10, HUD20.20, HUD6.10, OD10.10, OD10.20, OD12.20, OD20.10, OD20.20, OD6.10

### O-rings

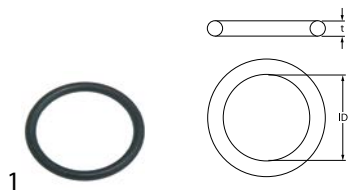
	
<b>GEV No.</b>	510408 <b>Ref. No.</b> 6005015
<b>description</b>	O-ring EPDM thickness 5.34mm ID ø 47mm Qty 1 pcs
<b>For models:</b>	OD10.10, OD10.20, OD12.20, OD20.10, OD20.20, OD6.10, OS10.10, OS10.20, OS12.20, OS20.10, OS20.20, OS6.10, OSC10.10, OSC10.20, OSC12.20, OSC20.10, OSC20.20, OSC6.10, OSP10.10, OSP10.20, OSP12.20, OSP20.10, OSP20.20, OSP6.10

### flange gaskets

	
<b>GEV No.</b>	550992 <b>Ref. No.</b> 6015023
<b>description</b>	gasket L 87mm W 57mm hole ø 6mm hole distance 70/40mm 4 holes thickness 3mm suitable for CONVOTHERM
<b>For models:</b>	OEB10.10, OEB10.20, OEB12.20, OEB20.10, OEB20.20, OEB6.10, OEB6.20, OES10.10, OES10.20, OES12.20, OES20.10, OES20.20, OES6.10, OES6.20, OGB10.10, OGB10.20, OGB12.20, OGB20.10, OGB20.20, OGB6.10, OGB6.20, OGS10.10, OGS10.20, OGS12.20, OGS20.10, OGS20.20, OGS6.10, OGS6.20

	
<b>GEV No.</b>	551383 <b>Ref. No.</b> 6056322
<b>description</b>	gasket L 86mm W 82mm hole ø 6mm hole distance 66mm 5 holes rubber thickness 3mm immersion heater suitable for CONVOTHERM 4

	
<b>GEV No.</b>	692931 <b>Ref. No.</b> 2623218
<b>description</b>	connection set with fixing kit suitable for CONVOTHERM for heating element



thermostats

bi-metal thermostats

bi-metal thermostats



<b>GEV No.</b>	391049	<b>Ref. No.</b>	5056372
<b>description</b>	bi-metal thermostat hole distance 24mm switch-off temp. 80°C 1NC 1-pole 10A 250V connection F6.3x0.8 suitable for CONVOTHERM		

control and safety thermostats

EGO

control thermostats

55.10/19\_ series



<b>GEV No.</b>	375631	<b>Ref. No.</b>	5001032
<b>description</b>	thermostat t.max. 249°C temperature range 55-249°C 1-pole 1NO 16A probe ø 3.1mm probe L 226mm capillary pipe 1270mm capillary pipe isolated 850mm gland nut 3/8"-M8x1 shaft ø 6x4.6mm shaft L 23mm shaft position upper rotation 318°		
<b>For models:</b>	OD10.20, OD12.20		



<b>GEV No.</b>	375632	<b>Ref. No.</b>	5001020
<b>description</b>	thermostat t.max. 90°C temperature range 30-90°C 1-pole 1CO 16A probe ø 6mm probe L 130mm capillary pipe 1300mm capillary pipe isolated 850mm gland nut M10x1 shaft ø 6x4.6mm shaft L 23mm shaft position upper rotation 270°		
<b>For models:</b>	OD10.20, OD12.20		

55.13\_ series



<b>GEV No.</b>	375116	<b>Ref. No.</b>	5001021 5001021K 5001040
<b>description</b>	thermostat t.max. 258°C temperature range 58-258°C 1-pole 1NC 16A probe ø 3.1mm probe L 201mm capillary pipe 1130mm capillary pipe isolatedmm gland nut shaft ø 6x4.6mm shaft L 23mm shaft position upper rotation 270°		
<b>For models:</b>	AR100, AR108, AR12, AR16, AR18, AR28, AR30, AR40, AR50, AR54, AR72, AR8, HUD10.10, HUD12.20, HUD20.10, HUD20.20, HUD6.10, UG10.10, UG10.20, UG20.10, UG20.20, UG4.05, UG6.05, UG6.10		

safety thermostats

55.13\_ series



<b>GEV No.</b>	375245	<b>Ref. No.</b>	5019002 5019004
<b>description</b>	safety thermostat switch-off temp. 135°C 1-pole 16A probe ø 6mm probe L 77mm capillary pipe 480mm capillary pipe isolatedmm gland nut probe SS		
<b>For models:</b>	OGB10.10, OGB10.20, OGB12.20, OGB20.10, OGB20.20, OGB6.10, OGB6.20, OGS10.10, OGS10.20, OGS12.20, OGS20.10, OGS20.20, OGS6.10, OGS6.20		



<b>GEV No.</b>	375731	<b>Ref. No.</b>	5001026 5001026+6005081 5001026K
<b>description</b>	safety thermostat switch-off temp. 135°C 1-pole 1NC 16A probe ø 6mm probe L 77mm capillary pipe 520mm capillary pipe isolatedmm gland nut probe SS		
<b>For models:</b>	OD10.10, OD10.20, OD12.20, OD20.10, OD20.20, OD6.10		





1

<b>GEV No.</b>	375117	<b>Ref. No.</b>	5001030 5001030K 51021
<b>description</b>	safety thermostat switch-off temp. 325°C 1-pole 16A probe ø 4mm probe L 91mm capillary pipe 390mm capillary pipe isolatedmm gland nut probe SS		
<b>For models:</b>	OD10.10, OD10.20, OD6.10		



1

<b>GEV No.</b>	375017	<b>Ref. No.</b>	2618787
<b>description</b>	safety thermostat switch-off temp. 360°C 3-pole 20A probe ø 4mm probe L 122mm capillary pipe 1490mm capillary pipe isolatedmm probe		
<b>For models:</b>	OES6.06		



1

<b>GEV No.</b>	390126	<b>Ref. No.</b>	5001029 5001029K
<b>description</b>	safety thermostat switch-off temp. 340°C 1-pole 1NC 16A probe ø 3.1mm probe L 201mm capillary pipe 1170mm capillary pipe isolatedmm gland nut probe SS		
<b>For models:</b>	AR108, AR72, OD10.10, OD10.20, OD12.20, OD20.10, OD20.20, OD6.10, OS10.10, OS10.20, OS12.20, OS20.10, OS20.20, OS6.10, OSC10.10, OSC10.20, OSC12.20, OSC20.10, OSC20.20, OSC6.10, OSP10.10, OSP10.20, OSP12.20, OSP20.10, OSP20.20, OSP6.10		



1

<b>GEV No.</b>	375474	<b>Ref. No.</b>	5001031
<b>description</b>	safety thermostat t.max. 340°C switch-off temp. 340°C 2-pole 1NC/1CO 1x20/1x0.5A probe ø 4mm probe L 120mm capillary pipe 1300mm capillary pipe isolated 900mm gland nut probe		
<b>For models:</b>	OD10.10, OD10.20, OD12.20, OD20.20, OD6.10, OSG10.10, OSG12.20, OSG20.20		

55.32\_ series



1

<b>GEV No.</b>	375392	<b>Ref. No.</b>	5001039
<b>description</b>	safety thermostat switch-off temp. 360°C 3-pole 1CO/2NC 20A probe ø 4mm probe L 120mm capillary pipe 1490mm capillary pipe isolated 1450mm gland nut probe SS		
<b>For models:</b>	AR12, AR18, AR28, AR40, AR54, AR8, OES6.06		

56\_ series



1

<b>GEV No.</b>	381480	<b>Ref. No.</b>	5056319
<b>description</b>	safety thermostat switch-off temp. 170°C temperature range 14-170°C 1-pole 16A probe ø 6mm probe L 65mm capillary pipe 1460mm capillary pipe isolated 1400mm probe material SS 230V		

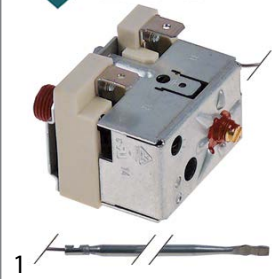

<b>GEV No.</b>	375870	<b>Ref. No.</b>	5001041
<b>description</b>	safety thermostat switch-off temp. 340°C 1-pole 16A probe ø 3mm probe L 160mm capillary pipe 1150mm capillary pipe isolated 1080mm gland nut probe		
<b>For models:</b>	OEB10.10, OEB10.20, OEB12.20, OEB20.10, OEB20.20, OEB6.10, OEB6.20, OES10.10, OES10.20, OES12.20, OES20.10, OES20.20, OES6.10, OES6.20, OGB10.10, OGB10.20, OGB12.20, OGB20.10, OGB20.20, OGB6.10, OGB6.20, OGS10.10, OGS10.20, OGS12.20, OGS20.10, OGS20.20, OGS6.10, OGS6.20, OSC10.10, OSC10.20, OSC12.20, OSC20.10, OSC20.20, OSC6.10, OSG10.10, OSG12.20, OSG20.20, OSG6.10		



<b>GEV No.</b>	376061	<b>Ref. No.</b>	5056329
<b>description</b>	safety thermostat switch-off temp. 340°C 1-pole 16A probe ø 3mm probe L 160mm capillary pipe 1200mm capillary pipe isolated 1140mm		

accessories

fitting parts



<b>GEV No.</b>	550389	<b>Ref. No.</b>	4006041
<b>description</b>	bracket for contact thermostat		
<b>For models:</b>	HUD12.20, HUD20.20		



<b>GEV No.</b>	550388	<b>Ref. No.</b>	4006031
<b>description</b>	bracket for contact thermostat mounting distance 24.5mm mounting ø 3.8		
<b>For models:</b>	HUD10.10, HUD20.10, HUD20.20, OD10.20, OD12.20		

gland nut accessories

ducts



<b>GEV No.</b>	550148	<b>Ref. No.</b>	6005080
<b>description</b>	gland duct ET M12x0.75 IT M9x1 probe ø max. 6.5mm WS 17 silicone		
<b>For models:</b>	HUD10.10, HUD12.20, HUD20.10, HUD20.20, HUD6.10, OD10.10, OD10.20, OD12.20, OD20.10, OD20.20, OD6.10, OS12.20, OS20.10, OS20.20, OSC12.20, OSC20.10, OSC20.20, OSP12.20, OSP20.10, OSP20.20		

gaskets



<b>GEV No.</b>	699830	<b>Ref. No.</b>	6015026
<b>description</b>	gasket silicone ø 10mm L 8mm		
<b>For models:</b>	OEB10.10, OEB10.20, OEB12.20, OEB20.10, OEB20.20, OEB6.10, OEB6.20, OES10.10, OES10.20, OES12.20, OES20.10, OES20.20, OES6.10, OES6.20, OGB10.10, OGB10.20, OGB12.20, OGB20.10, OGB20.20, OGB6.10, OGB6.20, OGS10.10, OGS10.20, OGS12.20, OGS20.10, OGS20.20, OGS6.10, OGS6.20		

switches and momentary switches

cam switches

on/off



<b>GEV No.</b>	301282	<b>Ref. No.</b>	5003022
<b>description</b>	cam switch sequence 0-1 shaft ø 6x4.6mm shaft L 19.5mm 4-pole rotation 45°		
<b>For models:</b>	OD10.10, OD10.20, OD12.20, OD20.10, OD20.20, OD6.10		

5 operating positions



<b>GEV No.</b>	301277	<b>Ref. No.</b>	5003023
<b>description</b>	cam switch 5 operating positions 7NO sequence 0-1-2-3-4 16A shaft ø 6x4.6mm shaft L 19mm connection male faston 6.3mm plastic		
<b>For models:</b>	OD10.10, OD10.20, OD12.20, OD20.10, OD20.20, OD6.10		



magnetic switches

28.5x19mm



<b>GEV No.</b>	348210	<b>Ref. No.</b>	5056328
<b>description</b>	magnetic switch L 28.5mm W 19mm cable length 450mm PIC MS-328/980A 5214 suitable for CONVOTHERM		

29x19mm

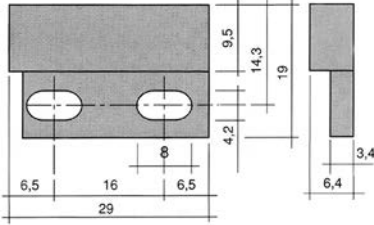

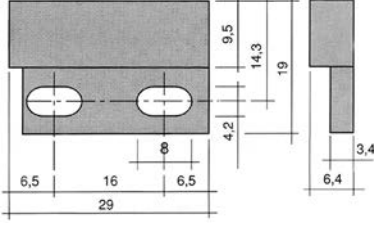

<b>GEV No.</b>	345117	<b>Ref. No.</b>	5003075 5013070
<b>description</b>	magnetic switch L 28.5mm W 19mm 1NO 250V 0.04A P max. 10W connection cable cable length 1000mm		
<b>For models:</b>	OD10.10, OD10.20, OD12.20, OD20.10, OD20.20, OD6.10, OEB10.10, OEB10.20, OEB12.20, OEB20.10, OEB20.20, OEB6.10, OEB6.20, OES10.10, OES10.20, OES12.20, OES20.10, OES20.20, OES6.06, OES6.10, OES6.20, OGB10.10, OGB10.20, OGB12.20, OGB20.10, OGB20.20, OGB6.10, OGB6.20, OGS10.10, OGS10.20, OGS12.20, OGS20.10, OGS20.20, OGS6.10, OGS6.20, OS10.10, OS10.20, OS12.20, OS20.10, OS20.20, OS6.10, OSC10.10, OSC10.20, OSC12.20, OSC20.10, OSC20.20, OSC6.10, OSP10.10, OSP10.20, OSP12.20...(Other models you can see in the webshop)		

<b>GEV No.</b>	347495	<b>Ref. No.</b>	2518798
<b>description</b>	magnetic switch L 29mm W 19mm 1NO 250V 0.3A P max. 10W connection cable cable length 2000mm PIC		
<b>For models:</b>	OES6.06		

32x15mm

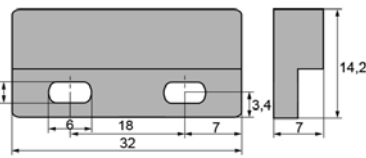
<b>GEV No.</b>	345109	<b>Ref. No.</b>	5003082
<b>description</b>	magnetic switch L 32mm W 15mm 1NO 250V 1A P max. 40W connection cable cable length 2000mm		

M10x0.75

<b>GEV No.</b>	345632	<b>Ref. No.</b>	5003079
<b>description</b>	magnetic switch thread M10x0.75 1NO 250V 0.5A P max. 50W connection cable cable length 2000mm type 102		
<b>For models:</b>	OD10.20, OD12.20, OD20.20, OSG10.10, OSG12.20, OSG20.20, OSG6.10		
<b>accessories for</b>	345632		
	<b>GEV No.</b>	<b>Ref. No.</b>	—
	nut thread M10x0.75 H 3mm WS 14 SS Qty 2 pcs		

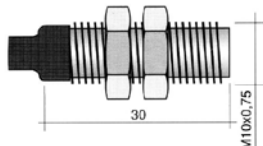
accessories

magnets

<b>GEV No.</b>	345700	<b>Ref. No.</b>	5003076
<b>description</b>	magnet ømm L 29mm H 6.5mm W 19mm hole distance 16mm M3 hole ø 3.5mm		
<b>For models:</b>	OD10.10, OD10.20, OD12.20, OD20.10, OD20.20, OD6.10, OSP6.10		

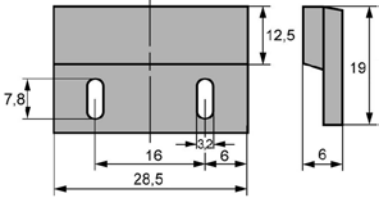
## control equipment

### RAFI

#### Lumotast series

##### fascias

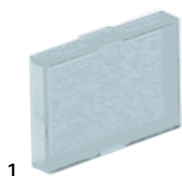

1

<b>GEV No.</b>	345140	<b>Ref. No.</b>	5003054
<b>description</b>	bezel clear		
<b>For models:</b>	HUD10.10, HUD12.20, HUD20.10, HUD20.20, HUD6.10		

#### momentary push switches



1

<b>GEV No.</b>	345139	<b>Ref. No.</b>	5003053
<b>description</b>	momentary push switch mounting measurements ø16mm 230V 1NC/1NO		
<b>For models:</b>	HUD10.10, HUD12.20, HUD20.10, HUD20.20, HUD6.10		

**accessories for** 345139



<b>GEV No.</b>	345140	<b>Ref. No.</b>	5003054
<b>description</b>	bezel clear		



<b>GEV No.</b>	346719	<b>Ref. No.</b>	—
<b>description</b>	bezel yellow		



<b>GEV No.</b>	346720	<b>Ref. No.</b>	—
<b>description</b>	bezel rectangular green		



<b>GEV No.</b>	346721	<b>Ref. No.</b>	—
<b>description</b>	bezel rectangular red		



<b>GEV No.</b>	359590	<b>Ref. No.</b>	—
<b>description</b>	light bulb socket T5.5K 24V 3W ø 5.5mm L 22mm clear		



<b>GEV No.</b>	359591	<b>Ref. No.</b>	—
<b>description</b>	light bulb socket T5.5K 48V 3W ø 5.5mm L 22mm clear		



<b>GEV No.</b>	359592	<b>Ref. No.</b>	—
<b>description</b>	light bulb socket T5.5K 12V 3W ø 5.5mm L 22mm clear		



<b>GEV No.</b>	359593	<b>Ref. No.</b>	—
<b>description</b>	light bulb socket T5.5K 60V 0.02A		

## TELEMECANIQUE (EFA)

### XB4 series

#### rotary switches



1

<b>GEV No.</b>	347383	<b>Ref. No.</b>	5003031 5003031K 5003035
<b>description</b>	switch mounting measurements ø22mm 2NO 0-1 latching		
<b>For models:</b>	HUD10.10, HUD12.20, HUD20.10, HUD20.20, HUD6.10		

## encoders and potentiometers



1

<b>GEV No.</b>	300268	<b>Ref. No.</b>	5056359
<b>description</b>	encoder rotation 360° 0.01A shaft ø 6x5.5mm shaft L 17mm connection for ribbon cable for combi-steamer thread M10x0.75 5V CONVOTHERM 4 0.10hm CESI 32/LS EBE		



1

<b>GEV No.</b>	300098	<b>Ref. No.</b>	5009095
<b>description</b>	potentiometer		
<b>For models:</b>	OD10.10, OD10.20, OD12.20, OD20.10, OD20.20, OD6.10		

## lamps

### indicator lights

#### indicator lights 3-piece (housing, lens and bulb)

##### lamps

##### light bulbs



1

<b>GEV No.</b>	359055	<b>Ref. No.</b>	5003046
<b>description</b>	light bulb socket T1 1/2 12VW 0.08A ø 4.9mm L 13mm		
<b>For models:</b>	OD10.10, OD10.20, OD12.20, OD20.10, OD20.20, OD6.10		





indicator lights (complete)			
ø16mm			
with plug-in socket			
			
1			
<b>GEV No.</b>	362003	<b>Ref. No.</b>	5004026
<b>description</b>	indicator light ø 16mm yellow connection F6.3 temp.-resist. 120°C		
<b>For models:</b>	AR100, AR108, AR12, AR16, AR18, AR28, AR30, AR40, AR50, AR54, AR72, AR8, UG10.10, UG10.20, UG20.10, UG20.20, UG4.05, UG6.05, UG6.10		

## screw-on/push-on fit

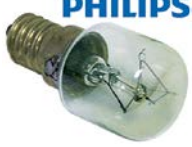
light bulbs			
for ovens			
			
1			
<b>GEV No.</b>	359458	<b>Ref. No.</b>	2618779
<b>description</b>	light bulb socket E14 15W 230V with gasket		
<b>For models:</b>	OEB10.10, OEB10.20, OEB12.20, OEB20.10, OEB20.20, OEB6.10, OEB6.20, OES10.10, OES10.20, OES12.20, OES20.10, OES20.20, OES6.06, OES6.10, OES6.20, OGB10.10, OGB10.20, OGB12.20, OGB20.10, OGB20.20, OGB6.10, OGB6.20, OGS10.10, OGS10.20, OGS12.20, OGS20.10, OGS20.20, OGS6.10, OGS6.20		

			
1			
<b>GEV No.</b>	359610	<b>Ref. No.</b>	5005040 5005040K
<b>description</b>	light bulb t.max. 300°C socket E14 15W 230V ø 22mm L 47mm lens L 20mm for oven lamp type Philips		
<b>For models:</b>	HUD10.10, HUD12.20, HUD20.10, HUD20.20, HUD6.10, OD10.10, OD10.20, OD12.20, OD20.10, OD20.20, OD6.10, UG10.10, UG10.20, UG20.10, UG20.20, UG4.05, UG6.05, UG6.10		

			
1			
<b>GEV No.</b>	359740	<b>Ref. No.</b>	5030622
<b>description</b>	light bulb t.max. 300°C socket E14 15W 230V ø 22mm L 48mm lens L 20mm for oven lamp IMPORT		

			
1			
<b>GEV No.</b>	359612	<b>Ref. No.</b>	5005045
<b>description</b>	light bulb t.max. 300°C socket E14 25W 230V ø 25mm L 56mm lens L 30mm for oven lamp type Philips		







for indicator lights			
			
1			
<b>GEV No.</b>	359055	<b>Ref. No.</b>	5003046
<b>description</b>	light bulb socket T1 1/2 12VW 0.08A ø 4.9mm L 13mm		
<b>For models:</b>	OD10.10, OD10.20, OD12.20, OD20.10, OD20.20, OD6.10		

halogen lamp			
for socket G4 / G6.35 / G9			
			
1			
<b>GEV No.</b>	359596	<b>Ref. No.</b>	5056314
<b>description</b>	halogen lamp socket G4 12V 10W temp.-resist. 500°C		





## oven lamps

universal oven lamps			
mounting diameter 35.5mm			
			
1			
<b>GEV No.</b>	359720	<b>Ref. No.</b>	5005012
<b>description</b>	oven lamp mounting ø 35.5mm 230V 15W socket E14 temp.-resist. 300°C connection male faston 6.3mm hard glas		
<b>For models:</b>	HUD10.10, HUD12.20, HUD20.10, HUD20.20, HUD6.10, OD10.10, OD10.20, OD12.20, OD20.10, OD20.20, OD6.10, UG10.10, UG10.20, UG20.10, UG20.20, UG4.05, UG6.05, UG6.10		
<b>spare parts for</b>	359720		
		<b>GEV No.</b>	359701
		<b>Ref. No.</b>	5005016
		<b>description</b>	lamp socket socket E14 220-230V mounting ø 35.5mm connection male faston 6.3mm 15W
		<b>GEV No.</b>	359705
		<b>Ref. No.</b>	5005017 5005017K 5030620
		<b>description</b>	oven lamp glass thr.ø 33.5mm ø 52mm hard glas temp.-resist. 350°C
		<b>GEV No.</b>	359721
		<b>Ref. No.</b>	5005025
		<b>description</b>	gasket silicone ED ø 48mm ID ø 39.5mm thickness 5mm Qty 1 pcs
		<b>GEV No.</b>	359740
		<b>Ref. No.</b>	5030622
		<b>description</b>	light bulb t.max. 300°C socket E14 15W 230V ø 22mm L 48mm lens L 20mm for oven lamp IMPORT

			
1			
<b>GEV No.</b>	359701	<b>Ref. No.</b>	5005016
<b>description</b>	lamp socket socket E14 220-230V mounting ø 35.5mm connection male faston 6.3mm 15W		
<b>For models:</b>	OD10.10, OD10.20, OD12.20, OD20.10, OD20.20, OD6.10, OS10.10, OS10.20, OS12.20, OS20.10, OS20.20, OS6.10, OSC10.10, OSC10.20, OSC12.20, OSC20.10, OSC20.20, OSC6.10, OSG10.10, OSG12.20, OSG20.20, OSG6.10, OSP10.10, OSP10.20, OSP12.20, OSP20.10, OSP20.20, OSP6.10		
<b>accessories for</b>	359701		
	<b>GEV No.</b>	359705	<b>Ref. No.</b> 5005017 5005017K 5030620
oven lamp glass thr.ø 33.5mm ø 52mm hard glas temp.-resist. 350°C			
	<b>GEV No.</b>	359709	<b>Ref. No.</b> —
oven lamp glass thr.ø 33.5mm ø 42mm hard glas temp.-resist. 350°C			
	<b>GEV No.</b>	359721	<b>Ref. No.</b> 5005025
gasket silicone ED ø 48mm ID ø 39.5mm thickness 5mm Qty 1 pcs			
	<b>GEV No.</b>	359942	<b>Ref. No.</b> —
oven lamp glass thr.ø 33.5mm ø 41mm hard glas temp.-resist. 350°C			



			
1			
<b>GEV No.</b>	359705	<b>Ref. No.</b>	5005017 5005017K 5030620
<b>description</b>	oven lamp glass thr.ø 33.5mm ø 52mm hard glas temp.-resist. 350°C		
<b>For models:</b>	HUD10.10, HUD12.20, HUD20.10, HUD20.20, HUD6.10, OD10.10, OD10.20, OD12.20, OD20.10, OD20.20, OD6.10, UG10.10, UG10.20, UG20.10, UG20.20, UG4.05, UG6.05, UG6.10		
<b>accessories for</b>	359705		
	<b>GEV No.</b>	359610	<b>Ref. No.</b> 5005040 5005040K
light bulb t.max. 300°C socket E14 15W 230V ø 22mm L 47mm lens L 20mm for oven lamp type Philips			
	<b>GEV No.</b>	359700	<b>Ref. No.</b> —
gasket for pizza oven fibre glass ID ø 32.5mm ED ø 55mm thickness 5mm			
	<b>GEV No.</b>	359721	<b>Ref. No.</b> 5005025
gasket silicone ED ø 48mm ID ø 39.5mm thickness 5mm Qty 1 pcs			
	<b>GEV No.</b>	359837	<b>Ref. No.</b> —
gasket ID ø 33mm ED ø 46mm thickness 1mm graphite			
	<b>GEV No.</b>	359838	<b>Ref. No.</b> —
gasket ID ø 33mm ED ø 45mm			

			
1			
<b>GEV No.</b>	359721	<b>Ref. No.</b>	5005025
<b>description</b>	gasket silicone ED ø 48mm ID ø 39.5mm thickness 5mm Qty 1 pcs		
<b>For models:</b>	HUD10.10, HUD12.20, HUD20.10, HUD20.20, HUD6.10, OD10.10, OD10.20, OD12.20, OD20.10, OD20.20, OD6.10, UG10.10, UG10.20, UG20.10, UG20.20, UG4.05, UG6.05, UG6.10		

<b>55x70mm</b>			
			
1			
<b>GEV No.</b>	360730	<b>Ref. No.</b>	5056316
<b>description</b>	gasket		
<b>accessories for</b>	360730		
	<b>GEV No.</b>	359596	<b>Ref. No.</b> 5056314
halogen lamp socket G4 12V 10W temp.-resist. 500°C			
	<b>GEV No.</b>	360728	<b>Ref. No.</b> 5056317
lamp cover complete L 99.5mm W 84.5mm H 8.5mm mounting distance 68/83mm			
	<b>GEV No.</b>	360729	<b>Ref. No.</b> 5056315
lamp socket socket G4 with cable			

			
1			
<b>GEV No.</b>	360728	<b>Ref. No.</b>	5056317
<b>description</b>	lamp cover complete L 99.5mm W 84.5mm H 8.5mm mounting distance 68/83mm		
<b>accessories for</b>	360728		
	<b>GEV No.</b>	359596	<b>Ref. No.</b> 5056314
halogen lamp socket G4 12V 10W temp.-resist. 500°C			
	<b>GEV No.</b>	360729	<b>Ref. No.</b> 5056315
lamp socket socket G4 with cable			
	<b>GEV No.</b>	360730	<b>Ref. No.</b> 5056316
gasket			









			
1			
<b>GEV No.</b>	359297	<b>Ref. No.</b>	5015003 5015006
<b>description</b>	frame L 95mm W 81mm mounting distance 68/83mm thickness 6mm		
<b>For models:</b>	OEB10.10, OEB10.20, OEB12.20, OEB20.10, OEB20.20, OEB6.10, OEB6.20, OES10.10, OES10.20, OES12.20, OES20.10, OES20.20, OES6.06, OES6.10, OES6.20, OGB10.10, OGB10.20, OGB12.20, OGB20.10, OGB20.20, OGB6.10, OGB6.20, OGS10.10, OGS10.20, OGS12.20, OGS20.10, OGS20.20, OGS6.10, OGS6.20		
<b>accessories for</b>	359297		
		<b>GEV No.</b>	359299 <b>Ref. No.</b> —
	gasket L 91mm W 77mm hole ø 3mm for oven lamp		

			
1			
<b>GEV No.</b>	359296	<b>Ref. No.</b>	5015002
<b>description</b>	lamp glass L 74mm W 58mm thickness 3mm		
<b>For models:</b>	OEB10.10, OEB10.20, OEB12.20, OEB20.10, OEB20.20, OEB6.10, OEB6.20, OES10.10, OES10.20, OES12.20, OES20.10, OES20.20, OES6.06, OES6.10, OES6.20, OGB10.10, OGB10.20, OGB12.20, OGB20.10, OGB20.20, OGB6.10, OGB6.20, OGS10.10, OGS10.20, OGS12.20, OGS20.10, OGS20.20, OGS6.10, OGS6.20		

			
1			
<b>GEV No.</b>	360728	<b>Ref. No.</b>	5056317
<b>description</b>	lamp cover complete L 99.5mm W 84.5mm H 8.5mm mounting distance 68/83mm		
<b>accessories for</b>	360728		
		<b>GEV No.</b>	359596 <b>Ref. No.</b> 5056314
	halogen lamp socket G4 12V 10W temp.-resist. 500°C		
		<b>GEV No.</b>	360729 <b>Ref. No.</b> 5056315
	lamp socket socket G4 with cable		
		<b>GEV No.</b>	360730 <b>Ref. No.</b> 5056316
	gasket		

			
1			
<b>GEV No.</b>	694335	<b>Ref. No.</b>	5015005
<b>description</b>	lamp glass L 87mm W 72mm thickness 3mm		

			
1			
<b>GEV No.</b>	359488	<b>Ref. No.</b>	2618780
<b>description</b>	oven lamp complete mounting measurements 55x70mm 230V 15W socket E14 rectangular connection male faston 6.3mm L 87mm W 70mm		
<b>For models:</b>	OEB10.10, OEB10.20, OEB12.20, OEB20.10, OEB20.20, OEB6.10, OEB6.20, OES10.10, OES10.20, OES12.20, OES20.10, OES20.20, OES6.06, OES6.10, OES6.20, OGB10.10, OGB10.20, OGB12.20, OGB20.10, OGB20.20, OGB6.10, OGB6.20, OGS10.10, OGS10.20, OGS12.20, OGS20.10, OGS20.20, OGS6.10, OGS6.20		
<b>spare parts for</b>	359488		
		<b>GEV No.</b>	358180 <b>Ref. No.</b> 6015018 6015020
	gasket L 94mm W 78mm PTFE thickness 3mm for oven lamp		
		<b>GEV No.</b>	359297 <b>Ref. No.</b> 5015003 5015006
	frame L 95mm W 81mm mounting distance 68/83mm thickness 6mm		
		<b>GEV No.</b>	359299 <b>Ref. No.</b> —
	gasket L 91mm W 77mm hole ø 3mm for oven lamp		
		<b>GEV No.</b>	694335 <b>Ref. No.</b> 5015005
	lamp glass L 87mm W 72mm thickness 3mm		

producer-specific oven lamps			
CONVOTHERM			
			
1			
<b>GEV No.</b>	360641	<b>Ref. No.</b>	N/A
<b>description</b>	gasket L 86mm W 71mm PTFE thickness 0.5mm for oven lamp		
<b>For models:</b>	OEB10.10, OEB10.20, OEB12.20, OEB20.10, OEB20.20, OEB6.10, OEB6.20, OES10.10, OES10.20, OES12.20, OES20.10, OES20.20, OES6.06, OES6.10, OES6.20, OGB10.10, OGB10.20, OGB12.20, OGB20.10, OGB20.20, OGB6.10, OGB6.20, OGS10.10, OGS10.20, OGS12.20, OGS20.10, OGS20.20, OGS6.10, OGS6.20		

			
1			
<b>GEV No.</b>	358180	<b>Ref. No.</b>	6015018 6015020
<b>description</b>	gasket L 94mm W 78mm PTFE thickness 3mm for oven lamp		







			
1			
<b>GEV No.</b>	692171	<b>Ref. No.</b>	5005020
<b>description</b>	frame for lamp lenses bore ø 6.3mm D1 ø 72mm D2 ø 56mm L 83mm W 83mm thickness 1mm		
<b>For models:</b>	OD10.10, OD10.20, OD12.20, OD20.10, OD20.20, OD6.10, OS10.10, OS10.20, OS12.20, OS20.10, OS20.20, OS6.10, OSC10.10, OSC10.20, OSC12.20, OSC20.10, OSC20.20, OSC6.10, OSP10.10, OSP10.20, OSP12.20, OSP20.10, OSP20.20, OSP6.10		

			
1			
<b>GEV No.</b>	359643	<b>Ref. No.</b>	5005022
<b>description</b>	lamp glass ø 69mm thickness 4mm		
<b>For models:</b>	OD10.10, OD10.20, OD12.20, OD20.10, OD20.20, OD6.10, OS10.10, OS10.20, OS12.20, OS20.10, OS20.20, OS6.10, OSC10.10, OSC10.20, OSC12.20, OSC20.10, OSC20.20, OSC6.10, OSP10.10, OSP10.20, OSP12.20, OSP20.10, OSP20.20, OSP6.10		

			
1			
<b>GEV No.</b>	359701	<b>Ref. No.</b>	5005016
<b>description</b>	lamp socket socket E14 220-230V mounting ø 35.5mm connection male faston 6.3mm 15W		
<b>For models:</b>	OD10.10, OD10.20, OD12.20, OD20.10, OD20.20, OD6.10, OS10.10, OS10.20, OS12.20, OS20.10, OS20.20, OS6.10, OSC10.10, OSC10.20, OSC12.20, OSC20.10, OSC20.20, OSC6.10, OSG10.10, OSG12.20, OSG20.20, OSG6.10, OSP10.10, OSP10.20, OSP12.20, OSP20.10, OSP20.20, OSP6.10		
<b>accessories for</b>	359701		
	<b>GEV No.</b>	359705	<b>Ref. No.</b> 5005017 5005017K 5030620
oven lamp glass thr.ø 33.5mm ø 52mm hard glas temp.-resist. 350°C			
	<b>GEV No.</b>	359709	<b>Ref. No.</b> —
oven lamp glass thr.ø 33.5mm ø 42mm hard glas temp.-resist. 350°C			
	<b>GEV No.</b>	359721	<b>Ref. No.</b> 5005025
gasket silicone ED ø 48mm ID ø 39.5mm thickness 5mm Qty 1 pcs			
	<b>GEV No.</b>	359942	<b>Ref. No.</b> —
oven lamp glass thr.ø 33.5mm ø 41mm hard glas temp.-resist. 350°C			

			
1			
<b>GEV No.</b>	358174	<b>Ref. No.</b>	5005022K 5030621
<b>description</b>	lamp glass ø 69mm thickness 4mm with gasket		

			
1			
<b>GEV No.</b>	360629	<b>Ref. No.</b>	2628501
<b>description</b>	oven lamp incl. gasket mounting ø 10mm 12V 10W socket G4 CONVOTHERM temp.-resist. 300°C		
<b>spare parts for</b>	360629		
	<b>GEV No.</b>	359596	<b>Ref. No.</b> 5056314
halogen lamp socket G4 12V 10W temp.-resist. 500°C			

			
1			
<b>GEV No.</b>	360680	<b>Ref. No.</b>	2628500
<b>description</b>	oven lamp incl. gasket mounting ø 10mm 12V 10W socket G4 CONVOTHERM temp.-resist. 300°C		
<b>spare parts for</b>	360680		
	<b>GEV No.</b>	359596	<b>Ref. No.</b> 5056314
halogen lamp socket G4 12V 10W temp.-resist. 500°C			

**lamps**  
**light bulbs**

			
1			
<b>GEV No.</b>	359610	<b>Ref. No.</b>	5005040 5005040K
<b>description</b>	light bulb t.max. 300°C socket E14 15W 230V ø 22mm L 47mm lens L 20mm for oven lamp type Philips		
<b>For models:</b>	HUD10.10, HUD12.20, HUD20.10, HUD20.20, HUD6.10, OD10.10, OD10.20, OD12.20, OD20.10, OD20.20, OD6.10, UG10.10, UG10.20, UG20.10, UG20.20, UG4.05, UG6.05, UG6.10		

			
1			
<b>GEV No.</b>	359740	<b>Ref. No.</b>	5030622
<b>description</b>	light bulb t.max. 300°C socket E14 15W 230V ø 22mm L 48mm lens L 20mm for oven lamp IMPORT		

			
1			
<b>GEV No.</b>	359612	<b>Ref. No.</b>	5005045
<b>description</b>	light bulb t.max. 300°C socket E14 25W 230V ø 25mm L 56mm lens L 30mm for oven lamp type Philips		







halogen lamps			
for socket G4 / G6.35 / G9			
			
<b>GEV No.</b>	359596	<b>Ref. No.</b>	5056314
<b>description</b>	halogen lamp socket G4 12V 10W temp.-resist. 500°C		

sockets				
G4 / G5,3 / G6,35				
				
<b>GEV No.</b>	360729	<b>Ref. No.</b>	5056315	
<b>description</b>	lamp socket socket G4 with cable			
<b>accessories for</b>	360729			
	<b>GEV No.</b>	359596	<b>Ref. No.</b>	5056314
	halogen lamp socket G4 12V 10W temp.-resist. 500°C			
	<b>GEV No.</b>	360728	<b>Ref. No.</b>	5056317
	lamp cover complete L 99.5mm W 84.5mm H 8.5mm mounting distance 68/83mm			
	<b>GEV No.</b>	360730	<b>Ref. No.</b>	5056316
	gasket			

timers

mechanical timers

				
<b>GEV No.</b>	350023	<b>Ref. No.</b>	5001003 5001003K	
<b>description</b>	timer M2 2-pole operation time 90min impulse mechanical 2CO at 250V 16A permanent position no shaft ø 6x4.6mm shaft 6x4.6mm shaft L 23mm mounting distance 28mm connection lateral			
<b>For models:</b>	HUD10.10, HUD12.20, HUD20.10, HUD20.20, HUD6.10, UG10.10, UG10.20, UG20.10, UG20.20, UG4.05, UG6.05, UG6.10			
<b>accessories for</b>	350023			
	<b>GEV No.</b>	110366	<b>Ref. No.</b>	—
	knob switch zero mark t.max.°C ø 44mm shaft ø 6x4.6mm shaft flat upper black			

			
<b>GEV No.</b>	350112	<b>Ref. No.</b>	5001001 5001001K 5030611
<b>description</b>	timer M2 2-pole operation time 90min impulse mechanical 2NO at 250V 16A permanent position no shaft ø 6x4.6mm shaft 6x4.6mm shaft L 23mm mounting distance 28mm connection rear		
<b>For models:</b>	AR100, AR108, AR12, AR16, AR18, AR28, AR30, AR40, AR50, AR54, AR72, AR8, UG10.10, UG10.20, UG20.10, UG20.20, UG4.05, UG6.05, UG6.10		

alarm devices

buzzers

			
<b>GEV No.</b>	350053	<b>Ref. No.</b>	4003050
<b>description</b>	buzzer 12VAC connection male faston 3.2mm screw mounting buzzer		
<b>For models:</b>	HUD10.10, HUD12.20, HUD20.10, HUD20.20, HUD6.10, OD10.10, OD10.20, OD12.20, OD20.10, OD20.20, OD6.10, UG10.10, UG10.20, UG20.10, UG20.20, UG4.05, UG6.05, UG6.10		

			
<b>GEV No.</b>	350050	<b>Ref. No.</b>	5003050
<b>description</b>	buzzer 230VAC connection male faston 6.3mm screw mounting thread M4 60dB		

contactors

BENEDIKT & JÄGER

power contactors

			
<b>GEV No.</b>	381476	<b>Ref. No.</b>	5056963
<b>description</b>	power contactor resistive load 130A 230 (AC3/400V) 37kW main contacts 3NO connection screw type K3-74A00		



1

<b>GEV No.</b>	380774	<b>Ref. No.</b>	5056373A
<b>description</b>	power contactor resistive load 32A 230VAC (AC3/400V) 18A/7.5kW main contacts 3NO auxiliary contacts 1NO connection screw connection type K3-18ND10		



1

<b>GEV No.</b>	380775	<b>Ref. No.</b>	5056962
<b>description</b>	power contactor resistive load 65A 230VAC (AC3/400V) 32A/15kW main contacts 3NO auxiliary contacts connection screw connection type K3-32A00230		

auxiliary contacts



1

<b>GEV No.</b>	381456	<b>Ref. No.</b>	5056966
<b>description</b>	auxiliary contact contacts 1NC/1NO AC15 3A connection screw type HKA11		



1

<b>GEV No.</b>	380678	<b>Ref. No.</b>	5056965
<b>description</b>	auxiliary contact contacts 1NO AC15 10A for contactors K2/K3 connection screw type HN10 AC1 25A		

GENERAL ELECTRIC (AEG)

power contactors



1

<b>GEV No.</b>	380247	<b>Ref. No.</b>	4001020 4001020K 4001027 4011000
<b>description</b>	power contactor resistive load 25A 400VAC (AC3/400V) 9A/4kW main contacts 3NO auxiliary contacts 1NC connection screw connection type AEG LS4K 01A type GE CL00A 301		
<b>For models:</b>	AR108, AR28, HUD10.10, OD10.10, OD12.20, OD20.10, OD20.20, OD6.10, OEB10.10, OEB10.20, OEB12.20, OEB20.10, OEB20.20, OEB6.10, OEB6.20, OES10.10, OES10.20, OES12.20, OES20.10, OES20.20, OES6.06, OES6.10, OES6.20, OGB10.10, OGB10.20, OGB12.20, OGB20.10, OGB20.20, OGB6.10, OGB6.20, OGS10.10, OGS10.20, OGS12.20, OGS20.10, OGS20.20, OGS6.10, OGS6.20, OSC10.10, OSC10.20, OSC12.20, OSC20.10, OSC20.20, OSC6.10, OSG10.10, OSG12.20, OSG20.20, OSG6.10, OSP10.10, OSP10.20...(Other models you can see in the webshop)		



1

<b>GEV No.</b>	380265	<b>Ref. No.</b>	4001041 4011013K
<b>description</b>	power contactor resistive load 60A 230VAC (AC3/400V) 32A/16kW main contacts 3NO auxiliary contacts 1NO connection screw connection type AEG LS15K 00A type GE CL04A 310 H 98mm L 87mm W 55mm		
<b>For models:</b>	AR108, OD10.10, OD10.20, OD12.20, OD20.10, OD20.20, OD6.10, OSC10.10, OSC10.20, OSC12.20, OSC20.10, OSC20.20, OSP10.10, OSP10.20, OSP12.20, OSP20.10, OSP20.20, OSP6.10		

auxiliary contacts



1

<b>GEV No.</b>	380269	<b>Ref. No.</b>	4001072
<b>description</b>	auxiliary contact contacts 1NC AC15 6A for contactors CL+LS_K connection screw AC-12 10A type AEG HS07K 01 type GE BCLF 01		
<b>For models:</b>	HUD10.10, OD10.10, OD10.20, OD12.20, OD20.10, OD20.20, OD6.10		





			
1			
<b>GEV No.</b>	380268	<b>Ref. No.</b>	4001070
<b>description</b>	auxiliary contact contacts 1NO for contactors CL+LS_K connection screw AC-12 10A type AEG HS07K 10 type GE BCLF 10		
<b>For models:</b>	HUD20.20		

TELEMECANIQUE (Schneider Electric)

power contactors



			
1			
<b>GEV No.</b>	381204	<b>Ref. No.</b>	4011000K
<b>description</b>	power contactor resistive load 20A 230VAC (AC3/400V) 9A/4kW main contacts 3NO auxiliary contacts 1NO/1NC connection spring terminal type LC1D093P7 with RC circuit LAD4RCU		

			
1			
<b>GEV No.</b>	381342	<b>Ref. No.</b>	4011001 4011001K 4030609
<b>description</b>	power contactor resistive load 25A 230VAC (AC3/400V) 18A/7.5kW main contacts 3NO auxiliary contacts 1NO/1NC connection elastic terminals type LC1D183P7		
<b>For models:</b>	OEB10.10, OEB10.20, OEB12.20, OEB20.10, OEB20.20, OEB6.10, OEB6.20, OES10.10, OES10.20, OES12.20, OES20.10, OES20.20, OES6.10, OES6.20		

			
1			
<b>GEV No.</b>	380952	<b>Ref. No.</b>	4001015 4001030 4001030K 4030607
<b>description</b>	power contactor resistive load 40A 230VAC (AC3/400V) 25A/11kW main contacts 4NO auxiliary contacts 1NO/1NC connection screw connection type LC1DT40P7		
<b>For models:</b>	AR100, AR108, AR12, AR16, AR18, AR28, AR30, AR40, AR50, AR54, AR72, HUD10.10, HUD12.20, HUD20.10, HUD20.20, HUD6.10, OD10.10, OD10.20, OD12.20, OD20.10, OD20.20, OD6.10, OSC10.10, OSC10.20, OSC12.20, OSC20.10, OSC20.20, OSC6.10, OSP10.10, OSP10.20, OSP12.20, OSP20.10, OSP20.20, OSP6.10, UG10.10, UG20.10, UG6.05		

ABL SURSUM

motor protection circuit breakers

			
1			
<b>GEV No.</b>	380300	<b>Ref. No.</b>	4002034
<b>description</b>	motor protection circuit breaker type Mbs25-016 setting range 1-1.6A (AC3/400V) 0.55kW		
<b>For models:</b>	HUD10.10, HUD20.10, HUD6.10, OD10.10, OD10.20, OD12.20, OD6.10, UG10.20, UG20.20		
<b>accessories for</b>	380300		
		<b>GEV No.</b>	380305
		<b>Ref. No.</b>	4002039
	auxiliary contact contacts 1NO/1NC HMS11		

			
1			
<b>GEV No.</b>	380301	<b>Ref. No.</b>	4002035
<b>description</b>	motor protection circuit breaker type Mbs25-025 setting range 1.6-2.5A (AC3/400V) 1.1kW		
<b>For models:</b>	AR18, AR28, AR40, AR54, OD10.10, OD10.20, OD12.20, OD20.10, OD20.20, OD6.10, OSG10.10, OSG12.20, OSG20.20, OSG6.10		



1

<b>GEV No.</b>	380302	<b>Ref. No.</b>	4002036
<b>description</b>	motor protection circuit breaker type Mbs25-040 setting range 2.5-4A (AC3/400V) 1.5kW		
<b>For models:</b>	OD10.10, OD10.20, OD12.20, OD20.20, OD6.10, OSG10.10, OSG12.20, OSG20.20, OSG6.10		



1

<b>GEV No.</b>	380322	<b>Ref. No.</b>	4002032
<b>description</b>	motor protection circuit breaker type SFK0E setting range 0.63-1A (AC3/400V) 0.5kW GENERAL ELECTRIC		
<b>For models:</b>	AR108, AR28, AR40, AR54, AR72, HUD10.10, HUD12.20, HUD20.10, HUD20.20, HUD6.10, OD10.10, OD10.20, OD12.20, OD20.10, OD20.20, OD6.10, UG10.10, UG20.10, UG6.10		

## accessories



1

<b>GEV No.</b>	380305	<b>Ref. No.</b>	4002039
<b>description</b>	auxiliary contact contacts 1NO/1NC HMS11		
<b>For models:</b>	HUD12.20, HUD20.20, OD10.10, OD10.20, OD12.20, OD20.10, OD20.20, OD6.10		

## solid state relays

## CRYDOM



1

<b>GEV No.</b>	403868	<b>Ref. No.</b>	5056381
<b>description</b>	solid state relay CRYDOM 1 phase 90A 480V 4-32VDC L 58mm W 44mm screw type CWD4890P		

## relays

## power relays

## with flange mounting



1

<b>GEV No.</b>	380131	<b>Ref. No.</b>	4000017
<b>description</b>	power relays Italiana Relè 230VAC 16A 3CO connection male faston 6.3mm screw mounting manuf. no. B2-3-230AC		

## with male contacts

## female contact 2.0mm

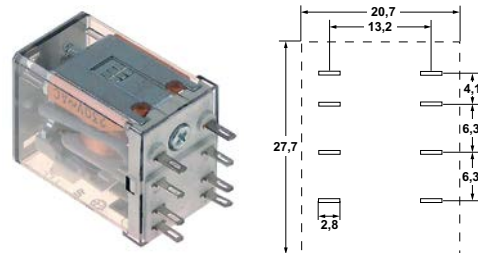

1



<b>GEV No.</b>	380377	<b>Ref. No.</b>	4000022	
<b>description</b>	power relays FINDER 220-240VAC 10A 2CO connection F2 plug-in connection manuf. no. 55.32.8.230.0000 94.92.3 250V			
<b>For models:</b>	OD10.20, OD12.20			
<b>accessories for</b>	380377			
	<b>GEV No.</b>	380341	<b>Ref. No.</b>	—
	<b>GEV No.</b>	380378	<b>Ref. No.</b>	—
	<b>GEV No.</b>	380384	<b>Ref. No.</b>	—

Table continues overleaf



<b>accessories for</b>	380377		
	<b>GEV No.</b>	380399	<b>Ref. No.</b> —
	relay socket 4-pole dimensions 76.2x27x86.1mm 250V voltage AC 1A FINDER manuf. no. 94.94.3		

plug-in/print relays

	1		
<b>GEV No.</b>	381090	<b>Ref. No.</b>	4000012
<b>description</b>	print relay 12VDC at 250V 10A with relay socket		
<b>spare parts for</b>	381090		
	<b>GEV No.</b>	380500	<b>Ref. No.</b> —
	print relay 12VDC 2CO at 250V 8A connection pins raster size 5mm REIPOL		

miscellaneous

	1		
<b>GEV No.</b>	381091	<b>Ref. No.</b>	4000013
<b>description</b>	print relay 230V voltage AC at 250V 10A with relay socket		
<b>For models:</b>	OD10.10, OD12.20, OD20.20, OD6.10, OSG10.10, OSG12.20, OSG20.20, OSG6.10		







transformers

power supplies

	1		
<b>GEV No.</b>	402981	<b>Ref. No.</b>	2618809 5056385
<b>description</b>	power supply primary 100-240VAC secondary 12VDC 60VA secondary 5A H 38mm L 99mm W 155mm connection screw 50/60Hz type ABL1REM12050 combi-steamer P3-devices		
<b>For models:</b>	OES6.06		

probes

producer-specific probes

	1		
<b>GEV No.</b>	400024	<b>Ref. No.</b>	5009050
<b>description</b>	temperature probe NTC 100kOhm cable PVC probe -40 up to +125°C cable -10 up to 100°C connection plug thread M10 probe ø6x120mm cable length 0.1m		
<b>For models:</b>	HUD10.10, HUD12.20, HUD20.10, HUD20.20, HUD6.10		
	1		
<b>GEV No.</b>	379409	<b>Ref. No.</b>	5001035
<b>description</b>	temperature probe Pt100 cable PVC probe -100 up to 450°C cable -10 up to 100°C connection 2-wire thread M10 probe ø3x60mm cable length 0.7m		
<b>For models:</b>	OD10.10, OD10.20, OD12.20, OD20.20, OD6.10		
	1		
<b>GEV No.</b>	379726	<b>Ref. No.</b>	5009053
<b>description</b>	temperature probe Pt100 cable silicone probe -100 up to 450°C cable -50 up to +180°C connection 3-wire thread M10x1 probe ø3x130mm cable length 1.5m		
<b>For models:</b>	OD10.10, OD10.20, OD12.20, OD20.20, OD6.10		
	1		
<b>GEV No.</b>	379104	<b>Ref. No.</b>	5009052
<b>description</b>	temperature probe Pt100 cable silicone probe -50 up to +300°C cable -50 up to +200°C connection 2-wire thread M10 probe ø4.5x-20mm cable length 3m		
<b>For models:</b>	OD10.10, OD10.20, OD12.20, OD20.10, OD20.20, OD6.10, OSP10.20, OSP12.20		
<b>accessories for</b>	379104		
	<b>GEV No.</b>	510416	<b>Ref. No.</b> 6005016
	flat gasket fibre ED ø 19mm ID ø 10.5mm thickness 1.5mm for thread M10 Qty 1 pcs		
	1		
<b>GEV No.</b>	379105	<b>Ref. No.</b>	5001022 5001023
<b>description</b>	temperature probe Pt100 cable silicone probe -50 up to +600°C cable -50 up to +180°C connection 2-wire thread M14x1.5 probe ø3x350mm cable length 2.4m		
<b>For models:</b>	OD10.10, OD10.20, OD12.20, OD20.10, OD20.20, OD6.10		
	1		
<b>GEV No.</b>	379410	<b>Ref. No.</b>	5001015
<b>description</b>	temperature probe thermocouple K (NiCr-Ni) cable silicone probe -50 up to 1150°C cable -50 up to +180°C connection 2-wire thread M10 probe ø3x125mm cable length 1.5m		
<b>For models:</b>	OSG10.10, OSG12.20, OSG20.20, OSG6.10		

<b>GEV No.</b>	379420	<b>Ref. No.</b>	5001016
<b>description</b>	temperature probe thermocouple K (NiCr-Ni) cable silicone probe -50 up to 1150°C cable -50 up to +180°C connection 2-wire thread M10 probe ø3x70mm cable length 0.7m		
<b>For models:</b>	OSG10.10, OSG12.20, OSG20.20, OSG6.10		



<b>GEV No.</b>	379800	<b>Ref. No.</b>	5002100 5002100K 5002101 5016014K 5030618
<b>description</b>	temperature probe thermocouple K (NiCr-Ni) cable silicone probe -50 up to 1150°C cable -50 up to +180°C connection 2-wire thread M5 probe ø4x20mm cable length 3m		
<b>For models:</b>	OEB10.10, OEB10.20, OEB12.20, OEB20.10, OEB20.20, OEB6.10, OEB6.20, OES10.10, OES10.20, OES12.20, OES20.10, OES20.20, OES6.06, OES6.10, OES6.20, OGB10.10, OGB10.20, OGB12.20, OGB20.10, OGB20.20, OGB6.10, OGB6.20, OGS10.10, OGS10.20, OGS12.20, OGS20.10, OGS20.20, OGS6.10, OGS6.20, OS10.10, OS10.20, OS12.20, OS20.10, OS20.20, OS6.10, OSC10.10, OSC10.20, OSC12.20, OSC20.10, OSC20.20, OSC6.10, OSG20.20, OSP10.10, OSP10.20, OSP12.20, OSP20.10, OSP20.20, OSP6.10		
<b>accessories for</b>	379800		
	<b>GEV No.</b>	521012	<b>Ref. No.</b> 6005260
	gasket graphite ED ø 15mm ID ø 5mm thickness 1.2mm Qty 1 pcs		

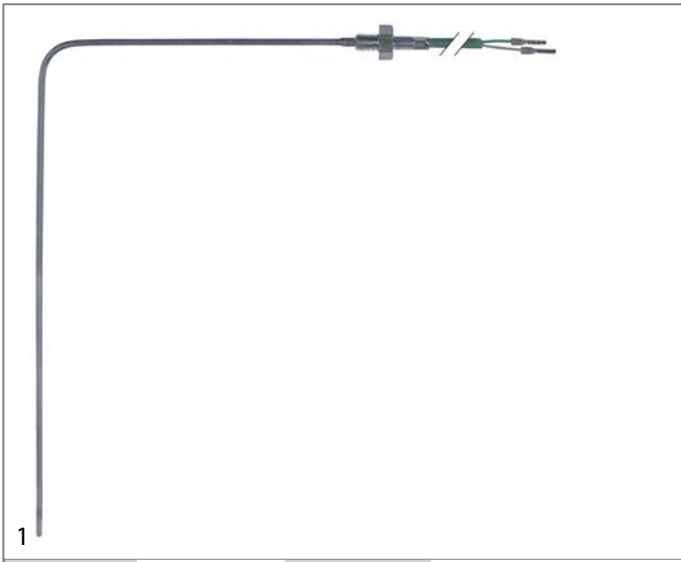

<b>GEV No.</b>	402164	<b>Ref. No.</b>	5002102 5002102K 5030619
<b>description</b>	temperature probe thermocouple K (NiCr-Ni) cable silicone probe -50 up to 1150°C cable -50 up to +180°C connection 2-wire thread M8 probe ø3x130/230mm cable length 2.1m		
<b>For models:</b>	OS10.10, OS10.20, OS12.20, OS20.10, OS20.20, OS6.10, OSC10.10, OSC10.20, OSC12.20, OSC20.10, OSC20.20, OSC6.10, OSP10.10, OSP10.20, OSP12.20, OSP20.10, OSP20.20, OSP6.10		



<b>GEV No.</b>	379536	<b>Ref. No.</b>	5016003
<b>description</b>	temperature probe thermocouple K (NiCr-Ni) cable silicone probe -50 up to 1150°C cable -50 up to +180°C connection 2-wire thread probe ø1.5x230mm cable length 2m		
<b>For models:</b>	OEB20.20, OGB10.10, OGB10.20, OGB12.20, OGB20.10, OGB20.20, OGB6.10, OGB6.20, OGS10.10, OGS10.20, OGS12.20, OGS20.10, OGS20.20, OGS6.10, OGS6.20		



<b>GEV No.</b>	379440	<b>Ref. No.</b>	5002103 5016017
<b>description</b>	temperature probe thermocouple K (NiCr-Ni) cable silicone probe -50 up to 1150°C cable -50 up to +180°C connection 2-wire thread probe ø1.5x35mm cable length 1.6m		
<b>For models:</b>	OS10.20, OS6.10, OSC10.10, OSC10.20, OSC12.20, OSC20.10, OSC20.20, OSC6.10, OSP10.10, OSP10.20, OSP12.20, OSP20.10, OSP20.20, OSP6.10		



<b>GEV No.</b>	379751	<b>Ref. No.</b>	5002104
<b>description</b>	temperature probe thermocouple K (NiCr-Ni) cable silicone probe -50 up to 1150°C cable -50 up to +180°C connection 2-wire thread probe ø1.5x35mm cable length 2.8m		
<b>For models:</b>	OEB10.10, OEB10.20, OEB12.20, OEB20.10, OEB20.20, OEB6.10, OEB6.20, OES10.10, OES10.20, OES12.20, OES20.10, OES20.20, OES6.10, OES6.20, OGB10.10, OGB10.20, OGB12.20, OGB20.10, OGB20.20, OGB6.10, OGB6.20, OS10.10, OS12.20, OS20.10, OS20.20, OSC10.10, OSC12.20, OSC20.10, OSC20.20, OSP10.10, OSP12.20, OSP20.10, OSP20.20		



<b>GEV No.</b>	378655	<b>Ref. No.</b>	5056324
<b>description</b>	temperature probe thermocouple K (NiCr-Ni) probe -50 up to 1150°C cable -50 up to +180°C connection coded plug thread M5 probe ø4x20mm cable length 3.2m		



<b>GEV No.</b>	381488	<b>Ref. No.</b>	5056323
<b>description</b>	temperature probe thermocouple K (NiCr-Ni) probe -50 up to 1150°C cable -50 up to +180°C thread 2-wire cable length 2.3m		



<b>GEV No.</b>	379414	<b>Ref. No.</b>	2219137 5002064
<b>description</b>	temperature probe thermocouple K (NiCr-Ni) probe Sous-Vide cable PTFE probe -50 up to 1150°C cable -50 up to +180°C connection 2-wire thread probe ø1.5x60mm cable length 4m		
<b>For models:</b>	OEB10.10, OEB10.20, OEB12.20, OEB20.10, OEB20.20, OEB6.10, OEB6.20, OES10.10, OES10.20, OES12.20, OES20.10, OES20.20, OES6.10, OES6.20, OGB10.10, OGB10.20, OGB12.20, OGB20.10, OGB20.20, OGB6.10, OGB6.20, OGS10.10, OGS10.20, OGS12.20, OGS20.10, OGS20.20, OGS6.10, OGS6.20		



core probes



<b>GEV No.</b>	379828 <sup>1</sup>	<b>Ref. No.</b>	5002068K
<b>description</b>	core temperature probe 3 point probe cable PTFE probe -40 up to +250°C cable -40 up to +250°C connection 5-wire probe ø4x100mm cable length 4m handle ø 12mm handle length 75mm		

<sup>1</sup> multipoint probe



<b>GEV No.</b>	379428 <sup>1</sup>	<b>Ref. No.</b>	5013001 5013022K 5030638 5030676
<b>description</b>	core temperature probe 3 point probe cable PTFE probe -50 up to 1150°C cable -40 up to +250°C connection 5-wire probe ø3x100mm thread cable length 3m handle ø 11mm handle length 75mm		

<sup>1</sup> multipoint probe



<b>GEV No.</b>	378536	<b>Ref. No.</b>	5056325
<b>description</b>	core temperature probe 4 point probe cable plastic probe -40 up to +250°C cable -40 up to +250°C connection plug probe ø3.5x100mm thread 5/8" cable length 3m handle ø 11mm handle length 75mm		



<b>GEV No.</b>	379103	<b>Ref. No.</b>	5002062 5002062K 5030616
<b>description</b>	core temperature probe Pt100 cable PTFE probe -40 up to +250°C cable -40 up to +250°C connection 2-wire probe ø4x100mm thread cable length 4m handle ø 15mm handle length 85mm		
<b>For models:</b>	HUD10.10, HUD12.20, HUD20.10, HUD20.20, HUD6.10, OD10.10, OD10.20, OD12.20, OD20.10, OD20.20, OD6.10, UG10.10, UG10.20, UG20.10, UG20.20, UG6.10		



<b>GEV No.</b>	379416	<b>Ref. No.</b>	5002066 5002066K
<b>description</b>	core temperature probe Pt100 cable SS corrugated hose probe -40 up to +250°C cable -40 up to +250°C connection 2-wire probe ø3x100mm thread M15x1 cable length 3m handle ø 12mm handle length 85mm		
<b>For models:</b>	OD6.10		



<b>GEV No.</b>	379417	<b>Ref. No.</b>	5002067 5002067K
<b>description</b>	core temperature probe Pt100 cable SS corrugated hose probe -40 up to +250°C cable -40 up to +250°C connection 2-wire probe ø3x100mm thread M15x1.5 cable length 3m handle ø 12mm handle length 85mm		



<b>GEV No.</b>	379858	<b>Ref. No.</b>	5002069 5002069K
<b>description</b>	core temperature probe thermocouple K (NiCr-Ni) 4 point probe		
<b>For models:</b>	OSG10.10, OSG12.20, OSG20.20, OSG6.10		



<b>GEV No.</b>	379139	<b>Ref. No.</b>	5002068
<b>description</b>	core temperature probe thermocouple K (NiCr-Ni) cable PTFE probe -40 up to +250°C cable -40 up to +250°C connection 6-wire probe ø4x100mm thread cable length 2.5m handle ø 15mm handle length 85mm		
<b>For models:</b>	OD10.10, OD10.20, OD12.20, OD20.10, OD20.20, OD6.10, OEB10.10, OEB10.20, OEB12.20, OEB20.10, OEB20.20, OEB6.10, OEB6.20, OES10.10, OES10.20, OES12.20, OES20.10, OES20.20, OES6.10, OES6.20, OGB10.10, OGB10.20, OGB12.20, OGB20.10, OGB20.20, OGB6.10, OGB6.20, OGS10.10, OGS10.20, OGS12.20, OGS20.10, OGS20.20, OGS6.10, OGS6.20, OS10.10, OS10.20, OS12.20, OS20.10, OS20.20, OS6.10, OSC10.10, OSC10.20, OSC12.20, OSC20.10, OSC20.20, OSC6.10, OSG10.10, OSG12.20, OSG20.20, OSG6.10...(Other models you can see in the webshop)		



<b>GEV No.</b>	381458	<b>Ref. No.</b>	5064012
<b>description</b>	probe 1 point probe cable PTFE connection -40 up to +250 cable length 1.04m handle ø 11mm handle length 72mm		



<b>GEV No.</b>	381459	<b>Ref. No.</b>	5064010
<b>description</b>	probe 1 point probe cable PTFE probe -40 up to +250°C connection plug probe ø1.5x60mm handle ø 11mm handle length 70mm		

accessories

plugs/bushes



<b>GEV No.</b>	378653	<b>Ref. No.</b>	5064011
<b>description</b>	female connector 2-pole max. 9A protection IP50 chrome-plated brass		



# electronics

## electronics accessories



1

<b>GEV No.</b>	560416	<b>Ref. No.</b>	6005054
<b>description</b>	plain washer ID ø 4mm ED ø 9.6mm thickness 2mm silicone Qty 1 pcs		
<b>For models:</b>	OD10.10, OD10.20, OD12.20, OD20.10, OD20.20, OD6.10, OEB6.10, OES6.10		

## frequency converters



1

<b>GEV No.</b>	403904	<b>Ref. No.</b>	5056374
<b>description</b>	frequency converter 200-240V 50/60 L 131mm W 72mm H 143mm		

## PCBs



1

<b>GEV No.</b>	403686	<b>Ref. No.</b>	5019301
<b>description</b>	control 5010 IDM module P3+mini 5010 IDM module P3+mini		

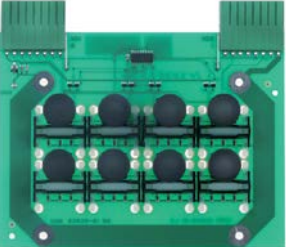





1

<b>GEV No.</b>	404007	<b>Ref. No.</b>	5019105 5019304
<b>description</b>	control PCB combi-steamer OEB10.10 control 5010		
<b>For models:</b>	OEB10.10, OEB10.20, OEB12.20, OEB20.10, OEB20.20, OEB6.10, OEB6.20, OES10.10, OES10.20, OES12.20, OES20.10, OES20.20, OES6.10, OES6.20, OGB10.10, OGB10.20, OGB12.20, OGB20.10, OGB20.20, OGB6.10, OGB6.20, OGS10.10, OGS10.20, OGS12.20, OGS20.10, OGS20.20, OGS6.10, OGS6.20		



1

<b>GEV No.</b>	402882	<b>Ref. No.</b>	5019100 5019306 5019406 5019418 5019420	
<b>description</b>	control PCB combi-steamer OEx xx.xx L 280mm W 100mm V5.19			
<b>For models:</b>	OEB10.10, OEB10.20, OEB12.20, OEB20.10, OEB20.20, OEB6.10, OEB6.20, OES10.10, OES10.20, OES12.20, OES20.10, OES20.20, OES6.06, OES6.10, OES6.20, OGB10.10, OGB10.20, OGB12.20, OGB20.10, OGB20.20, OGB6.10, OGB6.20, OGS10.10, OGS10.20, OGS12.20, OGS20.10, OGS20.20, OGS6.10, OGS6.20			
<b>accessories for</b>	402882			
	<b>GEV No.</b>	402589	<b>Ref. No.</b>	5019101 5019300 CM5019300
	keypad PCB combi-steamer P3-devices L 337mm W 132mm V5.19 buttons 14			
	<b>GEV No.</b>	403078	<b>Ref. No.</b>	5019011
	programmer suitable for CONVOTHERM P3-devices incl. SD Carte and Software			
	<b>GEV No.</b>	403686	<b>Ref. No.</b>	5019301
	control 5010 IDM module P3+mini 5010 IDM module P3+mini			



1

<b>GEV No.</b>	403794	<b>Ref. No.</b>	5019150
<b>description</b>	control PCB for combi-steamer OES6.06 Mini P3 L 465mm W 95mm model ST5020-BM V5.19		
<b>For models:</b>	OES6.06		



1

<b>GEV No.</b>	402587	<b>Ref. No.</b>	5009017
<b>description</b>	control PCB L 320mm W 118mm cable length 500mm supply 5/12VDC		
<b>For models:</b>	OD10.10, OD10.20, OD12.20, OD20.10, OD20.20, OD6.10		



1

<b>GEV No.</b>	402588	<b>Ref. No.</b>	5009303
<b>description</b>	keypad PCB combi-steamer OSx xx.xx L 322mm W 117mm V5.19 buttons 11		
<b>For models:</b>	OS10.10, OS10.20, OS12.20, OS20.10, OS20.20, OS6.10, OSC10.10, OSC10.20, OSC12.20, OSC20.10, OSC20.20, OSC6.10, OSP10.10, OSP10.20, OSP12.20, OSP20.10, OSP20.20, OSP6.10		





1

<b>GEV No.</b>	402910	<b>Ref. No.</b>	5009310 5009317
<b>description</b>	PCB		
<b>For models:</b>	OS10.10, OS10.20, OS12.20, OS20.10, OS20.20, OS6.10, OSC10.10, OSC10.20, OSC12.20, OSC20.10, OSC20.20, OSC6.10, OSG10.10, OSG12.20, OSG20.20, OSG6.10, OSP10.10, OSP10.20, OSP12.20, OSP20.10, OSP20.20, OSP6.10		



1

<b>GEV No.</b>	402589	<b>Ref. No.</b>	5019101 5019300 CM5019300
<b>description</b>	keypad PCB combi-steamer P3-devices L 337mm W 132mm V5.19 buttons 14		
<b>For models:</b>	OEB10.10, OEB10.20, OEB12.20, OEB20.10, OEB20.20, OEB6.10, OEB6.20, OES10.10, OES10.20, OES12.20, OES20.10, OES20.20, OES6.10, OES6.20, OGB10.10, OGB10.20, OGB12.20, OGB20.10, OGB20.20, OGB6.10, OGB6.20, OGS10.10, OGS10.20, OGS12.20, OGS20.10, OGS20.20, OGS6.10, OGS6.20		
<b>accessories for</b>	402589		
	<b>GEV No.</b>	402882	<b>Ref. No.</b> 5019100 5019306 5019406 5019418 5019420
control PCB combi-steamer OEx xx.xx L 280mm W 100mm V5.19			



1

<b>GEV No.</b>	402207	<b>Ref. No.</b>	5009305
<b>description</b>	PCB combi-steamer OS10.10		
<b>For models:</b>	OS10.10, OS10.20, OS12.20, OS20.10, OS20.20, OS6.10, OSC10.10, OSC10.20, OSC12.20, OSC20.10, OSC20.20, OSC6.10, OSG10.10, OSG12.20, OSG20.20, OSG6.10, OSP10.10, OSP10.20, OSP12.20, OSP20.10, OSP20.20, OSP6.10		



1

<b>GEV No.</b>	402208	<b>Ref. No.</b>	5009300
<b>description</b>	PCB combi-steamer OSx xx.xx V5.19		
<b>For models:</b>	OS10.10, OS10.20, OS12.20, OS20.10, OS20.20, OS6.10, OSC10.10, OSC10.20, OSC12.20, OSC20.10, OSC20.20, OSC6.10, OSG10.10, OSG12.20, OSG20.20, OSG6.10, OSP10.10, OSP10.20, OSP12.20, OSP20.10, OSP20.20, OSP6.10		

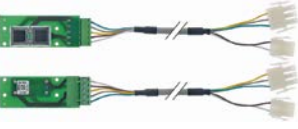

1

<b>GEV No.</b>	403870	<b>Ref. No.</b>	5056362
<b>description</b>	keypad PCB for combi-steamer CONVOTHERM 4 with cable ON-OFF		

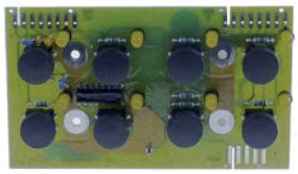

1

<b>GEV No.</b>	402879	<b>Ref. No.</b>	5009302
<b>description</b>	keypad PCB L 118mm W 69mm suitable for convection oven buttons 8		
<b>For models:</b>	OS10.10, OS10.20, OS12.20, OS20.10, OS20.20, OS6.10, OSC10.10, OSC10.20, OSC12.20, OSC20.10, OSC20.20, OSC6.10, OSG10.10, OSG12.20, OSG20.20, OSG6.10, OSP10.10, OSP10.20, OSP12.20, OSP20.10, OSP20.20, OSP6.10		



1

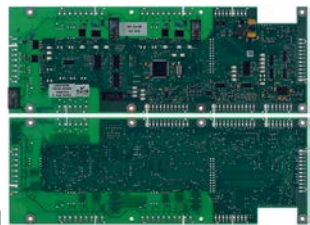

<b>GEV No.</b>	403819	<b>Ref. No.</b>	5019103 5019302 5019402
<b>description</b>	PCB for combi-steamer L 280mm W 100mm suitable for CONVOTHERM		
<b>For models:</b>	OGB10.10, OGB10.20, OGB12.20, OGB20.10, OGB20.20, OGB6.10, OGB6.20, OGS10.10, OGS10.20, OGS12.20, OGS20.10, OGS20.20, OGS6.10, OGS6.20		

2



<b>GEV No.</b>	401877	<b>Ref. No.</b>	5009005 5009006 5009007 5009008 5009029 5009029K
<b>description</b>	power PCB combi-steamer OD10.10 L 440mm W 95mm suitable for CONVOTHERM with mounting accessories		
<b>For models:</b>	OD10.10, OD10.20, OD12.20, OD20.10, OD20.20, OD6.10		

1



<b>GEV No.</b>	402586	<b>Ref. No.</b>	5009018
<b>description</b>	power PCB L 252mm W 120mm model 28755329 230V 0.1A voltage AC		
<b>For models:</b>	OD10.10, OD10.20, OD12.20, OD20.10, OD20.20, OD6.10		

1



<b>GEV No.</b>	402637	<b>Ref. No.</b>	2619973 5009301 5019154 5019305
<b>description</b>	power supply combi-steamer conversion kit		
<b>For models:</b>	OEB10.10, OEB10.20, OEB12.20, OEB20.10, OEB20.20, OEB6.10, OEB6.20, OES10.10, OES10.20, OES12.20, OES20.10, OES20.20, OES6.06, OES6.10, OES6.20, OGB10.10, OGB10.20, OGB12.20, OGB20.10, OGB20.20, OGB6.10, OGB6.20, OGS10.10, OGS10.20, OGS12.20, OGS20.10, OGS20.20, OGS6.10, OGS6.20, OS10.10, OS10.20, OS12.20, OS20.10, OS20.20, OS6.10, OSC10.10, OSC10.20, OSC12.20, OSC20.10, OSC20.20, OSC6.10, OSG10.10, OSG12.20, OSG20.20, OSG6.10, OSP10.10, OSP10.20, OSP12.20, OSP20.10, OSP20.20...(Other models you can see in the webshop)		

keypads

front foils

1



<b>GEV No.</b>	403813	<b>Ref. No.</b>	6009103
<b>description</b>	front foil combi-steamer CONVOTHERM L 107mm W 30mm		

1



<b>GEV No.</b>	402943	<b>Ref. No.</b>	6009101
<b>description</b>	front foil red suitable for CONVOTHERM L 108mm W 88mm		

1



<b>GEV No.</b>	402952	<b>Ref. No.</b>	6009235
<b>description</b>	front foil red suitable for CONVOTHERM L 135mm W 785mm		



## solenoid valves











### solenoid valves (water)







MÜLLER

medium temperature: 90°C  
duty cycle: 100%



1

<b>GEV No.</b>	370003	<b>Ref. No.</b>	5001056
<b>description</b>	solenoid valve double angled 230VAC inlet 3/4" outlet 14.5mm DN10 t.max. 90°C duty cycle 100% MÜLLER		
<b>For models:</b>	HUD10.10, HUD12.20, HUD20.10, HUD20.20, HUD6.10, OD10.10, OD10.20, OD12.20, OD20.10, OD20.20, OD6.10, OS10.10, OS10.20, OS12.20, OS20.10, OS20.20, OS6.10, OSC10.10, OSC10.20, OSC12.20, OSC20.10, OSC20.20, OSC6.10, OSP10.10, OSP10.20, OSP12.20, OSP20.10, OSP20.20, OSP6.10		
<b>spare parts for</b>	370003		
	<b>GEV No.</b>	370128	<b>Ref. No.</b> 5001057
	solenoid valve body double angled inlet 3/4" outlet 14.5mm DN10 t.max. 90°C duty cycle 100% MÜLLER 230V double-ways		
	<b>GEV No.</b>	371002	<b>Ref. No.</b> —
	solenoid valve holder MÜLLER flange support		
	<b>GEV No.</b>	371009	<b>Ref. No.</b> 5001074
	compression spring for solenoid coil		
	<b>GEV No.</b>	371011	<b>Ref. No.</b> —
	spare parts kit membrane with long star star hight 8mm MÜLLER		
	<b>GEV No.</b>	371017	<b>Ref. No.</b> 5001066
	solenoid coil MÜLLER 220-240VAC 50-60Hz connection male faston 6.3mm		
	<b>GEV No.</b>	371122	<b>Ref. No.</b> —
	solenoid valve filter ø 19mm H 10mm suitable for MÜLLER		
	<b>GEV No.</b>	501161	<b>Ref. No.</b> —
	tap head for solenoid valve holder for solenoid coils		
<b>accessories for</b>	370003		
	<b>GEV No.</b>	371010	<b>Ref. No.</b> —
	solenoid coil 230VAC connection with cable cable length 2000mm		
	<b>GEV No.</b>	371037	<b>Ref. No.</b> —
	solenoid coil 24VAC 50/60Hz connection male faston 6.3mm		
	<b>GEV No.</b>	371038	<b>Ref. No.</b> —
	solenoid coil 230VAC connection appliance plug		

	<b>GEV No.</b>	370001	<b>Ref. No.</b>	5001058
	<b>description</b>	solenoid valve single angled 230VAC inlet 3/4" outlet 14.5mm DN10 t.max. 90°C duty cycle 100% MÜLLER		
	<b>For models:</b>	OD10.10, OD10.20, OD12.20, OD20.10, OD20.20, OD6.10, OS10.10, OS10.20, OS12.20, OS20.10, OS20.20, OS6.10, OSC10.10, OSC10.20, OSC12.20, OSC20.10, OSC20.20, OSC6.10, OSP10.10, OSP10.20, OSP12.20, OSP20.10, OSP20.20, OSP6.10		
	<b>spare parts for</b>	370001		
	<b>GEV No.</b>	370126	<b>Ref. No.</b>	—
	solenoid valve body single angled inlet 3/4" outlet 14.5mm DN10 t.max. 90°C duty cycle 100% MÜLLER plastic			
	<b>GEV No.</b>	371002	<b>Ref. No.</b>	—
	solenoid valve holder MÜLLER flange support			
	<b>GEV No.</b>	371009	<b>Ref. No.</b>	5001074
	compression spring for solenoid coil			
	<b>GEV No.</b>	371011	<b>Ref. No.</b>	—
	spare parts kit membrane with long star star hight 8mm MÜLLER			
	<b>GEV No.</b>	371017	<b>Ref. No.</b>	5001066
	solenoid coil MÜLLER 220-240VAC 50-60Hz connection male faston 6.3mm			
	<b>GEV No.</b>	371122	<b>Ref. No.</b>	—
	solenoid valve filter ø 19mm H 10mm suitable for MÜLLER			
	<b>GEV No.</b>	501161	<b>Ref. No.</b>	—
	tap head for solenoid valve holder for solenoid coils			
<b>accessories for</b>	370001			
	<b>GEV No.</b>	371010	<b>Ref. No.</b>	—
	solenoid coil 230VAC connection with cable cable length 2000mm			
	<b>GEV No.</b>	371037	<b>Ref. No.</b>	—
	solenoid coil 24VAC 50/60Hz connection male faston 6.3mm			
	<b>GEV No.</b>	371038	<b>Ref. No.</b>	—
	solenoid coil 230VAC connection appliance plug			





<b>1</b>			
<b>GEV No.</b>	370000	<b>Ref. No.</b>	5001062
<b>description</b>	solenoid valve triple angled 230VAC inlet 3/4" outlet 14.5mm DN10 t.max. 90°C duty cycle 100% MÜLLER		
<b>For models:</b>	OS10.10, OS10.20, OS12.20, OS20.10, OS20.20, OS6.10, OSC10.10, OSC10.20, OSC12.20, OSC20.10, OSC20.20, OSC6.10, OSP10.10, OSP10.20, OSP12.20, OSP20.10, OSP20.20, OSP6.10		

<b>spare parts for</b>	370000		
------------------------	--------	--	--

	<b>GEV No.</b>	370130	<b>Ref. No.</b>	—
	solenoid valve body triple angled inlet 3/4" outlet 14.5mm DN10 t.max. 90°C duty cycle 100% MÜLLER 230V triple-ways			

	<b>GEV No.</b>	371002	<b>Ref. No.</b>	—
	solenoid valve holder MÜLLER flange support			

	<b>GEV No.</b>	371009	<b>Ref. No.</b>	5001074
	compression spring for solenoid coil			

	<b>GEV No.</b>	371011	<b>Ref. No.</b>	—
	spare parts kit membrane with long star star high 8mm MÜLLER			

	<b>GEV No.</b>	371017	<b>Ref. No.</b>	5001066
	solenoid coil MÜLLER 220-240VAC 50-60Hz connection male faston 6.3mm			

	<b>GEV No.</b>	371122	<b>Ref. No.</b>	—
	solenoid valve filter ø 19mm H 10mm suitable for MÜLLER			

	<b>GEV No.</b>	501161	<b>Ref. No.</b>	—
	tap head for solenoid valve holder for solenoid coils			

<b>accessories for</b>	370000		
------------------------	--------	--	--

	<b>GEV No.</b>	371010	<b>Ref. No.</b>	—
	solenoid coil 230VAC connection with cable cable length 2000mm			

	<b>GEV No.</b>	371037	<b>Ref. No.</b>	—
	solenoid coil 24VAC 50/60Hz connection male faston 6.3mm			

	<b>GEV No.</b>	371038	<b>Ref. No.</b>	—
	solenoid coil 230VAC connection appliance plug			

spare parts and accessories

valve bodies

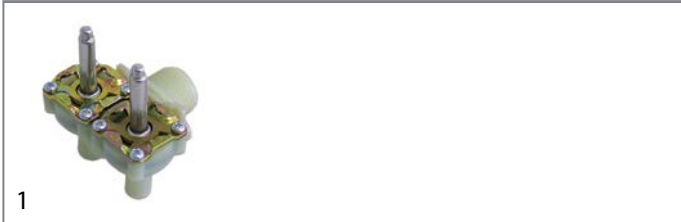

<b>1</b>			
<b>GEV No.</b>	370128	<b>Ref. No.</b>	5001057
<b>description</b>	solenoid valve body double angled inlet 3/4" outlet 14.5mm DN10 t.max. 90°C duty cycle 100% MÜLLER 230V double-ways		
<b>For models:</b>	HUD10.10, HUD12.20, HUD20.10, HUD20.20, HUD6.10, OD10.10, OD10.20, OD12.20, OD20.10, OD20.20, OD6.10		

solenoid coils

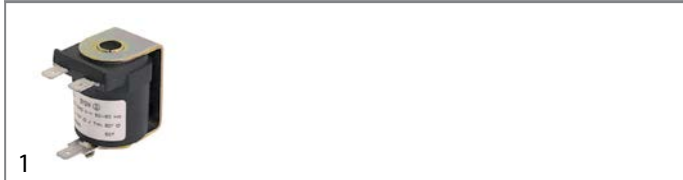

<b>1</b>			
<b>GEV No.</b>	371017	<b>Ref. No.</b>	5001066
<b>description</b>	solenoid coil MÜLLER 220-240VAC 50-60Hz connection male faston 6.3mm		
<b>For models:</b>	HUD10.10, HUD12.20, HUD20.10, HUD20.20, HUD6.10, OD10.10, OD10.20, OD12.20, OD20.10, OD20.20, OD6.10		

miscellaneous

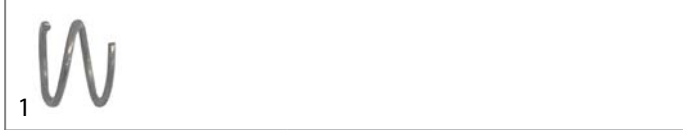

<b>1</b>			
<b>GEV No.</b>	371009	<b>Ref. No.</b>	5001074
<b>description</b>	compression spring for solenoid coil		
<b>For models:</b>	HUD10.10, HUD12.20, HUD20.10, HUD20.20, HUD6.10, OD10.10, OD10.20, OD12.20, OD20.10, OD20.20, OD6.10		

ROBERTSHAW/INVENSYS

medium temperature: 90°C 90°C 60°C  
 ambient temperature: 60°C 25°C 60°C  
 duty cycle: 40% 100% 100%



<b>1</b>			
<b>GEV No.</b>	372019	<b>Ref. No.</b>	5011050
<b>description</b>	solenoid valve double angled 230VAC inlet 3/4" outlet 11.5mm DN10 EATON (INVENSYS)		
<b>For models:</b>	OES6.06		

solenoid valves with reducers

single

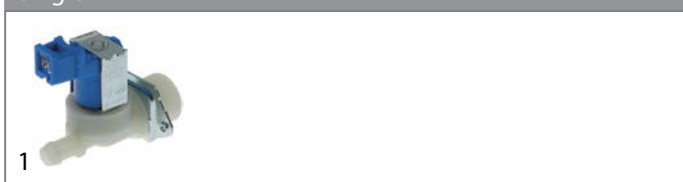



<b>1</b>			
<b>GEV No.</b>	372005	<b>Ref. No.</b>	5056378
<b>description</b>	solenoid valve single straight 200-240VAC inlet 3/4 outlet 10.5 t.max. 90°C duty cycle 100% ROBERTSHAW S02810/00 plastic		



			
<b>GEV No.</b>	371145	<b>Ref. No.</b>	5001059
<b>description</b>	solenoid valve single straight 230VAC inlet 3/4" outlet 11.5mm input 12l/min		
<b>For models:</b>	OD10.10, OD10.20, OD12.20, OD20.20, OD6.10, OEB10.10, OEB10.20, OEB12.20, OEB20.10, OEB20.20, OEB6.10, OEB6.20, OES10.10, OES10.20, OES12.20, OES20.10, OES20.20, OES6.10, OES6.20, OGB10.10, OGB10.20, OGB12.20, OGB20.10, OGB20.20, OGB6.10, OGB6.20, OGS10.10, OGS10.20, OGS12.20, OGS20.10, OGS20.20, OGS6.10, OGS6.20, OSG10.10, OSG12.20, OSG6.10		

2-fold			
			
<b>GEV No.</b>	374108	<b>Ref. No.</b>	5056379
<b>description</b>	solenoid valve double angled 230VAC inlet 3/4" outlet 10mm t.max. 90°C ROBERTSHAW plastic connection coded		

			
<b>GEV No.</b>	372000	<b>Ref. No.</b>	5001080
<b>description</b>	solenoid valve double straight 230VAC inlet 3/4" outlet 11.5mm input 9l/min 10 EATON (INVENSYS)		
<b>For models:</b>	OD10.10, OD10.20, OD12.20, OD20.20, OD6.10, OEB10.10, OEB10.20, OEB12.20, OEB20.10, OEB20.20, OEB6.10, OEB6.20, OES10.10, OES10.20, OES12.20, OES20.10, OES20.20, OES6.10, OES6.20, OGB10.10, OGB10.20, OGB12.20, OGB20.10, OGB20.20, OGB6.10, OGB6.20, OGS10.10, OGS10.20, OGS12.20, OGS20.10, OGS20.20, OGS6.10, OGS6.20, OSG10.10, OSG12.20, OSG20.20, OSG6.10		

RPE			
			
<b>GEV No.</b>	374067	<b>Ref. No.</b>	5011013
<b>description</b>	solenoid valve single straight 230VAC inlet 3/8" outlet 3/8" input/output 12l/min DN10 t.max. 25/60/90°C duty cycle 100% RPE 4115NC230V plastic		

solenoid valves with reducers			
single			
			
<b>GEV No.</b>	370744	<b>Ref. No.</b>	5011020 5030489
<b>description</b>	solenoid valve single straight 230VAC inlet 3/4" outlet 11mm input 10-20l/min t.max. 60°C RPE plastic flow regulating valve inlet white male faston 6.3mm		











TP			
			
<b>GEV No.</b>	370025	<b>Ref. No.</b>	5011000
<b>description</b>	solenoid valve triple straight 230VAC inlet 3/4" outlet 11.5mm DN10 TP		
<b>For models:</b>	OEB10.10, OEB10.20, OEB12.20, OEB20.10, OEB20.20, OEB6.10, OEB6.20, OES10.10, OES10.20, OES12.20, OES20.10, OES20.20, OES6.10, OES6.20, OGB10.10, OGB10.20, OGB12.20, OGB20.10, OGB20.20, OGB6.10, OGB6.20, OGS10.10, OGS10.20, OGS12.20, OGS20.10, OGS20.20, OGS6.10, OGS6.20		
<b>spare parts for</b>	370025		
		<b>GEV No.</b>	371013
		<b>Ref. No.</b>	—
<b>accessories for</b>	370025		
		<b>GEV No.</b>	371220
		<b>Ref. No.</b>	—
		<b>GEV No.</b>	371221
		<b>Ref. No.</b>	—
		<b>GEV No.</b>	371222
		<b>Ref. No.</b>	—
		<b>GEV No.</b>	371223
		<b>Ref. No.</b>	—
		<b>GEV No.</b>	371224
		<b>Ref. No.</b>	—
		<b>GEV No.</b>	371225
		<b>Ref. No.</b>	—
		<b>GEV No.</b>	371226
		<b>Ref. No.</b>	—
		<b>GEV No.</b>	371230
		<b>Ref. No.</b>	—
		<b>GEV No.</b>	371231
		<b>Ref. No.</b>	—



Table continues overleaf





accessories for		370025	
	GEV No.	371232	Ref. No. —
reducer TP flow rate 0.5l/min orange tolerance ±25%			
	GEV No.	371233	Ref. No. —
reducer TP flow rate 0.8l/min white tolerance ±25%			
	GEV No.	371234	Ref. No. —
reducer TP flow rate 1l/min light blue tolerance ±25%			
	GEV No.	371235	Ref. No. —
reducer TP flow rate 1.2l/min brown tolerance ±25%			
	GEV No.	371236	Ref. No. —
reducer TP flow rate 1.5l/min light brown tolerance ±25%			
	GEV No.	371237	Ref. No. —
reducer TP flow rate 2.5l/min yellow tolerance ±25%			
	GEV No.	371238	Ref. No. —
reducer TP flow rate 3.4l/min dark green tolerance ±25%			
	GEV No.	371239	Ref. No. —
reducer TP flow rate 5l/min black tolerance ±25%			
	GEV No.	371240	Ref. No. —
reducer TP flow rate 8l/min blue tolerance ±20%			

## pressure switches

for combi-steamers

	1		
GEV No.	541806	Ref. No.	5009061 5009063
description	pressure control ø 38mm pressure range 0.2-3.0bar connection 1/8" 250V 10A GP600 pressure connection 1/8"		
For models:	OD10.10, OD10.20, OD12.20, OD20.20, OD6.10, OES10.20, OES12.20, OES6.06, OSG10.10, OSG12.20, OSG20.20, OSG6.10		
accessories for	541806		
	GEV No.	541814	Ref. No. —
protection cap for pressure switch EPDM XP600			

	1		
GEV No.	541779	Ref. No.	2619860 5013052
description	pressure control ø 45mm pressure range 0-120mbar for combi-steamer suitable for CONVOTHERM p max 4bar		

	1		
GEV No.	542375	Ref. No.	5013053 5056352
description	pressure control ø 45mm pressure range 13mbar pressure connection ø 12mm for combi-steamer CONVOTHERM suitable for C4 Serie 250V 6A p max 4bar ambient temperature max. 85°C preset at 0.013bar		

	1		
GEV No.	542384	Ref. No.	2629926
description	pressure control ø 45mm pressure range 150mbar for combi-steamer CONVOTHERM CONVOClean p max 4bar		

	1		
GEV No.	541833	Ref. No.	2619149 5013051
description	pressure control ø 45mm pressure range 200mbar for cleaning system connection 1/4" suitable for CONVOTHERM p max 4bar preset at 0.2bar pressure connection 1/4"		
For models:	OEB10.10, OEB10.20, OEB12.20, OEB20.10, OEB20.20, OEB6.10, OEB6.20, OES10.10, OES10.20, OES12.20, OES20.10, OES20.20, OES6.10, OES6.20, OGB10.10, OGB10.20, OGB12.20, OGB20.10, OGB20.20, OGB6.10, OGB6.20, OGS10.10, OGS10.20, OGS12.20, OGS20.10, OGS20.20, OGS6.10, OGS6.20		

1

<b>GEV No.</b>	541642	<b>Ref. No.</b>	2611026 2611504 5013050
<b>description</b>	pressure control ø 45mm pressure range 80mbar connection 12mm pressure connection 12mm		
<b>For models:</b>	OS10.10, OSP10.10, OSP10.20, OSP12.20, OSP20.10, OSP20.20, OSP6.10		

## electrodes



1

<b>GEV No.</b>	400076	<b>Ref. No.</b>	5009062
<b>description</b>	level electrode 1/2" total length 190mm probe L 125/155mm insulated probe length 113mm connection bullet connector		
<b>For models:</b>	HUD6.10, OD10.10, OD10.20, OD6.10, OS10.10, OS6.10, OSC10.10, OSC20.10, OSC6.10, OSP10.10, OSP6.10		



1

<b>GEV No.</b>	400075	<b>Ref. No.</b>	5009065
<b>description</b>	level electrode 1/2" total length 270mm probe L 185/235mm insulated probe length 113mm connection bullet connector		
<b>For models:</b>	HUD10.10, HUD12.20, HUD20.10, HUD20.20, OD10.10, OD10.20, OD12.20, OD20.10, OD20.20, OS10.20, OS12.20, OS20.10, OS20.20, OSC10.10, OSC10.20, OSC12.20, OSC20.10, OSC20.20, OSP10.10, OSP10.20, OSP12.20, OSP20.10, OSP20.20		



1

<b>GEV No.</b>	400216	<b>Ref. No.</b>	5009068
<b>description</b>	level electrode 1/8" probe L 130mm insulated probe length 114mm		
<b>For models:</b>	OD10.10, OD6.10		



1

<b>GEV No.</b>	400219	<b>Ref. No.</b>	5009067
<b>description</b>	level electrode probe L 235mm		



1

<b>GEV No.</b>	403752	<b>Ref. No.</b>	5019003
<b>description</b>	level electrode total length 190mm probe L 130/160mm insulated probe length 98mm with flange ø 3mm		



1

<b>GEV No.</b>	400218	<b>Ref. No.</b>	5009069
<b>description</b>	level electrode with thread probe L 190mm		

## flow meters and flow sensors

### flow sensors



1

<b>GEV No.</b>	403753	<b>Ref. No.</b>	5056377
<b>description</b>	flow meter inlet ø 10 outlet ø 10 L 68mm		

## fans

### axial fans

#### ebm-papst



1

<b>GEV No.</b>	601121 <sup>1</sup>	<b>Ref. No.</b>	5008068
<b>description</b>	axial fan L 119mm W 119mm H 38mm 12VDC 4.5W bearing ball bearing manuf. no. 4182NX metal connection male faston 2.8mm ebm-papst fan wheel ø 110mm temp.-resist. 75°C		
<b>For models:</b>	OD10.10, OD10.20, OD12.20, OD20.10, OD20.20, OD6.10, OS10.10, OS10.20, OS12.20, OS20.10, OS20.20, OS6.10, OSC10.10, OSC10.20, OSC12.20, OSC20.10, OSC20.20, OSC6.10, OSP10.10, OSP10.20, OSP12.20, OSP20.10, OSP20.20, OSP6.10		

<sup>1</sup>with ball bearings



1

<b>GEV No.</b>	601120 <sup>1</sup>	<b>Ref. No.</b>	5008065
<b>description</b>	axial fan L 92mm W 92mm H 25mm 12VDC 0.8W bearing ball bearing manuf. no. 3412 plastic connection cable 1600mm ebm-papst fan wheel ø 85mm temp.-resist. 75°C		
<b>For models:</b>	OD10.10, OD6.10		
<b>accessories for</b>	601120		
	<b>GEV No.</b>	691103	<b>Ref. No.</b> —
	guard ø 90mm mounting distance 83mm for axial fan 92mm		

<sup>1</sup>with ball bearings

import



1

<b>GEV No.</b>	601161 <sup>1</sup>	<b>Ref. No.</b>	5018023 5018040
<b>description</b>	axial fan L 119mm W 119mm H 38mm 12VDC 6.3W bearing ball bearing connection cable plastic ADDA fan wheel ø 110mm temp.-resist. 70°C		

<sup>1</sup>with ball bearings



1

<b>GEV No.</b>	602154	<b>Ref. No.</b>	5056318
<b>description</b>	axial fan L 120mm W 120mm H 38mm 12VDC 6.7W bearing ball bearing manuf. no. PMD1212PMB3-A cable length 1500mm SUNON suitable for CONVOTHERM 4 fan wheel ø 110mm housing plastic		



1

<b>GEV No.</b>	601747 <sup>1</sup>	<b>Ref. No.</b>	2118786
<b>description</b>	axial fan L 92mm W 92mm H 25mm 12VDC 2.16W bearing ball bearing connection cable 300mm SUNON		
<b>For models:</b>	OE56.06		

<sup>1</sup>with ball bearings

hot air motors



1

<b>GEV No.</b>	500931	<b>Ref. No.</b>	5008051 5008051K 5008054 5008054K 5030636
<b>description</b>	fan motor 0.32kW L1 200mm L2 80mm D1 ø 14mm 1,5/0,87A at 50Hz 200-240/346-415V at 60Hz 200-254/346-440V at 50Hz 1400rpm at 60Hz 1700rpm type L7BC4D-675		
<b>For models:</b>	AR100, AR108, AR28, AR40, AR50, AR54, AR72, HUD10.10, HUD12.20, HUD20.10, HUD20.20, HUD6.10, OD10.10, OD10.20, OD12.20, OD20.10, OD20.20, OD6.10, UG10.10, UG20.10, UG20.20, UG6.10		

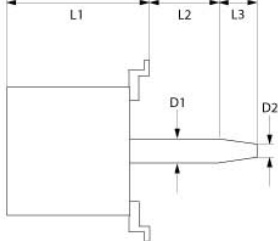
1

<b>GEV No.</b>	601719	<b>Ref. No.</b>	5008036 5008036K 5008049
<b>description</b>	fan motor 200-240/346-415V 200-254/346-480V 3 phase 50/60Hz 0.4/0.68kW 1420/1700rpm speeds 1 L1 152mm L2 44mm L3 54mm ø 125mm 1.2/2.1A at 50Hz 1420rpm at 60Hz 1720rpm type L9Cw4D2-450 D1 ø 15mm D2 ø 14mm		
<b>For models:</b>	OD10.10, OD10.20, OD12.20, OD20.10, OD20.20, OD6.10, OS10.10, OS10.20, OS12.20, OS20.10, OS20.20, OS6.10, OSC10.10, OSC10.20, OSC12.20, OSC20.10, OSC20.20, OSC6.10, OSP10.10, OSP10.20, OSP12.20, OSP20.10, OSP20.20, OSP6.10		

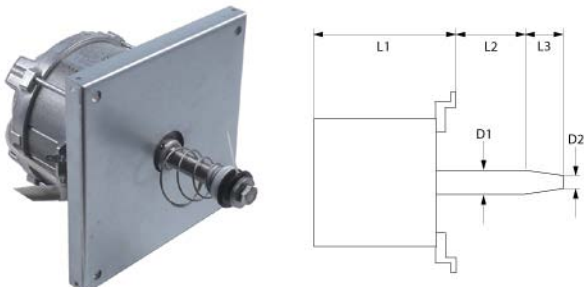

1

<b>GEV No.</b>	601720	<b>Ref. No.</b>	2617286 5018019 5018021
<b>description</b>	fan motor 200-240/346-415V 200-254/346-480V 3 phase 50/60Hz 0.6kW 1380/1650rpm speeds 1 L1 151mm L2 47mm L3 37mm M10x1.5 2.8/1.6A power input 820W type L9Fw4D-605 D1 ø 17mm D2 ø 13.5mm set		
<b>For models:</b>	OEB10.10, OEB20.10, OEB6.10, OEB6.20, OES10.10, OES20.10, OES6.10, OES6.20, OGB10.10, OGB20.10, OGB6.10, OGB6.20, OGS10.10, OGS20.10, OGS6.10, OGS6.20		
<b>spare parts for</b>	601720		
	<b>GEV No.</b>	510686	<b>Ref. No.</b> 6005079
	gasket set for fan motor ID ø 15mm		





1

<b>GEV No.</b>	602147	<b>Ref. No.</b>	2617287 5018020 5018022
<b>description</b>	fan motor 200-240/346-415V 200-254/346-480V 3 phase 50/60Hz 1.15kW 1410/1700rpm speeds 1 L1 200mm L2 60mm L3 38mm M10 IT 4.0/2.3A at 50Hz 200-240/346-415V at 60Hz 200-254/346-480V at 50Hz 1410rpm at 60Hz 1700rpm type L9FGw4D-607 D1 ø 17mm D2 ø 13.5mm combi-steamer CONVOTHERM series P3 model 10.20/12.20/20.20 with mounting accessories mounting distance 177mm mounting ø 9mm		
<b>For models:</b>	OEB10.20, OEB12.20, OEB20.20, OES10.20, OES12.20, OES20.20, OGB10.20, OGB12.20, OGB20.20, OGS10.20, OGS12.20, OGS20.20		



1

<b>GEV No.</b>	501576	<b>Ref. No.</b>	5056347
<b>description</b>	fan motor 215-320V 3 phase 50Hz 0.35kW 1430rpm L1 140mm L2 49mm L3 35mm 1.6-1.65A type HANNING no. V3A145-040P0035-015-002OS0-819 D1 ø 17mm D2 ø 12.5mm		
<b>spare parts for</b>	501576		
	<b>GEV No.</b>	694646	<b>Ref. No.</b> 2617295
	shaft sealing set for hot air motors		



1

<b>GEV No.</b>	602138	<b>Ref. No.</b>	2625108 5018057
<b>description</b>	fan motor 230/400V 3 phase 50/60Hz 0.15kW 2740/3270rpm L1 85mm L2 58mm L3 12mm ø 123mm shaft flat length 23mm M5 0.8A type V3A120-025P0015-036-001OS0-841 D1 ø 8mm D2 ø 8x6mm with fixing kit HANNING for CONVOTHERM model OES mini mounting distance 100mm		



1

<b>GEV No.</b>	602027	<b>Ref. No.</b>	2618802
<b>description</b>	fan motor 230V 1 phase 50/60Hz 0.12kW 2800/3400rpm L1 86mm L2 56mm L3 10mm ø 135mm shaft flat length 20.8mm M5 0.8A suitable capacitor 5µF compact type V1A120-025P0012-036-001OS0-840 D1 ø 8mm D2 ø 4.9mm		
<b>For models:</b>	OES6.06		
<b>spare parts for</b>	602027		
	<b>GEV No.</b>	694800	<b>Ref. No.</b> 2618801
	engine shaft gasket ø 18mm hole ø 8mm Mini series Qty 1 pcs		

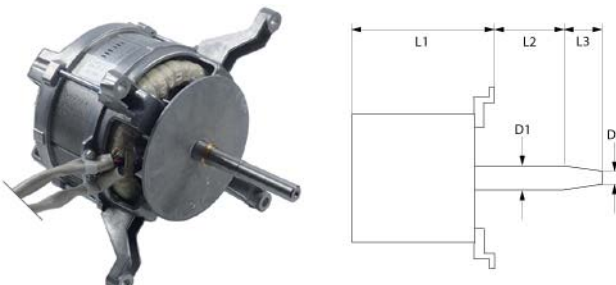

1

<b>GEV No.</b>	601733	<b>Ref. No.</b>	5008060 500806K
<b>description</b>	fan motor 380-415/380-480V 3 phase 50/60Hz 0.4/0.68kW 1420/1720rpm L1 155mm L2 45mm L3 55mm 0.55/1.1A at 50Hz 380-415V at 60Hz 380-480V at 50Hz 940-1420rpm at 60Hz 1120-1720rpm type L9zAw64D-449 D1 ø 15mm D2 ø 14mm kit		
<b>For models:</b>	OD10.10, OD10.20, OD12.20, OD20.10, OD20.20, OD6.10, OS10.10, OS10.20, OS12.20, OS20.10, OS20.20, OS6.10, OSC10.10, OSC10.20, OSC12.20, OSC20.10, OSC20.20, OSC6.10, OSP10.10, OSP10.20, OSP12.20, OSP20.10, OSP20.20, OSP6.10		



1

<b>GEV No.</b>	605169	<b>Ref. No.</b>	2617285 5018003
<b>description</b>	fan motor 380-415/380-480V 3 phase 50/60Hz 0.9kW 700/1380rpm speeds 2 L1 205mm L2 30mm L3 65mm 0.9/2.1A D1 ø 17mm D2 ø 13.5mm		
<b>For models:</b>	OEB10.20, OEB12.20, OEB20.20, OES10.20, OES12.20, OES20.20, OGB10.20, OGB12.20, OGB20.20, OGS10.20, OGS12.20, OGS20.20		
<b>spare parts for</b>	605169		
	<b>GEV No.</b>	694646	<b>Ref. No.</b> 2617295
shaft sealing set for hot air motors			



1

<b>GEV No.</b>	602144	<b>Ref. No.</b>	6000051 6000056
<b>description</b>	fan wheel blades 42 D1 ø 355mm D2 ø 14mm D3 ø 14mm H1 114mm H2 23mm H3 77mm		
<b>For models:</b>	AR100, AR108, AR30, AR40, AR50, AR54, AR72, HUD10.10, HUD12.20, HUD20.10, HUD20.20, HUD6.10, OD10.10, OD10.20, OD20.10, OD6.10, OS10.10, OS20.10, OS6.10, OSC10.10, OSC20.10, OSC6.10, OSP10.10, OSP20.10, OSP6.10, UG10.10, UG20.10, UG20.20, UG6.10		



1

<b>GEV No.</b>	601872	<b>Ref. No.</b>	2618803
<b>description</b>	fan wheel D1 ø 200mm H1 43mm blades 45 D2 ø 8.3mm D3 ø 8.3mm H2 25mm		
<b>For models:</b>	OES6.06		



1

<b>GEV No.</b>	514426	<b>Ref. No.</b>	2619958 6010001
<b>description</b>	fan wheel D1 ø 350mm H1 110mm blades 12 D2 ø 16.8mm D3 ø 13.2mm H2 15mm H3 75mm seat ø 33mm		
<b>For models:</b>	OEB10.10, OEB20.10, OEB6.10, OEB6.20, OES10.10, OES20.10, OES6.10, OES6.20, OGB10.10, OGB20.10, OGB6.20, OGS10.10, OGS20.10, OGS6.20		
<b>spare parts for</b>	514426		
	<b>GEV No.</b>	699819	<b>Ref. No.</b> 2617293
mounting set for fan wheel CONVOTHERM			



1

<b>GEV No.</b>	601873	<b>Ref. No.</b>	2619959 6010003
<b>description</b>	fan wheel D1 ø 405mm H1 150mm blades 12 D2 ø 14mm D3 ø 17mm H2 22mm		
<b>For models:</b>	OEB10.20, OEB12.20, OEB20.20, OES10.20, OES12.20, OES20.20, OGB10.20, OGB12.20, OGB20.20, OGS10.20, OGS12.20, OGS20.20		



1

<b>GEV No.</b>	514439	<b>Ref. No.</b>	6015034
<b>description</b>	gasket graphite ED ø 82.5mm ID ø 52.5mm thickness 2mm		
<b>For models:</b>	OGB10.10, OGB10.20, OGB12.20, OGB20.10, OGB20.20, OGB6.10, OGB6.20, OGS10.10, OGS10.20, OGS12.20, OGS20.10, OGS20.20, OGS6.10, OGS6.20		



1

<b>GEV No.</b>	510686	<b>Ref. No.</b>	6005079
<b>description</b>	gasket set for fan motor ID ø 15mm		
<b>For models:</b>	HUD10.10, HUD12.20, HUD20.10, HUD20.20, HUD6.10, OD10.10, OD10.20, OD12.20, OD20.10, OD20.20, OD6.10		



<b>GEV No.</b>	402888	<b>Ref. No.</b>	2617283 5018002
<b>description</b>	motor three phase current 0.6kW 380-415V 50/60Hz 3 phase 0.6-1.6A shaft $\varnothing$ 17mm shaft length 88mm 710-1390 / 820-1690rpm type L9yzw84D-584 HANNING		
<b>For models:</b>	OEB10.10, OEB20.10, OEB6.10, OEB6.20, OES10.10, OES20.10, OES6.10, OES6.20, OGB10.10, OGB20.10, OGB6.10, OGB6.20, OGS10.10, OGS20.10, OGS6.10, OGS6.20		
<b>accessories for</b>	402888		
	<b>GEV No.</b>	514426	<b>Ref. No.</b> 2619958 6010001
	fan wheel D1 $\varnothing$ 350mm H1 110mm blades 12 D2 $\varnothing$ 16.8mm D3 $\varnothing$ 13.2mm H2 15mm H3 75mm seat $\varnothing$ 33mm		



<b>GEV No.</b>	694646	<b>Ref. No.</b>	2617295
<b>description</b>	shaft sealing set for hot air motors		
<b>For models:</b>	OEB10.10, OEB10.20, OEB12.20, OEB20.10, OEB20.20, OEB6.10, OEB6.20, OES10.10, OES10.20, OES12.20, OES20.10, OES20.20, OES6.10, OES6.20, OGB10.10, OGB10.20, OGB12.20, OGB20.10, OGB20.20, OGB6.10, OGB6.20, OGS10.10, OGS10.20, OGS12.20, OGS20.10, OGS20.20, OGS6.10, OGS6.20		

hot air fans

accessories

miscellaneous



<b>GEV No.</b>	694800	<b>Ref. No.</b>	2618801
<b>description</b>	engine shaft gasket $\varnothing$ 18mm hole $\varnothing$ 8mm Mini series Qty 1 pcs		
<b>For models:</b>	OES6.06		

radial fans



<b>GEV No.</b>	601181	<b>Ref. No.</b>	5018000
<b>description</b>	radial fan 230V voltage AC 50Hz 100W H1 170mm L1 175mm D1 $\varnothing$ 50mm W1 115mm W2 40mm H2 45mm		
<b>For models:</b>	OGB10.10, OGB12.20, OGB20.10, OGB6.10, OGB6.20, OGS10.10, OGS12.20, OGS20.10, OGS6.10, OGS6.20		



<b>GEV No.</b>	601742	<b>Ref. No.</b>	5018001
<b>description</b>	radial fan 230V voltage AC 50Hz 140W H1 190mm L1 190mm D1 $\varnothing$ 50mm W1 133mm W2 28mm H2 55mm W3 83mm H3 83mm		
<b>For models:</b>	OGB10.20, OGB12.20, OGB20.10, OGB20.20, OGS10.20, OGS12.20, OGS20.10, OGS20.20		

accessories universal



<b>GEV No.</b>	802191	<b>Ref. No.</b>	7015200
<b>description</b>	puller for fan wheel seat $\varnothing$ 28/34mm thread M16x1.5 WS 17		
<b>For models:</b>	OEB10.10, OEB10.20, OEB12.20, OEB20.10, OEB20.20, OEB6.10, OEB6.20, OES10.10, OES10.20, OES12.20, OES20.10, OES20.20, OES6.10, OES6.20, OGB10.10, OGB10.20, OGB12.20, OGB20.10, OGB20.20, OGB6.10, OGB6.20, OGS10.10, OGS10.20, OGS12.20, OGS20.10, OGS20.20, OGS6.10, OGS6.20		



**motors**

accessories

miscellaneous



1

<b>GEV No.</b>	696344	<b>Ref. No.</b>	5008067
<b>description</b>	gasket set for three-phase motor		
<b>For models:</b>	OD10.10, OD10.20, OD12.20, OD20.10, OD20.20, OD6.10, OS10.10, OS10.20, OS12.20, OS20.10, OS20.20, OS6.10, OSC10.10, OSC10.20, OSC12.20, OSC20.10, OSC20.20, OSC6.10, OSP10.10, OSP10.20, OSP12.20, OSP20.10, OSP20.20, OSP6.10		

**pumps**

wash and rinse pumps

HANNING

pumps



1

<b>GEV No.</b>	501563	<b>Ref. No.</b>	5056337
<b>description</b>	pump inlet ø 24 outlet ø 24 type UP30-494 200-240V 50/60Hz 1 phase 0.1kW L 146mm capacitor 2.5µF HANNING hose clamps		

drain pumps

HANNING



1

<b>GEV No.</b>	500096	<b>Ref. No.</b>	2019700 5008079 5008079K
<b>description</b>	drain pump 32W 230V inlet ø 30mm outlet ø 24mm		
<b>For models:</b>	OEB10.10, OEB10.20, OEB12.20, OEB20.10, OEB20.20, OEB6.10, OEB6.20, OES10.10, OES10.20, OES12.20, OES20.10, OES20.20, OES6.10, OES6.20, OGB10.10, OGB10.20, OGB12.20, OGB20.10, OGB20.20, OGB6.10, OGB6.20, OGS10.10, OGS10.20, OGS12.20, OGS20.10, OGS20.20, OGS6.10, OGS6.20, OS10.10, OS10.20, OS12.20, OS20.10, OS20.20, OS6.10, OSC10.10, OSC10.20, OSC12.20, OSC20.10, OSC20.20, OSC6.10, OSP10.10, OSP10.20, OSP12.20, OSP20.10, OSP20.20, OSP6.10		



1

<b>GEV No.</b>	501569	<b>Ref. No.</b>	5056380
<b>description</b>	drain pump 38/43W 200-240V inlet ø 24mm outlet ø 24mm 50/60Hz type DPS25R-393 HANNING type series Hafflowtic compact		

vibration pumps



1

<b>GEV No.</b>	696786	<b>Ref. No.</b>	6013059
<b>description</b>	bracket for vibration pump L 85mm W 45mm H 70mm mounting distance 25/50mm rubber		

1

<b>GEV No.</b>	500580	<b>Ref. No.</b>	5008011 5008011K 5030635
<b>description</b>	vibration pump 230V 60W 50/60Hz inlet $\varnothing$ 7 outlet $\varnothing$ 1/8" IT CEME type E512 with accessories duty cycle 1/2 ambient temperature max. 60°C medium temp max. 35°C overheating protection 110°C CleanJet		
<b>For models:</b>	OEB10.10, OEB10.20, OEB12.20, OEB20.10, OEB20.20, OEB6.10, OEB6.20, OES10.10, OES10.20, OES12.20, OES20.10, OES20.20, OES6.06, OES6.10, OES6.20, OGB10.10, OGB10.20, OGB12.20, OGB20.10, OGB20.20, OGB6.10, OGB6.20, OGS10.10, OGS10.20, OGS12.20, OGS20.10, OGS20.20, OGS6.10, OGS6.20, OS12.20, OS20.10, OS20.20		



1

<b>GEV No.</b>	499142	<b>Ref. No.</b>	5018028 5018035
<b>description</b>	vibration pump type CP.06.728.0 220/240V 70W 60Hz inlet $\varnothing$ 6 outlet $\varnothing$ 6 with thermal fuse L 130mm		
<b>For models:</b>	OEB10.10, OEB10.20, OEB12.20, OEB20.10, OEB20.20, OEB6.10, OEB6.20, OES10.10, OES10.20, OES12.20, OES20.10, OES20.20, OES6.10, OES6.20, OGB10.10, OGB10.20, OGB12.20, OGB20.10, OGB20.20, OGB6.10, OGB6.20, OGS10.10, OGS10.20, OGS12.20, OGS20.10, OGS20.20, OGS6.10, OGS6.20		



1

<b>GEV No.</b>	501547	<b>Ref. No.</b>	5056376
<b>description</b>	vibration pump type MPP2.02.041.2/ST/S 208-240V 14W 50Hz inlet $\varnothing$ 6.5 outlet $\varnothing$ 7.5 ARS L 87mm		

## condensators & interference suppression filters

### filters

#### interference suppression filters



1

<b>GEV No.</b>	365218	<b>Ref. No.</b>	4001078
<b>description</b>	interference suppression filter type RC-01 capacity 0.15 $\mu$ F L 37.5mm H 37mm W 10mm 470Ohm		
<b>For models:</b>	OD10.10, OD10.20, OD12.20, OD20.10, OD20.20, OD6.10, OSC10.10, OSC10.20, OSC12.20, OSC20.10, OSC20.20, OSC6.10, OSG10.10, OSG12.20, OSG20.20, OSG6.10, OSP10.10, OSP10.20, OSP12.20, OSP20.10, OSP20.20, OSP6.10		

#### line filters

##### with housing



1

<b>GEV No.</b>	365222	<b>Ref. No.</b>	5056974
<b>description</b>	line filter type 5500.2218 250V 50/60Hz conductor 2 with E connection F6.3x0.8 L 65mm H 42mm W 50mm screw aluminium		

#### RC circuits



1

<b>GEV No.</b>	380272	<b>Ref. No.</b>	4001077
<b>description</b>	RC circuit for contactors type 910-304-585-50 130-250V 50-60Hz conductor 2 connection cable plastic Qty 1 pcs for contactors LS4_LS15K type AEG LR2K A250 type GE BS2R2R		
<b>For models:</b>	OD10.10, OD10.20, OD12.20, OD20.10, OD20.20, OD6.10		



1

<b>GEV No.</b>	381475	<b>Ref. No.</b>	5056978
<b>description</b>	RC circuit for CONVOTHERM 4 120Ohm capacity 0.15 $\mu$ F		



<b>GEV No.</b>	381483	<b>Ref. No.</b>	5056977
<b>description</b>	RC circuit for CONVOTHERM type MT151415 1200hm capacity 0.15µF		



<b>GEV No.</b>	381482	<b>Ref. No.</b>	5056980
<b>description</b>	RC circuit for CONVOTHERM type MT151417 1500hm capacity 0.47µF		



<b>GEV No.</b>	381478	<b>Ref. No.</b>	5056981
<b>description</b>	RC circuit for CONVOTHERM type MT151418 1500hm capacity 0.47µF		



<b>GEV No.</b>	381479	<b>Ref. No.</b>	5056979
<b>description</b>	RC circuit type SAWI 610303 1500hm capacity 0.47µF		



<b>GEV No.</b>	358603	<b>Ref. No.</b>	4005066 4056944
<b>description</b>	fine fuse size ø5x20mm 2A slow-acting rated 250V Qty 10 pcs		
<b>For models:</b>	AR108, AR12, AR18, AR28, AR40, AR54, AR72, OD10.10, OD10.20, OD12.20, OD20.10, OD20.20, OD6.10, OEB10.10, OEB10.20, OEB12.20, OEB20.10, OEB20.20, OEB6.10, OEB6.20, OES10.10, OES10.20, OES12.20, OES20.10, OES20.20, OES6.10, OES6.20, OGB10.10, OGB10.20, OGB12.20, OGB20.10, OGB20.20, OGB6.10, OGB6.20, OGS10.10, OGS10.20, OGS12.20, OGS20.10, OGS20.20, OGS6.10, OGS6.20, OSC10.10, OSC10.20, OSC12.20, OSC20.10, OSC20.20, OSC6.10, OSG10.10, OSG12.20, OSG20.20...(Other models you can see in the webshop)		



<b>GEV No.</b>	358605	<b>Ref. No.</b>	4056945
<b>description</b>	fine fuse size ø5x20mm 3.15A slow-acting rated 250V Qty 10 pcs		



<b>GEV No.</b>	358607	<b>Ref. No.</b>	4005068
<b>description</b>	fine fuse size ø5x20mm 6.3A slow-acting rated 250V Qty 10 pcs		
<b>For models:</b>	HUD10.10, HUD12.20, HUD20.10, HUD20.20, HUD6.10, OD10.10, OD10.20, OD12.20, OD20.10, OD20.20, OD6.10, OSG10.10, OSG12.20, OSG20.20, OSG6.10		



<b>GEV No.</b>	358751	<b>Ref. No.</b>	4005069
<b>description</b>	fine fuse size ø6.3x32mm 6.3A fast-acting rated 500V Qty 10 pcs		
<b>For models:</b>	OD10.10, OD10.20, OD12.20, OD6.10, OEB10.10, OEB6.10, OEB6.20, OES10.10, OES6.10, OES6.20, OGB10.10, OGB20.10, OGB6.10, OGB6.20, OGS10.10, OGS20.10, OGS6.10, OGS6.20, OSC10.10, OSC10.20, OSC12.20, OSC20.10, OSC6.10, OSP10.10, OSP10.20, OSP12.20, OSP6.10		



<b>GEV No.</b>	358188	<b>Ref. No.</b>	4056355
<b>description</b>	fine fuse size ø6.3x32mm 10A slow-acting rated 500V Qty 10 pcs		

fuses

fine fuses



<b>GEV No.</b>	358600	<b>Ref. No.</b>	4005064
<b>description</b>	fine fuse size ø5x20mm 1A slow-acting rated 250V Qty 10 pcs		
<b>For models:</b>	HUD10.10, HUD12.20, HUD20.10, HUD20.20, HUD6.10, OD10.10, OD10.20, OD12.20, OD20.10, OD20.20, OD6.10, OEB10.10, OEB10.20, OEB12.20, OEB20.10, OEB20.20, OEB6.10, OEB6.20, OES10.10, OES10.20, OES12.20, OES20.10, OES20.20, OES6.06, OES6.10, OES6.20, OGB10.20, OGB12.20, OGB20.10, OGB20.20, OGS10.10, OGS10.20, OGS12.20, OGS20.10, OGS20.20, OGS6.10, OGS6.20, OSC10.10, OSC10.20, OSC12.20, OSC20.10, OSC20.20, OSC6.10, OSG10.10, OSG12.20, OSG20.20, OSG6.10, OSP10.10, OSP10.20, OSP12.20...(Other models you can see in the webshop)		

slow-acting



			
1			
<b>GEV No.</b>	358189	<b>Ref. No.</b>	4056354
<b>description</b>	fine fuse size $\phi$ 6.3x32mm 4A slow-acting rated 500V Qty 10 pcs		

fine fuse holders

			
1			
<b>GEV No.</b>	550105	<b>Ref. No.</b>	4004010
<b>description</b>	rail-mounted terminal WIELAND type WK10/SIU 5X20 /V0 suitable fuse $\phi$ 5x20mm 1.0-16mm <sup>2</sup> 10A rated 250V		
<b>For models:</b>	AR108, AR12, AR18, AR28, AR40, AR54, AR72, HUD10.10, HUD12.20, HUD20.10, HUD20.20, HUD6.10, OD10.10, OD10.20, OD12.20, OD20.10, OD20.20, OD6.10, OSC10.10, OSC10.20, OSC12.20, OSC20.10, OSC20.20, OSC6.10, OSP10.10, OSP10.20, OSP12.20, OSP20.10, OSP20.20, OSP6.10		

screw locks

D0-system (NEOZED)

			
1			
<b>GEV No.</b>	358073	<b>Ref. No.</b>	4005053
<b>description</b>	fuse size D01 10A rated 250/400V E14 $\phi$ 11mm L 36mm Qty 10 pcs		

			
1			
<b>GEV No.</b>	358043	<b>Ref. No.</b>	4005054
<b>description</b>	fuse size D01 16A rated 250/400V E14 $\phi$ 11mm L 36mm Qty 10 pcs		
<b>For models:</b>	HUD12.20, HUD20.10		

			
1			
<b>GEV No.</b>	358070	<b>Ref. No.</b>	4005050
<b>description</b>	fuse size D01 2A rated 250/400V E14 $\phi$ 11mm L 36mm Qty 10 pcs		
<b>For models:</b>	AR100, AR108, AR16, AR18, AR28, AR30, AR40, AR50, AR54, AR72, UG10.10, UG10.20, UG20.10, UG20.20, UG6.05, UG6.10		

			
1			
<b>GEV No.</b>	358071	<b>Ref. No.</b>	4005051
<b>description</b>	fuse size D01 4A rated 250/400V E14 $\phi$ 11mm L 36mm Qty 10 pcs		
<b>For models:</b>	AR100, AR108, AR30, AR40, AR50, AR54, AR72, OES12.20, UG10.10, UG20.10, UG6.10		

			
1			
<b>GEV No.</b>	358072	<b>Ref. No.</b>	4005052
<b>description</b>	fuse size D01 6A rated 250/400V E14 $\phi$ 11mm L 36mm Qty 10 pcs		
<b>For models:</b>	OEB20.20, UG20.20		

			
1			
<b>GEV No.</b>	358048	<b>Ref. No.</b>	4005058
<b>description</b>	fuse size D02 20A rated 250/400V E18 $\phi$ 15mm L 36mm Qty 10 pcs		
<b>For models:</b>	AR108, HUD20.20, OD10.20, OD12.20, OD20.10, OD20.20, OEB10.20, OEB12.20, OEB20.10		

			
1			
<b>GEV No.</b>	358044	<b>Ref. No.</b>	4005046 4005055
<b>description</b>	fuse size D02 25A rated 250/400V E18 $\phi$ 15mm L 36mm Qty 10 pcs		
<b>For models:</b>	AR100, AR108, HUD12.20, HUD20.10, HUD20.20, OD10.20, OD12.20, OD20.10, OD20.20, OEB10.20, OEB12.20, OEB20.20, OES10.20, OES12.20, OES20.20, UG10.20		

			
1			
<b>GEV No.</b>	358045	<b>Ref. No.</b>	2212003 4005056
<b>description</b>	fuse size D02 35A rated 250/400V E18 $\phi$ 15mm L 36mm Qty 10 pcs		
<b>For models:</b>	HUD20.10, OD20.20, OEB10.20, OEB12.20, OEB20.10, OES20.10, UG20.10, UG20.20		

			
1			
<b>GEV No.</b>	358046	<b>Ref. No.</b>	4005057
<b>description</b>	fuse size D02 50A rated 250/400V E18 $\phi$ 15mm L 36mm Qty 10 pcs		
<b>For models:</b>	OD10.20, OD12.20, OD20.10, OD20.20, OEB10.20, OEB12.20, OEB20.20, OES10.20, OES12.20, OES20.20		

			
1			
<b>GEV No.</b>	358047	<b>Ref. No.</b>	4005059
<b>description</b>	fuse size D02 63A rated 250/400V E18 $\phi$ 15mm L 36mm Qty 10 pcs		
<b>For models:</b>	OEB20.10, OES20.10		

gauge pieces (NEOZED)



<b>GEV No.</b>	358055	<b>Ref. No.</b>	4005013
<b>description</b>	gauge piece size D01 suitable for 10A		



<b>GEV No.</b>	358052	<b>Ref. No.</b>	4005010
<b>description</b>	gauge piece size D01 suitable for 2A		
<b>For models:</b>	AR100, AR108, AR16, AR18, AR28, AR30, AR40, AR50, AR54, AR72, UG10.10, UG10.20, UG20.10, UG20.20, UG6.05, UG6.10		



<b>GEV No.</b>	358053	<b>Ref. No.</b>	4005011
<b>description</b>	gauge piece size D01 suitable for 4A		
<b>For models:</b>	AR100, AR108, AR30, AR40, AR50, AR54, AR72, OES12.20, OES20.20, UG10.10, UG20.10, UG6.10		



<b>GEV No.</b>	358054	<b>Ref. No.</b>	4005012
<b>description</b>	gauge piece size D01 suitable for 6A		
<b>For models:</b>	UG20.20		



<b>GEV No.</b>	358064	<b>Ref. No.</b>	4005021
<b>description</b>	gauge piece size D02 suitable for 16A		
<b>For models:</b>	OD10.20, OD12.20, OD20.10, OSP10.20, OSP12.20		



<b>GEV No.</b>	358065	<b>Ref. No.</b>	4005014
<b>description</b>	gauge piece size D02 suitable for 20A		
<b>For models:</b>	AR108, HUD12.20, HUD20.10, HUD20.20, OD10.20, OD12.20, OD20.10, OD20.20, OEB10.20, OEB12.20, OEB20.10, OSC10.20, OSC12.20, OSC20.10, OSC20.20, OSP10.20, OSP12.20, OSP20.10, OSP20.20, OSP6.10		



<b>GEV No.</b>	358066	<b>Ref. No.</b>	4005015
<b>description</b>	gauge piece size D02 suitable for 25A		
<b>For models:</b>	AR100, AR108, OD10.20, OD12.20, OD20.10, OD20.20, OEB10.20, OEB12.20, OEB20.20, OES10.20, OES12.20, OES20.20, OSC10.20, OSC12.20, OSC20.10, OSC20.20, OSP10.20, OSP12.20, OSP20.10, OSP20.20, UG10.20		



<b>GEV No.</b>	358067	<b>Ref. No.</b>	4005016
<b>description</b>	gauge piece size D02 suitable for 35A		
<b>For models:</b>	HUD20.10, OD20.20, OEB10.20, OEB12.20, OEB20.10, OES20.10, OSC20.20, OSP20.20, UG20.10, UG20.20		



<b>GEV No.</b>	358068	<b>Ref. No.</b>	4005017
<b>description</b>	gauge piece size D02 suitable for 50A		
<b>For models:</b>	OD10.20, OD12.20, OD20.10, OD20.20, OEB10.20, OEB12.20, OEB20.20, OES10.20, OES12.20, OES20.20, OSC10.20, OSC12.20, OSC20.10, OSC20.20, OSP10.20, OSP12.20, OSP20.10, OSP20.20		

fuse holders



<b>GEV No.</b>	358057	<b>Ref. No.</b>	4004020
<b>description</b>	fuse holder suitable fuse D01 1-pole-pole 16A rated 400V		
<b>For models:</b>	AR100, AR108, AR16, AR18, AR28, AR30, AR40, AR50, AR54, AR72, HUD12.20, HUD20.10, UG10.10, UG10.20, UG20.10, UG20.20, UG6.05, UG6.10		



<b>GEV No.</b>	358059	<b>Ref. No.</b>	4004030
<b>description</b>	fuse holder suitable fuse D01 ø 24mm mounting ø 14mm 1-pole-pole 16A rated 400V L 30mm		
<b>For models:</b>	AR100, AR108, AR16, AR18, AR28, AR30, AR40, AR50, AR54, AR72, HUD12.20, HUD20.10, HUD20.20, UG10.10, UG10.20, UG20.10, UG20.20, UG6.05, UG6.10		





			
1			
<b>GEV No.</b>	358058	<b>Ref. No.</b>	4004023 4004025 4030773
<b>description</b>	fuse holder suitable fuse D02 1-pole-pole 63A rated 400V		
<b>For models:</b>	AR108, HUD12.20, HUD20.10, HUD20.20, OD10.20, OD12.20, OD20.10, OD20.20, OEB10.20, OEB12.20, OEB20.10, OEB20.20, OES10.20, OES12.20, OES20.10, OES20.20, OSC10.20, OSC12.20, OSC20.10, OSC20.20, OSP10.20, OSP12.20, OSP20.10, OSP20.20, OSP6.10, UG10.20, UG20.10, UG20.20		

			
1			
<b>GEV No.</b>	358061	<b>Ref. No.</b>	4004035
<b>description</b>	fuse holder suitable fuse D02 ø 25mm mounting ø 18mm rated 400V L 30mm		
<b>For models:</b>	AR100, AR108, HUD12.20, HUD20.10, OD10.20, OD12.20, OD20.10, OD20.20, OEB10.20, OEB12.20, OEB20.10, OEB20.20, OES10.20, OES12.20, OES20.10, OES20.20, UG10.20, UG20.10, UG20.20		

line circuit breakers

SCHNEIDER ELECTRIC

			
1			
<b>GEV No.</b>	381457	<b>Ref. No.</b>	5056830
<b>description</b>	line circuit breaker 1-pole tripping type B 63A rated 230/400V connection screw auxiliary contacts 1NO mounting rail		

electric accessories

cables

connection cables

			
1			
<b>GEV No.</b>	579000	<b>Ref. No.</b>	5009304
<b>description</b>	connection cable L 1900mm 9-pole suitable for CONVOTHERM connection plug type RS232 interface		
<b>For models:</b>	OEB10.10, OEB10.20, OEB12.20, OEB20.10, OEB20.20, OEB6.10, OEB6.20, OES10.10, OES10.20, OES12.20, OES20.10, OES20.20, OES6.06, OES6.10, OES6.20, OGB10.10, OGB10.20, OGB12.20, OGB20.10, OGB20.20, OGB6.10, OGB6.20, OGS10.10, OGS10.20, OGS12.20, OGS20.10, OGS20.20, OGS6.10, OGS6.20, OSC10.10, OSC10.20, OSC12.20, OSC20.10, OSC20.20, OSC6.10, OSG10.10, OSG12.20, OSG20.20, OSG6.10, OSP10.10, OSP10.20, OSP12.20, OSP20.10, OSP20.20, OSP6.10		

			
1			
<b>GEV No.</b>	579006	<b>Ref. No.</b>	5056357
<b>description</b>	data cable L 1020mm 8-pole for combi-steamer suitable for CONVOTHERM plug type RJ45		

terminals

PCB terminal blocks

			
1			
<b>GEV No.</b>	551367	<b>Ref. No.</b>	5012003
<b>description</b>	PCB terminal block 12-pole raster size 3.5mm		
<b>For models:</b>	OEB10.10, OEB10.20, OEB12.20, OEB20.10, OEB20.20, OEB6.10, OEB6.20, OES10.10, OES10.20, OES12.20, OES20.10, OES20.20, OES6.06, OES6.10, OES6.20, OGB10.10, OGB10.20, OGB12.20, OGB20.10, OGB20.20, OGB6.10, OGB6.20, OGS10.10, OGS10.20, OGS12.20, OGS20.10, OGS20.20, OGS6.10, OGS6.20		

			
1			
<b>GEV No.</b>	551369	<b>Ref. No.</b>	5002091
<b>description</b>	PCB terminal block 12-pole raster size 3.5mm flat		
<b>For models:</b>	OS10.10, OS10.20, OS12.20, OS20.10, OS20.20, OS6.10, OSC10.10, OSC10.20, OSC12.20, OSC20.10, OSC20.20, OSC6.10, OSG10.10, OSG12.20, OSG20.20, OSG6.10, OSP10.10, OSP10.20, OSP12.20, OSP20.10, OSP20.20, OSP6.10		

			
1			
<b>GEV No.</b>	550810	<b>Ref. No.</b>	4006003
<b>description</b>	PCB terminal block 12-pole raster size 5mm		
<b>For models:</b>	OD10.10, OD10.20, OD12.20, OD20.10, OD20.20, OD6.10		

			
1			
<b>GEV No.</b>	551360	<b>Ref. No.</b>	5002097
<b>description</b>	PCB terminal block 16-pole raster size 3.5mm		
<b>For models:</b>	OS10.10, OS10.20, OS12.20, OS20.10, OS20.20, OS6.10, OSC10.10, OSC10.20, OSC12.20, OSC20.10, OSC20.20, OSC6.10, OSG10.10, OSG12.20, OSG20.20, OSG6.10, OSP10.10, OSP10.20, OSP12.20, OSP20.10, OSP20.20, OSP6.10		

1

<b>GEV No.</b>	550802	<b>Ref. No.</b>	4005093
<b>description</b>	PCB terminal block 4-pole raster size 5mm		
<b>For models:</b>	OD10.10, OD10.20, OD12.20, OD20.10, OD20.20, OD6.10		



1

<b>GEV No.</b>	551338	<b>Ref. No.</b>	4006022
<b>description</b>	PCB terminal block 6-pole cross section 1.5mm <sup>2</sup>		
<b>For models:</b>	OD10.10, OD10.20, OD12.20, OD20.10, OD20.20, OD6.10		



1

<b>GEV No.</b>	551363	<b>Ref. No.</b>	4006021
<b>description</b>	PCB terminal block 7-pole raster size 7mm cross section 1.5mm <sup>2</sup>		
<b>For models:</b>	OD10.10, OD10.20, OD12.20, OD20.10, OD20.20, OD6.10		



1

<b>GEV No.</b>	551370	<b>Ref. No.</b>	5002096
<b>description</b>	PCB terminal block 8-pole raster size 3.5mm flat		
<b>For models:</b>	OEB10.10, OEB10.20, OEB12.20, OEB20.10, OEB20.20, OEB6.10, OEB6.20, OES10.10, OES10.20, OES12.20, OES20.10, OES20.20, OES6.10, OES6.20, OGB10.10, OGB10.20, OGB12.20, OGB20.10, OGB20.20, OGB6.10, OGB6.20, OGS10.10, OGS10.20, OGS12.20, OGS20.10, OGS20.20, OGS6.10, OGS6.20, OS10.10, OS10.20, OS12.20, OS20.10, OS20.20, OS6.10, OSC10.10, OSC10.20, OSC12.20, OSC20.10, OSC20.20, OSC6.10, OSG10.10, OSG12.20, OSG20.20, OSG6.10, OSP10.10, OSP10.20, OSP12.20, OSP20.10, OSP20.20, OSP6.10		



1

<b>GEV No.</b>	551364	<b>Ref. No.</b>	5012002
<b>description</b>	PCB terminal block 8-pole raster size 5mm		
<b>For models:</b>	OEB10.10, OEB10.20, OEB12.20, OEB20.10, OEB20.20, OEB6.10, OEB6.20, OES10.10, OES10.20, OES12.20, OES20.10, OES20.20, OES6.06, OES6.10, OES6.20, OGB10.10, OGB10.20, OGB12.20, OGB20.10, OGB20.20, OGB6.10, OGB6.20, OGS10.10, OGS10.20, OGS12.20, OGS20.10, OGS20.20, OGS6.10, OGS6.20		



1

<b>GEV No.</b>	551365	<b>Ref. No.</b>	5002095
<b>description</b>	PCB terminal block 9-pole raster size 3.5mm		
<b>For models:</b>	OGB10.10, OGB10.20, OGB12.20, OGB20.10, OGB20.20, OGB6.10, OGB6.20, OGS10.10, OGS10.20, OGS12.20, OGS20.10, OGS20.20, OGS6.10, OGS6.20, OS10.10, OS10.20, OS12.20, OS20.10, OS20.20, OS6.10, OSC10.10, OSC10.20, OSC12.20, OSC20.10, OSC20.20, OSC6.10, OSG10.10, OSG12.20, OSG20.20, OSG6.10, OSP10.10, OSP10.20, OSP12.20, OSP20.10, OSP20.20, OSP6.10		



1

<b>GEV No.</b>	551368	<b>Ref. No.</b>	5002098
<b>description</b>	PCB terminal block 9-pole raster size 3.5mm		
<b>For models:</b>	OS10.10, OS10.20, OS12.20, OS20.10, OS20.20, OS6.10, OSC10.10, OSC10.20, OSC12.20, OSC20.10, OSC20.20, OSC6.10, OSG10.10, OSG12.20, OSG20.20, OSG6.10, OSP10.10, OSP10.20, OSP12.20, OSP20.10, OSP20.20, OSP6.10		



1

<b>GEV No.</b>	551361	<b>Ref. No.</b>	5002090
<b>description</b>	PCB terminal block 9-pole raster size 5mm		
<b>For models:</b>	OGB10.10, OGB10.20, OGB12.20, OGB20.10, OGB20.20, OGB6.10, OGB6.20, OGS10.10, OGS10.20, OGS12.20, OGS20.10, OGS20.20, OGS6.10, OGS6.20, OS10.10, OS10.20, OS12.20, OS20.10, OS20.20, OS6.10, OSC10.10, OSC10.20, OSC12.20, OSC20.10, OSC20.20, OSC6.10, OSG10.10, OSG12.20, OSG20.20, OSG6.10, OSP10.10, OSP10.20, OSP12.20, OSP20.10, OSP20.20, OSP6.10		

rail-mounted terminals  
WIELAND  
rail-mounted terminals type 9700A





1

<b>GEV No.</b>	550373	<b>Ref. No.</b>	4006040
<b>description</b>	rail-mounted terminal WIELAND type 9700A/10 S35 1.5-16mm <sup>2</sup> top-hat rail 35mm grey W 10mm L 49mm		
<b>For models:</b>	AR108, HUD12.20, HUD20.20, OD10.10, OD6.10, OSC10.10, OSP10.10, OSP6.10		





 <p>1</p>			
<b>GEV No.</b>	550382	<b>Ref. No.</b>	4006050
<b>description</b>	rail-mounted terminal WIELAND type 9700A/12 S35 2.5-25mm <sup>2</sup> top-hat rail 35mm grey W 12mm L 59mm		
<b>For models:</b>	HUD20.10, OD10.20, OD12.20, OD20.10, OSC10.20, OSC12.20, OSC20.10, OSP10.20, OSP12.20, OSP20.10, OSP6.10		

 <p>1</p>			
<b>GEV No.</b>	550376	<b>Ref. No.</b>	4006055
<b>description</b>	rail-mounted terminal WIELAND type 9700A/16 S35 2.5-35mm <sup>2</sup> top-hat rail 35mm grey W 16mm L 59mm		
<b>For models:</b>	HUD20.20, OD10.20, OD12.20, OD20.10, OD20.20, OSC10.20, OSC12.20, OSC20.10, OSC20.20, OSP10.20, OSP12.20, OSP20.10, OSP20.20		

 <p>1</p>			
<b>GEV No.</b>	550378	<b>Ref. No.</b>	4006058
<b>description</b>	rail-mounted terminal WIELAND type 9700A/16 SL2 S35 2.5-35mm <sup>2</sup> top-hat rail 35mm yellow/green W 16mm L 53mm		
<b>For models:</b>	HUD12.20, HUD20.10, HUD20.20, OD10.20, OD12.20, OD20.10, OD20.20, OSC10.20, OSC12.20, OSC20.10, OSC20.20, OSP10.20, OSP12.20, OSP20.10, OSP20.20, OSP6.10		

 <p>1</p>			
<b>GEV No.</b>	550371	<b>Ref. No.</b>	4006023
<b>description</b>	rail-mounted terminal WIELAND type 9700A/6 S35 0.5-4mm <sup>2</sup> top-hat rail 35mm grey W 6mm L 46.6mm		
<b>For models:</b>	AR18, AR28, HUD10.10, HUD12.20, HUD20.10, HUD20.20, HUD6.10, OD10.10, OD10.20, OD12.20, OD20.10, OD20.20, OD6.10, OSC10.10, OSC20.10, OSC6.10, OSG10.10, OSG12.20, OSG20.20, OSG6.10, OSP10.10, OSP10.20, OSP12.20, OSP20.10, OSP20.20, OSP6.10		

 <p>1</p>			
<b>GEV No.</b>	550372	<b>Ref. No.</b>	4006026
<b>description</b>	rail-mounted terminal WIELAND type 9700A/6 SL2 S35 0.5-4mm <sup>2</sup> top-hat rail 35mm yellow/green W 6mm L 48.5mm		
<b>For models:</b>	AR108, AR18, AR28, AR40, AR54, AR72, HUD10.10, HUD12.20, HUD20.10, HUD20.20, HUD6.10, OD10.10, OD10.20, OD12.20, OD20.10, OD20.20, OD6.10, OSC10.10, OSC10.20, OSC12.20, OSC20.10, OSC20.20, OSC6.10, OSG10.10, OSG12.20, OSG20.20, OSG6.10, OSP10.10, OSP10.20, OSP12.20, OSP20.10, OSP20.20, OSP6.10		

 <p>1</p>			
<b>GEV No.</b>	550383	<b>Ref. No.</b>	4006033
<b>description</b>	rail-mounted terminal WIELAND type 9700A/8 S35 1.0-10mm <sup>2</sup> top-hat rail 35mm blue W 8mm L 46.6mm		
<b>For models:</b>	AR40, AR54, AR72, HUD10.10, OD10.10, OD10.20, OD12.20, OD6.10, OSC10.10, OSC6.10, OSP10.10, OSP6.10		

 <p>1</p>			
<b>GEV No.</b>	550381	<b>Ref. No.</b>	4006030
<b>description</b>	rail-mounted terminal WIELAND type 9700A/8 S35 1.0-10mm <sup>2</sup> top-hat rail 35mm grey W 8mm L 46.6mm		
<b>For models:</b>	AR40, AR54, AR72, HUD10.10, HUD20.10, HUD20.20, OD10.10, OD6.10, OSC10.10, OSC6.10, OSP10.10, OSP6.10		

installation terminals

 <p>1</p>			
<b>GEV No.</b>	550400 <sup>1</sup>	<b>Ref. No.</b>	4006043
<b>description</b>	installation terminal WIELAND type WK4/D2/2U/V0 0.5-6mm <sup>2</sup> TS35+TS32 grey DUO		
<b>For models:</b>	HUD10.10, HUD12.20, HUD20.10, HUD20.20, HUD6.10, OD10.10, OD10.20, OD12.20, OD20.10, OD20.20, OD6.10, OSC10.10, OSC10.20, OSC12.20, OSC20.10, OSC20.20, OSC6.10, OSP10.10, OSP10.20, OSP12.20, OSP20.10, OSP20.20, OSP6.10		

<sup>1</sup>duo-modular terminal



fuse terminal blocks

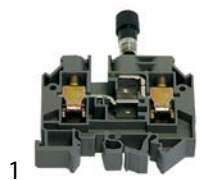

<b>GEV No.</b>	550105	<b>Ref. No.</b>	4004010
<b>description</b>	rail-mounted terminal WIELAND type WK10/SIU 5X20 /V0 suitable fuse ø5x20mm 1.0-16mm <sup>2</sup> 10A rated 250V		
<b>For models:</b>	AR108, AR12, AR18, AR28, AR40, AR54, AR72, HUD10.10, HUD12.20, HUD20.10, HUD20.20, HUD6.10, OD10.10, OD10.20, OD12.20, OD20.10, OD20.20, OD6.10, OSC10.10, OSC10.20, OSC12.20, OSC20.10, OSC20.20, OSC6.10, OSP10.10, OSP10.20, OSP12.20, OSP20.10, OSP20.20, OSP6.10		

accessories



<b>GEV No.</b>	550410	<b>Ref. No.</b>	4006045
<b>description</b>	end barrier for duo-modular terminal clamps up to 4mm <sup>2</sup> grey		
<b>For models:</b>	HUD10.10, HUD12.20, HUD20.10, HUD20.20, HUD6.10		



<b>GEV No.</b>	550337	<b>Ref. No.</b>	4004011
<b>description</b>	end barrier for fuse terminal clampsmm <sup>2</sup>		
<b>For models:</b>	HUD10.10, HUD12.20, HUD20.10, HUD20.20, HUD6.10, OD10.10, OD10.20, OD12.20, OD20.10, OD6.10		



<b>GEV No.</b>	550392	<b>Ref. No.</b>	4006051
<b>description</b>	end barrier for rail-mounted terminal clamps up to 25/35mm <sup>2</sup> blue		
<b>For models:</b>	HUD20.10, HUD20.20		



<b>GEV No.</b>	550384	<b>Ref. No.</b>	4006024
<b>description</b>	end barrier for rail-mounted terminal clamps up to 4mm <sup>2</sup> blue		
<b>For models:</b>	HUD6.10		



<b>GEV No.</b>	550394	<b>Ref. No.</b>	4006032
<b>description</b>	isolation barrier for rail-mounted terminal clamps up to 10mm <sup>2</sup> blue		
<b>For models:</b>	HUD10.10, HUD20.10		



<b>GEV No.</b>	550395	<b>Ref. No.</b>	4006042
<b>description</b>	isolation barrier for rail-mounted terminal clamps up to 16mm <sup>2</sup> yellow/green		
<b>For models:</b>	HUD12.20, HUD20.20		



<b>GEV No.</b>	550399	<b>Ref. No.</b>	4006052
<b>description</b>	isolation barrier for rail-mounted terminal clamps up to 25/35mm <sup>2</sup> green		
<b>For models:</b>	HUD20.10, HUD20.20		



<b>GEV No.</b>	550393	<b>Ref. No.</b>	4006025
<b>description</b>	isolation barrier for rail-mounted terminal clamps up to 4mm <sup>2</sup> grey		
<b>For models:</b>	HUD10.10, HUD12.20, HUD20.10, HUD20.20, HUD6.10		

miscellaneous





<b>GEV No.</b>	551421	<b>Ref. No.</b>	4056408
<b>description</b>	rail-mounted terminal PHOENIX CONTACT type ST 10-TWIN 0.2-16mm <sup>2</sup> grey W 10.2mm L 95.7mm max. 57A max 1000V for combi-steamer cross section 10mm <sup>2</sup>		





<b>GEV No.</b>	551427	<b>Ref. No.</b>	4056402
<b>description</b>	rail-mounted terminal PHOENIX CONTACT type ST 16-TWIN 0.2-25mm <sup>2</sup> grey W 12.2mm L 108mm max. 76A max 1000V for combi-steamer cross section 16mm <sup>2</sup>		



 <p>1</p>			
<b>GEV No.</b>	551410	<b>Ref. No.</b>	4056990
<b>description</b>	rail-mounted terminal PHOENIX CONTACT type ST 4 4mm <sup>2</sup> blue W 6mm L 56mm max. 30A max 800V		

 <p>1</p>			
<b>GEV No.</b>	551424	<b>Ref. No.</b>	4056988
<b>description</b>	rail-mounted terminal PHOENIX CONTACT type ST2.5-QUATTRO 0.08-4mm <sup>2</sup> grey W 5.2mm L 72mm max. 24A max 800V for combi-steamer cross section 2.5mm <sup>2</sup>		

 <p>1</p>			
<b>GEV No.</b>	551403	<b>Ref. No.</b>	4056405
<b>description</b>	rail-mounted terminal PHOENIX CONTACT type ST 4 4mm <sup>2</sup> grey W 6.2mm L 56mm		

 <p>1</p>			
<b>GEV No.</b>	551392	<b>Ref. No.</b>	4056389
<b>description</b>	rail-mounted terminal PHOENIX CONTACT type ST4-HESI 4mm <sup>2</sup> black W 6.2mm L 76.5mm max. 10A max 400V for combi-steamer 6.3x32		

 <p>1</p>			
<b>GEV No.</b>	551412	<b>Ref. No.</b>	4056404
<b>description</b>	rail-mounted terminal PHOENIX CONTACT type ST 4-PE 4mm <sup>2</sup> green/yellow W 35mm L 56mm for combi-steamer CONVOTHERM		

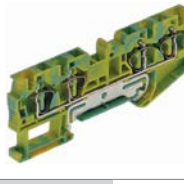
 <p>1</p>			
<b>GEV No.</b>	551429	<b>Ref. No.</b>	4056390
<b>description</b>	rail-mounted terminal PHOENIX CONTACT type ST4-QUATTRO-PE 0.08-6mm <sup>2</sup> yellow/green W 6.2mm L 82mm for combi-steamer cross section 4mm <sup>2</sup>		

 <p>1</p>			
<b>GEV No.</b>	551419	<b>Ref. No.</b>	4056985
<b>description</b>	rail-mounted terminal PHOENIX CONTACT type ST2,5-QUATTRO-PE 0.08-4mm <sup>2</sup> yellow/green W 5.2mm L 72.5mm for combi-steamer cross section 2.5mm <sup>2</sup>		

 <p>1</p>			
<b>GEV No.</b>	551422	<b>Ref. No.</b>	4056406A
<b>description</b>	rail-mounted terminal PHOENIX CONTACT type ST4-TWIN 0.08-6mm <sup>2</sup> grey W 6.2mm L 71.5mm max. 40A max 800V for combi-steamer cross section 4mm <sup>2</sup>		

 <p>1</p>			
<b>GEV No.</b>	551418	<b>Ref. No.</b>	4056987
<b>description</b>	rail-mounted terminal PHOENIX CONTACT type ST2.5-QUATTRO 0.08-4mm <sup>2</sup> blue W 5.2mm L 89.5mm max. 28A max 800V for combi-steamer cross section 2.5mm <sup>2</sup>		

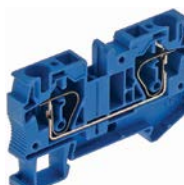
 <p>1</p>			
<b>GEV No.</b>	551417	<b>Ref. No.</b>	4056400
<b>description</b>	rail-mounted terminal PHOENIX CONTACT type ST6 0.2-10mm <sup>2</sup> blue W 8.2mm L 69.5mm max. 50A max 1000V for combi-steamer		

1

<b>GEV No.</b>	551416	<b>Ref. No.</b>	4056398
<b>description</b>	rail-mounted terminal PHOENIX CONTACT type ST6 0.2-10mm <sup>2</sup> grey W 8.2mm L 70mm max. 52A max 1000V for combi-steamer cross section 6mm <sup>2</sup>		



1

<b>GEV No.</b>	551423	<b>Ref. No.</b>	4056397
<b>description</b>	rail-mounted terminal PHOENIX CONTACT type UKH50 16-70mm <sup>2</sup> blue W 20mm L 70.5mm max. 150A max 1000V for combi-steamer cross section 50mm <sup>2</sup>		



1

<b>GEV No.</b>	551414	<b>Ref. No.</b>	4056399
<b>description</b>	rail-mounted terminal PHOENIX CONTACT type ST6-PE 0.2-10mm <sup>2</sup> green/yellow W 8.2mm L 69.5mm		



1

<b>GEV No.</b>	551415	<b>Ref. No.</b>	4056395
<b>description</b>	rail-mounted terminal PHOENIX CONTACT type UKH50 16-70mm <sup>2</sup> grey W 20mm L 76mm max. 150A max 1000V for combi-steamer cross section 50mm <sup>2</sup>		



1

<b>GEV No.</b>	551430	<b>Ref. No.</b>	4056834
<b>description</b>	rail-mounted terminal PHOENIX CONTACT type ST6-TWIN 0.2-10mm <sup>2</sup> grey W 8.2mm L 90.5mm max. 52A max 1000V for combi-steamer cross section 6mm <sup>2</sup>		



1

<b>GEV No.</b>	551413	<b>Ref. No.</b>	4056989
<b>description</b>	rail-mounted terminal PHOENIX CONTACT type UKH95 25-95mm <sup>2</sup> grey W 25mm L 83mm max. 232A max 1000V for combi-steamer		

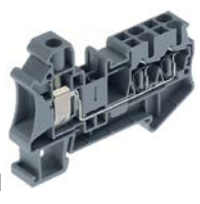

1

<b>GEV No.</b>	551406	<b>Ref. No.</b>	4056411
<b>description</b>	rail-mounted terminal PHOENIX CONTACT type STU10/4x2.5 0.5-16mm <sup>2</sup> grey W 10.3mm L 68mm max. 57A max 800V for combi-steamer cross section 10mm <sup>2</sup>		

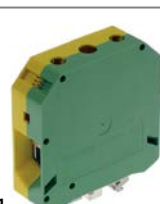

1

<b>GEV No.</b>	551425	<b>Ref. No.</b>	4056833
<b>description</b>	rail-mounted terminal PHOENIX CONTACT type USLKG 95 25-95mm <sup>2</sup> yellow/green W 25mm L 83mm for combi-steamer cross section 95mm <sup>2</sup>		

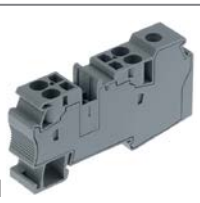

1

<b>GEV No.</b>	551405	<b>Ref. No.</b>	4056410
<b>description</b>	rail-mounted terminal PHOENIX CONTACT type STU35/4x10 1.5-50mm <sup>2</sup> grey W 16.2mm L 86mm max. 125A max 1000V for combi-steamer cross section 35mm <sup>2</sup>		





1

<b>GEV No.</b>	551426	<b>Ref. No.</b>	4056396
<b>description</b>	rail-mounted terminal PHOENIX CONTACT type USLKG50 16-50mm <sup>2</sup> yellow/green W 20mm L 70.5mm for combi-steamer cross section 50mm <sup>2</sup>		





 <p>1</p>			
<b>GEV No.</b>	551408	<b>Ref. No.</b>	4056394
<b>description</b>	rail-mounted terminal PHOENIX CONTACT type UT 35 1.5-50mm <sup>2</sup> blue W 16mm L 59mm max. 150A max 1000V for combi-steamer cross section 35mm <sup>2</sup>		

 <p>1</p>			
<b>GEV No.</b>	551404	<b>Ref. No.</b>	4056392
<b>description</b>	rail-mounted terminal PHOENIX CONTACT type UT 35 1.5-50mm <sup>2</sup> grey W 16mm L 60mm max. 150A max 1000V for combi-steamer cross section 35mm <sup>2</sup>		

 <p>1</p>			
<b>GEV No.</b>	551409	<b>Ref. No.</b>	4056393
<b>description</b>	rail-mounted terminal PHOENIX CONTACT type UT 35-PE 1.5-35mm <sup>2</sup> green/yellow W 16mm L 63mm max. 125A for combi-steamer		

 <p>1</p>			
<b>GEV No.</b>	551428	<b>Ref. No.</b>	4056831
<b>description</b>	terminal PHOENIX CONTACT type UHV95 35-95mm <sup>2</sup> grey W 40mm L 110mm max. 232A max 1000V for combi-steamer		

accessories universal			
terminal block end brackets			
 <p>1</p>			
<b>GEV No.</b>	551389	<b>Ref. No.</b>	4056403
<b>description</b>	isolation barrier for rail-mounted terminal L 108mm W 2.2mm H 44mm PHOENIX CONTACT D-ST 16-TWIN		

 <p>1</p>			
<b>GEV No.</b>	551388	<b>Ref. No.</b>	4056413A
<b>description</b>	isolation barrier for rail-mounted terminal L 56mm W 2.2mm H 29mm PHOENIX CONTACT D-ST 4		

 <p>1</p>			
<b>GEV No.</b>	551385	<b>Ref. No.</b>	4056412
<b>description</b>	isolation barrier for rail-mounted terminal L 68mm W 2.2mm H 40.7mm PHOENIX CONTACT D-STU 10		

 <p>1</p>			
<b>GEV No.</b>	551384	<b>Ref. No.</b>	4056401A
<b>description</b>	isolation barrier for rail-mounted terminal L 69.5mm W 2.2mm H 36mm PHOENIX CONTACT D-ST6		

 <p>1</p>			
<b>GEV No.</b>	551386	<b>Ref. No.</b>	4056407A
<b>description</b>	isolation barrier for rail-mounted terminal L 71.5mm W 2.2mm H 29mm PHOENIX CONTACT D-ST 4-TWIN		

 <p>1</p>			
<b>GEV No.</b>	551387	<b>Ref. No.</b>	4056986
<b>description</b>	isolation barrier for rail-mounted terminal L 72mm W 2.2mm H 29mm PHOENIX CONTACT D-ST 2.5-QUATTRO		

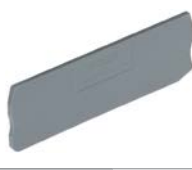
 <p>1</p>			
<b>GEV No.</b>	551391	<b>Ref. No.</b>	4056391A
<b>description</b>	isolation barrier for rail-mounted terminal L 87mm W 2.2mm H 29mm PHOENIX CONTACT D-ST 4-QUATTRO		



			
1			
<b>GEV No.</b>	551393	<b>Ref. No.</b>	4056835
<b>description</b>	isolation barrier for rail-mounted terminal L 90.5mm W 2.2mm H 36mm PHOENIX CONTACT D-ST6 TWIN		

			
1			
<b>GEV No.</b>	551390	<b>Ref. No.</b>	4056409
<b>description</b>	isolation barrier for rail-mounted terminal L 95.5mm W 2.2mm H 42.5mm PHOENIX CONTACT D-ST 10-TWIN		

## electronic components

### software

### service sets

			
1			
<b>GEV No.</b>	403078	<b>Ref. No.</b>	5019011
<b>description</b>	programmer suitable for CONVOTHERM P3-devices incl. SD Carte and Software		

## gas valves and ignition boxes



### gas control valves

### DUNGS

			
1			
<b>GEV No.</b>	106909	<b>Ref. No.</b>	2625175 6006191
<b>description</b>	gas valve 230V 50/60Hz gas inlet 1/2" gas outlet 1/2" total length 105mm DUNGS type GB-LEP 055 D01 S42		
<b>For models:</b>	OD10.10, OD12.20, OD20.20, OD6.10, OSG10.10, OSG12.20, OSG20.20, OSG6.10		

### HONEYWELL

			
1			
<b>GEV No.</b>	107873	<b>Ref. No.</b>	6056952
<b>description</b>	gas valve type VE420AA1001 230V 50Hz gas inlet 3/4" gas outlet 3/4" pressure range 17-23mbar max 200mbar HONEYWELL suitable for CONVOTHERM 4		

			
1			
<b>GEV No.</b>	107841	<b>Ref. No.</b>	6056955
<b>description</b>	gas valve type VK4115V 220-240V 50/60Hz gas inlet flange 32x32mm gas outlet flange 32x32mm thermocouple connection pilot connection pressure range 15-60mbar max 60mbar HONEYWELL hole distance 24mm M5 flange flange 32x32mmmm		
<b>accessories for</b>	107841		
	<b>GEV No.</b>	102845	<b>Ref. No.</b> —
	<b>GEV No.</b>	102846	<b>Ref. No.</b> —



			
1			
<b>GEV No.</b>	106012	<b>Ref. No.</b>	6016010
<b>description</b>	gas valve type VK4115V 220-240V 50/60Hz gas inlet flange 32x32mm gas outlet flange 32x32mm thermocouple connection pilot connection pressure range 15-60mbar max 60mbar operator type HONEYWELL hole distance 24mm flange 32x32mm		
<b>For models:</b>	OGB10.10, OGB10.20, OGB12.20, OGB20.10, OGB20.20, OGB6.10, OGB6.20, OGS10.10, OGS10.20, OGS12.20, OGS20.10, OGS20.20, OGS6.10, OGS6.20		
<b>accessories for</b>	106012		
	<b>GEV No.</b>	102845	<b>Ref. No.</b> —

Table continues overleaf





<b>accessories for</b>	106012		
	<b>GEV No.</b>	102846	<b>Ref. No.</b> —
	gas connection straight 1/2" flange 32x32mm hole distance 24x24mm suitable for Tandem		

SIT

ELETTROSIT



<b>GEV No.</b>	101993	<b>Ref. No.</b>	5001051
<b>description</b>	gas valve SIT type ELETTROSIT 230V gas inlet 1/2" gas outlet 1/2" thermocouple connection M9x1 pilot connection M10x1 lateral equiv. no. 0.810.126		
<b>For models:</b>	OD10.20, OD12.20		
<b>spare parts for</b>	101993		
	<b>GEV No.</b>	101312	<b>Ref. No.</b> 5001050
	microswitch		
	<b>GEV No.</b>	101352	<b>Ref. No.</b> —
	solenoid coil 230V 50Hz suitable for ELETTROSIT		
<b>accessories for</b>	101993		
	<b>GEV No.</b>	100006	<b>Ref. No.</b> —
	piezoelectric igniter suitable for ELETTROSIT body plastic blowing connection ø2.4mm ø 14mm		
	<b>GEV No.</b>	100904	<b>Ref. No.</b> —
	locking screw M10x1 for pipe ø 4mm Qty 1 pcs		
	<b>GEV No.</b>	100905	<b>Ref. No.</b> —
	locking screw M10x1 for pipe ø 6mm Qty 1 pcs		
	<b>GEV No.</b>	101301	<b>Ref. No.</b> —
	gas connection thread 1/2" straight ELETTROSIT screw with O-ring		
	<b>GEV No.</b>	101303	<b>Ref. No.</b> —
	gas connection straight thread 3/4" ELETTROSIT		
	<b>GEV No.</b>	101309	<b>Ref. No.</b> —
	extension		
	<b>GEV No.</b>	103104	<b>Ref. No.</b> —
	ignition switch		
	<b>GEV No.</b>	541504	<b>Ref. No.</b> —
	double nipple thread 1/2" - 1/2"		

NOVASIT

accessories



<b>GEV No.</b>	101312	<b>Ref. No.</b>	5001050
<b>description</b>	microswitch		
<b>For models:</b>	OD10.20, OD12.20		

ignition boxes

DUNGS



<b>GEV No.</b>	103102	<b>Ref. No.</b>	6006190
<b>description</b>	ignition box type DGAL.73 model 10.5.0TCL electrodes 2 starting time <10s waiting time >3s safety time <5s 230V 50/60Hz ignition cable male faston 2.8mm DUNGS protection IP20		
<b>For models:</b>	OD10.10, OD12.20, OD20.20, OD6.10, OSG10.10, OSG12.20, OSG20.20, OSG6.10		

HONEYWELL



<b>GEV No.</b>	106606	<b>Ref. No.</b>	6016021
<b>description</b>	ignition box HONEYWELL type S4575B 1025 electrodes 3 waiting times safety time 5s 230-240V 4VA 50/60Hz		

2 gas components

Honeywell



1

<b>GEV No.</b>	106755	<b>Ref. No.</b>	6016020 6016022
<b>description</b>	ignition box HONEYWELL type S4575B 1066 electrodes 3 waiting times safety time 5s 230-240V 4VA 50/60Hz		
<b>For models:</b>	OGB10.10, OGB10.20, OGB12.20, OGB20.10, OGB20.20, OGB6.10, OGB6.20, OGS10.10, OGS10.20, OGS12.20, OGS20.10, OGS20.20, OGS6.10, OGS6.20		

Honeywell



2

<b>GEV No.</b>	107860	<b>Ref. No.</b>	6056957
<b>description</b>	ignition box HONEYWELL type S4965V3075 electrodes 1 safety time 5s 230V 2.5VA 50Hz		

## ignition parts

### pilot burners

SIT

100 series



1



<b>GEV No.</b>	106727	<b>Ref. No.</b>	5001088 6006160
<b>description</b>	pilot burner SIT type 100 series 3 flames LPG nozzle ø 0.35mm gas connection 6mm incl. 1x nozzle 0.25 LPG		
<b>For models:</b>	OD10.20, OD12.20		

### accessories

#### pilot burner bottom parts



1

<b>GEV No.</b>	107700	<b>Ref. No.</b>	6006101	
<b>description</b>	pilot burner bottom part SIT 100 series nozzle ø 0.25mm			
<b>For models:</b>	OD10.20, OD12.20			
<b>spare parts for</b>	107700			
	<b>GEV No.</b>	100916	<b>Ref. No.</b>	—
	compression spring for pilot burner Qty 1 pcs			
	<b>GEV No.</b>	100917	<b>Ref. No.</b>	—
	gasket for pilot burner Qty 1 pcs aluminium ID ø 8.5mm ED ø 11mm thickness 1.2mm			
	<b>GEV No.</b>	100918	<b>Ref. No.</b>	—
	screw for pilot burner			
	<b>GEV No.</b>	102742	<b>Ref. No.</b>	—
	pilot burner nozzle LPG code 25 bore ø 0.25mm Qty 1 pcs			
<b>accessories for</b>	107700			
	<b>GEV No.</b>	100245	<b>Ref. No.</b>	—
	pilot burner nozzle LPG code 20 bore ø 0.2mm Qty 1 pcs thread M8x0.75			
	<b>GEV No.</b>	100246	<b>Ref. No.</b>	—
	pilot burner nozzle natural gas bore ø 0.35mm Qty 1 pcs thread M8x0.75			
	<b>GEV No.</b>	100904	<b>Ref. No.</b>	—
	locking screw M10x1 for pipe ø 4mm Qty 1 pcs			
	<b>GEV No.</b>	100905	<b>Ref. No.</b>	—
	locking screw M10x1 for pipe ø 6mm Qty 1 pcs			
	<b>GEV No.</b>	102110	<b>Ref. No.</b>	—
	pilot tube copper pipe ø 4mm thickness 1mm L 3000mm			
	<b>GEV No.</b>	102111	<b>Ref. No.</b>	—
	pilot tube copper pipe ø 6mm thickness 1mm L 3000mm			

#### pilot burner nozzles



1

<b>GEV No.</b>	102972	<b>Ref. No.</b>	6005182
<b>description</b>	pilot burner nozzle natural gas code 40 bore ø 0.4mm Qty 1 pcs		
<b>For models:</b>	OD10.20, OD12.20, OSG10.10, OSG12.20, OSG20.20, OSG6.10		



electrodes



1

<b>GEV No.</b>	102476	<b>Ref. No.</b>	2617322 4018001 C4018001
<b>description</b>	glow plug conversion kit flange length 41mm flange width 20mm ø 11mm mounting distance 29mm cable length 60mm connection male faston 2.8mm total length 101mm L1 73mm L2 28mm 24V		
<b>For models:</b>	OGB10.20, OGB12.20, OGB20.10, OGB20.20, OGS10.20, OGS12.20, OGS20.10, OGS20.20		



1

<b>GEV No.</b>	102477	<b>Ref. No.</b>	2617321 4018002
<b>description</b>	ignition electrode conversion kit flange length 41mm flange width 20mm ø 11mm mounting distance 29mm cable length 60mm con- nection male faston 2.8mm total length 64mm L1 54mm L2 10mm 24V		
<b>For models:</b>	OGB10.10, OGB20.10, OGB6.10, OGB6.20, OGS10.10, OGS20.10, OGS6.10, OGS6.20		



1

<b>GEV No.</b>	106517	<b>Ref. No.</b>	4008101
<b>description</b>	ignition electrode D1 ø 7mm D2 ø 8mm connection M4 L1 13mm BL1 18mm BL2 3mm BL3 23mm		
<b>For models:</b>	OD10.10, OD12.20, OD20.20, OD6.10, OSG10.10, OSG12.20, OSG20.20, OSG6.10		

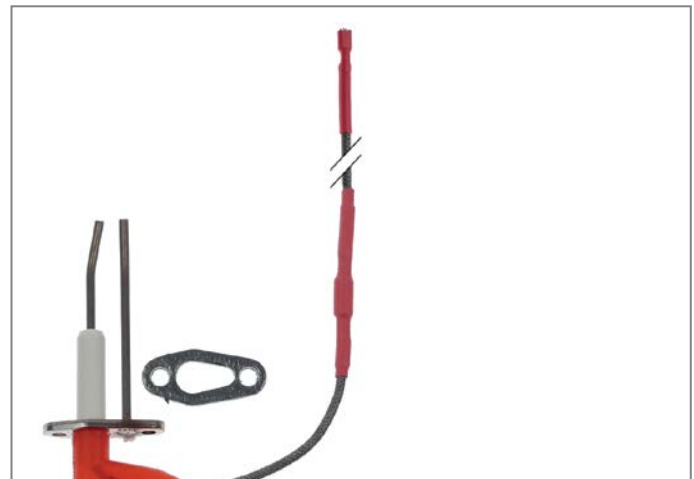

1

<b>GEV No.</b>	107839	<b>Ref. No.</b>	4056951
<b>description</b>	ignition electrode flange length 38mm flange width 16mm D1 ø 9.5mm L1 36.5mm BL1 30mm connection 2.8x0.8 cable length 400mm fixing dimensions 4.5mm mounting distance 28mm with mounting accessories		



1

<b>GEV No.</b>	107844	<b>Ref. No.</b>	4056950
<b>description</b>	ignition electrode set flange length 38mm flange width 17mm D1 ø 7mm L1 22mm L2 96mm BL1 62mm connection 2.8x0.8 cable length 400mm mounting distance 28mm M4 with mounting accessories CONVOTHERM model C4 Serie		



1

<b>GEV No.</b>	106516	<b>Ref. No.</b>	4008104
<b>description</b>	monitoring electrode D1 ø 7mm D2 ø 8mm connection M4 L1 19mm BL1 18mm BL2 3mm BL3 22mm		
<b>For models:</b>	OD10.10, OD12.20, OD20.20, OD6.10, OSG10.10, OSG12.20, OSG20.20, OSG6.10		

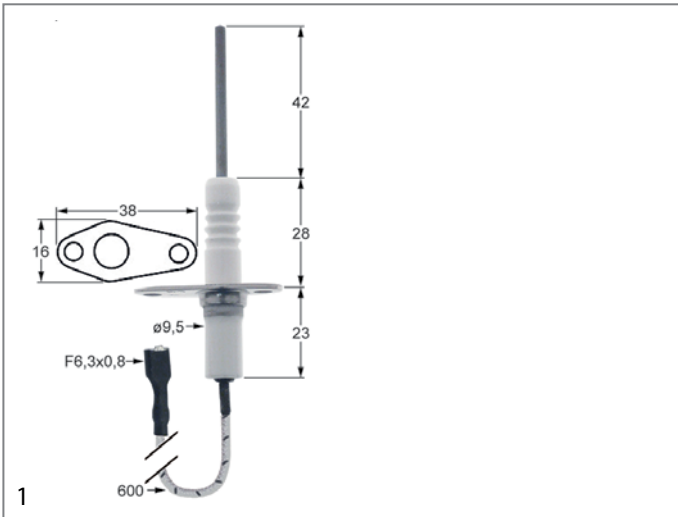

<b>GEV No.</b>	109183 <sup>1</sup>	<b>Ref. No.</b>	2617320 4018000 c4018000
<b>description</b>	monitoring electrode flange length 38mm D1 ø 9.5mm flange width 16mm L1 42mm BL1 28mm BL2 23mm connection F6.3x0.8 cable length 600mm with gasket and shrink tube		
<b>For models:</b>	OGB10.10, OGB10.20, OGB12.20, OGB20.10, OGB20.20, OGB6.10, OGB6.20, OGS10.10, OGS10.20, OGS12.20, OGS20.10, OGS20.20, OGS6.10, OGS6.20		

<sup>1</sup>with gasket and shrink tube

## ignition cables

### pre-assembled cables

<b>GEV No.</b>	106514	<b>Ref. No.</b>	4008103
<b>description</b>	connecting cable for monitoring electrode cable length 1200mm connection F6.3/ø6mm		
<b>For models:</b>	OD10.10, OD12.20, OD20.20, OD6.10, OSG10.10, OSG12.20, OSG20.20, OSG6.10		

<b>GEV No.</b>	106515	<b>Ref. No.</b>	4008100
<b>description</b>	ignition cable cable length 1200mm connection F2.8/ø6mm		
<b>For models:</b>	OD10.10, OD12.20, OD20.20, OD6.10, OSG10.10, OSG12.20, OSG20.20, OSG6.10		

## thermocouples

### plug-in thermocouples

### plug-in thermocouples with interruption

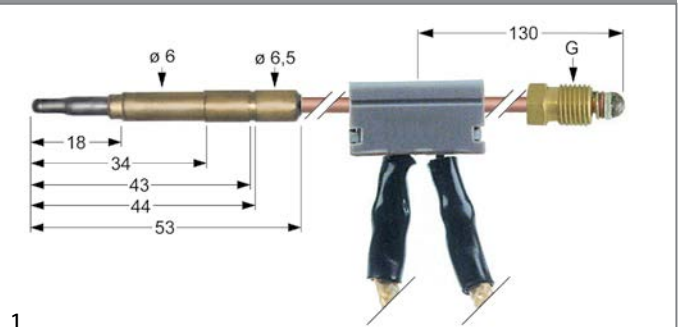

<b>GEV No.</b>	103103	<b>Ref. No.</b>	5009048
<b>description</b>	thermocouple with interrupter M9x1 L 1000mm plug connection ø6.0mm cable		
<b>For models:</b>	OD10.20, OD12.20		

## accessories

### miscellaneous



<b>GEV No.</b>	519625	<b>Ref. No.</b>	6056351
<b>description</b>	gasket for thermocouple ø 15mm ID ø 5mm H 1mm graphite suitable for combi-steamer series CONVOTHERM 4 Qty 5 pcs		

## gas burners

### forced air burners

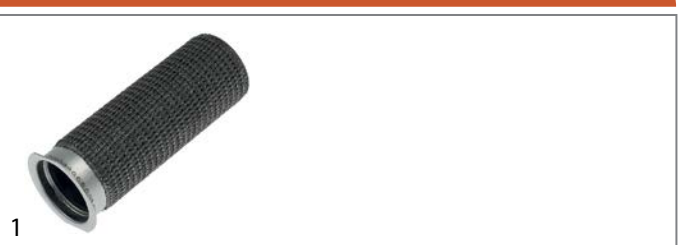

<b>GEV No.</b>	107842	<b>Ref. No.</b>	2010014
<b>description</b>	burner L 150mm ø 50mm 20kW combi-steamer		
<b>For models:</b>	OGB10.10, OGB20.10, OGB6.10, OGB6.20, OGS10.10, OGS20.10, OGS6.10, OGS6.20		



<b>GEV No.</b>	107840	<b>Ref. No.</b>	2010015
<b>description</b>	burner L 210mm ø 63mm 40kW combi-steamer CONVOTHERM series P3		
<b>For models:</b>	OGB10.20, OGB12.20, OGB20.10, OGB20.20, OGS10.20, OGS12.20, OGS20.10, OGS20.20		



			
1			
<b>GEV No.</b>	108150	<b>Ref. No.</b>	6016000 CV6056960
<b>description</b>	venturi MKN combi-steamer with gasket		
<b>For models:</b>	OGB10.10, OGB20.10, OGB6.10, OGB6.20, OGS10.10, OGS20.10, OGS6.10, OGS6.20		

accessories

gaskets

			
1			
<b>GEV No.</b>	112834	<b>Ref. No.</b>	6064078
<b>description</b>	gasket for burner chamber ø 140mm thickness 2mm graphite for combi-steamer suitable for CONVOTHERM 4 series 6.10/6.20/10.10		

gas nozzles

main nozzles

gas nozzles M10x1

			
1			
<b>GEV No.</b>	106405	<b>Ref. No.</b>	6005177
<b>description</b>	gas injector thread M10x1 bore ø 2mm L 30mm WS 12		

pilot burner nozzles

pilot burner nozzles SIT

100 series

			
1			
<b>GEV No.</b>	102972	<b>Ref. No.</b>	6005182
<b>description</b>	pilot burner nozzle natural gas code 40 bore ø 0.4mm Qty 1 pcs		
<b>For models:</b>	OD10.20, OD12.20, OSG10.10, OSG12.20, OSG20.20, OSG6.10		

			
1			
<b>GEV No.</b>	107171	<b>Ref. No.</b>	6006008
<b>description</b>	pilot burner nozzle SIT natural/liquid gas bore ø 0.25mm Qty 1 pcs		
<b>For models:</b>	OD10.20, OD12.20, OSG10.10, OSG12.20, OSG20.20, OSG6.10		

consumables

PTFE tapes

			
1			
<b>GEV No.</b>	890100	<b>Ref. No.</b>	7004052
<b>description</b>	PTFE tape reel L 12m W 12mm -200 up to +260°C approval DIN-DVGW, KTW temperature-resistant, elastic for fine thread thickness 0.1mm		
<b>description</b>	PTFE thread sealing tape for fine metal threads Application: All sanitary and heating circuits in hot and cold water areas. DVGW tested. DIN EN751-3. For fine thread DN < 10. Pressure: up to 20 bar. Temperature range: -60°C to +260°C		

thread sealants

			
1			
<b>GEV No.</b>	890097	<b>Ref. No.</b>	7004016
<b>description</b>	thread sealing LOCTITE 577 medium-strength bottle 50ml pipe thread sealing t.max. 150°C approval BAM and DVGW		
<b>description</b>	LOCTITE® 577™ - bottle 50ml It is designed for the locking and sealing of metal pipes and fittings as well as other cylindrical metal assemblies. The product provides an instant, low-pressure seal for metal pipes and fittings. It will not creep, shrink or block systems by shredding. Suitable for fast application at low temperatures. It has excellent chemical and thermal resistance and offers less migration of liquid product after application to the part.		

equipmentspecific units

for convection ovens/combi-steamers

drain units

drip rails

			
1			
<b>GEV No.</b>	692302	<b>Ref. No.</b>	2018000 2018006
<b>description</b>	drip rail L 500mm ABS plastic hole ø 5.5mm mounting distance 299mm for combi-steamer hose ø 15mm		
<b>For models:</b>	OEB10.10, OEB6.10, OES10.10, OES6.10, OGB10.10, OGB6.10, OGS10.10, OGS6.10		



			
1			
<b>GEV No.</b>	694425	<b>Ref. No.</b>	2616469
<b>description</b>	drip rail L 500mm plastic W 34mm hole ø 5mm for combi-steamer		
<b>For models:</b>	OEB10.10, OEB6.10, OES10.10, OES6.10, OGB10.10, OGB6.10, OGS10.10, OGS6.10		

			
1			
<b>GEV No.</b>	699355	<b>Ref. No.</b>	2556335
<b>description</b>	drip rail L 520mm W 25mm suitable for 6.10/10.10 Convotherm 4		

			
1			
<b>GEV No.</b>	699361	<b>Ref. No.</b>	2556345
<b>description</b>	drip rail push-in L 480mm plastic W 100mm for combi-steamer 6.10/10.10 Convotherm 4		

			
1			
<b>GEV No.</b>	699356	<b>Ref. No.</b>	2556346
<b>description</b>	drip rail push-in L 685mm W 60mm H 95mm suitable for 6.20/10.20 Convotherm 4		

### drain valves

			
1			
<b>GEV No.</b>	696784	<b>Ref. No.</b>	2623535
<b>description</b>	drain connection stainless steel for combi-steamer		

### steam generators

#### steam generators



			
1			
<b>GEV No.</b>	692212	<b>Ref. No.</b>	2306118 2323768
<b>description</b>	steam generator W 610mm H 525mm D 115mm		

			
1			
<b>GEV No.</b>	692593	<b>Ref. No.</b>	2016300
<b>description</b>	ventilation valve combi-steamer L 120mm W 120mm ø 43mm 12VDCV suitable for Mini series		
<b>For models:</b>	OES6.06		



### injection nozzles

			
1			
<b>GEV No.</b>	542356	<b>Ref. No.</b>	6005413
<b>description</b>	injection nozzle bore ø 1.5mm WS 14 T1: M10x1		
<b>For models:</b>	OEB10.10, OEB10.20, OEB12.20, OEB20.10, OEB20.20, OEB6.10, OEB6.20, OES10.10, OES10.20, OES12.20, OES20.10, OES20.20, OES6.10, OES6.20, OGB10.10, OGB10.20, OGB12.20, OGB20.10, OGB20.20, OGB6.10, OGB6.20, OGS10.10, OGS10.20, OGS12.20, OGS20.10, OGS20.20, OGS6.10, OGS6.20, OS10.10, OS10.20, OS12.20, OS20.10, OS20.20, OS6.10, OSP10.10, OSP10.20, OSP12.20, OSP20.10, OSP20.20, OSP6.10		





<b>GEV No.</b>	692594	<b>Ref. No.</b>	2226368 2230016
<b>description</b>	injection nozzle bore $\varnothing$ 1mm suitable for P3 D1 $\varnothing$ 10mm D2 $\varnothing$ 10mm L 130mm brass for steam generation mounting pos. left		
<b>spare parts for</b>	692594		
	<b>GEV No.</b>	541508	<b>Ref. No.</b> 6006140
	manometer $\varnothing$ 40mm pressure range 0-4bar connection thread 1/8"		
	<b>GEV No.</b>	541806	<b>Ref. No.</b> 5009061 5009063
	pressure control $\varnothing$ 38mm pressure range 0.2-3.0bar connection 1/8" 250V 10A GP600 pressure connection 1/8"		





<b>GEV No.</b>	692177	<b>Ref. No.</b>	2217332
<b>description</b>	injection nozzle with pressure switch and monometer bore $\varnothing$ 0.5mm D1 $\varnothing$ 12mm D2 $\varnothing$ 12mm L 60mm stainless steel for combi-steamer		
<b>For models:</b>	OEB6.10, OES6.06, OES6.10, OGB6.10, OGS6.10		
<b>spare parts for</b>	692177		
	<b>GEV No.</b>	541508	<b>Ref. No.</b> 6006140
	manometer $\varnothing$ 40mm pressure range 0-4bar connection thread 1/8"		
	<b>GEV No.</b>	541806	<b>Ref. No.</b> 5009061 5009063
	pressure control $\varnothing$ 38mm pressure range 0.2-3.0bar connection 1/8" 250V 10A GP600 pressure connection 1/8"		



<b>GEV No.</b>	692768	<b>Ref. No.</b>	2223452
<b>description</b>	injection nozzle double with pressure switch and monometer bore $\varnothing$ 0.6mm D1 $\varnothing$ 10.5mm D2 $\varnothing$ 10.5mm L 60mm SS/brass for combi-steamer OES/OGS		
<b>spare parts for</b>	692768		
	<b>GEV No.</b>	541508	<b>Ref. No.</b> 6006140
	manometer $\varnothing$ 40mm pressure range 0-4bar connection thread 1/8"		
	<b>GEV No.</b>	541806	<b>Ref. No.</b> 5009061 5009063
	pressure control $\varnothing$ 38mm pressure range 0.2-3.0bar connection 1/8" 250V 10A GP600 pressure connection 1/8"		





<b>GEV No.</b>	692169	<b>Ref. No.</b>	2217333
<b>description</b>	injection nozzle with pressure switch and monometer bore $\varnothing$ 0.6mm D1 $\varnothing$ 12mm D2 $\varnothing$ 12mm L 60mm brass for combi-steamer		
<b>For models:</b>	OEB10.10, OEB10.20, OEB6.20, OES10.10, OES10.20, OES6.20, OGB10.10, OGB10.20, OGB6.20, OGS10.10, OGS10.20, OGS6.20		
<b>spare parts for</b>	692169		
	<b>GEV No.</b>	541508	<b>Ref. No.</b> 6006140
	manometer $\varnothing$ 40mm pressure range 0-4bar connection thread 1/8"		
	<b>GEV No.</b>	541806	<b>Ref. No.</b> 5009061 5009063
	pressure control $\varnothing$ 38mm pressure range 0.2-3.0bar connection 1/8" 250V 10A GP600 pressure connection 1/8"		

mechanical components, equipment accessories



1

<b>GEV No.</b>	692592	<b>Ref. No.</b>	2217335
<b>description</b>	pressure monitor suitable for Mini series bore $\phi$ 1mm D1 $\phi$ 10mm D2 $\phi$ 10mm L 130mm brass for steam generation mounting pos. at the back right		
<b>For models:</b>	OEB20.10, OEB20.20, OES20.10, OES20.20, OGB20.10, OGB20.20, OGS20.10, OGS20.20		
<b>spare parts for</b>	692592		
	<b>GEV No.</b>	541508	<b>Ref. No.</b> 6006140
	manometer $\phi$ 40mm pressure range 0-4bar connection thread 1/8"		
	<b>GEV No.</b>	541806	<b>Ref. No.</b> 5009061 5009063
	pressure control $\phi$ 38mm pressure range 0.2-3.0bar connection 1/8" 250V 10A GP600 pressure connection 1/8"		

## injection pipes



1

<b>GEV No.</b>	692746	<b>Ref. No.</b>	2225074 6015216
<b>description</b>	injection pipe for combi-steamer H 80mm with gasket and nut ED $\phi$ 10mm L 210mm thread M14x1		
<b>For models:</b>	OEB10.10, OEB10.20, OEB12.20, OEB20.10, OEB20.20, OEB6.10, OEB6.20, OES10.10, OES10.20, OES12.20, OES20.10, OES20.20, OES6.10, OES6.20, OGB10.10, OGB10.20, OGB12.20, OGB20.10, OGB20.20, OGB6.10, OGB6.20, OGS10.10, OGS10.20, OGS12.20, OGS20.10, OGS20.20, OGS6.10, OGS6.20		



1

<b>GEV No.</b>	692736	<b>Ref. No.</b>	2016073 2016305
<b>description</b>	injection pipe for combi-steamer L 210mm H 80mm thread M14x1 $\phi$ 10mm		
<b>For models:</b>	OEB10.10, OEB20.10, OEB6.10, OES10.10, OES20.10, OES6.10, OGB10.10, OGB20.10, OGB6.10, OGS10.10, OGS20.10, OGS6.10		

## spare parts and accessories



1

<b>GEV No.</b>	699829	<b>Ref. No.</b>	2004035
<b>description</b>	bracket for cable H 8.5mm $\phi$ 29mm M4		
<b>For models:</b>	OEB10.10, OEB10.20, OEB12.20, OEB20.10, OEB20.20, OEB6.10, OEB6.20, OES10.10, OES10.20, OES12.20, OES20.10, OES20.20, OES6.10, OES6.20, OGB10.10, OGB10.20, OGB12.20, OGB20.10, OGB20.20, OGB6.10, OGB6.20, OGS10.10, OGS10.20, OGS12.20, OGS20.10, OGS20.20, OGS6.10, OGS6.20		



1

<b>GEV No.</b>	696786	<b>Ref. No.</b>	6013059
<b>description</b>	bracket for vibration pump L 85mm W 45mm H 70mm mounting distance 25/50mm rubber		



1

<b>GEV No.</b>	699840	<b>Ref. No.</b>	6006081
<b>description</b>	drain plug for steam generator H 20mm 1 1/4"		
<b>For models:</b>	OD10.10, OD10.20, OD12.20, OD20.10, OD20.20, OD6.10, OS10.10, OS10.20, OS12.20, OS20.10, OS20.20, OS6.10, OSC10.10, OSC10.20, OSC12.20, OSC20.10, OSC20.20, OSC6.10, OSP10.10, OSP10.20, OSP12.20, OSP20.10, OSP20.20, OSP6.10		



1

<b>GEV No.</b>	699824	<b>Ref. No.</b>	2615367
<b>description</b>	flange for burner L 84mm W 65mm H 1.2mm		
<b>For models:</b>	OGB10.10, OGB20.10, OGB6.10, OGB6.20, OGS10.10, OGS20.10, OGS6.10, OGS6.20		



1

<b>GEV No.</b>	112834	<b>Ref. No.</b>	6064078
<b>description</b>	gasket for burner chamber $\phi$ 140mm thickness 2mm graphite for combi-steamer suitable for CONVOTHERM 4 series 6.10/6.20/10.10		



1

<b>GEV No.</b>	519625	<b>Ref. No.</b>	6056351
<b>description</b>	gasket for thermocouple $\phi$ 15mm ID $\phi$ 5mm H 1mm graphite suitable for combi-steamer series CONVOTHERM 4 Qty 5 pcs		







			
1			
<b>GEV No.</b>	699821	<b>Ref. No.</b>	6005048
<b>description</b>	grommet for ventilation H 7.5mm ø 60mm ID ø 35mm		
<b>For models:</b>	OD10.10, OD10.20, OD12.20, OD20.10, OD20.20, OD6.10, OEB10.10, OEB10.20, OEB12.20, OEB20.10, OEB20.20, OEB6.10, OEB6.20, OES10.10, OES10.20, OES12.20, OES20.10, OES20.20, OES6.06, OES6.10, OES6.20, OGB10.10, OGB10.20, OGB12.20, OGB20.10, OGB20.20, OGB6.10, OGB6.20, OGS10.10, OGS10.20, OGS12.20, OGS20.10, OGS20.20, OGS6.10, OGS6.20, OS10.10, OS10.20, OS12.20, OS20.10, OS20.20, OS6.10, OSC10.10, OSC10.20, OSC12.20, OSC20.10, OSC20.20, OSC6.10, OSP10.10, OSP10.20, OSP12.20...(Other models you can see in the webshop)		

			
1			
<b>GEV No.</b>	699823	<b>Ref. No.</b>	6005427
<b>description</b>	grommet for ventilation H 9mm ø 83mm ID ø 53mm		
<b>For models:</b>	OEB10.10, OEB10.20, OEB12.20, OEB20.10, OEB20.20, OEB6.10, OEB6.20, OES10.10, OES10.20, OES12.20, OES20.10, OES20.20, OES6.10, OES6.20, OGB10.10, OGB10.20, OGB12.20, OGB20.10, OGB20.20, OGB6.10, OGB6.20, OGS10.10, OGS10.20, OGS12.20, OGS20.10, OGS20.20, OGS6.10, OGS6.20		

			
1			
<b>GEV No.</b>	692738	<b>Ref. No.</b>	2617294
<b>description</b>	mounting set for motor		
<b>For models:</b>	OEB10.10, OEB10.20, OEB12.20, OEB20.10, OEB20.20, OEB6.10, OEB6.20, OES10.10, OES10.20, OES12.20, OES20.10, OES20.20, OES6.10, OES6.20, OGB10.10, OGB10.20, OGB12.20, OGB20.10, OGB20.20, OGB6.10, OGB6.20, OGS10.10, OGS10.20, OGS12.20, OGS20.10, OGS20.20, OGS6.10, OGS6.20		

			
1			
<b>GEV No.</b>	692743	<b>Ref. No.</b>	6014004
<b>description</b>	rosette H 5mm 1/2" ED ø 35mm		
<b>For models:</b>	OEB10.10, OEB10.20, OEB12.20, OEB20.10, OEB20.20, OEB6.10, OEB6.20, OES10.10, OES10.20, OES12.20, OES20.10, OES20.20, OES6.10, OES6.20, OGB10.10, OGB10.20, OGB12.20, OGB20.10, OGB20.20, OGB6.10, OGB6.20, OGS10.10, OGS10.20, OGS12.20, OGS20.10, OGS20.20, OGS6.10, OGS6.20		

			
1			
<b>GEV No.</b>	699827	<b>Ref. No.</b>	6015042
<b>description</b>	rubber gasket for sump H 6mm ø 21mm ID ø 7.5mm		
<b>For models:</b>	OEB10.10, OEB10.20, OEB6.10, OEB6.20, OES10.10, OES10.20, OES6.10, OES6.20, OGB10.10, OGB10.20, OGB6.10, OGB6.20, OGS10.10, OGS10.20, OGS6.10, OGS6.20		

			
1			
<b>GEV No.</b>	699826	<b>Ref. No.</b>	6016030 6064077
<b>description</b>	sealing ring H 3.2mm ø 23mm ID ø 15mm		
<b>For models:</b>	OGB10.10, OGB10.20, OGB12.20, OGB20.10, OGB20.20, OGB6.10, OGB6.20, OGS10.10, OGS10.20, OGS12.20, OGS20.10, OGS20.20, OGS6.10, OGS6.20		

			
1			
<b>GEV No.</b>	699828	<b>Ref. No.</b>	6015062
<b>description</b>	sealing ring ø 14mm ID ø 10mm		
<b>For models:</b>	OEB10.10, OEB10.20, OEB12.20, OEB20.10, OEB20.20, OEB6.10, OEB6.20, OES10.10, OES10.20, OES12.20, OES20.10, OES20.20, OES6.10, OES6.20, OGB10.10, OGB10.20, OGB12.20, OGB20.10, OGB20.20, OGB6.10, OGB6.20, OGS10.10, OGS10.20, OGS12.20, OGS20.10, OGS20.20, OGS6.10, OGS6.20		

			
1			
<b>GEV No.</b>	699817	<b>Ref. No.</b>	2014008 2619152
<b>description</b>	support bracket for carriage L 55mm W 12mm H 22mm		
<b>For models:</b>	OEB10.10, OEB10.20, OEB12.20, OEB20.10, OEB20.20, OEB6.10, OEB6.20, OES10.10, OES10.20, OES12.20, OES20.10, OES20.20, OES6.10, OES6.20, OGB10.10, OGB10.20, OGB12.20, OGB20.10, OGB20.20, OGB6.10, OGB6.20, OGS10.10, OGS10.20, OGS12.20, OGS20.10, OGS20.20, OGS6.10, OGS6.20		

<b>filters</b>			
			
1			
<b>GEV No.</b>	700992	<b>Ref. No.</b>	6005024
<b>description</b>	drain filter ø 85mm for combi-steamer		
<b>For models:</b>	HUD10.10, HUD12.20, HUD20.10, HUD20.20, HUD6.10, OD10.10, OD10.20, OD12.20, OD20.10, OD20.20, OD6.10, OS10.10, OS10.20, OS12.20, OS20.10, OS20.20, OS6.10, OSC10.10, OSC10.20, OSC12.20, OSC20.20, OSC6.10, OSP10.10, OSP10.20, OSP12.20, OSP20.20, OSP6.10		



## front panels



1

<b>GEV No.</b>	692745	<b>Ref. No.</b>	2117301
<b>description</b>	control panel model OES/OGS CONVOTHERM series P3 H 600mm W 160mm		
<b>For models:</b>	OEB10.10, OEB10.20, OEB12.20, OEB20.10, OEB20.20, OEB6.10, OEB6.20, OES10.10, OES10.20, OES12.20, OES20.10, OES20.20, OES6.10, OES6.20, OGB10.10, OGB10.20, OGB12.20, OGB20.10, OGB20.20, OGB6.10, OGB6.20, OGS10.10, OGS10.20, OGS12.20, OGS20.10, OGS20.20, OGS6.10, OGS6.20		



1

<b>GEV No.</b>	699847	<b>Ref. No.</b>	5056365
<b>description</b>	housing L 245mm H 350mm D 35		

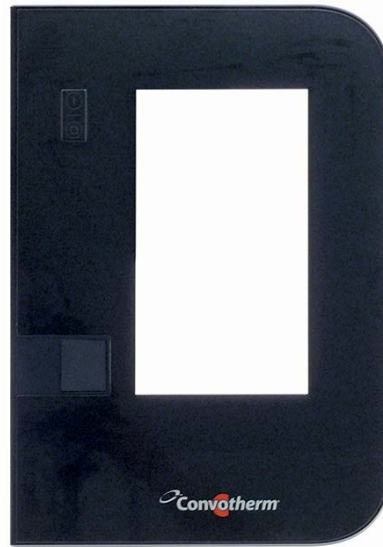

1

<b>GEV No.</b>	699846	<b>Ref. No.</b>	5056364
<b>description</b>	housing L 250mm H 350mm D 34		

## housing and bezels



1

<b>GEV No.</b>	699851	<b>Ref. No.</b>	45056832
<b>description</b>	cover L 95mm W 65mm H 34mm		

## cleaning system

## nozzles



1

<b>GEV No.</b>	694801	<b>Ref. No.</b>	2611010
<b>description</b>	sprinkler nozzle thread M10 hole $\varnothing$ 3.5mm H 29.5mm SS CONVOTHERM		
<b>For models:</b>	OEB10.10, OEB10.20, OEB12.20, OEB20.10, OEB20.20, OEB6.10, OEB6.20, OES10.10, OES10.20, OES12.20, OES20.10, OES20.20, OES6.10, OES6.20, OGB10.10, OGB10.20, OGB12.20, OGB20.10, OGB20.20, OGB6.10, OGB6.20, OGS10.10, OGS10.20, OGS12.20, OGS20.10, OGS20.20, OGS6.10, OGS6.20, OS10.10, OS10.20, OS12.20, OS20.10, OS20.20, OS6.10, OSP10.10, OSP10.20, OSP12.20, OSP20.10, OSP20.20, OSP6.10		



pumps



<b>GEV No.</b>	501563	<b>Ref. No.</b>	5056337
<b>description</b>	pump inlet ø 24 outlet ø 24 type UP30-494 200-240V 50/60Hz 1 phase 0.1kW L 146mm capacitor 2.5µF HANNING hose clamps		

hoses



<b>GEV No.</b>	542152	<b>Ref. No.</b>	2609347 2617594
<b>description</b>	extraction hose D1 ø 6.5mm D2 ø 10mm L 1700mm detergent		
<b>For models:</b>	OEB10.10, OEB10.20, OEB12.20, OEB20.10, OEB20.20, OEB6.10, OEB6.20, OES10.10, OES10.20, OES12.20, OES20.10, OES20.20, OES6.10, OES6.20, OGB10.10, OGB10.20, OGB12.20, OGB20.10, OGB20.20, OGB6.10, OGB6.20, OGS10.10, OGS10.20, OGS12.20, OGS20.10, OGS20.20, OGS6.10, OGS6.20, OS10.10, OS10.20, OS12.20, OS20.10, OS20.20, OS6.10, OSP10.10, OSP10.20, OSP12.20, OSP20.10, OSP20.20, OSP6.10		



<b>GEV No.</b>	694798	<b>Ref. No.</b>	2054369 2609349 2617598
<b>description</b>	extraction hose D1 ø 6.5mm D2 ø 10mm L 1700mm rinse aid		
<b>For models:</b>	OEB10.10, OEB10.20, OEB12.20, OEB20.10, OEB20.20, OEB6.10, OEB6.20, OES10.10, OES10.20, OES12.20, OES20.10, OES20.20, OES6.10, OES6.20, OGB10.10, OGB10.20, OGB12.20, OGB20.10, OGB20.20, OGB6.10, OGB6.20, OGS10.10, OGS10.20, OGS12.20, OGS20.10, OGS20.20, OGS6.10, OGS6.20, OS10.10, OS10.20, OS12.20, OS20.10, OS20.20, OS6.10, OSP10.10, OSP10.20, OSP12.20, OSP20.10, OSP20.20, OSP6.10		



<b>GEV No.</b>	694802	<b>Ref. No.</b>	7012302
<b>description</b>	hose ext. ø 9.8 D1 ø 6mm L 1300mm EPDM black Qty 1		
<b>For models:</b>	OEB10.10, OEB10.20, OEB12.20, OEB20.10, OEB20.20, OEB6.10, OEB6.20, OES10.10, OES10.20, OES12.20, OES20.10, OES20.20, OES6.10, OES6.20, OGB10.10, OGB10.20, OGB12.20, OGB20.10, OGB20.20, OGB6.10, OGB6.20, OGS10.10, OGS10.20, OGS12.20, OGS20.10, OGS20.20, OGS6.10, OGS6.20		

screw connections



<b>GEV No.</b>	361914	<b>Ref. No.</b>	5011003
<b>description</b>	connecting piece 1/2" -3/4" L 82mm plastic		
<b>For models:</b>	OEB10.10, OEB10.20, OEB12.20, OEB20.10, OEB20.20, OEB6.10, OEB6.20, OES10.10, OES10.20, OES12.20, OES20.10, OES20.20, OES6.10, OES6.20, OGB10.10, OGB10.20, OGB12.20, OGB20.10, OGB20.20, OGB6.10, OGB6.20, OGS10.10, OGS10.20, OGS12.20, OGS20.10, OGS20.20, OGS6.10, OGS6.20		

pipes



<b>GEV No.</b>	699816	<b>Ref. No.</b>	6005300
<b>description</b>	connecting fitting L 210mm for water inlet		
<b>For models:</b>	OS10.10, OS10.20, OS12.20, OS20.10, OS20.20, OS6.10, OSC10.10, OSC10.20, OSC12.20, OSC20.10, OSC20.20, OSC6.10, OSP10.10, OSP10.20, OSP12.20, OSP20.10, OSP20.20, OSP6.10		

non-return valves



<b>GEV No.</b>	531322	<b>Ref. No.</b>	6056934
<b>description</b>	backflow preventer for boiler L 88mm connection 10.5/13.5 hose ø 3/4"mm for combi-steamer CONVOTHERM 4		

hoses



<b>GEV No.</b>	506274	<b>Ref. No.</b>	5064082
<b>description</b>	formed hose end piece A ext. ø 28mm end piece A int. ø 22mm AD2 ø 28mm ø end piece B 22mm L 555mm boiler silicone combi-steamer L-shape white		



1

<b>GEV No.</b>	699367	<b>Ref. No.</b>	6064052
<b>description</b>	formed hose int. ø 1 47mm int. ø 2 30mm ED ø 54mm ext. ø 36 L 100mm for combi-steamer		



1

<b>GEV No.</b>	530897	<b>Ref. No.</b>	2364047
<b>description</b>	hose ID ø 10mm ED ø 15mm for boiler suitable for combi-steamer CONVOTHERM 4		

## service kits



1

<b>GEV No.</b>	551407	<b>Ref. No.</b>	8056358
<b>description</b>	mounting set control PCB M4 suitable for CONVOTHERM 4		



1

<b>GEV No.</b>	699818	<b>Ref. No.</b>	5008050
<b>description</b>	mounting set for fan CONVOTHERM		
<b>For models:</b>	AR100, AR108, AR40, AR50, AR54, AR72, HUD10.10, HUD12.20, HUD20.10, HUD20.20, HUD6.10, OD10.10, OD10.20, OD12.20, OD20.10, OD20.20, OD6.10, UG10.10, UG20.10, UG20.20, UG6.10		



1

<b>GEV No.</b>	699819	<b>Ref. No.</b>	2617293
<b>description</b>	mounting set for fan wheel CONVOTHERM		
<b>For models:</b>	OEB10.10, OEB10.20, OEB12.20, OEB20.10, OEB20.20, OEB6.10, OEB6.20, OES10.10, OES10.20, OES12.20, OES20.10, OES20.20, OES6.10, OES6.20, OGB10.10, OGB10.20, OGB12.20, OGB20.10, OGB20.20, OGB6.10, OGB6.20, OGS10.10, OGS10.20, OGS12.20, OGS20.10, OGS20.20, OGS6.10, OGS6.20		



1

<b>GEV No.</b>	699369	<b>Ref. No.</b>	2556368
<b>description</b>	repair kit for door drip tray combi-steamer CONVOTHERM 4		



1

<b>GEV No.</b>	699815	<b>Ref. No.</b>	2618161 6015032
<b>description</b>	seal kit for burner 12-20kW		
<b>For models:</b>	OGB10.10, OGB20.10, OGB6.10, OGB6.20, OGS10.10, OGS20.10, OGS6.10, OGS6.20		

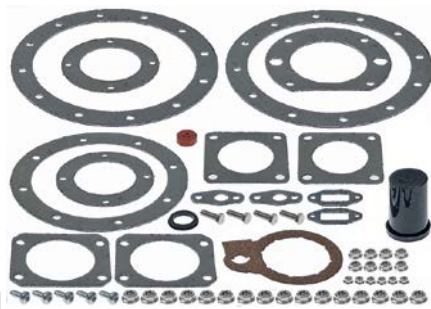

1

<b>GEV No.</b>	699814	<b>Ref. No.</b>	2618162 6015033
<b>description</b>	seal kit for burner 30-40kW		
<b>For models:</b>	OGB10.20, OGB12.20, OGB20.10, OGB20.20, OGS10.20, OGS12.20, OGS20.10, OGS20.20		



1

<b>GEV No.</b>	530896	<b>Ref. No.</b>	6056327
<b>description</b>	seal kit suitable for CONVOTHERM 4		



1

<b>GEV No.</b>	699845	<b>Ref. No.</b>	2117299
<b>description</b>	service kit for catch		
<b>For models:</b>	OEB10.10, OEB10.20, OEB12.20, OEB20.10, OEB20.20, OEB6.10, OEB6.20, OES10.10, OES10.20, OES12.20, OES20.10, OES20.20, OES6.10, OES6.20, OGB10.10, OGB10.20, OGB12.20, OGB20.10, OGB20.20, OGB6.10, OGB6.20, OGS10.10, OGS10.20, OGS12.20, OGS20.10, OGS20.20, OGS6.10, OGS6.20		

### drip water trays



1

<b>GEV No.</b>	699831	<b>Ref. No.</b>	2004051
<b>description</b>	drip tray L 535mm W 250mm H 40mm		
<b>For models:</b>	OD12.20, OD20.10, OD20.20, OS12.20, OS20.10, OS20.20, OSC12.20, OSC20.10, OSC20.20, OSP12.20, OSP20.10, OSP20.20		



1

<b>GEV No.</b>	699236	<b>Ref. No.</b>	2616470
<b>description</b>	drip tray L 710mm W 28mm H 22mm		
<b>For models:</b>	OEB10.20, OEB6.20, OES10.20, OES6.20, OGB10.20, OGB6.20, OGS10.20, OGS6.20		



1

<b>GEV No.</b>	699848	<b>Ref. No.</b>	2556336
<b>description</b>	drip tray L 725mm W 25mm H 22mm		

### doors



1

<b>GEV No.</b>	699352	<b>Ref. No.</b>	2518482
<b>description</b>	inner door glas suitable for CONVOTHERM P3 H 825mm W 695mm		
<b>For models:</b>	OEB10.20, OES10.20, OGB10.20, OGS10.20		



1

<b>GEV No.</b>	507578	<b>Ref. No.</b>	2518481
<b>description</b>	inner door suitable for CONVOTHERM P3 XXX 10.10		
<b>For models:</b>	OEB10.10, OES10.10, OGB10.10, OGS10.10		



			
1			
<b>GEV No.</b>	692734	<b>Ref. No.</b>	2518352
<b>description</b>	inner door with hinges suitable for CONVOTHERM OES6.06 Mini P3 H 380mm W 430mm		
<b>For models:</b>	OES6.06		

## door mechanics

## holders

			
1			
<b>GEV No.</b>	699820	<b>Ref. No.</b>	6015248
<b>description</b>	bracket L 29/29mm H 30mm		
<b>For models:</b>	OEB10.10, OEB10.20, OEB6.10, OEB6.20, OES10.10, OES10.20, OES6.10, OES6.20, OGB10.10, OGB10.20, OGB6.10, OGB6.20, OGS10.10, OGS10.20, OGS6.10, OGS6.20		

			
1			
<b>GEV No.</b>	692792	<b>Ref. No.</b>	6056812
<b>description</b>	bracket L 32mm W 30mm H 26mm stainless steel suitable for combi-steamer series CONVOTHERM 4		

## rollers

			
1			
<b>GEV No.</b>	694333	<b>Ref. No.</b>	2117291
<b>description</b>	roller set $\phi$ 60mm W 27.5mm V-shape stainless steel old edition		
<b>For models:</b>	OEB10.10, OEB10.20, OEB12.20, OEB20.10, OEB20.20, OEB6.10, OEB6.20, OES10.10, OES10.20, OES12.20, OES20.10, OES20.20, OES6.10, OES6.20, OGB10.10, OGB10.20, OGB12.20, OGB20.10, OGB20.20, OGB6.10, OGB6.20, OGS10.10, OGS10.20, OGS12.20, OGS20.10, OGS20.20, OGS6.10, OGS6.20		

			
1			
<b>GEV No.</b>	694604	<b>Ref. No.</b>	2619141
<b>description</b>	roller set U-shape stainless steel new edition		
<b>For models:</b>	OEB10.10, OEB10.20, OEB12.20, OEB20.10, OEB20.20, OEB6.10, OEB6.20, OES10.10, OES10.20, OES12.20, OES20.10, OES20.20, OES6.10, OES6.20, OGB10.10, OGB10.20, OGB12.20, OGB20.10, OGB20.20, OGB6.10, OGB6.20, OGS10.10, OGS10.20, OGS12.20, OGS20.10, OGS20.20, OGS6.10, OGS6.20		

## door bumpers

			
1			
<b>GEV No.</b>	699240	<b>Ref. No.</b>	6056370 6056370A
<b>description</b>	door bumper $\phi$ 12mm H 10mm Qty 4		

			
1			
<b>GEV No.</b>	694399	<b>Ref. No.</b>	8009056
<b>description</b>	door bumper set 2-piece silicone for combi-steamer $\phi$ 20mm		
<b>For models:</b>	OS10.10, OS10.20, OS6.10, OSC10.10, OSC10.20, OSC6.10, OSP10.10, OSP10.20, OSP6.10		
<b>spare parts for</b>	694399		
	<b>GEV No.</b>	694398	<b>Ref. No.</b>
			2004195
<b>description</b>	door bumper silicone for combi-steamer $\phi$ 20mm		

## accessories

			
1			
<b>GEV No.</b>	694797	<b>Ref. No.</b>	2619155 6012009
<b>description</b>	guide bar W 30mm plastic L 83.5mm black H 19mm incl. screws, nuts and film		
<b>For models:</b>	OEB10.10, OEB10.20, OEB12.20, OEB20.10, OEB20.20, OEB6.10, OEB6.20, OES10.10, OES10.20, OES12.20, OES20.10, OES20.20, OES6.10, OES6.20, OGB10.10, OGB10.20, OGB12.20, OGB20.10, OGB20.20, OGB6.10, OGB6.20, OGS10.10, OGS10.20, OGS12.20, OGS20.10, OGS20.20, OGS6.10, OGS6.20		



1

<b>GEV No.</b>	694803	<b>Ref. No.</b>	2619154 6012008 6012016
<b>description</b>	rail W 25mm plastic L 188mm black H 45mm		
<b>For models:</b>	OEB10.10, OEB10.20, OEB12.20, OEB20.10, OEB20.20, OEB6.10, OEB6.20, OES10.10, OES10.20, OES12.20, OES20.10, OES20.20, OES6.10, OES6.20, OGB10.10, OGB10.20, OGB12.20, OGB20.10, OGB20.20, OGB6.10, OGB6.20, OGS10.10, OGS10.20, OGS12.20, OGS20.10, OGS20.20, OGS6.10, OGS6.20		



1

<b>GEV No.</b>	692794	<b>Ref. No.</b>	2664000
<b>description</b>	stop for guide bar W 20mm L 80mm plastic/rubber suitable for combi-steamer CONVOTHERM		



1

<b>GEV No.</b>	694799	<b>Ref. No.</b>	2619156 6015226
<b>description</b>	stop W 25mm plastic L 60mm black H 20mm incl. screws, nuts and film		
<b>For models:</b>	OEB10.10, OEB10.20, OEB12.20, OEB20.10, OEB20.20, OEB6.10, OEB6.20, OES10.10, OES10.20, OES12.20, OES20.10, OES20.20, OES6.10, OES6.20, OGB10.10, OGB10.20, OGB12.20, OGB20.10, OGB20.20, OGB6.10, OGB6.20, OGS10.10, OGS10.20, OGS12.20, OGS20.10, OGS20.20, OGS6.10, OGS6.20		

### vibration pumps



1

<b>GEV No.</b>	500580	<b>Ref. No.</b>	5008011 5008011K 5030635
<b>description</b>	vibration pump 230V 60W 50/60Hz inlet ø 7 outlet ø 1/8" IT CEME type E512 with accessories duty cycle 1/2 ambient temperature max. 60°C medium temp max. 35°C overheating protection 110°C CleanJet		
<b>For models:</b>	OEB10.10, OEB10.20, OEB12.20, OEB20.10, OEB20.20, OEB6.10, OEB6.20, OES10.10, OES10.20, OES12.20, OES20.10, OES20.20, OES6.06, OES6.10, OES6.20, OGB10.10, OGB10.20, OGB12.20, OGB20.10, OGB20.20, OGB6.10, OGB6.20, OGS10.10, OGS10.20, OGS12.20, OGS20.10, OGS20.20, OGS6.10, OGS6.20, OS12.20, OS20.10, OS20.20		

### heat exchangers



1

<b>GEV No.</b>	520995	<b>Ref. No.</b>	6064017
<b>description</b>	gasket for heat exchanger L 65mm W 65mm hole distance 51mm graphite 50 model CONVOTHERM 4 thickness 2mm		



1

<b>GEV No.</b>	520994	<b>Ref. No.</b>	6064018
<b>description</b>	gasket for heat exchanger L 89mm W 89mm hole distance 70mm graphite 70 model CONVOTHERM 4 thickness 2mm		



1

<b>GEV No.</b>	692597	<b>Ref. No.</b>	2010000 2617317 2623208
<b>description</b>	heat exchanger combi-steamer CONVOTHERM		
<b>For models:</b>	OGB10.10, OGB20.10, OGS10.10, OGS20.10		



## miscellaneous



1

<b>GEV No.</b>	523050	<b>Ref. No.</b>	6016500
<b>description</b>	backflow preventer plastic operating medium water for steam generator		
<b>For models:</b>	OEB10.10, OEB10.20, OEB12.20, OEB20.10, OEB20.20, OEB6.10, OEB6.20, OES10.10, OES10.20, OES12.20, OES20.10, OES20.20, OES6.10, OES6.20, OGB10.10, OGB10.20, OGB12.20, OGB20.10, OGB20.20, OGB6.10, OGB6.20, OGS10.10, OGS10.20, OGS12.20, OGS20.10, OGS20.20, OGS6.10, OGS6.20		



1

<b>GEV No.</b>	710023	<b>Ref. No.</b>	3306319
<b>description</b>	base plate for guide		
<b>For models:</b>	OD20.10		



1

<b>GEV No.</b>	530777	<b>Ref. No.</b>	2002042
<b>description</b>	bracket for spray gun L 96mm W 75mm H 50mm		
<b>For models:</b>	OD10.10, OD10.20, OD12.20, OD20.10, OD20.20, OD6.10, OEB10.10, OEB10.20, OEB12.20, OEB20.10, OEB20.20, OEB6.10, OEB6.20, OES10.10, OES10.20, OES12.20, OES20.10, OES20.20, OES6.10, OES6.20, OGB10.10, OGB10.20, OGB12.20, OGB20.10, OGB20.20, OGB6.10, OGB6.20, OGS10.10, OGS10.20, OGS12.20, OGS20.10, OGS20.20, OGS6.10, OGS6.20, OS10.10, OS10.20, OS12.20, OS20.10, OS20.20, OS6.10, OSC10.10, OSC10.20, OSC12.20, OSC20.10, OSC20.20, OSC6.10, OSP10.10, OSP10.20, OSP12.20, OSP20.10...(Other models you can see in the webshop)		
<b>accessories for</b>	530777		
	<b>GEV No.</b>	<b>Ref. No.</b>	<b>540158</b>
spray gun for appliances 1/2" ET type ECHTERMANN			



1

<b>GEV No.</b>	699238	<b>Ref. No.</b>	6006030
<b>description</b>	connecting piece with nozzle outlet (with nozzle) L 60mm bore ø 0.5mm for hose 10mm		
<b>For models:</b>	OD6.10, OSG6.10		



1

<b>GEV No.</b>	506225	<b>Ref. No.</b>	6012050
<b>description</b>	door bumper		
<b>For models:</b>	OES6.06		



1

<b>GEV No.</b>	694399	<b>Ref. No.</b>	8009056
<b>description</b>	door bumper set 2-piece silicone for combi-steamer ø 20mm		
<b>For models:</b>	OS10.10, OS10.20, OS6.10, OSC10.10, OSC10.20, OSC6.10, OSP10.10, OSP10.20, OSP6.10		
<b>spare parts for</b>	694399		
	<b>GEV No.</b>	<b>Ref. No.</b>	<b>694398</b>
door bumper silicone for combi-steamer ø 20mm			



1

<b>GEV No.</b>	694440	<b>Ref. No.</b>	2618810
<b>description</b>	drip rail L 500mm plastic W 30mm		
<b>For models:</b>	OES6.06		



1

<b>GEV No.</b>	699235	<b>Ref. No.</b>	6056326
<b>description</b>	flap for dehumidification L 155mm W 94mm H 124mm 220VAC		
<b>spare parts for</b>	699235		
	<b>GEV No.</b>	<b>Ref. No.</b>	<b>530896</b>
seal kit suitable for CONVOTHERM 4			





1			
<b>GEV No.</b>	692171	<b>Ref. No.</b>	5005020
<b>description</b>	frame for lamp lenses bore $\varnothing$ 6.3mm D1 $\varnothing$ 72mm D2 $\varnothing$ 56mm L 83mm W 83mm thickness 1mm		
<b>For models:</b>	OD10.10, OD10.20, OD12.20, OD20.10, OD20.20, OD6.10, OS10.10, OS10.20, OS12.20, OS20.10, OS20.20, OS6.10, OSC10.10, OSC10.20, OSC12.20, OSC20.10, OSC20.20, OSC6.10, OSP10.10, OSP10.20, OSP12.20, OSP20.10, OSP20.20, OSP6.10		

1			
<b>GEV No.</b>	902415	<b>Ref. No.</b>	7011010
<b>description</b>	gasket for control panel profile W 155mm L 600mm suitable for CONVOTHERM self-adhesive Qty		
<b>For models:</b>	OEB10.10, OEB10.20, OEB12.20, OEB20.10, OEB20.20, OEB6.10, OEB6.20, OES10.10, OES10.20, OES12.20, OES20.10, OES20.20, OES6.10, OES6.20, OGB10.10, OGB10.20, OGB12.20, OGB20.10, OGB20.20, OGB6.10, OGB6.20, OGS10.10, OGS10.20, OGS12.20, OGS20.10, OGS20.20, OGS6.10, OGS6.20		

1			
<b>GEV No.</b>	710022	<b>Ref. No.</b>	2006016
<b>description</b>	guide for tray rack trolley PTFE		
<b>For models:</b>	OD12.20, OD20.10, OD20.20, OS12.20, OS20.10, OS20.20, OSC12.20, OSC20.10, OSC20.20, OSP12.20, OSP20.10, OSP20.20		

1			
<b>GEV No.</b>	699839	<b>Ref. No.</b>	6015236
<b>description</b>	guide L 51.5mm W 24mm H 12mm hole $\varnothing$ 4mm		
<b>For models:</b>	OEB6.10, OES6.10		

1			
<b>GEV No.</b>	512478	<b>Ref. No.</b>	5011002
<b>description</b>	hose connector thread 3/4" connection distance 75mm		
<b>For models:</b>	OEB10.10, OEB10.20, OEB12.20, OEB20.10, OEB20.20, OEB6.10, OEB6.20, OES10.10, OES10.20, OES12.20, OES20.10, OES20.20, OES6.10, OES6.20, OGB10.10, OGB10.20, OGB12.20, OGB20.10, OGB20.20, OGB6.10, OGB6.20, OGS10.10, OGS10.20, OGS12.20, OGS20.10, OGS20.20, OGS6.10, OGS6.20		

1			
<b>GEV No.</b>	699358	<b>Ref. No.</b>	6056827
<b>description</b>	pressure compensation valve complete, with solenoid coil for combi-steamer L 155mm D1 $\varnothing$ 58.3mm W 98mm H 122mm D2 $\varnothing$ 54mm 220V 15W duty cycle 100%		

1			
<b>GEV No.</b>	696398	<b>Ref. No.</b>	2611068 2611184 2616460 2627250
<b>description</b>	rotary nozzle for combi-steamer bore $\varnothing$ 1.1/1.5mm L 155mm thread 1/8"		
<b>For models:</b>	OEB10.10, OEB10.20, OEB12.20, OEB20.10, OEB20.20, OEB6.10, OEB6.20, OES10.10, OES10.20, OES12.20, OES20.10, OES20.20, OES6.10, OES6.20, OGB10.10, OGB10.20, OGB12.20, OGB20.10, OGB20.20, OGB6.10, OGB6.20, OGS10.10, OGS10.20, OGS12.20, OGS20.10, OGS20.20, OGS6.10, OGS6.20, OS10.10, OS10.20, OS12.20, OS20.10, OS20.20, OS6.10, OSP10.10, OSP10.20, OSP12.20, OSP20.10, OSP20.20, OSP6.10		

1			
<b>GEV No.</b>	696361	<b>Ref. No.</b>	6005299
<b>description</b>	sleeve for drain pump bore $\varnothing$ 18mm D1 $\varnothing$ 20mm D2 $\varnothing$ 22mm L 25mm SS thickness 1mm		
<b>For models:</b>	OEB10.10, OEB10.20, OEB12.20, OEB20.10, OEB20.20, OEB6.10, OEB6.20, OES10.10, OES10.20, OES12.20, OES20.10, OES20.20, OES6.10, OES6.20, OGB10.10, OGB10.20, OGB12.20, OGB20.10, OGB20.20, OGB6.10, OGB6.20, OGS10.10, OGS10.20, OGS12.20, OGS20.10, OGS20.20, OGS6.10, OGS6.20		

1			
<b>GEV No.</b>	692170	<b>Ref. No.</b>	6015200
<b>description</b>	spacer for door L 24mm thread M4 $\varnothing$ 20mm		
<b>For models:</b>	OEB10.10, OEB10.20, OEB12.20, OEB20.10, OEB20.20, OEB6.10, OEB6.20, OES10.10, OES10.20, OES12.20, OES20.10, OES20.20, OES6.10, OES6.20, OGB10.10, OGB10.20, OGB12.20, OGB20.10, OGB20.20, OGB6.10, OGB6.20, OGS10.10, OGS10.20, OGS12.20, OGS20.10, OGS20.20, OGS6.10, OGS6.20		

mechanical components, equipment accessories





1

<b>GEV No.</b>	699849	<b>Ref. No.</b>	2056497
<b>description</b>	spacer for tray rack trolley L 90mm W 13mm H 13mm		



1

<b>GEV No.</b>	750528	<b>Ref. No.</b>	2608962
<b>description</b>	ventilation valve D1 ø 56mm D2 ø 60mm L 57.6mm SS mounting pos. upper ø 48mm hose ø 1.48mm Qty 1 pcs		
<b>For models:</b>	OEB10.10, OEB10.20, OEB12.20, OEB20.10, OEB20.20, OEB6.10, OEB6.20, OES10.10, OES10.20, OES12.20, OES20.10, OES20.20, OES6.10, OES6.20, OGB10.10, OGB10.20, OGB12.20, OGB20.10, OGB20.20, OGB6.10, OGB6.20, OGS10.10, OGS10.20, OGS12.20, OGS20.10, OGS20.20, OGS6.10, OGS6.20		
<b>spare parts for</b>	750528		
	<b>GEV No.</b>	532374	<b>Ref. No.</b> —
	O-ring silicone thickness 5.34mm ID ø 43.82mm Qty 10 pcs		
<b>accessories for</b>	750528		
	<b>GEV No.</b>	699823	<b>Ref. No.</b> 6005427
	grommet for ventilation H 9mm ø 83mm ID ø 53mm		

## knobs

### universal knobs



1

<b>GEV No.</b>	110167	<b>Ref. No.</b>	6003011
<b>description</b>	knob time 90min t.max.°C ø 50mm shaft ø 6x4.6mm shaft flat lower black		
<b>For models:</b>	AR100, AR108, AR12, AR16, AR18, AR28, AR30, AR40, AR50, AR54, AR72, AR8, HUD10.10, HUD12.20, HUD20.10, HUD20.20, HUD6.10, UG10.10, UG10.20, UG20.10, UG20.20, UG4.05, UG6.05, UG6.10		



1

<b>GEV No.</b>	110166	<b>Ref. No.</b>	6003016
<b>description</b>	knob thermostat t.max. 250°C ø 50mm shaft ø 6x4.6mm shaft flat lower black temperature range 50-250°C		
<b>For models:</b>	AR108, AR12, AR18, AR28, AR40, AR54, AR72, AR8, HUD10.10, HUD12.20, HUD20.10, HUD20.20, HUD6.10, UG10.10, UG10.20, UG20.10, UG20.20, UG4.05, UG6.05, UG6.10		

### producer-specific knobs

#### CONVOTHERM



1

<b>GEV No.</b>	112565	<b>Ref. No.</b>	5009313 5009314 5009320
<b>description</b>	knob t.max.°C ø 44mm shaft flat special black for combi-steamer		
<b>For models:</b>	OEB10.10, OEB10.20, OEB12.20, OEB20.10, OEB20.20, OEB6.10, OEB6.20, OES10.10, OES10.20, OES12.20, OES20.10, OES20.20, OES6.06, OES6.10, OES6.20, OGB10.10, OGB10.20, OGB12.20, OGB20.10, OGB20.20, OGB6.10, OGB6.20, OGS10.10, OGS10.20, OGS12.20, OGS20.10, OGS20.20, OGS6.10, OGS6.20, OS10.10, OS10.20, OS12.20, OS20.10, OS20.20, OS6.10, OSC10.10, OSC10.20, OSC12.20, OSC20.10, OSC20.20, OSC6.10, OSG10.10, OSG12.20, OSG20.20, OSG6.10, OSP10.10, OSP10.20, OSP12.20, OSP20.10, OSP20.20...(Other models you can see in the webshop)		



1

<b>GEV No.</b>	110167	<b>Ref. No.</b>	6003011
<b>description</b>	knob time 90min t.max.°C ø 50mm shaft ø 6x4.6mm shaft flat lower black		
<b>For models:</b>	AR100, AR108, AR12, AR16, AR18, AR28, AR30, AR40, AR50, AR54, AR72, AR8, HUD10.10, HUD12.20, HUD20.10, HUD20.20, HUD6.10, UG10.10, UG10.20, UG20.10, UG20.20, UG4.05, UG6.05, UG6.10		



1

<b>GEV No.</b>	112816	<b>Ref. No.</b>	5056360
<b>description</b>	knob without symbol shaft ø 6.5x6mm black combi-steamer CONVOTHERM 4		



## miscellaneous

			
<b>GEV No.</b>	112565	<b>Ref. No.</b>	5009313 5009314 5009320
<b>description</b>	knob t.max.°C ø 44mm shaft flat special black for combi-steamer		
<b>For models:</b>	OEB10.10, OEB10.20, OEB12.20, OEB20.10, OEB20.20, OEB6.10, OEB6.20, OES10.10, OES10.20, OES12.20, OES20.10, OES20.20, OES6.06, OES6.10, OES6.20, OGB10.10, OGB10.20, OGB12.20, OGB20.10, OGB20.20, OGB6.10, OGB6.20, OGS10.10, OGS10.20, OGS12.20, OGS20.10, OGS20.20, OGS6.10, OGS6.20, OS10.10, OS10.20, OS12.20, OS20.10, OS20.20, OS6.10, OSC10.10, OSC10.20, OSC12.20, OSC20.10, OSC20.20, OSC6.10, OSG10.10, OSG12.20, OSG20.20, OSG6.10, OSP10.10, OSP10.20, OSP12.20, OSP20.10, OSP20.20...(Other models you can see in the webshop)		

## accessories

### gaskets

			
<b>GEV No.</b>	112623	<b>Ref. No.</b>	5009108
<b>description</b>	gasket for shaft ø6x4.6		
<b>For models:</b>	OD10.10, OD10.20, OD12.20, OD20.10, OD20.20, OD6.10		

## locks



### turning lever locks



#### universal

#### RAHRBACH

			
<b>GEV No.</b>	690027	<b>Ref. No.</b>	6002048 6002048K
<b>description</b>	handle latch left L 150mm H 59mm		
<b>For models:</b>	OD10.10, OD10.20, OD12.20, OD20.10, OD20.20, OD6.10, OS10.10, OS10.20, OS6.10, OSC10.10, OSC10.20, OSC6.10, OSP10.10, OSP10.20, OSP6.10		
<b>accessories for</b>	690027		
	<b>GEV No.</b>	690045	<b>Ref. No.</b> —
	door catch mounting pos. left off-set 20mm L 110mm H 56mm W 33mm mounting distance 68/68mm zinc die cast series 6300		
	<b>GEV No.</b>	690135	<b>Ref. No.</b> 6002049 6002049K
	door catch mounting pos. left off-set 38mm L 110mm H 74mm W 33mm mounting distance 68/68mm zinc die cast series 1750		
	<b>GEV No.</b>	690137	<b>Ref. No.</b> 6002060
	sliding plate mounting pos. left L 28mm H 3mm W 21mm H2 12.5mm		



			
<b>GEV No.</b>	690500	<b>Ref. No.</b>	6002053 6002053K 6030642
<b>description</b>	handle latch right L 185mm H 66mm handle material plastic type 6300 series		
<b>For models:</b>	HUD10.10, HUD12.20, HUD20.10, HUD20.20, HUD6.10, OD10.10, OD10.20, OD12.20, OD20.10, OD20.20, OD6.10, OS10.10, OS10.20, OS12.20, OS20.10, OS20.20, OS6.10, OSC10.10, OSC10.20, OSC12.20, OSC20.10, OSC20.20, OSC6.10, OSG10.10, OSG12.20, OSG6.10, OSP10.10, OSP10.20, OSP12.20, OSP20.10, OSP20.20, OSP6.10, UG10.20		
<b>spare parts for</b>	690500		
	<b>GEV No.</b>	699841	<b>Ref. No.</b> 6002056
	cover cap for turning lever lock ø 32mm H 14mm		
<b>accessories for</b>	690500		
	<b>GEV No.</b>	514281	<b>Ref. No.</b> —
	base plate L 110mm W 35mm for door catch thickness 10mm		
	<b>GEV No.</b>	690136	<b>Ref. No.</b> 6002062
	sliding plate mounting pos. right L 28mm H 3mm W 21mm H2 12.5mm		
	<b>GEV No.</b>	691174	<b>Ref. No.</b> —
	counterpart L 90mm W 60mm for door latch		
	<b>GEV No.</b>	700091	<b>Ref. No.</b> —
	door catch mounting pos. right off-set 20mm L 110mm H 56mm W 33mm mounting distance 68/68mm zinc die cast series 6300		
	<b>GEV No.</b>	700098	<b>Ref. No.</b> 6002054 6002054K
	door catch mounting pos. right off-set 38mm L 110mm H 74mm W 33mm mounting distance 68/68mm series 1750		

			
<b>GEV No.</b>	690135	<b>Ref. No.</b>	6002049 6002049K
<b>description</b>	door catch mounting pos. left off-set 38mm L 110mm H 74mm W 33mm mounting distance 68/68mm zinc die cast series 1750		
<b>For models:</b>	OD10.10, OD10.20, OD12.20, OD20.10, OD20.20, OD6.10, OS10.10, OS10.20, OS6.10, OSC10.10, OSC10.20, OSC6.10, OSP10.10, OSP10.20, OSP6.10		
<b>spare parts for</b>	690135		
	<b>GEV No.</b>	690137	<b>Ref. No.</b> 6002060
	sliding plate mounting pos. left L 28mm H 3mm W 21mm H2 12.5mm		

			
<b>GEV No.</b>	700098	<b>Ref. No.</b>	6002054 6002054K
<b>description</b>	door catch mounting pos. right off-set 38mm L 110mm H 74mm W 33mm mounting distance 68/68mm series 1750		
<b>For models:</b>	HUD10.10, HUD12.20, HUD20.10, HUD20.20, HUD6.10, OD10.10, OD10.20, OD12.20, OD20.10, OD20.20, OD6.10, OSG12.20, OSG20.20, OSG6.10, UG10.20		
<b>accessories for</b>	700098		
	<b>GEV No.</b>	514281	<b>Ref. No.</b> —
base plate L 110mm W 35mm for door catch thickness 10mm			



			
<b>GEV No.</b>	690137	<b>Ref. No.</b>	6002060
<b>description</b>	sliding plate mounting pos. left L 28mm H 3mm W 21mm H2 12.5mm		
<b>For models:</b>	HUD10.10, HUD12.20, HUD20.10, HUD20.20, HUD6.10, OD10.10, OD10.20, OD12.20, OD20.10, OD20.20, OD6.10, OS10.10, OS10.20, OS6.10, OSC10.10, OSC10.20, OSC6.10, OSP10.10, OSP10.20, OSP6.10		

			
<b>GEV No.</b>	690136	<b>Ref. No.</b>	6002062
<b>description</b>	sliding plate mounting pos. right L 28mm H 3mm W 21mm H2 12.5mm		
<b>For models:</b>	HUD10.10, HUD12.20, HUD20.10, HUD20.20, HUD6.10, OD10.10, OD10.20, OD12.20, OD20.10, OD20.20, OD6.10, OSG10.10, OSG12.20, OSG20.20, OSG6.10		





STUV			
			
<b>GEV No.</b>	700098	<b>Ref. No.</b>	6002054 6002054K
<b>description</b>	door catch mounting pos. right off-set 38mm L 110mm H 74mm W 33mm mounting distance 68/68mm series 1750		
<b>For models:</b>	HUD10.10, HUD12.20, HUD20.10, HUD20.20, HUD6.10, OD10.10, OD10.20, OD12.20, OD20.10, OD20.20, OD6.10, OSG12.20, OSG20.20, OSG6.10, UG10.20		
<b>spare parts for</b>	700098		
	<b>GEV No.</b>	690136	<b>Ref. No.</b> 6002062
<b>accessories for</b>	700098		
	<b>GEV No.</b>	514281	<b>Ref. No.</b> —
base plate L 110mm W 35mm for door catch thickness 10mm			







producer-specific			
CONVOTHERM			
			
<b>GEV No.</b>	691987	<b>Ref. No.</b>	2216070 2216070K 2230605 6012001 CV2216070
<b>description</b>	door catch with magnetic switch		
<b>For models:</b>	OEB10.10, OEB10.20, OEB12.20, OEB20.10, OEB20.20, OEB6.10, OEB6.20, OES10.10, OES10.20, OES12.20, OES20.10, OES20.20, OES6.10, OES6.20, OGB10.10, OGB10.20, OGB12.20, OGB20.10, OGB20.20, OGB6.10, OGB6.20, OGS10.10, OGS10.20, OGS12.20, OGS20.10, OGS20.20, OGS6.10, OGS6.20		

			
<b>GEV No.</b>	691986	<b>Ref. No.</b>	2525040 6012000
<b>description</b>	handle latch right L 200mm handle material plastic		
<b>For models:</b>	OEB10.10, OEB10.20, OEB12.20, OEB20.10, OEB20.20, OEB6.10, OEB6.20, OES10.10, OES10.20, OES12.20, OES20.10, OES20.20, OES6.10, OES6.20, OGB10.10, OGB10.20, OGB12.20, OGB20.10, OGB20.20, OGB6.10, OGB6.20, OGS10.10, OGS10.20, OGS12.20, OGS20.10, OGS20.20, OGS6.10, OGS6.20		
<b>accessories for</b>	691986		
	<b>GEV No.</b>	691987	<b>Ref. No.</b> 2216070 2216070K 2230605 6012001 CV2216070
door catch with magnetic switch			

			
<b>GEV No.</b>	690768	<b>Ref. No.</b>	6002043
<b>description</b>	mounting set for turning lever lock		
<b>For models:</b>	HUD10.10, HUD12.20, HUD20.10, HUD20.20, HUD6.10, OD10.10, OD10.20, OD12.20, OD20.10, OD20.20, OD6.10, OS10.10, OS10.20, OS12.20, OS20.10, OS20.20, OS6.10, OSC10.10, OSC10.20, OSC12.20, OSC20.10, OSC20.20, OSC6.10, OSG10.10, OSG12.20, OSG20.20, OSG6.10, OSP10.10, OSP10.20, OSP12.20, OSP20.10, OSP20.20, OSP6.10, UG10.20		
<b>accessories for</b>	690768		
	<b>GEV No.</b>	690027	<b>Ref. No.</b> 6002048 6002048K
handle latch left L 150mm H 59mm			
	<b>GEV No.</b>	690044	<b>Ref. No.</b> —
handle latch right L 185mm H 59mm handle material plastic type 6300 series			





			
<b>GEV No.</b>	690027	<b>Ref. No.</b>	6002048 6002048K
<b>description</b>	handle latch left L 150mm H 59mm		
<b>For models:</b>	OD10.10, OD10.20, OD12.20, OD20.10, OD20.20, OD6.10, OS10.10, OS10.20, OS6.10, OSC10.10, OSC10.20, OSC6.10, OSP10.10, OSP10.20, OSP6.10		
<b>accessories for</b>	690027		
	<b>GEV No.</b>	690045	<b>Ref. No.</b> —
<b>description</b>	door catch mounting pos. left off-set 20mm L 110mm H 56mm W 33mm mounting distance 68/68mm zinc die cast series 6300		
	<b>GEV No.</b>	690135	<b>Ref. No.</b> 6002049 6002049K
<b>description</b>	door catch mounting pos. left off-set 38mm L 110mm H 74mm W 33mm mounting distance 68/68mm zinc die cast series 1750		
	<b>GEV No.</b>	690137	<b>Ref. No.</b> 6002060
<b>description</b>	sliding plate mounting pos. left L 28mm H 3mm W 21mm H2 12.5mm		



			
<b>GEV No.</b>	690500	<b>Ref. No.</b>	6002053 6002053K 6030642
<b>description</b>	handle latch right L 185mm H 66mm handle material plastic type 6300 series		
<b>For models:</b>	HUD10.10, HUD12.20, HUD20.10, HUD20.20, HUD6.10, OD10.10, OD10.20, OD12.20, OD20.10, OD20.20, OD6.10, OS10.10, OS10.20, OS12.20, OS20.10, OS20.20, OS6.10, OSC10.10, OSC10.20, OSC12.20, OSC20.10, OSC20.20, OSC6.10, OSG10.10, OSG12.20, OSG6.10, OSP10.10, OSP10.20, OSP12.20, OSP20.10, OSP20.20, OSP6.10, UG10.20		
<b>spare parts for</b>	690500		
	<b>GEV No.</b>	699841	<b>Ref. No.</b> 6002056
<b>description</b>	cover cap for turning lever lock ø 32mm H 14mm		
<b>accessories for</b>	690500		
	<b>GEV No.</b>	514281	<b>Ref. No.</b> —
<b>description</b>	base plate L 110mm W 35mm for door catch thickness 10mm		
	<b>GEV No.</b>	690136	<b>Ref. No.</b> 6002062
<b>description</b>	sliding plate mounting pos. right L 28mm H 3mm W 21mm H2 12.5mm		
	<b>GEV No.</b>	691174	<b>Ref. No.</b> —
<b>description</b>	counterpart L 90mm W 60mm for door latch		
	<b>GEV No.</b>	700091	<b>Ref. No.</b> —
<b>description</b>	door catch mounting pos. right off-set 20mm L 110mm H 56mm W 33mm mounting distance 68/68mm zinc die cast series 6300		

<b>accessories for</b>	690500		
	<b>GEV No.</b>	700098	<b>Ref. No.</b> 6002054 6002054K
<b>description</b>	door catch mounting pos. right off-set 38mm L 110mm H 74mm W 33mm mounting distance 68/68mm series 1750		

			
<b>GEV No.</b>	690204	<b>Ref. No.</b>	6002064
<b>description</b>	base plate for door catch thickness 10mm		
<b>For models:</b>	HUD10.10, HUD12.20, HUD20.10, HUD20.20, HUD6.10, OD12.20, OD20.10, OD20.20		

			
<b>GEV No.</b>	690203	<b>Ref. No.</b>	6002066
<b>description</b>	base plate for door catch thickness 6mm		
<b>For models:</b>	OD10.10, OD10.20, OD6.10		

			
<b>GEV No.</b>	699841	<b>Ref. No.</b>	6002056
<b>description</b>	cover cap for turning lever lock ø 32mm H 14mm		
<b>For models:</b>	HUD10.10, HUD12.20, HUD20.10, HUD20.20, HUD6.10, OD10.10, OD10.20, OD12.20, OD20.10, OD20.20, OD6.10, OS10.10, OS10.20, OS12.20, OS20.10, OS20.20, OS6.10, OSC10.10, OSC10.20, OSC12.20, OSC20.10, OSC20.20, OSC6.10, OSP10.10, OSP10.20, OSP12.20, OSP20.10, OSP20.20, OSP6.10		

			
<b>GEV No.</b>	690135	<b>Ref. No.</b>	6002049 6002049K
<b>description</b>	door catch mounting pos. left off-set 38mm L 110mm H 74mm W 33mm mounting distance 68/68mm zinc die cast series 1750		
<b>For models:</b>	OD10.10, OD10.20, OD12.20, OD20.10, OD20.20, OD6.10, OS10.10, OS10.20, OS12.20, OS20.10, OS20.20, OS6.10, OSC10.10, OSC10.20, OSC12.20, OSC20.10, OSC20.20, OSC6.10, OSP10.10, OSP10.20, OSP12.20, OSP6.10		
<b>spare parts for</b>	690135		
	<b>GEV No.</b>	690137	<b>Ref. No.</b> 6002060
<b>description</b>	sliding plate mounting pos. left L 28mm H 3mm W 21mm H2 12.5mm		

			
<b>GEV No.</b>	690137	<b>Ref. No.</b>	6002060
<b>description</b>	sliding plate mounting pos. left L 28mm H 3mm W 21mm H2 12.5mm		
<b>For models:</b>	HUD10.10, HUD12.20, HUD20.10, HUD20.20, HUD6.10, OD10.10, OD10.20, OD12.20, OD20.10, OD20.20, OD6.10, OS10.10, OS10.20, OS6.10, OSC10.10, OSC10.20, OSC6.10, OSP10.10, OSP10.20, OSP6.10		









mechanical components, equipment accessories

1 			
<b>GEV No.</b>	690136	<b>Ref. No.</b>	6002062
<b>description</b>	sliding plate mounting pos. right L 28mm H 3mm W 21mm H2 12.5mm		
<b>For models:</b>	HUD10.10, HUD12.20, HUD20.10, HUD20.20, HUD6.10, OD10.10, OD10.20, OD12.20, OD20.10, OD20.20, OD6.10, OSG10.10, OSG12.20, OSG20.20, OSG6.10		

**handle latches**  
 universal  
 inside fixing  
 locks





<b>GEV No.</b>	694054	<b>Ref. No.</b>	2518784
<b>description</b>	door handle for headed units L 145mm W 40mm H 62mm spring length 33mm inner black		
<b>For models:</b>	OES6.06		

<b>spare parts for</b>	694054			
	<b>GEV No.</b>	514390	<b>Ref. No.</b>	—
	spring for door handle ø 6mm L 54mm W 27.5mm			
	<b>GEV No.</b>	694675	<b>Ref. No.</b>	—
	door catch L 88mm W 40mm H 37mm spring length 33mm mounting distance 60mm			
	<b>GEV No.</b>	694734	<b>Ref. No.</b>	—
	door handle L 165mm W 40mm H 25mm black			
	<b>GEV No.</b>	694735	<b>Ref. No.</b>	—
	cap ø 32mm black			
<b>accessories for</b>	694054			
	<b>GEV No.</b>	691123	<b>Ref. No.</b>	—
	duct for door opener			
	<b>GEV No.</b>	694055	<b>Ref. No.</b>	—
	door catch L 25mm W 14mm total length 54mm thread M8 thread L 29mm			
	<b>GEV No.</b>	694066	<b>Ref. No.</b>	—
	door catch with spigot 2-stage L 28mm W 14mm H 15mm H1 16mm total length 51mm thread M8 thread L 23mm stainless steel			
	<b>GEV No.</b>	694067	<b>Ref. No.</b>	—
	door catch with spigot 1-stage L 26mm total length 51mm thread M8			

producer-specific			
CONVOTHERM			
1 			
<b>GEV No.</b>	694948	<b>Ref. No.</b>	6056498
<b>description</b>	door catch L 30mm W 14mm H 13mm cast iron with spigot mounting thread M4		

1 			
<b>GEV No.</b>	694949	<b>Ref. No.</b>	6056807
<b>description</b>	door catch L 34.5mm W 14.5mm H 13mm cast iron with spigot mounting thread M4		







1 			
<b>GEV No.</b>	694947	<b>Ref. No.</b>	6056499
<b>description</b>	door catch L 58mm W 20mm H 17mm cast iron with spigot mounting thread M5 IT		

1 			
<b>GEV No.</b>	696785	<b>Ref. No.</b>	2528055
<b>description</b>	door handle for combi-steamer L 170mm W 30mm H 37mm spring length 37mm inner black plastic		

1 				
<b>GEV No.</b>	694054	<b>Ref. No.</b>	2518784	
<b>description</b>	door handle for headed units L 145mm W 40mm H 62mm spring length 33mm inner black			
<b>For models:</b>	OES6.06			
<b>spare parts for</b>	694054			
	<b>GEV No.</b>	514390	<b>Ref. No.</b>	—
	spring for door handle ø 6mm L 54mm W 27.5mm			

Table continues overleaf



<b>spare parts for</b> 694054	
	GEV No. 694675 Ref. No. — door catch L 88mm W 40mm H 37mm spring length 33mm mounting distance 60mm
	GEV No. 694734 Ref. No. — door handle L 165mm W 40mm H 25mm black
	GEV No. 694735 Ref. No. — cap ø 32mm black
<b>accessories for</b> 694054	
	GEV No. 691123 Ref. No. — duct for door opener
	GEV No. 694055 Ref. No. — door catch L 25mm W 14mm total length 54mm thread M8 thread L 29mm
	GEV No. 694066 Ref. No. — door catch with spigot 2-stage L 28mm W 14mm H 15mm H1 16mm total length 51mm thread M8 thread L 23mm stainless steel
	GEV No. 694067 Ref. No. — door catch with spigot 1-stage L 26mm total length 51mm thread M8

			
1			
<b>GEV No.</b>	694919	<b>Ref. No.</b>	6050978 6056384
<b>description</b>	door handle L 195mm W 53mm H 62mm spring length 44mm blue mounting distance 30mm mounting thread M4		

			
1			
<b>GEV No.</b>	692741	<b>Ref. No.</b>	6056809
<b>description</b>	door handle type L 195mm W 53mm H 62mm clamp length 42mm black mounting thread M4 CONVOTHERM model C4 Serie		





## edgmount latches

### push button latches

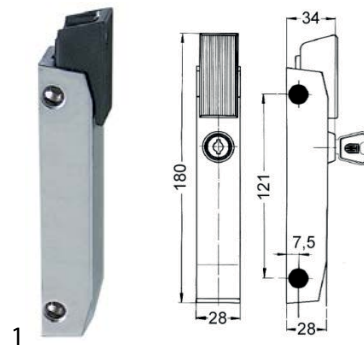
#### RAHRBACH





#### 6186 PRESTO series



<b>GEV No.</b>	700045	<b>Ref. No.</b>	6002030 6002030K
<b>description</b>	push button latch L 180mm mounting distance 121mm non lockable 6186 H 34mm W 28mm type PRESTO		
<b>spare parts for</b> 700045			
	GEV No. 700046	Ref. No.	—
handle H 26.5mm L 55mm W 23.5mm plastic with spring spring length 14mm mounting thread M4 spring thickness 0.5mm			
<b>accessories for</b> 700045			
	GEV No. 690108	Ref. No.	—
base plate H 5mm L 47.5mm W 21mm for swinging strike hole distance 31mm type PRESTO no. 6186			
	GEV No. 690109	Ref. No.	—
base plate H 1mm L 47.5mm W 21mm plastic hole distance 31mm type PRESTO no. 6186			
	GEV No. 700050	Ref. No.	—
door catch H 5mm L 47mm W 21mm hole distance 31mm with spigot refrigeration units type PRESTO no. 6186			
	GEV No. 700051	Ref. No.	—
door catch H 5mm L 48mm W 21mm adjustable hole distance 31mm with spigot type PRESTO no. 6186			

handle latches



<b>GEV No.</b>	700045	<b>Ref. No.</b>	6002030 6002030K
<b>description</b>	push button latch L 180mm mounting distance 121mm non lockable 6186 H 34mm W 28mm type PRESTO		
<b>spare parts for</b>	700045		
	<b>GEV No.</b>	700046	<b>Ref. No.</b> —
	handle H 26.5mm L 55mm W 23.5mm plastic with spring spring length 14mm mounting thread M4 spring thickness 0.5mm		
<b>accessories for</b>	700045		
	<b>GEV No.</b>	690108	<b>Ref. No.</b> —
	base plate H 5mm L 47.5mm W 21mm for swinging strike hole distance 31mm type PRESTO no. 6186		
	<b>GEV No.</b>	690109	<b>Ref. No.</b> —
	base plate H 1mm L 47.5mm W 21mm plastic hole distance 31mm type PRESTO no. 6186		
	<b>GEV No.</b>	700050	<b>Ref. No.</b> —
	door catch H 5mm L 47mm W 21mm hole distance 31mm with spigot refrigeration units type PRESTO no. 6186		
	<b>GEV No.</b>	700051	<b>Ref. No.</b> —
	door catch H 5mm L 48mm W 21mm adjustable hole distance 31mm with spigot type PRESTO no. 6186		

miscellaneous



<b>GEV No.</b>	690049	<b>Ref. No.</b>	6001040 6001040K
<b>description</b>	hinge off-set 0mm overall height 22mm face mounted total length 118.5mm		
<b>For models:</b>	AR100, AR108, AR12, AR18, AR28, AR72, HUD10.10, HUD12.20, HUD20.10, HUD20.20, HUD6.10, UG10.10, UG10.20, UG20.10, UG20.20		



<b>GEV No.</b>	750714	<b>Ref. No.</b>	79560
<b>description</b>	hinge off-set 22mm overall height 90mm stainless steel total length 50mm W 16.5mm		

piano hinges

producer-specific

CONVOTHERM

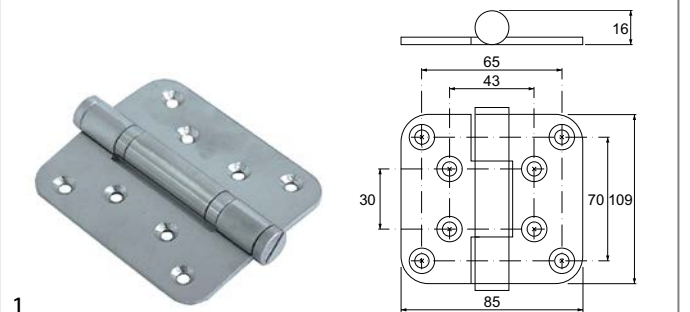

<b>GEV No.</b>	690074	<b>Ref. No.</b>	6001041 6001041K
<b>description</b>	hinge L 109mm W 85mm H 16mm mounting distance 65/70mm mounting distance 1 43/30mm hole $\varnothing$ 5.5mm thickness 3mm stainless steel		
<b>For models:</b>	AR108, HUD12.20, HUD20.10, HUD20.20, OD12.20, OD20.10, OD20.20		

hinges

overlying hinges

STUV

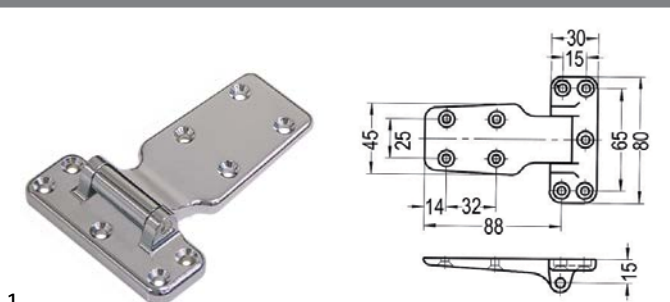

<b>GEV No.</b>	700092	<b>Ref. No.</b>	6001031 6001031K
<b>description</b>	hinge off-set 0mm overall height 21mm type 3.50.0139.0 total length 110mm W 80mm face mounted		
<b>For models:</b>	AR12, AR16, AR18, AR28, AR30, AR40, AR50, AR54, AR8, UG6.05, UG6.10		





<b>GEV No.</b>	690214	<b>Ref. No.</b>	6001032 6001032K
<b>description</b>	hinge L 90mm W 85mm H 16mm mounting distance 66/55mm mounting distance 1 43/25mm hole ø 6mm thickness 3mm stainless steel		
<b>For models:</b>	HUD10.10, HUD6.10, OD10.10, OD10.20, OD6.10, OS10.10, OS10.20, OS6.10, OSC10.10, OSC10.20, OSC6.10, OSP10.10, OSP10.20, OSP6.10		

<b>GEV No.</b>	692793	<b>Ref. No.</b>	6056845
<b>description</b>	hinge mounting pos. lower ID ø 10mm hinged at right suitable for combi-steamer series CONVOTHERM 4		

<b>GEV No.</b>	692784	<b>Ref. No.</b>	6056841
<b>description</b>	hinge mounting pos. right bottom thickness 5mm bolt 18.5mm bolt ø 10mm hinged at right suitable for CONVOTHERM 4		

door bearing

<b>GEV No.</b>	699842	<b>Ref. No.</b>	2517296 2517297 2523667
<b>description</b>	hinge L 128mm W 29mm H 23.5mm mounting pos. upper and bottom thickness 10.5mm bolt 17mm bolt ø 10mm series P3 1 pair		
<b>For models:</b>	OEB10.10, OEB10.20, OEB12.20, OEB20.10, OEB20.20, OEB6.10, OEB6.20, OES10.10, OES10.20, OES12.20, OES20.10, OES20.20, OES6.10, OES6.20, OGB10.10, OGB10.20, OGB12.20, OGB20.10, OGB20.20, OGB6.10, OGB6.20, OGS10.10, OGS10.20, OGS12.20, OGS20.10, OGS20.20, OGS6.10, OGS6.20		

<b>GEV No.</b>	692785	<b>Ref. No.</b>	6056840
<b>description</b>	hinge mounting pos. upper bolt 13mm bolt ø 10mm series CONVOTHERM 4 hinged at right		

<b>GEV No.</b>	692789	<b>Ref. No.</b>	2656838
<b>description</b>	hinge mounting pos. upper bolt 17mm bolt ø 10mm hinged at right series CONVOTHERM 4		

<b>GEV No.</b>	692788	<b>Ref. No.</b>	2656839
<b>description</b>	hinge mounting pos. lower bolt 18mm bolt ø 10mm hinged at right series CONVOTHERM 4		

<b>GEV No.</b>	692786	<b>Ref. No.</b>	6056844
<b>description</b>	hinge mounting pos. upper ID ø 10mm bolt 18mm bolt ø 18mm series CONVOTHERM 4 hinged at right		

<b>GEV No.</b>	692790	<b>Ref. No.</b>	6056843
<b>description</b>	hinge mounting pos. lower ID ø 10mm hinged at right series CONVOTHERM 4		

<b>GEV No.</b>	692791	<b>Ref. No.</b>	6056842
<b>description</b>	hinge mounting pos. upper ID ø 10mm bolt 19.5mm bolt ø 9.5mm hinged at right series CONVOTHERM 4		



1

<b>GEV No.</b>	699843	<b>Ref. No.</b>	2014003
<b>description</b>	hinge camp L 47mm W 28mm H 9mm mounting distance 22mm mounting pos. upper		
<b>For models:</b>	OEB10.10, OEB10.20, OEB12.20, OEB20.10, OEB20.20, OEB6.10, OEB6.20, OES10.10, OES10.20, OES12.20, OES20.10, OES20.20, OES6.10, OES6.20, OGB10.10, OGB10.20, OGB12.20, OGB20.10, OGB20.20, OGB6.10, OGB6.20, OGS10.10, OGS10.20, OGS12.20, OGS20.10, OGS20.20, OGS6.10, OGS6.20		

## miscellaneous



1

<b>GEV No.</b>	699844	<b>Ref. No.</b>	2014007
<b>description</b>	hinge L 49mm W 31mm mounting pos. lower		
<b>For models:</b>	OEB10.10, OEB10.20, OEB12.20, OEB20.10, OEB20.20, OEB6.10, OEB6.20, OES10.10, OES10.20, OES12.20, OES20.10, OES20.20, OES6.10, OES6.20, OGB10.10, OGB10.20, OGB12.20, OGB20.10, OGB20.20, OGB6.10, OGB6.20, OGS10.10, OGS10.20, OGS12.20, OGS20.10, OGS20.20, OGS6.10, OGS6.20		

## equipment feet and end caps

### bullet feet

#### zamak/SS



1

<b>GEV No.</b>	750715	<b>Ref. No.</b>	6014042
<b>description</b>	bullet foot pipe type 40x40 thickness 1-1.2mm H 75-105mm SS Qty 1 pcs		
<b>For models:</b>	OEB12.20, OEB20.10, OEB20.20, OES12.20, OES20.10, OES20.20, OGB12.20, OGB20.10, OGB20.20, OGS12.20, OGS20.10, OGS20.20		

### bolting feet



1

<b>GEV No.</b>	699852	<b>Ref. No.</b>	6056353
<b>description</b>	equipment foot L 150mm W 50mm H 100mm bore ø 8.5mm mounting distance mm Qty 1 pcs		



1

<b>GEV No.</b>	699498	<b>Ref. No.</b>	2118799
<b>description</b>	equipment foot ø 40mm H 25mm bore ø 7mm rubber Qty 4 pcs CONVOTHERM		
<b>For models:</b>	OES6.06		

## miscellaneous

### with spigot

#### ø125mm



1

<b>GEV No.</b>	710013	<b>Ref. No.</b>	6004066
<b>description</b>	fixed castor ø 125mm housing SS capacity 100kg spigot hight 66mm spigot-ø M10mm bearing slide bearing wheel body polypropylene H 155mm wheel width 32mm		
<b>For models:</b>	AR108, HUD12.20, HUD20.10, HUD20.20, OD10.20, OD12.20, OD20.10, OD20.20, OS12.20, OS20.10, OS20.20, OSC12.20, OSC20.10, OSC20.20, OSG12.20, OSG20.20, OSP12.20, OSP20.10, OSP20.20		



1

<b>GEV No.</b>	710021	<b>Ref. No.</b>	3303456 6004056
<b>description</b>	swivel castor ø 125mm housing SS capacity 100kg spigot hight 63mm spigot-ø M10mm bearing slide bearing wheel body polypropylene H 160mm wheel width 32mm		
<b>For models:</b>	AR108, HUD12.20, HUD20.10, HUD20.20, OD10.20, OD12.20, OD20.10, OD20.20, OS12.20, OS20.10, OS20.20, OSC12.20, OSC20.10, OSC20.20, OSG12.20, OSG20.20, OSP12.20, OSP20.10, OSP20.20		

## gaskets

### gaskets for heated units

#### window seals

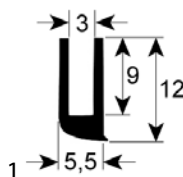

1

<b>GEV No.</b>	901430	<b>Ref. No.</b>	7001040
<b>description</b>	window gasket profile 1502 Qty supplied by meter		
<b>For models:</b>	AR12, AR18, AR8, HUD10.10, HUD12.20, HUD20.10, HUD20.20, HUD6.10, UG10.10, UG10.20, UG20.10, UG20.20, UG6.05, UG6.10		



<b>GEV No.</b>	900113	<b>Ref. No.</b>	7001041
<b>description</b>	window gasket profile 1560 Qty supplied by meter		
<b>For models:</b>	AR12, AR18, AR28, AR8, HUD10.10, HUD12.20, HUD20.10, HUD20.20, HUD6.10, OD10.10, OD10.20, OD12.20, OD20.10, OD20.20, OD6.10, UG10.10, UG10.20, UG20.10, UG20.20, UG6.05, UG6.10		

<b>GEV No.</b>	900448	<b>Ref. No.</b>	7001045
<b>description</b>	window gasket profile 1630 L 1800mm Qty 1		
<b>For models:</b>	OD10.10, OD6.10, OSG10.10, OSG6.10		

<b>GEV No.</b>	900114	<b>Ref. No.</b>	7001042
<b>description</b>	window gasket profile 1870 Qty supplied by meter		
<b>For models:</b>	AR28, HUD10.10, HUD12.20, HUD20.10, HUD20.20, HUD6.10, OD10.10, OD10.20, OD12.20, OD20.10, OD20.20, OD6.10		

## door seals

<b>GEV No.</b>	900062	<b>Ref. No.</b>	7001017 7001071
<b>description</b>	door seal profile 2060 L 720mm W 625mm Qty 1 outer plug size suitable for CONVOTHERM		
<b>For models:</b>	HUD10.10, OD10.10, OS10.10, OSC10.10, OSC10.20, OSC6.10, OSP10.10, OSP10.20, UG10.10		

<b>GEV No.</b>	900057	<b>Ref. No.</b>	7001013
<b>description</b>	door seal profile 2060 Qty supplied by meter		
<b>For models:</b>	AR72, HUD10.10, HUD12.20, HUD20.10, HUD20.20, HUD6.10, UG10.10, UG10.20, UG20.10, UG20.20, UG4.05, UG6.05, UG6.10		

<b>GEV No.</b>	900057	<b>Ref. No.</b>	7001013
<b>description</b>	door seal profile 2060 Qty supplied by meter		
<b>For models:</b>	AR72, HUD10.10, HUD12.20, HUD20.10, HUD20.20, HUD6.10, UG10.10, UG10.20, UG20.10, UG20.20, UG4.05, UG6.05, UG6.10		

<b>GEV No.</b>	900061	<b>Ref. No.</b>	7001016
<b>description</b>	door seal profile 2060 W 480mm L 625mm outer plug size Qty 1 suitable for CONVOTHERM 6 x 1/1		
<b>For models:</b>	HUD6.10, OD10.10, OD10.20, OD6.10, OS6.10, OSC6.10, OSP6.10, UG6.10		

<b>GEV No.</b>	900061	<b>Ref. No.</b>	7001016
<b>description</b>	door seal profile 2060 W 480mm L 625mm outer plug size Qty 1 suitable for CONVOTHERM 6 x 1/1		
<b>For models:</b>	HUD6.10, OD10.10, OD10.20, OD6.10, OS6.10, OSC6.10, OSP6.10, UG6.10		

<b>GEV No.</b>	900950	<b>Ref. No.</b>	7001032
<b>description</b>	door seal profile 2060 W 625mm L 810mm outer plug size suitable for CONVOTHERM OD/OS		
<b>For models:</b>	OD10.20, OS10.20, OSC10.20, OSP10.20		

<b>GEV No.</b>	900950	<b>Ref. No.</b>	7001032
<b>description</b>	door seal profile 2060 W 625mm L 810mm outer plug size suitable for CONVOTHERM OD/OS		
<b>For models:</b>	OD10.20, OS10.20, OSC10.20, OSP10.20		

<b>GEV No.</b>	901145	<b>Ref. No.</b>	7001050
<b>description</b>	door seal profile 2060 W 686mm L 770mm outer plug size Qty 1 suitable for CONVOTHERM		
<b>For models:</b>	OD10.20, OD12.20		

<b>GEV No.</b>	901145	<b>Ref. No.</b>	7001050
<b>description</b>	door seal profile 2060 W 686mm L 770mm outer plug size Qty 1 suitable for CONVOTHERM		
<b>For models:</b>	OD10.20, OD12.20		

mechanical components, equipment accessories

<b>GEV No.</b>	900064	<b>Ref. No.</b>	7001019 7001020
<b>description</b>	door seal profile 2060 W 705mm L 1080mm outer plug size Qty 1 suitable for CONVOTHERM short side open		
<b>For models:</b>	HUD12.20, OD10.20, OD12.20, OD20.10, OD20.20, OS12.20, OSC12.20, OSP12.20, UG20.20		

<b>GEV No.</b>	900063	<b>Ref. No.</b>	7001018 7001074
<b>description</b>	door seal profile 2060 W 705mm L 1635mm external size Qty 1 short side open		
<b>For models:</b>	AR100, HUD20.10, HUD20.20, OD20.10, OD20.20, OS20.10, OS20.20, OSC20.10, OSC20.20, OSP20.10, OSP20.20, UG20.10		

<b>GEV No.</b>	901289	<b>Ref. No.</b>	7001051
<b>description</b>	door seal profile 2060 W 710mm L 1300mm outer plug size Qty 1 suitable for CONVOTHERM OD20.20 Gas		
<b>For models:</b>	OD20.20		

<b>GEV No.</b>	900443	<b>Ref. No.</b>	7001034
<b>description</b>	door seal profile 2420 W 450mm L 460mm outer plug size Qty 1 suitable for CONVOTHERM		
<b>For models:</b>	OD6.10, OSG6.10		

<b>GEV No.</b>	900444	<b>Ref. No.</b>	7001035
<b>description</b>	door seal profile 2420 W 450mm L 700mm outer plug size Qty 1 suitable for CONVOTHERM		
<b>For models:</b>	OD10.10, OSG10.10		

<b>GEV No.</b>	901177	<b>Ref. No.</b>	7011051(Alternativ) 7011054(Alternativ)
<b>description</b>	door seal profile 2480 L 1470mm suitable for CONVOTHERM welded		

<b>GEV No.</b>	901951	<b>Ref. No.</b>	7011051 7011054 7011060
<b>description</b>	door seal profile 2480 L 1485mm Qty 1 suitable for CONVOTHERM series P3 for model OES 6.06/6.10 mini		
<b>For models:</b>	OES6.06		

<b>GEV No.</b>	901370	<b>Ref. No.</b>	7011052 (alternativ) 7011055 (alternativ) 7011061 (alternativ)
<b>description</b>	door seal profile 2480 L 1880mm Qty 1 suitable for CONVOTHERM model OES 10.10 mini		

<b>GEV No.</b>	902429	<b>Ref. No.</b>	7011052 7011055 7011061
<b>description</b>	door seal profile 2480 L 1880mm Qty 1 suitable for CONVOTHERM model OES 10.10 mini series C4		



<b>GEV No.</b>	901398	<b>Ref. No.</b>	7001079
<b>description</b>	door seal profile 2519 W 695mm L 1410mm external size Qty 1		
<b>For models:</b>	OSG20.20		

<b>GEV No.</b>	900930	<b>Ref. No.</b>	7011002 (Alternativ)
<b>description</b>	door seal profile 2715 W 460mm H 770mm outer plug size Qty 1		

<b>GEV No.</b>	901393	<b>Ref. No.</b>	7001078
<b>description</b>	door seal profile 2519 W 695mm L 885mm external size suitable for CONVOTHERM		
<b>For models:</b>	OSG12.20		

<b>GEV No.</b>	902422	<b>Ref. No.</b>	7011002
<b>description</b>	door seal profile 2715 W 460mm H 770mm outer plug size Qty 1 for model 10.10 series P3 CONVOTHERM		
<b>For models:</b>	OEB10.10, OES10.10, OGB10.10, OGS10.10		

<b>GEV No.</b>	900791	<b>Ref. No.</b>	7011003 (alternativ)
<b>description</b>	door seal profile 2715 W 460mm H 1495mm outer plug size Qty 1		

<b>GEV No.</b>	900369	<b>Ref. No.</b>	7011001 (alternativ)
<b>description</b>	door seal profile 2715 W 465mm H 510mm outer plug size Qty 1		

<b>GEV No.</b>	902424	<b>Ref. No.</b>	7011003
<b>description</b>	door seal profile 2715 W 460mm H 1495mm outer plug size Qty 1 for model 20.10 series P3 CONVOTHERM		
<b>For models:</b>	OEB20.10, OES20.10, OGB20.10, OGS20.10		

<b>GEV No.</b>	900851	<b>Ref. No.</b>	7011007 (alternativ)
<b>description</b>	door seal profile 2715 W 670mm H 1495mm outer plug size Qty 1		

<b>GEV No.</b>	902423	<b>Ref. No.</b>	7011001
<b>description</b>	door seal profile 2715 W 460mm H 510mm outer plug size Qty 1 for model 6.10 series P3 CONVOTHERM		
<b>For models:</b>	OEB6.10, OES6.10, OGB6.10, OGS6.10		

<b>GEV No.</b>	902428	<b>Ref. No.</b>	7011007
<b>description</b>	door seal profile 2715 W 670mm H 1495mm outer plug size Qty 1 for model 20.20 series P3 CONVOTHERM		
<b>For models:</b>	OEB20.20, OES20.20, OGB20.20, OGS20.20		



<b>GEV No.</b>	901436	<b>Ref. No.</b>	7011004 (alternativ)
<b>description</b>	door seal profile 2715 W 670mm H 550mm outer plug size Qty 1		



<b>GEV No.</b>	900853	<b>Ref. No.</b>	7011006 (alternativ)
<b>description</b>	door seal profile 2715 W 670mm H 965mm outer plug size Qty 1		

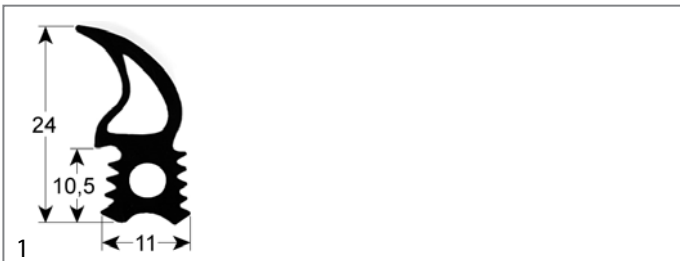

<b>GEV No.</b>	902426	<b>Ref. No.</b>	7011004
<b>description</b>	door seal profile 2715 W 670mm H 550mm outer plug size Qty 1 for model 6.20 series P3 CONVOTHERM		
<b>For models:</b>	OEB6.20, OES6.20, OGB6.20, OGS6.20		

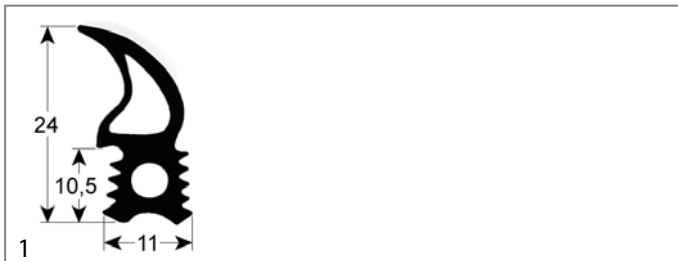

<b>GEV No.</b>	902427	<b>Ref. No.</b>	7011006
<b>description</b>	door seal profile 2715 W 670mm H 965mm outer plug size Qty 1 for model 12.20 series P3 CONVOTHERM		
<b>For models:</b>	OEB12.20, OES12.20, OGB12.20, OGS12.20		

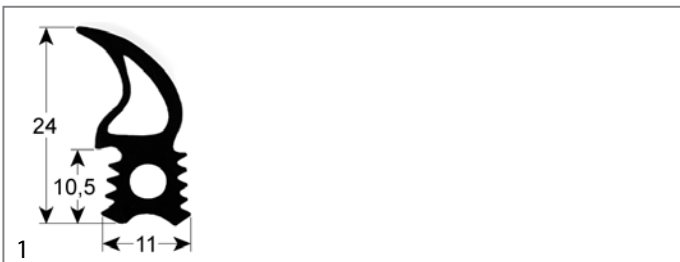

<b>GEV No.</b>	900852	<b>Ref. No.</b>	7011005 (alternativ)
<b>description</b>	door seal profile 2715 W 670mm H 770mm outer plug size Qty 1		

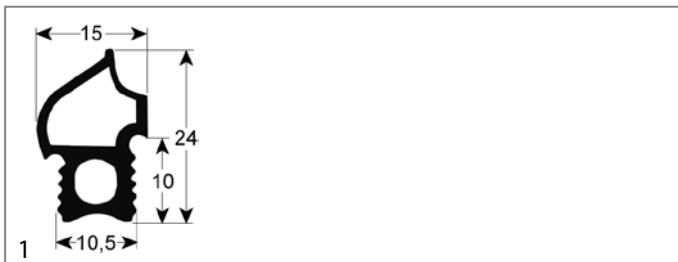

<b>GEV No.</b>	902433	<b>Ref. No.</b>	7056343
<b>description</b>	door seal profile 2717 W 460mm H 1495mm outer plug size Qty 1 CONVOTHERM 20.10 C4 Serie		



<b>GEV No.</b>	902425	<b>Ref. No.</b>	7011005
<b>description</b>	door seal profile 2715 W 670mm H 770mm outer plug size Qty 1 for model 10.20 series P3 CONVOTHERM		
<b>For models:</b>	OEB10.20, OES10.20, OGB10.20, OGS10.20		



<b>GEV No.</b>	902416	<b>Ref. No.</b>	7056338
<b>description</b>	door seal profile 2717 W 460mm H 490mm outer plug size Qty 1 CONVOTHERM 6.10 C4 Serie		



<b>GEV No.</b>	902393	<b>Ref. No.</b>	7056340
<b>description</b>	door seal profile 2717 W 460mm H 760mm outer plug size Qty 1 CONVOTHERM 10.10 C4 Serie		



<b>GEV No.</b>	902430	<b>Ref. No.</b>	7056339
<b>description</b>	door seal profile 2717 W 490mm H 660mm outer plug size Qty 1 CONVOTHERM 6.20 C4 Serie		

<b>GEV No.</b>	902432	<b>Ref. No.</b>	7056342
<b>description</b>	door seal profile 2717 W 660mm H 960mm outer plug size Qty 1 CONVOTHERM 12.20 C4 Serie		

<b>GEV No.</b>	902394	<b>Ref. No.</b>	7056344
<b>description</b>	door seal profile 2717 W 665mm H 1490mm outer plug size Qty 1 CONVOTHERM 20.20 C4 Serie		

<b>GEV No.</b>	902431	<b>Ref. No.</b>	7056341
<b>description</b>	door seal profile 2717 W 66mm H 760mm outer plug size Qty 1 CONVOTHERM 10.20 C4 Serie		

<b>GEV No.</b>	902449	<b>Ref. No.</b>	6016507
<b>description</b>	door seal profile 2800 W 730mm L 1540mm external size Qty 1 suitable for CONVOTHERM for heated trolley		

**gaskets for tray rack trolleys**

<b>GEV No.</b>	900167	<b>Ref. No.</b>	7001039 7001039K 7030645
<b>description</b>	tray rack trolley gasket profile 4030 L 1970mm Qty 1 silicone transparent		
<b>For models:</b>	HUD12.20, HUD20.10, HUD20.20, OD12.20, OD20.10, OD20.20, OS12.20, OS20.10, OS20.20, OSC12.20, OSC20.10, OSC20.20, OSP12.20, OSP20.10, OSP20.20, UG10.10, UG10.20, UG20.10, UG20.20		

<b>GEV No.</b>	900403	<b>Ref. No.</b>	N/A
<b>description</b>	tray rack trolley gasket profile 4030 Qty supplied by meter silicone transparent		

<b>GEV No.</b>	901150	<b>Ref. No.</b>	7011000	
<b>description</b>	tray rack trolley gasket profile 4080 L 540mm Qty 1			
<b>For models:</b>	OEB20.10, OES20.10, OGB20.10, OGS20.10			
<b>accessories for</b>	901150			
	<b>GEV No.</b>	560067	<b>Ref. No.</b>	8001031
	flat-headed bolt thread M5 thread L 10mm SS DIN 7985/ISO 7045 Qty 20 pcs intake Phillips head ø 8mm head thickness 2mm			

<b>GEV No.</b>	900850	<b>Ref. No.</b>	7001077 (alternativ)
<b>description</b>	tray rack trolley gasket profile 4080 L 740mm Qty 1		

<b>GEV No.</b>	901833'	<b>Ref. No.</b>	2514386 2525227
<b>description</b>	tray rack trolley gasket profile 4085 L 535mm Qty 1 incl. fastening strip		
<b>For models:</b>	OEB20.10, OES20.10, OGB20.10, OGS20.10		

'incl. mounting rail

mechanical components, equipment accessories

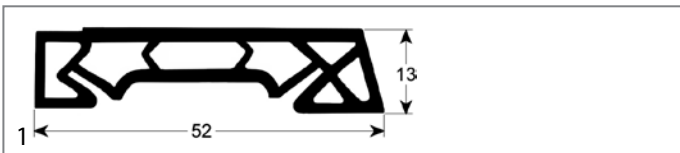

<b>GEV No.</b>	901574	<b>Ref. No.</b>	7011009
<b>description</b>	tray rack trolley gasket profile 4085 L 540mm Qty 1		

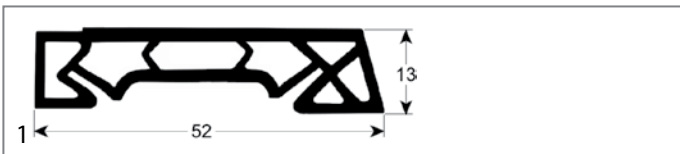

<b>GEV No.</b>	902338	<b>Ref. No.</b>	7056806
<b>description</b>	tray rack trolley gasket profile 4085 L 570mm Qty 1		

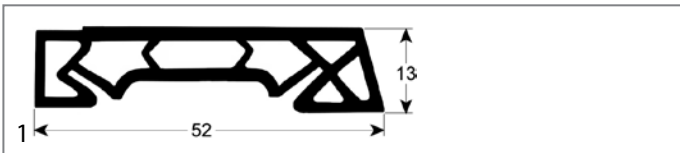

<b>GEV No.</b>	901749	<b>Ref. No.</b>	2514385 2525226 7001077
<b>description</b>	tray rack trolley gasket profile 4085 L 725mm Qty 1 incl. fastening strip		
<b>For models:</b>	OEB12.20, OEB20.20, OES12.20, OES20.20, OGB12.20, OGB20.20, OGS12.20, OGS20.20, OSG12.20		

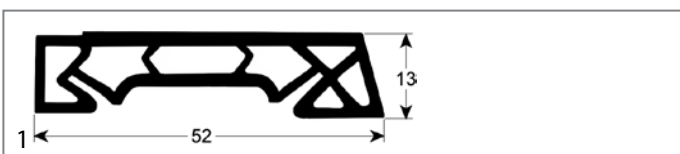

<b>GEV No.</b>	902441	<b>Ref. No.</b>	7011008
<b>description</b>	tray rack trolley gasket profile 4085 L 740mm Qty 1		

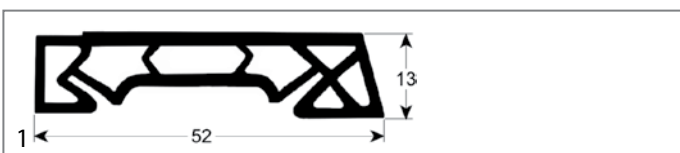

<b>GEV No.</b>	902339	<b>Ref. No.</b>	7056805
<b>description</b>	tray rack trolley gasket profile 4085 L 780mm Qty 1		

**gaskets for control panels**



<b>GEV No.</b>	902415	<b>Ref. No.</b>	7011010
<b>description</b>	gasket for control panel profile W 155mm L 600mm suitable for CONVOTHERM self-adhesive Qty		
<b>For models:</b>	OEB10.10, OEB10.20, OEB12.20, OEB20.10, OEB20.20, OEB6.10, OEB6.20, OES10.10, OES10.20, OES12.20, OES20.10, OES20.20, OES6.10, OES6.20, OGB10.10, OGB10.20, OGB12.20, OGB20.10, OGB20.20, OGB6.10, OGB6.20, OGS10.10, OGS10.20, OGS12.20, OGS20.10, OGS20.20, OGS6.10, OGS6.20		

**miscellaneous**

**miscellaneous**



<b>GEV No.</b>	902417	<b>Ref. No.</b>	7003066
<b>description</b>	sealing strip Qty supplied by meter self-adhesive suitable for CONVOTHERM size 9x3mm		
<b>For models:</b>	OD10.10, OD10.20, OD12.20, OD20.20, OD6.10, OEB10.10, OEB10.20, OEB12.20, OEB20.10, OEB20.20, OEB6.10, OEB6.20, OES10.10, OES10.20, OES12.20, OES20.10, OES20.20, OES6.06, OES6.10, OES6.20, OGB10.10, OGB10.20, OGB12.20, OGB20.10, OGB20.20, OGB6.10, OGB6.20, OGS10.10, OGS10.20, OGS12.20, OGS20.10, OGS20.20, OGS6.10, OGS6.20, OSG10.10, OSG12.20, OSG20.20, OSG6.10		

**O-rings**

**EPDM**

**ø3.00mm**

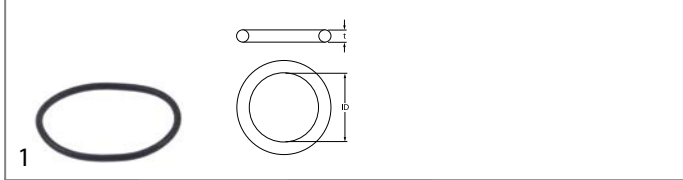

<b>GEV No.</b>	532674	<b>Ref. No.</b>	6005236
<b>description</b>	O-ring EPDM thickness 3mm ID ø 53mm Qty 1 pcs		
<b>For models:</b>	OEB10.10, OEB10.20, OEB12.20, OEB20.10, OEB20.20, OEB6.10, OEB6.20, OES10.10, OES10.20, OES12.20, OES20.10, OES20.20, OES6.10, OES6.20, OGB10.10, OGB10.20, OGB12.20, OGB20.10, OGB20.20, OGB6.10, OGB6.20, OGS10.10, OGS10.20, OGS12.20, OGS20.10, OGS20.20, OGS6.10, OGS6.20		

**ø4.00mm**

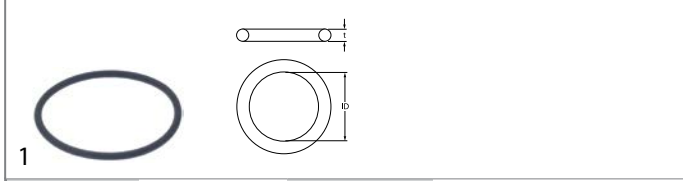

<b>GEV No.</b>	532673	<b>Ref. No.</b>	6015000 6015010
<b>description</b>	O-ring EPDM thickness 4mm ID ø 67mm Qty 1 pcs		
<b>For models:</b>	OEB10.10, OEB10.20, OEB12.20, OEB20.10, OEB20.20, OEB6.10, OEB6.20, OES10.10, OES10.20, OES12.20, OES20.10, OES20.20, OES6.10, OES6.20, OGB10.10, OGB10.20, OGB12.20, OGB20.10, OGB20.20, OGB6.10, OGB6.20, OGS10.10, OGS10.20, OGS12.20, OGS20.10, OGS20.20, OGS6.10, OGS6.20		

**ø5.34mm**

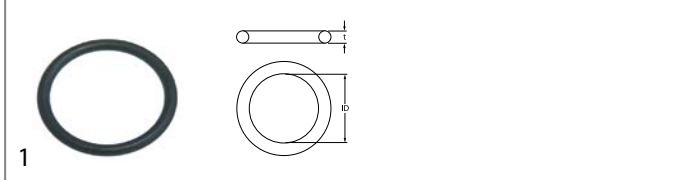

<b>GEV No.</b>	510408	<b>Ref. No.</b>	6005015
<b>description</b>	O-ring EPDM thickness 5.34mm ID ø 47mm Qty 1 pcs		
<b>For models:</b>	OD10.10, OD10.20, OD12.20, OD20.10, OD20.20, OD6.10, OS10.10, OS10.20, OS12.20, OS20.10, OS20.20, OS6.10, OSC10.10, OSC10.20, OSC12.20, OSC20.10, OSC20.20, OSC6.10, OSP10.10, OSP10.20, OSP12.20, OSP20.10, OSP20.20, OSP6.10		





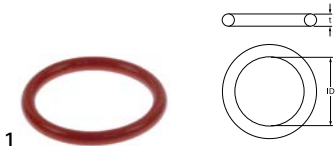

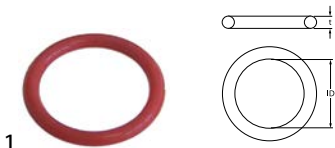
silicone			
ø5,00mm			
			
<b>GEV No.</b>	696759	<b>Ref. No.</b>	6056349
<b>description</b>	O-ring silicone thickness 5.34mm ID ø 43.82mm Qty 5 pcs		

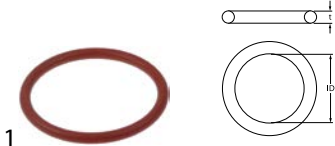
ø5.34mm			
			
<b>GEV No.</b>	532638	<b>Ref. No.</b>	6005068
<b>description</b>	O-ring silicone thickness 5.34mm ID ø 43.82mm Qty 1 pcs		
<b>For models:</b>	OD6.10, OEB10.10, OEB10.20, OEB12.20, OEB20.10, OEB20.20, OEB6.10, OEB6.20, OES10.10, OES10.20, OES12.20, OES20.10, OES20.20, OES6.10, OES6.20, OGB10.10, OGB10.20, OGB12.20, OGB20.10, OGB20.20, OGB6.10, OGB6.20, OGS10.10, OGS10.20, OGS12.20, OGS20.10, OGS20.20, OGS6.10, OGS6.20		

			
<b>GEV No.</b>	532575	<b>Ref. No.</b>	6005069
<b>description</b>	O-ring silicone thickness 5.34mm ID ø 59.69mm Qty 1 pcs		
<b>For models:</b>	OD10.10, OD10.20, OD12.20, OD20.10, OD20.20, OD6.10, OS10.10, OS10.20, OS12.20, OS20.10, OS20.20, OS6.10, OSC10.10, OSC10.20, OSC12.20, OSC20.10, OSC20.20, OSC6.10, OSP10.10, OSP10.20, OSP12.20, OSP20.10, OSP20.20, OSP6.10		

sealing washers			
fibre gaskets			
			
<b>GEV No.</b>	510416	<b>Ref. No.</b>	6005016
<b>description</b>	flat gasket fibre ED ø 19mm ID ø 10.5mm thickness 1.5mm for thread M10 Qty 1 pcs		
<b>For models:</b>	OD10.10, OD10.20, OD12.20, OD20.10, OD20.20, OD6.10, OEB10.10, OEB10.20, OEB12.20, OEB20.10, OEB20.20, OEB6.10, OEB6.20, OES10.10, OES10.20, OES12.20, OES20.10, OES20.20, OES6.10, OES6.20, OGB10.10, OGB10.20, OGB12.20, OGB20.10, OGB20.20, OGB6.10, OGB6.20, OGS10.10, OGS10.20, OGS12.20, OGS20.10, OGS20.20, OGS6.10, OGS6.20, OS10.10, OS10.20, OS12.20, OS20.10, OS20.20, OS6.10, OSP10.10, OSP10.20, OSP12.20, OSP20.10, OSP20.20, OSP6.10		

			
<b>GEV No.</b>	510406	<b>Ref. No.</b>	6005065
<b>description</b>	flat gasket fibre ED ø 60mm ID ø 48mm thickness 3mm for thread 1½" Qty 1 pcs		
<b>For models:</b>	HUD10.10, HUD12.20, HUD20.10, HUD20.20, HUD6.10, OD10.10, OD10.20, OD12.20, OD20.10, OD20.20, OD6.10		

graphite gaskets			
			
<b>GEV No.</b>	691609	<b>Ref. No.</b>	6015028
<b>description</b>	gasket graphite ED ø 150mm ID ø 115mm thickness 2mm Qty 1 pcs		
<b>For models:</b>	OGB10.10, OGB10.20, OGB12.20, OGB20.10, OGB20.20, OGB6.10, OGB6.20, OGS10.10, OGS10.20, OGS12.20, OGS20.10, OGS20.20, OGS6.10, OGS6.20		

			
<b>GEV No.</b>	521012	<b>Ref. No.</b>	6005260
<b>description</b>	gasket graphite ED ø 15mm ID ø 5mm thickness 1.2mm Qty 1 pcs		
<b>For models:</b>	OEB10.10, OEB10.20, OEB12.20, OEB20.10, OEB20.20, OEB6.10, OEB6.20, OES10.10, OES10.20, OES12.20, OES20.10, OES20.20, OES6.06, OES6.10, OES6.20, OGB10.10, OGB10.20, OGB12.20, OGB20.10, OGB20.20, OGB6.10, OGB6.20, OGS10.10, OGS10.20, OGS12.20, OGS20.10, OGS20.20, OGS6.10, OGS6.20, OS10.10, OS10.20, OS12.20, OS20.10, OS20.20, OS6.10, OSC10.10, OSC10.20, OSC12.20, OSC20.10, OSC20.20, OSC6.10, OSG20.20, OSP10.10, OSP10.20, OSP12.20, OSP20.10, OSP20.20, OSP6.10		

			
<b>GEV No.</b>	514439	<b>Ref. No.</b>	6015034
<b>description</b>	gasket graphite ED ø 82.5mm ID ø 52.5mm thickness 2mm		
<b>For models:</b>	OGB10.10, OGB10.20, OGB12.20, OGB20.10, OGB20.20, OGB6.10, OGB6.20, OGS10.10, OGS10.20, OGS12.20, OGS20.10, OGS20.20, OGS6.10, OGS6.20		

plastic gaskets			
			
<b>GEV No.</b>	510670	<b>Ref. No.</b>	6005407
<b>description</b>	gasket plastic ED ø 20mm ID ø 15mm thickness 2.9mm Qty 1 pcs		
<b>For models:</b>	OEB6.10, OES6.10, OS10.10, OS10.20, OS12.20, OS20.10, OS20.20, OS6.10, OSP10.10, OSP10.20, OSP12.20, OSP20.10, OSP20.20, OSP6.10		

copper gaskets

DIN-7603-C



<b>GEV No.</b>	510420	<b>Ref. No.</b>	6005055
<b>description</b>	gasket copper ED ø 19.9mm ID ø 14.3mm thickness 2mm Qty 1 pcs		
<b>For models:</b>	HUD10.10, HUD12.20, HUD20.10, HUD20.20, HUD6.10, OD10.10, OD10.20, OD12.20, OD20.10, OD20.20, OD6.10, OEB10.10, OEB10.20, OEB12.20, OEB20.10, OEB20.20, OEB6.10, OEB6.20, OES10.10, OES10.20, OES12.20, OES20.10, OES20.20, OES6.10, OES6.20, OGB10.10, OGB10.20, OGB12.20, OGB20.10, OGB20.20, OGB6.10, OGB6.20, OGS10.10, OGS10.20, OGS12.20, OGS20.10, OGS20.20, OGS6.10, OGS6.20, OS10.10, OS10.20, OS12.20, OS20.10, OS20.20, OS6.10, OSC10.10, OSC10.20, OSC12.20, OSC20.10, OSC20.20...(Other models you can see in the webshop)		

paper gasket



<b>GEV No.</b>	512427	<b>Ref. No.</b>	6005025
<b>description</b>	gasket paper ED ø 54mm ID ø 42.5mm thickness 2mm Qty 1 pcs ø 1 1/4"mm		
<b>For models:</b>	OEB10.10, OEB10.20, OEB12.20, OEB20.10, OEB6.10, OEB6.20, OES10.10, OES10.20, OES12.20, OES20.10, OES6.10, OES6.20, OGB10.10, OGB6.10, OGB6.20, OGS10.10, OGS6.10, OGS6.20		

silicone gaskets



<b>GEV No.</b>	693168	<b>Ref. No.</b>	6005074
<b>description</b>	gasket silicone ED ø 44mm ID ø 4mm thickness 5mm Qty 1 pcs		
<b>For models:</b>	OD10.10, OD10.20, OD12.20, OD20.10, OD20.20, OD6.10, OS10.10, OS10.20, OS12.20, OS20.10, OS20.20, OS6.10, OSC10.10, OSC10.20, OSC12.20, OSC20.10, OSC20.20, OSC6.10, OSP10.10, OSP10.20, OSP12.20, OSP20.10, OSP20.20, OSP6.10		



<b>GEV No.</b>	359721	<b>Ref. No.</b>	5005025
<b>description</b>	gasket silicone ED ø 48mm ID ø 39.5mm thickness 5mm Qty 1 pcs		
<b>For models:</b>	HUD10.10, HUD12.20, HUD20.10, HUD20.20, HUD6.10, OD10.10, OD10.20, OD12.20, OD20.10, OD20.20, OD6.10, UG10.10, UG10.20, UG20.10, UG20.20, UG4.05, UG6.05, UG6.10		

Viton gaskets



<b>GEV No.</b>	510577	<b>Ref. No.</b>	6005081
<b>description</b>	flat gasket Viton ED ø 7.5mm ID ø 1mm thickness 5mm Qty 1 pcs		
<b>For models:</b>	HUD10.10, HUD12.20, HUD20.10, HUD20.20, HUD6.10		

shaft gaskets

miscellaneous



<b>GEV No.</b>	694646	<b>Ref. No.</b>	2617295
<b>description</b>	shaft sealing set for hot air motors		
<b>For models:</b>	OEB10.10, OEB10.20, OEB12.20, OEB20.10, OEB20.20, OEB6.10, OEB6.20, OES10.10, OES10.20, OES12.20, OES20.10, OES20.20, OES6.10, OES6.20, OGB10.10, OGB10.20, OGB12.20, OGB20.10, OGB20.20, OGB6.10, OGB6.20, OGS10.10, OGS10.20, OGS12.20, OGS20.10, OGS20.20, OGS6.10, OGS6.20		

special gaskets

for combi-steamers



<b>GEV No.</b>	560644	<b>Ref. No.</b>	6056494
<b>description</b>	boot for drain pan ED ø 60mm ID ø 44mm CONVOTHERM 4		

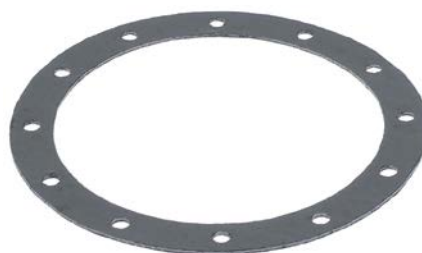

<b>GEV No.</b>	699822	<b>Ref. No.</b>	6015029
<b>description</b>	gasket for burner chamber ED ø 170mm ID ø 134mm graphite thickness 2mm		
<b>For models:</b>	OGB10.20, OGB12.20, OGB20.20, OGS10.20, OGS12.20, OGS20.20		

1

<b>GEV No.</b>	699825	<b>Ref. No.</b>	6015030
<b>description</b>	gasket L 63mm W 63mm for flues ID ø 42mm graphite thickness 2mm hole distance 50mm		
<b>For models:</b>	OGB10.10, OGB20.10, OGB6.10, OGB6.20, OGS10.10, OGS20.10, OGS6.10, OGS6.20		



1

<b>GEV No.</b>	560636	<b>Ref. No.</b>	6064079
<b>description</b>	gasket suitable for CONVOTHERM burner L 150mm W 150mm with mounting accessories graphite thickness 2mm 10.20/20.20		



1

<b>GEV No.</b>	560643	<b>Ref. No.</b>	6056943
<b>description</b>	gasket suitable for CONVOTHERM combi-steamer L 90mm W 29mm with mounting kit graphite thickness 2mm		



1

<b>GEV No.</b>	699239	<b>Ref. No.</b>	6005067
<b>description</b>	sealing disc ED ø 36mm thickness 5mm aperture 5mmmm		
<b>For models:</b>	HUD10.10, HUD12.20, HUD20.10, HUD20.20, HUD6.10, OD10.10, OD10.20, OD12.20, OD20.10, OD20.20, OD6.10		

miscellaneous



1

<b>GEV No.</b>	514439	<b>Ref. No.</b>	6015034
<b>description</b>	gasket graphite ED ø 82.5mm ID ø 52.5mm thickness 2mm		
<b>For models:</b>	OGB10.10, OGB10.20, OGB12.20, OGB20.10, OGB20.20, OGB6.10, OGB6.20, OGS10.10, OGS10.20, OGS12.20, OGS20.10, OGS20.20, OGS6.10, OGS6.20		



1

<b>GEV No.</b>	521013	<b>Ref. No.</b>	2623226 6015025
<b>description</b>	gasket set suitable for CONVOTHERM for heating element L 90mm W 71mm Qty 1m graphite hole distance 54/74mm		
<b>For models:</b>	OEB10.10, OEB20.10, OEB6.10, OEB6.20, OES10.10, OES20.10, OES6.10, OES6.20		



1

<b>GEV No.</b>	510086	<b>Ref. No.</b>	2006010
<b>description</b>	gasket suitable for CONVOTHERM for tray rack trolley L 55mm W 50mm thickness 15mm		
<b>For models:</b>	OD12.20, OD20.10, OD20.20, OS12.20, OS20.10, OS20.20, OSC12.20, OSC20.10, OSC20.20, OSP12.20, OSP20.10, OSP20.20		



1

<b>GEV No.</b>	514441	<b>Ref. No.</b>	6015040 6056350
<b>description</b>	gasket suitable for CONVOTHERM L 65mm W 55mm thickness 2.5mm		
<b>For models:</b>	OEB10.10, OEB10.20, OEB12.20, OEB20.10, OEB20.20, OEB6.10, OEB6.20, OES10.10, OES10.20, OES12.20, OES20.10, OES20.20, OES6.10, OES6.20, OGB10.10, OGB10.20, OGB12.20, OGB20.10, OGB20.20, OGB6.10, OGB6.20, OGS10.10, OGS10.20, OGS12.20, OGS20.10, OGS20.20, OGS6.10, OGS6.20		

springs  
miscellaneous



1

<b>GEV No.</b>	697940	<b>Ref. No.</b>	5009083
<b>description</b>	spring for thermostat shaft diameter 6x4.6mm ømm L 35mm W 20mm H 9mm wire gauge ø 1mm		
<b>For models:</b>	OD10.10, OD10.20, OD12.20, OD20.10, OD20.20, OD6.10		



1

<b>GEV No.</b>	697939	<b>Ref. No.</b>	5009082
<b>description</b>	spring for timer shaft diameter 6x4.6mm		
<b>For models:</b>	OD10.10, OD10.20, OD12.20, OD20.10, OD20.20, OD6.10		

## manometers



1

<b>GEV No.</b>	541508	<b>Ref. No.</b>	6006140
<b>description</b>	manometer ø 40mm pressure range 0-4bar connection thread 1/8"		
<b>For models:</b>	OD10.10, OD10.20, OD12.20, OD20.20, OD6.10, OSG10.10, OSG12.20, OSG20.20, OSG6.10		

## hose reels and spray guns

### spray guns



1

<b>GEV No.</b>	542964	<b>Ref. No.</b>	6011010
<b>description</b>	spray gun for appliances 1/2" ET L 135mm		
<b>For models:</b>	OEB10.10, OEB10.20, OEB6.10, OEB6.20, OES10.10, OES10.20, OES6.10, OES6.20, OGB10.10, OGB10.20, OGB6.10, OGB6.20, OGS10.10, OGS10.20, OGS6.10, OGS6.20		



1

<b>GEV No.</b>	540158	<b>Ref. No.</b>	6005005
<b>description</b>	spray gun for appliances 1/2" ET type ECHTERMANN		
<b>For models:</b>	HUD10.10, HUD12.20, HUD20.10, HUD20.20, HUD6.10, OD10.10, OD10.20, OD12.20, OD20.10, OD20.20, OD6.10, OEB10.10, OEB10.20, OEB12.20, OEB20.10, OEB20.20, OEB6.10, OEB6.20, OES10.10, OES10.20, OES12.20, OES20.10, OES20.20, OES6.10, OES6.20, OGB10.10, OGB10.20, OGB12.20, OGB20.10, OGB20.20, OGB6.10, OGB6.20, OGS10.10, OGS10.20, OGS12.20, OGS20.10, OGS20.20, OGS6.10, OGS6.20, OS10.10, OS10.20, OS12.20, OS20.10, OS20.20, OS6.10, OSC10.10, OSC10.20, OSC12.20, OSC20.10, OSC20.20...(Other models you can see in the webshop)		



1

<b>GEV No.</b>	542038	<b>Ref. No.</b>	6011005
<b>description</b>	spray gun for appliances 3/8" IT L 135mm		



1

<b>GEV No.</b>	542376	<b>Ref. No.</b>	6056382
<b>description</b>	spray gun for appliances 3/8" L 130mm stainless steel		

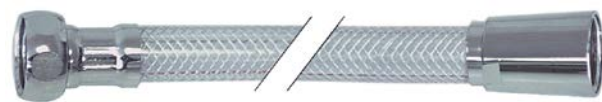

1

<b>GEV No.</b>	520277	<b>Ref. No.</b>	7012070 7012071 7012072
<b>description</b>	shower hose connections 1/2" L 1500mm PVC operating p. 10bar burst p. 30bar t.max. 60°C approval NSF rotary with fabric		
<b>For models:</b>	OEB10.10, OEB10.20, OEB12.20, OES10.10, OES10.20, OES12.20, OGB10.10, OGB10.20, OGB12.20, OGS10.10, OGS10.20, OGS12.20		



1

<b>GEV No.</b>	520096	<b>Ref. No.</b>	7002070
<b>description</b>	shower hose connections 1/2" L 2000mm PVC operating p. 10bar burst p. 30bar t.max. 60°C approval NSF rotary with fabric		
<b>For models:</b>	HUD10.10, HUD12.20, HUD6.10, OD10.10, OD6.10, OEB20.10, OEB20.20, OES20.10, OES20.20, OGB20.10, OGB20.20, OGS20.10, OGS20.20, OS10.10, OS6.10, OSC10.10, OSC6.10, OSG12.20, OSP10.10, OSP6.10		





1

<b>GEV No.</b>	520097	<b>Ref. No.</b>	7002071
<b>description</b>	shower hose connections 1/2" L 2200mm PVC operating p. 10bar burst p. 30bar t.max. 60°C approval NSF rotary with fabric		
<b>For models:</b>	HUD20.10, OD10.20, OD12.20, OD20.10, OD20.20, OS10.20, OS12.20, OS20.10, OSC10.20, OSC12.20, OSC20.10, OSP10.20, OSP12.20, OSP20.10		





			
1			
<b>GEV No.</b>	520098	<b>Ref. No.</b>	7002072
<b>description</b>	shower hose connections 1/2" L 2600mm PVC operating p. 10bar burst p. 30bar t.max. 60°C approval NSF rotary with fabric		
<b>For models:</b>	HUD20.20, OD20.20, OS20.20, OSC20.20, OSG20.20, OSP20.20		

			
1			
<b>GEV No.</b>	691094	<b>Ref. No.</b>	6011012
<b>description</b>	wall holder for hand spray		

			
1			
<b>GEV No.</b>	520968	<b>Ref. No.</b>	2625199
<b>description</b>	shower hose connections 3/8" L 1700mm connection 2: 12mm		

			
1			
<b>GEV No.</b>	540008	<b>Ref. No.</b>	6005006 6005006K 6030643
<b>description</b>	shower head connection 1/2" metal		
<b>For models:</b>	HUD10.10, HUD12.20, HUD20.10, HUD20.20, HUD6.10, OD10.10, OD10.20, OD12.20, OD20.10, OD20.20, OD6.10, OEB10.10, OEB10.20, OEB12.20, OEB20.10, OEB20.20, OEB6.10, OEB6.20, OES10.10, OES10.20, OES12.20, OES20.10, OES20.20, OES6.10, OES6.20, OGB10.10, OGB10.20, OGB12.20, OGB20.10, OGB20.20, OGB6.10, OGB6.20, OGS10.10, OGS10.20, OGS12.20, OGS20.10, OGS20.20, OGS6.10, OGS6.20, OS10.10, OS10.20, OS12.20, OS20.10, OS20.20, OS6.10, OSC10.10, OSC10.20, OSC12.20, OSC20.10, OSC20.20...(Other models you can see in the webshop)		

			
1			
<b>GEV No.</b>	540961	<b>Ref. No.</b>	6011012
<b>description</b>	wall holder for hand spray		
<b>For models:</b>	OEB10.10, OEB10.20, OEB6.10, OEB6.20, OES10.10, OES10.20, OES6.10, OES6.20, OGB10.10, OGB10.20, OGB6.10, OGB6.20, OGS10.10, OGS10.20, OGS6.10, OGS6.20		

			
1			
<b>GEV No.</b>	542966	<b>Ref. No.</b>	6011012
<b>description</b>	wall holder for hand spray		

hose reels

appliance hose reels

			
1			
<b>GEV No.</b>	542319	<b>Ref. No.</b>	2625201 6011015
<b>description</b>	hose reel complete with spray gun hose length 1.5m		

			
1			
<b>GEV No.</b>	542420	<b>Ref. No.</b>	6056491
<b>description</b>	hose reel for combi-steamer complete with spray gun hose length 1.3m hose ø DN6mm hose type drinking water		

			
1			
<b>GEV No.</b>	542424	<b>Ref. No.</b>	2625200
<b>description</b>	hose reel for combi-steamer complete with spray gun hose length 1.5m hose ø DN6mm hose type drinking water		

cleaning guns

spare parts and accessories

hoses

			
1			
<b>GEV No.</b>	699853	<b>Ref. No.</b>	7064050
<b>description</b>	hose ø DN13mm length 960 with clip t.max. 95°C approval FDA		



## hoses

### supply hoses

#### PVC supply hoses

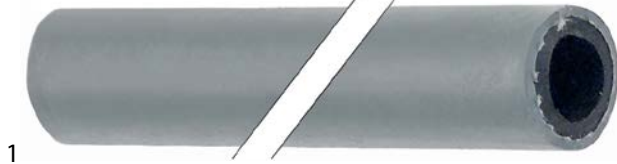

<b>GEV No.</b>	520016	<b>Ref. No.</b>	7012080-40M
<b>description</b>	supply hose ID $\varnothing$ 13mm ED $\varnothing$ 20mm L 40m operating p. 20bar burst p. 60bar t.max. 95°C grey Qty 40m		

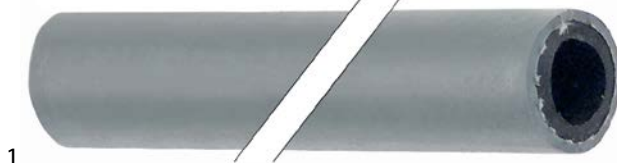

<b>GEV No.</b>	520017	<b>Ref. No.</b>	7012080-5MT
<b>description</b>	supply hose ID $\varnothing$ 13mm ED $\varnothing$ 20mm L 5m operating p. 20bar burst p. 60bar t.max. 95°C grey Qty 5m		

#### plastic/rubber hoses



<b>GEV No.</b>	699853	<b>Ref. No.</b>	7064050
<b>description</b>	hose $\varnothing$ DN13mm length 960 with clip t.max. 95°C approval FDA		

#### pre-rinse hoses

##### PVC braided hoses



<b>GEV No.</b>	520277	<b>Ref. No.</b>	7012070 7012071 7012072
<b>description</b>	shower hose connections 1/2" L 1500mm PVC operating p. 10bar burst p. 30bar t.max. 60°C approval NSF rotary with fabric		
<b>For models:</b>	OEB10.10, OEB10.20, OEB12.20, OES10.10, OES10.20, OES12.20, OGB10.10, OGB10.20, OGB12.20, OGS10.10, OGS10.20, OGS12.20		

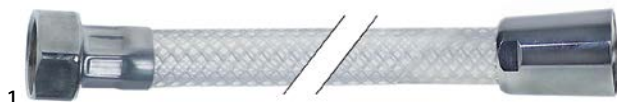

<b>GEV No.</b>	520311	<b>Ref. No.</b>	7012073 7012080 7013073
<b>description</b>	shower hose connections 1/2" L 1800mm operating p. 10bar burst p. 18bar t.max. 60°C approval NSF		
<b>For models:</b>	OEB10.10, OEB10.20, OEB12.20, OEB20.10, OEB20.20, OEB6.10, OEB6.20, OES10.10, OES10.20, OES12.20, OES20.10, OES20.20, OES6.10, OES6.20, OGB10.10, OGB10.20, OGB12.20, OGB20.10, OGB20.20, OGB6.10, OGB6.20, OGS10.10, OGS10.20, OGS12.20, OGS20.10, OGS20.20, OGS6.10, OGS6.20		



<b>GEV No.</b>	520096	<b>Ref. No.</b>	7002070
<b>description</b>	shower hose connections 1/2" L 2000mm PVC operating p. 10bar burst p. 30bar t.max. 60°C approval NSF rotary with fabric		
<b>For models:</b>	HUD10.10, HUD12.20, HUD6.10, OD10.10, OD6.10, OEB20.10, OEB20.20, OES20.10, OES20.20, OGB20.10, OGB20.20, OGS20.10, OGS20.20, OS10.10, OS6.10, OSC10.10, OSC6.10, OSG12.20, OSP10.10, OSP6.10		



<b>GEV No.</b>	520097	<b>Ref. No.</b>	7002071
<b>description</b>	shower hose connections 1/2" L 2200mm PVC operating p. 10bar burst p. 30bar t.max. 60°C approval NSF rotary with fabric		
<b>For models:</b>	HUD20.10, OD10.20, OD12.20, OD20.10, OD20.20, OS10.20, OS12.20, OS20.10, OSC10.20, OSC12.20, OSC20.10, OSP10.20, OSP12.20, OSP20.10		



<b>GEV No.</b>	520098	<b>Ref. No.</b>	7002072
<b>description</b>	shower hose connections 1/2" L 2600mm PVC operating p. 10bar burst p. 30bar t.max. 60°C approval NSF rotary with fabric		
<b>For models:</b>	HUD20.20, OD20.20, OS20.20, OSC20.20, OSG20.20, OSP20.20		

## industrial hoses

### rubber hoses - Goldschlange®



<b>GEV No.</b>	530540	<b>Ref. No.</b>	7002032
<b>description</b>	pressure hose ID $\varnothing$ 13mm ED $\varnothing$ 21mm L 5m operating p. 30bar burst p. 90bar t.max. 100°C Qty 5m		

### Niplaflex hoses



<b>GEV No.</b>	530561	<b>Ref. No.</b>	7002033
<b>description</b>	pressure hose ID $\varnothing$ 10mm ED $\varnothing$ 17mm L 5m thickness 3.5mm operating p. 10bar burst p. 30bar t.max. 110°C		
<b>For models:</b>	OD10.10, OD10.20, OD12.20, OD20.20, OD6.10, OEB10.10, OEB10.20, OEB12.20, OEB20.10, OEB20.20, OEB6.10, OEB6.20, OES10.10, OES10.20, OES12.20, OES20.10, OES20.20, OES6.06, OES6.10, OES6.20, OGB10.10, OGB10.20, OGB12.20, OGB20.10, OGB20.20, OGB6.10, OGB6.20, OGS10.10, OGS10.20, OGS12.20, OGS20.10, OGS20.20, OGS6.10, OGS6.20, OSG10.10, OSG12.20, OSG20.20, OSG6.10		



## PVC hoses

### PVC braided hoses

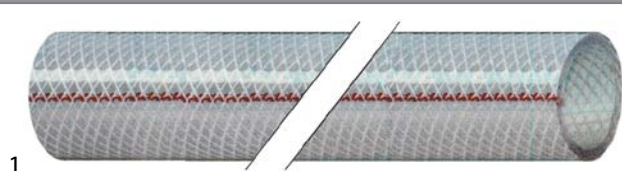

<b>GEV No.</b>	530565	<b>Ref. No.</b>	7002031
<b>description</b>	PVC braided hose ID ø 13mm ED ø 19mm L 10m operating p. 10bar burst p. 30bar t.max. 60°C Qty 10m		

## silicone hoses

### without fabric



<b>GEV No.</b>	530479	<b>Ref. No.</b>	7012300 7012300K 7030646
<b>description</b>	silicone hose ID ø 10mm ED ø 16mm L 0.45m thickness 2.5mm operating pressure without pressure burst pressure non defined t.max. 200°C transparent drain cable ties		
<b>For models:</b>	OEB10.10, OEB6.10, OES10.10, OES6.10, OGB10.10, OGB6.10, OGS10.10, OGS6.10		

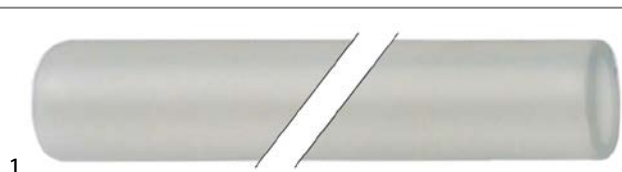

<b>GEV No.</b>	530823	<b>Ref. No.</b>	7002012
<b>description</b>	silicone hose ID ø 12mm ED ø 16mm L 1m thickness 2mm operating pressure without pressure burst pressure non defined t.max. 200°C transparent		

## formed hoses

### straight



<b>GEV No.</b>	694648	<b>Ref. No.</b>	7002015 7012305
<b>description</b>	hose ext. ø 20 D1 ø 15mm L 1080mm silicone for combi-steamer black		
<b>For models:</b>	OD10.20, OD12.20		



<b>GEV No.</b>	699241	<b>Ref. No.</b>	7012003
<b>description</b>	hose ID ø 45mm ext. ø 55 L 800mm for ventilation		
<b>For models:</b>	OEB10.20, OES10.20, OGB10.20, OGS10.20		

### form L



<b>GEV No.</b>	506274	<b>Ref. No.</b>	5064082
<b>description</b>	formed hose end piece A ext. ø 28mm end piece A int. ø 22mm AD2 ø 28mm ø end piece B 22mm L 555mm boiler silicone combi-steamer L-shape white		



<b>GEV No.</b>	699237	<b>Ref. No.</b>	6015100 6015100K 6030644
<b>description</b>	formed hose ext. ø 58 ID ø 48mm ED ø 37.5mm L 164mm for combi-steamer		
<b>For models:</b>	OEB10.10, OEB10.20, OEB12.20, OEB20.10, OEB20.20, OEB6.10, OEB6.20, OES10.10, OES10.20, OES12.20, OES20.10, OES20.20, OES6.10, OES6.20, OGB10.10, OGB10.20, OGB12.20, OGB20.10, OGB20.20, OGB6.10, OGB6.20, OGS10.10, OGS10.20, OGS12.20, OGS20.10, OGS20.20, OGS6.10, OGS6.20		



<b>GEV No.</b>	530082	<b>Ref. No.</b>	6006201
<b>description</b>	formed hose ID ø 48mm ED ø 54mm L 110mm black Qty 1 L-shape for combi-steamer		
<b>For models:</b>	OS10.10, OS10.20, OS12.20, OS20.10, OS20.20, OS6.10, OSC10.10, OSC10.20, OSC12.20, OSC20.10, OSC20.20, OSC6.10, OSP10.10, OSP10.20, OSP12.20, OSP20.10, OSP20.20, OSP6.10		



1

<b>GEV No.</b>	699367	<b>Ref. No.</b>	6064052
<b>description</b>	formed hose int. ø 1 47mm int. ø 2 30mm ED ø 54mm ext. ø 36 L 100mm for combi-steamer		



1

<b>GEV No.</b>	530897	<b>Ref. No.</b>	2364047
<b>description</b>	hose ID ø 10mm ED ø 15mm for boiler suitable for combi-steamer CONVOTHERM 4		

## fittings, hose and pipe connectors

### hose connectors

#### without screw connection



1

<b>GEV No.</b>	362001	<b>Ref. No.</b>	6005414 6064159
<b>description</b>	hose connector plastic hose ø 6-6mm		
<b>For models:</b>	OEB10.10, OEB10.20, OEB12.20, OEB20.10, OEB20.20, OEB6.10, OEB6.20, OES10.10, OES10.20, OES12.20, OES20.10, OES20.20, OES6.10, OES6.20, OGB10.10, OGB10.20, OGB12.20, OGB20.10, OGB20.20, OGB6.10, OGB6.20, OGS10.10, OGS10.20, OGS12.20, OGS20.10, OGS20.20, OGS6.10, OGS6.20		

### hose connectors

#### plastic



1

<b>GEV No.</b>	361690	<b>Ref. No.</b>	6005423
<b>description</b>	hose connector plastic straight thread 1/8" hose ø 6mm Qty 1 pcs		



1

<b>GEV No.</b>	361754	<b>Ref. No.</b>	6005416
<b>description</b>	hose connector plastic angled thread 1/8" hose ø 6mm Qty 1 pcs		
<b>For models:</b>	OEB10.10, OEB10.20, OEB12.20, OEB20.10, OEB20.20, OEB6.10, OEB6.20, OES10.10, OES10.20, OES12.20, OES20.10, OES20.20, OES6.10, OES6.20, OGB10.10, OGB10.20, OGB12.20, OGB20.10, OGB20.20, OGB6.10, OGB6.20, OGS10.10, OGS10.20, OGS12.20, OGS20.10, OGS20.20, OGS6.10, OGS6.20		



1

<b>GEV No.</b>	520059	<b>Ref. No.</b>	6006076
<b>description</b>	hose connector plastic angled thread 3/4" hose ø 13mm Qty 5 pcs		
<b>For models:</b>	OD10.10, OD10.20, OD12.20, OD20.10, OD20.20, OD6.10, OS10.10, OS10.20, OS12.20, OS20.10, OS20.20, OS6.10, OSC10.10, OSC10.20, OSC12.20, OSC20.10, OSC20.20, OSC6.10, OSP10.10, OSP10.20, OSP12.20, OSP20.10, OSP20.20, OSP6.10		

#### producer-specific



1

<b>GEV No.</b>	506242	<b>Ref. No.</b>	6014000
<b>description</b>	hose connector ID ø 12/6mm plastic L 195mm ø 16/10mm for combi-steamer		
<b>For models:</b>	OEB10.10, OEB10.20, OEB12.20, OEB20.10, OEB20.20, OEB6.10, OEB6.20, OES10.10, OES10.20, OES12.20, OES20.10, OES20.20, OES6.10, OES6.20, OGB10.10, OGB10.20, OGB12.20, OGB20.10, OGB20.20, OGB6.10, OGB6.20, OGS10.10, OGS10.20, OGS12.20, OGS20.10, OGS20.20, OGS6.10, OGS6.20		



1

<b>GEV No.</b>	501377	<b>Ref. No.</b>	6014001
<b>description</b>	hose connector ID ø 6mm L 96mm ø 10mm for combi-steamer		
<b>For models:</b>	OEB10.10, OEB10.20, OEB12.20, OEB20.10, OEB20.20, OEB6.10, OEB6.20, OES10.10, OES10.20, OES12.20, OES20.10, OES20.20, OES6.10, OES6.20, OGB10.10, OGB10.20, OGB12.20, OGB20.10, OGB20.20, OGB6.10, OGB6.20, OGS10.10, OGS10.20, OGS12.20, OGS20.10, OGS20.20, OGS6.10, OGS6.20		





## valves and tank inlets

### ball valves

#### universal

#### ball valves with lever handle



1

<b>GEV No.</b>	520283	<b>Ref. No.</b>	6006074
<b>description</b>	ball valve connection 1/2" IT - 1/2" ET DN15 total length 59mm with lever handle handle length 85mm		
<b>For models:</b>	OD10.10, OD10.20, OD12.20, OD20.10, OD20.20, OD6.10, OS10.10, OS10.20, OS12.20, OS20.10, OS20.20, OS6.10, OSC10.10, OSC10.20, OSC12.20, OSC20.10, OSC20.20, OSC6.10, OSG10.10, OSG12.20, OSG20.20, OSG6.10, OSP10.10, OSP10.20, OSP12.20, OSP20.10, OSP20.20, OSP6.10		
<b>accessories for</b>	520283		
	<b>GEV No.</b>	520168	<b>Ref. No.</b> —
	double nipple nickel-plated brass thread 1/2" - 1/2" Qty 1 pcs		



1

<b>GEV No.</b>	520992	<b>Ref. No.</b>	2230015
<b>description</b>	pressure reduction valve Norgren series R91 connection 1/8" nozzle ø 0.7mm setting range 0.1-2bar p max 10bar t.max. 50°C brass		
<b>spare parts for</b>	520992		
	<b>GEV No.</b>	541508	<b>Ref. No.</b> 6006140
	manometer ø 40mm pressure range 0-4bar connection thread 1/8"		
	<b>GEV No.</b>	541806	<b>Ref. No.</b> 5009061 5009063
	pressure control ø 38mm pressure range 0.2-3.0bar connection 1/8" 250V 10A GP600 pressure connection 1/8"		

## water cycle components



### pressure reduction valves

#### pressure reduction valves

#### producer-specific



1

<b>GEV No.</b>	520993	<b>Ref. No.</b>	2226366 2230014
<b>description</b>	pressure reduction valve Norgren series R91 connection 1/8" nozzle ø 0.6mm setting range 0.1-2bar p max 10bar t.max. 50°C brass		
<b>spare parts for</b>	520993		
	<b>GEV No.</b>	541508	<b>Ref. No.</b> 6006140
	manometer ø 40mm pressure range 0-4bar connection thread 1/8"		
	<b>GEV No.</b>	541806	<b>Ref. No.</b> 5009061 5009063
	pressure control ø 38mm pressure range 0.2-3.0bar connection 1/8" 250V 10A GP600 pressure connection 1/8"		



1

<b>GEV No.</b>	521052	<b>Ref. No.</b>	2230017
<b>description</b>	pressure reduction valve Norgren series R91 connection hose ø10mm default settingbar setting range 0.3-3.5bar p max 10bar t.max. 50°C with hose connection brass connection 10mm		





1

<b>GEV No.</b>	521006	<b>Ref. No.</b>	2217288
<b>description</b>	pressure reduction valve Norgren series R91 connection hose ø10mm default settingbar setting range 0.3-3.5bar p max 10bar t.max. 50°C with hose connection brass input pressure max. 10bar output pressure max. 3.4bar type R91W-2GK-NEN connection 10mm		
<b>For models:</b>	OEB10.10, OEB10.20, OEB12.20, OEB20.10, OEB20.20, OEB6.10, OEB6.20, OES10.10, OES10.20, OES12.20, OES20.10, OES20.20, OES6.06, OES6.10, OES6.20, OGB10.10, OGB10.20, OGB12.20, OGB20.10, OGB20.20, OGB6.10, OGB6.20, OGS10.10, OGS10.20, OGS12.20, OGS20.10, OGS20.20, OGS6.10, OGS6.20		

1

<b>GEV No.</b>	521047	<b>Ref. No.</b>	2226365 2230013
<b>description</b>	pressure reduction valve Norgren series R91 connection hose ø10mm default settingbar setting range 0.3-3.5bar p max 10bar t.max. 50°C with hose connector and nozzle brass input pressure max. 10bar output pressure max. 3.4bar type R91W-2GK-NEN with pressure switch and monometer connection 10mm		
<b>spare parts for</b>	521047		
	<b>GEV No.</b>	541508	<b>Ref. No.</b> 6006140
	manometer ø 40mm pressure range 0-4bar connection thread 1/8"		
	<b>GEV No.</b>	541806	<b>Ref. No.</b> 5009061 5009063
	pressure control ø 38mm pressure range 0.2-3.0bar connection 1/8" 250V 10A GP600 pressure connection 1/8"		



1

<b>GEV No.</b>	521286	<b>Ref. No.</b>	2618812
<b>description</b>	pressure reduction valve with solenoid valve		

### supply filters



1

<b>GEV No.</b>	520262	<b>Ref. No.</b>	6006061
<b>description</b>	supply filter thread 3/4" IT - 3/4" IT total length 70mm red brass DN20 mesh opening 0.4mm		
<b>For models:</b>	OD10.10, OD10.20, OD12.20, OD20.20, OD6.10, OSG10.10, OSG12.20, OSG20.20, OSG6.10		

### non-return valves



1

<b>GEV No.</b>	531322	<b>Ref. No.</b>	6056934
<b>description</b>	backflow preventer for boiler L 88mm connection 10.5/13.5 hose ø 3/4"mm for combi-steamer CONVOTHERM 4		

### ancillary products

#### PTFE tapes



1

<b>GEV No.</b>	890100	<b>Ref. No.</b>	7004052
<b>description</b>	PTFE tape reel L 12m W 12mm -200 up to +260°C approval DIN-DVGW, KTW temperature-resistant, elastic for fine thread thickness 0.1mm		
<b>description</b>	PTFE thread sealing tape for fine metal threads Application: All sanitary and heating circuits in hot and cold water areas. DVGW tested. DIN EN751-3. For fine thread DN < 10. Pressure: up to 20 bar. Temperature range: -60°C to +260°C		

### thread sealants



1

<b>GEV No.</b>	890097	<b>Ref. No.</b>	7004016
<b>description</b>	thread sealing LOCTITE 577 medium-strength bottle 50ml pipe thread sealing t.max. 150°C approval BAM and DVGW		
<b>description</b>	LOCTITE® 577™ - bottle 50ml It is designed for the locking and sealing of metal pipes and fittings as well as other cylindrical metal assemblies. The product provides an instant, low-pressure seal for metal pipes and fittings. It will not creep, shrink or block systems by shredding. Suitable for fast application at low temperatures. It has excellent chemical and thermal resistance and offers less migration of liquid product after application to the part.		



silicone

food-grade silicones



<b>GEV No.</b>	890106	<b>Ref. No.</b>	7004020
<b>description</b>	silicone TB40 transparent tube 90g -40 up to +160°C		
<b>description</b>	Tomabond - TB40 - tube 90g - transparent For flexible sealing in drinking water, food, water and industrial kitchen areas. Securely joins glass, metal, wood-based materials, ceramic and plastics with high adhesion (1.1 N/mm <sup>2</sup> ). Fungicide-, algicide- and solvent-free, ageing-resistant. Temperature-resistant from -40 °C to +160 °C Tested and approved by KTW / KSW.		
<b>For models:</b>	AR100, AR108, HUD10.10, HUD12.20, HUD20.10, HUD20.20, HUD6.10, OD10.10, OD10.20, OD12.20, OD20.10, OD20.20, OD6.10, OEB10.10, OEB10.20, OEB12.20, OEB20.10, OEB20.20, OEB6.10, OEB6.20, OES10.10, OES10.20, OES12.20, OES20.10, OES20.20, OES6.06, OES6.10, OES6.20, OGB10.10, OGB10.20, OGB12.20, OGB20.10, OGB20.20, OGB6.10, OGB6.20, OGS10.10, OGS10.20, OGS12.20, OGS20.10, OGS20.20, OGS6.10, OGS6.20, UG10.10, UG10.20, UG20.10, UG20.20, UG6.05, UG6.10		

clamps

hose clamps

DIN 3017 - W2



<b>GEV No.</b>	520112	<b>Ref. No.</b>	6006086
<b>description</b>	hose clamp ø 12-20mm width 9mm Qty 10 pcs DIN 3017		
<b>For models:</b>	OEB10.10, OEB10.20, OEB12.20, OEB20.10, OEB20.20, OEB6.10, OEB6.20, OES10.10, OES10.20, OES12.20, OES20.10, OES20.20, OES6.06, OES6.10, OES6.20, OGB10.10, OGB10.20, OGB12.20, OGB20.10, OGB20.20, OGB6.10, OGB6.20, OGS10.10, OGS10.20, OGS12.20, OGS20.10, OGS20.20, OGS6.10, OGS6.20		



<b>GEV No.</b>	520115	<b>Ref. No.</b>	6006087
<b>description</b>	hose clamp ø 25-40mm width 9mm Qty 10 pcs DIN 3017		
<b>For models:</b>	OEB10.10, OEB10.20, OEB12.20, OEB20.10, OEB20.20, OEB6.10, OEB6.20, OES10.10, OES10.20, OES12.20, OES20.10, OES20.20, OES6.10, OES6.20, OGB10.10, OGB10.20, OGB12.20, OGB20.10, OGB20.20, OGB6.10, OGB6.20, OGS10.10, OGS10.20, OGS12.20, OGS20.10, OGS20.20, OGS6.10, OGS6.20		

double wire clamps



<b>GEV No.</b>	505348	<b>Ref. No.</b>	8009058
<b>description</b>	wire clamp ø 9.8-10.4mm wire gauge ø 1.2mm zinc-coated steel Qty 100 pcs		
<b>For models:</b>	OEB10.10, OEB10.20, OEB12.20, OEB20.10, OEB20.20, OEB6.10, OEB6.20, OES10.10, OES10.20, OES12.20, OES20.10, OES20.20, OES6.10, OES6.20, OGB10.10, OGB10.20, OGB12.20, OGB20.10, OGB20.20, OGB6.10, OGB6.20, OGS10.10, OGS10.20, OGS12.20, OGS20.10, OGS20.20, OGS6.10, OGS6.20, OS12.20, OS20.10, OS20.10		

tools

hand tools

pullers



<b>GEV No.</b>	802191	<b>Ref. No.</b>	7015200
<b>description</b>	puller for fan wheel seat ø 28/34mm thread M16x1.5 WS 17		
<b>For models:</b>	OEB10.10, OEB10.20, OEB12.20, OEB20.10, OEB20.20, OEB6.10, OEB6.20, OES10.10, OES10.20, OES12.20, OES20.10, OES20.20, OES6.10, OES6.20, OGB10.10, OGB10.20, OGB12.20, OGB20.10, OGB20.20, OGB6.10, OGB6.20, OGS10.10, OGS10.20, OGS12.20, OGS20.10, OGS20.20, OGS6.10, OGS6.20		

fastening material

spacers



<b>GEV No.</b>	551407	<b>Ref. No.</b>	8056358
<b>description</b>	mounting set control PCB M4 suitable for CONVOTHERM 4		

screws

countersunk screws



<b>GEV No.</b>	699832	<b>Ref. No.</b>	8010001
<b>description</b>	countersunk screw thread M6 L 30mm SS DIN 7991/ISO 10642 Qty 1 pcs intake hexagonal		
<b>For models:</b>	OEB10.10, OEB10.20, OEB12.20, OEB20.10, OEB20.20, OEB6.10, OEB6.20, OES10.10, OES10.20, OES12.20, OES20.10, OES20.20, OES6.10, OES6.20, OGB10.10, OGB10.20, OGB12.20, OGB20.10, OGB20.20, OGB6.10, OGB6.20, OGS10.10, OGS10.20, OGS12.20, OGS20.10, OGS20.20, OGS6.10, OGS6.20		

flat-headed bolts



<b>GEV No.</b>	560067	<b>Ref. No.</b>	8001031
<b>description</b>	flat-headed bolt thread M5 thread L 10mm SS DIN 7985/ISO 7045 Qty 20 pcs intake Phillips head ø 8mm head thickness 2mm		
<b>For models:</b>	OEB12.20, OEB20.10, OEB20.20, OES12.20, OES20.10, OES20.20, OGB12.20, OGB20.10, OGB20.20, OGS12.20, OGS20.10, OGS20.20		

hexagonal screws



<b>GEV No.</b>	560083	<b>Ref. No.</b>	8003095
<b>description</b>	hexagonal screw thread M5 thread L 10mm SS WS 8 Qty 20 pcs DIN 933 / ISO 4017		
<b>For models:</b>	OGB10.10, OGB10.20, OGB12.20, OGB20.10, OGB20.20, OGB6.10, OGB6.20, OGS10.10, OGS10.20, OGS12.20, OGS20.10, OGS20.20, OGS6.10, OGS6.20		



<b>GEV No.</b>	510990	<b>Ref. No.</b>	8001074
<b>description</b>	hexagonal screw thread M8 thread L 20mm SS WS 13 Qty 1 pcs DIN 933 / ISO 4017		
<b>For models:</b>	OD10.10, OD10.20, OD12.20, OD20.10, OD20.20, OD6.10, OEB12.20, OEB20.10, OEB20.20, OEB6.10, OES12.20, OES20.10, OES20.20, OES6.10, OGB12.20, OGB20.10, OGB20.20, OGS12.20, OGS20.10, OGS20.20, OS10.10, OS10.20, OS12.20, OS20.10, OS20.20, OS6.10, OSC10.10, OSC10.20, OSC12.20, OSC20.10, OSC20.20, OSC6.10, OSP10.10, OSP10.20, OSP12.20, OSP20.10, OSP20.20, OSP6.10		

cylinder head bolts

DIN 912/ISO 4762



<b>GEV No.</b>	560316	<b>Ref. No.</b>	8013002
<b>description</b>	cylinder head bolt thread M8 thread L 25mm WS 6 SS Qty 20 pcs DIN 912/ISO 4762		
<b>For models:</b>	OEB12.20, OEB20.10, OEB20.20, OEB6.10, OES12.20, OES20.10, OES20.20, OES6.10, OGB12.20, OGB20.10, OGB20.20, OGS12.20, OGS20.10, OGS20.20		

side bolts



<b>GEV No.</b>	699834	<b>Ref. No.</b>	8003030
<b>description</b>	side bolts thread M5 L 15mm Qty 1 pcs intake hexagonal		
<b>For models:</b>	OD10.10, OD10.20, OD12.20, OD20.10, OD20.20, OD6.10, OEB10.10, OEB10.20, OEB12.20, OEB20.10, OEB20.20, OEB6.10, OEB6.20, OES10.10, OES10.20, OES12.20, OES20.10, OES20.20, OES6.10, OES6.20, OGB10.10, OGB10.20, OGB12.20, OGB20.10, OGB20.20, OGB6.10, OGB6.20, OGS10.10, OGS10.20, OGS12.20, OGS20.10, OGS20.20, OGS6.10, OGS6.20, OS10.10, OS10.20, OS12.20, OS20.10, OS20.20, OS6.10, OSC10.10, OSC10.20, OSC12.20, OSC20.10, OSC20.20, OSC6.10, OSP10.10, OSP10.20, OSP12.20, OSP20.10...(Other models you can see in the webshop)		



<b>GEV No.</b>	699833	<b>Ref. No.</b>	8015000
<b>description</b>	side bolts thread M6 L 8mm DIN 916/ISO 4029 intake hexagonal		
<b>For models:</b>	OEB10.10, OEB10.20, OEB12.20, OEB20.10, OEB20.20, OEB6.10, OEB6.20, OES10.10, OES10.20, OES12.20, OES20.10, OES20.20, OES6.10, OES6.20, OGB10.10, OGB10.20, OGB12.20, OGB20.10, OGB20.20, OGB6.10, OGB6.20, OGS10.10, OGS10.20, OGS12.20, OGS20.10, OGS20.20, OGS6.10, OGS6.20		

nuts

hexagonal nuts

DIN 934 / ISO 4032/8673



<b>GEV No.</b>	560129	<b>Ref. No.</b>	8017010
<b>description</b>	hexagonal nut thread M5 H 4mm WS 8 SS DIN/ISO DIN 934 / ISO 4032/8673 Qty 1 pcs		
<b>For models:</b>	OEB10.10, OEB10.20, OEB12.20, OEB20.10, OEB20.20, OEB6.10, OEB6.20, OES10.10, OES10.20, OES12.20, OES20.10, OES20.20, OES6.10, OES6.20, OGB10.10, OGB10.20, OGB12.20, OGB20.10, OGB20.20, OGB6.10, OGB6.20, OGS10.10, OGS10.20, OGS12.20, OGS20.10, OGS20.20, OGS6.10, OGS6.20		

fasteners

cable ties



<b>GEV No.</b>	550254	<b>Ref. No.</b>	4007087
<b>description</b>	cable tie W 3.6mm L 140mm white Qty 100 pcs nylon		
<b>For models:</b>	HUD10.10, HUD12.20, HUD20.10, HUD20.20, HUD6.10, OEB10.10, OEB10.20, OEB12.20, OEB20.10, OEB20.20, OEB6.10, OEB6.20, OES10.10, OES10.20, OES12.20, OES20.10, OES20.20, OES6.10, OES6.20, OGB10.10, OGB10.20, OGB12.20, OGB20.10, OGB20.20, OGB6.10, OGB6.20, OGS10.10, OGS10.20, OGS12.20, OGS20.10, OGS20.20, OGS6.10, OGS6.20		





clamps			
hose clamps			
DIN 3017 - W2			
			
1			
<b>GEV No.</b>	520112	<b>Ref. No.</b>	6006086
<b>description</b>	hose clamp ø 12-20mm width 9mm Qty 10 pcs DIN 3017		
<b>For models:</b>	OEB10.10, OEB10.20, OEB12.20, OEB20.10, OEB20.20, OEB6.10, OEB6.20, OES10.10, OES10.20, OES12.20, OES20.10, OES20.20, OES6.06, OES6.10, OES6.20, OGB10.10, OGB10.20, OGB12.20, OGB20.10, OGB20.20, OGB6.10, OGB6.20, OGS10.10, OGS10.20, OGS12.20, OGS20.10, OGS20.20, OGS6.10, OGS6.20		

			
1			
<b>GEV No.</b>	520115	<b>Ref. No.</b>	6006087
<b>description</b>	hose clamp ø 25-40mm width 9mm Qty 10 pcs DIN 3017		
<b>For models:</b>	OEB10.10, OEB10.20, OEB12.20, OEB20.10, OEB20.20, OEB6.10, OEB6.20, OES10.10, OES10.20, OES12.20, OES20.10, OES20.20, OES6.10, OES6.20, OGB10.10, OGB10.20, OGB12.20, OGB20.10, OGB20.20, OGB6.10, OGB6.20, OGS10.10, OGS10.20, OGS12.20, OGS20.10, OGS20.20, OGS6.10, OGS6.20		

double wire clamps			
			
1			
<b>GEV No.</b>	505348	<b>Ref. No.</b>	8009058
<b>description</b>	wire clamp ø 9.8-10.4mm wire gauge ø 1.2mm zinc-coated steel Qty 100 pcs		
<b>For models:</b>	OEB10.10, OEB10.20, OEB12.20, OEB20.10, OEB20.20, OEB6.10, OEB6.20, OES10.10, OES10.20, OES12.20, OES20.10, OES20.20, OES6.10, OES6.20, OGB10.10, OGB10.20, OGB12.20, OGB20.10, OGB20.20, OGB6.10, OGB6.20, OGS10.10, OGS10.20, OGS12.20, OGS20.10, OGS20.20, OGS6.10, OGS6.20, OS12.20, OS20.10, OS20.20		

consumables

sprays			
			
1			
<b>GEV No.</b>	890293	<b>Ref. No.</b>	7014013
<b>description</b>	penetrating oil Bavariapool korro pro universal can 200ml t.max. 50°C		

sealants and adhesives			
food-grade silicones			
			
1			
<b>GEV No.</b>	890106	<b>Ref. No.</b>	7004020
<b>description</b>	silicone TB40 transparent tube 90g -40 up to +160°C		
<b>description</b>	<p>Tomabond - TB40 - tube 90g - transparent</p> <p>For flexible sealing in drinking water, food, water and industrial kitchen areas. Securely joins glass, metal, wood-based materials, ceramic and plastics with high adhesion (1.1 N/mm<sup>2</sup>). Fungicide-, algicide- and solvent-free, ageing-resistant. Temperature-resistant from -40 °C to +160 °C. Tested and approved by KTW / KSW.</p>		
<b>For models:</b>	AR100, AR108, HUD10.10, HUD12.20, HUD20.10, HUD20.20, HUD6.10, OD10.10, OD10.20, OD12.20, OD20.10, OD20.20, OD6.10, OEB10.10, OEB10.20, OEB12.20, OEB20.10, OEB20.20, OEB6.10, OEB6.20, OES10.10, OES10.20, OES12.20, OES20.10, OES20.20, OES6.06, OES6.10, OES6.20, OGB10.10, OGB10.20, OGB12.20, OGB20.10, OGB20.20, OGB6.10, OGB6.20, OGS10.10, OGS10.20, OGS12.20, OGS20.10, OGS20.20, OGS6.10, OGS6.20, UG10.10, UG10.20, UG20.10, UG20.20, UG6.05, UG6.10		

screw fixings			
			
1			
<b>GEV No.</b>	890063	<b>Ref. No.</b>	7004008 7004012
<b>description</b>	screw fixing LOCTITE 270 bottle 10ml high-strength		
<b>description</b>	<p>LOCTITE® 270™ - bottle 10ml</p> <p>It is designed for the permanent locking and sealing of threaded fasteners. The product cures when confined in the absence of air between close fitting metal surfaces and prevents loosening and leakage from shock and vibration. LOCTITE® 270™ is particularly suited for heavy duty applications such as studs into motor housings, nuts onto studs in pump housings and other fasteners where high strength is required. LOCTITE® 270™ provides robust curing performance. It not only works on active metals (e.g. brass, copper) but also on passive substrates such as stainless steel and plated surfaces. The product offers high temperature performance and oil tolerance. It tolerates minor surface contaminations from various oils, such as cutting, lubrication, anti-corrosion and protection fluids.</p>		
<b>For models:</b>	OD10.10, OD10.20, OD12.20, OD20.10, OD20.20, OD6.10, OEB10.10, OEB10.20, OEB12.20, OEB20.10, OEB20.20, OEB6.10, OEB6.20, OES10.10, OES10.20, OES12.20, OES20.10, OES20.20, OES6.06, OES6.10, OES6.20, OGB10.10, OGB10.20, OGB12.20, OGB20.10, OGB20.20, OGB6.10, OGB6.20, OGS10.10, OGS10.20, OGS12.20, OGS20.10, OGS20.20, OGS6.10, OGS6.20, OSG10.10, OSG12.20, OSG6.10		

thread sealants

			
1			
<b>GEV No.</b>	890097	<b>Ref. No.</b>	7004016
<b>description</b>	thread sealing LOCTITE 577 medium-strength bottle 50ml pipe thread sealing t.max. 150°C approval BAM and DVGW		
<b>description</b>	<p>LOCTITE® 577™ - bottle 50ml</p> <p>It is designed for the locking and sealing of metal pipes and fittings as well as other cylindrical metal assemblies. The product provides an instant, low-pressure seal for metal pipes and fittings. It will not creep, shrink or block systems by shredding. Suitable for fast application at low temperatures. It has excellent chemical and thermal resistance and offers less migration of liquid product after application to the part.</p>		

PTFE tapes

			
1			
<b>GEV No.</b>	890100	<b>Ref. No.</b>	7004052
<b>description</b>	PTFE tape reel L 12m W 12mm -200 up to +260°C approval DIN-DVGW, KTW temperature-resistant, elastic for fine thread thickness 0.1mm		
<b>description</b>	<p>PTFE thread sealing tape for fine metal threads</p> <p>Application: All sanitary and heating circuits in hot and cold water areas. DVGW tested. DIN EN751-3. For fine thread DN &lt; 10.</p> <p>Pressure: up to 20 bar.</p> <p>Temperature range: -60°C to +260°C</p>		

lubricants

graphite paste

			
1			
<b>GEV No.</b>	890006	<b>Ref. No.</b>	7014005
<b>description</b>	graphite paste FERMIT NIVO can 500g		
<b>description</b>	<p>Fermit NIVO - can 500g</p> <p>Highly refractory sealing paste for threaded and flanged joints Prevents the sticking of gaskets, bolts, screws etc. which are exposed to intense heat. In the case of flange gaskets and surface seals, coat both sides with the paste. In the case of use as sealants for threads (DIN 2999) at over 160 degrees C, the use of aluminium hemp with Nivo Graphite Paste is recommended as normal hemp becomes scaly at these temperatures and then leaks can occur.</p> <p>Temperature range: 0°C to + 300°C</p>		
<b>For models:</b>	OGB10.10, OGB10.20, OGB12.20, OGB20.10, OGB20.20, OGB6.10, OGB6.20, OGS10.10, OGS10.20, OGS12.20, OGS20.10, OGS20.20, OGS6.10, OGS6.20		

cleaning agents

combisteamer detergents/descalers

*Notice: Articles labelled 'DANGEROUS GOODS' are delivered by road through a forwarder for reasons of safety and are charged separately!*

			
1			
<b>GEV No.</b>	802066 <sup>1</sup>	<b>Ref. No.</b>	3007028
<b>description</b>	detergent for combi-steamer CONVOTHERM CONVOCare nozzle detergent 1l concentrate P2 P3 concentrate mixing ratio 1:29 1l		
<b>description</b>	<p>CONVOTHERM ConvoCare K - bottle 1 litre</p> <p>For preventing and dissolving limescale deposits. Particularly suitable in regions with very hard water. Through the use of liquid detergents no residue remains in the cooking chamber. The environment is also considered - all products are compliant with the ISO standard and are biologically degradable.</p> <ul style="list-style-type: none"> <li>- 1l concentrate</li> <li>- rinse aid for CONVOClean system</li> <li>- must be mixed with water in a ratio of 1:29</li> </ul>		
<b>For models:</b>	OEB6.10, OES6.10, OS12.20, OS20.10, OS20.20		

<sup>1</sup>DANGEROUS GOODS

			
1			
<b>GEV No.</b>	890032 <sup>1</sup>	<b>Ref. No.</b>	3007014 3007017
<b>description</b>	detergent for combi-steamer CONVOTHERM Convoclean forte 10L		
<b>description</b>	<p>CONVOTHERM Convoclean forte - cleaner - canister 10l</p> <p>All Convotherm detergents and care products are optimally designed for use with the Convotherm combi steamers. This prevents residues from remaining in the cooking chamber when using liquid cleaners. The Convotherm cleaners comply with the ISO standard, are environmentally friendly, biodegradable and halal and kosher certified. The ConvoClean forte is a cooking chamber cleaner with a strong cleaning power. The ConvoClean forte is suitable for all devices with automatic and fully automatic cleaning.</p>		
<b>For models:</b>	OS12.20, OS20.10, OS20.20		

<sup>1</sup>DANGEROUS GOODS



descalers



1			
<b>GEV No.</b>	802196	<b>Ref. No.</b>	3007023
<b>description</b>	descaler ConvCal forte 10l		



1			
<b>GEV No.</b>	802195	<b>Ref. No.</b>	3007018
<b>description</b>	descaler ConvCal for combi-steamer 10l		

fuses

fine fuses



1			
<b>GEV No.</b>	358600	<b>Ref. No.</b>	4005064
<b>description</b>	fine fuse size $\phi$ 5x20mm 1A slow-acting rated 250V Qty 10 pcs		
<b>For models:</b>	HUD10.10, HUD12.20, HUD20.10, HUD20.20, HUD6.10, OD10.10, OD10.20, OD12.20, OD20.10, OD20.20, OD6.10, OEB10.10, OEB10.20, OEB12.20, OEB20.10, OEB20.20, OEB6.10, OEB6.20, OES10.10, OES10.20, OES12.20, OES20.10, OES20.20, OES6.06, OES6.10, OES6.20, OGB10.20, OGB12.20, OGB20.10, OGB20.20, OGS10.10, OGS10.20, OGS12.20, OGS20.10, OGS20.20, OGS6.10, OGS6.20, OSC10.10, OSC10.20, OSC12.20, OSC20.10, OSC20.20, OSC6.10, OSG10.10, OSG12.20, OSG20.20, OSG6.10, OSP10.10, OSP10.20, OSP12.20... (Other models you can see in the webshop)		

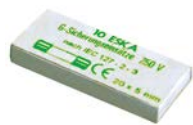

1			
<b>GEV No.</b>	358603	<b>Ref. No.</b>	4005066 4056944
<b>description</b>	fine fuse size $\phi$ 5x20mm 2A slow-acting rated 250V Qty 10 pcs		
<b>For models:</b>	AR108, AR12, AR18, AR28, AR40, AR54, AR72, OD10.10, OD10.20, OD12.20, OD20.10, OD20.20, OD6.10, OEB10.10, OEB10.20, OEB12.20, OEB20.10, OEB20.20, OEB6.10, OEB6.20, OES10.10, OES10.20, OES12.20, OES20.10, OES20.20, OES6.10, OES6.20, OGB10.10, OGB10.20, OGB12.20, OGB20.10, OGB20.20, OGB6.10, OGB6.20, OGS10.10, OGS10.20, OGS12.20, OGS20.10, OGS20.20, OGS6.10, OGS6.20, OSC10.10, OSC10.20, OSC12.20, OSC20.10, OSC20.20, OSC6.10, OSG10.10, OSG10.20, OSG12.20, OSG20.20... (Other models you can see in the webshop)		



1			
<b>GEV No.</b>	358605	<b>Ref. No.</b>	4056945
<b>description</b>	fine fuse size $\phi$ 5x20mm 3.15A slow-acting rated 250V Qty 10 pcs		



1			
<b>GEV No.</b>	358607	<b>Ref. No.</b>	4005068
<b>description</b>	fine fuse size $\phi$ 5x20mm 6.3A slow-acting rated 250V Qty 10 pcs		
<b>For models:</b>	HUD10.10, HUD12.20, HUD20.10, HUD20.20, HUD6.10, OD10.10, OD10.20, OD12.20, OD20.10, OD20.20, OD6.10, OSG10.10, OSG12.20, OSG20.20, OSG6.10		

$\phi$ 6.3x32mm 500V



1			
<b>GEV No.</b>	358751	<b>Ref. No.</b>	4005069
<b>description</b>	fine fuse size $\phi$ 6.3x32mm 6.3A fast-acting rated 500V Qty 10 pcs		
<b>For models:</b>	OD10.10, OD10.20, OD12.20, OD6.10, OEB10.10, OEB6.10, OEB6.20, OES10.10, OES6.10, OES6.20, OGB10.10, OGB20.10, OGB6.10, OGB6.20, OGS10.10, OGS20.10, OGS6.10, OGS6.20, OSC10.10, OSC10.20, OSC12.20, OSC20.10, OSC6.10, OSP10.10, OSP10.20, OSP12.20, OSP6.10		

screw locks

D0-system (NEOZED)



1			
<b>GEV No.</b>	358073	<b>Ref. No.</b>	4005053
<b>description</b>	fuse size D01 10A rated 250/400V E14 $\phi$ 11mm L 36mm Qty 10 pcs		





1			
<b>GEV No.</b>	358043	<b>Ref. No.</b>	4005054
<b>description</b>	fuse size D01 16A rated 250/400V E14 $\phi$ 11mm L 36mm Qty 10 pcs		
<b>For models:</b>	HUD12.20, HUD20.10		





1			
<b>GEV No.</b>	358070	<b>Ref. No.</b>	4005050
<b>description</b>	fuse size D01 2A rated 250/400V E14 $\phi$ 11mm L 36mm Qty 10 pcs		
<b>For models:</b>	AR100, AR108, AR16, AR18, AR28, AR30, AR40, AR50, AR54, AR72, UG10.10, UG10.20, UG20.10, UG20.20, UG6.05, UG6.10		

			
1			
<b>GEV No.</b>	358071	<b>Ref. No.</b>	4005051
<b>description</b>	fuse size D01 4A rated 250/400V E14 ø 11mm L 36mm Qty 10 pcs		
<b>For models:</b>	AR100, AR108, AR30, AR40, AR50, AR54, AR72, OES12.20, UG10.10, UG20.10, UG6.10		

			
1			
<b>GEV No.</b>	358072	<b>Ref. No.</b>	4005052
<b>description</b>	fuse size D01 6A rated 250/400V E14 ø 11mm L 36mm Qty 10 pcs		
<b>For models:</b>	OEB20.20, UG20.20		

			
1			
<b>GEV No.</b>	358048	<b>Ref. No.</b>	4005058
<b>description</b>	fuse size D02 20A rated 250/400V E18 ø 15mm L 36mm Qty 10 pcs		
<b>For models:</b>	AR108, HUD20.20, OD10.20, OD12.20, OD20.10, OD20.20, OEB10.20, OEB12.20, OEB20.10		

			
1			
<b>GEV No.</b>	358044	<b>Ref. No.</b>	4005046 4005055
<b>description</b>	fuse size D02 25A rated 250/400V E18 ø 15mm L 36mm Qty 10 pcs		
<b>For models:</b>	AR100, AR108, HUD12.20, HUD20.10, HUD20.20, OD10.20, OD12.20, OD20.10, OD20.20, OEB10.20, OEB12.20, OEB20.20, OES10.20, OES12.20, OES20.20, UG10.20		

			
1			
<b>GEV No.</b>	358045	<b>Ref. No.</b>	2212003 4005056
<b>description</b>	fuse size D02 35A rated 250/400V E18 ø 15mm L 36mm Qty 10 pcs		
<b>For models:</b>	HUD20.10, OD20.20, OEB10.20, OEB12.20, OEB20.10, OES20.10, UG20.10, UG20.20		

			
1			
<b>GEV No.</b>	358046	<b>Ref. No.</b>	4005057
<b>description</b>	fuse size D02 50A rated 250/400V E18 ø 15mm L 36mm Qty 10 pcs		
<b>For models:</b>	OD10.20, OD12.20, OD20.10, OD20.20, OEB10.20, OEB12.20, OEB20.20, OES10.20, OES12.20, OES20.20		

			
1			
<b>GEV No.</b>	358047	<b>Ref. No.</b>	4005059
<b>description</b>	fuse size D02 63A rated 250/400V E18 ø 15mm L 36mm Qty 10 pcs		
<b>For models:</b>	OEB20.10, OES20.10		

gauge pieces (NEOZED)			
			
1			
<b>GEV No.</b>	358055	<b>Ref. No.</b>	4005013
<b>description</b>	gauge piece size D01 suitable for 10A		

			
1			
<b>GEV No.</b>	358052	<b>Ref. No.</b>	4005010
<b>description</b>	gauge piece size D01 suitable for 2A		
<b>For models:</b>	AR100, AR108, AR16, AR18, AR28, AR30, AR40, AR50, AR54, AR72, UG10.10, UG10.20, UG20.10, UG20.20, UG6.05, UG6.10		

			
1			
<b>GEV No.</b>	358053	<b>Ref. No.</b>	4005011
<b>description</b>	gauge piece size D01 suitable for 4A		
<b>For models:</b>	AR100, AR108, AR30, AR40, AR50, AR54, AR72, OES12.20, OES20.20, UG10.10, UG20.10, UG6.10		

			
1			
<b>GEV No.</b>	358054	<b>Ref. No.</b>	4005012
<b>description</b>	gauge piece size D01 suitable for 6A		
<b>For models:</b>	UG20.20		

			
1			
<b>GEV No.</b>	358064	<b>Ref. No.</b>	4005021
<b>description</b>	gauge piece size D02 suitable for 16A		
<b>For models:</b>	OD10.20, OD12.20, OD20.10, OSP10.20, OSP12.20		





			
1			
<b>GEV No.</b>	358065	<b>Ref. No.</b>	4005014
<b>description</b>	gauge piece size D02 suitable for 20A		
<b>For models:</b>	AR108, HUD12.20, HUD20.10, HUD20.20, OD10.20, OD12.20, OD20.10, OD20.20, OEB10.20, OEB12.20, OEB20.10, OSC10.20, OSC12.20, OSC20.10, OSC20.20, OSP10.20, OSP12.20, OSP20.10, OSP20.20, OSP6.10		

			
1			
<b>GEV No.</b>	358066	<b>Ref. No.</b>	4005015
<b>description</b>	gauge piece size D02 suitable for 25A		
<b>For models:</b>	AR100, AR108, OD10.20, OD12.20, OD20.10, OD20.20, OEB10.20, OEB12.20, OEB20.20, OES10.20, OES12.20, OES20.20, OSC10.20, OSC12.20, OSC20.10, OSC20.20, OSP10.20, OSP12.20, OSP20.10, OSP20.20, UG10.20		

			
1			
<b>GEV No.</b>	358067	<b>Ref. No.</b>	4005016
<b>description</b>	gauge piece size D02 suitable for 35A		
<b>For models:</b>	HUD20.10, OD20.20, OEB10.20, OEB12.20, OEB20.10, OES20.10, OSC20.20, OSP20.20, UG20.10, UG20.20		

			
1			
<b>GEV No.</b>	358068	<b>Ref. No.</b>	4005017
<b>description</b>	gauge piece size D02 suitable for 50A		
<b>For models:</b>	OD10.20, OD12.20, OD20.10, OD20.20, OEB10.20, OEB12.20, OEB20.20, OES10.20, OES12.20, OES20.20, OSC10.20, OSC12.20, OSC20.10, OSC20.20, OSP10.20, OSP12.20, OSP20.10, OSP20.20		



<b>A</b>		<b>G</b>	
alarm devices	17	gas burners	52
appliance hose reels	85	gas control valves	48
axial fans	31	gas nozzles	53
<b>B</b>		gaskets for control panels	80
ball valves	89	gaskets for heated units	74
bi-metal thermostats	8, 8	gaskets for tray rack trolleys	79
<b>C</b>		GEV	2
cable ties	92	graphite paste	94
cables	41	<b>H</b>	
cam switches	10	halogen lamp	13
castors and bumper angles	74	hand tools	91
clamps	91, 93	handle latches	72
cleaning agents	94	heating elements	2
cleaning guns	85	heating elements for convection	4
combiteamer detergents/descalers	94	hexagonal nuts	92
condensators & interference suppression filters	37	hexagonal screws	92
connection cables	41	hose clamps	91, 93
consumables	93	hose connectors	88, 88
contactors	17	hose reels	85
control equipment	12	hoses	85, 86
control thermostats	8	hot air fans	35
countersunk screws	91	hot air motors	32
cylinder head bolts	92	<b>I</b>	
<b>D</b>		ignition boxes	49
descalers	95	ignition cables	52
door seals	75	immersion heating elements	2
double wire clamps	91, 93	indicator lights	12
drain pumps	36	indicator lights (complete)	13
<b>E</b>		industrial hoses	86
edgemount latches	71	<b>L</b>	
electric accessories	41	lamps	12
electrodes	31	light bulbs	13
<b>F</b>		lubricants	94
fans	31	<b>M</b>	
fasteners	92	magnetic switches	11
fastening material	91	mechanical timers	17
filters	37	motors	36
fine fuses	95	<b>N</b>	
flat-headed bolts	92	Niplaflex hoses	86
flow sensors	31	non-return valves	90
food-grade silicones	91, 93	nuts	92
forced air burners	52	<b>O</b>	
formed hoses	87	O-rings	80
fuses	38, 95	oven lamps	13
		overlying hinges	72

**P**

piano hinges	72
pilot burners	50
plastic/rubber hoses	86
pre-rinse hoses	86
pressure reduction valves	89, 89
pressure switches	30
probes	21
PTFE tapes	53, 90, 94
pullers	91
pumps	36
push button latches	71
PVC braided hoses	86
PVC hoses	87
PVC supply hoses	86

**R**

radial fans	35
relays	20
rubber hoses - Goldschlange®	86

**S**

safety thermostats	8
screw fixings	93
screw locks	95
screws	91
sealants and adhesives	93
sealing washers	81
shaft gaskets	82
side bolts	92
silicone	91, 93
silicone hoses	87
solenoid valves	27
solid state relays	20
spray guns	84
spray guns with external thread	84
sprays	93
supply filters	90, 90
supply hoses	86
switches and momentary switches	10

**T**

terminals	41
thermocouples	52
thermostats	8
thread sealants	53, 90, 94
timers	17
tools	91
transformers	21
turning lever locks	67

**V**

valves and tank inlets	89
vibration pumps	36

**W**

wash and rinse pumps	36
water cycle components	89
window seals	74