



## Ricambios para Hornos Combinados de



Repuestos adaptables a

# HOUNÖ

# 2017

Encuentre nuestra gama siempre actualizada en la tienda online de GEV



## resistencias

## resistencias de inmersión

## con brida de presión 50 x 26mm

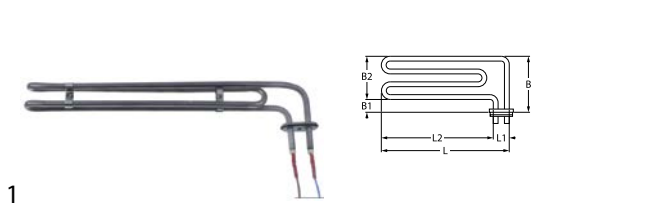

<b>código</b>	419129	<b>referencia</b>	072406 20720278
---------------	--------	-------------------	--------------------

**descripción** resistencia 1300W 230V espirales 1 brida 50x26mm L 380mm An 60mm L1 31mm L2 345mm B1 20mm B2 33mm brida de presión longitud del cable 1500mm tubo ø 8.5mm herrajes

**accesorios para** 419129



<b>código</b>	520562	<b>referencia</b>	070101
---------------	--------	-------------------	--------

junta L 44mm An 21mm D1 ø 9mm D2 ø 9mm agujero ø 5.5mm espesor 4mm para resistencia para HOUNO

## con brida de expansión 70 x 18mm



<b>código</b>	419131	<b>referencia</b>	031917
---------------	--------	-------------------	--------

**descripción** resistencia 5000W 235V espirales 2 brida 70x18mm L 325mm An 63mm con sensor K 1100 empalme conector Faston 6,3mm tubo ø 8.5mm brida de expansión longitud de empalme 35mm



<b>código</b>	419165	<b>referencia</b>	072415
---------------	--------	-------------------	--------

**descripción** resistencia 5000W 235V espirales 2 brida 70x18mm L 325mm An 63mm empalme conector Faston 6,3mm tubo ø 8.5mm brida de expansión

## otros



<b>código</b>	511653	<b>referencia</b>	20600007
---------------	--------	-------------------	----------

**descripción** junta silicona L 82mm An 82mm espesor 3mm



<b>código</b>	420371	<b>referencia</b>	20700045 20700047 30720643
---------------	--------	-------------------	----------------------------------

**descripción** resistencia 7500W 240-415V espirales 3 L 200mm An 40mm H 65mm casquillo portasondas 2 ø casquillo portasondas 5.6mm longitud casquillo portasondas 200mm casquillo termostato arriba dist. del agujero 600mm agujero ø 6.6mm longitud del cable 590mm empalme cable resistencia de inmersión anchura brida 820mm longitud brida 820mm inox inclusive

**accesorios para** 420371

<b>código</b>	511653	<b>referencia</b>	20600007
---------------	--------	-------------------	----------

junta silicona L 82mm An 82mm espesor 3mm



<b>código</b>	420582	<b>referencia</b>	30720642
---------------	--------	-------------------	----------

**descripción** resistencia 9000W 208V espirales 3 L 205mm An 40mm H 74mm casquillo portasondas 2 ø casquillo portasondas 6mm longitud casquillo portasondas 185mm casquillo termostato descentrado, ceñido tubo ø 6.5mm dist. del agujero 64mm agujero ø 6mm longitud del cable 600mm empalme cable brida 4 orificios generador de vapor anchura brida 82mm longitud brida 82mm con junta



<b>código</b>	420575	<b>referencia</b>	30720641
---------------	--------	-------------------	----------

**descripción** resistencia 9000W 240/415V espirales 3 L 203mm An 38mm H 66mm casquillo portasondas 2 ø casquillo portasondas 6mm longitud casquillo portasondas 185mm casquillo termostato descentrado, ceñido tubo ø 6.5mm dist. del agujero 64mm agujero ø 6.5mm longitud del cable 620mm brida generador de vapor anchura brida 82mm longitud brida 82mm



<b>código</b>	420148	<b>referencia</b>	20700028
---------------	--------	-------------------	----------

**descripción** resistencia 9000W 240V espirales 3 L 202mm An 38mm H 66mm casquillo portasondas 2 ø casquillo portasondas 5.4mm longitud casquillo portasondas 180mm casquillo termostato descentrado, ceñido tubo ø 6.3mm dist. del agujero 60/64mm agujero ø 6.5mm longitud del cable 590mm empalme cable brida resistencia de inmersión anchura brida 82mm longitud brida 82mm

**accesorios para** 420148

<b>código</b>	511653	<b>referencia</b>	20600007
---------------	--------	-------------------	----------

junta silicona L 82mm An 82mm espesor 3mm

resistencias circulación de aire



1

<b>código</b>	417767	<b>referencia</b>	20700062
<b>descripción</b>	resistencia 12000W 240V espirales 3 int.ø 390mm ø ext. 400mm L 435mm H 120mm B1 140mm H1 35mm H2 80mm longitud brida 155mm anchura brida 25mm dist. del agujero 23mm empalme conector Faston 6,3mm longitud de empalme 80mm tubo ø 6.5mm resistencia seca agujero ø 6.5mm pos. de montaje interior brida rectangular		



1

<b>código</b>	417762	<b>referencia</b>	30700076
<b>descripción</b>	resistencia 6900-9200W 208-240V espirales 2 int.ø 225mm ø ext. 270mm L 295mm H 68mm L1 15mm B1 63mm H1 8mm H2 57mm longitud brida 142mm anchura brida 25mm empalme conector Faston 6,3mm tubo ø 8.5mm resistencia circulación de aire rosca de sujeción M5 agujero ø 5mm brida rectangular con pasador roscado		



1

<b>código</b>	420419	<b>referencia</b>	20700009 20700059
<b>descripción</b>	resistencia 9000W 240V espirales 3 int.ø 395mm ø ext. 405mm L 422mm H 120mm B1 148mm H1 50mm H2 87mm longitud brida 156mm anchura brida 25mm dist. del agujero 25mm empalme F6,3 agujero ø 6.1mm		



1

<b>código</b>	417768	<b>referencia</b>	20700060
<b>descripción</b>	resistencia 9000W 240V espirales 3 int.ø 460mm ø ext. 470mm L 520mm H 135mm B1 145mm H1 50mm H2 85mm longitud brida 155mm anchura brida 25mm dist. del agujero 23mm empalme conector Faston 6,3mm longitud de empalme 80mm tubo ø 6.5mm resistencia seca agujero ø 6.5mm pos. de montaje interior brida rectangular		



1

<b>código</b>	417766	<b>referencia</b>	20700061
<b>descripción</b>	resistencia 9000W 240V espirales 3 int.ø 540mm ø ext. 530mm L 580mm H 120mm B1 140mm H1 30mm H2 90mm longitud brida 155mm anchura brida 25mm dist. del agujero 23mm empalme conector Faston 6,3mm longitud de empalme 80mm tubo ø 6.5mm resistencia seca agujero ø 6.5mm pos. de montaje interior brida rectangular		



1

<b>código</b>	420174	<b>referencia</b>	072403
<b>descripción</b>	resistencia 1650W 230V espirales 1 L 285mm An 100mm L1 32mm L2 250mm B2 83mm longitud brida 50mm anchura brida 26mm tubo ø 8mm longitud del cable 1500mm B1 23mm resistencia circulación de aire		



1

<b>código</b>	420175	<b>referencia</b>	072404
<b>descripción</b>	resistencia 1650W 230V espirales 1 L 565mm An 55mm L1 32mm L2 530mm B2 30mm longitud brida 50mm anchura brida 26mm tubo ø 8mm longitud del cable 1500mm B1 23mm resistencia circulación de aire		



## accesorios

## juntas para bridas



1

<b>código</b>	698523	<b>referencia</b>	20700008
<b>descripción</b>	junta L 155mm An 24.5mm D2 ø 7mm agujero ø 9mm dist. del agujero 12mm 13 orificios grafito espesor 2.2mm		



1

<b>código</b>	520562	<b>referencia</b>	070101
<b>descripción</b>	junta L 44mm An 21mm D1 ø 9mm D2 ø 9mm agujero ø 5.5mm espesor 4mm para resistencia para HOUNO		

## termostatos

## termostatos de superficie

## termostatos de superficie



1

<b>código</b>	390963	<b>referencia</b>	20800087
<b>descripción</b>	termostato de contacto dist. del agujeromm temp. desconexión 120°C 1NC 1 polos 10A 250V empalme F6,3 M4		

## termostatos de control y seguridad

## EGO

## termostatos de seguridad

## serie 55.32\_

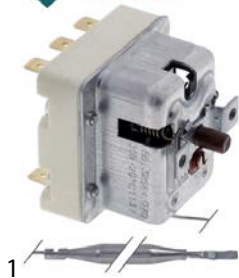

1

<b>código</b>	375988	<b>referencia</b>	062550
<b>descripción</b>	termostato de seguridad temp. desconexión 305°C 3 polos sonda ø 6mm sonda L 77mm aislamiento del capilarmm prensaestopas temperatura de conexión 20°C		

## JUMO

## termostatos de seguridad



1

<b>código</b>	375969	<b>referencia</b>	20800022
<b>descripción</b>	termostato de seguridad temp. desconexión 135°C 1 polos 1CO 16A sonda ø 4mm sonda L 150mm capilar 1500mm aislamiento del capilar 580mm eje ø 5.4mm		



1

<b>código</b>	370763	<b>referencia</b>	20800011 20820011 30820046 602031/80
<b>descripción</b>	termostato de seguridad temp. desconexión 350°C 1 polos 1CO 2.5A sonda ø 5mm sonda L 48mm capilar 950mm aislamiento del capilar 500mm prensaestopas bulbo inox cobre unión roscada M12 230V 602031/80		

## interruptores y pulsadores

## interruptores magnéticos

## ø 4mm



1

<b>código</b>	381268	<b>referencia</b>	20820012 20820014
<b>descripción</b>	interruptor magnético sonda L 57mm 1NO empalme conector longitud del cable 800mm Reed		



otros



1

<b>código</b>	348039	<b>referencia</b>	30800016
<b>descripción</b>	interruptor magnético 1NO empalme cable L 65mm L1 38mm L2 64mm distancia de sujeción 50mm para puerta		

## codificadores y potenciómetros



1

<b>código</b>	403484	<b>referencia</b>	20900026 30900064
<b>descripción</b>	codificador eje L 10mm longitud del cable 90mm eje 6mm		

## lámparas

### lámpade

#### bombillas incandescentes

##### para hornos



1

<b>código</b>	359610	<b>referencia</b>	065010
<b>descripción</b>	bombilla incandescente T máx 300°C casquillo E14 15W 230V ø 22mm L 47mm cristal L 20mm para lámpara de horno tipo Philips		

#### lámparas halógenas

##### para portalámpara G4 / G6,35 / G9



1 **500°C**

<b>código</b>	359596	<b>referencia</b>	065016 065044
<b>descripción</b>	lámpara halógena casquillo G4 12V 10W resis.a la temp. 500°C		



1 **500°C**

<b>código</b>	359599	<b>referencia</b>	065012
<b>descripción</b>	lámpara halógena casquillo G4 12V 20W resis.a la temp. 500°C		

## lámparas para hornos

### lámparas de horno específicas del fabricante

#### HOUNÖ



1

<b>código</b>	360618	<b>referencia</b>	20120131
<b>descripción</b>	cristal de lámpara con junta de goma montaje ø 85mm		



1

<b>código</b>	699627	<b>referencia</b>	20100107
<b>descripción</b>	junta para HOUNO horno a vapor combinado pos. de montaje cristal de lámpara ø ext. 65mm int.ø 53mm grafito espesor 0.6mm		



1

<b>código</b>	699628	<b>referencia</b>	20100106 30100147
<b>descripción</b>	junta para HOUNO horno a vapor combinado pos. de montaje cristal de lámpara ø ext. 83mm int.ø 52mm Viton espesor 3mm		



1

<b>código</b>	357092	<b>referencia</b>	066019 066020
<b>descripción</b>	portalámparas casquillo G4 ø 17mm H 9mm con sujeción de 2 orificios distancia de sujeción 12mm longitud de cordón 450mm		



1

<b>código</b>	360762	<b>referencia</b>	014576
<b>descripción</b>	vidrio ø 63mm espesor 3.5mm		



1

<b>código</b>	694502	<b>referencia</b>	037519
<b>descripción</b>	cristal de lámpara metal vetro con marco y junta ø 85mm		
<b>accesorios para</b>	694502		
<b>código</b>	694503	<b>referencia</b>	014575
<b>descripción</b>	junta ø 82mm agujero ø 51mm para cristales para lámparas		



1

<b>código</b>	694503	<b>referencia</b>	014575
---------------	--------	-------------------	--------

<b>descripción</b>	junta ø 82mm agujero ø 51 mm para cristales para lámparas		
--------------------	---	--	--



1

<b>código</b>	357092	<b>referencia</b>	066019 066020
---------------	--------	-------------------	------------------

<b>descripción</b>	portalámparas casquillo G4 ø 17mm H 9mm con sujeción de 2 orificios distancia de sujeción 12mm longitud de cordón 450mm		
--------------------	---	--	--

## lámparas

## bombillas incandescentes



1

<b>código</b>	359610	<b>referencia</b>	065010
---------------	--------	-------------------	--------

<b>descripción</b>	bombilla incandescente T máx 300°C casquillo E14 15W 230V ø 22mm L 47mm cristal L 20mm para lámpara de horno tipo Philips		
--------------------	---	--	--

## lámparas halógenas

## para portalámpara G4 / G6,35 / G9



1

<b>código</b>	359596	<b>referencia</b>	065016 065044
---------------	--------	-------------------	------------------

<b>descripción</b>	lámpara halógena casquillo G4 12V 10W resis.a la temp. 500°C		
--------------------	--	--	--



1

<b>código</b>	359599	<b>referencia</b>	065012
---------------	--------	-------------------	--------

<b>descripción</b>	lámpara halógena casquillo G4 12V 20W resis.a la temp. 500°C		
--------------------	--	--	--

## señalizadores de alarma

## dispositivos de alarma



1

<b>código</b>	353000	<b>referencia</b>	30800047
---------------	--------	-------------------	----------

<b>descripción</b>	señalizador de alarma sujeción 2 orificios		
--------------------	--	--	--

## contactores

## ABB

## contactores de potencia



1

<b>código</b>	381262	<b>referencia</b>	061625
---------------	--------	-------------------	--------

<b>descripción</b>	contactor de potencia AC1 20A 24VAC (AC3/400V) 12A/4kW contactos principales 2x3NO contactos auxiliares 2x1NO empalme empalme atornillado tipo VB6-30-10 / VB7-30-10		
--------------------	--	--	--



1

<b>código</b>	380107	<b>referencia</b>	061624
---------------	--------	-------------------	--------

<b>descripción</b>	contactor de potencia AC1 25A 24VAC (AC3/400V) 9A/4kW contactos principales 3NO contactos auxiliares 1NC empalme empalme atornillado tipo A9-30-01		
--------------------	--	--	--



1

<b>código</b>	381263	<b>referencia</b>	061246
---------------	--------	-------------------	--------

<b>descripción</b>	contactor de potencia AC1 30A 24VAC (AC3/400V) 17A/7,5kW contactos principales 4NO contactos auxiliares empalme empalme atornillado tipo A16-40-00		
--------------------	--	--	--



1

<b>código</b>	381264	<b>referencia</b>	61248
---------------	--------	-------------------	-------

<b>descripción</b>	contactor de potencia AC1 40A 24VAC (AC3/400V) 26A/11kW contactos principales 4NO contactos auxiliares empalme empalme atornillado tipo A26-40-00		
--------------------	---	--	--



1

<b>código</b>	381265	<b>referencia</b>	61265
<b>descripción</b>	contactor de potencia AC1 55A 24VAC (AC3/400V) 30A/15kW contactos principales 3NO contactos auxiliares 1NO empalme empalme atornillado tipo A30-30-10		



1

<b>código</b>	381266	<b>referencia</b>	61247
<b>descripción</b>	contactor de potencia AC1 70A 24VAC (AC3/400V) 45A/18,5kW contactos principales 4NO contactos auxiliares empalme empalme atornillado tipo A45-40		

contactos auxiliares



1

<b>código</b>	380126	<b>referencia</b>	61626
<b>descripción</b>	contacto auxiliar contactos 1NC AC1 16A AC15 3A empalme empalme atornillado para contactores A9-A50		

semiconductores de potencia

CELDUC



1

<b>código</b>	402974	<b>referencia</b>	20800086 30800037 30820013
<b>descripción</b>	semiconductor de potencia CELDUC fases 2 carga 50A carga 24-600V 10-30VDC L 58mm An 45mm conector atornillado tipo SOB965660		

transformadores

transformadores encapsulados

con clavija



1

<b>código</b>	403661	<b>referencia</b>	20800023
<b>descripción</b>	transformador primaria 200-480V secundaria 24V H 100mm L 105mm An 105mm 50/60Hz tipo 14458-7		

sensores

sensores específicos del fabricante

sensores



1

<b>código</b>	379777	<b>referencia</b>	062500
<b>descripción</b>	sensor de temperatura Pt100 cable silicona sonda -100 a 450°C cable -50 a +180°C empalme de dos hilos rosca 5/16 bulbo ø4x75mm longitud de cable 1.2m		



1

<b>código</b>	381229	<b>referencia</b>	20800174
<b>descripción</b>	sensor de temperatura Pt100 cable Vetrotex sonda -100 a 450°C cable -50 a +350°C empalme de dos hilos rosca bulbo ø3,5x170mm longitud de cable 0.4m -50 a +350°C		

sondas al corazón



1

<b>código</b>	381267 <sup>1</sup>	<b>referencia</b>	30800053
<b>descripción</b>	sensor al corazón Pt100 cable PTFE sonda -40 a +250°C cable -40 a +250°C empalme conector bulbo ø4x100mm rosca longitud de cable 1m asidero ømm longitud de asidero 50mm		

<sup>1</sup>sensor multipunto



<b>código</b>	381228'	<b>referencia</b>	30800054
<b>descripción</b>	sensor al corazón termopar K (NiCr-Ni) cable PTFE sonda -50 a 1150°C cable -40 a +250°C empalme conector bulbo Ø4x128mm rosca longitud de cable 1.5m asidero Ømm longitud de asidero 50mm		

\*sensor multipunto

## electrónicas

### convertidores de frecuencia



<b>código</b>	403483	<b>referencia</b>	20800211
<b>descripción</b>	convertidor de frecuencia 200-240V 50/60Hz L 125mm An 43mm H 144mm frecuencia output 0-250Hz 6.9A corriente de salida 2.2A		



<b>código</b>	403482	<b>referencia</b>	20800084
<b>descripción</b>	convertidor de frecuencia con disipador 200-240V 50/60Hz frecuencia output 0-250Hz 10.8A corriente de salida 4.3A		

### placas electrónicas



<b>código</b>	404020	<b>referencia</b>	3090002 30900059
<b>descripción</b>	display horno a vapor combinado Slim/Visual Cooking L 10.4mm An 144mm TFT		
<b>accesorios para</b>	404020		
	<b>código</b>	<b>referencia</b>	30900013
	cable de cinta plana L 120mm para display		

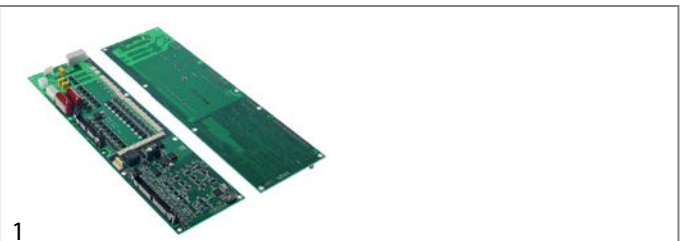

<b>código</b>	404024	<b>referencia</b>	20900002
<b>descripción</b>	placa base horno a vapor combinado Visual Cooking L 348mm An 100mm tipo 20 90 0002 Rev:2.2		



<b>código</b>	404022	<b>referencia</b>	30900014
<b>descripción</b>	placa de display horno a vapor combinado Visual Cooking L 133mm An 139mm		



<b>código</b>	403913	<b>referencia</b>	30900054
<b>descripción</b>	placa de display L 140mm An 135mm para HOUNO B/C/K Ver3.51		





1

<b>código</b>	403912	<b>referencia</b>	30900069
<b>descripción</b>	placa de display L 140mm An 135mm para HOUNO CombiSlim C Ver9.14		

1

<b>código</b>	404021	<b>referencia</b>	30900008
<b>descripción</b>	placa electrónica horno a vapor combinado Visual Cooking An 140mm para horno a vapor combinado H 140mm tipo Ver 1.67		

1

<b>código</b>	404023	<b>referencia</b>	30900006
<b>descripción</b>	placa electrónica horno a vapor combinado Visual Cooking para horno a vapor combinado		

1

<b>código</b>	403733	<b>referencia</b>	033908
<b>descripción</b>	placa electrónica L 340mm An 135mm		

## válvulas magnéticas

### válvulas magnéticas agua

RPE

1

<b>código</b>	370760	<b>referencia</b>	30520037	
<b>descripción</b>	válvula magnética doble recto 24VAC entrada 3/4" salida 10mm DN10 T máx 90°C plástico reducción salida B presentel/min reducción salida B blanco			
<b>repuestos para</b>	370760			
	<b>código</b>	370774	<b>referencia</b>	—
	bobina magnética RPE 24VAC			

1

<b>código</b>	370758	<b>referencia</b>	30520192	
<b>descripción</b>	válvula magnética doble recto 24VAC entrada 3/4" salida 10mm reducción entrada A 10-12l/min DN10 T máx 90°C plástico reducción salida B 1-1,25l/min reducción salida B blanco			
<b>repuestos para</b>	370758			
	<b>código</b>	370774	<b>referencia</b>	—
	bobina magnética RPE 24VAC			

### salida especial

1

<b>código</b>	371228	<b>referencia</b>	20720230
<b>descripción</b>	válvula magnética doble 24V salida 6,5mm entrada 3/4"		

1

<b>código</b>	371229	<b>referencia</b>	20720228
<b>descripción</b>	válvula magnética simple 24V entrada 3/4mm salida 6,5mm reducción entrada A 10l/min RPE entrada 3/4"		

1

<b>código</b>	371227	<b>referencia</b>	20720234
<b>descripción</b>	válvula magnética triple 24V salida 6,5mm DN10 RPE entrada 3/4		

### válvulas magnéticas con reducciones

#### simple

1

<b>código</b>	370761	<b>referencia</b>	30520034
<b>descripción</b>	válvula magnética simple recto 24VAC entrada 3/4" salida 11mm DN10 T máx 90°C plástico reducción salida A presentel/min reducción salida B blanco		





doble

			
1			
<b>código</b>	374008	<b>referencia</b>	032110
<b>descripción</b>	válvula magnética doble recto 24V entrada 3/4" salida 14mm reducción entrada A 10-12l/min RPE plástico reducción salida A 1.2l/min reducción salida B 1.2l/min entrada 3/4"mm		

			
1			
<b>código</b>	374003	<b>referencia</b>	032112
<b>descripción</b>	válvula magnética doble, con reducción recto 24V entrada 3/4" salida 14mm T máx 60°C RPE plástico reducción salida A 1.2l/min reducción salida A blanco		

triple

			
1			
<b>código</b>	370764	<b>referencia</b>	30520180
<b>descripción</b>	válvula magnética triple recto 24V entrada 3/4" salida 10mm DN10 T máx 60°C TP reducción salida C 1.2l/min reducción salida C blanco		

			
1			
<b>código</b>	374002	<b>referencia</b>	032111
<b>descripción</b>	válvula magnética triple, con reductor recto 24V entrada 3/4" salida 14mm T máx 60°C reducción salida A 1.2l/min reducción salida B 1.2l/min reducción salida A blanco reducción salida B blanco		

cuádruple

			
1			
<b>código</b>	370762	<b>referencia</b>	30500054 30520181
<b>descripción</b>	válvula magnética cuádruple con sensor 24V entrada 3/4" salida 10,5mm T máx 90°C reducción salida D 1,20l/min reducción salida D blanco		

presostatos

para hornos a vapor combinado

			
1			
<b>código</b>	348047	<b>referencia</b>	071138 30220071
<b>descripción</b>	presostato margen de presión 0-3mbar completo empalme 6mm p máx. 0,025bar empalme de presión 6mm		

			
1			
<b>código</b>	543023	<b>referencia</b>	308000145 62565
<b>descripción</b>	presostato presión reinicio 1.5bar empalme 1/8" apto para HOUNO 1NC		

			
1			
<b>código</b>	543032	<b>referencia</b>	32720056
<b>descripción</b>	presostato diferencial margen de presión 0,2-1,5mbar empalme presión ø 4.7mm DUNGS protección IP54 temperatura ambiente máx. -10 a +85°C		





## ventiladores

### ventilador axial

#### importación



1

<b>código</b>	601080 <sup>1</sup>	<b>referencia</b>	60211
<b>descripción</b>	ventilador axial L 119mm An 119mm H 38mm 230VAC 50/60Hz 23/20W cojinete rodamiento de bolas empalme conector Faston 2,8mm metal ADDA rodete ventilador ø 110mm resis.a la temp. 70°C		
<b>accesorios para</b>	601080		
	<b>código</b>	550898	<b>referencia</b> —
	cable de conexión longitud del cable 2000mm empalme F 2,8 distancia de empalme 7.9mm para ventilador axial		
	<b>código</b>	692519	<b>referencia</b> —
	rejilla de protección L 120mm An 120mm plástico		

<sup>1</sup>con rodamiento de bolas



1

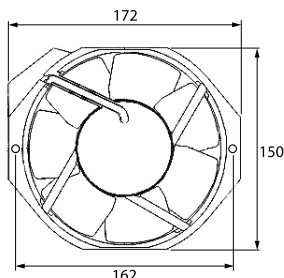

<b>código</b>	601706 <sup>1</sup>	<b>referencia</b>	N/A
<b>descripción</b>	ventilador axial L 172mm An 150mm H 51mm 230VAC 50/60Hz 69W cojinete rodamiento de bolas empalme conector Faston 3,2mm ADDA rodete ventilador ø 140mm		
<b>accesorios para</b>	601706		
	<b>código</b>	550898	<b>referencia</b> —
	cable de conexión longitud del cable 2000mm empalme F 2,8 distancia de empalme 7.9mm para ventilador axial		

<sup>1</sup>con rodamiento de bolas

### motores de aire caliente



1

<b>código</b>	696843	<b>referencia</b>	30700022
<b>descripción</b>	casquillo con muelle ø 14mm ø ext. 20mm H 12mm int.ø 8mm		



1

<b>código</b>	601352	<b>referencia</b>	60201
<b>descripción</b>	motor de ventilador 380-400V fases 3 50Hz 0,02/0,16kW 710/1390rev/min velocidades 2 L1 140mm L2 27mm L3 35mm M10D F 0,2/0,5A consumo 60/250W a 50 Hz 710/1390rev/min Y/YY tipo L7mw84D-148 N° T1 D1 ø 17mm D2 ø 13mm		



1

<b>código</b>	602004	<b>referencia</b>	60306
<b>descripción</b>	rodete ventilador palas 12 D1 ø 350mm D2 ø 13mm D3 ø 16mm H1 133mm H2 14mm H3 32mm		

## motores

### motorreductores

#### para hornos

#### para chimeneas



1

<b>código</b>	501469	<b>referencia</b>	20700012
<b>descripción</b>	tapa de ventilación FIBER tipo P255201B4T1 24V 50Hz 6rev/min árbol ø 6mm L 88mm An 56mm H 55mm tipo de motor M51B20R0000		

## bombas

### bombas de salida

#### HANNING



1

<b>código</b>	501441	<b>referencia</b>	20520270 20700034
<b>descripción</b>	bomba de desagüe 38W 200-240V entrada ø 24mm salida ø 24mm 50/60Hz HANNING máx. 15min versión reforzada tiempo de pausa 45min consumo de corriente 0.4A		

## fusibles

### fusibles finos

#### portafusibles



1

<b>código</b>	358192	<b>referencia</b>	20800115
<b>descripción</b>	portafusibles fusible adaptable 5x20/5x25mm 6.3A nominal 250V		

### contactores de protección de línea

#### otros



1

<b>código</b>	358114	<b>referencia</b>	061407
<b>descripción</b>	contactor de protección de línea 3 polos 6A característica de disparo C nominal 400V empalme atornillado		

## accesorios eléctricos

### cables

#### cables de cinta plana

#### grupo 10



1

<b>código</b>	698525	<b>referencia</b>	30900013
<b>descripción</b>	cable de cinta plana L 120mm para display		

## terminales

### bloques de bornes

#### otros



1

<b>código</b>	551281	<b>referencia</b>	20800122
<b>descripción</b>	borne seccionable máx. 400V empalme conexión enchufable 4 polos máx. 10A sección nominal 4mm <sup>2</sup>		

## otros

### kits de servicio



1

<b>código</b>	698520	<b>referencia</b>	033531 033608 066025 20120203
<b>descripción</b>	kit de servicio para iluminación para horno a vapor combinado		

## encendidos y temopares

### unidades de encendido



1

<b>código</b>	107895	<b>referencia</b>	32700166
<b>descripción</b>	grupo de encendido salidas 1 220-240VAC medidas 84x62x38mm distancia de sujeción 58mm entrada F6,3x0,8 salida 4 tipo TRK2-30PF-VD 69VA 50/60Hz protección IP54		



## quemadores de gas

### accesorios

#### juntas



1

<b>código</b>	514531	<b>referencia</b>	32700045
<b>descripción</b>	junta grafito ø ext. 117mm int.ø 94mm espesor 1.7mm UE 1 pzs		

### accesorios



1

<b>código</b>	107896	<b>referencia</b>	32700090
<b>descripción</b>	distribuidor gas L 118mm latón rosca cónico para HOUNO horno a vapor combinado		

#### unidades de salida

##### bandejas recogegotas



1

<b>código</b>	696848	<b>referencia</b>	30410005
<b>descripción</b>	bandeja recogegotas L 500mm acero inoxidable An 26mm para horno a vapor combinado		



1

<b>código</b>	696819	<b>referencia</b>	20420022 30420152
<b>descripción</b>	bandeja recogegotas L 553mm acero inoxidable An 26mm para horno a vapor combinado		



1

<b>código</b>	696818	<b>referencia</b>	30410026
<b>descripción</b>	bandeja recogegotas L 760mm acero inoxidable An 26mm para horno a vapor combinado		

#### boquillas de inyección



1

<b>código</b>	542436	<b>referencia</b>	059257
<b>descripción</b>	boquilla de inyección L 20mm EC 12 acero inoxidable para horno a vapor combinado rosca 1/8" M cónico JAU 1310		



1

<b>código</b>	542437	<b>referencia</b>	059216 30500400
<b>descripción</b>	boquilla de inyección taladro ø 1.1mm D1 ø 11mm L 23mm EC 12 inox para horno a vapor combinado rosca 1/8" M cónico		

#### tubos



1

<b>código</b>	521199	<b>referencia</b>	30500013
<b>descripción</b>	tubo L 360mm ø 25mm para horno a vapor combinado acero inoxidable		

#### puertas



1

<b>código</b>	698527	<b>referencia</b>	2042008
<b>descripción</b>	vidrio de puerta interior para HOUNO 1.06 H 579mm An 518mm		

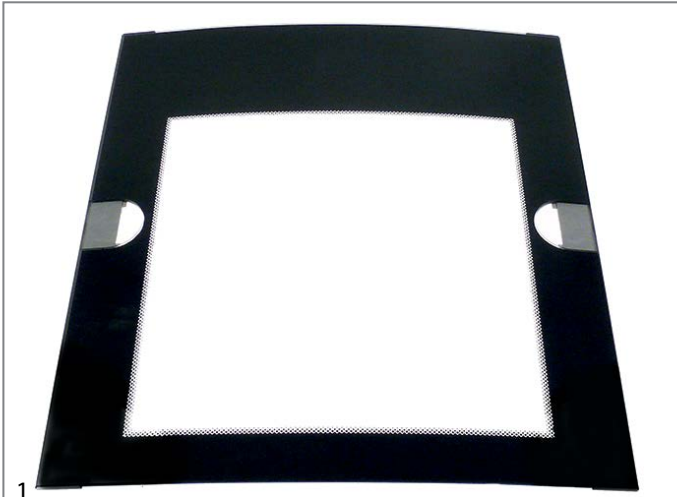

1	<b>código</b>	698528	<b>referencia</b>	30420020
	<b>descripción</b>	vidrio de puerta para HOUNO H 584mm An 692mm		

macánica de puertas

accesorios



1	<b>código</b>	696817	<b>referencia</b>	30400048
	<b>descripción</b>	cubierta An 25mm agujero ø 6.2mm L 70mm		



1	<b>código</b>	701648	<b>referencia</b>	064872
	<b>descripción</b>	resorte de gas para horno a vapor combinado 150N D1 ø 15mm D2 ø 6mm dist. del agujero 255mm agujero ø 6mm L 265mm		



1	<b>código</b>	701649	<b>referencia</b>	064874
	<b>descripción</b>	resorte de gas para horno a vapor combinado 250N D1 ø 15mm D2 ø 6mm dist. del agujero 255mm agujero ø 6mm L 268mm		



1	<b>código</b>	542439	<b>referencia</b>	30400027
	<b>descripción</b>	resorte de torsión ø 13mm L2 12mm espesor de hilo 2mm L1 12mm L3 12mm UE 1 pzs		



1	<b>código</b>	696816	<b>referencia</b>	014043
	<b>descripción</b>	tope para vidrio ø 13mm goma L 17mm		

otros



1	<b>código</b>	692213	<b>referencia</b>	032400
	<b>descripción</b>	mecánico para interruptor L 530mm rosca 1/4" An 50mm ø 8mm agujero ø 11.6mm		



1	<b>código</b>	698521	<b>referencia</b>	20400238
	<b>descripción</b>	tapón L 35.4mm ø 13mm		

cierres

cierres de palanca

específico del fabricante

HOUNÖ



1	<b>código</b>	694851	<b>referencia</b>	069022 30400031 30400034 30420694 30420849 30420850 30420864 30421087
	<b>descripción</b>	cierre Kit		
	<b>repuestos para</b>	694851		

	<b>código</b>	694848	<b>referencia</b>	30420245 30420840
	<b>descripción</b>	retén con espiga 2 niveles L 70mm An 25mm H 44mm distancia de sujeción 50mm		

componentes mecánicos y accesorios aparatos



<p>1</p>			
<b>código</b>	694607	<b>referencia</b>	20400207 20410019 20420227 20420262 20420313 30400030 30400032 30410004 30420013 30420853 30420854 30421088
<b>descripción</b>	cierre para horno a vapor combinado distancia de sujeción 50mm HOUNO		
<b>repuestos para</b>	694607		
	<b>código</b>	694848	<b>referencia</b>
			30420245 30420840
	retén con espiga 2 niveles L 70mm An 25mm H 44mm distancia de sujeción 50mm		

<p>1</p>			
<b>código</b>	701415	<b>referencia</b>	30420698
<b>descripción</b>	manilla de puerta L 171mm An 40mm asidero ø 25mm longitud muelle 38mm inox rosca de sujeción M5 brida ø 39mm		
<b>repuestos para</b>	701415		
	<b>código</b>	514390	<b>referencia</b>
			069023
	resorte para tirador de puerta ø 6mm L 54mm An 27.5mm		

<p>1</p>			
<b>código</b>	514390	<b>referencia</b>	069023
<b>descripción</b>	resorte para tirador de puerta ø 6mm L 54mm An 27.5mm		

<p>1</p>			
<b>código</b>	694066	<b>referencia</b>	069020
<b>descripción</b>	retén con espiga 2 niveles L 28mm An 14mm H 15mm H1 16mm longitud total 51mm rosca M8 rosca L 23mm acero inoxidable		

<p>1</p>			
<b>código</b>	694848	<b>referencia</b>	30420245 30420840
<b>descripción</b>	retén con espiga 2 niveles L 70mm An 25mm H 44mm distancia de sujeción 50mm		

cierres angulares

cierres de palanca

específico del fabricante

HOUNÖ

<p>1</p>			
<b>código</b>	694784	<b>referencia</b>	034317
<b>descripción</b>	cierre L 172mm distancia de sujeción 124/133mm cromado sin cierre aparatos térmicos 6200 H 65mm tipo DUPLO longitud total 248mm		
<b>accesorios para</b>	694784		
	<b>código</b>	690123	<b>referencia</b>
			037967 069012
	retén H 69mm P 37mm An 20mm distancia de sujeción 43mm con rueda		

<p>retén</p> <p>1</p>			
<b>código</b>	690123	<b>referencia</b>	037967 069012
<b>descripción</b>	retén H 69mm P 37mm An 20mm distancia de sujeción 43mm con rueda		



# juntas

## juntas térmicas

### juntas para puertas

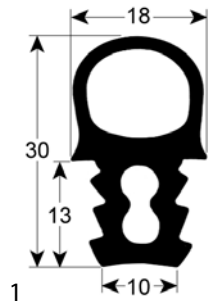

<b>código</b>	902542	<b>referencia</b>	037064
<b>descripción</b>	junta de puerta perfil 2073 An 484mm L 676mm medida inserción exterior UE 1		

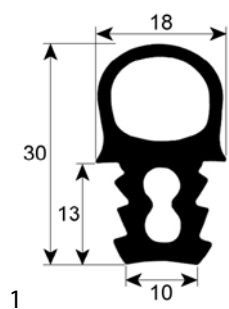

<b>código</b>	901499	<b>referencia</b>	037068
<b>descripción</b>	junta de puerta perfil 2073 An 490mm L 1465mm medidas exteriores UE 1 para HOUNO 1.20-99		

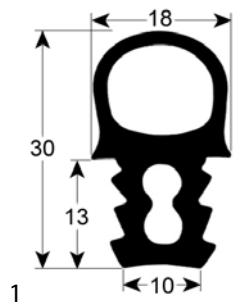

<b>código</b>	901440	<b>referencia</b>	037063
<b>descripción</b>	junta de puerta perfil 2073 An 490mm L 560mm medidas exteriores UE 1 para HOUNO 1.06-99		

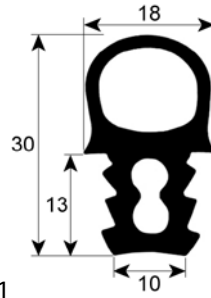

<b>código</b>	901459	<b>referencia</b>	037065
<b>descripción</b>	junta de puerta perfil 2073 An 490mm L 810mm medidas exteriores UE 1		

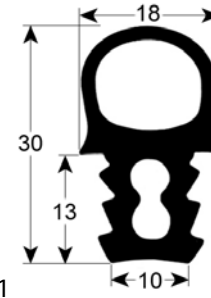

<b>código</b>	901652	<b>referencia</b>	037066
<b>descripción</b>	junta de puerta perfil 2073 An 495mm L 955mm medidas exteriores UE 1		

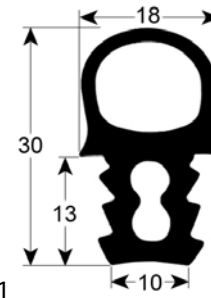

<b>código</b>	901853	<b>referencia</b>	32903
<b>descripción</b>	junta de puerta perfil 2073 An 530mm L 605mm medida inserción exterior para HOUNO		

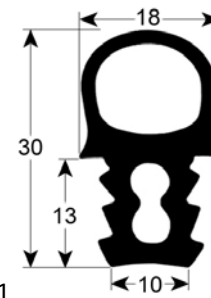

<b>código</b>	901670	<b>referencia</b>	032904
<b>descripción</b>	junta de puerta perfil 2073 An 535mm L 835mm medidas exteriores UE 1		



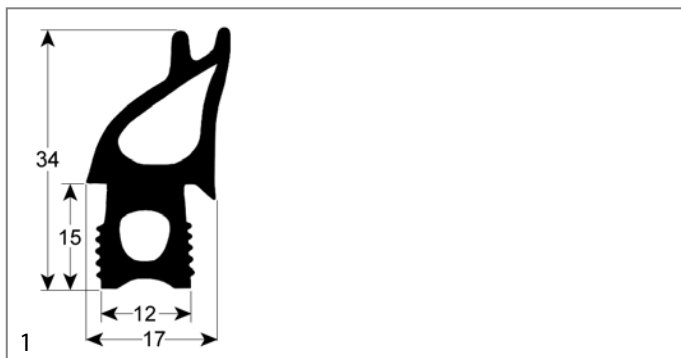

<b>código</b>	901387	<b>referencia</b>	20300234 30300134
<b>descripción</b>	junta de puerta perfil 2735 An 490mm L 550mm medidas exteriores UE 1 gris oscuro		

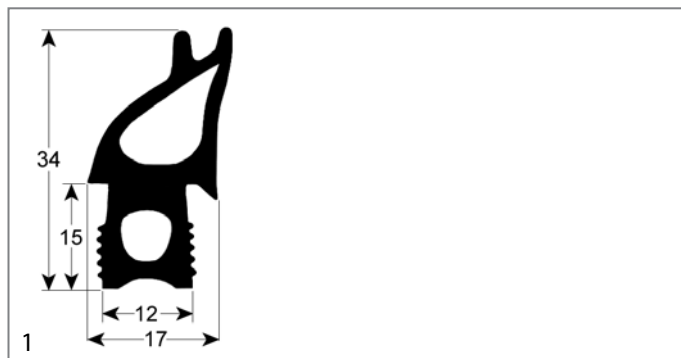

<b>código</b>	902540	<b>referencia</b>	20300239 30300137
<b>descripción</b>	junta de puerta perfil 2735 An 491mm L 947mm medida inserción exterior UE 1		

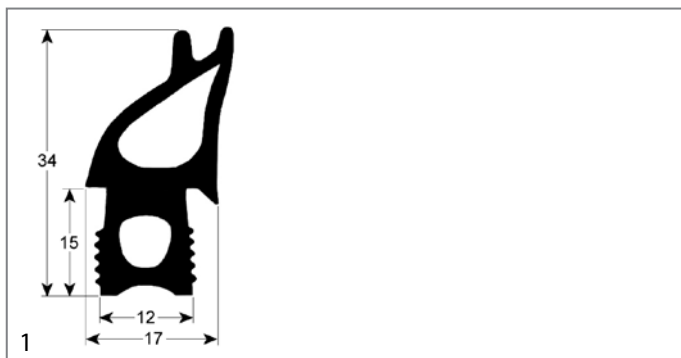

<b>código</b>	902106	<b>referencia</b>	20300235 30300135
<b>descripción</b>	junta de puerta perfil 2735 An 490mm L 690mm medidas exteriores UE 1		

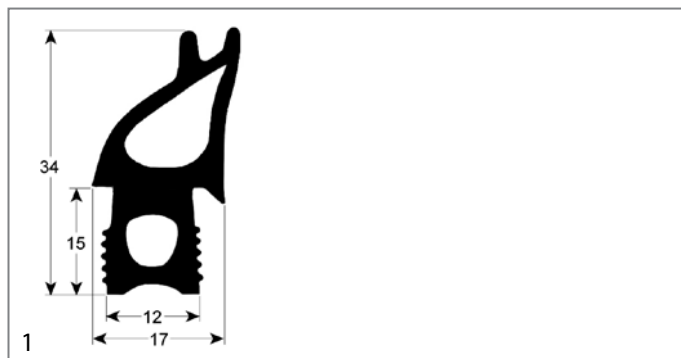

<b>código</b>	901854	<b>referencia</b>	20300241 30300139
<b>descripción</b>	junta de puerta perfil 2735 An 495mm L 1470mm medida inserción exterior para HOUNO		

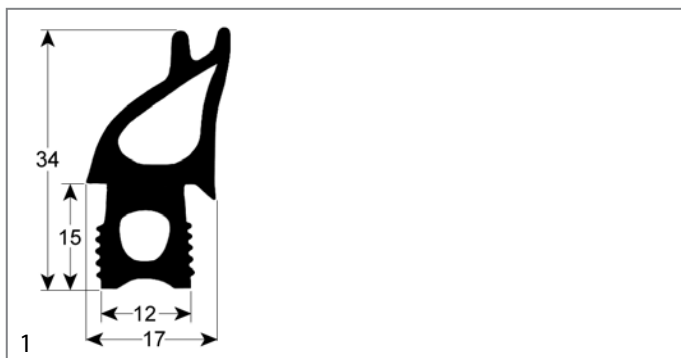

<b>código</b>	901386	<b>referencia</b>	20300236 30300136
<b>descripción</b>	junta de puerta perfil 2735 An 490mm L 820mm medidas exteriores UE 1		

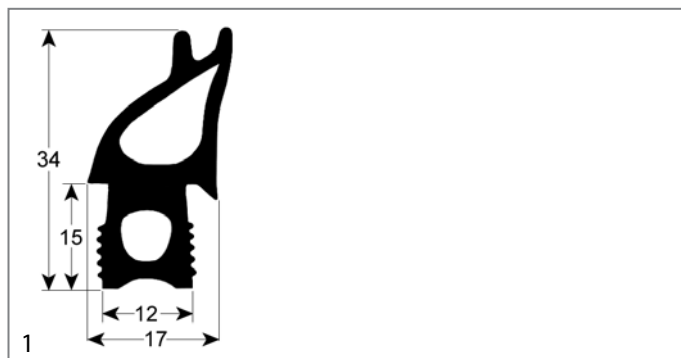

<b>código</b>	902536	<b>referencia</b>	30300187
<b>descripción</b>	junta de puerta perfil 2735 An 558mm L 683mm medida inserción exterior UE 1		



<b>código</b>	901855	<b>referencia</b>	30300108 30300142
<b>descripción</b>	junta de puerta perfil 2735 An 682mm L 1470mm UE 1 para HOUNO		

<b>código</b>	902538	<b>referencia</b>	30300141
<b>descripción</b>	junta de puerta perfil 2735 An 683mm L 1080mm medida inserción exterior UE 1		

<b>código</b>	902537	<b>referencia</b>	20300237 30300140
<b>descripción</b>	junta de puerta perfil 2735 An 683mm L 819mm medida inserción exterior UE 1		

<b>código</b>	902534	<b>referencia</b>	30300182
<b>descripción</b>	junta de puerta perfil 2739 L 1464mm UE 1 para HOUNO		

<b>código</b>	902535	<b>referencia</b>	30300183
<b>descripción</b>	junta de puerta perfil 2739 L 1845mm UE 1 para HOUNO		

juntas para bandejeros

<b>código</b>	902521	<b>referencia</b>	30420224 30420767
<b>descripción</b>	junta para carro porta bandejas con panel frontal L 760mm UE 1 apto para horno a vapor combinado HOUNO 2.20		

<b>código</b>	902529	<b>referencia</b>	30400325
<b>descripción</b>	junta para carro porta bandejas perfil 4150 L 540mm apto para 1.16/1.20 roll-in UE 1		

<b>código</b>	902530	<b>referencia</b>	30400281
<b>descripción</b>	junta para carro porta bandejas perfil 4150 L 760mm apto para 2.20 roll-in UE 1		



## juntas tóricas

EPDM

ø2,62mm

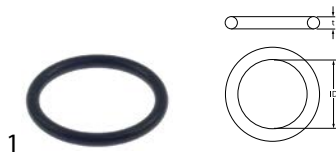

**código** 532453 **referencia** 32700106

**descripción** junta tórica EPDM espesor 2.62mm int.ø 21.89mm UE 1 pzs

## anillos de junta

### juntas de grafito



**código** 514531 **referencia** 32700045

**descripción** junta grafito ø ext. 117mm int.ø 94mm espesor 1.7mm UE 1 pzs

### juntas de gomaespuma



**código** 505406 **referencia** 30300363

**descripción** junta de gomaespuma An 10mm espesor 4mm autoadhesivo UE al metro

## juntas especiales

### para hornos a vapor combinado



**código** 699627 **referencia** 20100107

**descripción** junta para HOUNO horno a vapor combinado pos. de montaje cristal de lámpara ø ext. 65mm int.ø 53mm grafito espesor 0.6mm



**código** 699628 **referencia** 20100106  
30100147

**descripción** junta para HOUNO horno a vapor combinado pos. de montaje cristal de lámpara ø ext. 83mm int.ø 52mm Viton espesor 3mm

## otros



**código** 698524 **referencia** 32700059

**descripción** junta An 37.2mm L 60mm horno a vapor combinado para HOUNO espesor 4mm



**código** 514531 **referencia** 32700045

**descripción** junta grafito ø ext. 117mm int.ø 94mm espesor 1.7mm UE 1 pzs



**código** 511653 **referencia** 20600007

**descripción** junta silicona L 82mm An 82mm espesor 3mm

## muelles

### muelles de torsión



**código** 542439 **referencia** 30400027

**descripción** resorte de torsión ø 13mm L2 12mm espesor de hilo 2mm L1 12mm L3 12mm UE 1 pzs

### resortes de gas

#### resortes de gas



**código** 701648 **referencia** 064872

**descripción** resorte de gas para horno a vapor combinado 150N D1 ø 15mm D2 ø 6mm dist. del agujero 255mm agujero ø 6mm L 265mm



**código** 701649 **referencia** 064874

**descripción** resorte de gas para horno a vapor combinado 250N D1 ø 15mm D2 ø 6mm dist. del agujero 255mm agujero ø 6mm L 268mm

## enrolladores de tubo y duchas de mano para lavado

### duchas de mano para lavado



1

<b>código</b>	542075	<b>referencia</b>	041063
<b>descripción</b>	ducha de mano de aparato tubo ø 7mm		



1

<b>código</b>	542038	<b>referencia</b>	059959
<b>descripción</b>	ducha de mano de aparato 3/8" H L 135mm		

## tubos flexibles

### tubos flexibles industriales

#### tubos de nylon



1

<b>código</b>	570146	<b>referencia</b>	059003 30500498
<b>descripción</b>	tubo de nylon int.ø 4mm ø ext. 6mm L 1m p de trabajo 10bar p de reventamiento 50bar T máx 100°C azul		

#### tubos de silicona

##### con tejido

##### con trenzado exterior de monofil



1

<b>código</b>	530542	<b>referencia</b>	— 059963 30500065
<b>descripción</b>	tubo de silicona revestido en monohilo int.ø 10mm ø ext. 17mm L 5m grosor de la pared 3.5mm p de trabajo 4bar presión de reventam. a 95°C no definido bar presión de reventam. a 130°C no definido bar T máx 200°C UE 5m		

## tubos formados

### recto



1

<b>código</b>	504871	<b>referencia</b>	30500012 30500500
<b>descripción</b>	tubo formado ø ext. 34 int.ø 24mm goma negro UE 1		

## guarniciones, empalmes para mangueras y tubos

### guarniciones

#### piezas T

##### latón



1

<b>código</b>	698522	<b>referencia</b>	59122
<b>descripción</b>	pieza T rosca 1/4" latón 1x rosca macho 2x rosca hembra L 38mm		

### empalmes de tubo

#### acero inoxidable



1

<b>código</b>	542438	<b>referencia</b>	059147
<b>descripción</b>	empalme de tubo rosca 1/8" tubo ø 6mm inox		

## materiales de sujeción

### tornillos

#### tornillos de cabeza avellanada



1

<b>código</b>	560337	<b>referencia</b>	055620
<b>descripción</b>	tornillo de cabeza avellanada rosca M6 L 20mm EC 4 inox DIN 7991/ ISO 10642 UE 1 pzs soporte Allen		

## tuercas hexagonales



1

<b>código</b>	560088	<b>referencia</b>	55618
<b>descripción</b>	tornillo de cabeza hexagonal rosca M6 rosca L 20mm inox EC 10 UE 20 pzs DIN 933 / ISO 4017		

## tornillos de cabeza cilíndrica

DIN 912/ISO 4762



1

<b>código</b>	560652	<b>referencia</b>	055503
<b>descripción</b>	tornillo de cabeza cilíndrica rosca M5 L 35mm rosca L 24mm EC 4 A2-70 UE 1 pzs ø cabezal 8mm DIN 912/ISO 4762		

## tornillos planos



1

<b>código</b>	560052	<b>referencia</b>	055511 055514
<b>descripción</b>	tornillo plano rosca M5 L 10mm inox UE 20 pzs soporte ranura ø cabezal 12.5mm		

## tuercas

### tuercas hexagonales

DIN 934 / ISO 4032/8673



1

<b>código</b>	560129	<b>referencia</b>	056500
<b>descripción</b>	tuerca hexagonal rosca M5 H 4mm EC 8 inox DIN/ISO DIN 934 / ISO 4032/8673 UE 1 pzs		

## arandelas

### arandelas elásticas



1

<b>código</b>	560123	<b>referencia</b>	57601
<b>descripción</b>	arandela grower int.ø 6.3mm ø ext. 11mm inox DIN127 UE 20 pzs para rosca M6		

## consumibles

### fusibles

#### fusibles finos

#### portafusibles



1

<b>código</b>	358192	<b>referencia</b>	20800115
<b>descripción</b>	portafusibles fusible adaptable 5x20/5x25mm 6.3A nominal 250V		



<b>A</b>		<b>P</b>	
accesorios eléctricos	12	presostatos	10
anillos de junta	19	<b>Q</b>	
arandelas elásticas	21	quemadores de gas	13
<b>B</b>		<b>R</b>	
bombas	12	resistencias	2
bombas de salida	12	resistencias circulación de aire	3
bombillas incandescentes	5	resistencias de inmersión	2
<b>C</b>		retén	15
cables	12	<b>S</b>	
cables de cinta plana	12	semiconductores de potencia	7
cierres angulares	15	señalizadores de alarma	6
cierres de palanca	15	sensores	7
consumibles	21	<b>T</b>	
contactores	6	terminales	12
<b>D</b>		termostatos	4
duchas de mano con rosca macho	20	termostatos de seguridad	4,4
duchas de mano para lavado	20	termostatos de superficie	4,4
<b>E</b>		tornillos	20
empalmes de tubo	20	tornillos de cabeza avellanada	20
<b>F</b>		tornillos de cabeza cilíndrica	21
fusibles	12, 21	tornillos planos	21
fusibles finos	21	transformadores	7
<b>G</b>		tubos de nylon	20
guarniciones	20	tubos de silicona	20
<b>I</b>		tubos flexibles	20
interruptores magnéticos	4	tubos flexibles industriales	20
interruptores y pulsadores	4	tubos formados	20
<b>J</b>		tuercas	21
juntas de gomaespuma	19	tuercas hexagonales	21, 21
juntas para bandejeros	18	<b>U</b>	
juntas para puertas	16	unidades de encendido	12
juntas térmicas	16	<b>V</b>	
juntas tóricas	19	válvulas magnéticas	9
<b>L</b>		ventilador axial	11
lámparas	5	ventiladores	11
lámparas halógenas	5	<b>M</b>	
lámparas para hornos	5	material de sujeción	20
<b>M</b>		motores	11
material de sujeción	20	motores de aire caliente	11
motores	11		
motores de aire caliente	11		