



Ricambios para Hornos Combinados de



Repuestos adaptables a

RETIGO

2017

Encuentre nuestra gama siempre actualizada en la tienda online de GEV



resistencias

resistencias de inmersión

otros



1

código	420360	referencia	AX24-0008 AX24-0008+AX24-0002 EX24-0008
descripción	resistencia 12000W 230V espirales 3 L 330mm An 42mm H 65mm casquillo portasondas 1 ø casquillo portasondas 3.5mm longitud casquillo portasondas 80mm casquillo termostato descentrado, ceñido tubo ø 8.4mm dist. del agujero 65/77mm agujero ø 8mm empalme M4 brida resistencia de inmersión anchura brida 83mm longitud brida 95mm		
Para modelos:	B1011b, B1221b, B2011b, B2021b, O1011b, O1221b, O2011b, O2021b		
accesorios para	420360		
	código	520580	referencia AX24-0002
	junta goma L 96mm An 84mm espesor 5mm agujero ø 7mm dist. del agujero 65x78mm		



1

código	417542	referencia	AX24-0006 AX24-0006+AX24-0002
descripción	resistencia 3x3000W 230V espirales 3 L 305mm An 68mm H 40mm casquillo portasondas 1 ø casquillo portasondas 3.3mm longitud casquillo portasondas 970mm casquillo termostato arriba derecha tubo ø 8.5mm dist. del agujero 77x67mm agujero ø 7.9mm empalme atornillado resistencia de inmersión anchura brida 95mm longitud brida 83mm con junta		
Para modelos:	B611b, O611b		
accesorios para	417542		
	código	520580	referencia AX24-0002
	junta goma L 96mm An 84mm espesor 5mm agujero ø 7mm dist. del agujero 65x78mm		



1

código	419143	referencia	EX24-0006
descripción	resistencia 9000W 230V espirales 3 L 305mm An 45mm H 65mm casquillo portasondas 1 ø casquillo portasondas 2.5mm longitud casquillo portasondas 90mm dist. del agujero 65x78mm agujero ø 8mm longitud de empalme 33mm empalme M4 brida rectangular resistencia de inmersión		
accesorios para	419143		
	código	520580	referencia AX24-0002
	junta goma L 96mm An 84mm espesor 5mm agujero ø 7mm dist. del agujero 65x78mm		

resistencias circulación de aire



1

código	417545	referencia	AX00-0007 AX00-0007+AX00-0008
descripción	resistencia 16000W 230V espirales 3 int.ø 380mm ø ext. 430mm L 460mm H 98mm L1 45mm B1 187mm H1 18mm H2 80mm longitud brida 210mm anchura brida 24mm empalme atornillado longitud de empalme 90mm tubo ø 8.5mm resistencia circulación de aire agujero ø 7.6mm brida rectangular horno a vapor combinado		
Para modelos:	B1011b, B1011i, B1221b, B1221i, B2011b, B2011i, O1011b, O1011i, O1221b, O1221i, O2011b, O2011i		
accesorios para	417545		
	código	521127	referencia AX00-0008
	junta L 210mm An 24mm espesor 2mm para resistencia		



1

código	417546	referencia	AX00-0018
descripción	resistencia 29000W 230V espirales 6 int.ø 430mm ø ext. 530mm L 530mm H 130mm L1 20mm B1 100mm H1 21mm H2 150mm longitud brida 130mm anchura brida 90mm dist. del agujero 55mm empalme atornillado longitud de empalme 85mm tubo ø 8.5mm resistencia circulación de aire agujero ø 7.6mm brida rectangular horno a vapor combinado		
Para modelos:	B2021b, B2021i, O2021b, O2021i		

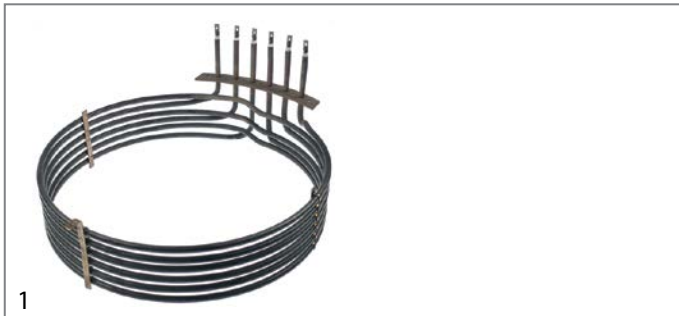

código	417544	referencia	AX00-0005 AX00-0005+AX00-0008
descripción	resistencia 3x3000W 230V espirales 3 int.ø 375mm ø ext. 400mm L 455mm H 200mm L1 45mm B1 160mm H1 20mm H2 110mm longitud brida 210mm anchura brida 25mm dist. del agujero 30mm empalme atornillado longitud de empalme 90mm tubo ø 8.5mm resistencia circulación de aire agujero ø 7.6mm brida rectangular horno a vapor combinado		
Para modelos:	B611b, B611i, O611b, O611i		
accesorios para	417544		
	código	referencia	521127 AX00-0008
	junta L 210mm An 24mm espesor 2mm para resistencia		





código	417541	referencia	AX00-0016 AX00-0016+AX00-0017
descripción	resistencia 4800W 230V espirales 3 int.ø 205mm ø ext. 250mm L 290mm H 45mm L1 45mm B1 95mm H1 5mm H2 30mm longitud brida 110mm anchura brida 20mm dist. del agujero 35mm empalme atornillado longitud de empalme 100mm tubo ø 6.4mm resistencia circulación de aire brida rectangular horno a vapor combinado		
Para modelos:	B623i, O623i		

accesorios

juntas para bridas

	código	referencia	551258 AX00-0020
	junta L 130mm An 88mm D1 ø 7mm D2 ø 11mm 12 orificios espesor 2mm para horno a vapor combinado para 417546		
Para modelos:	B2021b, B2021i, O2021b, O2021i		

	código	referencia	521072 AX00-0017
	junta L 112mm An 22mm D1 ø 10mm D2 ø 5.5mm grafito espesor 2mm para resistencia para RETIGO		
Para modelos:	B623i, O623i		

	código	referencia	521127 AX00-0008
	junta L 210mm An 24mm espesor 2mm para resistencia		
Para modelos:	B1011b, B1011i, B1221b, B1221i, B2011b, B2011i, B611b, B611i, O1011b, O1011i, O1221b, O1221i, O2011b, O2011i, O611b, O611i		

	código	referencia	520580 AX24-0002
	junta goma L 96mm An 84mm espesor 5mm agujero ø 7mm dist. del agujero 65x78mm		
Para modelos:	B1011b, B1221b, B2011b, B2021b, B611b, O1011b, O1221b, O2011b, O2021b, O611b		

termostatos

termostatos de control y seguridad

JUMO

termostatos de seguridad

	código	referencia	390922 EA04-0011
	termostato de seguridad temp. desconexión 140°C 1 polos 1CO 16A sonda ø 5mm sonda L 96mm capilar 990mm aislamiento del capilar 880mm prensaestopos bulbo cobre		
Para modelos:	B1011b, B1221b, B2011b, B2021b, B611b, O1011b, O1221b, O2011b, O2021b, O611b		



1

código	390923	referencia	EA04-0012
descripción	termostato de seguridad temp. desconexión 365°C margen de trabajo°C 1 polos 1CO 16A sonda ø 4mm sonda L 107mm capilar 1190mm aislamiento del capilar 1015mm prensaestopas eje ømm unión roscada M14x1		
Para modelos:	B1011b, B1011i, B1221b, B1221i, B2011b, B2011i, B2021b, B2021i, B611b, B611i, B623i, O1011b, O1011i, O1221b, O1221i, O2011b, O2011i, O2021b, O2021i, O611b, O611i, O623i		

23x19mm



1

código	347948	referencia	EA01-0001
descripción	interruptor magnético L 23mm An 19mm 1NC empalme cable longitud del cable 700mm 700W		

interruptores y pulsadores

interruptores magnéticos

23x14mm

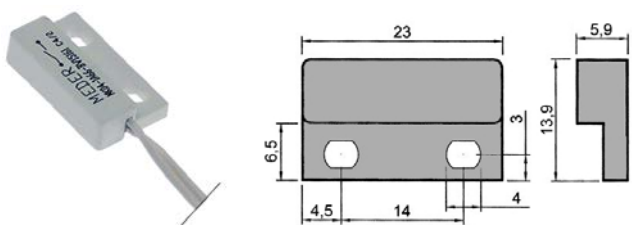

1

código	347995	referencia	EA01-0015
descripción	interruptor magnético L 23mm An 14mm 1NO 180V 0.5A P máx. 10W empalme cable longitud del cable 500mm		
Para modelos:	B1011b, B1011i, B611b, B611i, B623i, O1011b, O1011i, O611b, O611i, O623i		

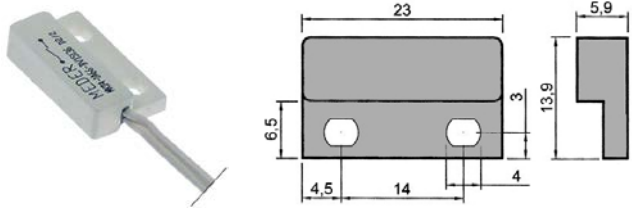

1

código	347994	referencia	EA01-0015
descripción	interruptor magnético L 23mm An 14mm 1NO 180V 0.5A P máx. 10W empalme cable longitud del cable 700mm		

lámparas

lámpade

lámparas halógenas

para portalámpara G4 / G6,35 / G9



1

código	357193	referencia	EA13-0100
descripción	lámpara halógena casquillo G4 12V 20W resis.a la temp. 300°C OSRAM HALOSTAR OVEN		



1

código	359599	referencia	EA13-0100
descripción	lámpara halógena casquillo G4 12V 20W resis.a la temp. 500°C		
Para modelos:	B1011b, B1011i, B1221b, B1221i, B2011b, B2011i, B2021b, B2021i, B611b, B611i, B623i, O1011b, O1011i, O1221b, O1221i, O2011b, O2011i, O2021b, O2021i, O611b, O611i, O623i		

lámparas para hornos

lámparas de horno específicas del fabricante

RETIGO



1

código	357182	referencia	AX07-0001	
descripción	cristal de lámpara ø 37mm espesor 3mm			
accesorios para	357182			
	código	357183	referencia	AX07-0002
	junta grafito ø 37mm int.ø 31mm espesor 1.5mm para portalámparas			

			
1			
código	357183	referencia	AX07-0002
descripción	junta grafito ø 37mm int.ø 31mm espesor 1.5mm para portalámparas		
accesorios para	357183		
	código	357182	referencia AX07-0001
	cristal de lámpara ø 37mm espesor 3mm		

			
1			
código	359922	referencia	EA13-0101
descripción	portalámparas con sujeción de 2 orificios 25V casquillo G4 empalme cable 140mm ø 17mm H 10mm distancia de sujeción 11.5mm material de cable silicona		
Para modelos:	B1011b, B1011i, B1221b, B1221i, B2011b, B2011i, B2021b, B2021i, B611b, B611i, B623i, O1011b, O1011i, O1221b, O1221i, O2011b, O2011i, O2021b, O2021i, O611b, O611i, O623i		

			
1			
código	680001	referencia	AX07-0004
descripción	cristal de lámpara ø 69mm espesor 2.9mm		
Para modelos:	B1011b, B1011i, B1221b, B1221i, B2011b, B2011i, B2021b, B2021i, B611b, B611i, B623i, O1011b, O1011i, O1221b, O1221i, O2011b, O2011i, O2021b, O2021i, O611b, O611i, O623i		

			
1			
código	680000	referencia	AX07-0005 AX07-0006
descripción	junta goma ø 92mm int.ø 58mm espesor 7.6mm iluminación de cámara de cocción apto para RETIGO		
Para modelos:	B1011b, B1011i, B1221b, B1221i, B2011b, B2011i, B2021b, B2021i, B611b, B611i, B623i, O1011b, O1011i, O1221b, O1221i, O2011b, O2011i, O2021b, O2021i, O611b, O611i, O623i		

			
1			
código	359922	referencia	EA13-0101
descripción	portalámparas con sujeción de 2 orificios 25V casquillo G4 empalme cable 140mm ø 17mm H 10mm distancia de sujeción 11.5mm material de cable silicona		
Para modelos:	B1011b, B1011i, B1221b, B1221i, B2011b, B2011i, B2021b, B2021i, B611b, B611i, B623i, O1011b, O1011i, O1221b, O1221i, O2011b, O2011i, O2021b, O2021i, O611b, O611i, O623i		

lámparas			
lámparas halógenas			
para portalámpara G4 / G6,35 / G9			
			
1			
código	357193	referencia	EA13-0100
descripción	lámpara halógena casquillo G4 12V 20W resis.a la temp. 300°C OSRAM HALOSTAR OVEN		

			
1 500°C			
código	359599	referencia	EA13-0100
descripción	lámpara halógena casquillo G4 12V 20W resis.a la temp. 500°C		
Para modelos:	B1011b, B1011i, B1221b, B1221i, B2011b, B2011i, B2021b, B2021i, B611b, B611i, B623i, O1011b, O1011i, O1221b, O1221i, O2011b, O2011i, O2021b, O2021i, O611b, O611i, O623i		

señalizadores de alarma

altavoces			
			
1			
código	350208	referencia	AA11-9903
descripción	altavoz ø 50mm profundidad de montaje 15mm 8Ohm 0.5W empalme conector longitud del cable 1360mm		

			
1			
código	350209	referencia	AA11-9904
descripción	altavoz ø 50mm profundidad de montaje 15mm 8Ohm 0.5W empalme conector longitud del cable 1740mm		

			
1			
código	350207	referencia	AA11-9902
descripción	altavoz ø 50mm profundidad de montaje 16mm 8Ohm 0.5W empalme conector longitud del cable 340mm		



			
1			
código	350211	referencia	EA13-0151
descripción	altavoz ø 50mm profundidad de montaje 16mm 80hm 0.5W empalme conexión para soldadura longitud del cable mm		
Para modelos:	B1011b, B1011i, B1221b, B1221i, B2011b, B2011i, B2021b, B2021i, B611b, B611i, B623i, O1011b, O1011i, O1221b, O1221i, O2011b, O2011i, O2021b, O2021i, O611b, O611i, O623i		

			
1			
código	380976	referencia	EA02-0003
descripción	contactor de potencia AC1 32A 230VAC (AC3/400V) 18A/7,5kW contactos principales 3NO contactos auxiliares 1NO/1NC empalme empalme atornillado		

contactores

TELEMECANIQUE (Schneider Electric)

contactores de potencia

			
1			
código	381010	referencia	EA02-0002
descripción	contactor de potencia AC1 20A 230VAC (AC3/400V) 6A/2,2kW contactos principales 2x3NO contactos auxiliares 2x1NO empalme empalme atornillado tipo LC2K0610P7		
Para modelos:	O1011b, O1011i, O1221b, O1221i, O2011b, O2011i, O2021b, O2021i, O611b, O611i		

			
1			
código	380979	referencia	EA02-0004
descripción	contactor de potencia AC1 40A 230VAC (AC3/400V) 25A/11kW contactos principales 3NO contactos auxiliares 1NO/1NC empalme empalme atornillado tipo LC1D25P7		
Para modelos:	B1011b, B1011i, B611b, B611i, O1011b, O1011i, O611b, O611i		

			
1			
código	380965	referencia	EA02-0001
descripción	contactor de potencia AC1 20A 230VAC (AC3/400V) 6A/2,2kW contactos principales 3NO contactos auxiliares 1NO empalme empalme atornillado tipo LC1K0610P7+		
Para modelos:	B623i, O623i		

			
1			
código	380982	referencia	EA02-0006
descripción	contactor de potencia AC1 80A 230VAC (AC3/400V) 50A/22kW contactos principales 3NO contactos auxiliares 1NO/1NC empalme empalme atornillado tipo LC1D50P7		
Para modelos:	B1221b, B1221i, B2011b, B2011i, B2021b, B2021i, O1221b, O1221i, O2011b, O2011i, O2021b, O2021i		



semiconductores de potencia

CELDUC



1

código	402974	referencia	EA02-0203 EA02-203
descripción	semiconductor de potencia CELDUC fases 2 carga 50A carga 24-600V 10-30VDC L 58mm An 45mm conector atornillado tipo SOB965660		
Para modelos:	B1011b, B1011i, B1221b, B1221i, B2011b, B2011i, B2021b, B2021i, B611b, B611i, B623i, O1011b, O1011i, O1221b, O1221i, O2011b, O2011i, O2021b, O2021i, O611b, O611i, O623i		

láminas térmicas



1



código	403355	referencia	EA02-0204
descripción	lámina térmica L 37mm An 37mm		

relés

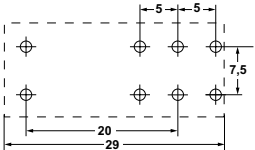
relés enchufables/para circuito impreso

1

código	380333	referencia	EA01-0104
descripción	relé para circuito impreso 230VAC 2CO a 250 V 8A empalme pins medida reticular 5mm FINDER N° fabricante 40.52.8.230.0000 95.65/95.75		
accesorios para	380333		
	código	380340	referencia —
	zócalo de relé medidas 62x36x15mm 250V tensión AC 10A Italiana Relè N° fabricante ZMEM/5		
	código	380505	referencia —
	zócalo de relé 2CO 40.52 medidas 81,9x15,5x75mm 250V tensión AC 10A FINDER N° fabricante 95.95.3		
	código	381181	referencia —
	zócalo de relé 2 polos 40.51/40.52/40.61 empalme borne roscado medidas 15,8x78,6mm 250V tensión AC 10A FINDER N° fabricante 95.75		

portarelés

1

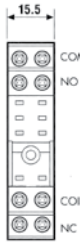
código	381241	referencia	EA13-0103
descripción	zócalo de relé riel DIN empalme atornillado medidas 80x46x15mm 300V tensión AC 10A FINDER N° fabricante 95.85.3 95.85.3		

transformadores

transformadores con núcleo toroidal



1

código	403333	referencia	EA13-0010
descripción	transformador primaria 230VAC secundaria 11,5VAC 20VA empalme cable 200mm 50Hz tipo toroidal limitación de temperatura 120°C temperatura ambiente máx. 40°C		
Para modelos:	B623i, O623i		



1

código	403336	referencia	EA13-0011
descripción	transformador primaria 230VAC secundaria 11,5VAC 40VA empalme cable 200mm 50Hz		
Para modelos:	B1011b, B1011i, B611b, B611i, O1011b, O1011i, O611b, O611i		



1

código	403340	referencia	EA13-0009
descripción	transformador primaria 230VAC secundaria 11,5VAC 63VA empalme cable 200mm 50Hz tipo toroidal		
Para modelos:	B1221b, B1221i, B2011b, B2011i, B2021b, B2021i, O1221b, O1221i, O2011b, O2011i, O2021b, O2021i		



transformadores encapsulados

con empalme atornillado



código	403352	referencia	EA13-0008
descripción	transformador primaria 230VAC secundaria 17VAC 20VA secundaria 1.17A empalme atornillado 50-60Hz tipo 704077 riel DIN limitación de temperatura 125°C temperatura ambiente máx. 40°C		
Para modelos:	B1011b, B1011i, B1221b, B1221i, B2011b, B2011i, B2021b, B2021i, B611b, B611i, B623i, O1011b, O1011i, O1221b, O1221i, O2011b, O2011i, O2021b, O2021i, O611b, O611i, O623i		

sensores

sensores específicos del fabricante

sensores



código	378350	referencia	EA10-0006
descripción	sensor de temperatura Pt100 cable silicona sonda -100 a 450°C cable -50 a +180°C empalme conector rosca bulbo ø4,5x25mm longitud de cable 1.5m		



código	378348	referencia	EA10-0007
descripción	sensor de temperatura Pt100 cable silicona sonda -100 a 450°C cable -50 a +180°C empalme conector rosca M10x1,5 bulbo ø6x30mm longitud de cable 1.5m		



código	381239	referencia	EA10-0104
descripción	sensor de temperatura termopar K (NiCr-Ni) cable PTFE sonda -50 a 1150°C cable -40 a +250°C empalme conector codificado rosca bulbo ø2x4mm longitud de cable 1.5m		
Para modelos:	B1011b, B1011i, B1221b, B1221i, B2011b, B2021b, B611b, B611i, B623i, O1011b, O1011i, O1221b, O1221i, O2011b, O2021b, O611b, O611i, O623i		



código	381240	referencia	EA10-0105
descripción	sensor de temperatura termopar K (NiCr-Ni) cable PTFE sonda -50 a 1150°C cable -40 a +250°C empalme conector codificado rosca bulbo ø2x7mm longitud de cable 2m		
Para modelos:	B2011b, B2011i, B2021b, B2021i, O2011b, O2011i, O2021b, O2021i		



código	381238	referencia	EA10-0103
descripción	sensor de temperatura termopar K (NiCr-Ni) cable silicona sonda -50 a 1150°C cable -50 a +180°C empalme conector codificado rosca bulbo ø1,9x140mm longitud de cable 1.4m		
Para modelos:	B1011b, B1011i, B1221b, B1221i, B2011b, B2011i, B2021b, B2021i, B611b, B611i, B623i, O1011b, O1011i, O1221b, O1221i, O2011b, O2011i, O2021b, O2021i, O611b, O611i, O623i		

sondas al corazón



código	378349 ¹	referencia	EA10-0069
descripción	sensor al corazón Pt100 cable PTFE sonda -40 a +250°C cable -40 a +250°C empalme conector codificado bulbo ø4,5x125mm rosca M12x1,75 longitud de cable 1m asidero ø 14mm longitud de asidero 58mm		

¹sensor multipunto

código	378359	referencia	EA10-0055
descripción	sensor al corazón Pt100 cable PTFE sonda -40 a +250°C cable -40 a +250°C empalme conector codificado bulbo ø4x115mm rosca M12x1,75 longitud de cable 1.5m asidero ø 14mm longitud de asidero 58mm		

1



código	378677	referencia	EA10-0058
descripción	sensor al corazón Pt100 cable PTFE sonda -40 a +250°C cable -40 a +250°C empalme conector codificado bulbo ø4x125mm rosca M12x1,75 longitud de cable 0.8m asidero ø 14mm longitud de asidero 58mm		

1



código	381237	referencia	EA10-0111 EA10-0116
descripción	sensor al corazón termopar K (NiCr-Ni) cable PTFE sonda -40 a +250°C cable -40 a +250°C empalme conector codificado bulbo ø3,9x170mm rosca M16x2 longitud de cable 1.4m asidero ømm longitud de asidero 50mm		
Para modelos:	O1011b, O1011i, O611b, O611i, O623i		

1



código	381234 ¹	referencia	EA10-0113 EA10-0118
descripción	sensor al corazón termopar K (NiCr-Ni) cable PTFE sonda -40 a +250°C cable -40 a +250°C empalme conector codificado bulbo ø3,9x170mm rosca M16x2 longitud de cable 1.4m asidero ømm longitud de asidero 50mm		
Para modelos:	B1011b, B1011i, B611b, B611i, B623i		

¹sensor multipunto

1



código	381235 ¹	referencia	EA10-0119
descripción	sensor al corazón termopar K (NiCr-Ni) cable PTFE sonda -40 a +250°C cable -40 a +250°C empalme conector codificado bulbo ø3,9x170mm rosca M16x2 longitud de cable 1.8m asidero ømm longitud de asidero 50mm		

¹sensor multipunto



1	código	381236	referencia	EA10-0117
descripción	sensor al corazón termopar K (NiCr-Ni) cable PTFE sonda -40 a +250°C cable -40 a +250°C empalme conector codificado bulbo ø3,9x170mm rosca M16x2 longitud de cable 2.1m asidero ømm longitud de asidero 50mm			

electrónicas

convertidores de frecuencia

accesorios



1	código	403356	referencia	EA16-0041
descripción	resistencia de frenado para convertidor de frecuencia L 78mm An 29mm H 16mm 20-60W longitud del cable 170mm VW3TR342150R 150Ohm			
Para modelos:	B1011b, B1011i, B1221b, B1221i, B2011b, B2011i, B2021b, B2021i, B611b, B611i			

placas electrónicas

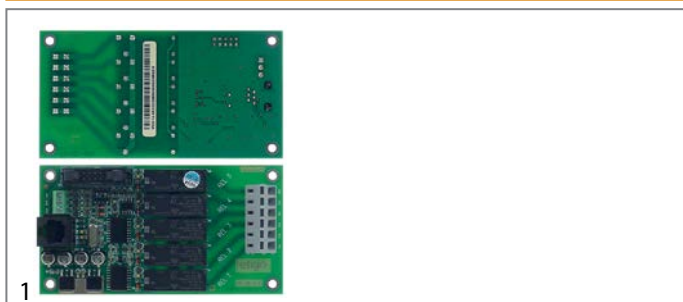

1	código	403936	referencia	EA14-0032
descripción	controlador electrónico para sistema de limpieza L 112mm An 60mm			

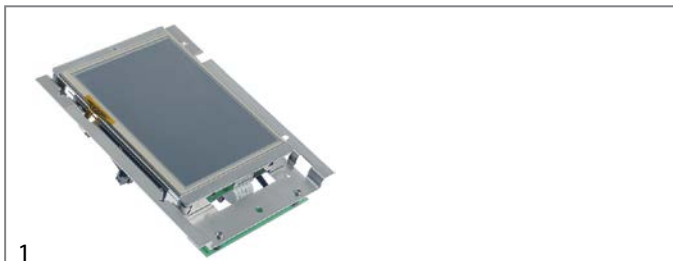

1	código	404013	referencia	XC10-2000
descripción	display horno a vapor combinado Blue FreeScale2011 L 170mm An 130mm para RETIGO modelo XC10-2000-10 con control H 50mm tipo azul			
Para modelos:	B1011b, B1011i, B1221b, B1221i, B2011b, B2011i, B2021b, B2021i, B611b, B611i, B623i			



1	código	403937	referencia	EA14-0041
descripción	display horno a vapor combinado L 95mm An 72mm			

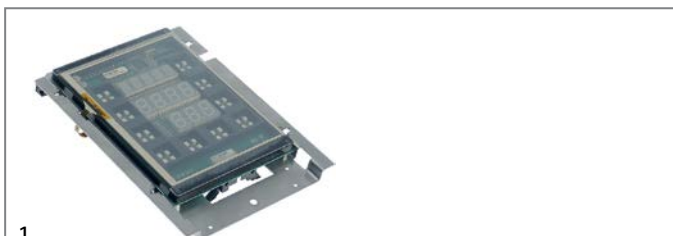

1	código	404012	referencia	XC10-2100
descripción	display horno a vapor combinado Orange FreeScale 2011 L 17mm An 13mm modelo XC10-2100 con control H 50mm tipo naranja			
Para modelos:	O1011b, O1011i, O1221b, O1221i, O2011b, O2011i, O2021b, O2021i, O611b, O611i, O623i			

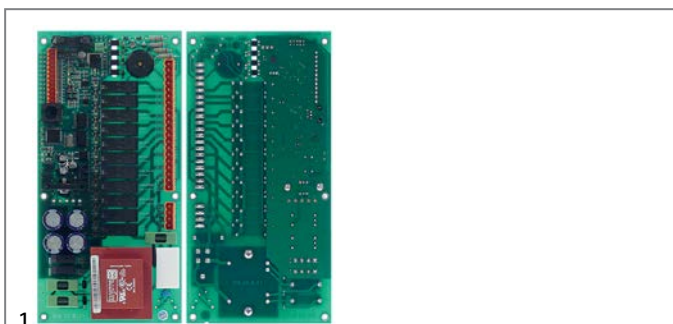

1	código	403938	referencia	EA14-0043
descripción	placa de potencia horno a vapor combinado L 230mm An 115mm			

1

código	404014	referencia	EA14-0080
descripción	placa de relés horno a vapor combinado B1011/B2011 L 200mm An 115mm modelo RP20B.15 con cable de cinta plana H 30mm		
Para modelos:	B1011b, B1011i, B1221b, B1221i, B2011b, B2011i, B2021b, B2021i, B611b, B611i, B623i, O1011b, O1011i, O1221b, O1221i, O2011b, O2011i, O2021b, O2021i, O611b, O611i, O623i		



1

código	404029	referencia	EA14-0014
descripción	placa de relés horno a vapor combinado L 112mm An 47mm		

válvulas magnéticas

válvulas magnéticas agua

ROBERTSHAW/INVENSYS

temperatura líquido: 90°C 90°C 60°C
 temperatura ambiente: 60°C 25°C 60°C
 ciclo de trabajo: 40% 100% 100%



1

código	372021	referencia	EA12-0050
descripción	válvula magnética doble recto 230VAC entrada 3/4" salida 11,5mm DN10 EATON (INVENSYS)		
Para modelos:	B1011b, B1011i, B611b, B611i, B623i, O1011b, O1011i, O1221b, O1221i, O2011b, O2011i, O2021b, O2021i, O611b, O611i, O623i		





1

código	372003	referencia	EA12-0051
descripción	válvula magnética simple recto 230VAC entrada 3/4" salida 10mm DN10 EATON (INVENSYS)		
Para modelos:	O623i		



1

código	372018	referencia	EA12-0050	
descripción	válvula magnética simple recto 230VAC entrada 3/4" salida 14mm DN10 EATON (INVENSYS) reducción salida reducción entrada A blanco			
repuestos para	372018			
	código	371122	referencia	—
	filtro de válvula magnética ø 19mm H 10mm apto para MÜLLER			
	código	371131	referencia	—
	bobina magnética 230VAC			



1

código	372025	referencia	EA12-0056
descripción	válvula magnética triple recto 230VAC entrada 3/4" salida 11,5mm DN10 EATON (INVENSYS)		
Para modelos:	B1011b, B1011i, B1221b, B1221i, B2011b, B2011i, B2021b, B2021i, B611b, B611i, O1221b, O1221i, O2011b, O2011i, O2021b, O2021i		

RPE

reducciones

salida



1

código	371247	referencia	EA12-0303
descripción	reducción RPE velocidad de flujo 1-1,25l/min blanco		
Para modelos:	B1011b, B1011i, B1221b, B1221i, B2011b, B2021b, B2021i, B611b, B611i, O1011b, O1011i, O1221b, O1221i, O2011b, O2021b, O2021i, O611b, O611i		

electródos



1

código	403353	referencia	AC24-0602
descripción	electrodo de nivel a presión longitud total 225mm sonda L 185mm largo del bulbo asilado 170mm triple empalme conector redondo ø 15mm nivel para RETIGO para 611/1011/1221/2011 edición calentador de agua		
Para modelos:	B1011b, B1221b, B2011b, B2021b, B611b, O1011b, O1221b, O2011b, O2021b, O611b		



			
código	403295	referencia	AC24-0101
descripción	electrodo de nivel M16x1 longitud total 205mm sonda L 148mm largo del bulbo asilado 8mm empalme de tres hilos longitud del cable 40mm		

			
código	694686	referencia	EA05-0203
descripción	cable de conexión de motor para motor de aire caliente blindado conductor 3PH/PE L 900mm L 1.3m para modelo 2011 ø ext. 8.5mm UE 2 pzs		

ventiladores

ventilador axial

			
código	601909 ¹	referencia	ZA21-0007
descripción	ventilador axial L 119mm An 119mm H 38mm 220-240 50/60Hz 31/29W cojinete rodamiento de bolas empalme conector Faston 2,8mm		
Para modelos:	B1011b, B1011i, B1221b, B1221i, B2011b, B2011i, B2021b, B2021i, B611b, B611i, B623i, O1011b, O1011i, O1221b, O1221i, O2011b, O2011i, O2021b, O2021i, O611b, O611i, O623i		

			
código	551259	referencia	AX00-0006
descripción	junta junta de árbol de motor int.ø 16.5mm ø ext. 29mm espesor 4.2mm		
Para modelos:	B1011b, B1011i, B1221b, B1221i, B2011b, B2011i, B2021b, B2021i, B611b, B611i, O1011b, O1011i, O1221b, O1221i, O2011b, O2011i, O2021b, O2021i, O611b, O611i		

			
código	551261	referencia	AX00-0011
descripción	junta junta de árbol de motor int.ø 8.5mm ø ext. 20mm		
Para modelos:	B623i, O623i		

¹con rodamiento de bolas

motores de aire caliente

			
código	694684	referencia	EA05-0201
descripción	cable de conexión de motor para motor de aire caliente blindado conductor 3PH/PE L 1040mm para modelo 6011, 1011 ø ext. 8.5mm		

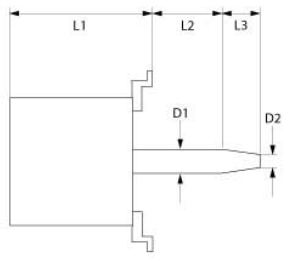
 			
código	499311	referencia	AA11-0016 EA11-0014 EA11-14
descripción	motor de ventilador 440V fases 3 50Hz 0.3kW 1410rev/min velocidades 1 L1 130mm L2 22mm L3 38mm M10 1,2/0,7A a 50 Hz 1410rev/min D1 ø 17mm D2 ø 13.5mm		
Para modelos:	B1011b, B1011i, B1221b, B1221i, B2011b, B2011i, B2021b, B2021i, B611b, B611i, O1011b, O1011i, O1221b, O1221i, O2011b, O2011i, O2021b, O2021i, O611b, O611i		

			
código	694685	referencia	EA05-0202
descripción	cable de conexión de motor para motor de aire caliente blindado conductor 3PH/PE L 600mm para modelo 1221 ø ext. 8.5mm UE 2 pzs		



1

código	602002	referencia	AX09-0004
descripción	rodete ventilador D1 ø 175mm H1 38.5mm palas 9 D2 ø 8mm D3 ø 8mm H2 10mm H3 12mm		
Para modelos:	B623i, O623i		



1

código	602000	referencia	AX09-0006
descripción	rodete ventilador D1 ø 320mm H1 110mm palas 12 D2 ø 13mm D3 ø 16.4mm H2 12mm H3 18mm		
Para modelos:	B1221b, B1221i, B2021b, B2021i, O1221b, O1221i, O2021b, O2021i		



1

código	602001	referencia	AX09-0001
descripción	rodete ventilador D1 ø 320mm H1 83mm palas 12 D2 ø 13mm D3 ø 16.4mm H2 12mm H3 18mm		
Para modelos:	B1011b, B1011i, B2011b, B2011i, B611b, B611i, O1011b, O1011i, O2011b, O2011i, O611b, O611i		

ventiladores de aire caliente

HANNING



1

código	601910	referencia	EA11-0004
descripción	ventilador de aire caliente 220-240V 125W 0,46/0,56A 3600rev/min L1 115mm L2 3mm L3 12mm L4 95mm rodete ventilador ø 100mm HANNING		
Para modelos:	B623i, O623i		

ventiladores radiales

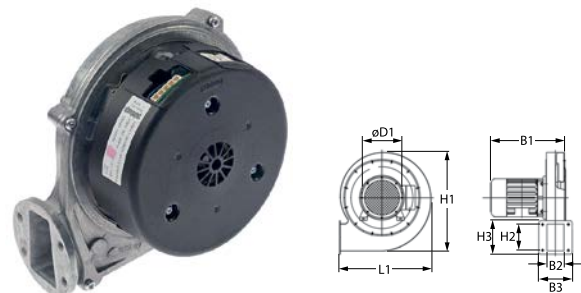

1

código	692477	referencia	ZA21-0008
descripción	ventilador radial 230V tensión AC 50Hz H1 150mm L1 170mm D1 ø 80mm B1 90mm B2 28mm H2 49mm B3 65mm H3 65mm		

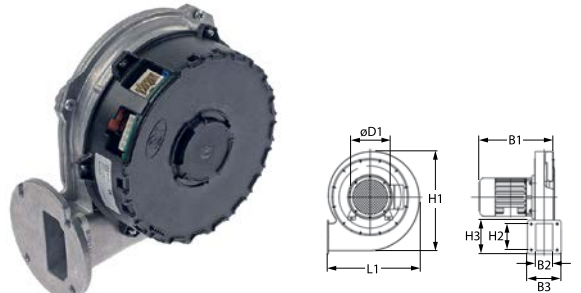

1

código	692478	referencia	ZA21-0009
descripción	ventilador radial 230V tensión AC 50Hz H1 165mm L1 170mm D1 ø 80mm B1 80mm B2 23mm H2 46mm B3 83mm H3 83mm		



motores

motorreductores

para hornos

para chimeneas



1

código	602072	referencia	AC25-0112/S AC25-0311/S
descripción	motorreductor 5W 220-240V tensión AC 50/60Hz 3/3,6rev/min árbol ømm L 84mm An 70mm H 54,4mm		

bombas

bombas de salida

HANNING



1

código	499328	referencia	EA10-0005 EA12-0005
descripción	bomba 25W 220-240V entrada ø 30mm salida ø 24mm 50Hz tipo DP020-028 HANNING		

accesorios

cubiertas de bomba



1

código	500303	referencia	ZA14-0105
descripción	cuerpo entrada ø 24mm salida ø 22mm apto para bomba de salida		
Para modelos:	B1221b, B1221i, B2011b, B2011i, B2021b, B2021i		

condensadores y filtros antiparasitarios

condensadores de servicio

metal



1

código	365191	referencia	EA13-0301
descripción	condensador de servicio capacidad 3µF 400V tolerancia 5% 60Hz temperatura ambiente máx. -40 a +85°C ø 30mm L 85mm M8 aluminio empalme cable 400mm MLR25L40303063		
Para modelos:	B623i, O623i		

filtros

filtros de red

con alojamiento



1

código	403358	referencia	EA13-0057
descripción	filtro de red tipo FC61113 400V 50-60Hz trifásico empalme cable longitud del cable 500mm montaje riel DIN		
Para modelos:	B1011b, B1011i, B611b, B611i, B623i, O1221b, O1221i, O2011b, O2011i, O2021b, O2021i, O623i		



1

código	403357	referencia	EA13-0058
descripción	filtro de red tipo FC61113b 400V 50-60Hz conductor 3 empalme cable 500mm L 70mm ømm H 34mm An 50mm riel DIN plástico UE 1 pzs		
Para modelos:	B1221b, B1221i, B2011b, B2011i, B2021b, B2021i, O1011b, O1011i, O611b, O611i		



1

código	365189	referencia	EA13-0109
descripción	filtro de red tipo SKY2FN3 230V 50-60Hz conductor 2 con T empalme borne con resorte L 90mm ømm H 40mm An 52mm riel DIN plástico UE 1 pzs		
Para modelos:	B1011b, B1011i, B1221b, B1221i, B2011b, B2011i, B2021b, B2021i, B611b, B611i		

			
1			
código	365190	referencia	EA13-0056
descripción	filtro de red tipo TS8111022B 250V 50-60Hz conductor 2 con T empalme cable 300mm L 41mm ømm H 38mm An 18mm riel DIN plástico UE 1 pzs		
Para modelos:	B1221b, B1221i, B2011b, B2011i, B2021b, B2021i, B623i, O1221b, O1221i, O2011b, O2011i, O2021b, O2021i, O623i		

			
1			
código	551257	referencia	EA07-1014
descripción	borne para placa de circuito impreso 14 polos máx. 1A máx. 240V medida reticular 3mm		

fusibles

contactores de protección de línea

			
1			
código	381233	referencia	EA03-0016
descripción	contactor de protección de línea 1 polo 6A característica de disparo D nominal 230/400V empalme atornillado montaje riel DIN fases 1		
Para modelos:	B1011b, B1011i, B1221b, B1221i, B2011b, B2011i, B2021b, B2021i, B611b, B611i, B623i, O623i		

			
1			
código	551255	referencia	EA07-1309
descripción	borne para placa de circuito impreso 9 polos máx. 16A máx. 400V medida reticular 5mm		

componentes electrónicos

varistores

			
1			
código	403354	referencia	EA05-0200
descripción	varistor		

			
1			
código	381232	referencia	EA03-0018
descripción	contactor de protección de línea 3 polos 6A característica de disparo D nominal 400V empalme atornillado montaje riel DIN fases 3		
Para modelos:	O1011b, O1011i, O1221b, O1221i, O2011b, O2011i, O2021b, O2021i, O611b, O611i		

válvulas de gas y centralitas de gas automáticas



válvulas de control de gas

accesorios eléctricos

terminales

bornes para placas de circuito impreso

			
1			
código	551256	referencia	EA07-1310
descripción	borne para placa de circuito impreso 10 polos máx. 16A máx. 400V medida reticular 5mm		

SIT			
SIGMA			
			
1			
código	106009	referencia	ZA12-0003
descripción	válvula de gas aliment. 230V 50Hz entrada gas 3/4" salida gas 3/4" margen de presión 0,5-12mbar Sigma núm. Ref. 0.848.037		
repuestos para	106009		
	código	106214	referencia
	 bobina magnética aliment. 230V 50Hz Sigma		
accesorios para	106009		
	código	107222	referencia
	 conector para válvula magnética 3 polos longitud del cable 1070mm		



centralitas de gas automáticas

BRAHMA

BRAHMA



1

código	103193	referencia	EA01-0203
descripción	centralita de gas automática BRAHMA tipo SM592N.2 electrodos 1 tiempo de espera 1.5s tiempo de seguridad 10s 230V 7VA 50-60Hz con pulsador reinicio		

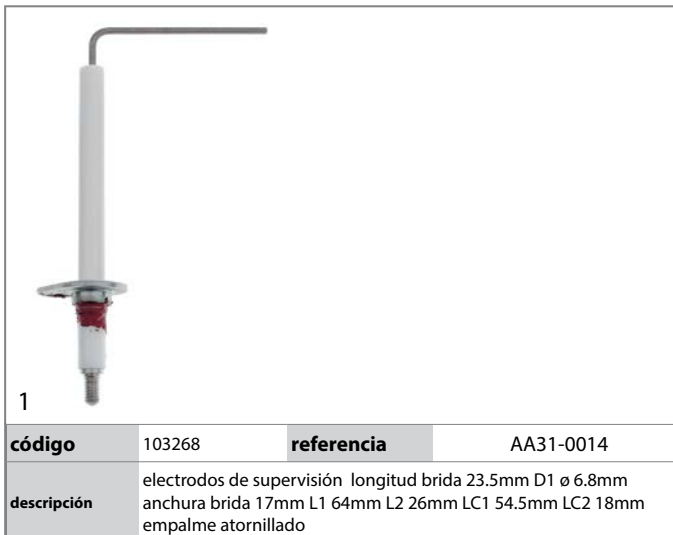

1

código	103268	referencia	AA31-0014
descripción	electrodos de supervisión longitud brida 23.5mm D1 ø 6.8mm anchura brida 17mm L1 64mm L2 26mm LC1 54.5mm LC2 18mm empalme atornillado		

encendidos y temopares

electródos

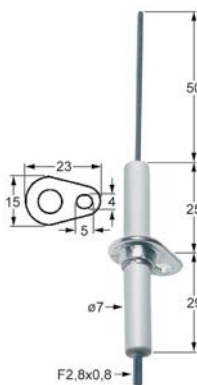

1

código	100711	referencia	AT31-0029
descripción	electrodo de encendido longitud brida 23mm anchura brida 15mm D1 ø 7mm L1 50mm LC1 25mm LC2 29mm empalme F 2,8x0,8mm medida de sujeción ø5x4mm con brida		

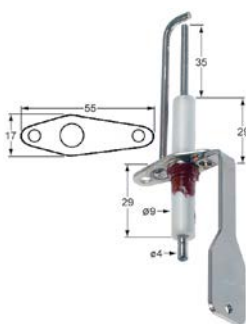

1

código	103191	referencia	AC31-0903
descripción	electrodo de encendido longitud brida 55mm anchura brida 17mm D1 ø 9mm L1 35mm LC1 29mm LC2 29mm ø empalme 4mm		

repuestos para	103191	código	692511	referencia	AX31-0044
-----------------------	--------	---------------	--------	-------------------	-----------

 junta para electrodo de encendido UE 1 RETIGO AC31-0903

accesorios para	103191	código	692511	referencia	AX31-0044
------------------------	--------	---------------	--------	-------------------	-----------

 junta para electrodo de encendido UE 1 RETIGO AC31-0903

cables de encendido

diversos



1

código	103192	referencia	EA05-0077
descripción	cable de encendido longitud del cable 880mm empalme conector redondo 3,6 1mm ² ø ext. 4.8mm aislam. PTFE conductor plateado blanco 0.150hm		

unidades de encendido

BRAHMA



1

código	103194	referencia	EA13-0013
descripción	grupo de encendido salidas 1 220-240VAC medidas 85x70x35mm distancia de sujeción 60mm entrada cable salida ø4mm tipo TC1SVCS 25VA 50/60Hz BRAHMA núm. Ref. 15911250		

quemadores de gas

quemadores para hornos a vapor combi-







1

código	104656	referencia	ZA22-0003		
descripción	quemador 38kW An 140mm L 315mm H 120mm				
repuestos para	104656	código	103191	referencia	AC31-0903
	electrodo de encendido longitud brida 55mm anchura brida 17mm D1 ø 9mm L1 35mm LC1 29mm LC2 29mm ø empalme 4mm				
	código	692509	referencia	AP31-0100	KP31-0100
marco para quemador RETIGO ZA22-0003 medida 320x136mm UE 1					

Continúa en la página siguiente



repuestos para	104656			
	código	692510	referencia	AT31-0047 ZA13-3040
	junta para quemador RETIGO ZA22-0003 UE 1m			
	código	692511	referencia	AX31-0044
	junta para electrodo de encendido UE 1 RETIGO AC31-0903			
accesorios para	104656			
	código	692509	referencia	AP31-0100 KP31-0100
	marco para quemador RETIGO ZA22-0003 medida 320x136mm UE 1			
	código	692510	referencia	AT31-0047 ZA13-3040
	junta para quemador RETIGO ZA22-0003 UE 1m			

para máquina de hielo en cubitos

tubos flexibles

tubos formados

recto

tubos de silicona



código	530062	referencia	ZA11-0805
descripción	tubo de silicona int.ø 16mm ø ext. 23mm L 1m T máx 200°C transparente		

unidades de salida

accesorios



código	694681	referencia	AC02-2202
descripción	filtro de desperdicios ø ext. 118mm H 13.5mm soporte de muelle inox		
Para modelos:	B1011b, B1011i, B1221b, B1221i, B2011b, B2011i, B2021b, B2021i, B611b, B611i, B623i, O1011b, O1011i, O1221b, O1221i, O2011b, O2011i, O2021b, O2021i, O611b, O611i, O623i		

tuberías de vapor



código	530920	referencia	ZA10-0500
descripción	manguera de vapor silicona L 68mm int.ø 38mm ø ext. 46mm para horno a vapor combinado generador de vapor		

boquillas de inyección



código	542109	referencia	AT00-0056
descripción	boquilla taladro ø 0.7mm D1 ø 12mm latón 07 TYC D12-8		
Para modelos:	B1011i, B1221i, B2011i, B2021i, B611i, B623i, O1011i, O1221i, O2011i, O2021i, O611i, O623i		

tubos de inyección



código	692480	referencia	AC12-0800
descripción	tubo de inyección L 185mm H 45mm int.ø 12mm ø ext. 8mm		
Para modelos:	B623i, O623i		



código	692483	referencia	AC12-1100
descripción	tubo de inyección L 190mm H 125mm int.ø 8mm ø ext. 12mm		



código	692484	referencia	AC12-0900 AC12-1300
descripción	tubo de inyección L 235mm H 130mm int.ø 8mm ø ext. 12mm		
Para modelos:	B1221b, B1221i, O1221b, O1221i		

2 componentes gas



1

código	692482	referencia	AC12-0700
descripción	tubo de inyección L 243mm H 115mm int.ø 8mm ø ext. 12mm		
Para modelos:	B1011b, B1011i, B2011b, B2011i, B611b, B611i, O1011b, O1011i, O2011b, O2011i, O611b, O611i		



1

código	692485	referencia	AC12-1000
descripción	tubo de inyección L 300mm H 135mm int.ø 10mm ø ext. 12mm		
Para modelos:	B2021b, B2021i, O2021b, O2021i		



1

código	696859	referencia	AC12-0100
descripción	tubo de inyección para horno a vapor combinado ø ext. 10mm int.ø 6mm L 250mm		

paneles frontales





1

código	694705	referencia	AC21-1406/S/CH1
descripción	panel frontal para horno a vapor combinado L 1580mm An 190mm H 60mm inox con accesorios RETIGO		
Para modelos:	O2011b, O2011i		





1

código	694704	referencia	AC21-1506/S/CH1
descripción	panel frontal para horno a vapor combinado L 530mm An 190mm H 60mm inox con accesorios RETIGO		
Para modelos:	O623i		
accesorios para	694704		
	código	360594	referencia EA05-0052
cable USB A montaje fijación atornillada casquillo 1.5m			
	código	360607	referencia AX21-0001+AX21-
cubierta USB plástico A montaje fijación atornillada casquillo gris			





1

código	694703	referencia	AC21-1206/S/CH1
descripción	panel frontal para horno a vapor combinado L 700mm An 190mm H 60mm inox con accesorios RETIGO		
Para modelos:	O611b, O611i		
accesorios para	694703		
	código	360594	referencia EA05-0052
	cable USB A montaje fijación atornillada casquillo 1.5m		
	código	360607	referencia AX21-0001+AX21-
	cubierta USB plástico A montaje fijación atornillada casquillo gris		



1

código	694702	referencia	AC21-1205/S/CH1
descripción	panel frontal para horno a vapor combinado L 700mm An 190mm H 60mm inox con accesorios RETIGO para pantalla táctil		
Para modelos:	B611b, B611i		
accesorios para	694702		
	código	360594	referencia EA05-0052
	cable USB A montaje fijación atornillada casquillo 1.5m		

accesorios para	694702		
	código	360607	referencia AX21-0001+AX21-
	cubierta USB plástico A montaje fijación atornillada casquillo gris		
	código	404013	referencia XC10-2000
	display horno a vapor combinado Blue FreeScale2011 L 170mm An 130mm para RETIGO modelo XC10-2000-10 con control H 50mm tipo azul		

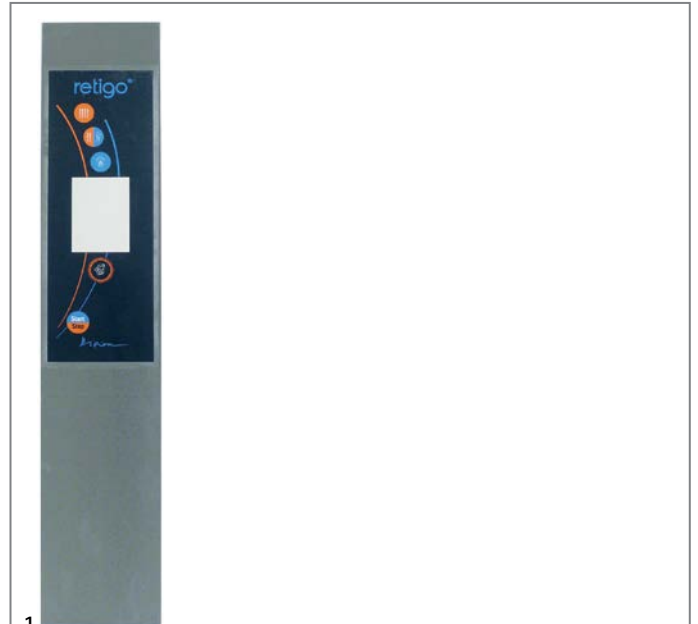

1

código	694770	referencia	AC21-1305/S/CH1
descripción	panel frontal para horno a vapor combinado L 960mm An 190mm H 60mm inox con accesorios RETIGO para pantalla táctil		
Para modelos:	B1011b, B1011i		



1

código	694771	referencia	AC21-1306/CH1
descripción	panel frontal para horno a vapor combinado L 960mm An 190mm H 60mm inox con accesorios RETIGO sin pantalla táctil		
Para modelos:	O1011b, O1011i		

sistema de limpieza

boquillas



1

código	694682	referencia	AA32-0050 AT32-0052
descripción	boquilla agujero ø 6.45mm H 17.8mm metal ø ext. 52mm int.ø 44.6mm		
Para modelos:	B1011b, B1011i, B1221b, B1221i, B2011b, B2011i, B2021b, B2021i, B611b, B611i, B623i		

tubos flexibles



1

código	530920	referencia	ZA10-0500
descripción	manguera de vapor silicona L 68mm int.ø 38mm ø ext. 46mm para horno a vapor combinado generador de vapor		



1

código	698469	referencia	ATOO-0006
descripción	tubo flexible int.ø 48mm ø ext. 54mm L 83mm		

macánica de puertas

accesorios



1

código	694683	referencia	AX03-0076
descripción	tope ø 14mm goma int.ø 7.5mm H 14mm		
Para modelos:	B1011b, B1011i, B1221b, B1221i, B2011b, B2011i, B2021b, B2021i, B611b, B611i, B623i, O1011b, O1011i, O1221b, O1221i, O2011b, O2011i, O2021b, O2021i, O611b, O611i, O623i		



1

código	694680	referencia	ZA13-0516
descripción	tope ø 22.25mm goma int.ø 14.75mm H 7.3mm		
Para modelos:	B1011b, B1011i, B611b, B611i, B623i, O1011b, O1011i, O611b, O611i, O623i		

intercambiadores de calor



1

código	692505	referencia	AC31-1700 AC31-4600
---------------	--------	-------------------	------------------------

descripción	intercambiador térmico para horno a vapor combinado RETIGO modelo 1011		
--------------------	--	--	--

accesorios para	692505		
------------------------	--------	--	--



código	103191	referencia	AC31-0903
descripción	electrodo de encendido longitud brida 55mm anchura brida 17mm D1 ø 9mm L1 35mm LC1 29mm LC2 29mm ø empalme 4mm		



código	103268	referencia	AA31-0014
descripción	electrodos de supervisión longitud brida 23.5mm D1 ø 6.8mm anchura brida 17mm L1 64mm L2 26mm LC1 54.5mm LC2 18mm empalme atornillado		



código	692515	referencia	AX31-0043
descripción	junta para intercambiador térmico UE 1 MICA		



código	692516	referencia	KP31-0049
descripción	junta para intercambiador térmico latón para modelo UE 1		



código	692518	referencia	AX31-0011
descripción	junta UE 1 silicona		



1

código	692550	referencia	AC31-3850
---------------	--------	-------------------	-----------

descripción	intercambiador térmico para horno a vapor combinado RETIGO modelo 2011 L 2040mm corto		
--------------------	---	--	--

accesorios para	692550		
------------------------	--------	--	--





código	103191	referencia	AC31-0903
descripción	electrodo de encendido longitud brida 55mm anchura brida 17mm D1 ø 9mm L1 35mm LC1 29mm LC2 29mm ø empalme 4mm		









código	103268	referencia	AA31-0014
descripción	electrodos de supervisión longitud brida 23.5mm D1 ø 6.8mm anchura brida 17mm L1 64mm L2 26mm LC1 54.5mm LC2 18mm empalme atornillado		

Continúa en la página siguiente



accesorios para	692550		
	código	692515	referencia AX31-0043
	junta para intercambiador térmico UE 1 MICA		
	código	692516	referencia KP31-0049
	junta para intercambiador térmico latón para modelo UE 1		
	código	692518	referencia AX31-0011
	junta UE 1 silicona		

	código	692551	referencia AC31-3750
	descripción intercambiador térmico para horno a vapor combinado RETIGO modelo 2011 L 2500mm LANG		
accesorios para	692551		
	código	103191	referencia AC31-0903
	electrodo de encendido longitud brida 55mm anchura brida 17mm D1 ø 9mm L1 35mm LC1 29mm LC2 29mm ø empalme 4mm		
	código	103268	referencia AA31-0014
	electrodos de supervisión longitud brida 23.5mm D1 ø 6.8mm anchura brida 17mm L1 64mm L2 26mm LC1 54.5mm LC2 18mm empalme atornillado		
	código	692515	referencia AX31-0043
	junta para intercambiador térmico UE 1 MICA		
	código	692516	referencia KP31-0049
	junta para intercambiador térmico latón para modelo UE 1		
	código	692518	referencia AX31-0011
	junta UE 1 silicona		

	código	692506	referencia AC31-1800 AC31-4700
	descripción intercambiador térmico para horno a vapor combinado RETIGO modelo 611		

otros



código	692548	referencia	20 AISI 316L AC31-4000
descripción	cámara de quemador RETIGO L 480mm An 160mm H 230mm completo, pero sin juntas 20 AISI 316L		
accesorios para	692548		
	código	103191	referencia AC31-0903
	electrodo de encendido longitud brida 55mm anchura brida 17mm D1 ø 9mm L1 35mm LC1 29mm LC2 29mm ø empalme 4mm		
	código	103268	referencia AA31-0014
	electrodos de supervisión longitud brida 23.5mm D1 ø 6.8mm anchura brida 17mm L1 64mm L2 26mm LC1 54.5mm LC2 18mm empalme atornillado		
	código	692515	referencia AX31-0043
	junta para intercambiador térmico UE 1 MICA		
	código	692516	referencia KP31-0049
	junta para intercambiador térmico latón para modelo UE 1		
	código	692518	referencia AX31-0011
	junta UE 1 silicona		
	código	692550	referencia AC31-3850
	intercambiador térmico para horno a vapor combinado RETIGO modelo 2011 L 2040mm corto		
	código	692551	referencia AC31-3750
	intercambiador térmico para horno a vapor combinado RETIGO modelo 2011 L 2500mm LANG		



1

código	692508	referencia	AC31-5000 AC31-5100
descripción	cámara de quemador RETIGO para 611 y 1011 L 400mm An 200mm H 230mm completo, pero sin juntas no compatible con AC31-5000		



1

código	696592	referencia	AC00-2500
descripción	empalme de tubos taladro ø 10mm D1 ø 10mm D2 ø 25mm inox rosca M16		
Para modelos:	B1011b, B1011i, B1221b, B1221i, B2011b, B2011i, B2021b, B2021i, B611b, B611i, B623i, O1011b, O1011i, O1221b, O1221i, O2011b, O2011i, O2021b, O2021i, O611b, O611i, O623i		



1

código	692479	referencia	AX04-0001
descripción	junta de goma goma An 9.7mm ø 55mm para tubo flexible 379mm agujero ø 38mm H 15mm		
Para modelos:	B623i, O623i		





1

código	692481	referencia	AX04-0002
descripción	junta de goma goma An 9.7mm ø 65mm agujero ø 48mm H 15mm		
Para modelos:	B1011b, B1011i, B1221b, B1221i, B2011b, B2011i, B2021b, B2021i, B611b, B611i, O1011b, O1011i, O1221b, O1221i, O2011b, O2011i, O2021b, O2021i, O611b, O611i		





1

código	601914	referencia	AA25-1002	
descripción	kit tapas para horno a vapor combinado con cable con tapa			
repuestos para	601914			
	código	602072	referencia	AC25-0112/S AC25-0311/S
	motorreductor 5W 220-240V tensión AC 50/60Hz 3/3,6rev/min árbol ømm L 84mm An 70mm H 54.4mm			
	código	750400	referencia	AC25-0105
	válvula de compensación de presión para horno a vapor combinado D1 ø 50mm D2 ø 84.5mm agujero ø 50mm H 55mm			





1

código	601913	referencia	AC25-0100 V15-001-030	
descripción	kit tapas para horno a vapor combinado con tapa			
Para modelos:	B1011b, B1011i, B1221b, B1221i, B2011b, B2021b, B2021i, B611b, B611i, B623i, O2011i			
repuestos para	601913			
	código	602072	referencia	AC25-0112/S AC25-0311/S
	motorreductor 5W 220-240V tensión AC 50/60Hz 3/3,6rev/min árbol ømm L 84mm An 70mm H 54.4mm			
	código	750400	referencia	AC25-0105
	válvula de compensación de presión para horno a vapor combinado D1 ø 50mm D2 ø 84.5mm agujero ø 50mm H 55mm			



			
1			
código	692513	referencia	KP31-0153
descripción	soporte PAD 1 inox		

			
1			
código	692514	referencia	AP31-0152 KP31-0152
descripción	soporte PAD 2 inox An 335mm H 160mm		
accesorios para	692514		
	código	692509	referencia
			AP31-0100 KP31-0100
	código	692510	referencia
			AT31-0047 ZA13-3040
	junta para quemador RETIGO ZA22-0003 UE 1m		

			
1			
código	698467	referencia	AT00-0002
descripción	soporte plástico para ducha de mano de aparato ø 21.5mm		
Para modelos:	B1011b, B1011i, B1221b, B1221i, B2011b, B2011i, B2021b, B2021i, B611b, B611i, B623i, O1011b, O1011i, O1221b, O1221i, O2011b, O2011i, O2021b, O2021i, O611b, O611i, O623i		

			
1			
código	750400	referencia	AC25-0105
descripción	válvula de compensación de presión para horno a vapor combinado D1 ø 50mm D2 ø 84.5mm agujero ø 50mm H 55mm		
Para modelos:	B1011b, B1011i, B1221b, B1221i, B2011b, B2021b, B2021i, B611b, B611i, B623i, O1011b, O1011i, O1221b, O1221i, O2011b, O2021b, O2021i, O611b, O611i, O623i		

cierres

cierres de palanca

específico del fabricante

RETIGO

			
1			
código	692486	referencia	ZA20-0901
descripción	cierre longitud de estribo 54mm LC 31mm para cubrimiento 66-76mm		
Para modelos:	B1011b, B1011i, B611b, B611i, B623i, O1011b, O1011i, O611b, O611i, O623i		
repuestos para	692486		
	código	514450	referencia
			AX08-0024
	resorte para tirador de puerta ø 6mm L 61mm An 27.5mm		
	código	692907	referencia
			ZA20-0910
	soporte de muelle L 20mm An 18mm H 8mm pos. de montaje cierre ø 4mm		

			
1			
código	696588	referencia	AC08-0700
descripción	manilla de puerta L 190mm An 35mm H 60mm asidero ø 60.5mm longitud muelle 50mm fijación atornillada negro/argénteo plástico brida 50mm		
Para modelos:	B1011b, B1011i, B611b, B611i, B623i, O1011b, O1011i, O611b, O611i, O623i		
repuestos para	696588		
	código	514450	referencia
			AX08-0024
	resorte para tirador de puerta ø 6mm L 61mm An 27.5mm		
	código	692486	referencia
			ZA20-0901
	cierre longitud de estribo 54mm LC 31mm para cubrimiento 66-76mm		
	código	696587	referencia
			AX08-0021
	manilla de puerta L 195mm An 38mm asidero ø 60mm agujero ø 8mm		
accesorios para	696588		
	código	694066	referencia
			ZA20-0903
	retén con espiga 2 niveles L 28mm An 14mm H 15mm H1 16mm longitud total 51mm rosca M8 rosca L 23mm acero inoxidable		
	código	694067	referencia
			ZA20-0902
	retén con espiga 1 nivel L 26mm longitud total 51mm rosca M8		
	código	696590	referencia
			AX08-0020
	revestimiento para tirador de puerta apto para horno a vapor combinado ø 47mm negro H 24mm agujero ø 36mm		



1

código	696587	referencia	AX08-0021
descripción	manilla de puerta L 195mm An 38mm asidero ø 60mm agujero ø 8mm		
Para modelos:	B1011b, B1011i, B611b, B611i, B623i, O1011b, O1011i, O611b, O611i, O623i		



1

código	694067	referencia	ZA20-0902
descripción	retén con espiga 1 nivel L 26mm longitud total 51mm rosca M8		
Para modelos:	B1011b, B1011i, B611b, B611i, B623i, O1011b, O1011i, O611b, O611i, O623i		



1

código	694066	referencia	ZA20-0903
descripción	retén con espiga 2 niveles L 28mm An 14mm H 15mm H1 16mm longitud total 51mm rosca M8 rosca L 23mm acero inoxidable		
Para modelos:	B1011b, B1011i, B611b, B611i, B623i, O1011b, O1011i, O611b, O611i, O623i		



1

código	696590	referencia	AX08-0020
descripción	revestimiento para tirador de puerta apto para horno a vapor combinado ø 47mm negro H 24mm agujero ø 36mm		
Para modelos:	B1011b, B1011i, B611b, B611i, B623i, O1011b, O1011i, O611b, O611i, O623i		



1

código	692907	referencia	ZA20-0910
descripción	soporte de muelle L 20mm An 18mm H 8mm pos. de montaje cierre ø 4mm		

bisagras

soporte de puerta



1

código	514533	referencia	AT03-0024
descripción	cojinete giratorio L 20mm An 20mm H 13mm ø 5mm sin perno para vidrio		



1

código	514534	referencia	AAX03-0074 AP03-0135
descripción	soporte L 37mm An 25mm H 20mm distancia de sujeción 15mm para vidrio		

filtros

filtros de grasa



1

código	970831	referencia	ZA17-0010
descripción	filtro de grasa An 135mm H 155mm espesor 9mm inox capas 7 rejilla exterior 2 rejilla interior 5		
Para modelos:	B1011b, B1011i, B1221b, B1221i, B2011b, B2011i, B2021b, B2021i, B611b, B611i, B623i, O1011b, O1011i, O1221b, O1221i, O2011b, O2011i, O2021b, O2021i, O611b, O611i, O623i		

pies para aparatos y tapas terminales

pies para aparatos



1

código	701310	referencia	AA00-0027 ZA15-0005
descripción	pie de aparato tubo ø 40mm rosca M10 rosca L 15mm H 80-110mm inox medida 1 1/2" UE 1 pzs		
Para modelos:	B623i, O623i		



			
1			
código	701309	referencia	AA00-0026 ZA15-0002
descripción	pie de aparato tubo ø 52mm rosca M10 rosca Lmm H 86-110mm inox medida 2" UE 1 pzs		
Para modelos:	B1011b, B1011i, B611b, B611i, O1011b, O1011i, O611b, O611i		

			
1			
código	701306	referencia	ZA16-0003
descripción	rueda pivotante ø 100mm agujero agujero ø 10.3mm carcasa plástico capacidad 90kg cojinete rodamiento de bolas cuerpo de rueda polipropileno superficie fricción termoplástico H 135mm ancho de rueda 30mm UE 1 pzs		
Para modelos:	B1221b, B1221i, B2011b, B2011i, B2021b, B2021i, O1221b, O1221i, O2011b, O2011i, O2021b, O2021i		

con placa de sujeción

			
1			
código	701308	referencia	ZA15-0008
descripción	pie de aparato tubo ø 58mm dimensiones de la placa 85x85mm dist. del agujero 85mm H 208-315mm inox medida 2 1/4" UE 1 pzs		
Para modelos:	B1221b, B1221i, B2011b, B2011i, B2021b, B2021i, O1221b, O1221i, O2011b, O2011i, O2021b, O2021i		

pies roscados

			
1			
código	701311	referencia	AC09-0400
descripción	pie de aparato ø 60.5mm H 40mm inox taladro ø M10mm UE 1 pzs		

STEINCO

con agujero

plástico

			
1			
código	701307 ¹	referencia	ZA16-0004
descripción	rueda pivotante con freno total ø 100mm agujero agujero ø 10.3mm carcasa plástico capacidad 90kg cojinete rodamiento de bolas cuerpo de rueda polipropileno superficie fricción termoplástico H 135mm ancho de rueda 30mm UE 1 pzs		
Para modelos:	B1221b, B1221i, B2011b, B2011i, B2021b, B2021i, O1221b, O1221i, O2011b, O2011i, O2021b, O2021i		

¹con freno total

juntas
juntas térmicas

juntas para puertas

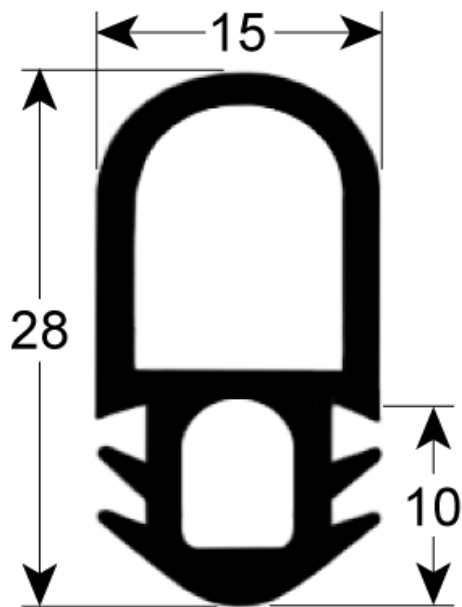
			
1			
código	901461	referencia	AX00-0002
descripción	junta de puerta perfil 2052 An 505mm L 620mm medidas exteriores		

código	901461	referencia	AX00-0002
descripción	junta de puerta perfil 2052 An 505mm L 620mm medidas exteriores		

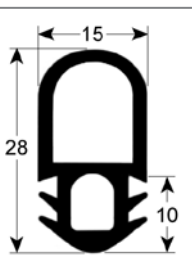
			
1			
código	901701	referencia	AX00-0003
descripción	junta de puerta perfil 2052 An 615mm L 755mm medidas exteriores		

código	901701	referencia	AX00-0003
descripción	junta de puerta perfil 2052 An 615mm L 755mm medidas exteriores		

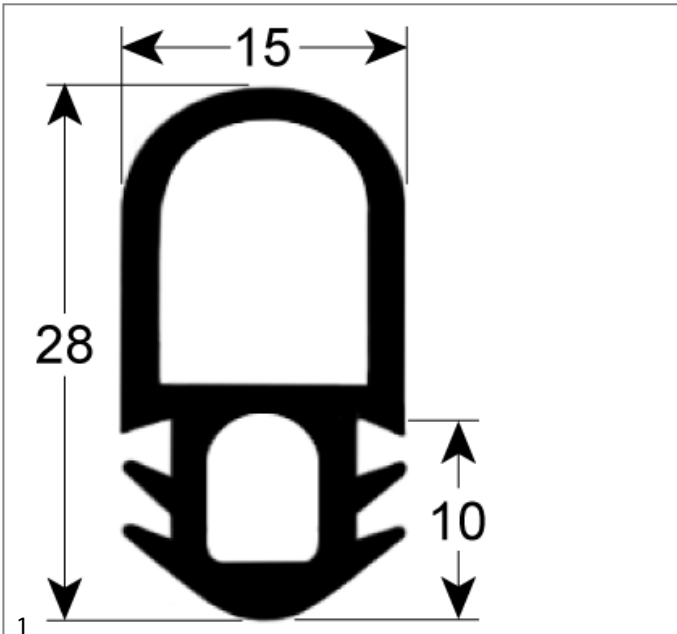

código	902552	referencia	AX00-0004
descripción	junta de puerta perfil 2052 An 660mm L 1420mm medidas exteriores UE 1		

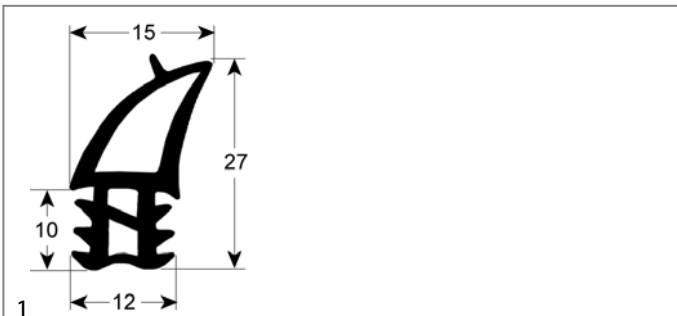

código	901720	referencia	AX00-0034
descripción	junta de puerta perfil 2729 An 405mm L 405mm medidas exteriores UE 1 para RETIGO		
Para modelos:	B623i, O623i		

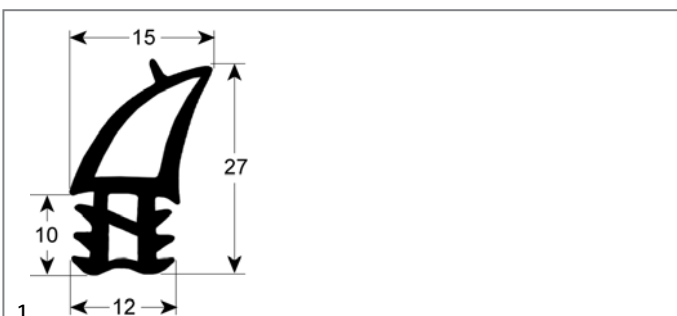

código	901717	referencia	AX00-0031 AX00-0038
descripción	junta de puerta perfil 2729 An 620mm L 1380mm medidas exteriores UE 1 para RETIGO		
Para modelos:	B2011b, B2011i, B2021b, B2021i, O2011b, O2011i, O2021b, O2021i		

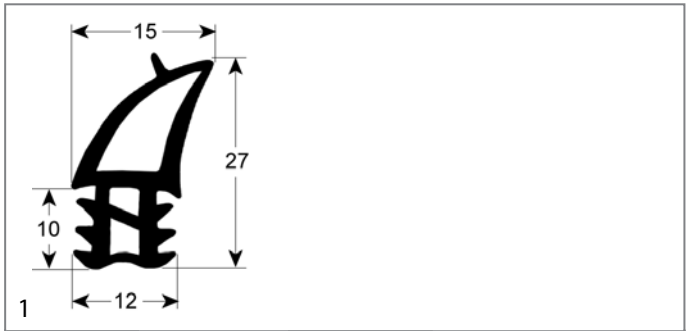

código	901721	referencia	AX00-0035
descripción	junta de puerta perfil 2729 An 620mm L 490mm medidas exteriores UE 1 para RETIGO		
Para modelos:	B611b, B611i, O611b, O611i		

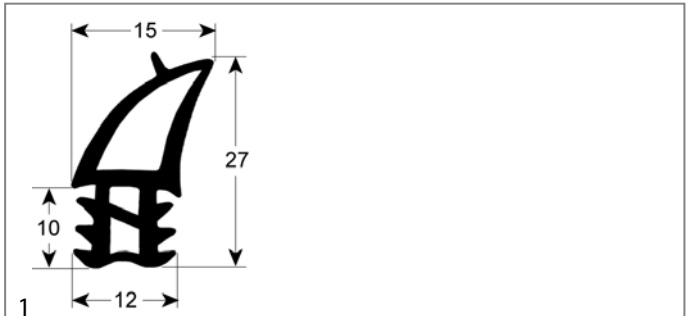

código	901719	referencia	AX00-0036
descripción	junta de puerta perfil 2729 An 620mm L 755mm medidas exteriores UE 1 para RETIGO		
Para modelos:	B1011b, B1011i, O1011b, O1011i		

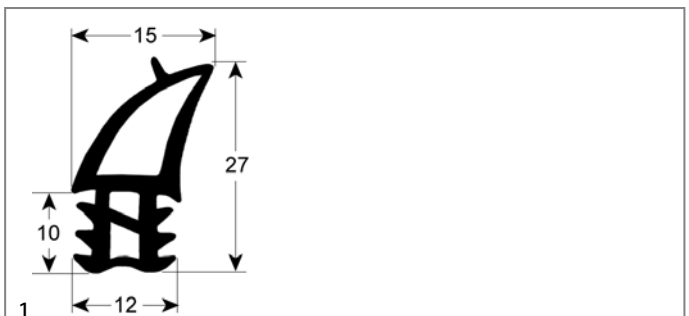

código	901718	referencia	AX00-0037
descripción	junta de puerta perfil 2729 An 620mm L 930mm medidas exteriores UE 1 para RETIGO		
Para modelos:	B1221b, B1221i, O1221b, O1221i		

juntas para bandejeros



código	901722	referencia	AX03-0078
descripción	junta para carro porta bandejas L 645mm An 44mm apto para RETIGO		
Para modelos:	B1221b, B1221i, B2011b, B2011i, B2021b, B2021i, O1221b, O1221i, O2011b, O2011i, O2021b, O2021i		



juntas tóricas

PTFE

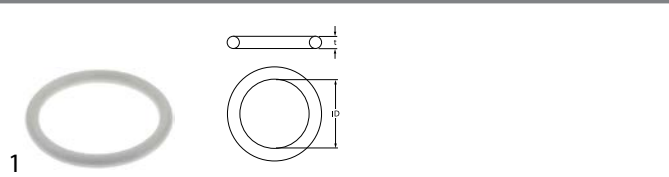

código	696591	referencia	ZA13-1549
descripción	junta tórica silicona espesor 5.5mm int.ø 48.75mm		
Para modelos:	B1011b, B1011i, B1221b, B1221i, B2011b, B2011i, B2021b, B2021i, B611b, B611i, B623i, O1011b, O1011i, O1221b, O1221i, O2011b, O2011i, O2021b, O2021i, O611b, O611i, O623i		



código	692515	referencia	AX31-0043
descripción	junta para intercambiador térmico UE 1 MICA		

otros

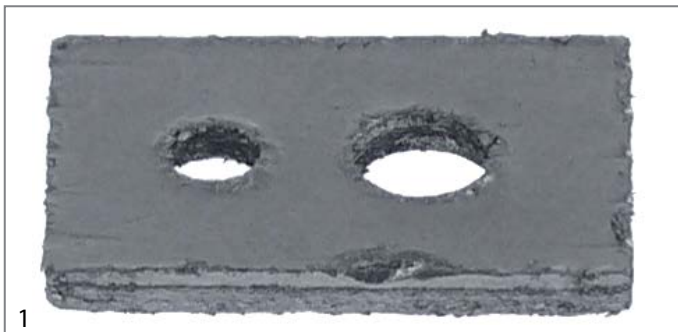

código	692512	referencia	AX31-0045
descripción	junta para control de llama UE 1 RETIGO		

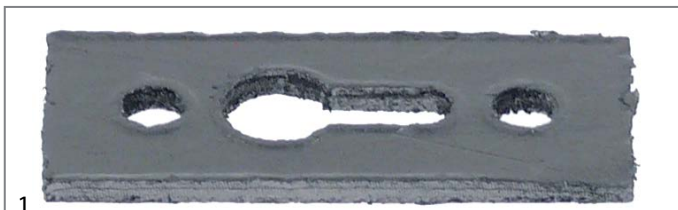

código	692511	referencia	AX31-0044
descripción	junta para electrodo de encendido UE 1 RETIGO AC31-0903		



código	692510	referencia	AT31-0047 ZA13-3040	
descripción	junta para quemador RETIGO ZA22-0003 UE 1m			
accesorios para	692510			
	código	692509	referencia	AP31-0100 KP31-0100
	descripción			marco para quemador RETIGO ZA22-0003 medida 320x136mm UE 1



código	692516	referencia	KP31-0049
descripción	junta para intercambiador térmico latón para modelo UE 1		

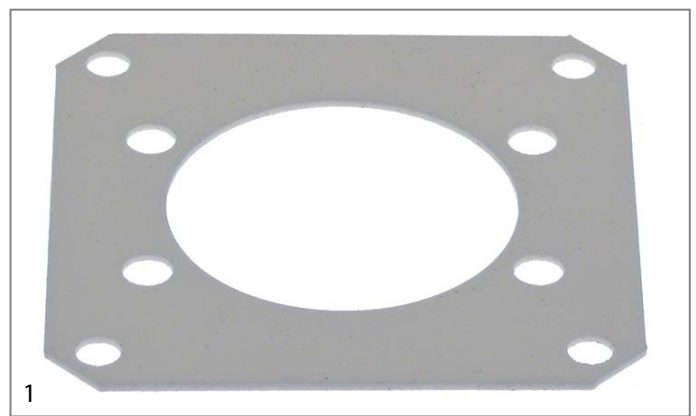

código	692517	referencia	AX31-0010
descripción	junta UE 1 para tipo 611 y 1011		

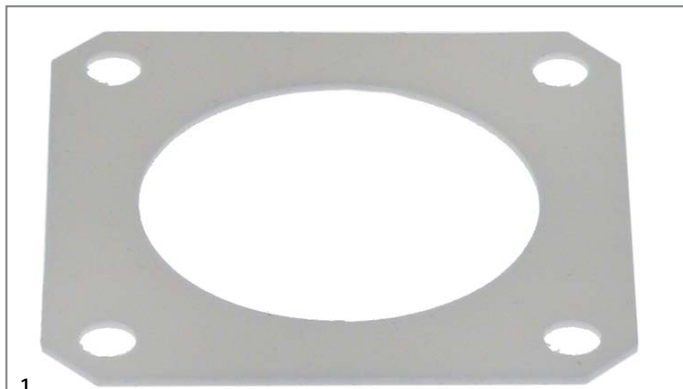

1

código	692518	referencia	AX31-0011
descripción	junta UE 1 silicona		

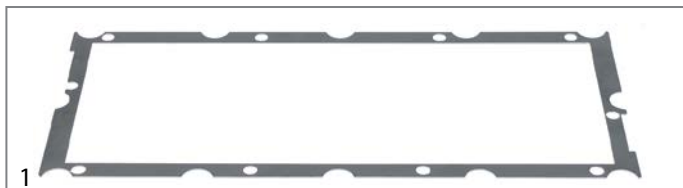

1

código	692509	referencia	AP31-0100 KP31-0100
descripción	marco para quemador RETIGO ZA22-0003 medida 320x136mm UE 1		
accesorios para	692509		
	código	692510	referencia
			AT31-0047 ZA13-3040
	junta para quemador RETIGO ZA22-0003 UE 1m		

muelles

otros



1

código	701316	referencia	AC08-0208
descripción	grapa elástica forma U cerradura alojamiento del ejemm ømm L 40mm An 50mm Hmm espesor de hilo 0.8mm		
Para modelos:	B1221b, B1221i, B2011b, B2011i, B2021b, B2021i, O1221b, O1221i, O2011b, O2011i, O2021b, O2021i		



1

código	514450	referencia	AX08-0024
descripción	resorte para tirador de puerta ø 6mm L 61mm An 27.5mm		

resortes de tracción



1

código	701659	referencia	AX08-0012
descripción	muelle de tracción para mecánica de puertas ø 7mm longitud total 44mm espesor de hilo 0.9mm para horno a vapor combinado		

manómetros



1

código	541998	referencia	ZA12-0401 ZA12-0409
descripción	manómetro ø 40mm margen de presión 0-1bar empalme 1/8"		
Para modelos:	B1011i, B1221i, B2011i, B2021i, B611i, B623i, O1011i, O1221i, O2011i, O2021i, O611i, O623i		

enrolladores de tubo y duchas de mano para lavado

duchas de mano para lavado





1

código	542038	referencia	ZA15-0100
descripción	ducha de mano de aparato 3/8" H L 135mm		
Para modelos:	B1011b, B1011i, B1221b, B1221i, B2011b, B2011i, B2021b, B2021i, B611b, B611i, B623i, O1011b, O1011i, O1221b, O1221i, O2011b, O2011i, O2021b, O2021i, O611b, O611i, O623i		



1

código	698468	referencia	AA26-1002
descripción	ducha de mano de aparato con accesorios		
repuestos para	698468		
	código	542038	referencia
			ZA15-0100
	ducha de mano de aparato 3/8" H L 135mm		
	código	698467	referencia
			AT00-0002
	soporte plástico para ducha de mano de aparato ø 21.5mm		



			
código	520891	referencia	ZA11-0904
descripción	tubo de ducha empalmes 3/8" L 2100mm EPDM T máx 110°C p de reventamiento 10bar para horno a vapor combinado		
Para modelos:	B1221b, B1221i, B2011b, B2011i, B2021b, B2021i, O1221b, O1221i, O2011b, O2011i, O2021b, O2021i		

tubos flexibles

tubos flexibles industriales

tubos flexibles de PVC

tubos de tejido recubiertos de PVC

			
código	570163	referencia	AA26-0101
descripción	tubo de tejido de PVC int.ø 10mm ø ext. 17.2mm L 350m grosor de la pared 3.6mm PVC horno a vapor combinado transparente UE 1		

			
código	570162	referencia	AA26-0100
descripción	tubo de tejido de PVC int.ø 10mm ø ext. 17.2mm L 440m grosor de la pared 3.6mm PVC horno a vapor combinado transparente UE 1		

			
código	570164	referencia	AA26-0104
descripción	tubo de tejido de PVC int.ø 10mm ø ext. 17.2mm L 90m grosor de la pared 3.6mm PVC horno a vapor combinado transparente UE 1		

tubos de silicona

sin tejido

			
código	530062	referencia	ZA11-0805
descripción	tubo de silicona int.ø 16mm ø ext. 23mm L 1m T máx 200°C transparente		

con tejido

con trenzado exterior de monofil

			
código	530435	referencia	ZA11-0803
descripción	tubo de silicona L 1m int.ø 10mm ø ext. 17mm revestido en monohilo grosor de la pared 3.5mm p de trabajo 4bar T máx 200°C claro		
Para modelos:	B2011i, O2011i		

tubos formados

recto

			
código	530920	referencia	ZA10-0500
descripción	manguera de vapor silicona L 68mm int.ø 38mm ø ext. 46mm para horno a vapor combinado generador de vapor		

componentes para el circuito agua

reductores de presión

reductores de presión

específico del fabricante

			
código	520958	referencia	ZA12-0207
descripción	reductor de presión Norgren empalme 1/4 / 1/8 preajustable margen de ajuste 0,1-2bar		

A			
accesorios eléctricos	15		
B			
bombas	14		
bombas de salida	14		
C			
cables de encendido	16		
centralitas de gas automáticas	16		
componentes para el circuito agua	29		
condensadores de servicio	14		
condensadores y filtros antiparasitarios	14		
contactores	6		
D			
duchas de mano para lavado	28		
E			
electródos	11		
F			
filtros	14		
fusibles	15		
I			
interruptores magnéticos	4		
interruptores y pulsadores	4		
J			
juntas para bandejeros	26		
juntas para puertas	25		
juntas térmicas	25		
juntas tóricas	27		
L			
lámparas	4		
lámparas halógenas	4		
lámparas para hornos	4		
M			
motores	14		
motores de aire caliente	12		
Q			
quemadores de gas	16		
R			
reductores de presión	29, 29		
relés	7		
resistencias	2		
resistencias circulación de aire	2		
		resistencias de inmersión	2
		ruedas para aparatos y esquinas protectoras	25
		S	
		semiconductores de potencia	7
		señalizadores de alarma	5
		sensores	8
		T	
		terminales	15
		termostatos	3
		termostatos de seguridad	3
		transformadores	7
		tubos de silicona	29
		tubos flexibles	29
		tubos flexibles de PVC	29
		tubos flexibles industriales	29
		tubos formados	29
		U	
		unidades de encendido	16
		V	
		válvulas de control de gas	15
		válvulas magnéticas	11
		ventilador axial	12
		ventiladores	12
		ventiladores de aire caliente	13
		ventiladores radiales	13