



# Ersatzteile für Öfen & Kombiöfen



Ersatzteile passend für

# ANGELO-PO

# 2018

Das komplette Sortiment finden Sie immer aktuell im GEV-Webshop





# Heizkörper



## Tauchheizkörper



### 3-Lochflansch ø57,5mm

			
<b>GEV-Nr.</b>	416231	<b>Vergl.-Nr.</b>	32G0230
<b>Beschreibung</b>	Heizkörper 4500W 230V Einbau ø 57.5mm HK 3 L 307mm B 45mm H 36mm THA 1 TH ø 7mm THL 210mm THP außermittig, nicht anliegend Rohr ø 8.5mm LA 74mm Loch ø 8/10mm Anschluss M5 3-Lochflansch Tauchheizkörper		
<b>Ersatzteile für</b>	416231		
	<b>GEV-Nr.</b>	510409	<b>Vergl.-Nr.</b> 3150430 3151960 37Q5260
<b>Zubehör für</b>	416231		
	<b>GEV-Nr.</b>	520258	<b>Vergl.-Nr.</b> —
	Schutzkappe		

			
<b>GEV-Nr.</b>	415021	<b>Vergl.-Nr.</b>	32G0400 32G0420 32G0520 32G0920
<b>Beschreibung</b>	Heizkörper 6000W 230V Einbau ø 57.5mm HK 3 L 343mm B 37mm H 50mm THA 1 TH ø 7mm THL 294mm THP nicht anliegend Rohr ø 8.5mm LA 72mm Loch ø 8mm Anschluss M5 3-Lochflansch		
<b>Für Modelle:</b>	F60P, F60PR, F60T, F80P, F80PR, L100, L45, L60, L80		
<b>Ersatzteile für</b>	415021		
	<b>GEV-Nr.</b>	510409	<b>Vergl.-Nr.</b> 3150430 3151960 37Q5260
<b>Zubehör für</b>	415021		
	<b>GEV-Nr.</b>	550002	<b>Vergl.-Nr.</b> 3113780
	Spannbügel H 10mm L 21mm B 10mm Loch ø 6.5mm für Heizkörper		

## Umluftheizkörper

			
<b>GEV-Nr.</b>	418102	<b>Vergl.-Nr.</b>	32G1701
<b>Beschreibung</b>	Heizkörper 16400W 230V HK 3 ID ø 441mm AD ø 458mm L 492mm H 143mm L1 34mm B1 104mm H1 128mm H2 115mm FL 142mm FB 25mm LA 63mm Anschluss M6x1 Rohr ø 8.5mm Umluftheizkörper Loch ø 6mm Rechteckflansch		
<b>Für Modelle:</b>	BX101E, BX101E-VERS.122013, FC1011E, FC101E, FCV101E, FCV101EDM, FCV101EDM-UL, FCV101EDS, FCV101EDS-UL, FCV101E-UL, FCV141E, FCV141EDM, FCV141EDS, FCV72EDM-UL, FCV72EDS-UL, FCV72E-UL, FM1011E1, FM1011E1-VERS.2006, FM1011E2, FM1011E2-VERS.2006, FM1011E3, FM1011E3-VERS.2006, FM2011E2-VERS.2006, FM2011E3-VERS.2006, FM721E1, FM721E1-VERS.2006, FM721E2, FM721E2-VERS.2006, FM721E3, FM721E3-VERS.2006, FX101E1, FX101E1R, FX101E2, FX101E2C, FX101E2R, FX101E3, FX101E3C, FX101E3R, FX10E2CR, FX10E3CR, FX201E2, FX201E2P, FX201E3, FX201E3P		
<b>Zubehör für</b>	418102		
	<b>GEV-Nr.</b>	699165	<b>Vergl.-Nr.</b> 3332550
	Dichtung L 142mm B 25mm D1 ø 6.5mm D2 ø 12mm LA 17mm 9 Löcher Graphit Materialstärke 2mm		

			
<b>GEV-Nr.</b>	418103	<b>Vergl.-Nr.</b>	32G1711
<b>Beschreibung</b>	Heizkörper 24000W 400V HK 3 ID ø 518mm AD ø 535mm L 590mm H 143mm L1 38mm B1 104mm H1 120mm H2 23mm FL 142mm FB 25mm LA 125mm Anschluss M6 Rohr ø 8.5mm Umluftheizkörper Loch ø 6mm Rechteckflansch		
<b>Für Modelle:</b>	FC1221E, FC241E, FCV241E, FCV241EDM, FCV241EDS, FCV401EDM, FM1221E1, FM1221E1-VERS.2006, FM1221E2, FM1221E2-VERS.2006, FM1221E3, FM1221E3-VERS.2006, FM2021E1, FM2021E2, FM2021E2-VERS.2006, FM2021E3, FM2021E3-VERS.2006		
<b>Zubehör für</b>	418103		
	<b>GEV-Nr.</b>	699165	<b>Vergl.-Nr.</b> 3332550
	Dichtung L 142mm B 25mm D1 ø 6.5mm D2 ø 12mm LA 17mm 9 Löcher Graphit Materialstärke 2mm		



1

<b>GEV-Nr.</b>	418099	<b>Vergl.-Nr.</b>	32G0430
<b>Beschreibung</b>	Heizkörper 2800W 230V HK 1 ID ø 217mm AD ø 230mm L 249mm H 72mm L1 11mm B1 68mm H1 11mm H2 41mm FL 142mm FB 25mm LA 63mm Anschluss Flachstecker 6,3mm AL 73mm Rohr ø 6.3mm Umluftheizkörper Loch ø 6mm Rechteckflansch		
<b>Für Modelle:</b>	FCV3EM		



1

<b>GEV-Nr.</b>	419261	<b>Vergl.-Nr.</b>	3116030
<b>Beschreibung</b>	Heizkörper 9500/10400W 230/240V HK 3 ID ø 320mm AD ø 337mm L 380mm H 148mm L1 40mm B1 105mm H1 20mm H2 120mm FL 142mm FB 25mm LA 18mm Anschluss M6x1 AL 85mm Rohr ø 8.5mm Umluftheizkörper Flansch Kombidämpfer		
<b>Für Modelle:</b>	BX61E, BX61E-VERS.122013, FX61E1, FX61E1R, FX61E2, FX61E2C, FX61E2CR, FX61E2CR-VERS.032014, FX61E2C-VERS.032014, FX61E2R, FX61E2R-VERS.032014, FX61E2-VERS.032014, FX61E3, FX61E3C, FX61E3CR, FX61E3CR-VERS.022014, FX61E3C-VERS.022014, FX61E3R, FX61E3R-VERS.022014, FX61E3-VERS.022014		



1

<b>GEV-Nr.</b>	418100	<b>Vergl.-Nr.</b>	32G1940
<b>Beschreibung</b>	Heizkörper 4150W 230V HK 3 ID ø 214mm AD ø 226mm L 248mm H 70mm L1 15mm B1 103mm H1 5mm H2 65mm FL 142mm FB 25mm LA 62mm Anschluss Flachstecker 6,3mm Rohr ø 6.3mm Umluftheizkörper Loch ø 6mm Rechteckflansch		
<b>Für Modelle:</b>	FCV4E, FCV4EDS, FCV4EM, FM423E1, FM423E2		





1

<b>GEV-Nr.</b>	415737	<b>Vergl.-Nr.</b>	32G1280
<b>Beschreibung</b>	Heizkörper 2500W 230V HK 1 L 655mm B 120mm L1 30mm L2 625mm B2 90mm FL 70mm FB 22mm LA 56mm AL 100mm Anschluss M4 Rohr ø 6.3mm Loch ø 5.5mm B1 30mm Rechteckflansch Umluftheizkörper Windungen 2		



1

<b>GEV-Nr.</b>	418101	<b>Vergl.-Nr.</b>	32G1691
<b>Beschreibung</b>	Heizkörper 8700W 230V HK 3 ID ø 317mm AD ø 333mm L 375mm H 100mm L1 42mm B1 105mm H1 82mm H2 18mm FL 142mm FB 25mm LA 63mm Anschluss M6 AL 26mm Rohr ø 8.5mm Umluftheizkörper Loch ø 6mm Rechteckflansch		
<b>Für Modelle:</b>	FC611E, FC61E, FCV61E, FCV61EDM, FCV61EDM-UL, FCV61EDS, FCV61EDS-UL, FCV61E-UL, FM611E1, FM611E1-VERS.2006, FM611E2, FM611E2-VERS.2006, FM611E3, FM611E3-VERS.2006		
<b>Zubehör für</b>	418101		
	<b>GEV-Nr.</b>	<b>Vergl.-Nr.</b>	3332550
	Dichtung L 142mm B 25mm D1 ø 6.5mm D2 ø 12mm LA 17mm 9 Löcher Graphit Materialstärke 2mm		



1

<b>GEV-Nr.</b>	419222	<b>Vergl.-Nr.</b>	3115001
<b>Beschreibung</b>	Heizkörper 27000/29000W 400/415V L 590mm B 545mm H 140mm HK 3 Kabellängem		
<b>Für Modelle:</b>	BX122E, BX122E-VERS.122013, FX122E1, FX122E2, FX122E2C, FX122E2T, FX122E2T-VERS.032014, FX122E3, FX122E3C, FX122E3T, FX122E3T-VERS.022014, FX12E3CT, FX12E3CT-VERS.022014, FX202E2, FX202E2-VERS.032014, FX202E3, FX202E3-VERS.022014		



1

<b>GEV-Nr.</b>	415736	<b>Vergl.-Nr.</b>	32G1360
<b>Beschreibung</b>	Heizkörper 3500W 230V HK 1 L 655mm B 125mm L1 30mm L2 625mm B2 88mm FL 70mm FB 22mm LA 56mm AL 97mm Anschluss M4 Rohr ø 6.25mm Loch ø 5mm B1 30mm Rechteckflansch Umluftheizkörper Windungen 2 BA 58mm		



## Zubehör

## Unterlegscheiben



1

<b>GEV-Nr.</b>	560113	<b>Vergl.-Nr.</b>	3121480
<b>Beschreibung</b>	Unterlegscheibe ID $\varnothing$ 6.4mm AD $\varnothing$ 12mm Materialstärke 1.6mm CNS VPE 20 Stück DIN 125A für Gewinde M6		
<b>Für Modelle:</b>	030FE1, 30F1, 30FES2, 30FS2, 70F1, 70FE1, 70FES2, 70FES2B, 71F2, 71FE2, 91F210		

## Dichtungsringe

## O-Ringe

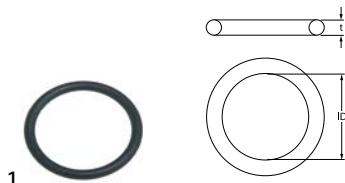

1

<b>GEV-Nr.</b>	510408	<b>Vergl.-Nr.</b>	3152650
<b>Beschreibung</b>	O-Ring EPDM Materialstärke 5.34mm ID $\varnothing$ 47mm VPE 1 Stück		

## Flanschdichtungen



1

<b>GEV-Nr.</b>	699165	<b>Vergl.-Nr.</b>	3332550
<b>Beschreibung</b>	Dichtung L 142mm B 25mm D1 $\varnothing$ 6.5mm D2 $\varnothing$ 12mm LA 17mm 9 Löcher Graphit Materialstärke 2mm		

## Energierегler

## EGO

## 1-kreisig



1

<b>GEV-Nr.</b>	380015	<b>Vergl.-Nr.</b>	32Z0170 32Z0171
<b>Beschreibung</b>	Energierегler 230V 13A Einkreis Drehrichtung rechts Achse $\varnothing$ 6x4,6mm Achslänge 23mm Befestigungsgewinde M4 Leistungsfreigabe 6-100% Nr. 50.57021.010		
<b>Für Modelle:</b>	06WBR3E, 08WGREV, 090SPE, 0G0SPE, 0G1BR3E, 190GRE, 191BR1E, 191BR2E, 191BR2EA, 1A1BR1E, 1A1BR2E, 1A1BR2EA, 1D1BR1E, 1D1BR2E, 1D1BR2EA, 1G0GRE, 1G1BR3E, 291BR1E, 291BR2E, 291BR2EA, 291PI3E, 2A1BR1E, 2A1BR2E, 2A1BR2EA, 2A1PI3E, 2D1BR1E, 2D1BR2E, 2D1BR2EA, FC1011E, FC1011G, FC1221E, FC1221G, FC611E, FC611G, FMS, FMSX		

## Thermostate

## Anlegethermostate

## Anlegethermostate



1

<b>GEV-Nr.</b>	375927	<b>Vergl.-Nr.</b>	3093940
<b>Beschreibung</b>	Anlegethermostat LA 23.5mm Abschalttemp. 50°C 1NO 10A Anschluss F6,3		
<b>Für Modelle:</b>	04WPEBV, 08WPEBV, 08WTPEV, 090PEB, 091FR7G, 091PEB, 190PEB, 190TPE, 191PEB, 191TPE, 6BM, 6BR, 6CP, 6FR, 6FTL, 6FTR, 6PC, 6VTR		

## Regel- und Sicherheitsthermostate

## EGO

## Regelthermostate

## Serie 55.10/19\_



1

<b>GEV-Nr.</b>	375631	<b>Vergl.-Nr.</b>	32Z5820
<b>Beschreibung</b>	Thermostat T.max. 249°C Arbeitsbereich 55-249°C 1-polig 1NO 16A Fühler $\varnothing$ 3.1mm Fühler L 226mm Kapillarrohr 1270mm Kapillarrohr isoliert 850mm Stopfbuchse 3/8"-M8x1 Achse $\varnothing$ 6x4,6mm Achslänge 23mm Achsstellung oben Drehwinkel 318°		
<b>Für Modelle:</b>	FC101, FC1011E, FC1011G, FC101E, FC1221E, FC1221G, FC241, FC241E, FC241G, FC61, FC611E, FC611G, FC61E, FCV101, FCV101-CSA, FCV101E, FCV101E-UL, FCV141, FCV141-CSA, FCV141E, FCV241, FCV241E, FCV241E-UL, FCV241G, FCV241G-CSA, FCV3EM, FCV4EM, FCV61, FCV61-CSA, FCV61E, FCV61E-UL, FCV72E-UL		



1

<b>GEV-Nr.</b>	390068	<b>Vergl.-Nr.</b>	32Z0610
<b>Beschreibung</b>	Thermostat T.max. 269°C Arbeitsbereich 55-269°C 1-polig 1CO 16A Fühler $\varnothing$ 3.1mm Fühler L 219mm Kapillarrohr 1280mm Kapillarrohr isoliert 1270mm Stopfbuchse Achse $\varnothing$ 6x4,6mm Achslänge 23mm Achsstellung oben° Drehwinkel 318°		



<b>GEV-Nr.</b>	375437	<b>Vergl.-Nr.</b>	32Z0210
<b>Beschreibung</b>	Thermostat T.max. 324°C Arbeitsbereich 66-324°C 1-polig 1NO 16A Fühler ø 4mm Fühler L 124mm Kapillarrohr 1470mm Kapillarrohr isoliertmm Stopfbuchse Achse ø 6x4,6mm Achslänge 23mm Achsstellung oben Drehwinkel 270°		



<b>GEV-Nr.</b>	375215	<b>Vergl.-Nr.</b>	32Z2430
<b>Beschreibung</b>	Thermostat T.max. 65°C Arbeitsbereich fest 65°C 1-polig 1CO 16A Fühler ø 6mm Fühler L 130mm Kapillarrohr 900mm Kapillarrohr isoliert 900mm Stopfbuchse Achslängem Achsstellung		
<b>Für Modelle:</b>	F60PR, F60T, F80P, F80PR, L100, L40, L40S, L60, L80		



<b>GEV-Nr.</b>	390032	<b>Vergl.-Nr.</b>	32Z0160 32Z5880
<b>Beschreibung</b>	Thermostat T.max. 90°C Arbeitsbereich 30-90°C 1-polig 1CO 16A Fühler ø 6mm Fühler L 130mm Kapillarrohr 2500mm Kapillarrohr isoliertmm Stopfbuchse M10x1 Achse ø 6x4,6mm Achslänge 23mm Achsstellung oben Drehwinkel 270° Fühlermaterial CNS		
<b>Für Modelle:</b>	FC101, FC101E, FC101G, FC101E, FC1221E, FC1221G, FC241, FC241E, FC241G, FC61, FC61E, FC61G, FC61E, FCV101, FCV101-CSA, FCV101E, FCV101E-UL, FCV141, FCV141-CSA, FCV141E, FCV241, FCV241E, FCV241E-UL, FCV241G, FCV3EM, FCV401DM, FCV401EDM, FCV401EDM-UL, FCV4EM, FCV61, FCV61-CSA, FCV61E, FCV61E-UL, FCV72E-UL, L100, L40, L40S, L60, L80		

Serie 55.34\_



<b>GEV-Nr.</b>	375038	<b>Vergl.-Nr.</b>	32Z2560
<b>Beschreibung</b>	Thermostat T.max. 300°C Arbeitsbereich 50-300°C 3-polig 3NO 16A Fühler ø 6mm Fühler L 79mm Kapillarrohr 1740mm Kapillarrohr isoliert 800mm Stopfbuchse Achse ø 6x4,6mm Achslänge 23mm Achsstellung oben Drehwinkel 270°		
<b>Für Modelle:</b>	191FAAE, 191FAE, 191PE4E, 1A1PE4E, 1A1PEFFE, 1A1FBE, 1D1PE4E, 1D1FBE, 71E, 71GE, 71GEGG, FS30E		
<b>Zubehör für</b>	375038		
		<b>GEV-Nr.</b>	110123
		<b>Vergl.-Nr.</b>	—
	Knebel Thermostat T.max. 300°C ø 50mm Achse ø 6x4,6mm Abflachung oben schwarz Arbeitsbereich 50-300°C Drehwinkel 270°		

Sicherheitsthermostate

Serie 55.32\_



<b>GEV-Nr.</b>	375208	<b>Vergl.-Nr.</b>	32V398
<b>Beschreibung</b>	Sicherheitsthermostat Abschalttemp. 139°C 3-polig 2x20/1x0,5A Fühler ø 6mm Fühler L 77mm Kapillarrohr 890mm Kapillarrohr isoliertmm Stopfbuchse M9x1 Fühler CNS		



<b>GEV-Nr.</b>	375209	<b>Vergl.-Nr.</b>	32V3980 32Z2011
<b>Beschreibung</b>	Sicherheitsthermostat Abschalttemp. 140°C 3-polig 20A Fühler ø 6mm Fühler L 89mm Kapillarrohr 900mm Kapillarrohr isoliert 900mm Stopfbuchse Fühler CNS		
<b>Für Modelle:</b>	191CP1GA, 1A1CP1GA, 1A1PI2G, 1A1PI2GA, 1D1CP1GA, 1D1PI2G, 1D1PI2GA, 291PD3G, 291PI3G, 2A1PD3G, 2A1PI3G, 2D1PI3G, F60P, F60PR, F60T, F80P, F80PR, L100, L40, L40S, L45, L60, L80		

IMIT / TEMPOMATIC / ARThERMO

Regelthermostate



<b>GEV-Nr.</b>	375220	<b>Vergl.-Nr.</b>	32Z6790
<b>Beschreibung</b>	Sicherheitsthermostat Abschalttemp. 330°C 3-polig 20A Fühler ø 11mm Fühler L 18.5mm Kapillarrohr 900mm Kapillarrohr isoliert 900mm Stopfbuchse Fühler Einschraubföhler Föhlergewinde M14x1		
<b>Für Modelle:</b>	FCV4E, FCV4EDS		





<b>GEV-Nr.</b>	375344	<b>Vergl.-Nr.</b>	32Z1400
<b>Beschreibung</b>	Sicherheitsthermostat Abschalttemp. 360°C 1-polig 0.5A Föhler ø 4mm Föhler L 120mm Kapillarrohr 1500mm Kapillarrohr isoliert 1500mm Stopfbuchse Föhler		
<b>Für Modelle:</b>	031FT04, 031FT06, 070FT04, 070FT05, 071FT04, 071FT06, 08WFT-4GV, 08WFT6GV, 090FT04, 090FT05, 090FT4G, 090FT5G, 091FT04, 091FT06, 0A0FT1G, 0A0FT2G, 0A0FT4G, 0A0FT5G, 0B0FT1G, 0B0FT2G, 0B0FT4G, 0B0FT5G, 0D0FT1G, 0D0FT2G, 0D0FT4G, 0D0FT5G, 0G0FT4G, 0G0FT4G-VERS.032008, 0G0FT5G, 0G0FT5G-VERS.032008, 0G1BR3G, 190FT15G, 190FT42G, 190FT4G, 190FT6G, 1A0FT1G, 1A0FT2G, 1A0FT3G, 1A0FT4G, 1A0FT6G, 1B0FT4G, 1B0FT6G, 1D0FT1G, 1D0FT2G, 1D0FT3G, 1D0FT4G, 1D0FT6G, 1G0FT4G, 1G0FT4G-VERS.032008, 1G0FT6G...(Weitere Modelle finden Sie in unserem Webshop)		



<b>GEV-Nr.</b>	375474	<b>Vergl.-Nr.</b>	3111950 32Z5511
<b>Beschreibung</b>	Sicherheitsthermostat T.max. 340°C Abschalttemp. 340°C 2-polig 1NC/1CO 1x20/1x0,5A Föhler ø 4mm Föhler L 120mm Kapillarrohr 1300mm Kapillarrohr isoliert 900mm Stopfbuchse Föhler		
<b>Für Modelle:</b>	FC101, FC1011E, FC1011G, FC101E, FC1221E, FC1221G, FC241, FC241E, FC241G, FC61, FC611E, FC611G, FC61E, FCV101, FCV101DM, FCV101DS, FCV101E, FCV101EDM, FCV101EDS, FCV141, FCV141DM, FCV141DS, FCV141E, FCV141EDM, FCV141EDS, FCV241, FCV241DM, FCV241DS, FCV241E, FCV241EDM, FCV241EDS, FCV241G, FCV241G-CSA, FCV241GDM, FCV241GDS, FCV3EM, FCV401DM, FCV401EDM, FCV4EM, FCV61, FCV61DM, FCV61DS, FCV61E, FCV61EDM, FCV61EDS, FM1011E1, FM1011E1-VERS.2006, FM1011E2, FM1011E2-VERS.2006, FM1011E3...(Weitere Modelle finden Sie in unserem Webshop)		



<b>GEV-Nr.</b>	390006	<b>Vergl.-Nr.</b>	32V1910
<b>Beschreibung</b>	Thermostat T.max. 86°C Arbeitsbereich 0-86°C 1-polig 1CO 16A Föhler ø 6.5mm Föhler L 95mm Kapillarrohr 1500mm Kapillarrohr isoliertmm Stopfbuchse Achse ø 6x4,6mm Achslänge 19mm Drehwinkel 270°		
<b>Für Modelle:</b>	C207D-VERS.2006, C207S-VERS.2006, C207VD-VERS.2006, C207VS-VERS.2006, C304AD-VERS.2006, C304AS-VERS.2006, C304AVD-VERS.2006, C304AVS-VERS.2006, C304D-VERS.2006, C304S-VERS.2006, C304VD-VERS.2006, C304VS-VERS.2006, C92D-VERS.2006, C92S-VERS.2006, C92VD-VERS.2006, C92VS-VERS.2006, CS243D-VERS.2006, CS243S-VERS.2006, CS243VD-VERS.2006, CS243VS-VERS.2006, CS370AD-VERS.2006, CS370AS-VERS.2006, CS370AVD-VERS.2006, CS370AVS-VERS.2006, CS370D-VERS.2006, CS370S-VERS.2006, CS370VD-VERS.2006, CS370VS-VERS.2006, CS466AD-VERS.2006, CS466AS-VERS.2006, CS466AVD-VERS.2006, CS466AVS-VERS.2006, CS466D-VERS.2006, CS466S-VERS.2006, CS466VD-VERS.2006, CS466VS-VERS.2006, LC100, LC100-VERS.2001, LC130, LC130-VERS.2001, LC80, LF50		

<b>Zubehör für</b> 390006			
	<b>GEV-Nr.</b>	<b>Vergl.-Nr.</b>	110100 36M2830
	Knebel Thermostat T.max. 90°C 0-90°C ø 42mm Achse ø 6x4,6mm Abflachung -135° schwarz		
	<b>GEV-Nr.</b>	<b>Vergl.-Nr.</b>	110105 —
	Rosette Knebel ø 42mm ø 56mm Nullstrich		



<b>GEV-Nr.</b>	390704	<b>Vergl.-Nr.</b>	32Z8840
<b>Beschreibung</b>	Thermostat T.max. 86°C Arbeitsbereich 0-86°C 1-polig 1CO 16A Föhler ø 6.5mm Föhler L 98mm Kapillarrohr 1020mm Kapillarrohr isoliert 950mm Stopfbuchse Achse ø 6x4,6mm Achslänge 19mm Achsstellung +135° Drehwinkel 270° Föhlermaterial Kupfer 250V		
<b>Für Modelle:</b>	C165D, C165S, C165VD, C165VS, C207D, C207S, C207VD, C207VS, C304AD, C304AD-VERS.2006, C304AS, C304AS-VERS.2006, C304AVD, C304AVD-VERS.2006, C304AVS, C304AVS-VERS.2006, C304D, C304D-VERS.2006, C304S, C304S-VERS.2006, C304VD, C304VD-VERS.2006, C304VS, C304VS-VERS.2006, CS243D, CS243D-VERS.2006, CS243S, CS243S-VERS.2006, CS243VD, CS243VD-VERS.2006, CS243VS, CS243VS-VERS.2006, CS370AD, CS370AD-VERS.2006, CS370AS, CS370AS-VERS.2006, CS370AVD, CS370AVD-VERS.2006, CS370AVS, CS370AVS-VERS.2006, CS370D, CS370D-VERS.2006, CS370S, CS370S-VERS.2006, CS370VD, CS370VD-VERS.2006, CS370VS, CS370VS-VERS.2006, CS466AD, CS466AD-VERS.2006...(Weitere Modelle finden Sie in unserem Webshop)		



Diverse

Regelthermostate mit Vorsatzschalter



<b>GEV-Nr.</b>	375267	<b>Vergl.-Nr.</b>	32Z3550 32Z3551
<b>Beschreibung</b>	Thermostat T.max. 290°C Arbeitsbereich 50-290°C 3-polig 3NO Fühler ø 3mm Fühler L 219mm Kapillarrohr 1200mm Kapillarrohr isoliert 1200mm Achsstellung unten Drehwinkel 270°		
<b>Für Modelle:</b>	1G1FA0E, 1G1FA0EV, 1G1PE1E, 1G1PE1EV, 1G1PE2E, 1G1PE2EV, 2G1FA0E, 2G1PE1E, 2G1PE1EV, 2G1PE2E, 2G1PE2EV, 31GE, 31TCE, 32TCE		



<b>GEV-Nr.</b>	375265	<b>Vergl.-Nr.</b>	32W0030
<b>Beschreibung</b>	Thermostat T.max. 300°C Arbeitsbereich 50-300°C 3-polig 3NO 16A Fühler ø 6mm Fühler L 79mm Kapillarrohr 1740mm Kapillarrohr isoliert 800mm Achse ø 6x4,6mm Drehwinkel 270°		
<b>Ersatzteile für</b>	375265		
	<b>GEV-Nr.</b>	<b>Vergl.-Nr.</b>	<b>32Z2560</b>
	375038		
	Thermostat T.max. 300°C Arbeitsbereich 50-300°C 3-polig 3NO 16A Fühler ø 6mm Fühler L 79mm Kapillarrohr 1740mm Kapillarrohr isoliert 800mm Stopfbuchse Achse ø 6x4,6mm Achslänge 23mm Achsstellung oben Drehwinkel 270°		
	<b>GEV-Nr.</b>	<b>Vergl.-Nr.</b>	—
	550059		
	Verbindungsbügel kurz für Schalter VPE 1 Stück		

Zubehör

Stopfbuchsenzubehör

Durchführungen



<b>GEV-Nr.</b>	560623	<b>Vergl.-Nr.</b>	3003400
<b>Beschreibung</b>	Stopfbuchsendurchführung AG M16 IG M10x1 SW 19 L 18mm		
<b>Für Modelle:</b>	FM101E2-VERS.2006, FM101E3, FM101E3-VERS.2006, FM101G2-VERS.2006, FM101G3, FM101G3-VERS.2006, FM1221E2-VERS.2006, FM1221E3, FM1221E3-VERS.2006, FM1221G2-VERS.2006, FM1221G3, FM1221G3-VERS.2006, FM2011E2-VERS.2006, FM2011E3-VERS.2006, FM2011G2-VERS.2006, FM2011G3-VERS.2006, FM2021E2-VERS.2006, FM2021E3, FM2021E3-VERS.2006, FM2021G2-VERS.2006, FM2021G3, FM2021G3-VERS.2006, FM423E2, FM611E2-VERS.2006, FM611E3, FM611E3-VERS.2006, FM611G2-VERS.2006, FM611G3, FM611G3-VERS.2006, FM721E2-VERS.2006, FM721E3, FM721E3-VERS.2006, FM721G2-VERS.2006, FM721G3, FM721G3-VERS.2006, FX101E2, FX101E2C, FX101E2C-VERS.032014, FX101E2R, FX101E2R-VERS.032014, FX101E2-VERS.032014, FX101E3, FX101E3C, FX101E3C-VERS.022014, FX101E3R, FX101E3R-VERS.022014, FX101E3-VERS.022014, FX101G2, FX101G2C, FX101G2C-VERS.032014...(Weitere Modelle finden Sie in unserem Webshop)		

## Schalter und Taster

### Wippschalter/-taster

30x22mm

beschriftet



<b>GEV-Nr.</b>	300125	<b>Vergl.-Nr.</b>	32W0860 32W2331 32W2990
<b>Beschreibung</b>	Wippschalter Einbaumaß 30x22mm grün 2NO 230V 16A 0-I Anschluss Flachstecker 6,3mm Umgebungstemperatur max. 125/55°C Schutzart IP65 mit Abdeckkappe		
<b>Für Modelle:</b>	120, 120B, 120NN, 120PV, 135, 135-4, 135A, 135B, 135BA, 135BN, 135BNX, 135BX, 135BXE, 135BXR, 135CPX, 135NN, 135NNX, 135PVX, 135X, 135X-3, 135X-4, 135XE, 135XR, 40, 40B, 40CP, 40CPX, 40EV, 40EVP, 40PL, 40PV, 40X, 40XPV, 55, 55B, 55PV, 65, 65A, 65B, 65BA, 65BX, 65BX-2, 65BXE, 65BXR, 65NB, 65NBX, 65NN, 65NNX, 65PVX, 65X...(Weitere Modelle finden Sie in unserem Webshop)		
<b>Zubehör für</b>	300125		
	<b>GEV-Nr.</b>	<b>Vergl.-Nr.</b>	—
	301036		
	Schutzhaube Innenmaß 30x22mm für Wippschalter Einbaumaß-mm		



<b>GEV-Nr.</b>	301164	<b>Vergl.-Nr.</b>	32W0631
<b>Beschreibung</b>	Wippschalter Einbaumaß 30x22mm grün 2NO 250V 16A beleuchtet Anschluss Flachstecker 6,3mm Umgebungstemperatur max. 85°C Schutzart IP65 mit Abdeckkappe		
<b>Für Modelle:</b>	1G1FA0EV, 1G1FA0GV, 1G1PE1EV, 1G1PE2EV, 2091SCP, 2G1FA0GV, 2G1PE1EV, 2G1PE2EV, 31GE, 31TC, 31TCE, 32TC, 32TCE, FX101E1, FX101E1R, FX101E2, FX101E2C, FX101E2R, FX101E3, FX101E3C, FX101E3C-VERS.022014, FX101E3R, FX101G1, FX101G1R, FX101G2, FX101G2C, FX101G2R, FX101G3, FX101G3C, FX101G3C-VERS.022014, FX101G3R, FX10E2CR, FX10E3CR, FX10E3CR-VERS.022014, FX10G2CR, FX10G3CR, FX10G3CR-VERS.022014, FX122E1, FX122E2, FX122E2C, FX122E3, FX122E3C, FX122G1, FX122G2, FX122G2C, FX122G3, FX122G3C, FX12E3CT, FX12E3CT-VERS.022014, FX12G3CT...(Weitere Modelle finden Sie in unserem Webshop)		
<b>Zubehör für</b>	301164		
	<b>GEV-Nr.</b>	<b>Vergl.-Nr.</b>	—
	301036		
	Schutzhaube Innenmaß 30x22mm für Wippschalter Einbaumaß-mm		

### Druckschalter/-taster

19x13mm



<b>GEV-Nr.</b>	347431	<b>Vergl.-Nr.</b>	3126050
<b>Beschreibung</b>	Drucktaster Einbaumaß 19x13mm rot 1NO 250V 16A Anschluss Flachstecker 6,3mm Umgebungstemperatur max. 105/55°C Schutzart IP40		
<b>Für Modelle:</b>	090FAA, 091FR11, 091FR11-VERS.032012, 091FR7G, 091FR7G-VERS.052012, 10CP1GA, 12CP1GA, 18CP2GA, 190FAA, 191FR21, 191FR21-VERS.032012		

			
1			
<b>GEV-Nr.</b>	301054	<b>Vergl.-Nr.</b>	3062550 3126060+3126050 6300676
<b>Beschreibung</b>	Drucktaster Einbaumaß 19x13mm rot 1NO 250V 16A Anschluss Flachstecker 6,3mm Umgebungstemperatur max. 105/55°C Schutzart IP65 mit Abdeckkappe		
<b>Für Modelle:</b>	090BM1G, 090FAVA, 090FT1G, 090FT2G, 090FT4G, 090FT5G, 090FT7G, 090GRG, 091CP1G, 190BM2G, 190FAB, 190FT15G, 190FT1G, 190FT2G, 190FT3G, 190FT42G, 190FT4G, 190FT6G, 190FT72G, 190FT7G, 190GRG, 190TP0, 191CP1G, 191CP1GA, 191CP2G, 191FAAG, 191FABG, 191FADG, 191FAG, 191PD1G, 191PD2G, 191PI1G, 191PI1GA, 191PI2G, 191PI2GA, 191TPG, 291FAG, 291FAGF, 291PD3G, 291PI3G, 291TPCG, 391FAG, G1FAGS, G1FAGST		

<b>ø25mm</b>			
			
1			
<b>GEV-Nr.</b>	301322	<b>Vergl.-Nr.</b>	3203760
<b>Beschreibung</b>	Druckschalter Einbau ø 25mm silber 1NO/1NC 250V 5A Edelstahl Anschluss Flachstecker 2,8mm		
<b>Für Modelle:</b>	B151H, B151M, FX201E2, FX201E2P, FX201E2P-VERS.032014, FX201E2-VERS.032014, FX201E3, FX201E3P, FX201E3P-VERS.022014, FX201E3-VERS.022014, FX201G2, FX201G2P, FX201G2P-VERS.032014, FX201G2-VERS.032014, FX201G3P, FX201G3-VERS.022014, FX202E2, FX202E2-VERS.032014, FX202E3, FX202E3-230V-3-50Hz-60Hz, FX202E3-230V-3-50Hz-60Hz-VERS.022014, FX202E3-VERS.022014, FX202G2, FX202G2-VERS.032014, FX202G3, FX202G3-VERS.022014		

**Mikroschalter**

<b>hebelbetätigt</b>			
			
1			
<b>GEV-Nr.</b>	345257	<b>Vergl.-Nr.</b>	32W4240
<b>Beschreibung</b>	Mikroschalter mit Hebel 250V 16A 1CO Anschluss Flachstecker 6,3mm L 29mm L1 33mm Umgebungstemperatur max. 120°C BA 22mm Betätigungskraft: 130g Hebellänge 31.5mm		
<b>Für Modelle:</b>	KD40EPSD, KD40LEPS, KD40LUX, KD40LUXE, KD60, KD60E, KD60EAT, KD60M, KD60MA, KD60ME, KD60MPS, KD60MPSA, KD60PS, KD60PSD, KD6EATSD, KD85, KD85A, KD85E, KD85EA, KD85EAT, KD85EATS, KD85EPS, KD85EPSA, KD85PS, KD85PSA, LP70		

			
1			
<b>GEV-Nr.</b>	345254	<b>Vergl.-Nr.</b>	32W1320
<b>Beschreibung</b>	Mikroschalter mit Hebel 250V 16A 1CO Anschluss Flachstecker 6,3mm Umgebungstemperatur max. 120°C BA 22mm Betätigungskraft: 60g Hebellänge 58mm		

			
1			
<b>GEV-Nr.</b>	346907	<b>Vergl.-Nr.</b>	32W0020
<b>Beschreibung</b>	Mikroschalter mit Hebel 250V 16A 1CO Anschluss Flachstecker Umgebungstemperatur max. 85°C		

**stiftbetätigt**

<b>M10</b>			
			
1			
<b>GEV-Nr.</b>	347216	<b>Vergl.-Nr.</b>	32W1660 32W3020 32W3340
<b>Beschreibung</b>	Mikroschalter mit Druckstift Gewinde M10x0,75 Gewinde L 14mm 250V 10A 1CO Anschluss Flachstecker 6,3mm Hub 7.5mm BA 22mm L 28mm Umgebungstemperatur max. 125°C Typ NR6K5 Betätigungskraft: 260g		
<b>Für Modelle:</b>	030FE, 030FE1, 030FE1B, 04WFR3ED, 08WFR4ED, 091FE28, 091FE28B, 091FR3E, 091FR3ED, 0A1FR3E, 0A1FR3ED, 0D1FR3E, 0D1FR3ED, 0G0FR3E, 0G0FR3ED, 10CP1EA, 10CP1GA, 10CP1IA, 12CP1EA, 12CP1GA, 12CP1IA, 18CP2EA, 18CP2GA, 18CP2IA, 191BR1E, 191BR1G, 191BR2E, 191BR2G, 191FR4E, 191FR4ED, 1A1FR4E, 1A1FR4ED, 1D1FR4E, 1D1FR4ED, 1G0FR4E, 291BR1E, 291BR1G, 291BR2E, 291BR2G, 30FES, 30FES2, 30FES2B, 6043840, 6043970, 70FE, 70FE1, 70FE1B, 70FES, 70FES2, 70FES2B...(Weitere Modelle finden Sie in unserem Webshop)		

			
1			
<b>GEV-Nr.</b>	345032	<b>Vergl.-Nr.</b>	32W2290
<b>Beschreibung</b>	Mikroschalter mit Druckstift Gewinde M10x1 Gewinde L 12mm 250V 16A 1CO Anschluss Flachstecker 6,3mm Hub 7mm BA 22mm L 28mm Umgebungstemperatur max. 125°C Typ SP9603 Betätigungskraft: 180g		

<b>M12</b>			
			
1			
<b>GEV-Nr.</b>	345360	<b>Vergl.-Nr.</b>	32W1410
<b>Beschreibung</b>	Mikroschalter mit Druckstift BA 25.4mm Gewinde M12x1 Gewinde L 15mm 250V 10A 1CO Anschluss Schraubanschluss Hub 5mm Umgebungstemperatur max. 125°C Typ Highly D5000 Betätigungskraft: 200g		
<b>Für Modelle:</b>	65NN, SP65NN		







			
1			
<b>GEV-Nr.</b>	345679	<b>Vergl.-Nr.</b>	32W0960
<b>Beschreibung</b>	Mikroschalter mit Druckstift BA 25mm Gewinde M12x1 Gewinde L 9mm 250V 5A 1CO Anschluss Flachstecker 6,3mm Hub 5mm Umgebungstemperatur max. 125°C Typ MF12 Betätigungskraft: 680g		
<b>Für Modelle:</b>	31RE, 71AR		

Sonderbauformen			
			
1			
<b>GEV-Nr.</b>	346183	<b>Vergl.-Nr.</b>	33Q5620 6300496
<b>Beschreibung</b>	Mikroschalter Anschluss Flachstecker		
<b>Für Modelle:</b>	FC101, FC101E, FC241, FC241E, FC241G, FC61, FC61E, FCV101, FCV101DM, FCV101DS, FCV101E, FCV101EDM, FCV101EDS, FCV141, FCV141DM, FCV141DM-CSA, FCV141DS, FCV141E, FCV141EDM, FCV141EDS, FCV241, FCV241DM, FCV241DS, FCV241E, FCV241EDM, FCV241EDS, FCV241G, FCV241GDM, FCV241GDS, FCV401DM, FCV401EDM, FCV61, FCV61DM, FCV61DS, FCV61E, FCV61EDM, FCV61EDS		

Zubehör			
			
1			
<b>GEV-Nr.</b>	691143	<b>Vergl.-Nr.</b>	36D8360
<b>Beschreibung</b>	Bolzen für Mikroschalter		
<b>Für Modelle:</b>	FC101, FC101E, FC241, FC61, FC61E, FCV101, FCV101-CSA, FCV101DM, FCV101DM-CSA, FCV101DS, FCV101DS-CSA, FCV101E, FCV101EDM, FCV101EDM-UL, FCV101EDS, FCV101EDS-UL, FCV101E-UL, FCV141, FCV141-CSA, FCV141DM, FCV141DM-CSA, FCV141DS, FCV141DS-CSA, FCV141E, FCV141EDM, FCV141EDS, FCV241, FCV241DM, FCV241DS, FCV401DM, FCV401DM-CSA, FCV401EDM, FCV401EDM-UL, FCV61, FCV61-CSA, FCV61DM, FCV61DM-CSA, FCV61DS, FCV61DS-CSA, FCV61E, FCV61EDM, FCV61EDM-UL, FCV61EDS, FCV61EDS-UL, FCV61E-UL, FCV72EDM-UL, FCV72EDS-UL, FCV72E-UL		

			
1			
<b>GEV-Nr.</b>	691140	<b>Vergl.-Nr.</b>	33Q5610
<b>Beschreibung</b>	Buchse für Mikroschalter Gewinde M16x1,5		
<b>Für Modelle:</b>	FC101, FC101E, FC241, FC241E, FC241G, FC61, FC61E, FCV101, FCV101-CSA, FCV101DM, FCV101DM-CSA, FCV101DS, FCV101DS-CSA, FCV101E, FCV101EDM, FCV101EDM-UL, FCV101EDS, FCV101EDS-UL, FCV101E-UL, FCV141, FCV141-CSA, FCV141DM, FCV141DM-CSA, FCV141DS, FCV141DS-CSA, FCV141E, FCV141EDM, FCV141EDS, FCV241, FCV241DM, FCV241DS, FCV241E, FCV241EDM, FCV241EDM-UL, FCV241EDS, FCV241EDS-UL, FCV241E-UL, FCV241G, FCV241G-CSA, FCV241GDM, FCV241GDM-CSA, FCV241GDS, FCV241GDS-CSA, FCV401DM, FCV401DM-CSA, FCV401EDM, FCV401EDM-UL, FCV61, FCV61-CSA, FCV61DM... (Weitere Modelle finden Sie in unserem Webshop)		

			
1			
<b>GEV-Nr.</b>	691141	<b>Vergl.-Nr.</b>	36G7140
<b>Beschreibung</b>	Feder für Mikroschalter		
<b>Für Modelle:</b>	1A1BR1E, 1A1BR1G, 1A1BR1GA, 1A1BR2E, 1A1BR2EA, 1A1BR2G, 1A1BR2GA, 1D1BR1E, 1D1BR1G, 1D1BR1GA, 1D1BR2E, 1D1BR2EA, 1D1BR2G, 1D1BR2GA, 2A1BR1G, 2A1BR1GA, 2A1BR2G, 2A1BR2GA, 2D1BR1G, 2D1BR1GA, 2D1BR2G, 2D1BR2GA, FC101, FC101E, FC241, FC241E, FC241G, FC61, FC61E, FCV101, FCV101-CSA, FCV101DM, FCV101DM-CSA, FCV101DS, FCV101DS-CSA, FCV101E, FCV101EDM, FCV101EDM-UL, FCV101EDS, FCV101EDS-UL, FCV101E-UL, FCV141, FCV141-CSA, FCV141DM, FCV141DM-CSA, FCV141DS, FCV141DS-CSA, FCV141E, FCV141EDM, FCV141EDM-UL, FCV141EDS, FCV141EDS-UL, FCV141E-UL, FCV141G, FCV141G-CSA, FCV141GDM, FCV141GDM-CSA, FCV141GDS, FCV141GDS-CSA, FCV401DM, FCV401DM-CSA, FCV401EDM, FCV401EDM-UL, FCV61, FCV61-CSA, FCV61DM... (Weitere Modelle finden Sie in unserem Webshop)		

			
1			
<b>GEV-Nr.</b>	691138	<b>Vergl.-Nr.</b>	35Q2360
<b>Beschreibung</b>	Gehäuse für Mikroschalter		
<b>Für Modelle:</b>	FC101, FC101E, FC241, FC241E, FC241G, FC61, FC61E, FCV101, FCV101-CSA, FCV101DM, FCV101DM-CSA, FCV101DS, FCV101DS-CSA, FCV101E, FCV101EDM, FCV101EDM-UL, FCV101EDS, FCV101EDS-UL, FCV101E-UL, FCV141, FCV141-CSA, FCV141DM, FCV141DM-CSA, FCV141DS, FCV141DS-CSA, FCV141E, FCV141EDM, FCV141EDM-UL, FCV141EDS, FCV241, FCV241DM, FCV241DS, FCV241E, FCV241EDM, FCV241EDM-UL, FCV241EDS, FCV241EDS-UL, FCV241E-UL, FCV241G, FCV241GDM, FCV241GDM-CSA, FCV241GDS, FCV241GDS-CSA, FCV401DM, FCV401DM-CSA, FCV401EDM, FCV401EDM-UL, FCV61, FCV61-CSA, FCV61DM, FCV61DM-CSA... (Weitere Modelle finden Sie in unserem Webshop)		

			
1			
<b>GEV-Nr.</b>	691142	<b>Vergl.-Nr.</b>	36G6040 36G6041
<b>Beschreibung</b>	Stift für Mikroschalter		
<b>Für Modelle:</b>	FC101, FC101E, FC241, FC241E, FC241G, FC61, FC61E, FCV101, FCV101-CSA, FCV101DM, FCV101DM-CSA, FCV101DS, FCV101DS-CSA, FCV101E, FCV101EDM, FCV101EDM-UL, FCV101EDS, FCV101EDS-UL, FCV101E-UL, FCV141, FCV141-CSA, FCV141DM, FCV141DM-CSA, FCV141DS, FCV141DS-CSA, FCV141E, FCV141EDM, FCV141EDS, FCV241, FCV241DM, FCV241DS, FCV241E, FCV241EDM, FCV241EDM-UL, FCV241EDS, FCV241EDS-UL, FCV241E-UL, FCV241G, FCV241G-CSA, FCV241GDM, FCV241GDM-CSA, FCV241GDS, FCV241GDS-CSA, FCV401DM, FCV401DM-CSA, FCV401EDM, FCV401EDM-UL, FCV61, FCV61-CSA, FCV61DM... (Weitere Modelle finden Sie in unserem Webshop)		

			
1			
<b>GEV-Nr.</b>	691139	<b>Vergl.-Nr.</b>	33Q4120
<b>Beschreibung</b>	Verbindungsstück für Mikroschalter		
<b>Für Modelle:</b>	FC101, FC101E, FC241E, FC241G, FC61, FC61E, FCV101, FCV101-CSA, FCV101DM, FCV101DM-CSA, FCV101DS, FCV101DS-CSA, FCV101E, FCV101EDM, FCV101EDM-UL, FCV101EDS, FCV101EDS-UL, FCV101E-UL, FCV141, FCV141-CSA, FCV141DM, FCV141DM-CSA, FCV141DS, FCV141DS-CSA, FCV141E, FCV141EDM, FCV141EDS, FCV241E, FCV241EDM, FCV241EDM-UL, FCV241EDS, FCV241EDS-UL, FCV241E-UL, FCV241G, FCV241G-CSA, FCV241GDM, FCV241GDM-CSA, FCV241GDS, FCV241GDS-CSA, FCV401DM, FCV401DM-CSA, FCV401EDM, FCV401EDM-UL, FCV61, FCV61-CSA, FCV61DM, FCV61DM-CSA, FCV61DS, FCV61DS-CSA, FCV61E, FCV61EDM... (Weitere Modelle finden Sie in unserem Webshop)		



## Systemschalter ROLD

	<b>1</b>		
<b>GEV-Nr.</b>	345605	<b>Vergl.-Nr.</b>	32W4140
<b>Beschreibung</b>	Schaltelement 2CO 250V 16A Anschluss Flachstecker 6,3mm		

	<b>1</b>		
<b>GEV-Nr.</b>	345720	<b>Vergl.-Nr.</b>	32W4150
<b>Beschreibung</b>	Schaltelement 2NO 250V 16A Anschluss Flachstecker 6,3mm		

<b>Für Modelle:</b>	KD100, KD100A, KD100PSD, KD130, KD130A, KD37, KD37PS, KD37-VERS.112009, KD40, KD40LUX, KD40PS, KD40-VERS.112009, KD60, KD60M, KD60MA, KD60MPS, KD60MPSA, KD60PS, KD60PSD, KD85, KD85A, KD85PS, KD85PSA, KN1100, KN1100SD, KN11PSDD, KN35, KN37, KN37PS, KN40, KN40PS, KN40PSD, KN50, KN50M, KN50MPS, KN50PS, KN50PSD, KN50PSDD, KN80, KN800, KN800PSD, KN80PS, N100D, N100S, N100VD, N100VS, N38D, N38S, N38VD, N38VS...(Weitere Modelle finden Sie in unserem Webshop)		
---------------------	---	--	--

	<b>1</b>		
<b>GEV-Nr.</b>	347193	<b>Vergl.-Nr.</b>	3040850
<b>Beschreibung</b>	Tastelement 1NO 250V 16A Anschluss Flachstecker 6,3mm		
<b>Für Modelle:</b>	KD37, KD37PS, KD37-VERS.112009, KD40, KD40LUX, KD40PS, KD40-VERS.112009, KD60, KD60M, KD60MA, KD60MPS, KD60MPSA, KD60PS, KD60PSD, KD85, KD85A, KD85PS, KD85PSA, KN35, KN37, KN37PS, KN40, KN40PS, KN40PSD, KN50, KN50M, KN50MPS, KN50PS, KN50PSD, KN50PSDD, KN80, KN80PS		

## Schwimmerschalter

	<b>1</b>		
<b>GEV-Nr.</b>	403292	<b>Vergl.-Nr.</b>	6300787
<b>Beschreibung</b>	Schwimmerschalter 1NO ø 12mm Einbau ø 8mm 24V 0.2A Stecker Kabellänge 880mm 1-polig		
<b>Für Modelle:</b>	FX101E3, FX101E3C, FX101E3C-VERS.022014, FX101E3R, FX101E3R-VERS.022014, FX101E3-VERS.022014, FX101G3, FX101G3C, FX101G3C-VERS.022014, FX101G3R, FX101G3R-VERS.022014, FX101G3-VERS.022014, FX10E3CR, FX10E3CR-VERS.022014, FX10G3CR, FX10G3CR-VERS.022014, FX122E3, FX122E3C, FX122E3T, FX122E3T-VERS.022014, FX122G3, FX122G3C, FX122G3T, FX122G3T-VERS.022014, FX12E3CT, FX12E3CT-VERS.022014, FX12G3CT, FX12G3CT-VERS.022014, FX201E3, FX201E3P, FX201E3P-VERS.022014, FX201E3-VERS.022014, FX201G3P, FX201G3-VERS.022014, FX202E3, FX202E3-230V-3-50Hz-60Hz, FX202E3-230V-3-50Hz-60Hz-VERS.022014, FX202E3-VERS.022014, FX202G3, FX202G3-VERS.022014, FX61E3, FX61E3C, FX61E3CR, FX61E3CR-VERS.022014, FX61E3C-VERS.022014, FX61E3R, FX61E3R-VERS.022014, FX61E3-VERS.022014, FX61G3, FX61G3C...(Weitere Modelle finden Sie in unserem Webshop)		

## Nockenschalter

## Ein/Aus

	<b>1</b>		
<b>GEV-Nr.</b>	301115	<b>Vergl.-Nr.</b>	3168540
<b>Beschreibung</b>	Nockenschalter 2 Schaltstellungen 2NO Schaltfolge 0-1 16A Achse ø 6x4,6mm Achslänge 23mm Anschluss Flachstecker 6,3mm		
<b>Für Modelle:</b>	091FR11, 091FR11-VERS.032012, 191FR21, 191FR21-VERS.032012, 6043840, 6043970		

	<b>1</b>		
<b>GEV-Nr.</b>	300088	<b>Vergl.-Nr.</b>	32W3830
<b>Beschreibung</b>	Nockenschalter 2 Schaltstellungen 4NO Schaltfolge 0-1 16A Achse ø 6x4,6mm Achslänge 23mm Anschluss Flachstecker 6,3mm Keramik		
<b>Für Modelle:</b>	0M0BR1E, 0M0FR1E, 0M0FT1E, 0M0FT2E, 0M0FT4E, 0M0FT5E, 0M0GR1E, 0M0GR2E, 1M0FR2E, 1M0FT1E, 1M0FT2E, 1M0FT3E, 1M0FT4E, 1M0FT5E, 1M0FT6E, 2M0FT1E, 2M0FT2E, 2M0FT3E, 2M0FT4E, 2M0FT5E, 2M0FT6E		

	<b>1</b>			
<b>GEV-Nr.</b>	300020	<b>Vergl.-Nr.</b>	32W0490 32W3610	
<b>Beschreibung</b>	Nockenschalter 4 Schaltstellungen 2NO Schaltfolge 0-1-0-1 16A Achse ø 6x4,6mm Achslänge 23mm Anschluss Schraubanschluss Keramik			
<b>Für Modelle:</b>	04WFR3ED, 06WFR3GD, 08WFR4ED, 091FR1ED, 091FR1GD, 091FR3ED, 091FR3GD, 0A1FR1ED, 0A1FR1GD, 0A1FR1GD-VERS.2004, 0B1FR1GD, 0D1FR1ED, 0D1FR1GD, 0D1FR1GD-VERS.2004, 0G0FR3ED, 0G1FR3GD, 10WFR4GD, 191FR2ED, 191FR2GD, 191FR4ED, 191FR4GD, 1A1FR2ED, 1A1FR2GD, 1A1FR2GD-VERS.2004, 1A1PI2G, 1A1PI2GA, 1D1FR2ED, 1D1FR2GD, 1D1FR2GD-VERS.2004, 1D1PI2G, 1D1PI2GA, 1G1FR4GD, 291PI3G, 2A1PI3G, 2D1PI3G, FC101, FC101E, FC241, FC241E, FC241G, FC61, FC61E, L100, L80			
<b>Zubehör für</b>	300020			
	<b>GEV-Nr.</b>	110135	<b>Vergl.-Nr.</b>	—
	Rosette Knebel bis ø 52mm			
	<b>GEV-Nr.</b>	110231	<b>Vergl.-Nr.</b>	—
	Knebel Schalter 0-1-0-1 T.max.°C ø 50mm Achse ø 6x4,6mm Abflachung oben schwarz			

7-Takt



<b>GEV-Nr.</b>	300106	<b>Vergl.-Nr.</b>	32W2920
<b>Beschreibung</b>	Nockenschalter 7 Schaltstellungen 1NO/2CO Schaltfolge 0-1-2-3-4-5-6 32A Achse $\varnothing$ 6x4,6mm Achslänge 23mm Anschluss Schraubanschluss 7-Takt Abflachung oben		
<b>Für Modelle:</b>	60SME		

3 Schaltstellungen

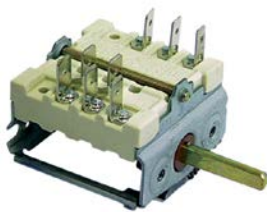

<b>GEV-Nr.</b>	345171	<b>Vergl.-Nr.</b>	3041660	
<b>Beschreibung</b>	Nockenschalter 3 Schaltstellungen 3NO Schaltfolge 0-1-2 16A Achse $\varnothing$ 6x4,6mm Achslänge 26mm Anschluss Flachstecker 6,3mm Keramik			
<b>Für Modelle:</b>	FC1011E, FC1011G, FC1221E, FC1221G, FC611E, FC611G			
<b>Zubehör für</b>	345171			
	<b>GEV-Nr.</b>	112340	<b>Vergl.-Nr.</b>	—
	Knebel Schalter Nullstrich T.max.°C Arbeitsbereich °C $\varnothing$ 40mm Achse $\varnothing$ 6x4,6mm Abflachung links schwarz			

4 Schaltstellungen

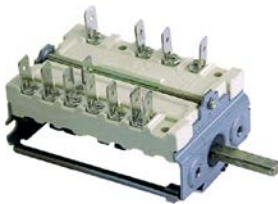

<b>GEV-Nr.</b>	300010	<b>Vergl.-Nr.</b>	32Z0540
<b>Beschreibung</b>	Nockenschalter 4 Schaltstellungen 2NO/2CO Schaltfolge 0-1-2-3 16A Achse $\varnothing$ 6x4,6mm Achslänge 23mm Anschluss Flachstecker 6,3mm Keramik		

Magnetschalter

37x16mm

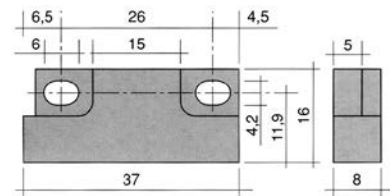

<b>GEV-Nr.</b>	345600	<b>Vergl.-Nr.</b>	32V5740 32W2160	
<b>Beschreibung</b>	Magnetschalter L 37mm B 16mm 1NO 250V 0.2A P max. 50W Anschluss Kabel Kabellänge 960mm			
<b>Für Modelle:</b>	BX101E, BX101E-VERS.122013, BX101G, BX101G-VERS.122013, BX122E, BX122E-VERS.122013, BX122G, BX122G-VERS.122013, BX61E, BX61E-VERS.122013, BX61G, BX61G-VERS.122013, BX82E, BX82E-VERS.122013, BX82G, BX82G-VERS.122013, FM1011E1, FM1011E1-VERS.2006, FM1011E2, FM1011E2-VERS.2006, FM1011E3, FM1011E3-VERS.2006, FM1011G1, FM1011G1-VERS.2006, FM1011G2, FM1011G2-VERS.2006, FM1011G3, FM1011G3-VERS.2006, FM1221E1, FM1221E1-VERS.2006, FM1221E2, FM1221E2-VERS.2006, FM1221E3, FM1221E3-VERS.2006, FM1221G1, FM1221G1-VERS.2006, FM1221G2, FM1221G2-VERS.2006, FM1221G3, FM1221G3-VERS.2006, FM2011E2-VERS.2006, FM2011E3-VERS.2006, FM2011G2-VERS.2006, FM2011G3-VERS.2006, FM2021E1, FM2021E2, FM2021E2-VERS.2006, FM2021E3, FM2021E3-VERS.2006, FM2021G1...(Weitere Modelle finden Sie in unserem Webshop)			
<b>Zubehör für</b>	345600			
	<b>GEV-Nr.</b>	519049	<b>Vergl.-Nr.</b>	3023650 32W0870 32W1680
	Magnet $\varnothing$ mm L 63mm H 10.7mm B 18.8mm LA 52mm M2 Loch $\varnothing$ 2mm			

65x20mm

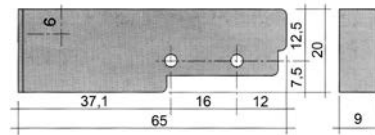
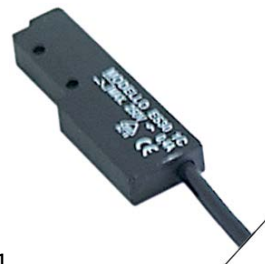

<b>GEV-Nr.</b>	345116	<b>Vergl.-Nr.</b>	32W1210	
<b>Beschreibung</b>	Magnetschalter L 65mm B 20mm 1NO 250V 0.4A P max. 100W Anschluss Kabel Kabellänge 3000mm			
<b>Für Modelle:</b>	LT25F			
<b>Zubehör für</b>	345116			
	<b>GEV-Nr.</b>	345399	<b>Vergl.-Nr.</b>	—
	Magnet $\varnothing$ 3.3mm L 40mm H 8mm B 13mm LA 30mm M3			

M10x0,75



<b>GEV-Nr.</b>	348024	<b>Vergl.-Nr.</b>	32W1890 32W3460
<b>Beschreibung</b>	Magnetschalter 1NO 250V 1A P max. 10W Anschluss Faston 6,3mm Kabellänge 2000mm		
<b>Für Modelle:</b>	CX65NB, CX65NCP, CX65NN, CX70NB, CX70NN, DS31, DS31A, DS31C, DS31M, DS51, DS51A, DS51C, DS51M, FS611, IA101L, IA101S, IA51, IA51A, IA51C, IA51M, IA72S, IS101L, IS101LR, IS101LW, IS101S, IS101SR, IS101SW, IS102S, IS102SR-ONR01, IS102SW, IS51, IS51A, IS51AR, IS51C, IS51CR, IS51M, IS51MR, IS51R, IS51W, IS51WA, IS51WC, IS51WM, IS72S, IS72SR, IS72SW, ISP202R, ISR201R, ISR202R, MD70NB, MD70NCP...(Weitere Modelle finden Sie in unserem Webshop)		

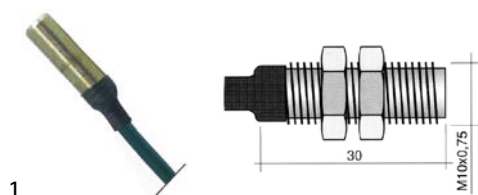

<b>GEV-Nr.</b>	345632	<b>Vergl.-Nr.</b>	32W3200 32W3240 32Z8650
<b>Beschreibung</b>	Magnetschalter Gewinde M10x0,75 1NO 250V 0.5A P max. 50W Anschluss Kabel Kabellänge 2000mm Typ 102		
<b>Für Modelle:</b>	C165D, C165S, C165VD, C165VS, C207D, C207D-VERS.2006, C207S, C207S-VERS.2006, C207VD, C207VD-VERS.2006, C207VS, C207VS-VERS.2006, C304AD, C304AD-VERS.2006, C304AS, C304AS-VERS.2006, C304AVD, C304AVD-VERS.2006, C304AVS, C304AVS-VERS.2006, C304V, C304V-VERS.2006, C304VS, C304VS-VERS.2006, C92D-VERS.2006, C92S-VERS.2006, C92VD-VERS.2006, C92VS-VERS.2006, CS243D, CS243D-VERS.2006, CS243S, CS243S-VERS.2006, CS243VD, CS243VD-VERS.2006, CS243VS, CS243VS-VERS.2006, CS370AD, CS370AD-VERS.2006, CS370AS, CS370AS-VERS.2006, CS370AVD, CS370AVD-VERS.2006, CS370AVS, CS370AVS-VERS.2006, CS370D, CS370D-VERS.2006...(Weitere Modelle finden Sie in unserem Webshop)		

<b>Zubehör für</b>	345632		
	<b>GEV-Nr.</b>	100779	<b>Vergl.-Nr.</b>
			—
	Mutter Gewinde M10x0,75 H 3mm SW 14 CNS VPE 2 Stück		

Zubehör

Magnete



<b>GEV-Nr.</b>	691178	<b>Vergl.-Nr.</b>	3008810 3112370 3600090
<b>Beschreibung</b>	Magnet ø 22mm Lmm H 7mm Bmm AD ø 22mm M5		
<b>Für Modelle:</b>	FC1011E, FC1011G, FC1221E, FC1221G, FC611E, FC611G, FM1011E1, FM1011E1-VERS.2006, FM1011E2, FM1011E2-VERS.2006, FM1011E3, FM1011E3-VERS.2006, FM1011G1, FM1011G1-VERS.2006, FM1011G2, FM1011G2-VERS.2006, FM1011G3, FM1011G3-VERS.2006, FM1221E1, FM1221E1-VERS.2006, FM1221E2, FM1221E2-VERS.2006, FM1221E3, FM1221E3-VERS.2006, FM1221G1, FM1221G1-VERS.2006, FM1221G2, FM1221G2-VERS.2006, FM1221G3, FM1221G3-VERS.2006, FM2011E2-VERS.2006, FM2011E3-VERS.2006, FM2011G2-VERS.2006, FM2011G3-VERS.2006, FM2021E1, FM2021E2, FM2021E2-VERS.2006, FM2021E3, FM2021E3-VERS.2006, FM2021G1, FM2021G2, FM2021G2-VERS.2006, FM2021G3, FM2021G3-VERS.2006, FM611E1, FM611E1-VERS.2006, FM611E2, FM611E2-VERS.2006, FM611E3, FM611E3-VERS.2006...(Weitere Modelle finden Sie in unserem Webshop)		

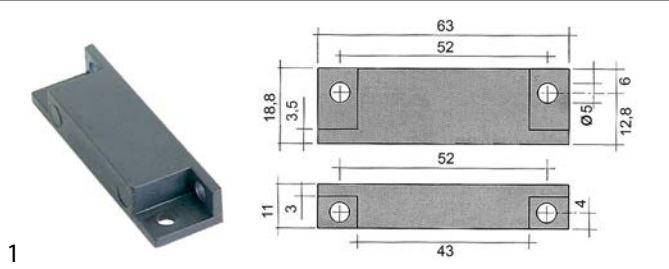

<b>GEV-Nr.</b>	345336	<b>Vergl.-Nr.</b>	3210010
<b>Beschreibung</b>	Magnet ø 4.8mm L 63mm H 11mm B 18.8mm LA 51mm M4		
<b>Für Modelle:</b>	LP151, LP202, LP202HC, LP302, LP302HC, LP402, LP402HC, LP402V, LPG300		



<b>GEV-Nr.</b>	519049	<b>Vergl.-Nr.</b>	3023650 32W0870 32W1680
<b>Beschreibung</b>	Magnet ømm L 63mm H 10.7mm B 18.8mm LA 52mm M2 Loch ø 2mm		
<b>Für Modelle:</b>	C165D, C165S, C165VD, C165VS, C207D, C207D-VERS.2006, C207S, C207S-VERS.2006, C207VD, C207VD-VERS.2006, C207VS, C207VS-VERS.2006, C304AD, C304AD-VERS.2006, C304AS, C304AS-VERS.2006, C304AVD, C304AVD-VERS.2006, C304AVS, C304AVS-VERS.2006, C304D, C304D-VERS.2006, C304S, C304S-VERS.2006, C304VD, C304VD-VERS.2006, C304VS, C304VS-VERS.2006, C92D-VERS.2006, C92S-VERS.2006, C92VD-VERS.2006, C92VS-VERS.2006, CS243D, CS243D-VERS.2006, CS243S, CS243S-VERS.2006, CS243VD, CS243VD-VERS.2006, CS243VS, CS243VS-VERS.2006, CS370AD, CS370AD-VERS.2006, CS370AS, CS370AS-VERS.2006, CS370AVD, CS370AVD-VERS.2006, CS370AVS, CS370AVS-VERS.2006, CS370D, CS370D-VERS.2006...(Weitere Modelle finden Sie in unserem Webshop)		
<b>Zubehör für</b>	519049		
	<b>GEV-Nr.</b>	560095	<b>Vergl.-Nr.</b> —
	Blechschraben ø 2.9mm L 9.5mm CNS VPE 20 Stück DIN 7981/ISO 7049 Kopf ø 5.6mm Linsenkopf		

<b>GEV-Nr.</b>	300272	<b>Vergl.-Nr.</b>	3104220 6300966
<b>Beschreibung</b>	Encoder Achse ø 6x4,6mm für Kombidämpfer		
<b>Für Modelle:</b>	BX101E-VERS.122013, BX101G-VERS.122013, BX122E-VERS.122013, BX122G-VERS.122013, BX61E-VERS.122013, BX61G-VERS.122013, BX82E-VERS.122013, BX82G-VERS.122013, FX101E1, FX101E1R, FX101E2, FX101E2C, FX101E2C-VERS.032014, FX101E2R, FX101E2R-VERS.032014, FX101E2-VERS.032014, FX101E3, FX101E3C, FX101E3C-VERS.022014, FX101E3R, FX101E3R-VERS.022014, FX101E3-VERS.022014, FX101G1, FX101G1R, FX101G2, FX101G2C, FX101G2C-VERS.032014, FX101G2R, FX101G2R-VERS.032014, FX101G2-VERS.032014, FX101G3, FX101G3C, FX101G3C-VERS.022014, FX101G3R, FX101G3R-VERS.022014, FX101G3-VERS.022014, FX10E2CR, FX10E2CR-VERS.032014, FX10E3CR, FX10E3CR-VERS.022014, FX10G2CR, FX10G2CR-VERS.032014, FX10G3CR, FX10G3CR-VERS.022014, FX122E1, FX122E2, FX122E2C, FX122E2T, FX122E2T-VERS.032014, FX122E3...(Weitere Modelle finden Sie in unserem Webshop)		

<b>GEV-Nr.</b>	300230	<b>Vergl.-Nr.</b>	32V5580
<b>Beschreibung</b>	Potentiometer		
<b>Für Modelle:</b>	FM1011E1, FM1011E2, FM1011E3, FM1011G1, FM1011G2, FM1011G3, FM1221E1, FM1221E2, FM1221E3, FM1221G1, FM1221G2, FM1221G3, FM2021E1, FM2021E2, FM2021E3, FM2021G1, FM2021G2, FM2021G3, FM611E1, FM611E2, FM611E3, FM611G1, FM611G2, FM611G3, FM721E1, FM721E2, FM721E3, FM721G1, FM721G2, FM721G3, FS611		

## Encoder und Potentiometer

<b>GEV-Nr.</b>	402322	<b>Vergl.-Nr.</b>	3051070
<b>Beschreibung</b>	Encoder		
<b>Für Modelle:</b>	BX101E, BX101G, BX122E, BX122G, BX61E, BX61G, BX82E, BX82G, FM1011E1-VERS.2006, FM1011E2-VERS.2006, FM1011E3-VERS.2006, FM1011G1-VERS.2006, FM1011G2-VERS.2006, FM1011G3-VERS.2006, FM1221E1-VERS.2006, FM1221E2-VERS.2006, FM1221E3-VERS.2006, FM1221G1-VERS.2006, FM1221G2-VERS.2006, FM1221G3-VERS.2006, FM2011E2-VERS.2006, FM2011E3-VERS.2006, FM2011G2-VERS.2006, FM2011G3-VERS.2006, FM2021E2-VERS.2006, FM2021E3-VERS.2006, FM2021G2-VERS.2006, FM2021G3-VERS.2006, FM423E1, FM423E2, FM611E1-VERS.2006, FM611E2-VERS.2006, FM611E3-VERS.2006, FM611G1-VERS.2006, FM611G2-VERS.2006, FM611G3-VERS.2006, FM721E1-VERS.2006, FM721E2-VERS.2006, FM721E3-VERS.2006, FM721G1-VERS.2006, FM721G2-VERS.2006, FM721G3-VERS.2006		

## Lampen

### Signallampen

#### Signallampen 2-teilig (Linse und Signalelement)

##### Signalelemente für Fassungsstyp SRZ / SDK / SDY / SFK

<b>GEV-Nr.</b>	359130	<b>Vergl.-Nr.</b>	32W4220
<b>Beschreibung</b>	Signalelement 230V klar Anschluss Flachstecker 6,3mm ø 8mm		
<b>Für Modelle:</b>	KD100, KD100A, KD100PSD, KD37, KD37PS, KD37-VERS.112009, KD40, KD40LUX, KD40PS, KD40-VERS.112009, KD60, KD60M, KD60MA, KD60MPS, KD60MPSA, KD60PS, KD60PSD, KD85, KD85A, KD85PS, KD85PSA, KN1100, KN1100SD, KN11PSDD, KN35, KN37, KN37PS, KN40, KN40PS, KN40PSD, KN50, KN50M, KN50MPS, KN50PS, KN50PSD, KN50PSDD, KN80, KN800, KN800PSD, KN80PS		

#### Signallampen komplett

##### ø 6mm

<b>GEV-Nr.</b>	359005	<b>Vergl.-Nr.</b>	32W2250
<b>Beschreibung</b>	Signallampe ø 6mm 230V gelb Kabellänge 400mm		
<b>Für Modelle:</b>	FC101, FC1011E, FC1011G, FC101E, FC1221E, FC1221G, FC241, FC241E, FC241G, FC61, FC611E, FC611G, FC61E, FMS, FMSX		





			
1			
<b>GEV-Nr.</b>	359004	<b>Vergl.-Nr.</b>	32W0101
<b>Beschreibung</b>	Signallampe ø 6mm 230V grün Kabellänge 400mm Temp.Best. 106°C		
<b>Für Modelle:</b>	FC101, FC1011E, FC1011G, FC101E, FC1221E, FC1221G, FC241, FC241E, FC241G, FC61, FC611E, FC611G, FC61E, FMS, FMSX		

			
1			
<b>GEV-Nr.</b>	359009	<b>Vergl.-Nr.</b>	32W0450
<b>Beschreibung</b>	Signallampe ø 6mm 230V rot Kabellänge 400mm mit Vorwiderstand		
<b>Für Modelle:</b>	FC101, FC1011E, FC1011G, FC101E, FC1221E, FC1221G, FC241, FC241E, FC241G, FC61, FC611E, FC611G, FC61E		

**ø10mm mit Schraubfassung**

			
1			
<b>GEV-Nr.</b>	359379	<b>Vergl.-Nr.</b>	3106730 32W0790 32W0791
<b>Beschreibung</b>	Signallampe ø 10mm 230V gelb Anschluss Flachstecker 6,3mm Fassung Schraubfassung		
<b>Für Modelle:</b>	030BME, 030EBM, 030FE, 030FE1, 030FE1B, 030FTE, 030FTER, 031BME, 031EBM, 031FTE, 031FTER, 031FTERL, 04WBMEV, 04WCP1EM, 04WFR3ED, 06WBR3E, 06WFR3GD, 06WFT1EV, 06WFT2EV, 06WFT3EV, 06WFT4EV, 06WFT6EV, 06WFT7EV, 070BME, 070FTE, 070FTER, 071BME, 071FTE, 071FTER, 071FTERL, 08WFA4E, 08WFAAE, 08WFR4ED, 08WFT1EV, 08WFT2EV, 08WFT3EV, 08WFT4EV, 08WFT6EV, 08WFT7EV, 090BM1E, 090BME, 090FT1E, 090FT2E, 090FT4E, 090FT5E, 090FT7E, 090FTE, 090FTER, 091BME, 091CP1E... (Weitere Modelle finden Sie in unserem Webshop)		

			
1			
<b>GEV-Nr.</b>	359378	<b>Vergl.-Nr.</b>	3106710 32W1330 32W1331
<b>Beschreibung</b>	Signallampe ø 10mm 230V grün Anschluss Flachstecker 6,3mm Fassung Schraubfassung		
<b>Für Modelle:</b>	030BME, 030E, 030EBM, 030FE, 030FE1, 030FE1B, 030FTE, 030FTER, 031BME, 031E, 031EBM, 031FTE, 031FTER, 031FTERL, 04WBMEV, 04WCP1EM, 04WFR3ED, 04WPE4V, 04WVT3RV, 06WBR3E, 06WCP1GM, 06WFR3GD, 06WFT1EV, 06WFT2EV, 06WFT3EV, 06WFT4EV, 06WFT6EV, 06WFT7EV, 070BME, 070E, 070FTE, 070FTER, 071BME, 071E, 071FTE, 071FTER, 071FTERL, 08WCP1GM, 08WFA4E, 08WFAAE, 08WFR4ED, 08WFT1EV, 08WFT2EV, 08WFT3EV, 08WFT4EV, 08WFT6EV, 08WFT7EV, 08WGREV, 08WPE4V, 090BM1E... (Weitere Modelle finden Sie in unserem Webshop)		

			
1			
<b>GEV-Nr.</b>	359380	<b>Vergl.-Nr.</b>	32W1340
<b>Beschreibung</b>	Signallampe ø 10mm 230V rot Anschluss Flachstecker 6,3mm Fassung Schraubfassung		
<b>Für Modelle:</b>	1G1PE1E, 1G1PE1EV, 1G1PE2EV, 2G1PE1E, 2G1PE1EV, 2G1PE2E, 2G1PE2EV, 30CPSE, 31PIE6, 70CPE, 71PIE15, 71PIE15A, 90CPE, 91PIE15, 91PIE15A		

			
1			
<b>GEV-Nr.</b>	346883	<b>Vergl.-Nr.</b>	6300651
<b>Beschreibung</b>	Signallampe ø 10mm 230V gelb Anschluss Flachstecker 6,3mm		
<b>Für Modelle:</b>	031FTE04, 031FTE06, 070FTE04, 070FTE05, 071FTE04, 071FTE06, 090FTE04, 090FTE05, 091FTE04, 091FTE06, 0A0FT1E, 0A0FT2E, 0A0FT4E, 0A0FT5E, 0D0FT1E, 0D0FT2E, 0D0FT4E, 0D0FT5E, 0G0FT1E, 0G0FT2E, 0G0FT4E, 0G0FT5E, 0G0FT7E, 10WTPGE, 12WFAAA, 190BM2E, 1A0BME, 1A0FT1E, 1A0FT2E, 1A0FT3E, 1A0FT4E, 1A0FT6E, 1A1PE4E, 1A1PEFTE, 1AIFBE, 1DOBME, 1D0FT1E, 1D0FT2E, 1D0FT3E, 1D0FT4E, 1D0FT6E, 1D1PE4E, 1DIFBE, 1G0FT1E, 1G0FT2E, 1G0FT3E, 1G0FT4E, 1G0FT7E, 1G1FA0E, 1G1FA0EV... (Weitere Modelle finden Sie in unserem Webshop)		

			
1			
<b>GEV-Nr.</b>	346881	<b>Vergl.-Nr.</b>	3106720 32W1341 6300653
<b>Beschreibung</b>	Signallampe ø 10mm 230V rot Anschluss Flachstecker 6,3mm		
<b>Für Modelle:</b>	06WBR3E, 06WFT1EV, 06WFT2EV, 06WFT3EV, 06WFT4EV, 06WFT6EV, 06WFT7EV, 08WGREV, 090FT1E, 090FT2E, 090FT4E, 090FT5E, 090FT7E, 091CP1E, 091FR11, 091FR11-VERS.032012, 091FR7G, 091FR7G-VERS.052012, 091FT1E, 091FT2E, 091FT4E, 091FT5E, 091FT7E, 0A1CP1E, 0D1CP1E, 0G1CP1E, 0G1CP1EC, 0G1CP1E-VERS.2004, 0G1FT2E, 0G1FT4E, 0G1FT5E, 0G1FT7E, 190FT15E, 190FT1E, 190FT2E, 190FT3E, 190FT42E, 190FT4E, 190FT5E, 190FT6E, 190FT72E, 190FT7E, 190GRE, 191BR1E, 191BR2E, 191BR2EA, 191FAAE, 191FAE, 191FR2I, 191FR2I-VERS.032012... (Weitere Modelle finden Sie in unserem Webshop)		

<b>30x22mm</b>			
			
1			
<b>GEV-Nr.</b>	359156	<b>Vergl.-Nr.</b>	32W0270 32W0640
<b>Beschreibung</b>	Signallampe Einbaumaß 30x22mm 230V gelb Anschluss Flachstecker 6,3mm Temp.Best. 125/55°C Typ RL2		

## Leuchtmittel für Steck-/Schraubfassungen

### Glühlampen für Backöfen

			
1			
<b>GEV-Nr.</b>	359610	<b>Vergl.-Nr.</b>	32W0780
<b>Beschreibung</b>	Glühlampe T.max. 300°C Fassung E14 15W 230V ø 22mm L 47mm Glas L 20mm für Backofenlampe Typ Philips		



			
1			
<b>GEV-Nr.</b>	357153	<b>Vergl.-Nr.</b>	32W3900
<b>Beschreibung</b>	Glühlampe T.max. 300°C Fassung E14 25W 230V ø 25mm L 55mm Glas L 30mm für Backofen Typ 120lm 1000std		

			
1			
<b>GEV-Nr.</b>	359612	<b>Vergl.-Nr.</b>	32W0210
<b>Beschreibung</b>	Glühlampe T.max. 300°C Fassung E14 25W 230V ø 25mm L 56mm Glas L 30mm für Backofenlampe Typ Philips		
<b>Für Modelle:</b>	FC101, FC101E, FC101G, FC101E, FC1221E, FC1221G, FC241, FC241E, FC241G, FC61, FC61E, FC61G, FC61E, FCV101, FCV101-CSA, FCV101DM, FCV101DM-CSA, FCV101DS, FCV101DS-CSA, FCV101E, FCV101EDM, FCV101EDM-UL, FCV101EDS, FCV101EDS-UL, FCV101E-UL, FCV141, FCV141-CSA, FCV141DM, FCV141DM-CSA, FCV141DS, FCV141DS-CSA, FCV141E, FCV141EDM, FCV141EDS, FCV241, FCV241DM, FCV241DS, FCV241E, FCV241EDM, FCV241EDM-UL, FCV241EDS, FCV241EDS-UL, FCV241E-UL, FCV241G, FCV241G-CSA, FCV241GDM, FCV241GDM-CSA, FCV241GDS, FCV241GDS-CSA, FCV3EM...(Weitere Modelle finden Sie in unserem Webshop)		

			
1			
<b>GEV-Nr.</b>	359614	<b>Vergl.-Nr.</b>	32W2350
<b>Beschreibung</b>	Glühlampe T.max. 300°C Fassung E27 230V 40W ø 45mm L 71mm Glas L 44mm VPE 1 Stück		
<b>Für Modelle:</b>	135, 135-4, 135B, 135BN, 135BNX, 135BX, 135BXR, 135CPX, 135NN, 135NNX, 135X, 135X-3, 135X-4, 135XR, 65, 65B, 65BX, 65BX-2, 65BXR, 65NB, 65NBX, 65NN, 65NNX, 65X, 65X-2, 65XR, SP120, SP120B, SP120BN, SP120NN, SP135, SP135B, SP135BN, SP135CP, SP135NN, SP55, SP55B, SP65, SP65B, SP65NB, SP65NN		

**Halogenleuchtmittel**

für Fassung G4 / G6,35 / G9

			
1			
<b>GEV-Nr.</b>	357193	<b>Vergl.-Nr.</b>	3030661
<b>Beschreibung</b>	Halogenlampe Fassung G4 12V 20W Temp.Best. 300°C OSRAM HALOSTAR OVEN		
<b>Für Modelle:</b>	BX101E, BX101E-VERS.122013, BX101G, BX101G-VERS.122013, BX122E, BX122E-VERS.122013, BX122G, BX122G-VERS.122013, BX61E, BX61E-VERS.122013, BX61G, BX61G-VERS.122013, BX82E, BX82E-VERS.122013, BX82G, BX82G-VERS.122013, FM1011E1, FM1011E2, FM1011E3, FM1011G1, FM1011G2, FM1011G3, FM1221E1, FM1221E2, FM1221E3, FM1221G1, FM1221G2, FM1221G3, FM611E2, FM611E3, FM611G1, FM611G2, FM611G3, FM721E1, FM721E2, FM721E3, FM721G1, FM721G2, FM721G3, FX101E1, FX101E1R, FX101E2, FX101E2C, FX101E2C-VERS.032014, FX101E2R, FX101E2R-VERS.032014, FX101E2-VERS.032014, FX101E3, FX101E3C, FX101E3C-VERS.022014...(Weitere Modelle finden Sie in unserem Webshop)		





			
1			
<b>GEV-Nr.</b>	359599	<b>Vergl.-Nr.</b>	3019710 3030660
<b>Beschreibung</b>	Halogenlampe Fassung G4 12V 20W Temp.Best. 500°C 250lm 2000std		
<b>Für Modelle:</b>	BX101E, BX101E-VERS.122013, BX101G, BX101G-VERS.122013, BX122E, BX122E-VERS.122013, BX122G, BX122G-VERS.122013, BX61E, BX61E-VERS.122013, BX61G, BX61G-VERS.122013, BX82E, BX82E-VERS.122013, BX82G, BX82G-VERS.122013, FM1011E1, FM1011E2, FM1011E3, FM1011G1, FM1011G2, FM1011G3, FM1221E1, FM1221E2, FM1221E3, FM1221G1, FM1221G2, FM1221G3, FM611E2, FM611E3, FM611G1, FM611G2, FM611G3, FM721E1, FM721E2, FM721E3, FM721G1, FM721G2, FM721G3, FPZ14E, FPZ16E, FPZ24E, FPZ2635E, FPZ26E, FPZ4G, FPZ6G, FX101E1, FX101E1R, FX101E2, FX101E2C...(Weitere Modelle finden Sie in unserem Webshop)		

**Backofenlampen**



**Universale Backofenlampen**

Einbaudurchmesser 35,5mm



			
1			
<b>GEV-Nr.</b>	357162	<b>Vergl.-Nr.</b>	3008760
<b>Beschreibung</b>	Backofenlampe Einbau ø 35.5mm 12V 20W Fassung G4 Temp.Best. 300°C Anschluss Kabel 450mm Hartglas		
<b>Ersatzteile für</b>	357162		
	<b>GEV-Nr.</b>	359599	<b>Vergl.-Nr.</b> 3019710 3030660
	Halogenlampe Fassung G4 12V 20W Temp.Best. 500°C 250lm 2000std		
	<b>GEV-Nr.</b>	359762	<b>Vergl.-Nr.</b> —
	Lampenfassung Fassung G4 Einbau ø 35.5mm Anschluss Kabel 450mm		
	<b>GEV-Nr.</b>	359942	<b>Vergl.-Nr.</b> —
	Linsennippel øG 33.5mm H 39mm ø 40mm Hartglas Temp.Best. 350°C		

			
1			
<b>GEV-Nr.</b>	360759	<b>Vergl.-Nr.</b>	3019720
<b>Beschreibung</b>	Backofenlampe Einbau ø 35.5mm 12V 20W Fassung G4 Temp.Best. 350°C Anschluss Kabel 450mm Hartglas		
<b>Für Modelle:</b>	FPZ14E, FPZ16E, FPZ24E, FPZ2635E, FPZ26E, FPZ4G, FPZ6G		
<b>Ersatzteile für</b>	360759		
	<b>GEV-Nr.</b>	357192	<b>Vergl.-Nr.</b> —
	Halogenlampe Fassung G4 12V 20W Temp.Best.°C OSRAM HALOSTAR STARLITE		
	<b>GEV-Nr.</b>	357264	<b>Vergl.-Nr.</b> —
	Lampenfassung Fassung G4 Einbau ø 35.5mm Anschluss Kabel 450mm		
	<b>GEV-Nr.</b>	359033	<b>Vergl.-Nr.</b> 3019730
	Linsennippel øG 33.5mm H 39mm ø 40mm Borosilikatglas		



			
1			
<b>GEV-Nr.</b>	359718	<b>Vergl.-Nr.</b>	32W0740
<b>Beschreibung</b>	Backofenlampe Einbau ø 35.5mm 230V 15W Fassung E14 Temp.Best. 300°C Anschluss Flachstecker 6,3mm Hartglas		
<b>Ersatzteile für</b>	359718		
	<b>GEV-Nr.</b>	359701	<b>Vergl.-Nr.</b> 32W0746 32W2561
	Lampenfassung Fassung E14 220-230V Einbau ø 35.5mm Anschluss Flachstecker 6,3mm 15W		
	<b>GEV-Nr.</b>	359740	<b>Vergl.-Nr.</b> —
	Glühlampe T.max. 300°C Fassung E14 15W 230V ø 22mm L 48mm Glas L 20mm für Backofenlampe IMPORT 70lm 1000std		



			
1			
<b>GEV-Nr.</b>	359701	<b>Vergl.-Nr.</b>	32W0746 32W2561
<b>Beschreibung</b>	Lampenfassung Fassung E14 220-230V Einbau ø 35.5mm Anschluss Flachstecker 6,3mm 15W		
<b>Für Modelle:</b>	FC101, FC101E, FC241, FC241E, FC241G, FC61, FC61E, FCV101, FCV101-CSA, FCV101DM, FCV101DM-CSA, FCV101DS, FCV101DS-CSA, FCV101E, FCV101EDM, FCV101EDM-UL, FCV101EDS, FCV101EDS-UL, FCV101E-UL, FCV141, FCV141-CSA, FCV141DM, FCV141DM-CSA, FCV141DS, FCV141DS-CSA, FCV141E, FCV141EDM, FCV141EDS, FCV241, FCV241DM, FCV241DS, FCV241E, FCV241EDM, FCV241EDM-UL, FCV241EDS, FCV241E-UL, FCV241G, FCV241GDM, FCV241GDM-CSA, FCV241GDS, FCV241GDS-CSA, FCV401DM, FCV401DM-CSA, FCV401EDM, FCV401EDM-UL, FCV61, FCV61-CSA, FCV61DM, FCV61DM-CSA, FCV61DS...(Weitere Modelle finden Sie in unserem Webshop)		
<b>Zubehör für</b>	359701		
	<b>GEV-Nr.</b>	359705	<b>Vergl.-Nr.</b> 32W3080
	Linsennippel øG 33.5mm ø 52mm Hartglas Temp.Best. 350°C		
	<b>GEV-Nr.</b>	359709	<b>Vergl.-Nr.</b> —
	Linsennippel øG 33.5mm ø 42mm Hartglas Temp.Best. 350°C		
	<b>GEV-Nr.</b>	359721	<b>Vergl.-Nr.</b> —
	Dichtung Silikon AD ø 48mm ID ø 39.5mm Materialstärke 5mm VPE 1 Stück		
	<b>GEV-Nr.</b>	359942	<b>Vergl.-Nr.</b> —
	Linsennippel øG 33.5mm H 39mm ø 40mm Hartglas Temp.Best. 350°C		

			
1			
<b>GEV-Nr.</b>	359661	<b>Vergl.-Nr.</b>	32X3080
<b>Beschreibung</b>	Linsennippel Gewinde 32.1 ø 58mm Hartglas Temp.Best. 350°C		
<b>Zubehör für</b>	359661		
	<b>GEV-Nr.</b>	359700	<b>Vergl.-Nr.</b> —
	Dichtung für Pizzaofen Fiberglas ID ø 32.5mm AD ø 55mm Materialstärke 5mm		

<b>Zubehör für</b>	359661		
	<b>GEV-Nr.</b>	360782	<b>Vergl.-Nr.</b> —
	Dichtung für Pizzaofen Fiberglas ID ø 35mm AD ø 45mm Materialstärke 5mm		

			
1			
<b>GEV-Nr.</b>	359033	<b>Vergl.-Nr.</b>	3019730
<b>Beschreibung</b>	Linsennippel øG 33.5mm H 39mm ø 40mm Borosilikatglas		
<b>Für Modelle:</b>	FPZ14E, FPZ16E, FPZ24E, FPZ2635E, FPZ26E, FPZ4G, FPZ6G		

			
1			
<b>GEV-Nr.</b>	359705	<b>Vergl.-Nr.</b>	32W3080
<b>Beschreibung</b>	Linsennippel øG 33.5mm ø 52mm Hartglas Temp.Best. 350°C		
<b>Zubehör für</b>	359705		
	<b>GEV-Nr.</b>	359610	<b>Vergl.-Nr.</b> 32W0780
	Glühlampe T.max. 300°C Fassung E14 15W 230V ø 22mm L 47mm Glas L 20mm für Backofenlampe Typ Philips		
	<b>GEV-Nr.</b>	359700	<b>Vergl.-Nr.</b> —
	Dichtung für Pizzaofen Fiberglas ID ø 32.5mm AD ø 55mm Materialstärke 5mm		
	<b>GEV-Nr.</b>	359721	<b>Vergl.-Nr.</b> —
	Dichtung Silikon AD ø 48mm ID ø 39.5mm Materialstärke 5mm VPE 1 Stück		
	<b>GEV-Nr.</b>	359837	<b>Vergl.-Nr.</b> —
	Dichtung ID ø 33mm AD ø 46mm Materialstärke 1mm Graphit		
	<b>GEV-Nr.</b>	359838	<b>Vergl.-Nr.</b> —
	Dichtung ID ø 33mm AD ø 45mm		

<b>55x70mm</b>			
			
1			
<b>GEV-Nr.</b>	358148	<b>Vergl.-Nr.</b>	32V5570
<b>Beschreibung</b>	Lampenfassung Fassung G4 12V Einbaumaß 55x70mm Anschluss Kabel 135mm		
<b>Ersatzteile für</b>	358148		
	<b>GEV-Nr.</b>	359599	<b>Vergl.-Nr.</b> 3019710 3030660
	Halogenlampe Fassung G4 12V 20W Temp.Best. 500°C 250lm 2000std		
<b>Zubehör für</b>	358148		
	<b>GEV-Nr.</b>	359937	<b>Vergl.-Nr.</b> —
	Lampenglas L 80mm B 65mm Einbaumaß 52x67mm		





			
1			
<b>GEV-Nr.</b>	358147	<b>Vergl.-Nr.</b>	3036970
<b>Beschreibung</b>	Dichtung L 75mm B 65mm Materialstärke 1mm für Backofenlampe		
<b>Für Modelle:</b>	FC1011E, FC1011G, FC1221E, FC1221G, FC611E, FC611G, FCV3EM, FCV4E, FCV4EDS, FCV4EM, FM1011E1, FM1011E1-VERS.2006, FM1011E2, FM1011E2-VERS.2006, FM1011E3, FM1011E3-VERS.2006, FM1011G1, FM1011G1-VERS.2006, FM1011G2, FM1011G2-VERS.2006, FM1011G3, FM1011G3-VERS.2006, FM1221E1, FM1221E1-VERS.2006, FM1221E2, FM1221E2-VERS.2006, FM1221E3, FM1221E3-VERS.2006, FM1221G1, FM1221G1-VERS.2006, FM1221G2, FM1221G2-VERS.2006, FM1221G3, FM1221G3-VERS.2006, FM2011E2-VERS.2006, FM2011E3-VERS.2006, FM2011G2-VERS.2006, FM2011G3-VERS.2006, FM2021E1, FM2021E2, FM2021E2-VERS.2006, FM2021E3-VERS.2006, FM2021G1, FM2021G2, FM2021G2-VERS.2006, FM2021G3, FM2021G3-VERS.2006, FM423E1, FM423E2, FM611E1...(Weitere Modelle finden Sie in unserem Webshop)		

			
1			
<b>GEV-Nr.</b>	359299	<b>Vergl.-Nr.</b>	37Q4100 37Q4106
<b>Beschreibung</b>	Dichtung L 91mm B 77mm Loch ø 3mm für Backofenlampe		
<b>Für Modelle:</b>	FCV3EM, FCV4E, FCV4EDS, FCV4EM		

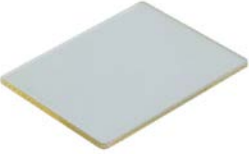



			
1			
<b>GEV-Nr.</b>	359296	<b>Vergl.-Nr.</b>	37M9910 37M9911
<b>Beschreibung</b>	Lampenglas L 74mm B 58mm Materialstärke 3mm		
<b>Für Modelle:</b>	FCV3EM, FCV4E, FCV4EDS, FCV4EM		

Herstellerspezifische Backofenlampen

ANGELO PO





			
1			
<b>GEV-Nr.</b>	359339	<b>Vergl.-Nr.</b>	37Q7840
<b>Beschreibung</b>	Dichtung ID ø 65mm AD ø 80mm Materialstärke 1mm		
<b>Für Modelle:</b>	FC101, FC101E, FC241, FC241E, FC241G, FC61, FC61E, FCV101, FCV101-CSA, FCV101DM, FCV101DM-CSA, FCV101DS, FCV101DS-CSA, FCV101E, FCV101EDM, FCV101EDM-UL, FCV101EDS, FCV101EDS-UL, FCV101E-UL, FCV141, FCV141-CSA, FCV141DM, FCV141DM-CSA, FCV141DS, FCV141DS-CSA, FCV141E, FCV141EDM, FCV141EDS, FCV241, FCV241DM, FCV241DS, FCV241E, FCV241EDM, FCV241EDM-UL, FCV241EDS, FCV241EDS-UL, FCV241E-UL, FCV241G, FCV241G-CSA, FCV241GDM, FCV241GDM-CSA, FCV241GDS, FCV241GDS-CSA, FCV401DM, FCV401DM-CSA, FCV401EDM, FCV401EDM-UL, FCV4E, FCV4EDS, FCV61...(Weitere Modelle finden Sie in unserem Webshop)		

			
1			
<b>GEV-Nr.</b>	359340	<b>Vergl.-Nr.</b>	3036650 37M6210
<b>Beschreibung</b>	Glasscheibe rund ø 78mm Materialstärke 3mm		
<b>Für Modelle:</b>	031FT04, 031FT06, 070FT04, 070FT05, 071FT04, 071FT06, 090FT04, 090FT05, 091FT04, 091FT06, 0A0FT1G, 0A0FT2G, 0A0FT4G, 0A0FT5G, 0D0FT1G, 0D0FT2G, 0D0FT4G, 0D0FT5G, 1A0FT1G, 1A0FT2G, 1A0FT3G, 1A0FT4G, 1A0FT6G, 1D0FT1G, 1D0FT2G, 1D0FT3G, 1D0FT4G, 1D0FT6G, FC101, FC101E, FC241, FC241E, FC241G, FC61, FC61E, FCV101, FCV101-CSA, FCV101DM, FCV101DM-CSA, FCV101DS, FCV101DS-CSA, FCV101E, FCV101EDM, FCV101EDM-UL, FCV101EDS, FCV101EDS-UL, FCV101E-UL, FCV141, FCV141-CSA, FCV141DM...(Weitere Modelle finden Sie in unserem Webshop)		

			
1			
<b>GEV-Nr.</b>	359701	<b>Vergl.-Nr.</b>	32W0746 32W2561
<b>Beschreibung</b>	Lampenfassung Fassung E14 220-230V Einbau ø 35.5mm Anschluss Flachstecker 6,3mm 15W		
<b>Für Modelle:</b>	FC101, FC101E, FC241, FC241E, FC241G, FC61, FC61E, FCV101, FCV101-CSA, FCV101DM, FCV101DM-CSA, FCV101DS, FCV101DS-CSA, FCV101E, FCV101EDM, FCV101EDM-UL, FCV101EDS, FCV101EDS-UL, FCV101E-UL, FCV141, FCV141-CSA, FCV141DM, FCV141DM-CSA, FCV141DS, FCV141DS-CSA, FCV141E, FCV141EDM, FCV141EDS, FCV241, FCV241DM, FCV241DS, FCV241E, FCV241EDM, FCV241EDM-UL, FCV241EDS, FCV241E-UL, FCV241G, FCV241GDM, FCV241GDM-CSA, FCV241GDS, FCV241GDS-CSA, FCV401DM, FCV401DM-CSA, FCV401EDM, FCV401EDM-UL, FCV61, FCV61-CSA, FCV61DM, FCV61DM-CSA, FCV61DS...(Weitere Modelle finden Sie in unserem Webshop)		
<b>Zubehör für</b>	359701		
	<b>GEV-Nr.</b>	359705	<b>Vergl.-Nr.</b> 32W3080
	Linsennippel øG 33.5mm ø 52mm Hartglas Temp.Best. 350°C		
	<b>GEV-Nr.</b>	359709	<b>Vergl.-Nr.</b> —
	Linsennippel øG 33.5mm ø 42mm Hartglas Temp.Best. 350°C		
	<b>GEV-Nr.</b>	359721	<b>Vergl.-Nr.</b> —
	Dichtung Silikon AD ø 48mm ID ø 39.5mm Materialstärke 5mm VPE 1 Stück		
	<b>GEV-Nr.</b>	359942	<b>Vergl.-Nr.</b> —
	Linsennippel øG 33.5mm H 39mm ø 40mm Hartglas Temp.Best. 350°C		



			
<b>GEV-Nr.</b>	551336	<b>Vergl.-Nr.</b>	36E3170
<b>Beschreibung</b>	Dichtung für Lampe L 92mm B 92mm Materialstärke 2.3mm		
<b>Für Modelle:</b>	BX101E, BX101E-VERS.122013, BX101G, BX101G-VERS.122013, BX122E, BX122E-VERS.122013, BX122G, BX122G-VERS.122013, BX61E, BX61E-VERS.122013, BX61G, BX61G-VERS.122013, BX82E, BX82E-VERS.122013, BX82G, BX82G-VERS.122013, FC1011E, FC1011G, FC1221E, FC1221G, FC611E, FC611G, FCV3EM, FCV4E, FCV4EDS, FCV4EM, FM1011E1, FM1011E1-VERS.2006, FM1011E2, FM1011E2-VERS.2006, FM1011E3, FM1011E3-VERS.2006, FM1011G1, FM1011G1-VERS.2006, FM1011G2, FM1011G2-VERS.2006, FM1011G3, FM1011G3-VERS.2006, FM1221E1, FM1221E1-VERS.2006, FM1221E2, FM1221E2-VERS.2006, FM1221E3, FM1221E3-VERS.2006, FM1221G1, FM1221G1-VERS.2006, FM1221G2, FM1221G2-VERS.2006, FM1221G3, FM1221G3-VERS.2006...(Weitere Modelle finden Sie in unserem Webshop)		

			
<b>GEV-Nr.</b>	357262	<b>Vergl.-Nr.</b>	3097180
<b>Beschreibung</b>	Lampenfassung Fassung E14 Einbaumaß 55x70mm Anschluss Flachstecker 6,3mm VPE 1 Stück		
<b>Für Modelle:</b>	FC1011E, FC1011G, FC1221E, FC1221G, FC611E, FC611G, FCV3EM, FCV4E, FCV4EDS, FCV4EM, FM423E1, FM423E2		
<b>Zubehör für</b>	357262		
	<b>GEV-Nr.</b>	<b>Vergl.-Nr.</b>	3159800 3278370 35E3360
Rahmen für Backofenlampe L 97mm B 97mm Stärke 6mm BA 78mm ø 55mm			
	<b>GEV-Nr.</b>	<b>Vergl.-Nr.</b>	3036960 3036961 3036962 3036963
Lampenglas L 73.6mm B 64mm Materialstärke 4mm			
	<b>GEV-Nr.</b>	<b>Vergl.-Nr.</b>	3036970
Dichtung L 75mm B 65mm Materialstärke 1mm für Backofenlampe			
	<b>GEV-Nr.</b>	<b>Vergl.-Nr.</b>	551336 36E3170
Dichtung für Lampe L 92mm B 92mm Materialstärke 2.3mm			

			
<b>GEV-Nr.</b>	357180	<b>Vergl.-Nr.</b>	3036960 3036961 3036962 3036963
<b>Beschreibung</b>	Lampenglas L 73.6mm B 64mm Materialstärke 4mm		
<b>Für Modelle:</b>	BX101E, BX101E-VERS.122013, BX101G, BX101G-VERS.122013, BX122E, BX122E-VERS.122013, BX122G, BX122G-VERS.122013, BX61E, BX61E-VERS.122013, BX61G, BX61G-VERS.122013, BX82E, BX82E-VERS.122013, BX82G, BX82G-VERS.122013, FC1011E, FC1011G, FC1221E, FC1221G, FC611E, FC611G, FCV3EM, FCV4E, FCV4EDS, FCV4EM, FM1011E1, FM1011E1-VERS.2006, FM1011E2, FM1011E2-VERS.2006, FM1011E3, FM1011E3-VERS.2006, FM1011G1, FM1011G1-VERS.2006, FM1011G2, FM1011G2-VERS.2006, FM1011G3, FM1011G3-VERS.2006, FM1221E1, FM1221E1-VERS.2006, FM1221E2, FM1221E2-VERS.2006, FM1221E3, FM1221E3-VERS.2006, FM1221G1, FM1221G1-VERS.2006, FM1221G2, FM1221G2-VERS.2006, FM1221G3, FM1221G3-VERS.2006...(Weitere Modelle finden Sie in unserem Webshop)		

			
<b>GEV-Nr.</b>	357179	<b>Vergl.-Nr.</b>	3159800 3278370 35E3360
<b>Beschreibung</b>	Rahmen für Backofenlampe L 97mm B 97mm Stärke 6mm BA 78mm ø 55mm		
<b>Für Modelle:</b>	BX101E, BX101E-VERS.122013, BX101G, BX101G-VERS.122013, BX122E, BX122E-VERS.122013, BX122G, BX122G-VERS.122013, BX61E, BX61E-VERS.122013, BX61G, BX61G-VERS.122013, BX82E, BX82E-VERS.122013, BX82G, BX82G-VERS.122013, FC1011E, FC1011G, FC1221E, FC1221G, FC611E, FC611G, FCV3EM, FCV4E, FCV4EDS, FCV4EM, FM1011E1, FM1011E1-VERS.2006, FM1011E2, FM1011E2-VERS.2006, FM1011E3, FM1011E3-VERS.2006, FM1011G1, FM1011G1-VERS.2006, FM1011G2, FM1011G2-VERS.2006, FM1011G3, FM1011G3-VERS.2006, FM1221E1, FM1221E1-VERS.2006, FM1221E2, FM1221E2-VERS.2006, FM1221E3, FM1221E3-VERS.2006, FM1221G1, FM1221G1-VERS.2006, FM1221G2, FM1221G2-VERS.2006, FM1221G3, FM1221G3-VERS.2006...(Weitere Modelle finden Sie in unserem Webshop)		

Leuchtmittel

Glühlampen

			
<b>GEV-Nr.</b>	359610	<b>Vergl.-Nr.</b>	32W0780
<b>Beschreibung</b>	Glühlampe T.max. 300°C Fassung E14 15W 230V ø 22mm L 47mm Glas L 20mm für Backofenlampe Typ Philips		

			
<b>GEV-Nr.</b>	357153	<b>Vergl.-Nr.</b>	32W3900
<b>Beschreibung</b>	Glühlampe T.max. 300°C Fassung E14 25W 230V ø 25mm L 55mm Glas L 30mm für Backofen Typ 120lm 1000std		

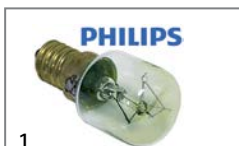
			
<b>GEV-Nr.</b>	359612	<b>Vergl.-Nr.</b>	32W0210
<b>Beschreibung</b>	Glühlampe T.max. 300°C Fassung E14 25W 230V ø 25mm L 56mm Glas L 30mm für Backofenlampe Typ Philips		
<b>Für Modelle:</b>	FC101, FC1011E, FC1011G, FC101E, FC1221E, FC1221G, FC241, FC241E, FC241G, FC61, FC611E, FC611G, FC61E, FCV101, FCV101-CSA, FCV101DM, FCV101DM-CSA, FCV101DS, FCV101DS-CSA, FCV101E, FCV101EDM, FCV101EDM-UL, FCV101EDS, FCV101EDS-UL, FCV101E-UL, FCV141, FCV141-CSA, FCV141DM, FCV141DM-CSA, FCV141DS, FCV141DS-CSA, FCV141E, FCV141EDM, FCV141EDS, FCV241, FCV241DM, FCV241DS, FCV241E, FCV241EDM, FCV241EDM-UL, FCV241EDS, FCV241EDS-UL, FCV241E-UL, FCV241G, FCV241G-CSA, FCV241GDM, FCV241GDM-CSA, FCV241GDS, FCV241GDS-CSA, FCV3EM...(Weitere Modelle finden Sie in unserem Webshop)		



			
1			
<b>GEV-Nr.</b>	359614	<b>Vergl.-Nr.</b>	32W2350
<b>Beschreibung</b>	Glühlampe T.max. 300°C Fassung E27 230V 40W ø 45mm L 71mm Glas L 44mm VPE 1 Stück		
<b>Für Modelle:</b>	135, 135-4, 135B, 135BN, 135BNX, 135BX, 135BXR, 135CPX, 135NN, 135NNX, 135X, 135X-3, 135X-4, 135XR, 65, 65B, 65BX, 65BX-2, 65BXR, 65NB, 65NBX, 65NN, 65NNX, 65X, 65X-2, 65XR, SP120, SP120B, SP120BN, SP120NN, SP135, SP135B, SP135BN, SP135CP, SP135NN, SP55, SP55B, SP65, SP65B, SP65NB, SP65NN		

**Halogenlampen**  
für Fassung G4 / G6,35 / G9

			
1			
<b>GEV-Nr.</b>	357193	<b>Vergl.-Nr.</b>	3030661
<b>Beschreibung</b>	Halogenlampe Fassung G4 12V 20W Temp.Best. 300°C OSRAM HALOSTAR OVEN		
<b>Für Modelle:</b>	BX101E, BX101E-VERS.122013, BX101G, BX101G-VERS.122013, BX122E, BX122E-VERS.122013, BX122G, BX122G-VERS.122013, BX61E, BX61E-VERS.122013, BX61G, BX61G-VERS.122013, BX82E, BX82E-VERS.122013, BX82G, BX82G-VERS.122013, FM1011E1, FM1011E2, FM1011E3, FM1011G1, FM1011G2, FM1011G3, FM1221E1, FM1221E2, FM1221E3, FM1221G1, FM1221G2, FM1221G3, FM611E2, FM611E3, FM611G1, FM611G2, FM611G3, FM721E1, FM721E2, FM721E3, FM721G1, FM721G2, FM721G3, FX101E1, FX101E1R, FX101E2, FX101E2C, FX101E2C-VERS.032014, FX101E2R, FX101E2R-VERS.032014, FX101E2-VERS.032014, FX101E3, FX101E3C, FX101E3C-VERS.022014...(Weitere Modelle finden Sie in unserem Webshop)		

			
1			
<b>GEV-Nr.</b>	359599	<b>Vergl.-Nr.</b>	3019710 3030660
<b>Beschreibung</b>	Halogenlampe Fassung G4 12V 20W Temp.Best. 500°C 250lm 2000std		
<b>Für Modelle:</b>	BX101E, BX101E-VERS.122013, BX101G, BX101G-VERS.122013, BX122E, BX122E-VERS.122013, BX122G, BX122G-VERS.122013, BX61E, BX61E-VERS.122013, BX61G, BX61G-VERS.122013, BX82E, BX82E-VERS.122013, BX82G, BX82G-VERS.122013, FM1011E1, FM1011E2, FM1011E3, FM1011G1, FM1011G2, FM1011G3, FM1221E1, FM1221E2, FM1221E3, FM1221G1, FM1221G2, FM1221G3, FM611E2, FM611E3, FM611G1, FM611G2, FM611G3, FM721E1, FM721E2, FM721E3, FM721G1, FM721G2, FM721G3, FPZ14E, FPZ16E, FPZ24E, FPZ2635E, FPZ26E, FPZ4G, FPZ6G, FX101E1, FX101E1R, FX101E2, FX101E2C... (Weitere Modelle finden Sie in unserem Webshop)		

**Timer**

**Programmtimer**

			
1			
<b>GEV-Nr.</b>	360645	<b>Vergl.-Nr.</b>	3289260
<b>Beschreibung</b>	Timer CDC 11901F Motoren 1 Kammern 1 Laufzeit 20S 230V 50/60Hz Achse ø 6x4mm Achslänge 25mm Hersteller-Nr. 11901F1CEE000.0000		
<b>Für Modelle:</b>	FX201G3P, FX201G3-VERS.022014		

			
1			
<b>GEV-Nr.</b>	360381	<b>Vergl.-Nr.</b>	32Z5840
<b>Beschreibung</b>	Timer CDC Motoren 1 Kammern 2 Laufzeit 2h 230V Achse ø 6x4,6mm Achslänge 19mm Hersteller-Nr. 4900/32Z58400		

			
1			
<b>GEV-Nr.</b>	360633	<b>Vergl.-Nr.</b>	32Z9630
<b>Beschreibung</b>	Zeitschalter Kit 14000F3 Laufzeit 120min Antrieb elektrisch Achse ø 6x4,6mm Achslänge 20mm CDC 230V Motoren 1 Kammern 2		



Zeitschalter mechanisch

			
1			
<b>GEV-Nr.</b>	350003	<b>Vergl.-Nr.</b>	32Z0420 32Z2200
<b>Beschreibung</b>	Zeitschalter M2 mit Glocke 2-polig Laufzeit 120min Antrieb mechanisch 2NO bei 250V 16A Dauerstellung Nein Achse ø 6x4,6mm Achse 6x4,6mm Achslänge 23mm BA 28mm Anschluss seitlich		
<b>Für Modelle:</b>	FC101, FC1011E, FC1011G, FC101E, FC1221E, FC1221G, FC241, FC241E, FC241G, FC61, FC611E, FC611G, FC61E		
<b>Zubehör für</b>	350003		
	GEV-Nr. 110366	Vergl.-Nr.	—
	Knebel Schalter Nullstrich T.max.°C ø 44mm Achse ø 6x4,6mm Abflachung oben schwarz		
	GEV-Nr. 111199	Vergl.-Nr.	—
	Skalenscheibe Einteilung 120min Dauerstellung Nein Drehwinkel 0-330° ø 60mm Zeitschaltuhren Knebel ø 45mm		

Alarmgeber

Alarmenteile

			
1			
<b>GEV-Nr.</b>	350056	<b>Vergl.-Nr.</b>	32Z5860
<b>Beschreibung</b>	Alarmgeber 220-240VAC ømm H 25mm Aufputzversion BAmm 83dB Schutzart IPx0		
<b>Für Modelle:</b>	FCV101, FCV101E, FCV141, FCV141E, FCV241, FCV241E, FCV241G, FCV241G-CSA, FCV3EM, FCV4EM, FCV61, FCV61E		

Schütze

GENERAL ELECTRIC (AEG)

Leistungsschütze

			
1			
<b>GEV-Nr.</b>	380262	<b>Vergl.-Nr.</b>	3100910 32V7170 32Z2080 32Z2083
<b>Beschreibung</b>	Leistungsschütz AC1 32A 230VAC (AC3/400V) 17A/7,5kW Hauptkontakte 3NO Hilfskontakte 1NC Anschluss Schraubanschluss Typ AEG LS7K01A Typ GE CL02A 301 H 85mm		
<b>Für Modelle:</b>	030FE, 030FE1, 030FE1B, 04WFR3ED, 08WFR4ED, 091FE28, 091FE28B, 091FR3E, 091FR3ED, 0A1FR3E, 0A1FR3ED, 0D1FR3E, 0D1FR3ED, 0G0FR3E, 0G0FR3ED, 191FR4E, 191FR4ED, 1A1FR4E, 1A1FR4ED, 1D1FR4E, 1D1FR4ED, 1G0FR4E, 1G1BR1E, 30FES, 30FES2, 30FES2B, 31RE, 6043840, 6043970, 70FES, 70FES2, 70FES2B, 71AR, 71ARE, 91AR, FC101, FC101E, FC241E, FC241G, FC61, FC611E, FC61E, FCV101, FCV101DM, FCV101DS, FCV101E, FCV101EDM, FCV101EDS, FCV141, FCV141DM...(Weitere Modelle finden Sie in unserem Webshop)		

			
1			
<b>GEV-Nr.</b>	380265	<b>Vergl.-Nr.</b>	32Z2091
<b>Beschreibung</b>	Leistungsschütz AC1 60A 230VAC (AC3/400V) 32A/16kW Hauptkontakte 3NO Hilfskontakte 1NO Anschluss Schraubanschluss Typ AEG LS15K 00A Typ GE CL04A 310 H 98mm L 87mm B 55mm		
<b>Für Modelle:</b>	04WCP1EM, 091CP1E, 091FR1E, 091FR1ED, 0A1FR1E, 0A1FR1ED, 0D1FR1E, 0D1FR1ED, 0G1BR3E, 191BR1E, 191BR2E, 191BR2EA, 191FR2E, 191FR2ED, 1A1BR1E, 1A1BR2E, 1A1BR2EA, 1A1FR2E, 1A1FR2ED, 1D1BR1E, 1D1BR2E, 1D1BR2EA, 1D1FR2ED, 1G1BR3E, 291BR1E, 291BR2E, 291BR2EA, 2A1BR1E, 2A1BR2E, 2A1BR2EA, 2D1BR1E, 2D1BR2E, 2D1BR2EA, 70FE1, 70FE1B, 71ARE, 71FE2, 71FE2B, 91ARE		

**ISKRA (FANAL)**

**Leistungsschütze**



<b>1</b>			
<b>GEV-Nr.</b>	380212	<b>Vergl.-Nr.</b>	32V0980
<b>Beschreibung</b>	Leistungsschütz AC1 20A 230VAC (AC3/400V) 8,5A/5,5kW Hauptkontakte 3NO Hilfskontakte 1NC Anschluss Schraubanschluss Typ FANAL K07M 01 Typ ISKRA DSL7 01		
<b>Für Modelle:</b>	1A1BR2EA, 1D1BR2EA, 2A1BR1GA, 2A1BR2EA, 2A1BR2GA, 2D1BR1GA, 2D1BR2GA, FCV3EM		

<b>1</b>			
<b>GEV-Nr.</b>	380705	<b>Vergl.-Nr.</b>	32V1880
<b>Beschreibung</b>	Leistungsschütz AC1 20A 230VAC (AC3/400V) 9A/4kW Hauptkontakte 3NO Hilfskontakte 1NO Anschluss Schraubanschluss Typ 11BG0910A230		
<b>Zubehör für</b>	380705		
	<b>GEV-Nr.</b>	380057	<b>Vergl.-Nr.</b> —
	Hilfskontakt Kontakte 1NO/1NC AC1 10A für Schütze Serie BG Anschluss Schraubanschluss Typ BGX1011		

**LOVATO**

**Leistungsschütze**



<b>1</b>			
<b>GEV-Nr.</b>	380711	<b>Vergl.-Nr.</b>	32Z3512 32Z4471
<b>Beschreibung</b>	Leistungsschütz AC1 20A 230VAC (AC3/400V) 9A/4kW Hauptkontakte 3NO Hilfskontakte 1NC Anschluss Flachstecker Typ 11BG-F0901A230		
<b>Für Modelle:</b>	070FTE, 070FTER, 071BME, 071FTE, 071FTER, 071FTERL, 090FTE, 090FTER, 091BME, 091FTE, 091FTER, 091FTERL, 71ARE, 91ARE, FC1011E, FC1221E, FC241E, FCV141E, FCV141EDM, FCV141EDS, FCV241E, FCV241EDM, FCV241EDS, FCV401EDM, FCV61E, FM1011E1, FM1011E1-VERS.2006, FM1011E2, FM1011E2-VERS.2006, FM1011E3, FM1011E3-VERS.2006, FM1221E1, FM1221E1-VERS.2006, FM1221E2, FM1221E2-VERS.2006, FM1221E3, FM1221E3-VERS.2006, FM2011E2-VERS.2006, FM2011E3-VERS.2006, FM2021E1, FM2021E2, FM2021E2-VERS.2006, FM2021E3, FM2021E3-VERS.2006, FM611E3, FM721E1, FM721E1-VERS.2006, FM721E2, FM721E2-VERS.2006, FM721E3... (Weitere Modelle finden Sie in unserem Webshop)		

<b>1</b>			
<b>GEV-Nr.</b>	380083	<b>Vergl.-Nr.</b>	3100940 32V5290
<b>Beschreibung</b>	Leistungsschütz AC1 25A 230VAC (AC3/400V) 9A/4,2kW Hauptkontakte 3NO Hilfskontakte 1NC Anschluss Schraubanschluss Typ BF0901A230		
<b>Für Modelle:</b>	04WBMEV, 06WFT1EV, 06WFT2EV, 06WFT3EV, 06WFT4EV, 06WFT6EV, 06WFT7EV, 08WFT1EV, 08WFT2EV, 08WFT3EV, 08WFT4EV, 08WFT6EV, 08WFT7EV, 091FT1E, 091FT2E, 091FT4E, 091FT5E, 091FT7E, 0G1CP1EC, 0G1FT2E, 0G1FT4E, 0G1FT5E, 0G1FT7E, 191FT1E, 191FT2E, 191FT3E, 191FT4E, 191FT6E, 191FT7E, 1G1FT2E, 1G1FT4E, 1G1FT5E, 1G1FT6E, 1G1FT7E, BX101E, BX101E-VERS.122013, BX101G, BX101G-VERS.122013, BX122E, BX122E-VERS.122013, BX122G, BX122G-VERS.122013, BX61E, BX61E-VERS.122013, BX61G, BX61G-VERS.122013, BX82E, BX82E-VERS.122013, BX82G, BX82G-VERS.122013...(Weitere Modelle finden Sie in unserem Webshop)		

<b>1</b>			
<b>GEV-Nr.</b>	380704	<b>Vergl.-Nr.</b>	32V6550
<b>Beschreibung</b>	Leistungsschütz AC1 20A 230VAC (AC3/400V) 9A/4kW Hauptkontakte 3NO Hilfskontakte 1NC Anschluss Schraubanschluss Typ 11BG0901A230		
<b>Für Modelle:</b>	08WGREV, 190GRE, 191BR2EA, 1A1BR2EA, 1D1BR2EA, 1G0GRE, 291BR1GA, 291BR2EA, 291BR2GA, 2A1BR1GA, 2A1BR2EA, 2A1BR2GA, 2D1BR1GA, 2D1BR2GA, FC1011E, FC1011G, FC1221E, FC1221G, FC611E, FC611G, FCV3EM, FM1011E3, FM1011E3-VERS.2006, FM1011G3, FM1011G3-VERS.2006, FM1221E3, FM1221E3-VERS.2006, FM1221G3, FM1221G3-VERS.2006, FM2021E3, FM2021G3, FM423E1, FM423E2, FM611E3, FM611E3-VERS.2006, FM611G3, FM611G3-VERS.2006, FM721E3, FM721E3-VERS.2006, FM721G3, FM721G3-VERS.2006, FX101E3, FX101E3C, FX101E3C-VERS.022014, FX101E3R, FX101E3R-VERS.022014, FX101E3-VERS.022014, FX101G3, FX101G3C, FX101G3C-VERS.022014...(Weitere Modelle finden Sie in unserem Webshop)		

<b>1</b>			
<b>GEV-Nr.</b>	380720	<b>Vergl.-Nr.</b>	32Z2090
<b>Beschreibung</b>	Leistungsschütz AC1 32A 230VAC (AC3/400V) 25A/12,5kW Hauptkontakte 3NO Hilfskontakte 1NO Anschluss Schraubanschluss Typ BF2510A230		

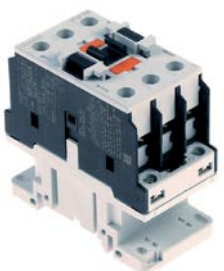

1

<b>GEV-Nr.</b>	380722	<b>Vergl.-Nr.</b>	3100930 32Z3511
<b>Beschreibung</b>	Leistungsschütz AC1 56A 230VAC (AC3/400V) 32A/16kW Hauptkontakte 3NO Hilfskontakte Anschluss Schraubanschluss Typ BF3200A230		
<b>Für Modelle:</b>	091FR1ED, 10CP1EA, 12CP1EA, 18CP2EA, BRE21HD, BRE31HD, BX101E, BX101E-VERS.122013, BX122E, BX122E-VERS.122013, BX61E, BX61E-VERS.122013, BX82E, BX82E-VERS.122013, FC1011E, FC101E, FC1221E, FC241E, FCV101E, FCV101EDM, FCV101EDS, FCV141E, FCV141EDM, FCV141EDS, FCV241E, FCV241EDM, FCV241EDS, FCV401EDM, FCV61E, FM1011E1, FM1011E1-VERS.2006, FM1011E2, FM1011E2-VERS.2006, FM1011E3, FM1011E3-VERS.2006, FM1221E1, FM1221E1-VERS.2006, FM1221E2, FM1221E2-VERS.2006, FM1221E3, FM1221E3-VERS.2006, FM2011E2-VERS.2006, FM2011E3-VERS.2006, FM2021E1, FM2021E2, FM2021E2-VERS.2006, FM2021E3, FM2021E3-VERS.2006, FM611E3, FM721E1...(Weitere Modelle finden Sie in unserem Webshop)		

**Überstromauslöser**



1

<b>GEV-Nr.</b>	380081	<b>Vergl.-Nr.</b>	32V6950
<b>Beschreibung</b>	Überstromauslöser Einstellbereich 0,6-1A für Schütze Serie BG (BG06-BG12) Anschluss Schraubanschluss		
<b>Für Modelle:</b>	FM1011E3, FM1221E3, FM1221G3, FM611E3, FM721E3		



1

<b>GEV-Nr.</b>	380743	<b>Vergl.-Nr.</b>	32V1010
<b>Beschreibung</b>	Überstromauslöser Einstellbereich 0,9-1,5A für Schütze Serie BG (BG06-BG12) Anschluss Schraubanschluss		
<b>Für Modelle:</b>	2A1BR1GA, 2A1BR2GA, 2D1BR1GA, 2D1BR2GA, FC101, FC101E, FC241, FC241E, FC241G, FC61, FC61E, FCV101, FCV101DM, FCV101DS, FCV101E, FCV101EDM, FCV101EDS, FCV141, FCV141DM, FCV141DS, FCV141E, FCV141EDM, FCV141EDS, FCV241, FCV241DM, FCV241DS, FCV241E, FCV241EDM, FCV241EDS, FCV241G, FCV241GDM, FCV241GDS, FCV401EDM, FCV61, FCV61DM, FCV61DS, FCV61E, FCV61EDM, FCV61EDS, FM1011E3-VERS.2006, FM1221E3-VERS.2006, FM611E3-VERS.2006, FM721E3-VERS.2006		



1

<b>GEV-Nr.</b>	380897	<b>Vergl.-Nr.</b>	32Z0930
<b>Beschreibung</b>	Überstromauslöser Einstellbereich 0,9-1,5A Typ 11RF25 1V5 für Schütze Serie BG (BG06-BG12) Anschluss mit Schraube		
<b>Für Modelle:</b>	FC101, FC101E, FC241, FC241E, FC241G, FC61, FC61E, FCV101, FCV101DM, FCV101DS, FCV101E, FCV101EDM, FCV101EDS, FCV141, FCV141DM, FCV141DS, FCV141E, FCV141EDM, FCV141EDS, FCV241, FCV241DM, FCV241DS, FCV241E, FCV241EDM, FCV241EDS, FCV241GDM, FCV241GDS, FCV401DM, FCV401EDM, FCV61, FCV61DM, FCV61DS, FCV61E, FCV61EDM, FCV61EDS, FM2011E3-VERS.2006, FM2021E3-VERS.2006		



1

<b>GEV-Nr.</b>	380744	<b>Vergl.-Nr.</b>	32V1020
<b>Beschreibung</b>	Überstromauslöser Einstellbereich 1,4-2,3A für Schütze Serie BG (BG06-BG12) Anschluss Schraubanschluss		
<b>Für Modelle:</b>	FC101, FC101E, FC241, FC241E, FC241G, FC61, FC61E, FCV101, FCV101DM, FCV101DS, FCV101E, FCV101EDM, FCV101EDS, FCV141, FCV141DM, FCV141DS, FCV141E, FCV141EDS, FCV241, FCV241DS, FCV241E, FCV241EDS, FCV241G, FCV241GDS, FCV401DM, FCV61, FCV61DM, FCV61DS, FCV61E, FCV61EDS, FM1221E3-VERS.2006, FM1221G3-VERS.2006		

**MOELLER/EATON**

**Leistungsschütze**



1

<b>GEV-Nr.</b>	380171	<b>Vergl.-Nr.</b>	32Z4840
<b>Beschreibung</b>	Leistungsschütz AC1 20A 230VAC (AC3/400V) 9A/4kW Hauptkontakte 3NO Hilfskontakte 1NO Anschluss Schraubanschluss Typ DILEM 10		
<b>Für Modelle:</b>	LCV, P10, P102, P10M, P20, P202, P5, Q3, Q3M, Q5, Q52, Q5M, Q8, Q82, TV1, TV1M, TV2L		

**SIEMENS**

**Leistungsschütze**



1

<b>GEV-Nr.</b>	380646	<b>Vergl.-Nr.</b>	32Z9250
<b>Beschreibung</b>	Leistungsschütz AC1 40A 230VAC (AC3/400V) 17A/7,5kW Hauptkontakte 3NO Hilfskontakte Anschluss Schraubanschluss Typ 3RT10-2S-1AL20		
<b>Für Modelle:</b>	ART1L7, ART1L7A, ART1L7M, ART1LD, ART1LD7, ART1LD7A, ART1LD7M, ART1LDA, ART2LD, ART2SD, ART3SD, B1101S, B151H, B151M, BF101L, BF101S, BF51H, BF51M, D12Q1M, D12Q2, D12Q2M, DS51, DS51A, DS51C, DS51M, FS611, GR135BT, GR140TN4, GR65BT, GR65TN4, IA101L, IA101S, IA51, IA51A, IA51C, IA51M, IA72S, IS101L, IS101LW, IS101S, IS101SR, IS101SW, IS102S, IS102SR-0NR01, IS102SW, IS51, IS51A, IS51AR, IS51C, IS51CR...(Weitere Modelle finden Sie in unserem Webshop)		

**TELEMECANIQUE (Schneider Electric)**

**Leistungsschütze**



1

<b>GEV-Nr.</b>	380617	<b>Vergl.-Nr.</b>	32Z8680
<b>Beschreibung</b>	Leistungsschütz AC1 25A 24VAC (AC3/400V) 9A/4kW Hauptkontakte 3NO Hilfskontakte 1NO/1NC Anschluss Schraubanschluss Typ LC1D09B7		
<b>Für Modelle:</b>	C165D, C165S, C165VD, C165VS, C207D, C207S, C207VD, C207VS, C304AD, C304AS, C304AVD, C304AVS, C304D, C304S, C304VD, C304VS, CS243D, CS243S, CS243VD, CS243VS, CS370AD, CS370AS, CS370AVD, CS370AVS, CS370D, CS370S, CS370VD, CS370VS, CS466AD, CS466AS, CS466AVD, CS466AVS, CS466D, CS466S, CS466VD, CS466VS, N303D, N303S, N303VD, N303VS, N354D, N354S, N354VD, N354VS, N506D, N506S, N506VD, N506VS, N607D, N607S...(Weitere Modelle finden Sie in unserem Webshop)		

**Relais**

**Leistungsrelais**

**mit Laschenbefestigung**



1

<b>GEV-Nr.</b>	380815	<b>Vergl.-Nr.</b>	32V0540
<b>Beschreibung</b>	Leistungsrelais 230VAC 16A 2NO Anschluss Flachstecker 6,3mm Flansch Maße 36x38x68mm		
<b>Für Modelle:</b>	LC100, LC100-VERS.2001, LC130, LC130-VERS.2001, LC80, LF50, LF50E		

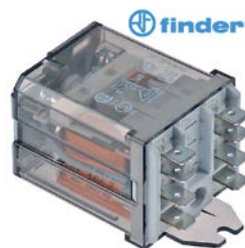

1

<b>GEV-Nr.</b>	380139	<b>Vergl.-Nr.</b>	32V2950 32V7100 32Z2000
<b>Beschreibung</b>	Leistungsrelais FINDER 230VAC 16A 2CO Anschluss F6,3 Laschenbefestigung Maße 68x38,2x35,8mm Hersteller-Nr. 62.82.8.230.0000		
<b>Für Modelle:</b>	F60P, F60PR, F60T, F80P, F80PR, KD100, KD100A, KD100PSD, KD37, KD40, KD85, KD85A, KD85PS, KD85PSA, KN35, KN37, KN37PS, KN40, KN40PS, KN40PSD, KN50, KN50M, KN50MPS, KN50PS, KN50PSD, KN50PSDD, KN80, KN80PS, L100, L40, L40S, L45, L60, L80, LC100, LC100-VERS.2001, LC130, LC130-VERS.2001, LC80, LP151		



1

<b>GEV-Nr.</b>	380403	<b>Vergl.-Nr.</b>	32V2940
<b>Beschreibung</b>	Leistungsrelais FINDER 230VAC 16A 3CO Anschluss F6,3 Laschenbefestigung Hersteller-Nr. 62.83.8.230.0500		
<b>Für Modelle:</b>	LF50EM, LP124, LP124V, LP84V		

## Transformatoren

### offene Transformatoren

#### mit Klemmanschluss



<b>1</b>	<b>GEV-Nr.</b>	403905	<b>Vergl.-Nr.</b>	3117170
	<b>Beschreibung</b>	Transformator primär 230V/50-60Hz sekundär 12V 50VA Anschluss Schraubanschluss Typ T1ULF		
	<b>Für Modelle:</b>	10CP1EA, 10CP1GA, 10CP1IA, 12CP1EA, 12CP1GA, 12CP1IA, 18CP2EA, 18CP2GA, 18CP2IA, FX101E1, FX101E1R, FX101E2, FX101E2C, FX101E2C-VERS.032014, FX101E2R, FX101E2R-VERS.032014, FX101E2-VERS.032014, FX101E3, FX101E3C, FX101E3C-VERS.022014, FX101E3R, FX101E3R-VERS.022014, FX101E3-VERS.022014, FX101G1, FX101G1R, FX101G2, FX101G2C, FX101G2C-VERS.032014, FX101G2R, FX101G2R-VERS.032014, FX101G2-VERS.032014, FX101G3, FX101G3C, FX101G3C-VERS.022014, FX101G3R, FX101G3R-VERS.022014, FX101G3-VERS.022014, FX10E2CR, FX10E2CR-VERS.032014, FX10E3CR, FX10E3CR-VERS.022014, FX10G2CR, FX10G2CR-VERS.032014, FX10G3CR, FX10G3CR-VERS.022014, FX122E1, FX122E2, FX122E2C, FX122E2T, FX122E2T-VERS.032014...(Weitere Modelle finden Sie in unserem Webshop)		

#### mit Steckverbindung



<b>1</b>	<b>GEV-Nr.</b>	400956	<b>Vergl.-Nr.</b>	32V5770
	<b>Beschreibung</b>	Transformator primär 230VAC sekundär 12VAC 20VA Anschluss Flachstecker 6,3mm 50/60Hz Typ T602012/E TB 150°C Umgebungstemperatur max. 80°C		
	<b>Für Modelle:</b>	B1101S, B151H, B151M, BF101L, BF101S, BF51H, BF51M, BX101E, BX101E-VERS.122013, BX101G, BX101G-VERS.122013, BX61E, BX61E-VERS.122013, BX61G, BX61G-VERS.122013, BX82E, BX82E-VERS.122013, BX82G, BX82G-VERS.122013, FM1011E1, FM1011E1-VERS.2006, FM1011E2, FM1011E2-VERS.2006, FM1011E3, FM1011E3-VERS.2006, FM1011G1, FM1011G1-VERS.2006, FM1011G2, FM1011G2-VERS.2006, FM1011G3, FM1011G3-VERS.2006, FM611E1, FM611E1-VERS.2006, FM611E2, FM611E2-VERS.2006, FM611E3, FM611E3-VERS.2006, FM611G1, FM611G1-VERS.2006, FM611G2, FM611G2-VERS.2006, FM611G3, FM611G3-VERS.2006, FM721E1, FM721E1-VERS.2006, FM721E2, FM721E2-VERS.2006, FM721E3, FM721E3-VERS.2006, FM721G1...(Weitere Modelle finden Sie in unserem Webshop)		

<b>1</b>			
<b>GEV-Nr.</b>	380812	<b>Vergl.-Nr.</b>	3038640 3251120
<b>Beschreibung</b>	Leistungsrelais FINDER 230VAC 30A 2CO Anschluss F6,3 Laschenbefestigung Hersteller-Nr. 66.82.8.230.0000		

<b>1</b>			
<b>GEV-Nr.</b>	380185	<b>Vergl.-Nr.</b>	32V3720
<b>Beschreibung</b>	Leistungsrelais Italiana Relè 230VAC 30A 1NO Anschluss F6,3 Laschenbefestigung Maße 36,5x32,2x51,8mm Hersteller-Nr. A10-230AC-FA		
<b>Für Modelle:</b>	120B, 135B, 135BA, 135BN, 135BNX, 135BX, 135BXE, 135BXR, 135XR, 55B, 65B, 65BA, 65BX, 65BX-2, 65BXE, 65BXR, 65NB, 65NBX, 65XR, 6BMABA, 6BMABB, 6BMABM, 6BMABBA, 6BMABBB, 6BMABBM, 6BMABBZ, 6BMCBA, 6BMCBB, 6BMCBM, 6BMCBZ, 6ERAB-OPR01, 6ERABA-OPR01, 6ERABM-OPR01, 6ERBB-OPR01, 6ERBBA-OPR01, 6ERBBM-OPR01, 6ERCB-OPR01, 6ERCBA-OPR01, 6ERCBM-OPR01, AGL6B, ART1L, ART1L7, ART1L7A, ART1L7M, ART1LA, BM1AB, BM1BB, BM1CB, BS11, BS11A...(Weitere Modelle finden Sie in unserem Webshop)		

### Steck/Printrelais

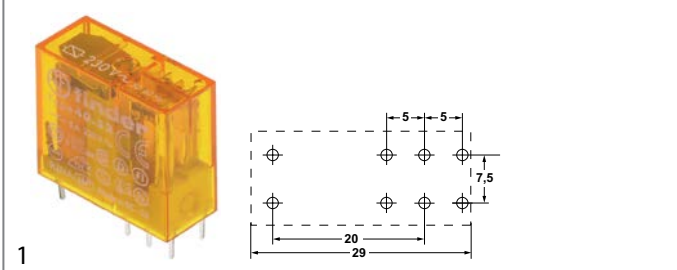

<b>1</b>	<b>GEV-Nr.</b>	380333	<b>Vergl.-Nr.</b>	32V6630	
	<b>Beschreibung</b>	Printrelais 230VAC 2CO bei 250V 8A Anschluss Pins Rastermaß 5mm FINDER Hersteller-Nr. 40.52.8.230.0000 95.65/95.75			
	<b>Für Modelle:</b>	191BR2EA, FM1221G1, FM1221G2, FM1221G3, FM2011G2-VERS.2006, FM2011G3-VERS.2006, FM2021G1, FM2021G2, FM2021G2-VERS.2006, FM2021G3, FM2021G3-VERS.2006			
	<b>Zubehör für</b>	380333			
		<b>GEV-Nr.</b>	380340	<b>Vergl.-Nr.</b>	—
		Relais-Sockel Maße 62x36x15mm 250V Spannung AC 10A Italiana Relè Hersteller-Nr. ZMEM/5			
		<b>GEV-Nr.</b>	380505	<b>Vergl.-Nr.</b>	—
		Relais-Sockel 2CO 40.52 Maße 81,9x15,5x75mm 250V Spannung AC 10A FINDER Hersteller-Nr. 95.95.3			
		<b>GEV-Nr.</b>	381181	<b>Vergl.-Nr.</b>	—
		Relais-Sockel 2-polig 40.51/40.52/40.61 Anschluss Schraubklemme Maße 15,8x78,6mm 250V Spannung AC 10A FINDER Hersteller-Nr. 95.75			





vergossene Transformatoren

PMA



<b>GEV-Nr.</b>	379054	<b>Vergl.-Nr.</b>	32Z3470
<b>Beschreibung</b>	Transformator primär 230VAC sekundär 12VAC 3VA sekundär 0.25A H 40mm L 45mm B 50mm Anschluss Schraubanschluss 50/60Hz Typ 153/M		
<b>Für Modelle:</b>	120, 120B, 120PV, 135, 135-4, 135B, 135BA, 135BN, 135BNX, 135BX, 135BXE, 135BXR, 135CPX, 135PVX, 135X, 135X-3, 135X-4, 135XR, 40CP, 40CPX, 55, 55B, 55PV, 65, 65B, 65BA, 65BX, 65BX-2, 65BXE, 65BXR, 65NB, 65NBX, 65PVX, 65X, 65X-2, 65XR, 6BMA11A, 6BMA11B, 6BMA11M, 6BMA11Z, 6BMA2A, 6BMA2B, 6BMA2M, 6BMA2Z, 6BMA3A, 6BMA3B, 6BMA3M, 6BMA3Z, 6BMAA, 6BMAB...(Weitere Modelle finden Sie in unserem Webshop)		

<b>GEV-Nr.</b>	379934	<b>Vergl.-Nr.</b>	32Z6191
<b>Beschreibung</b>	Temperaturfühler Pt100 Kabel Silikon Fühler -100 bis +450°C Kabel -50 bis +180°C Anschluss 3-adrig Gewinde M10x1 Fühler ø3x65mm Kabellänge 0.65m		
<b>Für Modelle:</b>	FCV101, FCV101-CSA, FCV101DM, FCV101DM-CSA, FCV101DS, FCV101DS-CSA, FCV101E, FCV101EDM, FCV101EDM-UL, FCV101EDS, FCV101EDS-UL, FCV101E-UL, FCV141, FCV141-CSA, FCV141DM, FCV141DM-CSA, FCV141DS, FCV141DS-CSA, FCV141E, FCV141EDM, FCV141EDS, FCV241, FCV241DM, FCV241DS, FCV241E, FCV241EDM, FCV241EDM-UL, FCV241EDS, FCV241EDS-UL, FCV241E-UL, FCV241G, FCV241G-CSA, FCV241GDM, FCV241GDM-CSA, FCV241GDS, FCV241GDS-CSA, FCV3EM, FCV401DM, FCV401DM-CSA, FCV401EDM, FCV401EDM-UL, FCV4E, FCV4EDS, FCV4EM, FCV61, FCV61-CSA, FCV61DM, FCV61DM-CSA, FCV61DS, FCV61DS-CSA...(Weitere Modelle finden Sie in unserem Webshop)		

Fühler

Universalfühler

Temperaturfühler

<b>GEV-Nr.</b>	379064	<b>Vergl.-Nr.</b>	32V0150 8223470
<b>Beschreibung</b>	Temperaturfühler PTC 1kOhm Kabel Silikon Fühler -50 bis +150°C Kabel -50 bis +180°C Fühler ø6x40mm Kabellänge 3m ohne Verschraubung 2-adrig		

<b>GEV-Nr.</b>	379931	<b>Vergl.-Nr.</b>	32Z6780
<b>Beschreibung</b>	Temperaturfühler Pt100 Kabel Vetrotex Fühler -200 bis +600°C Kabel -50 bis +350°C Anschluss 3-adrig Gewinde M10x1 Fühler ø4x85mm Kabellänge 0.8m		
<b>Für Modelle:</b>	FCV4E, FCV4EDS		

Herstellerspezifische Fühler

Fühler

<b>GEV-Nr.</b>	379932	<b>Vergl.-Nr.</b>	32Z6041
<b>Beschreibung</b>	Temperaturfühler Pt100 Kabel Silikon Fühler -100 bis +450°C Kabel -50 bis +180°C Anschluss 3-adrig Gewinde M10x1 Fühler ø3x130mm Kabellänge 1.5m		
<b>Für Modelle:</b>	FCV101DM, FCV101DM-CSA, FCV101DS, FCV101DS-CSA, FCV101EDM, FCV101EDM-UL, FCV101EDS, FCV101EDS-UL, FCV141DM, FCV141DM-CSA, FCV141DS, FCV141DS-CSA, FCV141EDM, FCV141EDS, FCV241DM, FCV241DS, FCV241EDM, FCV241EDM-UL, FCV241EDS, FCV241EDS-UL, FCV241GDM, FCV241GDM-CSA, FCV241GDS, FCV241GDS-CSA, FCV401DM, FCV401DM-CSA, FCV401EDM, FCV401EDM-UL, FCV61DM, FCV61DM-CSA, FCV61DS, FCV61DS-CSA, FCV61EDM, FCV61EDM-UL, FCV61EDS, FCV61EDS-UL, FCV72EDM-UL, FCV72EDS-UL		

<b>GEV-Nr.</b>	379331	<b>Vergl.-Nr.</b>	32V5750
<b>Beschreibung</b>	Temperaturfühler Pt1000 Kabel PTFE Fühler -70 bis +500°C Kabel -40 bis +250°C Anschluss 2-adrig Gewinde M10x1 Fühler ø3x60mm Kabellänge 0.7m		
<b>Für Modelle:</b>	091FR1EX, 091FR11A, 091FR11D, 091FR11D-VERS.052012, 10CP1EA, 10CP1GA, 10CP1IA, 12CP1EA, 12CP1GA, 12CP1IA, 18CP2EA, 18CP2GA, 18CP2IA, 191FR2ED, 191FR2ID, 191FR2ID-VERS.092012, BX101E, BX101E-VERS.122013, BX101G, BX101G-VERS.122013, BX122E, BX122E-VERS.122013, BX122G, BX122G-VERS.122013, BX61E, BX61E-VERS.122013, BX61G, BX61G-VERS.122013, BX82E, BX82E-VERS.122013, BX82G, BX82G-VERS.122013, FM1011E1, FM1011E1-VERS.2006, FM1011E2, FM1011E2-VERS.2006, FM1011E3, FM1011E3-VERS.2006, FM1011G1, FM1011G1-VERS.2006, FM1011G2, FM1011G2-VERS.2006, FM1011G3, FM1011G3-VERS.2006, FM1221E1, FM1221E1-VERS.2006, FM1221E2, FM1221E2-VERS.2006, FM1221E3, FM1221E3-VERS.2006...(Weitere Modelle finden Sie in unserem Webshop)		

<b>GEV-Nr.</b>	378647	<b>Vergl.-Nr.</b>	32V5760
<b>Beschreibung</b>	Temperaturfühler Pt1000 Kabel Vetrotex Fühler -70 bis +500°C Kabel -50 bis +350°C Anschluss 2-adrig Gewinde M10x1 Fühler ø3x100mm Kabellänge 1m		
<b>Für Modelle:</b>	091FR1EA, 091FR1ED, 091FR7GS, 091FR7GX, 191FR2ED, FM1011E1, FM1011E1-VERS.2006, FM1011E2, FM1011E2-VERS.2006, FM1011E3, FM1011E3-VERS.2006, FM1011G1, FM1011G1-VERS.2006, FM1011G2, FM1011G2-VERS.2006, FM1011G3, FM1011G3-VERS.2006, FM1221E1, FM1221E1-VERS.2006, FM1221E2, FM1221E2-VERS.2006, FM1221E3, FM1221E3-VERS.2006, FM1221G1, FM1221G1-VERS.2006, FM1221G2, FM1221G2-VERS.2006, FM1221G3, FM1221G3-VERS.2006, FM2011E2-VERS.2006, FM2011E3-VERS.2006, FM2011G2-VERS.2006, FM2011G3-VERS.2006, FM2021E1, FM2021E2, FM2021E2-VERS.2006, FM2021E3, FM2021E3-VERS.2006, FM2021G1, FM2021G2, FM2021G2-VERS.2006, FM2021G3, FM2021G3-VERS.2006, FM611E1, FM611E1-VERS.2006, FM611E2, FM611E2-VERS.2006, FM611E3, FM611E3-VERS.2006, FM611G1...(Weitere Modelle finden Sie in unserem Webshop)		

Einsteckfühler



<b>GEV-Nr.</b>	379933	<b>Vergl.-Nr.</b>	32Z1982 32Z1983
<b>Beschreibung</b>	Kerntemperaturfühler Pt100 Kabel PTFE Fühler -40 bis +250°C Kabel -40 bis +250°C Anschluss 3-adrig Fühler ø2,5x100mm Gewinde Kabellänge 2.75m Griff ø 15mm Grifflänge 90mm		
<b>Für Modelle:</b>	FCV101DM, FCV101DM-CSA, FCV101DS, FCV101DS-CSA, FCV101EDM, FCV101EDM-UL, FCV101EDS, FCV101EDS-UL, FCV141DM, FCV141DM-CSA, FCV141DS, FCV141DS-CSA, FCV141EDM, FCV141EDS, FCV241DM, FCV241DS, FCV241EDM, FCV241EDM-UL, FCV241EDS, FCV241EDS-UL, FCV241GDM, FCV241GDS, FCV241GDS-CSA, FCV401DM, FCV401DM-CSA, FCV401EDM, FCV401EDM-UL, FCV4EDS, FCV61DM, FCV61DM-CSA, FCV61DS, FCV61DS-CSA, FCV61EDM, FCV61EDM-UL, FCV61EDS, FCV61EDS-UL, FCV72EDM-UL, FCV72EDS-UL		



<b>GEV-Nr.</b>	381511	<b>Vergl.-Nr.</b>	3116780
<b>Beschreibung</b>	Kerntemperaturfühler Pt1000 Anschluss 6-adrig Fühler ø3,2x100mm Kabellänge 3.1m Griff ø 13mm Grifflänge 70mm Kombidämpfer		



<b>GEV-Nr.</b>	403452	<b>Vergl.-Nr.</b>	6300643
<b>Beschreibung</b>	Kerntemperaturfühler Pt1000 Kabel PTFE Fühler -40 bis +250°C Kabel -40 bis +250°C Anschluss 2-adrig Fühler ø3x100mm Gewinde Kabellänge 3.2m Griff ø 13mm Grifflänge 60mm		
<b>Für Modelle:</b>	FM1011E2-VERS.2006, FM1011G2-VERS.2006, FM1221E2-VERS.2006, FM1221G2-VERS.2006, FM2011E2-VERS.2006, FM2011G2-VERS.2006, FM2021E2-VERS.2006, FM2021G2-VERS.2006, FM611E2-VERS.2006, FM611G2-VERS.2006, FM721E2-VERS.2006, FM721G2-VERS.2006		



<b>GEV-Nr.</b>	401966	<b>Vergl.-Nr.</b>	6300644
<b>Beschreibung</b>	Kerntemperaturfühler Pt1000 Kabel PTFE Fühler -40 bis +250°C Kabel -40 bis +250°C Anschluss 3-adrig Fühler ø3x100mm Gewinde Kabellänge 1.5m Griff ø 13mm Grifflänge 75mm		
<b>Für Modelle:</b>	FM1011E3-VERS.2006, FM1011G3-VERS.2006, FM1221E3-VERS.2006, FM1221G3-VERS.2006, FM2011E3-VERS.2006, FM2011G3-VERS.2006, FM2021E3-VERS.2006, FM2021G3-VERS.2006, FM611E3-VERS.2006, FM611G3-VERS.2006, FM721E3-VERS.2006, FM721G3-VERS.2006		



<b>GEV-Nr.</b>	378264	<b>Vergl.-Nr.</b>	3159510 3159511 3200361
<b>Beschreibung</b>	Kerntemperaturfühler Pt1000 Kabel PTFE Fühler -40 bis +250°C Kabel -40 bis +250°C Anschluss 5-adrig Fühler ø3x100mm Gewinde Kabellänge 2.7m Griff ø 13mm Grifflänge 75mm		
<b>Für Modelle:</b>	FM1011E3, FM1011G3, FM1221E3, FM1221G3, FM2021E3, FM2021G3, FM611E3, FM611G3, FM721E3, FM721G3		



<b>GEV-Nr.</b>	379588	<b>Vergl.-Nr.</b>	3139610 32V5940
<b>Beschreibung</b>	Kerntemperaturfühler Pt1000 Kabel Thermoplast Fühler -40 bis +250°C Kabel -40 bis +110°C Anschluss 2-adrig Fühler ø3x110mm Gewinde Kabellänge 3.1m Griff ø 13mm Grifflänge 70mm		
<b>Für Modelle:</b>	FM1011E2, FM1011G2, FM1221E2, FM1221G2, FM2021E2, FM2021G2, FM423E2, FM611E2, FM611G2, FM721E2, FM721G2, FX101E2, FX101E2C, FX101E2C-VERS.032014, FX101E2R, FX101E2R-VERS.032014, FX101E2-VERS.032014, FX101G2, FX101G2C, FX101G2C-VERS.032014, FX101G2R, FX101G2R-VERS.032014, FX101G2-VERS.032014, FX10E2CR, FX10E2CR-VERS.032014, FX10G2CR, FX10G2CR-VERS.032014, FX122E2, FX122E2C, FX122E2T, FX122E2T-VERS.032014, FX122G2, FX122G2C, FX122G2T, FX122G2T-VERS.032014, FX201E2, FX201E2P, FX201E2P-VERS.032014, FX201E2-VERS.032014, FX201G2, FX201G2P, FX201G2P-VERS.032014, FX201G2-VERS.032014, FX202E2, FX202E2-VERS.032014, FX202G2, FX202G2-VERS.032014, FX61E2, FX61E2C, FX61E2CR...(Weitere Modelle finden Sie in unserem Webshop)		

Zubehör

Verschraubungen



<b>GEV-Nr.</b>	401967	<b>Vergl.-Nr.</b>	3004870
<b>Beschreibung</b>	Verschraubung für Kerntemperaturfühler		
<b>Für Modelle:</b>	FM1011E2, FM1011E2-VERS.2006, FM1011E3, FM1011E3-VERS.2006, FM1011G2, FM1011G2-VERS.2006, FM1011G3, FM1011G3-VERS.2006, FM1221E2, FM1221E2-VERS.2006, FM1221E3, FM1221E3-VERS.2006, FM1221G2, FM1221G2-VERS.2006, FM1221G3, FM1221G3-VERS.2006, FM2011E2-VERS.2006, FM2011E3-VERS.2006, FM2011G2-VERS.2006, FM2011G3-VERS.2006, FM2021E2, FM2021E2-VERS.2006, FM2021E3, FM2021E3-VERS.2006, FM2021G2, FM2021G2-VERS.2006, FM2021G3, FM2021G3-VERS.2006, FM611E2, FM611E2-VERS.2006, FM611E3, FM611E3-VERS.2006, FM611G2, FM611G2-VERS.2006, FM611G3, FM611G3-VERS.2006, FM721E2, FM721E2-VERS.2006, FM721E3, FM721E3-VERS.2006, FM721G2, FM721G2-VERS.2006, FM721G3, FM721G3-VERS.2006, FX101E2, FX101E2C, FX101E3, FX101E3C, FX101E3R, FX101G2...(Weitere Modelle finden Sie in unserem Webshop)		

Weiteres



<b>GEV-Nr.</b>	519385	<b>Vergl.-Nr.</b>	3150220
<b>Beschreibung</b>	Dichtung für Kerntemperaturfühler AD ø 8mm ID ø 4mm Materialstärke 5mm		
<b>Für Modelle:</b>	FCV101DM, FCV101DM-CSA, FCV101DS, FCV101DS-CSA, FCV101EDM, FCV101EDM-UL, FCV101EDS, FCV101EDS-UL, FCV141DM, FCV141DM-CSA, FCV141DS, FCV141DS-CSA, FCV141EDM, FCV141EDS, FCV241DM, FCV241DS, FCV241EDM, FCV241EDM-UL, FCV241EDS, FCV241EDS-UL, FCV241GDM, FCV241GDM-CSA, FCV241GDS, FCV241GDS-CSA, FCV401DM, FCV401DM-CSA, FCV401EDM, FCV401EDM-UL, FCV4EDS, FCV61DM, FCV61DM-CSA, FCV61DS, FCV61DS-CSA, FCV61EDM, FCV61EDM-UL, FCV61EDS, FCV61EDS-UL, FCV72EDM-UL, FCV72EDS-UL, FM1011E2, FM1011E3, FM1011G2, FM1011G3, FM1221E2, FM1221E3, FM1221G2, FM1221G3, FM2021E2, FM2021E3, FM2021G2...(Weitere Modelle finden Sie in unserem Webshop)		

			
1			
<b>GEV-Nr.</b>	691159	<b>Vergl.-Nr.</b>	35Q6360
<b>Beschreibung</b>	Schutzblech für Fühler		
<b>Für Modelle:</b>	FC101, FC101E, FC241, FC241E, FC241G, FC61, FC61E, FCV101, FCV101-CSA, FCV101DM, FCV101DM-CSA, FCV101DS, FCV101DS-CSA, FCV101E, FCV101EDM, FCV101EDM-UL, FCV101EDS, FCV101EDS-UL, FCV101E-UL, FCV141, FCV141-CSA, FCV141DM, FCV141DM-CSA, FCV141DS, FCV141DS-CSA, FCV141E, FCV141EDM, FCV141EDS, FCV241, FCV241DM, FCV241DS, FCV241E, FCV241EDM, FCV241EDM-UL, FCV241EDS, FCV241EDS-UL, FCV241E-UL, FCV241G, FCV241G-CSA, FCV241GDM, FCV241GDM-CSA, FCV241GDS, FCV241GDS-CSA, FCV401DM, FCV401DM-CSA, FCV401EDM, FCV401EDM-UL, FCV4E, FCV4EDS, FCV61...(Weitere Modelle finden Sie in unserem Webshop)		

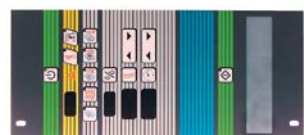
			
1			
<b>GEV-Nr.</b>	401183	<b>Vergl.-Nr.</b>	32Z6621 32Z6622
<b>Beschreibung</b>	Tastaturplatte		
<b>Für Modelle:</b>	FCV4E		

			
1			
<b>GEV-Nr.</b>	401184	<b>Vergl.-Nr.</b>	32Z1081 32Z1082
<b>Beschreibung</b>	Tastaturplatte		
<b>Für Modelle:</b>	FCV4EDS		

## Elektroniken

### Platinen

			
1			
<b>GEV-Nr.</b>	404028	<b>Vergl.-Nr.</b>	6300751
<b>Beschreibung</b>	Platine für Kombidämpfer ANGELO PO L 140mm B 100mm		
<b>Für Modelle:</b>	BX101G, BX101G-VERS.122013, BX122G, BX122G-VERS.122013, BX61G, BX61G-VERS.122013, BX82G, BX82G-VERS.122013, FX101G1, FX101G1R, FX101G2, FX101G2C, FX101G2C-VERS.032014, FX101G2R, FX101G2R-VERS.032014, FX101G2-VERS.032014, FX101G3, FX101G3C, FX101G3C-VERS.022014, FX101G3R, FX101G3R-VERS.022014, FX101G3-VERS.022014, FX10G2CR, FX10G2CR-VERS.032014, FX10G3CR, FX10G3CR-VERS.022014, FX122G1, FX122G2, FX122G2C, FX122G2T, FX122G2T-VERS.032014, FX122G3, FX122G3C, FX122G3T, FX122G3T-VERS.022014, FX12G3CT, FX12G3CT-VERS.022014, FX201G2, FX201G2P, FX201G2P-VERS.032014, FX201G2-VERS.032014, FX201G3P, FX201G3-VERS.022014, FX202G2, FX202G2-VERS.032014, FX202G3, FX202G3-VERS.022014, FX61G1, FX61G1R, FX61G2...(Weitere Modelle finden Sie in unserem Webshop)		

			
1			
<b>GEV-Nr.</b>	402867	<b>Vergl.-Nr.</b>	3018770 3018771
<b>Beschreibung</b>	Tastaturplatte Kombidämpfer für Gerät FM1011 L 275mm B 100mm passend für ANGELO PO Tasten 12		
<b>Für Modelle:</b>	FM1011E1, FM1011E2, FM1011E3, FM1011G1, FM1011G2, FM1011G3, FM1221E1, FM1221E2, FM1221E3, FM1221G1, FM1221G2, FM1221G3, FM2021E1, FM2021E2, FM2021E3, FM2021G1, FM2021G2, FM2021G3, FM611E1, FM611E2, FM611E3, FM611G1, FM611G2, FM611G3, FM721E1, FM721E2, FM721E3, FM721G1, FM721G2, FM721G3		

			
1			
<b>GEV-Nr.</b>	402866	<b>Vergl.-Nr.</b>	32V5360 32V5361
<b>Beschreibung</b>	Platine Kombidämpfer für Gerät FM1011 passend für ANGELO PO		
<b>Für Modelle:</b>	FM1011E1, FM1011E1-VERS.2006, FM1011E2, FM1011E2-VERS.2006, FM1011E3, FM1011G1, FM1011G1-VERS.2006, FM1011G2, FM1011G2-VERS.2006, FM1011G3, FM1221E1, FM1221E1-VERS.2006, FM1221E2, FM1221E2-VERS.2006, FM1221E3, FM1221G1, FM1221G1-VERS.2006, FM1221G2, FM1221G2-VERS.2006, FM1221G3, FM2011E2-VERS.2006, FM2011G2-VERS.2006, FM2021E1, FM2021E2, FM2021E2-VERS.2006, FM2021G1, FM2021G2, FM2021G2-VERS.2006, FM611E1, FM611E1-VERS.2006, FM611E2, FM611E2-VERS.2006, FM611E3, FM611G1, FM611G1-VERS.2006, FM611G2, FM611G2-VERS.2006, FM611G3, FM721E1, FM721E1-VERS.2006, FM721E2, FM721E2-VERS.2006, FM721G1, FM721G1-VERS.2006, FM721G2, FM721G2-VERS.2006		

## Tastaturen

### Frontfolien

			
1			
<b>GEV-Nr.</b>	401180	<b>Vergl.-Nr.</b>	37M4201
<b>Beschreibung</b>	Frontfolie		
<b>Für Modelle:</b>	FC101, FC101E, FC241, FC241E, FC241G, FC61, FC61E		



1

<b>GEV-Nr.</b>	401181	<b>Vergl.-Nr.</b>	37M9220
<b>Beschreibung</b>	Frontfolie		
<b>Für Modelle:</b>	FCV3EM, FCV4EM		



1

<b>GEV-Nr.</b>	401182	<b>Vergl.-Nr.</b>	37M5641
<b>Beschreibung</b>	Frontfolie		
<b>Für Modelle:</b>	FCV101, FCV101E, FCV141, FCV141E, FCV241, FCV241E, FCV241G, FCV61, FCV61E		



1







<b>GEV-Nr.</b>	374053	<b>Vergl.-Nr.</b>	3032680
<b>Beschreibung</b>	Magnetventil 1-fach gerade 230VAC Eingang 3/4" Ausgang 11,5mm T.max. 60°C ELBI Kunststoff Reduzierung Ausgang orange		
<b>Für Modelle:</b>	BX101E, BX101E-VERS.122013, BX101G, BX101G-VERS.122013, BX122E, BX122E-VERS.122013, BX122G, BX122G-VERS.122013, BX61E, BX61E-VERS.122013, BX61G, BX61G-VERS.122013, BX82E, BX82E-VERS.122013, BX82G, BX82G-VERS.122013, FM1011E1, FM1011E1-VERS.2006, FM1011E2, FM1011E2-VERS.2006, FM1011E3, FM1011E3-VERS.2006, FM1011G1, FM1011G1-VERS.2006, FM1011G2, FM1011G2-VERS.2006, FM1011G3, FM1011G3-VERS.2006, FM1221E1, FM1221E1-VERS.2006, FM1221E2, FM1221E2-VERS.2006, FM1221E3, FM1221E3-VERS.2006, FM1221G1, FM1221G1-VERS.2006, FM1221G2, FM1221G2-VERS.2006, FM1221G3, FM1221G3-VERS.2006, FM2021E1, FM2021E2, FM2021G1, FM2021G2, FM423E2, FM611E1, FM611E1-VERS.2006, FM611E2, FM611E2-VERS.2006, FM611E3...(Weitere Modelle finden Sie in unserem Webshop)		

**MÜLLER**

*Temperatur Medium: 90°C  
Einschaltdauer: 100%*



1

<b>GEV-Nr.</b>	370117	<b>Vergl.-Nr.</b>	33D2460	
<b>Beschreibung</b>	Magnetventil 1-fach gerade 230VAC Eingang 3/4" Ausgang 11,5mm DN10 T.max. 90°C Einschaltdauer 100% MÜLLER			
<b>Für Modelle:</b>	FM1011E3, FM1011G3, FM1221E1, FM1221E2, FM1221E3, FM1221G1, FM1221G2, FM1221G3, FM611E3, FM611G3, FM721E1, FM721E2, FM721E3, FM721G1, FM721G2, FM721G3			
<b>Ersatzteile für</b>	370117			
	<b>GEV-Nr.</b>	370133	<b>Vergl.-Nr.</b>	—
	Magnetventilkörper 1-fach gerade Eingang 3/4" Ausgang 11,5mm DN10 T.max. 90°C Einschaltdauer 100% MÜLLER 230V			
	<b>GEV-Nr.</b>	371002	<b>Vergl.-Nr.</b>	—
	Magnetventilhalter MÜLLER Flanschhalterung			
	<b>GEV-Nr.</b>	371009	<b>Vergl.-Nr.</b>	—
	Druckfeder für Magnetspule			
	<b>GEV-Nr.</b>	371011	<b>Vergl.-Nr.</b>	—
	Ersatzteilkit Membran mit langem Stern Stern Höhe 8mm MÜLLER			
	<b>GEV-Nr.</b>	371017	<b>Vergl.-Nr.</b>	—
	Magnetspule MÜLLER 220-240VAC 50-60Hz Anschluss Flachstecker 6,3mm			
	<b>GEV-Nr.</b>	371122	<b>Vergl.-Nr.</b>	—
	Magnetventilsieb ø 19mm H 10mm passend für MÜLLER			
	<b>GEV-Nr.</b>	501161	<b>Vergl.-Nr.</b>	—
	Oberteil für Magnetventil Halter für Magnetspulen			

Tabellenfortsetzung auf der nächsten Seite

**Magnetventile**

Magnetventile Wasser



ELBI

gerade



1

<b>GEV-Nr.</b>	373017	<b>Vergl.-Nr.</b>	33D2310	
<b>Beschreibung</b>	Magnetventil 1-fach gerade 230VAC Eingang 3/4" Ausgang 11,5mm DN10 ELBI			
<b>Ersatzteile für</b>	373017			
	<b>GEV-Nr.</b>	370467	<b>Vergl.-Nr.</b>	N/A
	Magnetventilsieb passend für ELBI			

<b>Zubehör für</b>	370117			
	GEV-Nr.	371010	Vergl.-Nr.	—
	Magnetspule 230VAC Anschluss mit Kabel Kabellänge 2000mm			
	GEV-Nr.	371037	Vergl.-Nr.	—
	Magnetspule 24VAC 50/60Hz Anschluss Flachstecker 6,3mm			
	GEV-Nr.	371038	Vergl.-Nr.	—
	Magnetspule 230VAC Anschluss Gerätestecker			















				
1				
<b>GEV-Nr.</b>	370158	<b>Vergl.-Nr.</b>	33D1710 33D2410	
<b>Beschreibung</b>	Magnetventil 2-fach gerade 230VAC Eingang 3/4" Ausgang 11,5mm DN10 T.max. 90°C Einschaltdauer 100% MÜLLER			
<b>Für Modelle:</b>	FC101, FC101E, FC241E, FC241G, FC61, FC61E, FCV101, FCV101-CSA, FCV101DM, FCV101DM-CSA, FCV101DS, FCV101DS-CSA, FCV101E, FCV101EDM, FCV101EDM-UL, FCV101EDS, FCV101EDS-UL, FCV101E-UL, FCV141, FCV141-CSA, FCV141DM, FCV141DM-CSA, FCV141DS, FCV141DS-CSA, FCV141E, FCV141EDM, FCV141EDS, FCV241E, FCV241EDM, FCV241EDM-UL, FCV241EDS, FCV241EDS-UL, FCV241E-UL, FCV241G, FCV241G-CSA, FCV241GDM, FCV241GDM-CSA, FCV241GDS, FCV241GDS-CSA, FCV401DM, FCV401DM-CSA, FCV401EDM, FCV401EDM-UL, FCV61, FCV61-CSA, FCV61DM, FCV61DM-CSA, FCV61DS, FCV61DS-CSA, FCV61E... (Weitere Modelle finden Sie in unserem Webshop)			
<b>Ersatzteile für</b>	370158			
	GEV-Nr.	370195	Vergl.-Nr.	—
	Magnetventilkörper 2-fach gerade Eingang 3/4" Ausgang 11,5mm DN10 T.max. 90°C Einschaltdauer 100% MÜLLER 230V			
	GEV-Nr.	371002	Vergl.-Nr.	—
	Magnetventilhalter MÜLLER Flanschhalterung			
	GEV-Nr.	371009	Vergl.-Nr.	—
	Druckfeder für Magnetspule			
	GEV-Nr.	371011	Vergl.-Nr.	—
	Ersatzteilkits Membran mit langem Stern Stern Höhe 8mm MÜLLER			
	GEV-Nr.	371017	Vergl.-Nr.	—
	Magnetspule MÜLLER 220-240VAC 50-60Hz Anschluss Flachstecker 6,3mm			
	GEV-Nr.	371122	Vergl.-Nr.	—
	Magnetventilsieb ø 19mm H 10mm passend für MÜLLER			
	GEV-Nr.	501161	Vergl.-Nr.	—
	Oberteil für Magnetventil Halter für Magnetspulen			
<b>Zubehör für</b>	370158			
	GEV-Nr.	371010	Vergl.-Nr.	—
	Magnetspule 230VAC Anschluss mit Kabel Kabellänge 2000mm			
	GEV-Nr.	371037	Vergl.-Nr.	—
	Magnetspule 24VAC 50/60Hz Anschluss Flachstecker 6,3mm			
	GEV-Nr.	371038	Vergl.-Nr.	—
	Magnetspule 230VAC Anschluss Gerätestecker			







Magnetventile mit Reduzierung			
2-fach			
			
1			
<b>GEV-Nr.</b>	370743	<b>Vergl.-Nr.</b>	3014720 3014721
<b>Beschreibung</b>	Magnetventil 2-fach gerade 230VAC Eingang 3/4" Ausgang 11,5mm DN10 T.max. 70°C MÜLLER Kunststoff Reduzierung Ausgang B rosa		
<b>Für Modelle:</b>	04WCP1EM, 06WCP1GM, 08WCP1GM, 091CP1E, 091CP1G, 0G1CP1EC, 0G1CP1E-VERS.2004, 0G1CP1G-VERS.2004, 191CP1G, 191CP2G, 1G1CP1G-VERS.2004, 1G1CP2G-VERS.2004, 6040090, 6040310, 6043850, 6043980		









RPE			
			
1			
<b>GEV-Nr.</b>	374017	<b>Vergl.-Nr.</b>	33D3260
<b>Beschreibung</b>	Magnetventil 1-fach gerade 230VAC Eingang 3/4" Ausgang 10mm Eingang 6l/min DN10 RPE Polyamid Reduzierung Eingang weiß Membrane NBR Druckbereich 0,2-10bar		
<b>Für Modelle:</b>	KD37, KD37PS, KD37-VERS.112009, KD40, KD40PS, KD40-VERS.112009, KD60, KD60E, KD60EAT, KD60M, KD60MA, KD60ME, KD60MPS, KD60MPSA, KD60PS, KD60PSD, KD6EATSD, KD85E, KD85EA, KD85EAT, KD85EATS, KD85EPS, KD85EPSA, KN35, KN37, KN37PS, KN40, KN40PS, KN40PSD, KN50, KN50M, KN50MPS, KN50PS, KN50PSD, KN50PSDD, KN80, KN80PS, LC100, LC100-VERS.2001, LC130, LC130-VERS.2001, LC80, LF50, LF50E, LF50EM, LF50EMPS, LF50EM-VERS.122012, LF50E-VERS.122012, LF50E-VERS.2007, LP202... (Weitere Modelle finden Sie in unserem Webshop)		

			
1			
<b>GEV-Nr.</b>	374015	<b>Vergl.-Nr.</b>	33D3280
<b>Beschreibung</b>	Magnetventil 1-fach gewinkelt 230VAC Eingang 3/4" Ausgang 10mm Eingang 10-12l/min DN10 RPE Reduzierung Eingang weiß		
<b>Für Modelle:</b>	KD100, KD100A, KD100PSD, KD130, KD130A, KD130E, KD130EAT, KD85, KD85A, KD85PS, KD85PSA, KN1100, KN1100SD, KN11PSDD, KN800, KN800PSD, LP151		



TP			
			
1			
<b>GEV-Nr.</b>	370021	<b>Vergl.-Nr.</b>	33D1640 33D1641 33D3250
<b>Beschreibung</b>	Magnetventil 2-fach gerade 230VAC Eingang 3/4" Ausgang 11,5mm DN10 TP Reduzierung Eingang weiß		
<b>Für Modelle:</b>	FC101, FC101E, FC241, FC241E, FC241G, FC61, FC61E, FCV101, FCV101DM, FCV101DS, FCV101E, FCV101EDM, FCV101EDS, FCV141, FCV141DM, FCV141DS, FCV141E, FCV141EDM, FCV141EDS, FCV241, FCV241DM, FCV241DS, FCV241E, FCV241EDM, FCV241EDS, FCV241G, FCV241GDM, FCV241GDS, FCV3EM, FCV401DM, FCV401EDM, FCV4E, FCV4EDS, FCV4EM, FCV61, FCV61DM, FCV61DS, FCV61E, FCV61EDM, FCV61EDS, FM423E1, KD37, KD37PS, KD37-VERS.112009, KD40, KD40EPSD, KD40LEPS, KD40LSPS, KD40LUX, KD40LUXE...(Weitere Modelle finden Sie in unserem Webshop)		
<b>Ersatzteile für</b>	370021		
	<b>GEV-Nr.</b>	371013	<b>Vergl.-Nr.</b> —
Magnetspule TP 230VAC 50/60Hz			
<b>Zubehör für</b>	370021		
	<b>GEV-Nr.</b>	371220	<b>Vergl.-Nr.</b> —
Reduzierung TP Durchflussrate 3l/min rot Toleranz ±15%			
	<b>GEV-Nr.</b>	371221	<b>Vergl.-Nr.</b> —
Reduzierung TP Durchflussrate 5.5l/min gelb Toleranz ±15%			
	<b>GEV-Nr.</b>	371222	<b>Vergl.-Nr.</b> —
Reduzierung TP Durchflussrate 6l/min grau Toleranz ±15%			
	<b>GEV-Nr.</b>	371223	<b>Vergl.-Nr.</b> —
Reduzierung TP Durchflussrate 10l/min weiß Toleranz ±15%			
	<b>GEV-Nr.</b>	371224	<b>Vergl.-Nr.</b> —
Reduzierung TP Durchflussrate 12l/min Bronze Toleranz ±15%			
	<b>GEV-Nr.</b>	371225	<b>Vergl.-Nr.</b> —
Reduzierung TP Durchflussrate 16l/min hellbraun Toleranz ±15%			
	<b>GEV-Nr.</b>	371226	<b>Vergl.-Nr.</b> —
Reduzierung TP Durchflussrate 20l/min rot Toleranz ±15%			
	<b>GEV-Nr.</b>	371230	<b>Vergl.-Nr.</b> —
Reduzierung TP Durchflussrate 0.25l/min rot Toleranz ±25%			
	<b>GEV-Nr.</b>	371231	<b>Vergl.-Nr.</b> —
Reduzierung TP Durchflussrate 0.35l/min violett Toleranz ±25%			
	<b>GEV-Nr.</b>	371232	<b>Vergl.-Nr.</b> —
Reduzierung TP Durchflussrate 0.5l/min orange Toleranz ±25%			
	<b>GEV-Nr.</b>	371233	<b>Vergl.-Nr.</b> —
Reduzierung TP Durchflussrate 0.8l/min weiß Toleranz ±25%			
	<b>GEV-Nr.</b>	371234	<b>Vergl.-Nr.</b> —
Reduzierung TP Durchflussrate 11l/min hellblau Toleranz ±25%			





Zubehör für 370021			
	<b>GEV-Nr.</b>	371235	<b>Vergl.-Nr.</b> —
Reduzierung TP Durchflussrate 1.2l/min braun Toleranz ±25%			
	<b>GEV-Nr.</b>	371236	<b>Vergl.-Nr.</b> —
Reduzierung TP Durchflussrate 1.5l/min hellbraun Toleranz ±25%			
	<b>GEV-Nr.</b>	371237	<b>Vergl.-Nr.</b> —
Reduzierung TP Durchflussrate 2.5l/min gelb Toleranz ±25%			
	<b>GEV-Nr.</b>	371238	<b>Vergl.-Nr.</b> —
Reduzierung TP Durchflussrate 3.4l/min dunkelgrün Toleranz ±25%			
	<b>GEV-Nr.</b>	371239	<b>Vergl.-Nr.</b> —
Reduzierung TP Durchflussrate 5l/min schwarz Toleranz ±25%			
	<b>GEV-Nr.</b>	371240	<b>Vergl.-Nr.</b> —
Reduzierung TP Durchflussrate 8l/min blau Toleranz ±20%			















TP			
			
1			
<b>GEV-Nr.</b>	370015	<b>Vergl.-Nr.</b>	33D1370 33D1371
<b>Beschreibung</b>	Magnetventil 1-fach gewinkelt 230VAC Eingang 3/4" Ausgang 11,5mm DN10 TP		
<b>Für Modelle:</b>	04WBMEV, 08WGREV, 090BM1E, 090BM1G, 190BM2E, 190BM2G, 190GRE, 191BR1E, 191BR1G, 191BR1GA, 191BR2E, 191BR2EA, 191BR2G, 191BR2GA, 1GOGRE, 291BR1E, 291BR1G, 291BR1GA, 291BR2E, 291BR2EA, 291BR2G, 291BR2GA, 6040110, 6042680, AF1B, AF1B-OPR01, AF1N, AF1N-OPR01, AF2B, AF2B-OPR01, AF2N, AF2N-OPR01, F60P, F60PR, F60T, F80P, F80PR, FM1011E3, FM1011G3, FM1221E3, FM1221G3, FM611E3, FM611G3, FM721E3, FM721G3, L100, L40, L40S, L45, L60...(Weitere Modelle finden Sie in unserem Webshop)		
<b>Zubehör für</b>	370015		
	<b>GEV-Nr.</b>	371220	<b>Vergl.-Nr.</b> —
Reduzierung TP Durchflussrate 3l/min rot Toleranz ±15%			
	<b>GEV-Nr.</b>	371221	<b>Vergl.-Nr.</b> —
Reduzierung TP Durchflussrate 5.5l/min gelb Toleranz ±15%			
	<b>GEV-Nr.</b>	371222	<b>Vergl.-Nr.</b> —
Reduzierung TP Durchflussrate 6l/min grau Toleranz ±15%			
	<b>GEV-Nr.</b>	371223	<b>Vergl.-Nr.</b> —
Reduzierung TP Durchflussrate 10l/min weiß Toleranz ±15%			
	<b>GEV-Nr.</b>	371224	<b>Vergl.-Nr.</b> —
Reduzierung TP Durchflussrate 12l/min Bronze Toleranz ±15%			
	<b>GEV-Nr.</b>	371225	<b>Vergl.-Nr.</b> —
Reduzierung TP Durchflussrate 16l/min hellbraun Toleranz ±15%			
	<b>GEV-Nr.</b>	371226	<b>Vergl.-Nr.</b> —
Reduzierung TP Durchflussrate 20l/min rot Toleranz ±15%			

Tabellenfortsetzung auf der nächsten Seite



Zubehör für		370015	
	GEV-Nr.	371230	Vergl.-Nr. —
Reduzierung TP Durchflussrate 0.25l/min rot Toleranz ±25%			
	GEV-Nr.	371231	Vergl.-Nr. —
Reduzierung TP Durchflussrate 0.35l/min violett Toleranz ±25%			
	GEV-Nr.	371232	Vergl.-Nr. —
Reduzierung TP Durchflussrate 0.5l/min orange Toleranz ±25%			
	GEV-Nr.	371233	Vergl.-Nr. —
Reduzierung TP Durchflussrate 0.8l/min weiß Toleranz ±25%			
	GEV-Nr.	371234	Vergl.-Nr. —
Reduzierung TP Durchflussrate 1l/min hellblau Toleranz ±25%			
	GEV-Nr.	371235	Vergl.-Nr. —
Reduzierung TP Durchflussrate 1.2l/min braun Toleranz ±25%			
	GEV-Nr.	371236	Vergl.-Nr. —
Reduzierung TP Durchflussrate 1.5l/min hellbraun Toleranz ±25%			
	GEV-Nr.	371237	Vergl.-Nr. —
Reduzierung TP Durchflussrate 2.5l/min gelb Toleranz ±25%			
	GEV-Nr.	371238	Vergl.-Nr. —
Reduzierung TP Durchflussrate 3.4l/min dunkelgrün Toleranz ±25%			
	GEV-Nr.	371239	Vergl.-Nr. —
Reduzierung TP Durchflussrate 5l/min schwarz Toleranz ±25%			
	GEV-Nr.	371240	Vergl.-Nr. —
Reduzierung TP Durchflussrate 8l/min blau Toleranz ±20%			

 <p>1</p>			
<b>GEV-Nr.</b>	370019	<b>Vergl.-Nr.</b>	33D0290
<b>Beschreibung</b>	Magnetventil 2-fach gewinkelt 230VAC Eingang 3/4" Ausgang 11,5mm DN10 TP Kunststoff		
<b>Für Modelle:</b>	LT25F		
<b>Ersatzteile für</b>	370019		
	GEV-Nr.	371013	Vergl.-Nr. —
Magnetspule TP 230VAC 50/60Hz			
<b>Zubehör für</b>	370019		
	GEV-Nr.	371220	Vergl.-Nr. —
Reduzierung TP Durchflussrate 3l/min rot Toleranz ±15%			
	GEV-Nr.	371221	Vergl.-Nr. —
Reduzierung TP Durchflussrate 5.5l/min gelb Toleranz ±15%			
	GEV-Nr.	371222	Vergl.-Nr. —
Reduzierung TP Durchflussrate 6l/min grau Toleranz ±15%			

Zubehör für		370019	
	GEV-Nr.	371223	Vergl.-Nr. —
Reduzierung TP Durchflussrate 10l/min weiß Toleranz ±15%			
	GEV-Nr.	371224	Vergl.-Nr. —
Reduzierung TP Durchflussrate 12l/min Bronze Toleranz ±15%			
	GEV-Nr.	371225	Vergl.-Nr. —
Reduzierung TP Durchflussrate 16l/min hellbraun Toleranz ±15%			
	GEV-Nr.	371226	Vergl.-Nr. —
Reduzierung TP Durchflussrate 20l/min rot Toleranz ±15%			
	GEV-Nr.	371230	Vergl.-Nr. —
Reduzierung TP Durchflussrate 0.25l/min rot Toleranz ±25%			
	GEV-Nr.	371231	Vergl.-Nr. —
Reduzierung TP Durchflussrate 0.35l/min violett Toleranz ±25%			
	GEV-Nr.	371232	Vergl.-Nr. —
Reduzierung TP Durchflussrate 0.5l/min orange Toleranz ±25%			
	GEV-Nr.	371233	Vergl.-Nr. —
Reduzierung TP Durchflussrate 0.8l/min weiß Toleranz ±25%			
	GEV-Nr.	371234	Vergl.-Nr. —
Reduzierung TP Durchflussrate 1l/min hellblau Toleranz ±25%			
	GEV-Nr.	371235	Vergl.-Nr. —
Reduzierung TP Durchflussrate 1.2l/min braun Toleranz ±25%			
	GEV-Nr.	371236	Vergl.-Nr. —
Reduzierung TP Durchflussrate 1.5l/min hellbraun Toleranz ±25%			
	GEV-Nr.	371237	Vergl.-Nr. —
Reduzierung TP Durchflussrate 2.5l/min gelb Toleranz ±25%			
	GEV-Nr.	371238	Vergl.-Nr. —
Reduzierung TP Durchflussrate 3.4l/min dunkelgrün Toleranz ±25%			
	GEV-Nr.	371239	Vergl.-Nr. —
Reduzierung TP Durchflussrate 5l/min schwarz Toleranz ±25%			
	GEV-Nr.	371240	Vergl.-Nr. —
Reduzierung TP Durchflussrate 8l/min blau Toleranz ±20%			



Magnetventile mit Reduzierung



<b>1</b>			
<b>GEV-Nr.</b>	370648	<b>Vergl.-Nr.</b>	3032670
<b>Beschreibung</b>	Magnetventil 2-fach gerade 220-240VAC Eingang 3/4" Eingang 10l/min DN10 TP Ausgang 11.5mm Ausgang A 3.4l/min Reduzierung Ausgang A grün		
<b>Für Modelle:</b>	10CP1EA, 10CP1GA, 10CP1IA, 12CP1EA, 12CP1GA, 12CP1IA, 18CP2EA, 18CP2GA, 18CP2IA, FC1011E, FC1011G, FC1221E, FC1221G, FC611E, FC611G, FM1011E2-VERS.2006, FM1011E3, FM1011E3-VERS.2006, FM1011G2-VERS.2006, FM1011G3, FM1011G3-VERS.2006, FM1221E2-VERS.2006, FM1221E3, FM1221E3-VERS.2006, FM1221G2-VERS.2006, FM1221G3, FM1221G3-VERS.2006, FM2011E2-VERS.2006, FM2011E3-VERS.2006, FM2011G2-VERS.2006, FM2011G3-VERS.2006, FM2021E1, FM2021E2, FM2021E2-VERS.2006, FM2021E3, FM2021E3-VERS.2006, FM2021G1, FM2021G2, FM2021G2-VERS.2006, FM2021G3, FM2021G3-VERS.2006, FM423E2, FM611E2-VERS.2006, FM611E3, FM611E3-VERS.2006, FM611G2-VERS.2006, FM611G3, FM611G3-VERS.2006, FM721E1-VERS.2006, FM721E2-VERS.2006...(Weitere Modelle finden Sie in unserem Webshop)		

Metall

ASCO

Ersatzteile und Zubehör

Steckdosen



<b>1</b>			
<b>GEV-Nr.</b>	371093	<b>Vergl.-Nr.</b>	32A2330
<b>Beschreibung</b>	Steckdose Steckertyp kompakt Kabellänge 1100mm klein		
<b>Für Modelle:</b>	0A1FR1G, 0A1FR1GD, 0A1FR1GD-VERS.2004, 0A1FR1G-VERS.2004, 0B1FR1G, 0B1FR1GD, 0D1FR1G, 0D1FR1GD, 0D1FR1GD-VERS.2004, 0D1FR1G-VERS.2004, 1A1BR1G, 1A1BR1GA, 1A1BR2G, 1A1BR2GA, 1A1FR2G, 1A1FR2GD, 1A1FR2GD-VERS.2004, 1A1FR2G-VERS.2004, 1D1BR1G, 1D1BR1GA, 1D1BR2G, 1D1BR2GA, 1D1FR2G, 1D1FR2GD, 1D1FR2GD-VERS.2004, 1D1FR2G-VERS.2004, 2A1BR1G, 2A1BR1GA, 2A1BR2G, 2A1BR2GA, 2D1BR1G, 2D1BR1GA, 2D1BR2G, 2D1BR2GA		

für Kombidämpfer



<b>1</b>			
<b>GEV-Nr.</b>	541806	<b>Vergl.-Nr.</b>	3041830 32Z5870 32Z5871 32Z5872
<b>Beschreibung</b>	Pressostat ø 38mm Druckbereich 0,2-3,0bar Anschluss 1/8" 250V 10A GP600 Druckanschluss 1/8"		
<b>Für Modelle:</b>	BX101E, BX101E-VERS.122013, BX101G, BX101G-VERS.122013, BX122E, BX122E-VERS.122013, BX122G, BX122G-VERS.122013, BX61E, BX61E-VERS.122013, BX61G, BX61G-VERS.122013, BX82E, BX82E-VERS.122013, BX82G, BX82G-VERS.122013, FCV101, FCV101-CSA, FCV101DM, FCV101DM-CSA, FCV101DS, FCV101DS-CSA, FCV101E, FCV101EDM, FCV101EDM-UL, FCV101EDS, FCV101EDS-UL, FCV101E-UL, FCV141, FCV141-CSA, FCV141DM, FCV141DM-CSA, FCV141DS, FCV141DS-CSA, FCV141E, FCV141EDM, FCV141EDS, FCV241, FCV241DM, FCV241DS, FCV241E, FCV241EDM, FCV241EDM-UL, FCV241EDS, FCV241EDS-UL, FCV241E-UL, FCV241G, FCV241G-CSA, FCV241GDM, FCV241GDM-CSA...(Weitere Modelle finden Sie in unserem Webshop)		
<b>Zubehör für</b>	541806		
	<b>GEV-Nr.</b>	541814	<b>Vergl.-Nr.</b>
			—
	Schutzkappe für Pressostat EPDM XP600		



<b>1</b>			
<b>GEV-Nr.</b>	541575	<b>Vergl.-Nr.</b>	3004460 3004461
<b>Beschreibung</b>	Pressostat ø 45.5mm Druckbereich 200/100mbar 1CO Druckanschluss vertikal MEC Anschluss Flachstecker 6,3mm passend für ANGELO PO 250V p max 1bar 6A Druckanschluss 1/8"		
<b>Für Modelle:</b>	FM1011E3, FM1011E3-VERS.2006, FM1011G3, FM1011G3-VERS.2006, FM1221E3, FM1221E3-VERS.2006, FM1221G3, FM1221G3-VERS.2006, FM2011E3-VERS.2006, FM2011G3-VERS.2006, FM2021E3, FM2021E3-VERS.2006, FM2021G3, FM2021G3-VERS.2006, FM611E3, FM611E3-VERS.2006, FM611G3, FM611G3-VERS.2006, FM721E3, FM721E3-VERS.2006, FM721G3, FM721G3-VERS.2006		

Pressostate

für Spültechnik



<b>1</b>			
<b>GEV-Nr.</b>	541199	<b>Vergl.-Nr.</b>	6300569
<b>Beschreibung</b>	Pressostat Druckbereich 0,2-3,0mbar ø 74mm Druckanschluss ø 6.3mm		
<b>Für Modelle:</b>	FC1011G, FC1221G, FC611G, FM1011G1, FM1011G1-VERS.2006, FM1011G2, FM1011G2-VERS.2006, FM1011G3, FM1011G3-VERS.2006, FM1221G1, FM1221G1-VERS.2006, FM1221G2, FM1221G2-VERS.2006, FM1221G3, FM1221G3-VERS.2006, FM2011G2-VERS.2006, FM2011G3-VERS.2006, FM2021G1, FM2021G2, FM2021G2-VERS.2006, FM2021G3, FM2021G3-VERS.2006, FM611G1, FM611G1-VERS.2006, FM611G2, FM611G2-VERS.2006, FM611G3, FM611G3-VERS.2006, FM721G1, FM721G1-VERS.2006, FM721G2, FM721G2-VERS.2006, FM721G3, FM721G3-VERS.2006		



# Lüfter

## Axiallüfter

### ebm-papst

ebmpapst



<b>GEV-Nr.</b>	601082 <sup>1</sup>	<b>Vergl.-Nr.</b>	3076620
<b>Beschreibung</b>	Axiallüfter L 92mm B 92mm H 25mm 230VAC 50/60Hz 9/11W Lager Kugellager Hersteller-Nr. 3956 Metall Anschluss Flachstecker 2,8mm ebm-papst Lüfterrad ø 85mm Temp.Best. 80°C		
<b>Für Modelle:</b>	04WPBEV, 08WPBEV, 08WTPEV, 090PEB, 091FR1EX, 091FR1IA, 091FR7G, 091FR7GS, 091FR7GX, 190PEB, 190TPE, 6BM, 6BR, 6CP, 6FR, 6FTL, 6FTR, 6PC, 6VTR, 6VTR2		
<b>Zubehör für</b>	601082		
	<b>GEV-Nr.</b>	691103	<b>Vergl.-Nr.</b> —
	Schutzgitter ø 90mm BA 83mm für Axiallüfter 92mm		

<sup>1</sup>mit Kugellager

### Import



<b>GEV-Nr.</b>	601604 <sup>1</sup>	<b>Vergl.-Nr.</b>	32M7130 32V5790
<b>Beschreibung</b>	Axiallüfter L 119mm B 119mm H 38mm 230VAC 50/60Hz 17/15W Lager Gleitlager Hersteller-Nr. AA1282HS-AT Anschluss Kabel 300mm Lüfterrad ø 110mm Temp.Best. 70°C Stromaufnahme 0.1A Leistung 130m³/h 2600U/min		
<b>Für Modelle:</b>	191FR4ED, BX61E, BX61E-VERS.122013, BX61G, BX61G-VERS.122013, FC1011E, FC1011G, FC1221E, FC1221G, FC611E, FC611G, FM1011E1, FM1011E1-VERS.2006, FM1011E2, FM1011E2-VERS.2006, FM1011E3, FM1011E3-VERS.2006, FM1011G1, FM1011G1-VERS.2006, FM1011G2, FM1011G2-VERS.2006, FM1011G3, FM1011G3-VERS.2006, FM1221E1, FM1221E1-VERS.2006, FM1221E2, FM1221E2-VERS.2006, FM1221E3, FM1221E3-VERS.2006, FM1221G1, FM1221G1-VERS.2006, FM1221G2, FM1221G2-VERS.2006, FM1221G3, FM1221G3-VERS.2006, FM611E1, FM611E1-VERS.2006, FM611E2, FM611E2-VERS.2006, FM611E3, FM611E3-VERS.2006, FM611G1, FM611G1-VERS.2006, FM611G2, FM611G2-VERS.2006, FM611G3, FM611G3-VERS.2006, FM721E1, FM721E1-VERS.2006, FM721E2... (Weitere Modelle finden Sie in unserem Webshop)		

<sup>1</sup>mit Gleitlager



<b>GEV-Nr.</b>	601055 <sup>1</sup>	<b>Vergl.-Nr.</b>	3113740 3205930
<b>Beschreibung</b>	Axiallüfter L 92mm B 92mm H 25mm 230VAC 50/60Hz 14,5/14W Lager Kugellager Anschluss Flachstecker 2,8mm Metall ADDA Lüfterrad ø 85mm Temp.Best. 70°C		
<b>Für Modelle:</b>	08WPBEV, 08WTPEV, 090PEB, 091FR1I, 091FR1ID, 091PEB, 10CP1EA, 10CP1IA, 12CP1EA, 12CP1IA, 18CP2EA, 18CP2IA, 190PEB, 190TPE, 191FR2I, 191FR2ID, 191PEB, 191TPE, 2091SCP, FX101E1, FX101E1R, FX101E2, FX101E2C, FX101E2C-VERS.032014, FX101E2R, FX101E2R-VERS.032014, FX101E2-VERS.032014, FX101E3, FX101E3C, FX101E3C-VERS.022014, FX101E3R, FX101E3R-VERS.022014, FX101E3-VERS.022014, FX101G1, FX101G1R, FX101G2, FX101G2C, FX101G2C-VERS.032014, FX101G2R, FX101G2R-VERS.032014, FX101G2-VERS.032014, FX101G3, FX101G3C, FX101G3C-VERS.022014, FX101G3R, FX101G3R-VERS.022014, FX101G3-VERS.022014, FX10E2CR, FX10E2CR-VERS.032014, FX10E3CR... (Weitere Modelle finden Sie in unserem Webshop)		
<b>Zubehör für</b>	601055		
	<b>GEV-Nr.</b>	550898	<b>Vergl.-Nr.</b> —
	Anschlusskabel Kabellänge 2000mm Anschluss F 2,8 Anschlussabstand 7,9mm für Axiallüfter		
	<b>GEV-Nr.</b>	691103	<b>Vergl.-Nr.</b> —
	Schutzgitter ø 90mm BA 83mm für Axiallüfter 92mm		

<sup>1</sup>mit Kugellager

## Heißluftmotoren





<b>GEV-Nr.</b>	550686	<b>Vergl.-Nr.</b>	37Q0250
<b>Beschreibung</b>	Dichtung für Lüftermotor ID ø 12mm AD ø 58mm Materialstärke 1mm mit 3 Schraublöchern		
<b>Für Modelle:</b>	BX101E, BX101E-VERS.122013, BX101G, BX101G-VERS.122013, BX122E, BX122E-VERS.122013, BX122G, BX122G-VERS.122013, BX61E, BX61E-VERS.122013, BX61G, BX61G-VERS.122013, BX82E, BX82E-VERS.122013, BX82G, BX82G-VERS.122013, FC1011E, FC1011G, FC1221E, FC1221G, FC611E, FC611G, FCV3EM, FCV4E, FCV4EDS, FCV4EM, FM1011E1, FM1011E1-VERS.2006, FM1011E2, FM1011E2-VERS.2006, FM1011E3, FM1011E3-VERS.2006, FM1011G1, FM1011G1-VERS.2006, FM1011G2, FM1011G2-VERS.2006, FM1011G3, FM1011G3-VERS.2006, FM1221E1, FM1221E1-VERS.2006, FM1221E2, FM1221E2-VERS.2006, FM1221E3, FM1221E3-VERS.2006, FM1221G1, FM1221G1-VERS.2006, FM1221G2, FM1221G2-VERS.2006, FM1221G3, FM1221G3-VERS.2006... (Weitere Modelle finden Sie in unserem Webshop)		





			
1			
<b>GEV-Nr.</b>	550689	<b>Vergl.-Nr.</b>	37Q3011
<b>Beschreibung</b>	Dichtung für Lüftermotor ID $\varnothing$ 40mm AD $\varnothing$ 58mm Materialstärke 1mm mit 3 Schraublöchern		
<b>Für Modelle:</b>	FC101, FC101E, FC241, FC241E, FC241G, FC61, FC61E, FCV101, FCV101-CSA, FCV101DM, FCV101DM-CSA, FCV101DS, FCV101DS-CSA, FCV101E, FCV101EDM, FCV101EDM-UL, FCV101EDS, FCV101EDS-UL, FCV101E-UL, FCV141, FCV141-CSA, FCV141DM, FCV141DM-CSA, FCV141DS, FCV141DS-CSA, FCV141E, FCV141EDM, FCV141EDS, FCV241, FCV241DM, FCV241DS, FCV241E, FCV241EDM, FCV241EDM-UL, FCV241EDS, FCV241EDS-UL, FCV241E-UL, FCV241G, FCV241G-CSA, FCV241GDM, FCV241GDM-CSA, FCV241GDS, FCV241GDS-CSA, FCV3EM, FCV401DM, FCV401DM-CSA, FCV401EDM, FCV401EDM-UL, FCV4E, FCV4EDS...(Weitere Modelle finden Sie in unserem Webshop)		

			
1			
<b>GEV-Nr.</b>	697866	<b>Vergl.-Nr.</b>	33Q5690
<b>Beschreibung</b>	Flansch für Lüftermotor AD $\varnothing$ 58mm Innen- $\varnothing$ 1 38.8mm Innen- $\varnothing$ 2 19/23mm Messing		
<b>Für Modelle:</b>	FC101, FC101E, FC241, FC241E, FC241G, FC61, FC61E, FCV101, FCV101-CSA, FCV101DM, FCV101DM-CSA, FCV101DS, FCV101DS-CSA, FCV101E, FCV101EDM, FCV101EDM-UL, FCV101EDS, FCV101EDS-UL, FCV101E-UL, FCV141, FCV141-CSA, FCV141DM, FCV141DM-CSA, FCV141DS, FCV141DS-CSA, FCV141E, FCV141EDM, FCV141EDS, FCV241, FCV241DM, FCV241DS, FCV241E, FCV241EDM, FCV241EDM-UL, FCV241EDS, FCV241EDS-UL, FCV241E-UL, FCV241G, FCV241G-CSA, FCV241GDM, FCV241GDM-CSA, FCV241GDS, FCV241GDS-CSA, FCV401DM, FCV401DM-CSA, FCV401EDM, FCV401EDM-UL, FCV61, FCV61-CSA, FCV61DM...(Weitere Modelle finden Sie in unserem Webshop)		

			
1			
<b>GEV-Nr.</b>	550687	<b>Vergl.-Nr.</b>	33Q6320
<b>Beschreibung</b>	Flansch für Lüftermotor		
<b>Für Modelle:</b>	FCV3EM, FCV4E, FCV4EDS, FCV4EM		

			
1			
<b>GEV-Nr.</b>	550688	<b>Vergl.-Nr.</b>	3151490 3151490
<b>Beschreibung</b>	Lagerbuchse für Lüftermotor		
<b>Für Modelle:</b>	FC101, FC101E, FC241, FC241E, FC241G, FC61, FC61E, FCV101, FCV101-CSA, FCV101DM, FCV101DM-CSA, FCV101DS, FCV101DS-CSA, FCV101E, FCV101EDM, FCV101EDM-UL, FCV101EDS, FCV101EDS-UL, FCV101E-UL, FCV141, FCV141-CSA, FCV141DM, FCV141DM-CSA, FCV141DS, FCV141DS-CSA, FCV141E, FCV141EDM, FCV141EDS, FCV241, FCV241DM, FCV241DS, FCV241E, FCV241EDM, FCV241EDM-UL, FCV241EDS, FCV241EDS-UL, FCV241E-UL, FCV241G, FCV241G-CSA, FCV241GDM, FCV241GDM-CSA, FCV241GDS, FCV241GDS-CSA, FCV401DM, FCV401DM-CSA, FCV401EDM, FCV401EDM-UL, FCV61, FCV61-CSA, FCV61DM...(Weitere Modelle finden Sie in unserem Webshop)		

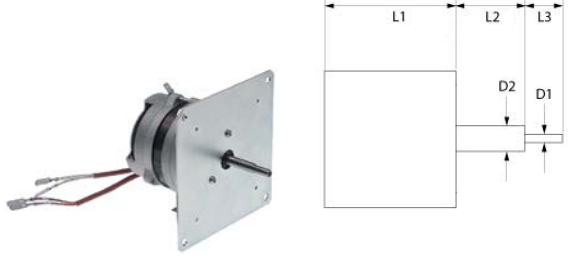
			
1			
<b>GEV-Nr.</b>	552005	<b>Vergl.-Nr.</b>	36E3160
<b>Beschreibung</b>	Flansch für Lüftermotor AD $\varnothing$ 56mm Innen- $\varnothing$ 1 38mm Innen- $\varnothing$ 2 20mm Materialstärke 8mm Messing		
<b>Für Modelle:</b>	BX101E, BX101E-VERS.122013, BX101G, BX101G-VERS.122013, BX122E, BX122E-VERS.122013, BX122G, BX122G-VERS.122013, BX61E, BX61E-VERS.122013, BX61G, BX61G-VERS.122013, BX82E, BX82E-VERS.122013, BX82G, BX82G-VERS.122013, FC1011E, FC1011G, FC1221E, FC1221G, FC611E, FC611G, FM1011E1, FM1011E1-VERS.2006, FM1011E2, FM1011E2-VERS.2006, FM1011E3, FM1011E3-VERS.2006, FM1011G1, FM1011G1-VERS.2006, FM1011G2, FM1011G2-VERS.2006, FM1011G3, FM1011G3-VERS.2006, FM1221E1, FM1221E1-VERS.2006, FM1221E2, FM1221E2-VERS.2006, FM1221E3, FM1221E3-VERS.2006, FM1221G1, FM1221G1-VERS.2006, FM1221G2, FM1221G2-VERS.2006, FM1221G3, FM1221G3-VERS.2006, FM2011E2-VERS.2006, FM2011E3-VERS.2006, FM2011G2-VERS.2006, FM2011G3-VERS.2006...(Weitere Modelle finden Sie in unserem Webshop)		

			
1			
<b>GEV-Nr.</b>	601104	<b>Vergl.-Nr.</b>	32M4301
<b>Beschreibung</b>	Lüftermotor 220-240V Phasen 1 50/60Hz 0,045/0,0765kW 2800/3400U/min Geschw. 1 L1 97mm L2 41mm L3 19mm D1 $\varnothing$ 8mm D2 $\varnothing$ 10mm 0.35A passender Kondensator 2 $\mu$ F/400V Leistungsaufnahme 45W bei 50Hz 2800/3400U/min		
<b>Für Modelle:</b>	1G1FA0EV, 1G1FA0GV, 1G1PE1EV, 1G1PE2EV, 2G1FA0GV, 2G1PE1EV, 2G1PE2EV, 31GE, 31TC, 31TCE, 32TC, 32TCE		
<b>Zubehör für</b>	601104		
		<b>GEV-Nr.</b>	365170
		<b>Vergl.-Nr.</b>	—
	Kondensator Kapazität 2 $\mu$ F 425V Becherkondensator Toleranz 5% 50/60Hz Umgebungstemperatur max. -25 bis + 85°C $\varnothing$ 25mm L 49mm M8 Kunststoff Anschluss Kabel 250mm 416.17.74 Schutzart		

			
1			
<b>GEV-Nr.</b>	552006	<b>Vergl.-Nr.</b>	33Q5381
<b>Beschreibung</b>	Flansch für Lüftermotor AD $\varnothing$ 57.5mm Innen- $\varnothing$ 1 35mm Innen- $\varnothing$ 2 23mm Materialstärke 2mm		
<b>Für Modelle:</b>	FC101, FC101E, FC241, FC241E, FC241G, FC61, FC61E, FCV101, FCV101-CSA, FCV101DM, FCV101DM-CSA, FCV101DS, FCV101DS-CSA, FCV101E, FCV101EDM, FCV101EDM-UL, FCV101EDS, FCV101EDS-UL, FCV101E-UL, FCV141, FCV141-CSA, FCV141DM, FCV141DM-CSA, FCV141DS, FCV141DS-CSA, FCV141E, FCV141EDM, FCV141EDS, FCV241, FCV241DM, FCV241DS, FCV241E, FCV241EDM, FCV241EDM-UL, FCV241EDS, FCV241EDS-UL, FCV241E-UL, FCV241G, FCV241G-CSA, FCV241GDM, FCV241GDM-CSA, FCV241GDS, FCV241GDS-CSA, FCV401DM, FCV401DM-CSA, FCV401EDM, FCV401EDM-UL, FCV61, FCV61-CSA, FCV61DM...(Weitere Modelle finden Sie in unserem Webshop)		

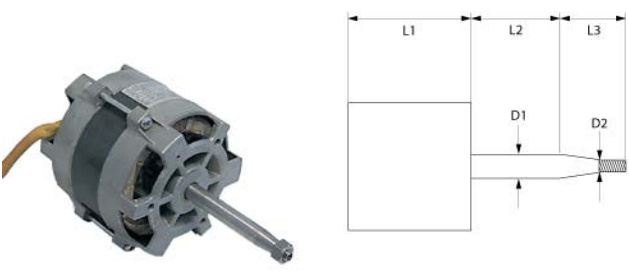
1

<b>GEV-Nr.</b>	601043	<b>Vergl.-Nr.</b>	32M1500	
<b>Beschreibung</b>	Lüftermotor 220-240V Phasen 1 50Hz 0,37/0,07kW 0,1/0,5PS 1400/2700U/min Geschw. 2 L1 123mm L2 107mm L3 15mm D1 ø 15mm D2 ø 12mm M10L AG 2/0,7A passender Kondensator 20µF/250V bei 50Hz 1400/2700U/min Typ 1057			
<b>Zubehör für</b>	601043			
				
	<b>GEV-Nr.</b>	365019	<b>Vergl.-Nr.</b>	—
	Betriebskondensator Kapazität 20µF 400V Becherkondensator Toleranz 5% 50/60Hz Umgebungstemperatur max. -25 bis + 85°C ø 39,5mm L 70mm Doppelanschluss M8 Kunststoff Anschluss Flachstecker 6,3mm 16.10.25. Schutzart			

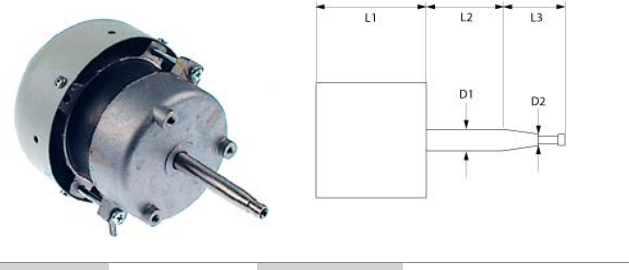

1

<b>GEV-Nr.</b>	601210	<b>Vergl.-Nr.</b>	32M4260
<b>Beschreibung</b>	Lüftermotor 220-240V Phasen 1 50Hz 0.075kW 2800U/min Geschw. 1 L1 120mm L2 38mm L3 36mm D1 ø 12mm D2 ø 8mm M5R IG 0.55A passender Kondensator 2,5µF/400V bei 50Hz 2800U/min Typ 1074		
<b>Für Modelle:</b>	FCV3EM, FCV4E, FCV4EDS, FCV4EM, FM423E1, FM423E2		

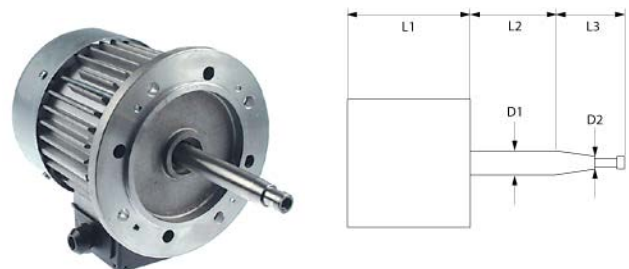

1

<b>GEV-Nr.</b>	601211	<b>Vergl.-Nr.</b>	32M3820
<b>Beschreibung</b>	Lüftermotor 230/400-415V Phasen 3 50/60Hz 0.25kW 1400/1600U/min Geschw. 1 L1 175mm L2 70mm L3 27mm D1 ø 17mm D2 ø 12mm M8R IG 1,4/0,8A bei 50Hz 1400U/min bei 60Hz 1600U/min Typ 1046.4530		
<b>Für Modelle:</b>	FC101, FC101E, FC241, FC241E, FC241G, FC61, FC61E, FCV101, FCV101DS, FCV101E, FCV101EDS, FCV141, FCV141DS, FCV141E, FCV141EDS, FCV241, FCV241DS, FCV241E, FCV241EDS, FCV241G, FCV241GDS, FCV61, FCV61DS, FCV61E, FCV61EDS		

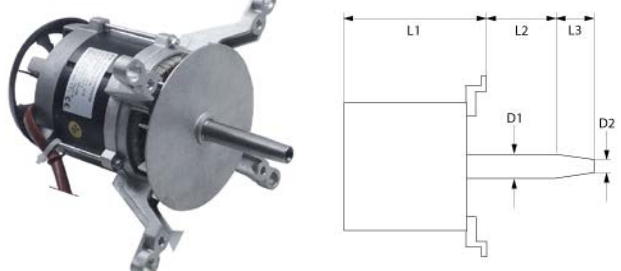

1

<b>GEV-Nr.</b>	601713	<b>Vergl.-Nr.</b>	32M6722
<b>Beschreibung</b>	Lüftermotor 230/400V Phasen 1 50/60Hz 0.55kW 0.75PS 1400U/min Geschw. 1 L1 200mm L2 53mm L3 32mm D1 ø 18mm D2 ø 15mm M10x1 passender Kondensator 31,5µF Cos(phi) 0.72 bei 50Hz 1400U/min bei 60Hz 1700U/min Typ 3065A4051		
<b>Für Modelle:</b>	FC1011E, FC1011G, FC1221E, FC1221G, FC611E, FC611G, FM1011E1, FM1011E1-VERS.2006, FM1011E2, FM1011E2-VERS.2006, FM1011E3, FM1011G1, FM1011G1-VERS.2006, FM1011G2, FM1011G2-VERS.2006, FM1011G3, FM1221E1, FM1221E1-VERS.2006, FM1221E2, FM1221E2-VERS.2006, FM1221E3, FM1221G1, FM1221G2, FM1221G3, FM2011E2-VERS.2006, FM2011G2-VERS.2006, FM2021E1, FM2021E2, FM2021E2-VERS.2006, FM2021E3, FM2021G1, FM2021G2, FM2021G3, FM611E1, FM611E1-VERS.2006, FM611E2, FM611E2-VERS.2006, FM611E3, FM611G1, FM611G1-VERS.2006, FM611G2, FM611G2-VERS.2006, FM611G3, FM721E1, FM721E1-VERS.2006, FM721E2, FM721E2-VERS.2006, FM721E3, FM721G1, FM721G1-VERS.2006...(Weitere Modelle finden Sie in unserem Webshop)		



1

<b>GEV-Nr.</b>	602175	<b>Vergl.-Nr.</b>	3103750
<b>Beschreibung</b>	Lüftermotor 230/400V Phasen 3 50/60Hz 0.7kW 1400/1700U/min L1 150mm L2 80mm L3 32mm D1 ø 18mm D2 ø 15mm M8 passender Kondensator 3µF400V Typ 3042P4050		
<b>Für Modelle:</b>	BX101E, BX101E-VERS.122013, BX101G, BX101G-VERS.122013, BX61E, BX61E-VERS.122013, BX61G, BX61G-VERS.122013, BX82E, BX82E-VERS.122013, BX82G, BX82G-VERS.122013, FX101E1, FX101E1R, FX101E2, FX101E2C, FX101E2C-VERS.032014, FX101E2R, FX101E2R-VERS.032014, FX101E2-VERS.032014, FX101E3, FX101E3C, FX101E3C-VERS.022014, FX101E3R, FX101E3R-VERS.022014, FX101E3-VERS.022014, FX101G3, FX101G3C, FX101G3C-VERS.022014, FX101G3R, FX101G3R-VERS.022014, FX101G3-VERS.022014, FX10E2CR, FX10E2CR-VERS.032014, FX10E3CR, FX10E3CR-VERS.022014, FX10G3CR, FX10G3CR-VERS.022014, FX201E2, FX201E2P, FX201E2P-VERS.032014, FX201E2-VERS.032014, FX201E3, FX201E3P, FX201E3P-VERS.022014, FX201E3-VERS.022014, FX201G2P, FX201G2P-VERS.032014, FX201G3P, FX201G3-VERS.022014...(Weitere Modelle finden Sie in unserem Webshop)		

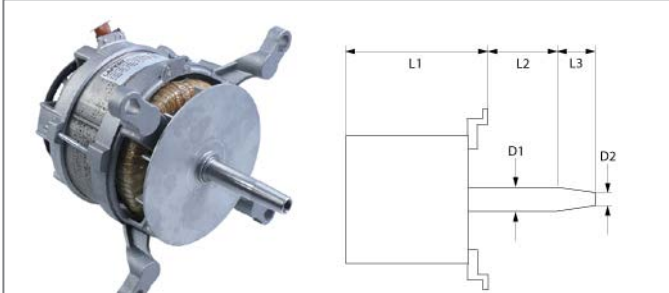

1

<b>GEV-Nr.</b>	601598	<b>Vergl.-Nr.</b>	3001182
<b>Beschreibung</b>	Lüftermotor 230V Phasen 1 50Hz 0,22/0,55kW 960/1430U/min Geschw. 2 L1 175mm L2 52mm L3 32mm D1 ø 15mm D2 ø 18mm M10R IG 1,7/3,7A passender Kondensator 36/25 Cos(φ) 0.96 bei 50Hz 960/1430U/min Typ LM/FB 100L		
<b>Für Modelle:</b>	FM1011G1, FM1011G2, FM1011G3, FM1011G3-VERS.2006, FM2011G3-VERS.2006, FM611G1, FM611G2, FM611G3, FM611G3-VERS.2006, FM721G1, FM721G2, FM721G3, FM721G3-VERS.2006		

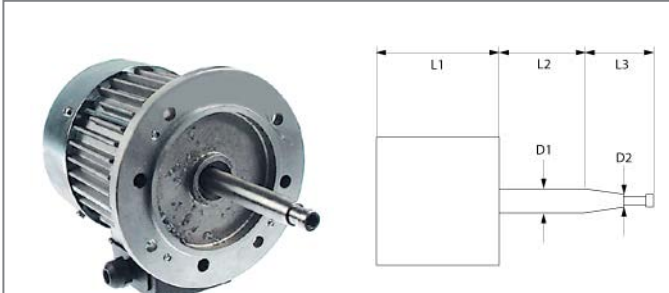

1

<b>GEV-Nr.</b>	601212	<b>Vergl.-Nr.</b>	32M3880
<b>Beschreibung</b>	Lüftermotor 380-400-415V Phasen 3 50Hz 0,04/0,33PS 700/1400U/min Geschw. 2 L1 180mm L2 70mm L3 27mm D1 ø 17mm D2 ø 12mm M8R IG 0,4/0,9A bei 50Hz 700/1400U/min Typ 1046/4-8		
<b>Für Modelle:</b>	FCV101DM, FCV101EDM, FCV141DM, FCV141EDM, FCV241DM, FCV241EDM, FCV241GDM, FCV401EDM, FCV61DM, FCV61EDM		

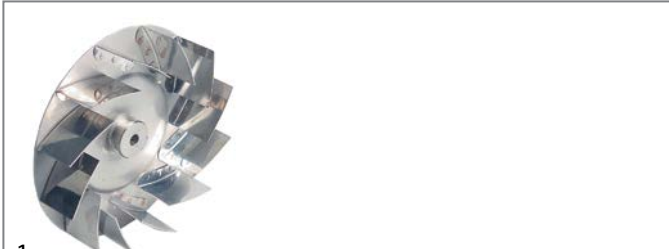

1

<b>GEV-Nr.</b>	601109	<b>Vergl.-Nr.</b>	32M0370
<b>Beschreibung</b>	Lüfterrad D1 ø 160mm H1 35mm Schaufeln 12 D2 ø 8mm D3 ø 8mm H2 15mm		
<b>Für Modelle:</b>	1G1FA0EV, 1G1FA0GV, 1G1PE1EV, 1G1PE2EV, 2G1FA0GV, 2G1PE1EV, 2G1PE2EV, 31GE, 31TC, 31TCE, 32TC, 32TCE		



1

<b>GEV-Nr.</b>	601221	<b>Vergl.-Nr.</b>	32M4270 32M4271
<b>Beschreibung</b>	Lüfterrad D1 ø 180mm H1 60mm Schaufeln 12 D2 ø 9mm D3 ø 12,5mm H2 35mm		
<b>Für Modelle:</b>	FCV3EM, FCV4E, FCV4EDS, FCV4EM, FM423E1, FM423E2		



1

<b>GEV-Nr.</b>	601060	<b>Vergl.-Nr.</b>	32M1570
<b>Beschreibung</b>	Lüfterrad D1 ø 180mm H1 60mm Schaufeln 16 D2 ø 11mm D3 ø 16mm H2 30mm		



1

<b>GEV-Nr.</b>	601207	<b>Vergl.-Nr.</b>	32M3811 32M3812
<b>Beschreibung</b>	Lüfterrad D1 ø 280mm H1 135mm Schaufeln 12 D2 ø 12mm D3 ø 18mm H2 55mm		
<b>Für Modelle:</b>	FC61, FC61E, FCV61, FCV61-CSA, FCV61DM, FCV61DM-CSA, FCV61DS, FCV61DS-CSA, FCV61E, FCV61EDM, FCV61EDM-UL, FCV61EDS, FCV61EDS-UL, FCV61E-UL		



1

<b>GEV-Nr.</b>	514449	<b>Vergl.-Nr.</b>	32M6741
<b>Beschreibung</b>	Lüfterrad D1 ø 283mm H1 140mm Schaufeln 8 D2 ø 15mm D3 ø 18mm		
<b>Für Modelle:</b>	FC611E, FC611G, FM611E1, FM611E1-VERS.2006, FM611E2, FM611E2-VERS.2006, FM611E3, FM611E3-VERS.2006, FM611G1, FM611G1-VERS.2006, FM611G2, FM611G2-VERS.2006, FM611G3, FM611G3-VERS.2006		



1

<b>GEV-Nr.</b>	602173	<b>Vergl.-Nr.</b>	32M6760 32M6761
<b>Beschreibung</b>	Lüfterrad Schaufeln 12 D1 ø 365mm D2 ø 14mm D3 ø 18mm H1 140mm H2 23mm		
<b>Für Modelle:</b>	FC1221E, FC1221G, FM1221E1, FM1221E1-VERS.2006, FM1221E2, FM1221E2-VERS.2006, FM1221E3, FM1221E3-VERS.2006, FM1221G1, FM1221G1-VERS.2006, FM1221G2, FM1221G2-VERS.2006, FM1221G3, FM1221G3-VERS.2006, FM2021E1, FM2021E2, FM2021E2-VERS.2006, FM2021E3, FM2021E3-VERS.2006, FM2021G1, FM2021G2, FM2021G2-VERS.2006, FM2021G3, FM2021G3-VERS.2006		



2

<b>GEV-Nr.</b>	601208	<b>Vergl.-Nr.</b>	32M2561
<b>Beschreibung</b>	Lüfterrad D1 ø 335mm H1 135mm Schaufeln 12 D2 ø 12mm D3 ø 18mm H2 56mm		
<b>Für Modelle:</b>	FC101, FC101E, FCV101, FCV101-CSA, FCV101DM, FCV101DM-CSA, FCV101DS, FCV101DS-CSA, FCV101E, FCV101EDM, FCV101EDM-UL, FCV101EDS, FCV101EDS-UL, FCV101E-UL, FCV141, FCV141-CSA, FCV141DM, FCV141DM-CSA, FCV141DS, FCV141DS-CSA, FCV141E, FCV141EDM, FCV141EDS, FCV72EDM-UL, FCV72EDS-UL, FCV72E-UL		



1

<b>GEV-Nr.</b>	601209	<b>Vergl.-Nr.</b>	32M3992
<b>Beschreibung</b>	Lüfterrad D1 ø 400mm H1 135mm Schaufeln 20 D2 ø 12mm D3 ø 18mm H2 54mm		
<b>Für Modelle:</b>	FC241E, FC241G, FCV241E, FCV241EDM, FCV241EDM-UL, FCV241EDS, FCV241EDS-UL, FCV241E-UL, FCV241G, FCV241G-CSA, FCV241GDM, FCV241GDM-CSA, FCV241GDS, FCV241GDS-CSA, FCV401EDM, FCV401EDM-UL		

## Heißluftventilatoren

### Weitere



1

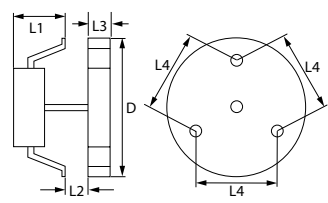

<b>GEV-Nr.</b>	601011	<b>Vergl.-Nr.</b>	32M0360 32M2320 32M2420 32M5690
<b>Beschreibung</b>	Heißluftventilator 220-240V 40W 50/60Hz L1 65mm L2 15mm L3 25mm L4 87mm Lüfterrad ø 150mm FIME Typ C25R8023CLH		
<b>Für Modelle:</b>	A12A1E, A12B1E, A12B2E, A12M1E, A12Z1E, A12Z2E, A14A1E, A14B1E, A14B2E, A14M1E, A14Z1E, A14Z2E, A16A1E, A16B1E, A16B2E, A16M1E, A16Z1E, A16Z2E, A18A1E, A18B1E, A18B2E, A18M1E, A18Z1E, A18Z2E, A20A1E, A20B1E, A20B2E, A20M1E, A20Z1E, A20Z2E, ACBM, ACBM218, ACPN, ACPN218, AJ12AE, AJ12ME, AJ14AE, AJ14ME, AJ16AE, AJ16ME, AJ18AE, AJ18ME, AJ20AE, AJ20ME, SL14CPN, SL14CVB, SL21CPN, SL21CVB		
<b>Zubehör für</b>	601011		
		<b>GEV-Nr.</b>	550879 <b>Vergl.-Nr.</b> —
			Isolierung ø 130mm Materialstärke 3mm Loch ø 18mm für Heißluftventilator

Tabellenfortsetzung auf der nächsten Seite



<b>Zubehör für</b>	601011		
	<b>GEV-Nr.</b>	601260	<b>Vergl.-Nr.</b> —
Mutter Gewinde M6L IG für HeiBluftventilator			

## Radiallüfter

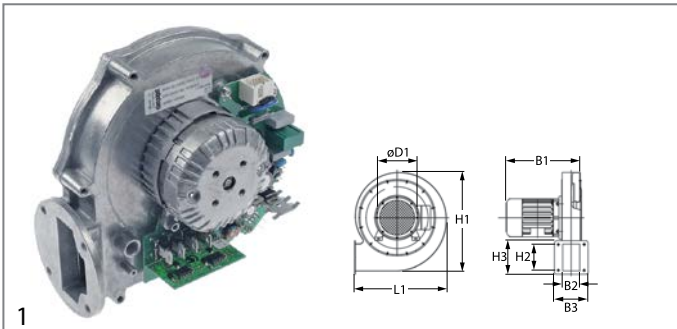

<b>GEV-Nr.</b>	601870	<b>Vergl.-Nr.</b>	32V6840
<b>Beschreibung</b>	Radiallüfter 230/240V Spannung AC 50/60Hz H1 180mm L1 175mm D1 ø 75mm B1 80mm B2 50mm H2 50mm B3 83mm H3 83mm		
<b>Für Modelle:</b>	FC1221G, FM1221G1, FM1221G1-VERS.2006, FM1221G2, FM1221G2-VERS.2006, FM1221G3, FM1221G3-VERS.2006, FM2021G1, FM2021G2, FM2021G2-VERS.2006, FM2021G3, FM2021G3-VERS.2006		

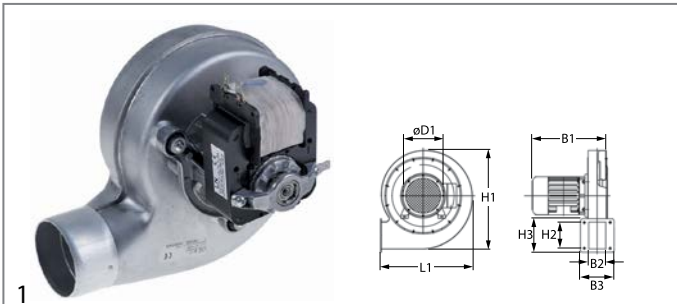

<b>GEV-Nr.</b>	601599	<b>Vergl.-Nr.</b>	32V5830
<b>Beschreibung</b>	Radiallüfter 230V Spannung AC 50Hz 60W H1 175mm L1 205mm D1 ø 109mm B1 135mm B2 58mm H2 58mm MEC		
<b>Für Modelle:</b>	FC1011G, FC611G, FM1011G1, FM1011G1-VERS.2006, FM1011G2, FM1011G2-VERS.2006, FM1011G3, FM1011G3-VERS.2006, FM2011G2-VERS.2006, FM2011G3-VERS.2006, FM611G1, FM611G1-VERS.2006, FM611G2, FM611G2-VERS.2006, FM611G3, FM611G3-VERS.2006, FM721G1, FM721G1-VERS.2006, FM721G2, FM721G2-VERS.2006, FM721G3, FM721G3-VERS.2006		

## Zubehör allgemein



<b>GEV-Nr.</b>	801197	<b>Vergl.-Nr.</b>	3018670 6003060
<b>Beschreibung</b>	Abzieher für Lüfterrad Aufnahme ø 27-33mm Gewinde M16x1,5 SW 17		
<b>Für Modelle:</b>	FM1011E1, FM1011E2, FM1011E3, FM1011G1, FM1011G2, FM1011G3, FM1221E1, FM1221E2, FM1221E3, FM1221G1, FM1221G2, FM1221G3, FM611E1, FM611E2, FM611E3, FM611G1, FM611G2, FM611G3		

<b>Ersatzteile für</b>	801197		
	<b>GEV-Nr.</b>	801198	<b>Vergl.-Nr.</b> 3019160
Schraube für Abzieher Gewinde M16x1,5 L 63mm SW 17			

## Pumpen

### Vibrationspumpen



<b>GEV-Nr.</b>	520159	<b>Vergl.-Nr.</b>	3007950 33Q6630
<b>Beschreibung</b>	Schlauchanschluss Messing vernickelt gerade Gewinde 1/8" Schlauch ø 6mm VPE 1 Stück SW 12 Gesamtlänge 32mm Gewinde L 7.5mm Tülle ø 6mm Tüllenlänge 19.5mm		
<b>Für Modelle:</b>	FM1011E3, FM1011G3, FM1221E3, FM1221G3, FM2021E3, FM2021G3, FM423E2, FM611E3, FM611G3, FM721E3, FM721G3		



<b>GEV-Nr.</b>	500972	<b>Vergl.-Nr.</b>	32M7000 32M7001
<b>Beschreibung</b>	Vibrationspumpe 230V 47W 50Hz Eingang ø 7 Ausgang ø 1/8" IG CEME Typ E507		
<b>Für Modelle:</b>	FM1011E3, FM1011E3-VERS.2006, FM1011G3, FM1011G3-VERS.2006, FM1221E3, FM1221E3-VERS.2006, FM1221G3-VERS.2006, FM2011E3-VERS.2006, FM2011G3-VERS.2006, FM2021E3, FM2021E3-VERS.2006, FM2021G3, FM2021G3-VERS.2006, FM611E3, FM611E3-VERS.2006, FM611G3, FM611G3-VERS.2006, FM721E3, FM721E3-VERS.2006, FM721G3, FM721G3-VERS.2006		

## Kondensatoren & Entstörfilter

### Betriebskondensatoren

#### Kunststoff



<b>GEV-Nr.</b>	365014	<b>Vergl.-Nr.</b>	32Z1310
<b>Beschreibung</b>	Betriebskondensator Kapazität 12.5µF 450V Becherkondensator Toleranz 5%Hz Umgebungstemperatur max. -25 bis + 85°C ø 35mm L 70mm Doppelanschluss M8 Kunststoff Anschluss Flachstecker 6,3mm 45S.C3DS.12,5 Schutzart		
<b>Für Modelle:</b>	L40, L40S		



			
1			
<b>GEV-Nr.</b>	365021	<b>Vergl.-Nr.</b>	32Z6080
<b>Beschreibung</b>	Betriebskondensator Kapazität 16µF 425V Becherkondensator Toleranz 5% 50/60Hz Umgebungstemperatur max. -25 bis + 85°C ø 35mm L 73mm 1-fach M8 Kunststoff Anschluss Flachstecker 6,3mm 416.10.99 Schutzart		
<b>Für Modelle:</b>	FC101, FC241, FC61, FCV101, FCV101DS, FCV141, FCV141DS, FCV141DS-CSA, FCV241, FCV241DS, FCV61, FCV61DS		

			
1			
<b>GEV-Nr.</b>	365224	<b>Vergl.-Nr.</b>	32V6440
<b>Beschreibung</b>	Betriebskondensator Kapazität 25µF 420V Becherkondensator Toleranz 5% 50/60Hz ø 45mm L 75mm M8 Kunststoff Anschluss Flachstecker 6,3mm		
<b>Für Modelle:</b>	FM1011G3, FM1011G3-VERS.2006, FM2011G3-VERS.2006, FM611G3, FM611G3-VERS.2006, FM721G3, FM721G3-VERS.2006, FX61G1, FX61G1R, FX61G2, FX61G2C, FX61G2CR, FX61G2R		

			
1			
<b>GEV-Nr.</b>	365225	<b>Vergl.-Nr.</b>	32V5980
<b>Beschreibung</b>	Betriebskondensator Kapazität 35µF 420V Becherkondensator Toleranz 5% 50/60Hz Umgebungstemperatur max. -25 bis + 85°C ø 45mm L 95mm M8 Kunststoff Anschluss Flachstecker 6,3mm Schutzart		
<b>Für Modelle:</b>	FC1011G, FC611G, FM1011G1-VERS.2006, FM1011G2-VERS.2006, FM1011G3-VERS.2006, FM1221G1, FM1221G1-VERS.2006, FM1221G2, FM1221G2-VERS.2006, FM1221G3-VERS.2006, FM2011G2-VERS.2006, FM2011G3-VERS.2006, FM2021G2-VERS.2006, FM2021G3-VERS.2006, FM611G1-VERS.2006, FM611G2-VERS.2006, FM611G3-VERS.2006, FX101G1, FX101G1R, FX101G2, FX101G2C, FX101G2R, FX10G2CR, FX82G1, FX82G2, FX82G2C		

			
1			
<b>GEV-Nr.</b>	365022	<b>Vergl.-Nr.</b>	32V6540
<b>Beschreibung</b>	Betriebskondensator Kapazität 40µF 400V Becherkondensator Toleranz 5%Hz Umgebungstemperatur max. -25 bis + 85°C ø 45mm L 95mm Doppelanschluss M8 Kunststoff Anschluss Flachstecker 6,3mm Schutzart		
<b>Für Modelle:</b>	BX101G, BX101G-VERS.122013, BX82G, BX82G-VERS.122013, FM1011G1, FM1011G2, FM1011G3, FM611G1, FM611G2, FM611G3, FM721G1, FM721G1-VERS.2006, FM721G2, FM721G2-VERS.2006, FM721G3, FM721G3-VERS.2006, FX101G1, FX101G1R, FX101G2, FX101G2C, FX101G2C-VERS.032014, FX101G2R, FX101G2R-VERS.032014, FX101G2-VERS.032014, FX10G2CR, FX10G2CR-VERS.032014, FX201G2, FX201G2P, FX201G2P-VERS.032014, FX201G2-VERS.032014, FX202G2, FX202G2-VERS.032014, FX82G1, FX82G2, FX82G2C, FX82G2T, FX82G2T-VERS.032014		

			
1			
<b>GEV-Nr.</b>	365013	<b>Vergl.-Nr.</b>	32Z2490
<b>Beschreibung</b>	Betriebskondensator Kapazität 8µF 400V Becherkondensator Toleranz 5%Hz Umgebungstemperatur max. -25 bis + 85°C ø 31.5mm L 55mm Doppelanschluss M8 Kunststoff Anschluss Flachstecker 6,3mm Schutzart		
<b>Für Modelle:</b>	71AR		

Filter

Entstörfilter

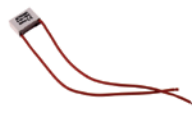
			
1			
<b>GEV-Nr.</b>	365065	<b>Vergl.-Nr.</b>	32Z6100
<b>Beschreibung</b>	Entstörfilter 100Ohm Kapazität 1µF		
<b>Für Modelle:</b>	FCV101DM, FCV101DS, FCV101EDM, FCV101EDS, FCV141DM, FCV141DS, FCV141EDM, FCV141EDS, FCV241DM, FCV241DS, FCV241EDM, FCV241EDS, FCV241GDM, FCV241GDS, FCV401DM, FCV401EDM, FCV4E, FCV4EDS, FCV61DM, FCV61DM-CSA, FCV61DS, FCV61EDM, FCV61EDM-UL, FCV61EDS		

Sicherungen

Feinsicherungen

			
1			
<b>GEV-Nr.</b>	358668	<b>Vergl.-Nr.</b>	3201540
<b>Beschreibung</b>	Feinsicherung Größe ø5x20mm 0.5A flink Nennspannung 250V VPE 10 Stück		
<b>Für Modelle:</b>	04WFR3ED, 08WFR4ED, 08WGREV, 091FR3ED, 0A1FR1ED, 0A1FR3ED, 0D1FR1ED, 0D1FR3ED, 0G0FR3ED, 10CP1EA, 10CP1GA, 10CP1IA, 12CP1EA, 12CP1GA, 12CP1IA, 18CP2EA, 18CP2GA, 18CP2IA, 191FR4ED, 1A1FR2ED, 1A1FR4ED, 1D1FR2ED, 1D1FR4ED, 71RA, 91RA, FC101, FC101E, FC1011G, FC101E, FC1221E, FC1221G, FC241, FC241E, FC241G, FC61, FC61E, FC611G, FC61E, FCV101, FCV101DM, FCV101DS, FCV101E, FCV101EDM, FCV101EDS, FCV141, FCV141DM, FCV141DS, FCV141E, FCV141EDM, FCV141EDS...(Weitere Modelle finden Sie in unserem Webshop)		

			
1			
<b>GEV-Nr.</b>	358671	<b>Vergl.-Nr.</b>	3200020
<b>Beschreibung</b>	Feinsicherung Größe ø5x20mm 1A flink Nennspannung 250V VPE 10 Stück		
<b>Für Modelle:</b>	06WBR3E, 0G1BR3E, 191BR1E, 191BR1GA, 191BR2E, 191BR2EA, 191BR2GA, 1A1BR1E, 1A1BR1GA, 1A1BR2E, 1A1BR2EA, 1A1BR2GA, 1D1BR1E, 1D1BR1GA, 1D1BR2E, 1D1BR2EA, 1D1BR2GA, 1G1BR3E, 291BR1E, 291BR1GA, 291BR2E, 291BR2EA, 291BR2GA, 2A1BR1E, 2A1BR1GA, 2A1BR2E, 2A1BR2EA, 2A1BR2GA, 2D1BR1E, 2D1BR1GA, 2D1BR2E, 2D1BR2EA, 2D1BR2GA, 71ARE, 91ARE, FCV401DM, FCV401EDM		



			
1			
<b>GEV-Nr.</b>	358031	<b>Vergl.-Nr.</b>	32V6210
<b>Beschreibung</b>	Feinsicherung Größe ø10x38mm 10A Nennspannung 500V Typ gG flink VPE 1 Stück		
<b>Für Modelle:</b>	BX101E, BX101E-VERS.122013, BX122E, BX122E-VERS.122013, BX61E, BX61E-VERS.122013, BX82E, BX82E-VERS.122013, FC1011E, FC1221E, FC611E, FM1011E1, FM1011E1-VERS.2006, FM1011E2, FM1011E2-VERS.2006, FM1011E3, FM1011E3-VERS.2006, FM1221E1, FM1221E1-VERS.2006, FM1221E2, FM1221E2-VERS.2006, FM1221E3-VERS.2006, FM2011E2-VERS.2006, FM2011E3-VERS.2006, FM2021E1, FM2021E2, FM2021E2-VERS.2006, FM2021E3, FM2021E3-VERS.2006, FM611E1, FM611E1-VERS.2006, FM611E2, FM611E2-VERS.2006, FM611E3, FM611E3-VERS.2006, FM721E1, FM721E1-VERS.2006, FM721E2, FM721E2-VERS.2006, FM721E3, FM721E3-VERS.2006, FX101E1, FX101E1R, FX101E2, FX101E2C, FX101E2C-VERS.032014, FX101E2R, FX101E2R-VERS.032014, FX101E2-VERS.032014, FX101E3...(Weitere Modelle finden Sie in unserem Webshop)		

## Elektrozubehör

### Kabel

#### Erdungskabel

			
1			
<b>GEV-Nr.</b>	104684	<b>Vergl.-Nr.</b>	3113500
<b>Beschreibung</b>	Erdungskabel Anschluss F2,8mm / Öse M5 Kabellänge 350mm 1.5mm <sup>2</sup>		
<b>Für Modelle:</b>	BX101G, BX101G-VERS.122013, BX122G, BX122G-VERS.122013, BX61G, BX61G-VERS.122013, BX82G, BX82G-VERS.122013, FC1011G, FC611G, FM1011G1, FM1011G1-VERS.2006, FM1011G2, FM1011G2-VERS.2006, FM1011G3, FM1011G3-VERS.2006, FM2011G2-VERS.2006, FM2011G3-VERS.2006, FM611G1, FM611G1-VERS.2006, FM611G2, FM611G2-VERS.2006, FM611G3, FM611G3-VERS.2006, FM721G1, FM721G1-VERS.2006, FM721G2, FM721G2-VERS.2006, FM721G3, FM721G3-VERS.2006, FX101G1, FX101G1R, FX101G2, FX101G2C, FX101G2C-VERS.032014, FX101G2R, FX101G2R-VERS.032014, FX101G2-VERS.032014, FX101G3, FX101G3C, FX101G3C-VERS.022014, FX101G3R, FX101G3R-VERS.022014, FX101G3-VERS.022014, FX10G2CR, FX10G2CR-VERS.032014, FX10G3CR, FX10G3CR-VERS.022014, FX122G1, FX122G2...(Weitere Modelle finden Sie in unserem Webshop)		

			
1			
<b>GEV-Nr.</b>	104798	<b>Vergl.-Nr.</b>	3113480
<b>Beschreibung</b>	Erdungskabel Anschluss F2,8mm/Öse M6 Kabellänge 600mm 1.5mm <sup>2</sup>		
<b>Für Modelle:</b>	FM1221G1, FM1221G1-VERS.2006, FM1221G2, FM1221G2-VERS.2006, FM1221G3, FM1221G3-VERS.2006, FM2021G1, FM2021G2, FM2021G2-VERS.2006, FM2021G3, FM2021G3-VERS.2006, FM721G1, FM721G2, FM721G3		

#### Verbindungskabel

			
1			
<b>GEV-Nr.</b>	579001	<b>Vergl.-Nr.</b>	3116180
<b>Beschreibung</b>	Datenleitung L 1300mm 8-polig passend für RATIONAL Steckertyp RJ45		

## Klemmen

### Porzellanklemmen

			
1			
<b>GEV-Nr.</b>	550112	<b>Vergl.-Nr.</b>	3000060
<b>Beschreibung</b>	Porzellanklemme 2-polig 2.5mm <sup>2</sup> max. 10A max 250V T.max. 200°C L 22mm B 17mm H 15mm BAm VPE 1 Stück		
<b>Für Modelle:</b>	090SPE, 0G0SPE, BX122E, BX122E-VERS.122013, BX122G, BX122G-VERS.122013, FC1221E, FC1221G, FM1221E1-VERS.2006, FM1221E2-VERS.2006, FM1221E3-VERS.2006, FM1221G1-VERS.2006, FM1221G2-VERS.2006, FM1221G3-VERS.2006, FM2011E2-VERS.2006, FM2011E3-VERS.2006, FM2011G2-VERS.2006, FM2011G3-VERS.2006, FM2021E2-VERS.2006, FM2021E3-VERS.2006, FM2021G2-VERS.2006, FM2021G3-VERS.2006, FX122E1, FX122E2, FX122E2C, FX122E2T, FX122E2T-VERS.032014, FX122E3, FX122E3C, FX122E3T, FX122E3T-VERS.022014, FX122G1, FX122G2, FX122G2C, FX122G2T, FX122G2T-VERS.032014, FX122G3, FX122G3C, FX122G3T, FX122G3T-VERS.022014, FX12E3CT, FX12E3CT-VERS.022014, FX12G3CT, FX12G3CT-VERS.022014, FX201E2, FX201E2P, FX201E2P-VERS.032014, FX201E2-VERS.032014, FX201E3, FX201E3P...(Weitere Modelle finden Sie in unserem Webshop)		

### Lüsterklemmen

			
1			
<b>GEV-Nr.</b>	550232	<b>Vergl.-Nr.</b>	32D1450
<b>Beschreibung</b>	Lüsterklemme 12-polig Querschnitt 2.5mm <sup>2</sup> max. 32A max 450V Temp.Best. 150°C		
<b>Für Modelle:</b>	031FT04, 031FT06, 04WBMEV, 04WCP1EM, 04WFR3ED, 04WPE4V, 04WPEBV, 04WVT3RV, 06WBR3E, 06WFT1EV, 06WFT2EV, 06WFT3EV, 06WFT4EV, 06WFT6EV, 06WFT7EV, 07FT04, 07FT05, 071FT04, 071FT06, 08WFR4ED, 08WFT1EV, 08WFT2EV, 08WFT3EV, 08WFT4EV, 08WFT4GV, 08WFT6EV, 08WFT6GV, 08WFT7EV, 08WPE4V, 08WPEBV, 08WTPEV, 090BM1G, 090FT04, 090FT05, 090FT1G, 090FT2G, 090FT4G, 090FT5G, 090FT7G, 090GRG, 090PE4, 090VTR, 091CP1E, 091CP1G, 091FR1EA, 091FR1EX, 091FR3E, 091FR3ED, 091FT04, 091FT06...(Weitere Modelle finden Sie in unserem Webshop)		

### Anschlussklemmen mit Schraub-Steckkontakten

			
1			
<b>GEV-Nr.</b>	550278	<b>Vergl.-Nr.</b>	32D0171
<b>Beschreibung</b>	Netzanschlussklemme 3-polig max. 40A max 400V Anschluss ø6mm <sup>2</sup> / F6,3 Temp.Best. 150°C Querschnitt 6mm <sup>2</sup>		
<b>Für Modelle:</b>	04WBMEV, 04WFAAV, 06WCP1GM, 06WFR3GD, 08WCP1GM, 08WFA4G, 08WFAAG, 08WFAAV, 08WFT1GV, 08WFT2GV, 08WFT3GV, 08WFT4GV, 08WFT6GV, 08WFT7GV, 08WGRGV, 090BM1E, 090BM1G, 090FAA, 090FAVA, 090FT1G, 090FT2G, 090FT4G, 090FT5G, 090FT7G, 090GRG, 090SPE, 091CP1G, 091FR1G, 091FR1GD, 091FR1I, 091FR1IA, 091FR1ID, 091FR1I-VERS.032012, 091FR3G, 091FR3GD, 091FR7G, 091FR7GS, 091FR7G-VERS.052012, 091FR7GX, 0A0BME, 0A1FR1G, 0A1FR1GD, 0A1FR1GD-VERS.2004, 0A1FR1G-VERS.2004, 0A1FR3G, 0A1FR3GD, 0B0BME, 0B1FR1G, 0B1FR1GD, 0D0BME...(Weitere Modelle finden Sie in unserem Webshop)		















			
1			
<b>GEV-Nr.</b>	550411	<b>Vergl.-Nr.</b>	32D0250 32D0251
<b>Beschreibung</b>	Netzanschlussklemme 6-polig max. 40A max 450V Anschluss ø6mm <sup>2</sup> / F6,3 Temp.Best. 150°C Querschnitt 6mm <sup>2</sup>		
<b>Für Modelle:</b>	04WPE4V, 04WPEBV, 04WVT3RV, 08WFA4E, 08WFAAE, 08WGREV, 08WPEBV, 08WTPPEV, 090FT1E, 090FT2E, 090FT4E, 090FT5E, 090FT7E, 090PE4, 090PEB, 0A0FT1E, 0A0FT2E, 0A0FT4E, 0A0FT5E, 0A1CP1E, 0D0FT1E, 0D0FT2E, 0D0FT4E, 0D0FT5E, 0D1CP1E, 0G0PEVTR, 0G0VT1IW, 0G1PE2, 10WTPGE, 12WFA6E, 12WFAAE, 190BM2E, 190FT1E, 190FT2E, 190FT3E, 190FT4E, 190FT5E, 190FT6E, 190FT7E, 190GRE, 1A0BME, 1A0FT1E, 1A0FT2E, 1A0FT3E, 1A0FT4E, 1A0FT6E, 1D0BME, 1D0FT1E, 1D0FT2E, 1D0FT3E...(Weitere Modelle finden Sie in unserem Webshop)		









## Gasventile und Gasfeuerungsautomaten

### Gasregelventile

				
1				
<b>HONEYWELL</b>				
<b>GEV-Nr.</b>	106004	<b>Vergl.-Nr.</b>	32V5810	
<b>Beschreibung</b>	Gasventil Typ VK4105C 220-240V 50/60Hz Gaseingang Flansch 32x32mm Gasausgang Flansch 32x32mm Thermoelementanschluss Zündflammenanschluss Druckbereich 15-60mbar max 60mbar Operatortyp Druckreglertyp V5306E 1234 1 passend für HONEYWELL LA 24mm Flansch 32x32mm			
<b>Für Modelle:</b>	FCV61DS-CSA			
<b>Zubehör für</b>	106004			
	<b>GEV-Nr.</b>	102845	<b>Vergl.-Nr.</b>	—
	Gasanschluss gewinkelt 1/2" Flansch 32x32mm LA 24x24mm Tandem			
	<b>GEV-Nr.</b>	102846	<b>Vergl.-Nr.</b>	—
	Gasanschluss gerade 1/2" Flansch 32x32mm LA 24x24mm passend für Tandem			

				
1				
<b>SIT</b>				
<b>ELETTROSIT</b>				
<b>GEV-Nr.</b>	101993	<b>Vergl.-Nr.</b>	33A0590 6000640	
<b>Beschreibung</b>	Gasventil SIT Typ ELETTROSIT 230V Gaseingang 1/2" Gasausgang 1/2" Thermoelementanschluss M9x1 Zündflammenanschluss M10x1 seitlich Vergl.-Nr. 0.810.126			
<b>Für Modelle:</b>	30F1, 30F1B, 30FS2, 30FS2B, 70F1, 70F1B, 71AR, 71F2, 71F2B, 71RA, 90F110B, 91AR, 91F210, 91F210B, 91F223B, 91RA, FC101, FC61, FCV101, FCV101DM, FCV101DS, FCV241GDM, FCV241GDS, FCV401DM, FCV61, FCV61DM, FCV61DS			
<b>Ersatzteile für</b>	101993			
	<b>GEV-Nr.</b>	101312	<b>Vergl.-Nr.</b>	32W1580 33A0020
	Mikroschalter			
	<b>GEV-Nr.</b>	101352	<b>Vergl.-Nr.</b>	—
	Magnetspule 230V 50Hz passend für ELETTROSIT			
<b>Zubehör für</b>	101993			
	<b>GEV-Nr.</b>	100006	<b>Vergl.-Nr.</b>	—
	Piezozünder passend für ELETTROSIT Körper Kunststoff drückend Anschluss ø2,4mm ø 14mm			
	<b>GEV-Nr.</b>	100904	<b>Vergl.-Nr.</b>	—
	Klemmschraube M10x1 für Rohr-ø 4mm VPE 1 Stück			
	<b>GEV-Nr.</b>	100905	<b>Vergl.-Nr.</b>	—
	Klemmschraube M10x1 für Rohr-ø 6mm VPE 1 Stück			
	<b>GEV-Nr.</b>	101301	<b>Vergl.-Nr.</b>	—
	Gasanschluss Gewinde 1/2" gerade ELETTROSIT Schraubanschluss mit O-Ring			
	<b>GEV-Nr.</b>	101303	<b>Vergl.-Nr.</b>	—
	Gasanschluss gerade Gewinde 3/4" ELETTROSIT			
	<b>GEV-Nr.</b>	101309	<b>Vergl.-Nr.</b>	—
	Verlängerung			
	<b>GEV-Nr.</b>	103104	<b>Vergl.-Nr.</b>	—
	Zündschalter			
	<b>GEV-Nr.</b>	541504	<b>Vergl.-Nr.</b>	33Q5880
	Doppelnippel Gewinde 1/2" - 1/2"			





<b>1</b>				
<b>GEV-Nr.</b>	101127	<b>Vergl.-Nr.</b>	33A0530	
<b>Beschreibung</b>	Gasventil SIT Typ ELETTROSIT 230V Gaseingang 3/4" Gasausgang 3/4" Thermoelementanschluss M9x1 Zündflammenanschluss M10x1 seitlich Vergl.-Nr. 0.810.175			
<b>Für Modelle:</b>	FC241, FC241G, FCV141, FCV141DM, FCV141DS, FCV241, FCV241DM, FCV241DS, FCV241G			
<b>Ersatzteile für</b>	101127			
	<b>GEV-Nr.</b>	101312	<b>Vergl.-Nr.</b>	32W1580 33A0020
		Mikroschalter		
	<b>GEV-Nr.</b>	101352	<b>Vergl.-Nr.</b>	—
		Magnetspule 230V 50Hz passend für ELETTROSIT		
<b>Zubehör für</b>	101127			
	<b>GEV-Nr.</b>	100006	<b>Vergl.-Nr.</b>	—
		Piezozünder passend für ELETTROSIT Körper Kunststoff drückend Anschluss ø2,4mm ø 14mm		
	<b>GEV-Nr.</b>	100904	<b>Vergl.-Nr.</b>	—
		Klemmschraube M10x1 für Rohr-ø 4mm VPE 1 Stück		
	<b>GEV-Nr.</b>	100905	<b>Vergl.-Nr.</b>	—
		Klemmschraube M10x1 für Rohr-ø 6mm VPE 1 Stück		
	<b>GEV-Nr.</b>	101301	<b>Vergl.-Nr.</b>	—
		Gasanschluss Gewinde 1/2" gerade ELETTROSIT Schraubanschluss mit O-Ring		
	<b>GEV-Nr.</b>	101303	<b>Vergl.-Nr.</b>	—
		Gasanschluss gerade Gewinde 3/4" ELETTROSIT		
	<b>GEV-Nr.</b>	101309	<b>Vergl.-Nr.</b>	—
		Verlängerung		





<b>1</b>				
<b>GEV-Nr.</b>	101760	<b>Vergl.-Nr.</b>	33A1640	
<b>Beschreibung</b>	Gasventil SIT Serie Novasit 820 220V 50Hz Gaseingang 1/2" Gasausgang 1/2" Thermoelementanschluss M9x1 Zündflammenanschluss M10x1 Zünddruck 3-5mbar Druckbereich 3-30mbar Anschluss für Druckregler blind Vergl.-Nr. 0.820.060			
<b>Für Modelle:</b>	091FR1G, 091FR3G, 191FR2GD, 191FR4GD			
<b>Ersatzteile für</b>	101760			
	<b>GEV-Nr.</b>	101065	<b>Vergl.-Nr.</b>	—
		Magneteinsatz mit Kabel L 44mm D1 ø 30mm D2 ø 20mm passend für NOVASIT		
	<b>GEV-Nr.</b>	101867	<b>Vergl.-Nr.</b>	—
		Magnetspule 220V 60Hz		
<b>Zubehör für</b>	101760			
	<b>GEV-Nr.</b>	100006	<b>Vergl.-Nr.</b>	—
		Piezozünder passend für ELETTROSIT Körper Kunststoff drückend Anschluss ø2,4mm ø 14mm		
	<b>GEV-Nr.</b>	100904	<b>Vergl.-Nr.</b>	—
		Klemmschraube M10x1 für Rohr-ø 4mm VPE 1 Stück		
	<b>GEV-Nr.</b>	100905	<b>Vergl.-Nr.</b>	—
		Klemmschraube M10x1 für Rohr-ø 6mm VPE 1 Stück		
	<b>GEV-Nr.</b>	101305	<b>Vergl.-Nr.</b>	—
		Gasanschluss gerade 1/2" Flansch 45x45mm ELETTROSIT/V4400/4600/4605 passend für SIT/HONEYWELL LA 36x36mm		
	<b>GEV-Nr.</b>	101306	<b>Vergl.-Nr.</b>	—
		Gasanschluss gewinkelt Flansch 45x45mm LA 36x36mm 1/2" ELETTROSIT/V4400/4600/4605 Schraubanschluss mit O-Ring passend für SIT/HONEYWELL		
	<b>GEV-Nr.</b>	101307	<b>Vergl.-Nr.</b>	—
		Gasanschluss gerade Flansch 45x45mm LA 36x36mm 3/4" ELETTROSIT/V4400/4600/4605 Schraubanschluss mit O-Ring passend für SIT/HONEYWELL		
	<b>GEV-Nr.</b>	101308	<b>Vergl.-Nr.</b>	—
		Gasanschluss gewinkelt Flansch 45x45mm LA 36x36mm 3/4" ELETTROSIT/V4400/4600/4605 Schraubanschluss mit O-Ring passend für SIT/HONEYWELL		
	<b>GEV-Nr.</b>	101312	<b>Vergl.-Nr.</b>	32W1580 33A0020
		Mikroschalter		
	<b>GEV-Nr.</b>	101313	<b>Vergl.-Nr.</b>	—
		Magnetspule 230V 50Hz		
	<b>GEV-Nr.</b>	101314	<b>Vergl.-Nr.</b>	—
		Magnetspule 24V 50Hz		
	<b>GEV-Nr.</b>	101317	<b>Vergl.-Nr.</b>	—
		Stecker mit Kabel L 1000mm passend für NOVASIT		

Tabellenfortsetzung auf der nächsten Seite





<b>Zubehör für</b>	101760			
	GEV-Nr.	101318	Vergl.-Nr.	—
	Abdeckkappe für Magnetspule passend für NOVASIT			
	GEV-Nr.	101503	Vergl.-Nr.	—
	O-Ring EPDM Materialstärke 2mm ID ø 32mm VPE 1 Stück			







<b>Zubehör für</b>	101162			
	GEV-Nr.	101317	Vergl.-Nr.	—
	Stecker mit Kabel L 1000mm passend für NOVASIT			
	GEV-Nr.	101318	Vergl.-Nr.	—
	Abdeckkappe für Magnetspule passend für NOVASIT			



1

<b>GEV-Nr.</b>	101162	<b>Vergl.-Nr.</b>	33A0460
<b>Beschreibung</b>	Gasventil SIT Serie Novasit 820 230V 50Hz Gaseingang 1/2" Gasausgang 1/2" Thermoelementanschluss M9x1 Zündflammenanschluss M10x1 Zünddruck 3-5mbar Druckbereich 3-30mbar Anschluss für Druckregler blind Vergl.-Nr. 0.820.010		
<b>Für Modelle:</b>	06WFR3GD, 091FR1G, 091FR1GD, 091FR3G, 091FR3GD, 0A1FR1G, 0A1FR1GD, 0A1FR1GD-VERS.2004, 0A1FR1G-VERS.2004, 0A1FR3G, 0A1FR3GD, 0B1FR1G, 0B1FR1GD, 0D1FR1G, 0D1FR1GD, 0D1FR1GD-VERS.2004, 0D1FR1G-VERS.2004, 0D1FR3G, 0D1FR3GD, 0G1FR3G, 0G1FR3GD, 10WFR4GD, 191FR2G, 191FR2GD, 191FR4G, 191FR4GD, 1A1FR2G, 1A1FR2GD, 1A1FR2GD-VERS.2004, 1A1FR2G-VERS.2004, 1A1FR4G, 1A1FR4GD, 1D1FR2G, 1D1FR2GD, 1D1FR2GD-VERS.2004, 1D1FR2G-VERS.2004, 1D1FR4G, 1D1FR4GD, 1G1FR4G, 1G1FR4GD, FC101, FC241G, FC61, FCV101, FCV101DM, FCV101DS, FCV141, FCV141DM, FCV141DS, FCV241G...(Weitere Modelle finden Sie in unserem Webshop)		



<b>Ersatzteile für</b>	101162			
	GEV-Nr.	101065	Vergl.-Nr.	—
	Magneteinsatz mit Kabel L 44mm D1 ø 30mm D2 ø 20mm passend für NOVASIT			
	GEV-Nr.	101313	Vergl.-Nr.	—
	Magnetspule 230V 50Hz			



<b>Zubehör für</b>	101162			
	GEV-Nr.	100006	Vergl.-Nr.	—
	Piezozünder passend für ELETTROSIT Körper Kunststoff drückend Anschluss ø2,4mm ø 14mm			
	GEV-Nr.	101305	Vergl.-Nr.	—
	Gasanschluss gerade 1/2" Flansch 45x45mm ELETTROSIT/V4400/4600/4605 passend für SIT/HONEYWELL LA 36x36mm			
	GEV-Nr.	101306	Vergl.-Nr.	—
	Gasanschluss gewinkelt Flansch 45x45mm LA 36x36mm 1/2" ELETTROSIT/V4400/4600/4605 Schraubanschluss mit O-Ring passend für SIT/HONEYWELL			
	GEV-Nr.	101307	Vergl.-Nr.	—
	Gasanschluss gerade Flansch 45x45mm LA 36x36mm 3/4" ELETTROSIT/V4400/4600/4605 Schraubanschluss mit O-Ring passend für SIT/HONEYWELL			
	GEV-Nr.	101308	Vergl.-Nr.	—
	Gasanschluss gewinkelt Flansch 45x45mm LA 36x36mm 3/4" ELETTROSIT/V4400/4600/4605 Schraubanschluss mit O-Ring passend für SIT/HONEYWELL			
	GEV-Nr.	101312	Vergl.-Nr.	32W1580 33A0020
	Mikroschalter			
	GEV-Nr.	101314	Vergl.-Nr.	—
	Magnetspule 24V 50Hz			



1

<b>GEV-Nr.</b>	101956	<b>Vergl.-Nr.</b>	3029730
<b>Beschreibung</b>	Gasventil SIT Serie Novasit 820 230V 50Hz Gaseingang 1/2" Gasausgang 1/2" Thermoelementanschluss M9x1 Zündflammenanschluss M10x1 Zünddruckmbar Druckbereich 5-50mbar Anschluss für Druckregler blind Vergl.-Nr. 0.820.031		

<b>Ersatzteile für</b>	101956			
	GEV-Nr.	101065	Vergl.-Nr.	—
	Magneteinsatz mit Kabel L 44mm D1 ø 30mm D2 ø 20mm passend für NOVASIT			
	GEV-Nr.	101313	Vergl.-Nr.	—
	Magnetspule 230V 50Hz			

<b>Zubehör für</b>	101956			
	GEV-Nr.	100006	Vergl.-Nr.	—
	Piezozünder passend für ELETTROSIT Körper Kunststoff drückend Anschluss ø2,4mm ø 14mm			
	GEV-Nr.	101305	Vergl.-Nr.	—
	Gasanschluss gerade 1/2" Flansch 45x45mm ELETTROSIT/V4400/4600/4605 passend für SIT/HONEYWELL LA 36x36mm			
	GEV-Nr.	101306	Vergl.-Nr.	—
	Gasanschluss gewinkelt Flansch 45x45mm LA 36x36mm 1/2" ELETTROSIT/V4400/4600/4605 Schraubanschluss mit O-Ring passend für SIT/HONEYWELL			
	GEV-Nr.	101307	Vergl.-Nr.	—
	Gasanschluss gerade Flansch 45x45mm LA 36x36mm 3/4" ELETTROSIT/V4400/4600/4605 Schraubanschluss mit O-Ring passend für SIT/HONEYWELL			
	GEV-Nr.	101308	Vergl.-Nr.	—
	Gasanschluss gewinkelt Flansch 45x45mm LA 36x36mm 3/4" ELETTROSIT/V4400/4600/4605 Schraubanschluss mit O-Ring passend für SIT/HONEYWELL			
	GEV-Nr.	101312	Vergl.-Nr.	32W1580 33A0020
	Mikroschalter			
	GEV-Nr.	101314	Vergl.-Nr.	—
	Magnetspule 24V 50Hz			
	GEV-Nr.	101317	Vergl.-Nr.	—
	Stecker mit Kabel L 1000mm passend für NOVASIT			
	GEV-Nr.	101318	Vergl.-Nr.	—
	Abdeckkappe für Magnetspule passend für NOVASIT			

2 Gaskomponenten



## Zubehör



<b>GEV-Nr.</b>	101859	<b>Vergl.-Nr.</b>	32A2340
<b>Beschreibung</b>	Anbaustecker mit Kabel L 1000mm für Gleichrichter passend für NOVASIT		
<b>Für Modelle:</b>	1A1BR1G, 1A1BR1GA, 1A1BR2G, 1A1BR2GA, 1D1BR1G, 1D1BR1GA, 1D1BR2G, 1D1BR2GA, 2A1BR1G, 2A1BR1GA, 2A1BR2G, 2A1BR2GA, 2D1BR1G, 2D1BR1GA, 2D1BR2G, 2D1BR2GA		



<b>GEV-Nr.</b>	101312	<b>Vergl.-Nr.</b>	32W1580 33A0020
<b>Beschreibung</b>	Mikroschalter		
<b>Für Modelle:</b>	06WFR3GD, 091FR1G, 0A1FR1G, 0A1FR1GD, 0A1FR1GD-VERS.2004, 0A1FR1G-VERS.2004, 0A1FR3G, 0A1FR3GD, 0B1FR1G, 0B1FR1GD, 0D1FR1G, 0D1FR1GD, 0D1FR1GD-VERS.2004, 0D1FR1G-VERS.2004, 0D1FR3G, 0D1FR3GD, 0G1FR3G, 0G1FR3GD, 10WFR4GD, 191BR1GA, 191BR2GA, 191FR4G, 191FR4GD, 1A1BR1G, 1A1BR1GA, 1A1BR2G, 1A1BR2GA, 1A1FR2G, 1A1FR2GD, 1A1FR2GD-VERS.2004, 1A1FR2G-VERS.2004, 1A1FR4G, 1A1FR4GD, 1D1BR1G, 1D1BR1GA, 1D1BR2G, 1D1BR2GA, 1D1FR2G, 1D1FR2GD, 1D1FR2GD-VERS.2004, 1D1FR2G-VERS.2004, 1D1FR4G, 1D1FR4GD, 1G1FR4G, 1G1FR4GD, 291BR1G, 291BR1GA, 291BR2G, 291BR2GA, 2A1BR1G...(Weitere Modelle finden Sie in unserem Webshop)		

## SIGMA



<b>GEV-Nr.</b>	101989	<b>Vergl.-Nr.</b>	32V6780
<b>Beschreibung</b>	Gasventil 230V 50Hz Gaseingang 3/4" Gasausgang 3/4" SIT Druckbereich 2-50mbar Vergl.-Nr. 0.840.016		
<b>Ersatzteile für</b>	101989		
	<b>GEV-Nr.</b>	106214	<b>Vergl.-Nr.</b> 3188170
<b>Zubehör für</b>	101989		
	<b>GEV-Nr.</b>	107222	<b>Vergl.-Nr.</b> —





<b>GEV-Nr.</b>	107893	<b>Vergl.-Nr.</b>	3041070
<b>Beschreibung</b>	Gasventil Typ 0840028 220V 60Hz Gaseingang 3/4" Gasausgang 3/4" Druckbereich 2-50mbar		
<b>Für Modelle:</b>	091FR11, 091FR11A, 091FR11D, 091FR11D-VERS.052012, 091FR11-VERS.032012, 091FR7G, 091FR7GS, 091FR7G-VERS.052012, 091FR7GX, 191FR21, 191FR21D, 191FR21D-VERS.092012, 191FR21-VERS.032012, FC1011G, FC1221G, FC611G, FM1011G1, FM1011G1-VERS.2006, FM1011G2, FM1011G2-VERS.2006, FM1011G3, FM1011G3-VERS.2006, FM2011G2-VERS.2006, FM2011G3-VERS.2006, FM2021G1, FM2021G2, FM2021G2-VERS.2006, FM2021G3, FM2021G3-VERS.2006, FM611G1, FM611G1-VERS.2006, FM611G2, FM611G2-VERS.2006, FM611G3, FM611G3-VERS.2006, FM721G1, FM721G1-VERS.2006, FM721G2, FM721G2-VERS.2006, FM721G3, FM721G3-VERS.2006		



<b>GEV-Nr.</b>	107894	<b>Vergl.-Nr.</b>	6300749
<b>Beschreibung</b>	Gasventil Typ 0848083 230V 50Hz Gaseingang 3/4" Gasausgang 3/4" Druckbereich 0,5-12mbar mit Reduzierung 1/2" - 3/4"		
<b>Für Modelle:</b>	BX101G, BX101G-VERS.122013, BX122G, BX122G-VERS.122013, BX61G, BX61G-VERS.122013, BX82G, BX82G-VERS.122013, FX101G1, FX101G1R, FX101G2, FX101G2C, FX101G2C-VERS.032014, FX101G2R, FX101G2R-VERS.032014, FX101G2-VERS.032014, FX101G3, FX101G3C, FX101G3C-VERS.022014, FX101G3R, FX101G3R-VERS.022014, FX101G3-VERS.022014, FX10G2CR, FX10G2CR-VERS.032014, FX10G3CR, FX10G3CR-VERS.022014, FX122G1, FX122G2, FX122G2C, FX122G2T, FX122G2T-VERS.032014, FX122G3, FX122G3C, FX122G3T, FX122G3T-VERS.022014, FX12G3CT, FX12G3CT-VERS.022014, FX201G2, FX201G2P, FX201G2P-VERS.032014, FX201G2-VERS.032014, FX201G3P, FX201G3-VERS.022014, FX202G2, FX202G2-VERS.032014, FX202G3, FX202G3-VERS.022014, FX61G1, FX61G1R, FX61G2...(Weitere Modelle finden Sie in unserem Webshop)		





1

<b>GEV-Nr.</b>	107547	<b>Vergl.-Nr.</b>	3011580
<b>Beschreibung</b>	Gasventil Typ Sigma 230V 50Hz Gaseingang 3/4" AG Gasausgang 3/4" AG Druckbereich 2-50mbar Vergl.-Nr. 0063AS4831		
<b>Für Modelle:</b>	091FR1I, 091FR1IA, 091FR1ID, 091FR1ID-VERS.052012, 091FR1I-VERS.032012, 091FR7G, 091FR7GS, 091FR7G-VERS.052012, 091FR7GX, 191FR2I, 191FR2ID, 191FR2ID-VERS.092012, 191FR2I-VERS.032012, FC1221G, FM1221G1, FM1221G1-VERS.2006, FM1221G2, FM1221G2-VERS.2006, FM1221G3, FM1221G3-VERS.2006		
<b>Ersatzteile für</b>	107547		
	<b>GEV-Nr.</b>	106214	<b>Vergl.-Nr.</b> 3188170
	Magnetspule 230V 50Hz Sigma		
<b>Zubehör für</b>	107547		
	<b>GEV-Nr.</b>	107222	<b>Vergl.-Nr.</b> —
	Stecker für Magnetventil 3-polig Kabellänge 1070mm		



1

<b>GEV-Nr.</b>	107241	<b>Vergl.-Nr.</b>	32V5800
<b>Beschreibung</b>	Gasventil Typ Sigma 230V 50Hz Gaseingang 3/4" Gasausgang 3/4" Druckbereich 2-50mbar		
<b>Für Modelle:</b>	FC1011G, FC611G, FM1011G1, FM1011G1-VERS.2006, FM1011G2, FM1011G2-VERS.2006, FM1011G3, FM1011G3-VERS.2006, FM2011G2-VERS.2006, FM2011G3-VERS.2006, FM2021G1, FM2021G2, FM2021G2-VERS.2006, FM2021G3, FM2021G3-VERS.2006, FM611G1, FM611G1-VERS.2006, FM611G2, FM611G2-VERS.2006, FM611G3, FM611G3-VERS.2006, FM721G1, FM721G1-VERS.2006, FM721G2, FM721G2-VERS.2006, FM721G3, FM721G3-VERS.2006		
<b>Ersatzteile für</b>	107241		
	<b>GEV-Nr.</b>	106214	<b>Vergl.-Nr.</b> 3188170
	Magnetspule 230V 50Hz Sigma		
<b>Zubehör für</b>	107241		
	<b>GEV-Nr.</b>	107222	<b>Vergl.-Nr.</b> —
	Stecker für Magnetventil 3-polig Kabellänge 1070mm		

## Gasfeuerungsautomaten

### Sonstige



1

<b>GEV-Nr.</b>	103221	<b>Vergl.-Nr.</b>	32V5850 32V5851
<b>Beschreibung</b>	Gasfeuerungsautomat RV CONSTRUCTIONS ELECTRIQUES Typ 0526 Wartezeit 7s Sicherheitszeit 10s 230V 50/60Hz		
<b>Für Modelle:</b>	FC1011G, FC1221G, FC611G, FM1011G1, FM1011G1-VERS.2006, FM1011G2, FM1011G2-VERS.2006, FM1011G3, FM1011G3-VERS.2006, FM1221G1, FM1221G1-VERS.2006, FM1221G2, FM1221G2-VERS.2006, FM1221G3, FM1221G3-VERS.2006, FM2011G2-VERS.2006, FM2011G3-VERS.2006, FM2021G1, FM2021G2-VERS.2006, FM2021G3, FM2021G3-VERS.2006, FM611G1, FM611G1-VERS.2006, FM611G2, FM611G2-VERS.2006, FM611G3, FM611G3-VERS.2006, FM721G1, FM721G1-VERS.2006, FM721G2, FM721G2-VERS.2006, FM721G3, FM721G3-VERS.2006		

## Zündtechnik







### Zündbrenner

#### SIT

##### Serie 100



1

<b>GEV-Nr.</b>	106906	<b>Vergl.-Nr.</b>	6000350
<b>Beschreibung</b>	Zündbrenner SIT Typ Serie 100 3-flammig Düse ø 0.2mm Gasanschluss 6mm		
<b>Für Modelle:</b>	71AR, 91AR, FS30		
<b>Ersatzteile für</b>	106906		
	<b>GEV-Nr.</b>	100245	<b>Vergl.-Nr.</b> —
	Zündbrennerdüse Flüssiggas Kennzahl 20 Bohrung ø 0.2mm VPE 1 Stück Gewinde M8x0,75		
	<b>GEV-Nr.</b>	100855	<b>Vergl.-Nr.</b> 33A0950 33A1000 33S0950
	Zündbrennerhalter 3-fach		
	<b>GEV-Nr.</b>	100885	<b>Vergl.-Nr.</b> 33A0970
	Luftmischhülse für Zündbrenner VPE 1 Stück		
	<b>GEV-Nr.</b>	100916	<b>Vergl.-Nr.</b> —
	Druckfeder für Zündbrenner VPE 1 Stück		
	<b>GEV-Nr.</b>	100917	<b>Vergl.-Nr.</b> —
	Dichtung für Zündbrenner VPE 1 Stück Aluminium ID ø 8.5mm AD ø 11mm Materialstärke 1.2mm		
	<b>GEV-Nr.</b>	100918	<b>Vergl.-Nr.</b> —
	Schraube für Zündbrenner		

Tabellenfortsetzung auf der nächsten Seite



<b>Ersatzteile für</b>	106906			
	<b>GEV-Nr.</b>	107162	<b>Vergl.-Nr.</b>	33A1080 33A1081
	Zündbrenneroberteil SIT 3-flammig Hmm Lmm VPE 1 Stück			
	<b>GEV-Nr.</b>	107701	<b>Vergl.-Nr.</b>	—
	Zündbrennerunterteil SIT Serie 100 Düse ø 0.2mm			
<b>Zubehör für</b>	106906			
	<b>GEV-Nr.</b>	100245	<b>Vergl.-Nr.</b>	—
	Zündbrennerdüse Flüssiggas Kennzahl 20 Bohrung ø 0.2mm VPE 1 Stück Gewinde M8x0,75			
	<b>GEV-Nr.</b>	100246	<b>Vergl.-Nr.</b>	33T0410
	Zündbrennerdüse Erdgas Bohrung ø 0.35mm VPE 1 Stück Gewinde M8x0,75			
	<b>GEV-Nr.</b>	100904	<b>Vergl.-Nr.</b>	—
	Klemmschraube M10x1 für Rohr-ø 4mm VPE 1 Stück			
	<b>GEV-Nr.</b>	100905	<b>Vergl.-Nr.</b>	—
	Klemmschraube M10x1 für Rohr-ø 6mm VPE 1 Stück			
	<b>GEV-Nr.</b>	102110	<b>Vergl.-Nr.</b>	—
	Zündgasleitung Kupfer Rohr ø 4mm Wandstärke 1mm L 3000mm			
	<b>GEV-Nr.</b>	102111	<b>Vergl.-Nr.</b>	—
	Zündgasleitung Kupfer Rohr ø 6mm Wandstärke 1mm L 3000mm			
	<b>GEV-Nr.</b>	107171	<b>Vergl.-Nr.</b>	33T0340
	Zündbrennerdüse SIT Erdgas/Flüssiggas Bohrung ø 0.25mm VPE 1 Stück			
	<b>GEV-Nr.</b>	107700	<b>Vergl.-Nr.</b>	33A0960
	Zündbrennerunterteil SIT Serie 100 Düse ø 0.25mm			
	<b>GEV-Nr.</b>	107702	<b>Vergl.-Nr.</b>	33A2900
	Zündbrennerunterteil SIT Serie 100 Düse ø 0.35mm			









**Zubehör****Zündbrenneroberteile**

	1		
<b>GEV-Nr.</b>	107162	<b>Vergl.-Nr.</b>	33A1080 33A1081
<b>Beschreibung</b>	Zündbrenneroberteil SIT 3-flammig Hmm Lmm VPE 1 Stück		
<b>Für Modelle:</b>	030FT, 030FTR, 031FT, 031FT04, 031FT06, 031FTR, 031FTRL, 031TP, 06WCP1GM, 06WFR3GD, 070BM, 070FT, 070FT04, 070FT05, 070FTR, 0712VA, 071BM, 071FT, 071FT04, 071FT06, 071FTR, 071FTRL, 071TP, 08WCP1GM, 08WFA4G, 08WFAAG, 08WFT1GV, 08WFT2GV, 08WFT3GV, 08WFT4GV, 08WFT6GV, 08WFT7GV, 090BM, 090FAVA, 090FT, 090FT04, 090FT05, 090FT1G, 090FT2G, 090FT4G, 090FT5G, 090FT7G, 090FTR, 091BM, 091CP1G, 091FR1G, 091FR1GD, 091FR3G, 091FR3GD, 091FT...(Weitere Modelle finden Sie in unserem Webshop)		

**Zündbrennerunterteile**

	1			
<b>GEV-Nr.</b>	107700	<b>Vergl.-Nr.</b>	33A0960	
<b>Beschreibung</b>	Zündbrennerunterteil SIT Serie 100 Düse ø 0.25mm			
<b>Für Modelle:</b>	031FT04, 031FT06, 06WFR3GD, 070FT04, 070FT05, 071FT04, 071FT06, 08WCP1GM, 08WFT1GV, 08WFT2GV, 08WFT3GV, 08WFT4GV, 08WFT6GV, 08WFT7GV, 090FT04, 090FT05, 091FT04, 091FT06, 0A0FAVA, 0A1FR3G, 0A1FR3GD, 0D0FAVA, 0D1FR3G, 0D1FR3GD, 0G0FT1G, 0G0FT2G, 0G0FT4G, 0G0FT5G, 0G1CP1G, 0G1FR3G, 0G1FR3GD, 10WFR4GD, 1A1FR4G, 1A1FR4GD, 1D1FR4G, 1D1FR4GD, 1G0FT1G, 1G0FT2G, 1G0FT3G, 1G0FT4G, 1G0FT6G, 1G0TP0, 1G1BR1G, 1G1CP1G, 1G1CP2G, 1G1FA0G, 1G1FABG, 1G1FAPG, 1G1FR4G, 1G1FR4GD...(Weitere Modelle finden Sie in unserem Webshop)			
<b>Ersatzteile für</b>	107700			
	<b>GEV-Nr.</b>	100916	<b>Vergl.-Nr.</b>	—
	Druckfeder für Zündbrenner VPE 1 Stück			
	<b>GEV-Nr.</b>	100917	<b>Vergl.-Nr.</b>	—
	Dichtung für Zündbrenner VPE 1 Stück Aluminium ID ø 8.5mm AD ø 11mm Materialstärke 1.2mm			
	<b>GEV-Nr.</b>	100918	<b>Vergl.-Nr.</b>	—
	Schraube für Zündbrenner			
	<b>GEV-Nr.</b>	102742	<b>Vergl.-Nr.</b>	—
	Zündbrennerdüse Flüssiggas Kennzahl 25 Bohrung ø 0.25mm VPE 1 Stück			
<b>Zubehör für</b>	107700			
	<b>GEV-Nr.</b>	100245	<b>Vergl.-Nr.</b>	—
	Zündbrennerdüse Flüssiggas Kennzahl 20 Bohrung ø 0.2mm VPE 1 Stück Gewinde M8x0,75			
	<b>GEV-Nr.</b>	100246	<b>Vergl.-Nr.</b>	33T0410
	Zündbrennerdüse Erdgas Bohrung ø 0.35mm VPE 1 Stück Gewinde M8x0,75			
	<b>GEV-Nr.</b>	100904	<b>Vergl.-Nr.</b>	—
	Klemmschraube M10x1 für Rohr-ø 4mm VPE 1 Stück			
	<b>GEV-Nr.</b>	100905	<b>Vergl.-Nr.</b>	—
	Klemmschraube M10x1 für Rohr-ø 6mm VPE 1 Stück			
	<b>GEV-Nr.</b>	102110	<b>Vergl.-Nr.</b>	—
	Zündgasleitung Kupfer Rohr ø 4mm Wandstärke 1mm L 3000mm			
	<b>GEV-Nr.</b>	102111	<b>Vergl.-Nr.</b>	—
	Zündgasleitung Kupfer Rohr ø 6mm Wandstärke 1mm L 3000mm			







			
1			
<b>GEV-Nr.</b>	107702	<b>Vergl.-Nr.</b>	33A2900
<b>Beschreibung</b>	Zündbrennerunterteil SIT Serie 100 Düse ø 0.35mm		
<b>Für Modelle:</b>	030FT, 030FTR, 031FT, 031FTR, 031FTRL, 031TP, 070BM, 070D, 070DGG, 070FT, 070FTR, 0712D, 0712VA, 071BM, 071D, 071DGG, 071FT, 071FTR, 071FTRL, 071TP, 072D, 072DGG, 090, 090BM, 090FT, 090FTR, 090GG, 091, 091BM, 091FT, 091FTR, 091FTRL, 091GG, 091TP, 092, 092GG, 092VA, 092VAGG, 0A0BMG, 0A0FAS, 0A0FT1G, 0A0FT2G, 0A0FT4G, 0A0FT5G, 0A1FR1G, 0A1FR1GD, 0D0BMG, 0D0FAS, 0D0FT1G, 0D0FT2G...(Weitere Modelle finden Sie in unserem Webshop)		
<b>Ersatzteile für</b>	107702		
	<b>GEV-Nr.</b>	<b>Vergl.-Nr.</b>	33T0410
	100246		
	Zündbrennerdüse Erdgas Bohrung ø 0.35mm VPE 1 Stück Gewinde M8x0,75		
	<b>GEV-Nr.</b>	<b>Vergl.-Nr.</b>	—
	100916		
	Druckfeder für Zündbrenner VPE 1 Stück		
	<b>GEV-Nr.</b>	<b>Vergl.-Nr.</b>	—
	100917		
	Dichtung für Zündbrenner VPE 1 Stück Aluminium ID ø 8.5mm AD ø 11mm Materialstärke 1.2mm		
	<b>GEV-Nr.</b>	<b>Vergl.-Nr.</b>	—
	100918		
	Schraube für Zündbrenner		
<b>Zubehör für</b>	107702		
	<b>GEV-Nr.</b>	<b>Vergl.-Nr.</b>	—
	100245		
	Zündbrennerdüse Flüssiggas Kennzahl 20 Bohrung ø 0.2mm VPE 1 Stück Gewinde M8x0,75		
	<b>GEV-Nr.</b>	<b>Vergl.-Nr.</b>	—
	100904		
	Klemmschraube M10x1 für Rohr-ø 4mm VPE 1 Stück		
	<b>GEV-Nr.</b>	<b>Vergl.-Nr.</b>	—
	100905		
	Klemmschraube M10x1 für Rohr-ø 6mm VPE 1 Stück		
	<b>GEV-Nr.</b>	<b>Vergl.-Nr.</b>	—
	102110		
	Zündgasleitung Kupfer Rohr ø 4mm Wandstärke 1mm L 3000mm		
	<b>GEV-Nr.</b>	<b>Vergl.-Nr.</b>	—
	102111		
	Zündgasleitung Kupfer Rohr ø 6mm Wandstärke 1mm L 3000mm		
	<b>GEV-Nr.</b>	<b>Vergl.-Nr.</b>	—
	102742		
	Zündbrennerdüse Flüssiggas Kennzahl 25 Bohrung ø 0.25mm VPE 1 Stück		

			
1			
<b>GEV-Nr.</b>	100880	<b>Vergl.-Nr.</b>	33A0690
<b>Beschreibung</b>	Zündbrennerunterteil SIT Serie 100 Düse ø 0.4mm		
<b>Für Modelle:</b>	06WCP1GM, 06WFR3GD, 08WCP1GM, 08WFA4G, 08WFAAG, 08WFT1GV, 08WFT2GV, 08WFT3GV, 08WFT4GV, 08WFT6GV, 08WFT7GV, 090BM1G, 090FAVA, 090FT1G, 090FT2G, 090FT4G, 090FT5G, 090FT7G, 091CP1G, 091FR1G, 091FR1GD, 091FR3G, 091FR3GD, 0A0BMG, 0A0FAS, 0A0FT1G, 0A0FT2G, 0A0FT4G, 0A0FT5G, 0A1FR1G, 0A1FR1GD, 0A1FR1GD-VERS.2004, 0A1FR1G-VERS.2004, 0A1FR3G, 0A1FR3GD, 0B0FAS, 0B0FT1G, 0B0FT2G, 0B0FT4G, 0B0FT5G, 0D0BMG, 0D0FAS, 0D0FT1G, 0D0FT2G, 0D0FT4G, 0D0FT5G, 0D1FR1G, 0D1FR1GD, 0D1FR1GD-VERS.2004, 0D1FR1G-VERS.2004...(Weitere Modelle finden Sie in unserem Webshop)		

Zündbrennerhalter

Universal

			
1			
<b>GEV-Nr.</b>	100888	<b>Vergl.-Nr.</b>	33A0980
<b>Beschreibung</b>	Schraubbolzen für Zündbrenner		
<b>Für Modelle:</b>	030FT, 030FTR, 031FT, 031FTR, 031FTRL, 070BM, 070FT, 070FT04, 070FT05, 070FTR, 0712VA, 071BM, 071FT, 071FT04, 071FT06, 071FTR, 071FTRL, 071TP, 090BM, 090FT, 090FTR, 091BM, 091FT, 091FTR, 091FTRL, 091TP, 30F, 30FS, 31, 31PD6, 31PI6, 31R, 31TC, 31TP, 32, 32TC, 32TP, 32TPV, 32V, 60SM, 70F, 712D, 712VA, 71AR, 71D, 71DGG, 71F, 71PD10, 71PD15, 71PI10...(Weitere Modelle finden Sie in unserem Webshop)		

			
1			
<b>GEV-Nr.</b>	100855	<b>Vergl.-Nr.</b>	33A0950 33A1000 33S0950
<b>Beschreibung</b>	Zündbrennerhalter 3-fach		
<b>Zubehör für</b>	100855		
	<b>GEV-Nr.</b>	<b>Vergl.-Nr.</b>	33A0950 33A1000 33S0950
	100855		
	Zündbrennerhalter 3-fach		
	<b>GEV-Nr.</b>	<b>Vergl.-Nr.</b>	33A1000
	100886		
	Zündbrennerhalter passend für Serie 100 3-teilig		
	<b>GEV-Nr.</b>	<b>Vergl.-Nr.</b>	33A0980
	100888		
	Schraubbolzen für Zündbrenner		

Zündbrennerdüsen

			
1			
<b>GEV-Nr.</b>	100246	<b>Vergl.-Nr.</b>	33T0410
<b>Beschreibung</b>	Zündbrennerdüse Erdgas Bohrung ø 0.35mm VPE 1 Stück Gewinde M8x0,75		

	<b>GEV-Nr.</b> 102972	<b>Vergl.-Nr.</b> 33T3130
<b>Beschreibung</b> Zündbrennerdüse Erdgas Kennzahl 40 Bohrung ø 0.4mm VPE 1 Stück		

**Zündelectroden**

	<b>GEV-Nr.</b> 100706	<b>Vergl.-Nr.</b> 32T0320
<b>Beschreibung</b> Zündelectrode Anschluss M4 VPE 1 Stück		
<b>Für Modelle:</b> 191CP1GA, 1A1CP1GA, 1A1PI2G, 1A1PI2GA, 1D1CP1GA, 1D1PI2G, 1D1PI2GA, 291PD3G, 291PI3G, 2A1PD3G, 2A1PI3G, 2D1PI3G		

	<b>GEV-Nr.</b> 100707	<b>Vergl.-Nr.</b> 3232960
<b>Beschreibung</b> Zündelectrode D1 ø 7mm D2 ø 9mm Anschluss ø2,4mm L1 14mm L2 6mm KL1 18mm KL2 3mm KL3 23mm zum Klemmen VPE 1 Stück		
<b>Für Modelle:</b> 06WCP1GM, 08WCP1GM, 08WFA4G, 08WFAAG, 090BM1G, 090FAVA, 090FT1G, 090FT2G, 090FT4G, 090FT5G, 090FT7G, 091CP1G, 091FR1G, 091FR1GD, 091FR3G, 091FR3GD, 0G0FT1G-VERS.032008, 0G0FT2G-VERS.032008, 0G0FT4G-VERS.032008, 0G0FT5G-VERS.032008, 0G0FT7G, 0G1CP1G-VERS.2004, 0G1FR3G, 0G1FR3GD, 0G1FR7G, 10WTPGE, 10WTPGV, 12WFA6G, 12WFAAG, 190BM2G, 190FAB, 190FT15G, 190FT1G, 190FT2G, 190FT3G, 190FT42G, 190FT4G, 190FT6G, 190FT72G, 190FT7G, 190TP0, 191BR1G, 191BR1GA, 191BR2G, 191BR2GA, 191CP2G, 191FAAG, 191FABG, 191FADG, 191FR2G...(Weitere Modelle finden Sie in unserem Webshop)		

	<b>GEV-Nr.</b> 100701	<b>Vergl.-Nr.</b> 32T0190
<b>Beschreibung</b> Zündelectrode Anschluss M4 VPE 1 Stück		
<b>Für Modelle:</b> 08WGRGV, 090GRG, 0A0GRG, 0A1CP1G, 0B1CP1G, 0D0GRG, 0D1CP1G, 190GRG, 191CP1G, 1A0GRG, 1A1CP1G, 1A1CP2G, 1A1PD1G, 1A1PD2G, 1A1PI1G, 1A1PI1GA, 1D0GRG, 1D1CP1G, 1D1CP2G, 1D1PD1G, 1D1PD2G, 1D1PI1G, 1D1PI1GA, 1G0GRG, 6042120-08WGRGV		

	<b>GEV-Nr.</b> 100706	<b>Vergl.-Nr.</b> 32T0320
<b>Beschreibung</b> Zündelectrode Anschluss M4 VPE 1 Stück		
<b>Für Modelle:</b> 191CP1GA, 1A1CP1GA, 1A1PI2G, 1A1PI2GA, 1D1CP1GA, 1D1PI2G, 1D1PI2GA, 291PD3G, 291PI3G, 2A1PD3G, 2A1PI3G, 2D1PI3G		

**Sonstiges**

	<b>GEV-Nr.</b> 100885	<b>Vergl.-Nr.</b> 33A0970
<b>Beschreibung</b> Luftmischhülse für Zündbrenner VPE 1 Stück		
<b>Für Modelle:</b> 030, 030FT, 030FTR, 031, 031FT, 031FT04, 031FT06, 031FTR, 031FTRL, 031TP, 032, 06WCP1GM, 06WFR3GD, 070BM, 070D, 070DGG, 070FT, 070FT04, 070FT05, 070FTR, 0712D, 0712VA, 071BM, 071D, 071DGG, 071FT, 071FT04, 071FT06, 071FTR, 071FTRL, 071TP, 072D, 072DGG, 08WCP1GM, 08WFA4G, 08WFAAG, 08WFT1GV, 08WFT2GV, 08WFT3GV, 08WFT4GV, 08WFT6GV, 08WFT7GV, 090, 090BM, 090BM1G, 090FAVA, 090FT, 090FT04, 090FT05, 090FT1G...(Weitere Modelle finden Sie in unserem Webshop)		

**Elektroden**

	<b>GEV-Nr.</b> 100906	<b>Vergl.-Nr.</b> 36Q1050
<b>Beschreibung</b> Verschraubung Gewinde M10x1 für Zündelectrode Messing VPE 1 Stück SW 10		
<b>Für Modelle:</b> 08WGRGV, 090GRG, 0A0GRG, 0A1CP1G, 0B1CP1G, 0D0GRG, 0D1CP1G, 190GRG, 191CP1G, 1A0GRG, 1A1CP1G, 1A1CP2G, 1A1PD1G, 1A1PD2G, 1A1PI1G, 1A1PI1GA, 1D0GRG, 1D1CP1G, 1D1CP2G, 1D1PD1G, 1D1PD2G, 1D1PI1G, 1D1PI1GA, 1G0GRG, 6042120-08WGRGV		

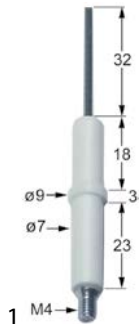
	<b>GEV-Nr.</b> 100906	<b>Vergl.-Nr.</b> 36Q1050
<b>Beschreibung</b> Verschraubung Gewinde M10x1 für Zündelectrode Messing VPE 1 Stück SW 10		

	<b>GEV-Nr.</b> 100906	<b>Vergl.-Nr.</b> 36Q1050
<b>Beschreibung</b> Verschraubung Gewinde M10x1 für Zündelectrode Messing VPE 1 Stück SW 10		

	<b>GEV-Nr.</b> 100906	<b>Vergl.-Nr.</b> 36Q1050
<b>Beschreibung</b> Verschraubung Gewinde M10x1 für Zündelectrode Messing VPE 1 Stück SW 10		

	<b>GEV-Nr.</b> 100706	<b>Vergl.-Nr.</b> 32T0320
<b>Beschreibung</b> Zündelectrode Anschluss M4 VPE 1 Stück		
<b>Für Modelle:</b> 191CP1GA, 1A1CP1GA, 1A1PI2G, 1A1PI2GA, 1D1CP1GA, 1D1PI2G, 1D1PI2GA, 291PD3G, 291PI3G, 2A1PD3G, 2A1PI3G, 2D1PI3G		

	<b>GEV-Nr.</b> 100701	<b>Vergl.-Nr.</b> 32T0190
<b>Beschreibung</b> Zündelectrode Anschluss M4 VPE 1 Stück		
<b>Für Modelle:</b> 08WGRGV, 090GRG, 0A0GRG, 0A1CP1G, 0B1CP1G, 0D0GRG, 0D1CP1G, 190GRG, 191CP1G, 1A0GRG, 1A1CP1G, 1A1CP2G, 1A1PD1G, 1A1PD2G, 1A1PI1G, 1A1PI1GA, 1D0GRG, 1D1CP1G, 1D1CP2G, 1D1PD1G, 1D1PD2G, 1D1PI1G, 1D1PI1GA, 1G0GRG, 6042120-08WGRGV		





<b>GEV-Nr.</b>	100707	<b>Vergl.-Nr.</b>	3232960
<b>Beschreibung</b>	Zünderlektrode D1 ø 7mm D2 ø 9mm Anschluss ø2,4mm L1 14mm L2 6mm KL1 18mm KL2 3mm KL3 23mm zum Klemmen VPE 1 Stück		
<b>Für Modelle:</b>	06WCP1GM, 08WCP1GM, 08WFA4G, 08WFAAG, 090BM1G, 090FAVA, 090FT1G, 090FT2G, 090FT4G, 090FT5G, 090FT7G, 091CP1G, 091FR1G, 091FR1GD, 091FR3G, 091FR3GD, 0G0FT1G-VERS.032008, 0G0FT2G-VERS.032008, 0G0FT4G-VERS.032008, 0G0FT5G-VERS.032008, 0G0FT7G, 0G1CP1G-VERS.2004, 0G1FR3G, 0G1FR3GD, 0G1FR7G, 10WTPGE, 10WTPGV, 12WFA6G, 12WFAAG, 190BM2G, 190FAB, 190FT15G, 190FT1G, 190FT2G, 190FT3G, 190FT42G, 190FT4G, 190FT6G, 190FT72G, 190FT7G, 190TP0, 191BR1G, 191BR1GA, 191BR2G, 191BR2GA, 191CP2G, 191FAAG, 191FABG, 191FADG, 191FR2G...(Weitere Modelle finden Sie in unserem Webshop)		

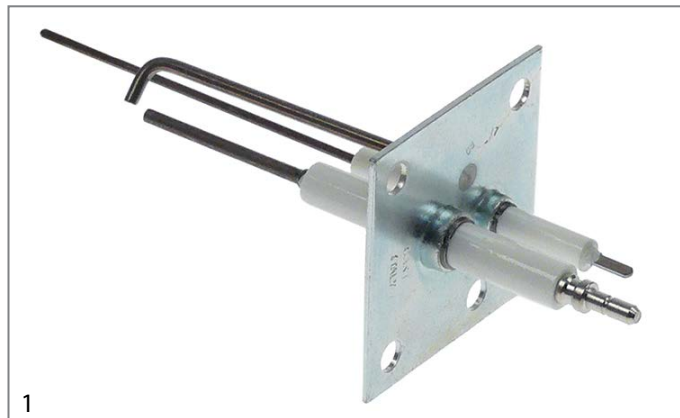

<b>GEV-Nr.</b>	104800	<b>Vergl.-Nr.</b>	32V4670
<b>Beschreibung</b>	Zünderlektrode FL 55mm FB 55mm D1 ø 9mm D2 ø 7mm L1 119mm L2 145mm KL1 60mm KL2 55mm		



<b>GEV-Nr.</b>	106743	<b>Vergl.-Nr.</b>	6300568
<b>Beschreibung</b>	Zünderlektrode FL 55mm FB 55mm D1 ø 9.3mm D2 ø 5.85mm L1 80mm KL1 80mm KL2 33.5mm KL3 29.5mm KL4 24.5mm mit Befestigungsflansch mit Montagmaterial Anschluss ø 4mm		
<b>Für Modelle:</b>	FC1221G, FM1221G1, FM1221G1-VERS.2006, FM1221G2, FM1221G2-VERS.2006, FM1221G3, FM1221G3-VERS.2006, FM2021G1, FM2021G2, FM2021G2-VERS.2006, FM2021G3, FM2021G3-VERS.2006, FM721G1, FM721G1-VERS.2006, FM721G2, FM721G2-VERS.2006, FM721G3, FM721G3-VERS.2006		



<b>GEV-Nr.</b>	104799	<b>Vergl.-Nr.</b>	6300747
<b>Beschreibung</b>	Zünderlektrode FL 56mm FB 22mm D1 ø 9x62mm D2 ø 9x62mm L1 130mm L2 140mm		
<b>Für Modelle:</b>	BX122G, BX122G-VERS.122013, BX82G, BX82G-VERS.122013, FX122G1, FX122G2, FX122G2C, FX122G2T, FX122G2T-VERS.032014, FX122G3, FX122G3C, FX122G3T, FX122G3T-VERS.022014, FX12G3CT, FX12G3CT-VERS.022014, FX202G2, FX202G2-VERS.032014, FX202G3, FX202G3-VERS.022014, FX82G1, FX82G2, FX82G2C, FX82G2T, FX82G2T-VERS.032014, FX82G3, FX82G3C, FX82G3CT, FX82G3CT-VERS.022014, FX82G3T, FX82G3T-VERS.022014		



<b>GEV-Nr.</b>	104801	<b>Vergl.-Nr.</b>	6300567
<b>Beschreibung</b>	Zünderlektrode FL 55mm FB 55mm D1 ø 9mm D2 ø 7mm L1 118mm L2 145mm KL1 77mm KL2 65mm		
<b>Für Modelle:</b>	FC1011G, FC611G, FM1011G1, FM1011G1-VERS.2006, FM1011G2, FM1011G2-VERS.2006, FM1011G3, FM1011G3-VERS.2006, FM2011G2-VERS.2006, FM2011G3-VERS.2006, FM611G1, FM611G1-VERS.2006, FM611G2, FM611G2-VERS.2006, FM611G3, FM611G3-VERS.2006		



**1**

<b>GEV-Nr.</b>	103287	<b>Vergl.-Nr.</b>	6300746
<b>Beschreibung</b>	Zündelektrode Kit FL 56mm FB 22mm D1 ø 3mm D2 ø 9,5mm BA 47mm		
<b>Für Modelle:</b>	BX101G, BX101G-VERS.122013, BX61G, BX61G-VERS.122013, FX101G1, FX101G1R, FX101G2, FX101G2C, FX101G2C-VERS.032014, FX101G2R, FX101G2R-VERS.032014, FX101G2-VERS.032014, FX101G3, FX101G3C, FX101G3C-VERS.022014, FX101G3R, FX101G3R-VERS.022014, FX101G3-VERS.022014, FX10G2CR, FX10G2CR-VERS.032014, FX10G3CR, FX10G3CR-VERS.022014, FX201G2, FX201G2P, FX201G2P-VERS.032014, FX201G2-VERS.032014, FX201G3P, FX201G3-VERS.022014, FX61G1, FX61G1R, FX61G2, FX61G2C, FX61G2CR, FX61G2CR-VERS.032014, FX61G2C-VERS.032014, FX61G2R, FX61G2R-VERS.032014, FX61G2-VERS.032014, FX61G3, FX61G3C, FX61G3CR, FX61G3CR-VERS.022014, FX61G3C-VERS.022014, FX61G3R, FX61G3R-VERS.022014, FX61G3-VERS.022014		

## Zündkabel

### Konfektionierte Kabel



**1**

<b>GEV-Nr.</b>	100190	<b>Vergl.-Nr.</b>	32A0061 32A0390
<b>Beschreibung</b>	Zündkabel Kabellänge 1200mm Anschluss F2,8mm / F2,8mm		
<b>Für Modelle:</b>	06WFR3GD, 071TP, 08WFAAG, 08WFT1GV, 08WFT2GV, 08WFT3GV, 08WFT4GV, 08WFT6GV, 08WFT7GV, 090FAVA, 091FR1G, 091FR1GD, 091FR3G, 091FR3GD, 091TP, 0A1FR1G, 0A1FR1GD, 0A1FR1GD-VERS.2004, 0A1FR1G-VERS.2004, 0A1FR3G, 0A1FR3GD, 0B1FR1G, 0B1FR1GD, 0D1FR1G, 0D1FR1GD, 0D1FR1GD-VERS.2004, 0D1FR1G-VERS.2004, 0D1FR3G, 0D1FR3GD, 0G1FR3G, 0G1FR3GD, 10WFR4GD, 12WFAAG, 190FAB, 191BR1G, 191BR1GA, 191BR2G, 191BR2GA, 191CP1GA, 191FABG, 191FR2G, 191FR2GD, 191FR4G, 191FR4GD, 1A1BR1G, 1A1BR1GA, 1A1BR2G, 1A1BR2GA, 1A1CP1GA, 1A1FR2G... (Weitere Modelle finden Sie in unserem Webshop)		



**1**

<b>GEV-Nr.</b>	100179	<b>Vergl.-Nr.</b>	32A2540
<b>Beschreibung</b>	Zündkabel Kabellänge 1200mm Anschluss F2,8mm / ø2,4mm		
<b>Für Modelle:</b>	08WGRGV, 090GRG, 0A0BMG, 0A0FAVA, 0D0BMG, 0D0FAVA, 0G0FR5G, 0G1CP1G, 0G1CP1G-VERS.2004, 0G1FR7G, 190GRG, 191CP1G, 1A0BMG, 1A0FA2, 1A0FA5, 1A0FAB, 1A0FAS2, 1A0TP0, 1A1FA2G, 1A1FA5G, 1A1FABG, 1A1FAS2G, 1A1FASG, 1A1TP0G, 1A1TP0G-VERS.2002, 1B0FAS2, 1B0TP0, 1B1FAS2G, 1D0BMG, 1D0FA2, 1D0FA5, 1D0FAB, 1D0FAS2, 1D0TP0, 1D1FA2G, 1D1FA5G, 1D1FABG, 1D1FAS2G, 1D1FASG, 1D1TP0G, 1D1TP0G-VERS.2002, 1G0FR6G, 1G1CP1G, 1G1CP1G-VERS.2004, 1G1CP2G, 1G1CP2G-VERS.2004, 1G1FR8G, 2A0FAS2, 2A1FAS2G, 2A1FASG... (Weitere Modelle finden Sie in unserem Webshop)		



**1**

<b>GEV-Nr.</b>	102163	<b>Vergl.-Nr.</b>	32A3080
<b>Beschreibung</b>	Zündkabel Kabellänge 1500mm Anschluss F2,8mm / ø2,4mm		
<b>Für Modelle:</b>	08WFA4G, 12WFA6G, 190TP0, 191FAAG, 191FADG, 191FAG, 191PD2G, 191PI1G, 191PI1GA, 191PI2G, 191PI2GA, 191TPG, 1G1FA0G, 1G1FAPG, 1G1TP0G, 291FAG, 291TPCG, 2A1PI3G, 2D1PI3G, 2G1FA0G, 2G1FADG, 2G1FADGV, 2G1FAPG, 2G1TP3G, 391FAG		



**1**

<b>GEV-Nr.</b>	100189	<b>Vergl.-Nr.</b>	3059160 32A1640
<b>Beschreibung</b>	Zündkabel Kabellänge 150mm Anschluss F2,8mm / Öse M4		
<b>Für Modelle:</b>	090FT1G, 090FT2G, 090FT4G, 090FT5G, 090FT7G, 090GRG, 091CP1G, 091FR1G, 091FR1GD, 091FR3G, 091FR3GD, 0A1FR1G, 0A1FR1GD, 0A1FR1GD-VERS.2004, 0A1FR1G-VERS.2004, 0A1FR3G, 0A1FR3GD, 0B1FR1G, 0B1FR1GD, 0D1FR1G, 0D1FR1GD, 0D1FR1GD-VERS.2004, 0D1FR1G-VERS.2004, 0D1FR3G, 0D1FR3GD, 0G1FR3G, 0G1FR3GD, 10WTPGE, 191BR1G, 191BR1GA, 191BR2G, 191BR2GA, 1A1BR1G, 1A1BR1GA, 1A1BR2G, 1A1BR2GA, 1D1BR1G, 1D1BR1GA, 1D1BR2G, 1D1BR2GA, 1G1FR4G, 1G1FR4GD, 291BR1G, 291BR1GA, 291BR2G, 291BR2GA, 2A1BR1G, 2A1BR1GA, 2A1BR2G, 2A1BR2GA... (Weitere Modelle finden Sie in unserem Webshop)		



**1**

<b>GEV-Nr.</b>	103353	<b>Vergl.-Nr.</b>	3113510
<b>Beschreibung</b>	Zündkabel Kabellänge 350mm Anschluss F2,8/F6,3		
<b>Für Modelle:</b>	FC1011G, FC611G, FM1011G1, FM1011G1-VERS.2006, FM1011G2, FM1011G2-VERS.2006, FM1011G3, FM1011G3-VERS.2006, FM2011G2-VERS.2006, FM2011G3-VERS.2006, FM611G1, FM611G1-VERS.2006, FM611G2, FM611G2-VERS.2006, FM611G3, FM611G3-VERS.2006, FM721G1, FM721G1-VERS.2006, FM721G2, FM721G2-VERS.2006, FM721G3, FM721G3-VERS.2006		



**1**

<b>GEV-Nr.</b>	102162	<b>Vergl.-Nr.</b>	3116311
<b>Beschreibung</b>	Zündkabel Kabellänge 400mm Anschluss F2,8mm / F6,3mm		



**1**

<b>GEV-Nr.</b>	103352	<b>Vergl.-Nr.</b>	3113490
<b>Beschreibung</b>	Zündkabel Kabellänge 550mm Anschluss F2,8mm / F6,3mm		
<b>Für Modelle:</b>	FM1221G1, FM1221G1-VERS.2006, FM1221G2, FM1221G2-VERS.2006, FM1221G3, FM1221G3-VERS.2006, FM2021G1, FM2021G2, FM2021G2-VERS.2006, FM2021G3, FM2021G3-VERS.2006, FM721G1, FM721G2, FM721G3, FX201G2, FX201G2P, FX201G2P-VERS.032014, FX201G2-VERS.032014, FX201G3P, FX201G3-VERS.022014, FX202G2, FX202G2-VERS.032014, FX202G3, FX202G3-VERS.022014		



**1**

<b>GEV-Nr.</b>	100025	<b>Vergl.-Nr.</b>	32A0051
<b>Beschreibung</b>	Zündkabel Kabellänge 600mm Anschluss ø4mm / F6,3mm		



**1**

<b>GEV-Nr.</b>	100037	<b>Vergl.-Nr.</b>	32A0010 32A0060 32A0210
<b>Beschreibung</b>	Zündkabel Kabellänge 900mm Anschluss F2,8mm / F2,8mm		
<b>Für Modelle:</b>	030FT, 030FTR, 031FT, 031FTR, 031FTRL, 031TP, 070BM, 070FT, 070FTR, 0712VA, 071BM, 071FT, 071FTR, 071FTRL, 090BM, 090BM1G, 090FT, 090FTR, 091BM, 091FT, 091FTR, 091FTRL, 092VA, 092VAGG, 135PVX, 190BM2G, 1G0TP0, 1G1TP0G, 2G1TP3G, 30CPS, 30F, 30FS, 31TP, 32TP, 32TPV, 70CP, 70F, 712D, 712VA, 71CP2, 71D, 71DGG, 71F, 71TP, 72D, 72DGG, 72TP, 72TPGG, 72VA, 72VAGG... (Weitere Modelle finden Sie in unserem Webshop)		





			
<b>GEV-Nr.</b>	100016	<b>Vergl.-Nr.</b>	32A2550
<b>Beschreibung</b>	Zündkabel Kabellänge 900mm Anschluss ø2,4mm / ø2,4mm		
<b>Für Modelle:</b>	0A1CP1G, 0B1CP1G, 0D1CP1G, 0G1CP1G-VERS.2004, 0G1FR7G, 1A1CP1G, 1A1CP2G, 1A1PD1G, 1A1PD2G, 1A1PI1G, 1A1PI1GA, 1D1CP1G, 1D1CP2G, 1D1PD1G, 1D1PD2G, 1D1PI1G, 1D1PI1GA, 1G0FR6G, 1G1CP1G-VERS.2004, 1G1CP2G-VERS.2004, 1G1FR8G, 1G1PD1G, 1G1PI1G		

Diverse

			
<b>GEV-Nr.</b>	102986	<b>Vergl.-Nr.</b>	32A1600
<b>Beschreibung</b>	Zündkabel 1000Ohm		
<b>Für Modelle:</b>	FCV101DM, FCV101DS, FCV141DM, FCV141DS, FCV241DM, FCV241DS, FCV241GDM, FCV241GDS, FCV401DM, FCV61DM, FCV61DS		

Zündgruppen

			
<b>GEV-Nr.</b>	102485	<b>Vergl.-Nr.</b>	32T0040 32T0041 32T0050 32T0210
<b>Beschreibung</b>	Zündgruppe Ausgänge 2 220-240VAC 0.6VA 50-60Hz		
<b>Für Modelle:</b>	04WFAAV, 06WCP1GM, 06WFR3GD, 08WCP1GM, 08WFT1GV, 08WFT-2GV, 08WFT3GV, 08WFT4GV, 08WFT6GV, 08WFT7GV, 08WGRGV, 090BM1G, 090FAA, 090FAVA, 090FT1G, 090FT2G, 090FT4G, 090FT5G, 090FT7G, 090GRG, 091CP1G, 091FR1G, 091FR1GD, 091FR3G, 091FR3GD, 0A1FR1G, 0A1FR1GD, 0A1FR1GD-VERS.2004, 0A1FR1G-VERS.2004, 0A1FR3G, 0A1FR3GD, 0B1FR1G, 0B1FR1GD, 0D1FR1G, 0D1FR1GD, 0D1FR1GD-VERS.2004, 0D1FR1G-VERS.2004, 0D1FR3G, 0D1FR3GD, 0G1FR3G, 0G1FR3GD, 10CP1GA, 10WFR4GD, 10WTPGV, 12CP1GA, 12WFA6G, 18CP2GA, 190BM2G, 190FAB, 190FT15G...(Weitere Modelle finden Sie in unserem Webshop)		

			
<b>GEV-Nr.</b>	103334	<b>Vergl.-Nr.</b>	3144130
<b>Beschreibung</b>	Zündgruppe Ausgänge 2 220-240VAC Maße 83x42x32mm BA 34mm Eingang F2,8 Ausgang F2,8 Typ TSM 17VA 50/60Hz		
<b>Für Modelle:</b>	BX101G, BX101G-VERS.122013, BX122G, BX122G-VERS.122013, BX61G, BX61G-VERS.122013, BX82G, BX82G-VERS.122013, FX101G1, FX101G1R, FX101G2, FX101G2C, FX101G2C-VERS.032014, FX101G2R, FX101G2R-VERS.032014, FX101G2-VERS.032014, FX101G3, FX101G3C, FX101G3C-VERS.022014, FX101G3R, FX101G3R-VERS.022014, FX101G3-VERS.022014, FX10G2CR, FX10G2CR-VERS.032014, FX10G3CR, FX10G3CR-VERS.022014, FX122G1, FX122G2, FX122G2C, FX122G2T, FX122G2T-VERS.032014, FX122G3, FX122G3C, FX122G3T, FX122G3T-VERS.022014, FX12G3CT, FX12G3CT-VERS.022014, FX201G2, FX201G2P, FX201G2P-VERS.032014, FX201G2-VERS.032014, FX201G3P, FX201G3-VERS.022014, FX202G2, FX202G2-VERS.032014, FX202G3, FX202G3-VERS.022014, FX61G1, FX61G1R, FX61G2...(Weitere Modelle finden Sie in unserem Webshop)		

			
<b>GEV-Nr.</b>	101002	<b>Vergl.-Nr.</b>	3107650
<b>Beschreibung</b>	Zündgruppe Ausgänge 2 230VAC Maße 88x23x34mm BA 73mm Eingang F6,3x0,8 Ausgang F2,8x0,8 0.6VA 50/60Hz		
<b>Für Modelle:</b>	091FR1ID-VERS.052012, 091FR1I-VERS.032012, 091FR7G, 091FR7GS, 091FR7G-VERS.052012, 091FR7GX, 10CP1IA, 12CP1IA, 18CP2IA, 191FR2ID-VERS.092012, 191FR2I-VERS.032012		

			
<b>GEV-Nr.</b>	102388	<b>Vergl.-Nr.</b>	3134640 32T0030
<b>Beschreibung</b>	Zündgruppe Ausgänge 4 230VAC Maße 111x23x34mm BA 100mm Eingang F6,3x0,8 Ausgang F2,8x0,8 Typ WAC-T4 0.6VA 50/60Hz		

			
<b>GEV-Nr.</b>	102389	<b>Vergl.-Nr.</b>	3015000
<b>Beschreibung</b>	Zündgruppe Ausgänge 6 230VAC Maße 135x23x34mm BA 123mm Eingang F6,3x0,8 Ausgang F2,8x0,8 0.6VA 50/60Hz		
<b>Für Modelle:</b>	08WFA4E, 08WFA4G, 08WFAAE, 08WFAAG, 08WFAAV, 10WTPGE, 12WFA6E, 12WFA6G, 12WFAAA, 12WFAAE, 12WFAAG, 12WFAAN		

			
<b>GEV-Nr.</b>	101005	<b>Vergl.-Nr.</b>	32T0020
<b>Beschreibung</b>	Zündgruppe Ausgänge 8 230VAC Maße 92x68x33mm BA 88mm Eingang F6,3x0,8 Ausgang F2,8x0,8 Typ BK 40086-00 0.6VA 50-60Hz		

Thermoelemente

Einsteckthermoelemente

Einsteckthermoelemente Standard

mit Stechhülse ø6mm

Typ Junkers mit aluminierter Spitze

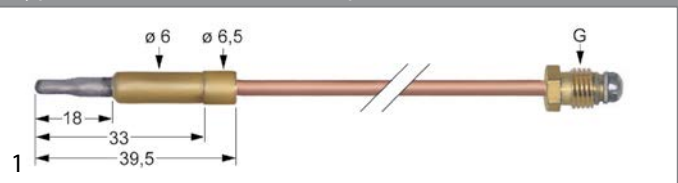

<b>GEV-Nr.</b>	102229	<b>Vergl.-Nr.</b>	33A0360
<b>Beschreibung</b>	Thermoelement M10x1 L 1000mm Stechhülse ø6,0mm		



mit Stechhülse  $\varnothing 6(6,5)$ mm

### Thermoelemente SIT

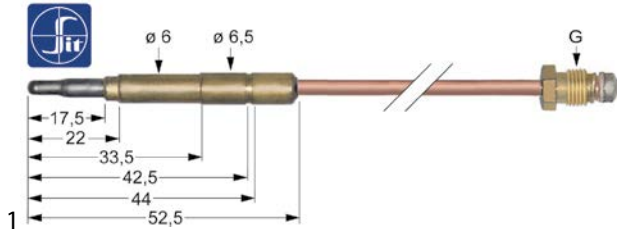

<b>GEV-Nr.</b>	107621	<b>Vergl.-Nr.</b>	33A0370
<b>Beschreibung</b>	Thermoelement SIT M10x1 L 1500mm Stechhülse $\varnothing 6,0(6,5)$ mm		

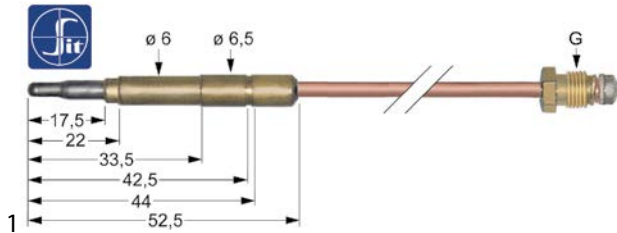

<b>GEV-Nr.</b>	107605	<b>Vergl.-Nr.</b>	33A0520 33A0890
<b>Beschreibung</b>	Thermoelement SIT M8x1 L 1500mm Stechhülse $\varnothing 6,0(6,5)$ mm		
<b>Für Modelle:</b>	071TP, 091TP, 1G1PD1G, 30CPS, 31, 31PD6, 31TC, 31TP, 32, 32TC, 32TP, 32TPV, 32V, 70CP, 71CP, 71CP2, 71PD10, 71PD15, 71TP, 72TP, 72TPGG, 90CP, 91CP		

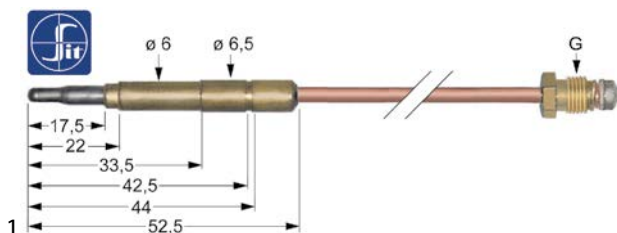

<b>GEV-Nr.</b>	107600	<b>Vergl.-Nr.</b>	33A0390
<b>Beschreibung</b>	Thermoelement SIT M8x1 L 320mm Stechhülse $\varnothing 6,0(6,5)$ mm		

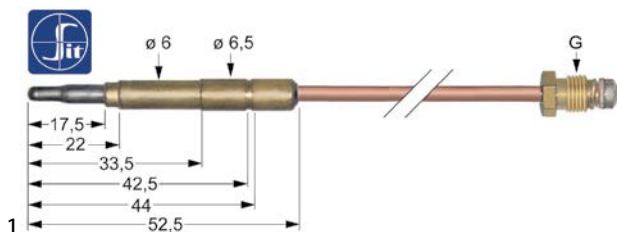

<b>GEV-Nr.</b>	107601	<b>Vergl.-Nr.</b>	33A0400 33A1060 33A1260
<b>Beschreibung</b>	Thermoelement SIT M8x1 L 600mm Stechhülse $\varnothing 6,0(6,5)$ mm		
<b>Für Modelle:</b>	030, 030FT, 030FTR, 031, 031FT, 031FTR, 031FTRL, 031TP, 032, 070D, 070DGG, 070FT, 070FTR, 0712D, 0712VA, 071D, 071DGG, 071FT, 071FTR, 071FTRL, 072D, 072DGG, 090, 090FT, 090FTR, 090GG, 091, 091FT, 091FTR, 091FTRL, 091GG, 092, 092GG, 092VA, 092VAGG, 0A0FAS, 0B0FAS, 0D0FAS, 1A0FA2, 1A0FA5, 1A0FAB, 1A0FAS, 1A0FAS2, 1A1FA2G, 1A1FA5G, 1A1FABG, 1A1FAS2G, 1A1FASG, 1B0FAS, 1B0FAS2...(Weitere Modelle finden Sie in unserem Webshop)		

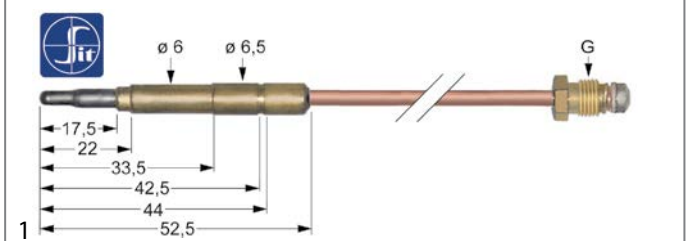

<b>GEV-Nr.</b>	107612	<b>Vergl.-Nr.</b>	32A0310
<b>Beschreibung</b>	Thermoelement SIT M9x1 L 1000mm Stechhülse $\varnothing 6,0(6,5)$ mm		

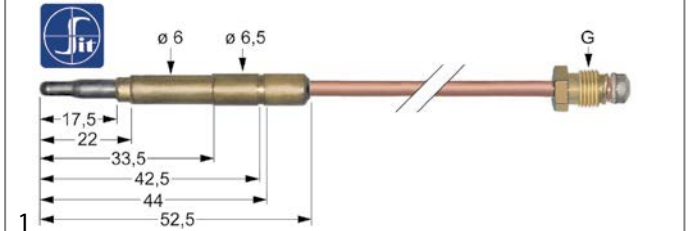

<b>GEV-Nr.</b>	107614	<b>Vergl.-Nr.</b>	33A0320
<b>Beschreibung</b>	Thermoelement SIT M9x1 L 1500mm Stechhülse $\varnothing 6,0(6,5)$ mm		

<b>Für Modelle:</b>	08WFA4G, 08WFAAG, 10WTPGE, 10WTPGV, 12WFA6G, 12WFAAG, 191FAAG, 191FABG, 191FADG, 191TPG, 1A1BR1G, 1A1BR1GA, 1A1BR2G, 1A1BR2GA, 1A1FA1G, 1A1FA2G, 1A1FA4G, 1A1FA5G, 1A1FAAG, 1A1FABG, 1A1TP0G-VERS.2002, 1B1FAS2G, 1B1FASG, 1D1BR1G, 1D1BR1GA, 1D1BR2G, 1D1BR2GA, 1D1FA1G, 1D1FA2G, 1D1FA4G, 1D1FA5G, 1D1FAAG, 1D1FABG, 1D1TP0G-VERS.2002, 1G1FA0G, 1G1FA0GV, 1G1FABG, 1G1FAPG, 1G1TP0G, 291FAG, 291TPCG, 2A1BR1G, 2A1BR1GA, 2A1BR2G, 2A1BR2GA, 2A1FA1G, 2A1FA4G, 2A1FAAG, 2A1TP3G, 2A1TP6G...(Weitere Modelle finden Sie in unserem Webshop)		
---------------------	--	--	--

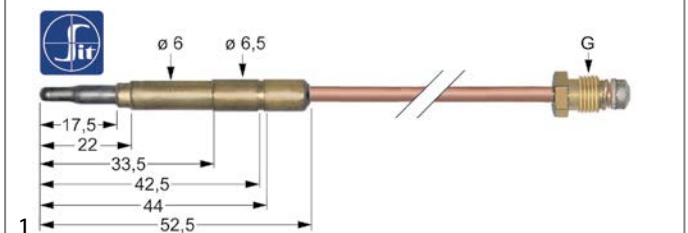

<b>GEV-Nr.</b>	107609	<b>Vergl.-Nr.</b>	33A0310 33A0340
<b>Beschreibung</b>	Thermoelement SIT M9x1 L 600mm Stechhülse $\varnothing 6,0(6,5)$ mm		

<b>Für Modelle:</b>	GR4A-ONR01, SM1L, SM1LA, SM1LAW, SM1LW, SM2L, SM2LR, SM2LW, SM2S, SM2SR, SM2SW, SM3S, SM3SR		
---------------------	---	--	--

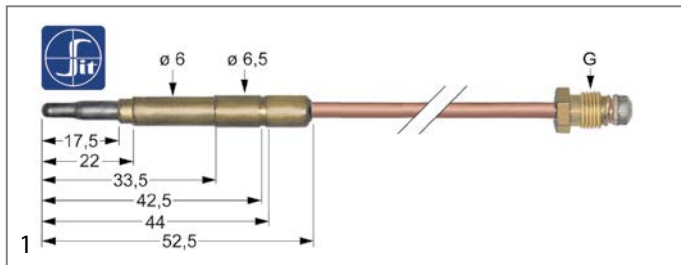

<b>GEV-Nr.</b>	107611	<b>Vergl.-Nr.</b>	33A1140 33A1190
<b>Beschreibung</b>	Thermolement SIT M9x1 L 850mm Steckhülse ø6,0(6,5)mm		
<b>Für Modelle:</b>	06WCP1GM, 070BM, 071BM, 08WCP1GM, 08WFT1GV, 08WFT2GV, 08WFT3GV, 08WFT7GV, 090BM, 091BM, 10WTPGV, 10WTPGV, 191BR1G, 191BR1GA, 191BR2G, 191BR2GA, 1A1FAS2G, 1A1FASG, 1A1PD1G, 1A1PD2G, 1A1PI1G, 1A1PI1GA, 1A1TP0G, 1D1FAS2G, 1D1FASG, 1D1PD1G, 1D1PD2G, 1D1PI1G, 1D1PI1GA, 1D1TP0G, 1G1BR1G, 291BR1G, 291BR1GA, 291BR2G, 291BR2GA, 2A1FAS2G, 2A1FASG, 2A1TPSG, 2D1FAS2G, 2D1FASG, 2D1TPSG, 31R, 3A1FASG, 3D1FASG, 6040560, 6042490, 6042500, 6043200, 712D, 712VA... (Weitere Modelle finden Sie in unserem Webshop)		

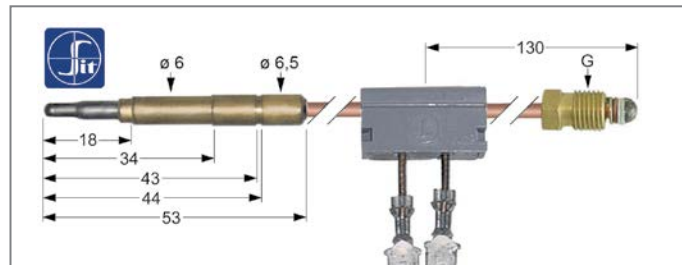

<b>GEV-Nr.</b>	107177	<b>Vergl.-Nr.</b>	33A0140
<b>Beschreibung</b>	Thermolement SIT mit Unterbrecher M9x1 L 600mm Steckhülse ø6,0mm F 6,3mm		
<b>Für Modelle:</b>	031FT04, 031FT06, 070FT04, 070FT05, 071FT04, 071FT06, 08WFT-4GV, 08WFT6GV, 090BM1G, 090FT04, 090FT05, 090FT4G, 090FT5G, 091FR3G, 091FR3GD, 091FT04, 091FT06, 0A0BMG, 0A0FT1G, 0A0FT2G, 0A0FT4G, 0A0FT5G, 0A1FR1G, 0A1FR1GD, 0A1FR1GD-VERS.2004, 0A1FR1G-VERS.2004, 0A1FR3G, 0A1FR3GD, 0B0FT1G, 0B0FT2G, 0B0FT4G, 0B0FT5G, 0B1FR1G, 0B1FR1GD, 0D0BMG, 0D0FT1G, 0D0FT2G, 0D0FT4G, 0D0FT5G, 0D1FR1G, 0D1FR1GD, 0D1FR1GD-VERS.2004, 0D1FR1G-VERS.2004, 0D1FR3G, 0D1FR3GD, 0G0FR5G, 0G0FT4G, 0G0FT5G, 0G1BR3G, 0G1FR3G... (Weitere Modelle finden Sie in unserem Webshop)		

**Einsteckthermoelemente mit Unterbrechung**

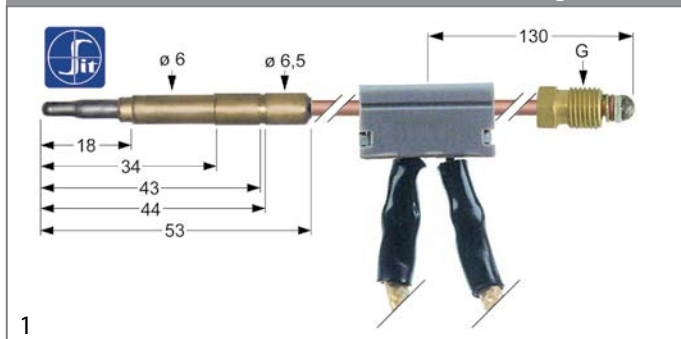

<b>GEV-Nr.</b>	107863	<b>Vergl.-Nr.</b>	33A1880 6021770 60A4060
<b>Beschreibung</b>	Thermolement SIT mit Unterbrecher M9x1 L 1000mm Steckhülse ø6,0(6,5)mm Kabel 820mm		
<b>Für Modelle:</b>	06WCP1GM, 06WFR3GD, 091CP1G, 091FR1G, 091FR1GD, 0G0FR5G, 0G1CP1G-VERS.2004, 0M0FR1G, 0M0FT4G, 0M0FT5G, 10CP1GA, 10WFR4GD, 12CP1GA, 18CP2GA, 191CP1G, 191CP2G, 191FR2G, 191FR2GD, 191PI1G, 191PI1GA, 191PI2G, 191PI2GA, 1A1FR2G, 1A1FR2GD, 1A1FR2GD-VERS.2004, 1A1FR2G-VERS.2004, 1A1FR4G, 1A1FR4GD, 1A1PI1G, 1A1PI1GA, 1D1FR2G, 1D1FR2GD, 1D1FR2GD-VERS.2004, 1D1FR2G-VERS.2004, 1D1FR4G, 1D1FR4GD, 1D1PI1G, 1D1PI1GA, 1G0FR6G, 1G1CP1G-VERS.2004, 1G1CP2G-VERS.2004, 1G1FR4G, 1G1FR4GD, 1G1PI1G, 1M0FR2G, 1M0FT4G, 1M0FT5G, 1M0FT6G, 291FAGF, 2M0FT4G... (Weitere Modelle finden Sie in unserem Webshop)		

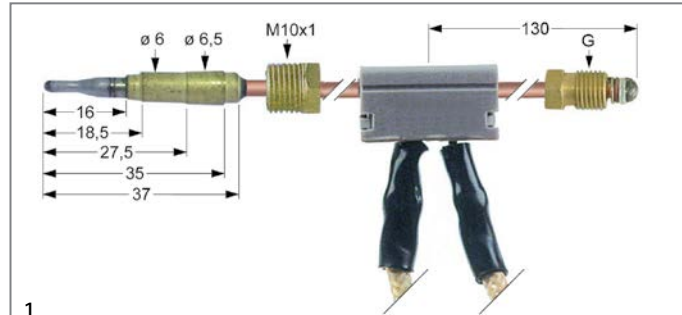

<b>GEV-Nr.</b>	102252	<b>Vergl.-Nr.</b>	33A1410 6021780
<b>Beschreibung</b>	Thermolement mit Unterbrecher M9x1 L 600mm Steckhülse ø6,0mm Kabel 650mm		
<b>Für Modelle:</b>	06WFR3GD, 090BM1G, 090FT4G, 090FT5G, 091FR1G, 091FR1GD, 091FR3G, 091FR3GD, 0A0BMG, 0A1FR1G, 0A1FR1GD, 0A1FR1GD-VERS.2004, 0A1FR1G-VERS.2004, 0B1FR1G, 0B1FR1GD, 0D0BMG, 0D1FR1G, 0D1FR1GD, 0D1FR1GD-VERS.2004, 0D1FR1G-VERS.2004, 0G0FT4G, 0G0FT4G-VERS.032008, 0G0FT5G, 0G0FT5G-VERS.032008, 0G1BR3G, 0G1FR3G, 0G1FR3GD, 0G1FR7G, 10WFR4GD, 190BM2G, 190FT15G, 190FT42G, 190FT4G, 190FT6G, 191FR2G, 191FR2GD, 191FR4G, 191FR4GD, 1A0BMG, 1A1FR2G, 1A1FR2GD, 1A1FR2GD-VERS.2004, 1A1FR2G-VERS.2004, 1A1FR4G, 1A1FR4GD, 1D0BMG, 1D1FR2G, 1D1FR2GD, 1D1FR2GD-VERS.2004, 1D1FR2G-VERS.2004... (Weitere Modelle finden Sie in unserem Webshop)		

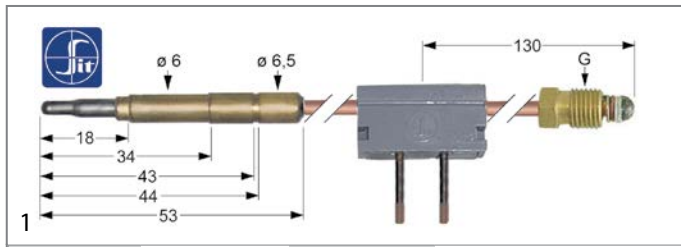

<b>GEV-Nr.</b>	107164	<b>Vergl.-Nr.</b>	33A0900
<b>Beschreibung</b>	Thermolement SIT mit Unterbrecher M9x1 L 1000mm Steckhülse ø6,0(6,5)mm Lötanschluss		
<b>Für Modelle:</b>	0M0FR1G, 0M0FT4G, 0M0FT5G, 191PI1G, 191PI1GA, 191PI2G, 191PI-2GA, 1A1PI1G, 1A1PI1GA, 1D1PI1G, 1D1PI1GA, 1G1PI1G, 1M0FR2G, 1M0FT4G, 1M0FT5G, 1M0FT6G, 2M0FT4G, 2M0FT5G, 2M0FT6G, 30F, 30F1, 30F1B, 30FS, 30FS2, 30FS2B, 31PI6, 70F, 70F1, 70F1B, 71F, 71F2, 71F2B, 71PI10, 71PI10A, 90F110B, 91F210, 91F210B, 91F223B, 91PI10, 91PI10A, FC101, FC241, FC241G, FC61, FCV101, FCV101DM, FCV101DS, FCV141, FCV141DM, FCV141DS... (Weitere Modelle finden Sie in unserem Webshop)		

**Verlängerungen**





<b>GEV-Nr.</b>	102013	<b>Vergl.-Nr.</b>	33A0130 33A1270
<b>Beschreibung</b>	Thermolementverlängerung Gewinde M9x1 L 500mm		
<b>Für Modelle:</b>	031FT04, 031FT06, 1A1BR1G, 1A1BR1GA, 1A1BR2G, 1A1BR2GA, 1D1BR1G, 1D1BR1GA, 1D1BR2G, 1D1BR2GA, 2A1BR1G, 2A1BR1GA, 2A1BR2G, 2A1BR2GA, 2D1BR1G, 2D1BR1GA, 2D1BR2G, 2D1BR2GA		
<b>Zubehör für</b>	102013		

<b>GEV-Nr.</b>	101260	<b>Vergl.-Nr.</b>	—
<b>Beschreibung</b>	Thermolementverschraubung Gewinde M8x1 VPE 1 Stück		
<b>GEV-Nr.</b>	101261	<b>Vergl.-Nr.</b>	—
<b>Beschreibung</b>	Thermolementverschraubung Gewinde M9x1 VPE 1 Stück		

Tabellenfortsetzung auf der nächsten Seite



<b>Zubehör für</b>	102013		
	<b>GEV-Nr.</b>	101262	<b>Vergl.-Nr.</b> —
Thermoelementverschraubung Gewinde M10x1 VPE 1 Stück			
	<b>GEV-Nr.</b>	101263	<b>Vergl.-Nr.</b> —
Thermoelementverschraubung Gewinde ASA 11/32 VPE 1 Stück			

## Gasbrenner

### Stabbrenner

#### Stabbrenner



<b>GEV-Nr.</b>	105502	<b>Vergl.-Nr.</b>	34A1690 34A1690-2
<b>Beschreibung</b>	Stabbrenner ø 50mm B 8mm H mm L 424mm HeiBluftofen		
<b>Für Modelle:</b>	FC101, FCV101, FCV101-CSA, FCV101DM, FCV101DM-CSA, FCV101DS, FCV101DS-CSA		



<b>GEV-Nr.</b>	107843	<b>Vergl.-Nr.</b>	34A0500
<b>Beschreibung</b>	Stabbrenner ø 50mm L 550mm FB 57mm FL 57mm 15kW Kombi-dämpfer		
<b>Für Modelle:</b>	FC241G, FCV241G, FCV241G-CSA, FCV241GDM, FCV241GDM-CSA, FCV241GDS, FCV241GDS-CSA, FCV401DM, FCV401DM-CSA		

### Gebälsebrenner



<b>GEV-Nr.</b>	108153	<b>Vergl.-Nr.</b>	6300748
<b>Beschreibung</b>	Brennergebläse Kombidämpfer 230V 65W LA 50mm NRG118/0800-3612-030204		
<b>Für Modelle:</b>	BX101G, BX101G-VERS.122013, BX122G, BX122G-VERS.122013, BX61G, BX61G-VERS.122013, BX82G, BX82G-VERS.122013, FX101G1, FX101G1R, FX101G2, FX101G2C, FX101G2C-VERS.032014, FX101G2R, FX101G2R-VERS.032014, FX101G2-VERS.032014, FX101G3, FX101G3C, FX101G3C-VERS.022014, FX101G3R, FX101G3R-VERS.022014, FX101G3-VERS.022014, FX10G2CR, FX10G2CR-VERS.032014, FX10G3CR, FX10G3CR-VERS.022014, FX122G1, FX122G2, FX122G2C, FX122G2T, FX122G2T-VERS.032014, FX122G3, FX122G3C, FX122G3T, FX122G3T-VERS.022014, FX12G3CT, FX12G3CT-VERS.022014, FX201G2, FX201G2P, FX201G2P-VERS.032014, FX201G2-VERS.032014, FX201G3P, FX201G3-VERS.022014, FX202G2, FX202G2-VERS.032014, FX202G3, FX202G3-VERS.022014, FX61G1, FX61G1R, FX61G2...(Weitere Modelle finden Sie in unserem Webshop)		

## Zubehör

### Dichtungen



<b>GEV-Nr.</b>	109208	<b>Vergl.-Nr.</b>	36E3770
<b>Beschreibung</b>	Dichtung L 89mm B 89mm D1 ø 76mm Materialstärke 1mm Loch ø 6mm LA 69mm für Brennkammer Kombidämpfer		
<b>Für Modelle:</b>	FC1011G, FC1221G, FC611G, FM1011G1, FM1011G1-VERS.2006, FM1011G2, FM1011G2-VERS.2006, FM1011G3, FM1011G3-VERS.2006, FM1221G1, FM1221G1-VERS.2006, FM1221G2, FM1221G2-VERS.2006, FM1221G3, FM1221G3-VERS.2006, FM2011G2-VERS.2006, FM2011G3-VERS.2006, FM2021G1, FM2021G2, FM2021G2-VERS.2006, FM2021G3, FM2021G3-VERS.2006, FM611G1, FM611G1-VERS.2006, FM611G2, FM611G2-VERS.2006, FM611G3, FM611G3-VERS.2006, FM721G1, FM721G1-VERS.2006, FM721G2, FM721G2-VERS.2006, FM721G3, FM721G3-VERS.2006		



<b>GEV-Nr.</b>	109207	<b>Vergl.-Nr.</b>	36E3390
<b>Beschreibung</b>	Dichtung L 89mm B 89mm ø 76mm Materialstärke 3mm Loch ø 4mm LA 69mm für Brennkammer Kombidämpfer		
<b>Für Modelle:</b>	FC1011G, FC1221G, FC611G, FM1011G1, FM1011G1-VERS.2006, FM1011G2, FM1011G2-VERS.2006, FM1011G3, FM1011G3-VERS.2006, FM1221G1, FM1221G1-VERS.2006, FM1221G2, FM1221G2-VERS.2006, FM1221G3, FM1221G3-VERS.2006, FM2011G2-VERS.2006, FM2011G3-VERS.2006, FM2021G1, FM2021G2, FM2021G2-VERS.2006, FM2021G3, FM2021G3-VERS.2006, FM611G1, FM611G1-VERS.2006, FM611G2, FM611G2-VERS.2006, FM611G3, FM611G3-VERS.2006, FM721G1, FM721G1-VERS.2006, FM721G2, FM721G2-VERS.2006, FM721G3, FM721G3-VERS.2006		

## Gasdüsen

### Hauptdüsen

#### Gasdüsen M8x1



<b>GEV-Nr.</b>	104737	<b>Vergl.-Nr.</b>	3032930
<b>Beschreibung</b>	Gasdüse Gewinde M8x1 SW 10 Bohrung ø 0.5mm		
<b>Für Modelle:</b>	BX61E, BX61E-VERS.122013, BX61G, BX61G-VERS.122013, FC611E, FC611G, FM1221E1-VERS.2006, FM1221E2-VERS.2006, FM1221E3-VERS.2006, FM1221G1-VERS.2006, FM1221G2-VERS.2006, FM1221G3-VERS.2006, FM2011E2-VERS.2006, FM2011E3-VERS.2006, FM2011G3-VERS.2006, FM2021E2-VERS.2006, FM2021E3-VERS.2006, FM2021G2-VERS.2006, FM2021G3-VERS.2006, FM611E1, FM611E1-VERS.2006, FM611E2, FM611E2-VERS.2006, FM611E3, FM611E3-VERS.2006, FM611G1, FM611G1-VERS.2006, FM611G2, FM611G2-VERS.2006, FM611G3, FM611G3-VERS.2006, FX61E1, FX61E1R, FX61E2, FX61E2C, FX61E2CR, FX61E2CR-VERS.032014, FX61E2C-VERS.032014, FX61E2R, FX61E2R-VERS.032014, FX61E3, FX61E3C, FX61E3CR, FX61E3CR-VERS.022014, FX61E3C-VERS.022014, FX61E3R, FX61E3R-VERS.022014, FX61E3-VERS.022014...(Weitere Modelle finden Sie in unserem Webshop)		





			
1			
<b>GEV-Nr.</b>	104736	<b>Vergl.-Nr.</b>	3032920
<b>Beschreibung</b>	Gasdüse Gewinde M8x1 SW 10 Bohrung ø 1.85mm		
<b>Für Modelle:</b>	FC1011E, FC1011G, FC1221E, FC1221G, FC611E, FC611G, FM1011E1, FM1011E1-VERS.2006, FM1011E2, FM1011E2-VERS.2006, FM1011E3, FM1011E3-VERS.2006, FM1011G1, FM1011G1-VERS.2006, FM1011G2, FM1011G2-VERS.2006, FM1011G3, FM1011G3-VERS.2006, FM1221E1-VERS.2006, FM1221E2-VERS.2006, FM1221E3, FM1221E3-VERS.2006, FM1221G1-VERS.2006, FM1221G2-VERS.2006, FM1221G3, FM1221G3-VERS.2006, FM2011E2-VERS.2006, FM2011E3-VERS.2006, FM2011G2-VERS.2006, FM2011G3-VERS.2006, FM611E1, FM611E1-VERS.2006, FM611E2, FM611E2-VERS.2006, FM611E3, FM611E3-VERS.2006, FM611G1, FM611G1-VERS.2006, FM611G2, FM611G2-VERS.2006, FM611G3, FM611G3-VERS.2006, FM721E3, FM721G3		

			
1			
<b>GEV-Nr.</b>	106452	<b>Vergl.-Nr.</b>	33T3760
<b>Beschreibung</b>	Gasdüse Gewinde M10x1 SW 12 Bohrung ø 1.35mm		

			
1			
<b>GEV-Nr.</b>	101961	<b>Vergl.-Nr.</b>	33T3490
<b>Beschreibung</b>	Gasdüse Gewinde M10x1 SW 12 Bohrung ø 1.55mm		

**Gasdüsen M10x1**

			
1			
<b>GEV-Nr.</b>	101975	<b>Vergl.-Nr.</b>	33T3980
<b>Beschreibung</b>	Gasdüse Gewinde M10x1 Bohrung ø 1.55mm L 30mm SW 12		

			
1			
<b>GEV-Nr.</b>	106475	<b>Vergl.-Nr.</b>	33T1820
<b>Beschreibung</b>	Gasdüse Gewinde M10x1 SW 12 Bohrung ø 2.2mm		

			
1			
<b>GEV-Nr.</b>	100816	<b>Vergl.-Nr.</b>	33T3900
<b>Beschreibung</b>	Gasdüse Gewinde M10x1 Bohrung ø 1.5mm SW 12		

			
1			
<b>GEV-Nr.</b>	106469	<b>Vergl.-Nr.</b>	33T1850
<b>Beschreibung</b>	Gasdüse Gewinde M10x1 SW 12 Bohrung ø 2.5mm		

			
1			
<b>GEV-Nr.</b>	106402	<b>Vergl.-Nr.</b>	33T0710
<b>Beschreibung</b>	Gasdüse Gewinde M10x1 Bohrung ø 1.75mm L 30mm SW 12		

			
1			
<b>GEV-Nr.</b>	106474	<b>Vergl.-Nr.</b>	33T1780
<b>Beschreibung</b>	Gasdüse Gewinde M10x1 SW 12 Bohrung ø 2mm		

			
1			
<b>GEV-Nr.</b>	106403	<b>Vergl.-Nr.</b>	33T1920
<b>Beschreibung</b>	Gasdüse Gewinde M10x1 Bohrung ø 1.9mm L 30mm SW 12		

			
1			
<b>GEV-Nr.</b>	100387	<b>Vergl.-Nr.</b>	33T1670
<b>Beschreibung</b>	Gasdüse Gewinde M10x1 SW 12 Bohrung ø 1.45mm		

			
1			
<b>GEV-Nr.</b>	106405	<b>Vergl.-Nr.</b>	33T3360
<b>Beschreibung</b>	Gasdüse Gewinde M10x1 Bohrung ø 2mm L 30mm SW 12		

			
1			
<b>GEV-Nr.</b>	106408	<b>Vergl.-Nr.</b>	33T3370
<b>Beschreibung</b>	Gasdüse Gewinde M10x1 Bohrung ø 3mm L 30mm SW 12		





			
1			
<b>GEV-Nr.</b>	100384	<b>Vergl.-Nr.</b>	33T0130
<b>Beschreibung</b>	Gasdüse Gewinde M10x1 SW 12 Bohrung ø 1.8mm		

## Zündbrennerdüsen

### Zündbrennerdüsen SIT

#### Serie 100

			
1			
<b>GEV-Nr.</b>	100246	<b>Vergl.-Nr.</b>	33T0410
<b>Beschreibung</b>	Zündbrennerdüse Erdgas Bohrung ø 0.35mm VPE 1 Stück Gewinde M8x0,75		

			
1			
<b>GEV-Nr.</b>	102972	<b>Vergl.-Nr.</b>	33T3130
<b>Beschreibung</b>	Zündbrennerdüse Erdgas Kennzahl 40 Bohrung ø 0.4mm VPE 1 Stück		

			
1			
<b>GEV-Nr.</b>	107171	<b>Vergl.-Nr.</b>	33T0340
<b>Beschreibung</b>	Zündbrennerdüse SIT Erdgas/Flüssiggas Bohrung ø 0.25mm VPE 1 Stück		

#### Serie 160

			
1			
<b>GEV-Nr.</b>	107173	<b>Vergl.-Nr.</b>	33T4310
<b>Beschreibung</b>	Zündbrennerdüse SIT Erdgas Kennzahl 35 VPE 1 Stück passend für Serie 160 Düse ø 0.35mm		

			
1			
<b>GEV-Nr.</b>	107174	<b>Vergl.-Nr.</b>	33T2870
<b>Beschreibung</b>	Zündbrennerdüse SIT Erdgas Kennzahl 41 VPE 1 Stück		

			
1			
<b>GEV-Nr.</b>	107649	<b>Vergl.-Nr.</b>	33T4300
<b>Beschreibung</b>	Zündbrennerdüse SIT Flüssiggas Kennzahl 20 VPE 1 Stück		



			
1			
<b>GEV-Nr.</b>	107650	<b>Vergl.-Nr.</b>	33T3310
<b>Beschreibung</b>	Zündbrennerdüse SIT Flüssiggas Kennzahl 30 VPE 1 Stück		

## Verschraubungen

### Schneidringe

			
1			
<b>GEV-Nr.</b>	101278	<b>Vergl.-Nr.</b>	36Q0080
<b>Beschreibung</b>	Schneidring für Rohr-ø 10mm VPE 1 Stück		

<b>Für Modelle:</b>	030, 031, 032, 04WFAAV, 06WCP1GM, 06WFR3GD, 070BM, 070BME, 071BM, 071BME, 08WCP1GM, 08WFA4E, 08WFA4G, 08WFAAE, 08WFAAG, 08WFAAV, 08WFT1GV, 08WFT2GV, 08WFT3GV, 08WFT4GV, 08WFT6GV, 08WFT7GV, 08WGRGV, 090BM, 090BM1G, 090BME, 090FAA, 090FAVA, 090FT1G, 090FT2G, 090FT4G, 090FT5G, 090FT7G, 090GRG, 091BM, 091BME, 091CP1G, 091FR1EX, 091FR3G, 091FR3GD, 091FR7GS, 091FR7GX, 0A0BMG, 0A0FA1, 0A0FA4, 0A0FAA, 0A0FT1G, 0A0FT2G, 0A0FT4G, 0A0FT5G...(Weitere Modelle finden Sie in unserem Webshop)		
---------------------	---	--	--

<b>Zubehör für</b>	101278			
	<b>GEV-Nr.</b>	100943	<b>Vergl.-Nr.</b>	—
Überwurfmutter Gewinde M17x1 Rohr ø 10mm				
	<b>GEV-Nr.</b>	101300	<b>Vergl.-Nr.</b>	36Q0830
Überwurfmutter Gewinde M16x1,5 Rohr ø 10mm				
	<b>GEV-Nr.</b>	101478	<b>Vergl.-Nr.</b>	—
Überwurfmutter Gewinde 3/8\" für Rohr ø 10mm				

			
1			
<b>GEV-Nr.</b>	101273	<b>Vergl.-Nr.</b>	36Q0030 36Q0200 36Q1590

<b>Beschreibung</b>	Schneidring für Rohr-ø 12mm L 9.5mm Messing VPE 1 Stück passend für universal		
<b>Zubehör für</b>	101273		

	<b>GEV-Nr.</b>	100944	<b>Vergl.-Nr.</b>	36Q0040
Überwurfmutter Gewinde M18x1,5 für Rohr ø 12mm				



	<b>GEV-Nr.</b>	101276	<b>Vergl.-Nr.</b>	36Q0710
Überwurfschraube Gewinde 3/8\" Rohr ø 12mm VPE 1 Stück				





			
1			
<b>GEV-Nr.</b>	101428	<b>Vergl.-Nr.</b>	36Q0310
<b>Beschreibung</b>	Schneidring für Rohr-ø 14mm L 9mm VPE 1 Stück AD ø 16mm		
<b>Für Modelle:</b>	04WFAAV, 08WFAAE, 08WFAAG, 08WFAAV, 12WFAAE, 12WFAAG, 191BR1G, 191BR1GA, 191BR2G, 191BR2GA, 1A1BR1G, 1A1BR1GA, 1A1BR2G, 1A1BR2GA, 1D1BR1G, 1D1BR1GA, 1D1BR2G, 1D1BR2GA, 291BR1G, 291BR1GA, 291BR2G, 291BR2GA, 2A1BR1G, 2A1BR1GA, 2A1BR2G, 2A1BR2GA, 2D1BR1G, 2D1BR1GA, 2D1BR2G, 2D1BR2GA, FC241, FCV141, FCV141DM, FCV141DS, FCV241, FCV241DM, FCV241DS		

			
1			
<b>GEV-Nr.</b>	100870	<b>Vergl.-Nr.</b>	36Q1040
<b>Beschreibung</b>	Schneidring für Rohr-ø 4mm VPE 1 Stück passend für Serie 160 für Zündbrenner		
<b>Für Modelle:</b>	04WFAAV, 06WCP1GM, 06WFR3GD, 08WFA4E, 08WFA4G, 08WFAAE, 08WFAAG, 08WFAAV, 08WFT1GV, 08WFT2GV, 08WFT3GV, 08WFT4GV, 08WFT6GV, 08WFT7GV, 08WGRGV, 090BM1G, 090FAA, 090FAVA, 090FT1G, 090FT2G, 090FT4G, 090FT5G, 090FT7G, 090GRG, 091FR1G, 091FR1GD, 091FR3G, 091FR3GD, 0A0FA1, 0A0FA4, 0A0FAA, 0A0FT1G, 0A0FT2G, 0A0FT4G, 0A0FT5G, 0A0GRG, 0A1CP1G, 0B0FT1G, 0B0FT2G, 0B0FT4G, 0B0FT5G, 0B1CP1G, 0D0FA1, 0D0FA4, 0D0FAA, 0D0FT1G, 0D0FT2G, 0D0FT4G, 0D0FT5G, 0D0GRG...(Weitere Modelle finden Sie in unserem Webshop)		

			
1			
<b>GEV-Nr.</b>	101286	<b>Vergl.-Nr.</b>	36Q0020
<b>Beschreibung</b>	Schneidring ID ø 6mm VPE 1 Stück		
<b>Für Modelle:</b>	04WFAAV, 08WFA4E, 08WFA4G, 08WFAAE, 08WFAAG, 08WFAAV, 090FAA, 0A0FA1, 0A0FA4, 0A0FAA, 0D0FA1, 0D0FA4, 0D0FAA, 0G0FA0, 12WFA6E, 12WFA6G, 12WFAAA, 12WFAAE, 12WFAAG, 12WFAAN, 190FA, 190FAA, 190FAB, 190FAD, 191FAAE, 191FAAG, 191FABG, 191FADG, 191FAE, 191FAG, 1A0FA1, 1A0FA2, 1A0FA4, 1A0FA5, 1A0FAA, 1A0FAB, 1A1FA1G, 1A1FA2G, 1A1FA4G, 1A1FA5G, 1A1FAAG, 1A1FABG, 1D0FA1, 1D0FA2, 1D0FA4, 1D0FA5, 1D0FAA, 1D0FAB, 1D1FA1G, 1D1FA2G...(Weitere Modelle finden Sie in unserem Webshop)		
<b>Zubehör für</b>	101286		
		<b>GEV-Nr.</b>	100909
		<b>Vergl.-Nr.</b>	36Q0060
	Überwurfschraube Gewinde M10x1 für Rohr-ø 6mm VPE 1 Stück		
		<b>GEV-Nr.</b>	101464
		<b>Vergl.-Nr.</b>	—
	Überwurfmutter Gewinde M12x1 für Rohr ø 6mm		

<b>Überwurfmütern</b>			
			
1			
<b>GEV-Nr.</b>	107892	<b>Vergl.-Nr.</b>	36Q0210
<b>Beschreibung</b>	Überwurfmutter Gewinde M20x1,5 für Rohr-ø 14 SW 25		
<b>Für Modelle:</b>	04WFAAV, 08WFA4E, 08WFA4G, 08WFAAE, 08WFAAG, 08WFAAV, 12WFA6E, 12WFA6G, 12WFAAA, 12WFAAE, 12WFAAG, 12WFAAN, 191BR2G, 1A1BR1G, 1A1BR1GA, 1A1BR2G, 1A1BR2GA, 1D1BR1G, 1D1BR1GA, 1D1BR2G, 1D1BR2GA, 2A1BR1G, 2A1BR1GA, 2A1BR2G, 2A1BR2GA, 2D1BR1G, 2D1BR1GA, 2D1BR2G, 2D1BR2GA, 71AR, 71RA, 91AR, 91RA, FC241, FCV141, FCV141DM, FCV141DS, FCV241, FCV241DM, FCV241DS		

<b>Überwurfschrauben</b>			
			
1			
<b>GEV-Nr.</b>	100908	<b>Vergl.-Nr.</b>	36Q1000
<b>Beschreibung</b>	Überwurfschraube Gewinde M10x1 für Rohr-ø 4mm VPE 1 Stück		
<b>Für Modelle:</b>	04WFAAV, 06WCP1GM, 06WFR3GD, 08WFA4E, 08WFA4G, 08WFAAE, 08WFAAG, 08WFAAV, 08WFT1GV, 08WFT2GV, 08WFT3GV, 08WFT4GV, 08WFT6GV, 08WFT7GV, 08WGRGV, 090BM1G, 090FAA, 090FAVA, 090FT1G, 090FT2G, 090FT4G, 090FT5G, 090FT7G, 090GRG, 091FR1G, 091FR1GD, 091FR3G, 091FR3GD, 0A0FA1, 0A0FA4, 0A0FAA, 0A0FT1G, 0A0FT2G, 0A0FT4G, 0A0FT5G, 0A0GRG, 0A1CP1G, 0B0FT1G, 0B0FT2G, 0B0FT4G, 0B0FT5G, 0B1CP1G, 0D0FA1, 0D0FA4, 0D0FAA, 0D0FT1G, 0D0FT2G, 0D0FT4G, 0D0FT5G, 0D0GRG...(Weitere Modelle finden Sie in unserem Webshop)		
<b>Zubehör für</b>	100908		
		<b>GEV-Nr.</b>	100897
		<b>Vergl.-Nr.</b>	—
	Schneidring für Rohr-ø 4mm VPE 1 Stück für Zündbrenner		
		<b>GEV-Nr.</b>	101246
		<b>Vergl.-Nr.</b>	—
	Schneidring für Rohr-ø 4mm VPE 1 Stück		
		<b>GEV-Nr.</b>	101280
		<b>Vergl.-Nr.</b>	—
	Schneidring für Rohr-ø 4mm VPE 1 Stück		
		<b>GEV-Nr.</b>	101282
		<b>Vergl.-Nr.</b>	—
	Schneidring für Rohr-ø 4mm L 7.4mm VPE 1 Stück		

			
1			
<b>GEV-Nr.</b>	100909	<b>Vergl.-Nr.</b>	36Q0060
<b>Beschreibung</b>	Überwurfschraube Gewinde M10x1 für Rohr-ø 6mm VPE 1 Stück		
<b>Für Modelle:</b>	04WFAAV, 08WFA4E, 08WFA4G, 08WFAAE, 08WFAAG, 08WFAAV, 090FAA, 0A0FA1, 0A0FA4, 0A0FAA, 0D0FA1, 0D0FA4, 0D0FAA, 0G0FA0, 12WFA6E, 12WFA6G, 12WFAAA, 12WFAAE, 12WFAAG, 12WFAAN, 190FA, 190FAA, 190FAB, 190FAD, 191FAAE, 191FAAG, 191FABG, 191FADG, 191FAE, 191FAG, 1A0FA1, 1A0FA2, 1A0FA4, 1A0FA5, 1A0FAA, 1A0FAB, 1A1FA1G, 1A1FA2G, 1A1FA4G, 1A1FA5G, 1A1FAAG, 1A1FABG, 1D0FA1, 1D0FA2, 1D0FA4, 1D0FA5, 1D0FAA, 1D0FAB, 1D1FA1G, 1D1FA2G...(Weitere Modelle finden Sie in unserem Webshop)		
<b>Zubehör für</b>	100909		
		<b>GEV-Nr.</b>	100898
		<b>Vergl.-Nr.</b>	—
	Schneidring für Rohr-ø 6mm VPE 1 Stück für Zündbrenner		
		<b>GEV-Nr.</b>	101286
		<b>Vergl.-Nr.</b>	36Q0020
	Schneidring ID ø 6mm VPE 1 Stück		
		<b>GEV-Nr.</b>	101287
		<b>Vergl.-Nr.</b>	36Q0150
	Schneidring für Rohr-ø 6mm VPE 1 Stück		
		<b>GEV-Nr.</b>	101288
		<b>Vergl.-Nr.</b>	—
	Schneidring für Rohr-ø 6mm L 6mm Aluminium VPE 1 Stück AD ø 8,5mm		



1

<b>GEV-Nr.</b>	100906	<b>Vergl.-Nr.</b>	36Q1050
<b>Beschreibung</b>	Verschraubung Gewinde M10x1 für Zündelektrode Messing VPE 1 Stück SW 10		
<b>Für Modelle:</b>	08WGRGV, 090GRG, 0A0GRG, 0A1CP1G, 0B1CP1G, 0D0GRG, 0D1CP1G, 190GRG, 191CP1G, 1A0GRG, 1A1CP1G, 1A1CP2G, 1A1PD1G, 1A1PD2G, 1A1PI1G, 1A1PI1GA, 1D0GRG, 1D1CP1G, 1D1CP2G, 1D1PD1G, 1D1PD2G, 1D1PI1G, 1D1PI1GA, 1G0GRG, 6042120-08WGRGV		



1

<b>GEV-Nr.</b>	696788	<b>Vergl.-Nr.</b>	3120620 3215240
<b>Beschreibung</b>	Ablaufrohr Gewinde 1 1/2" IG T-Stück Kunststoff ID ø 37mm AD ø 40mm für Kombidämpfer		
<b>Für Modelle:</b>	BX101E, BX101E-VERS.122013, BX101G, BX101G-VERS.122013, BX61E, BX61E-VERS.122013, BX61G, BX61G-VERS.122013, FX101E1, FX101E1R, FX101E2, FX101E2C, FX101E2C-VERS.032014, FX101E2R, FX101E2R-VERS.032014, FX101E2-VERS.032014, FX101E3, FX101E3C, FX101E3C-VERS.022014, FX101E3R, FX101E3R-VERS.022014, FX101E3-VERS.022014, FX101G1, FX101G1R, FX101G2, FX101G2C, FX101G2C-VERS.032014, FX101G2R, FX101G2R-VERS.032014, FX101G2-VERS.032014, FX101G3, FX101G3C, FX101G3C-VERS.022014, FX101G3R, FX101G3R-VERS.022014, FX101G3-VERS.022014, FX10E2CR, FX10E2CR-VERS.032014, FX10E3CR, FX10E3CR-VERS.022014, FX10G2CR, FX10G2CR-VERS.032014, FX10G3CR, FX10G3CR-VERS.022014, FX61E1, FX61E1R, FX61E2, FX61E2C, FX61E2CR, FX61E2CR-VERS.032014...(Weitere Modelle finden Sie in unserem Webshop)		

## Gerätespezifische Bauteile

### für Heißluftöfen/Kombidämpfer

#### Ablaufventile



1

<b>GEV-Nr.</b>	696790	<b>Vergl.-Nr.</b>	30Z3011
<b>Beschreibung</b>	Ablaufrohr Gewinde 1 1/2" IG gewinkelt 90° Kunststoff ID ø 37mm AD ø 40mm für Kombidämpfer		
<b>Für Modelle:</b>	FC1011E, FC1011G, FC1221E, FC1221G, FC611E, FC611G, FM1011E1-VERS.2006, FM1011E2-VERS.2006, FM1011E3-VERS.2006, FM1011G1-VERS.2006, FM1011G2-VERS.2006, FM1011G3-VERS.2006, FM1221E1-VERS.2006, FM1221E2-VERS.2006, FM1221E3-VERS.2006, FM1221G1-VERS.2006, FM1221G2-VERS.2006, FM1221G3-VERS.2006, FM2011E2-VERS.2006, FM2011E3-VERS.2006, FM2011G2-VERS.2006, FM2011G3-VERS.2006, FM2021E2-VERS.2006, FM2021E3-VERS.2006, FM2021G2-VERS.2006, FM2021G3-VERS.2006, FM611E1-VERS.2006, FM611E2-VERS.2006, FM611E3-VERS.2006, FM611G1-VERS.2006, FM611G2-VERS.2006, FM611G3-VERS.2006, FM721E1-VERS.2006, FM721E2-VERS.2006, FM721E3-VERS.2006, FM721G1-VERS.2006, FM721G2-VERS.2006, FM721G3-VERS.2006		



1

<b>GEV-Nr.</b>	696773	<b>Vergl.-Nr.</b>	6300833
<b>Beschreibung</b>	Ablaufventil Set für Kombidämpfer Schlauch ø 8mm		
<b>Für Modelle:</b>	FX101E3, FX101E3C, FX101E3C-VERS.022014, FX101E3R, FX101E3R-VERS.022014, FX101E3-VERS.022014, FX101G3, FX101G3C, FX101G3C-VERS.022014, FX101G3R, FX101G3R-VERS.022014, FX101G3-VERS.022014, FX10E3CR, FX10E3CR-VERS.022014, FX10G3CR, FX10G3CR-VERS.022014, FX122E3, FX122E3C, FX122E3T, FX122E3T-VERS.022014, FX122G3, FX122G3C, FX122G3T, FX122G3T-VERS.022014, FX12E3CT, FX12E3CT-VERS.022014, FX12G3CT, FX12G3CT-VERS.022014, FX201E3, FX201E3P, FX201E3P-VERS.022014, FX201E3-VERS.022014, FX201G3P, FX201G3-VERS.022014, FX202E3, FX202E3-230V-3-50Hz-60Hz, FX202E3-230V-3-50Hz-60Hz-VERS.022014, FX202E3-VERS.022014, FX202G3, FX202G3-VERS.022014, FX61E3, FX61E3C, FX61E3CR, FX61E3CR-VERS.022014, FX61E3C-VERS.022014, FX61E3R, FX61E3R-VERS.022014, FX61E3-VERS.022014, FX61G3, FX61G3C...(Weitere Modelle finden Sie in unserem Webshop)		



Buchsen



1

<b>GEV-Nr.</b>	692880	<b>Vergl.-Nr.</b>	36A3400 36A3401
<b>Beschreibung</b>	Buchse ID ø 34mm AD ø 60mm L 20mm Gewinde 1 1/4" AG		
<b>Für Modelle:</b>	BX101E, BX101E-VERS.122013, BX101G, BX101G-VERS.122013, BX122E, BX122E-VERS.122013, BX122G, BX122G-VERS.122013, BX61E, BX61E-VERS.122013, BX61G, BX61G-VERS.122013, BX82E, BX82E-VERS.122013, BX82G, BX82G-VERS.122013, FC101, FC1011E, FC1011G, FC101E, FC1221E, FC1221G, FC241, FC241E, FC241G, FC61, FC611E, FC611G, FC61E, FCV101, FCV101-CSA, FCV101DM, FCV101DM-CSA, FCV101DS, FCV101DS-CSA, FCV101E, FCV101EDM, FCV101EDM-UL, FCV101EDS, FCV101EDS-UL, FCV101E-UL, FCV141, FCV141-CSA, FCV141DM, FCV141DM-CSA, FCV141DS, FCV141DS-CSA, FCV141E, FCV141EDM, FCV141EDS...(Weitere Modelle finden Sie in unserem Webshop)		

Dampfleitungen



1

<b>GEV-Nr.</b>	691639	<b>Vergl.-Nr.</b>	33Q6230
<b>Beschreibung</b>	Buchse Edelstahl L 31mm ID ø 33mm AD ø 35mm		
<b>Für Modelle:</b>	FC101, FC241, FC241G, FC61, FCV101, FCV101-CSA, FCV101DM, FCV101DM-CSA, FCV101DS, FCV101DS-CSA, FCV141, FCV141-CSA, FCV141DM, FCV141DM-CSA, FCV141DS, FCV141DS-CSA, FCV241, FCV241DM, FCV241DS, FCV241G, FCV241G-CSA, FCV241GDM, FCV241GDM-CSA, FCV241GDS, FCV241GDS-CSA, FCV401DM, FCV401DM-CSA, FCV61, FCV61-CSA, FCV61DM, FCV61DM-CSA, FCV61DS, FCV61DS-CSA		



1

<b>GEV-Nr.</b>	540906	<b>Vergl.-Nr.</b>	33Q5980
<b>Beschreibung</b>	Dampfdüse Kunststoff L 78.5mm ID ø 12.5mm AD ø 40mm		
<b>Für Modelle:</b>	FC101, FC1011E, FC1011G, FC101E, FC1221E, FC1221G, FC241, FC241E, FC241G, FC61, FC611E, FC611G, FC61E, FCV101, FCV101-CSA, FCV101DM, FCV101DM-CSA, FCV101DS, FCV101DS-CSA, FCV101E, FCV101EDM, FCV101EDM-UL, FCV101EDS, FCV101EDS-UL, FCV101E-UL, FCV141, FCV141-CSA, FCV141DM, FCV141DM-CSA, FCV141DS, FCV141DS-CSA, FCV141E, FCV141EDM, FCV141EDS, FCV241, FCV241DM, FCV241DS, FCV241E, FCV241EDM, FCV241EDM-UL, FCV241EDS, FCV241EDS-UL, FCV241E-UL, FCV241G, FCV241G-CSA, FCV241GDM, FCV241GDM-CSA, FCV241GDS, FCV241GDS-CSA, FCV61...(Weitere Modelle finden Sie in unserem Webshop)		

Einspritzdüsen



1

<b>GEV-Nr.</b>	542429	<b>Vergl.-Nr.</b>	33T4450
<b>Beschreibung</b>	Düse Bohrung ø 5/3,65mm L 24mm SW 12 Messing Gewinde M10x1		



1

<b>GEV-Nr.</b>	541507	<b>Vergl.-Nr.</b>	33T4110
<b>Beschreibung</b>	Düse Kühlung Gewinde 1/8"		
<b>Für Modelle:</b>	FCV3EM, FCV4E, FCV4EDS, FCV4EM, FM423E1, FM423E2		
<b>Zubehör für</b>	541507		



<b>GEV-Nr.</b>	541488	<b>Vergl.-Nr.</b>	33Q5591 33Q5592
<b>Beschreibung</b>	Schlauchanschluss Gewinde M14x1 AG - 1/8"IG gewinkelt		



1

<b>GEV-Nr.</b>	541509	<b>Vergl.-Nr.</b>	33T3720
<b>Beschreibung</b>	Düse Kühlung Gewinde 1/8"		

**Für Modelle:** FC101, FC101E, FC241, FC241E, FC241G, FC61, FC61E, FCV101, FCV101-CSA, FCV101DM, FCV101DM-CSA, FCV101DS, FCV101DS-CSA, FCV101E, FCV101EDM, FCV101EDM-UL, FCV101EDS, FCV101EDS-UL, FCV101E-UL, FCV141, FCV141-CSA, FCV141DM, FCV141DM-CSA, FCV141DS, FCV141DS-CSA, FCV141E, FCV141EDM, FCV141EDS, FCV241, FCV241DM, FCV241DS, FCV241E, FCV241EDM, FCV241EDM-UL, FCV241EDS, FCV241EDS-UL, FCV241E-UL, FCV241G, FCV241G-CSA, FCV241GDM, FCV241GDM-CSA, FCV241GDS, FCV241GDS-CSA, FCV401DM, FCV401DM-CSA, FCV401EDM, FCV401EDM-UL, FCV61, FCV61-CSA, FCV61DM...(Weitere Modelle finden Sie in unserem Webshop)





<b>GEV-Nr.</b>	541488	<b>Vergl.-Nr.</b>	33Q5591 33Q5592
<b>Beschreibung</b>	Schlauchanschluss Gewinde M14x1 AG - 1/8"IG gewinkelt		





1

<b>GEV-Nr.</b>	692721	<b>Vergl.-Nr.</b>	33Q5441 33Q5442
<b>Beschreibung</b>	Einspritzdüse Bohrung ø 0.5mm D1 ø 12mm D2 ø 12mm L 60mm SW 17 Messing für Kombidämpfer Gewinde 1/8"		
<b>Für Modelle:</b>	FC61, FC61E, FCV61, FCV61-CSA, FCV61DM, FCV61DM-CSA, FCV61DS, FCV61DS-CSA, FCV61E, FCV61EDM, FCV61EDM-UL, FCV61EDS, FCV61EDS-UL, FCV61E-UL, FM611E1, FM611E2, FM611E3, FM611G1, FM611G2, FM611G3		



			
1			
<b>GEV-Nr.</b>	541487	<b>Vergl.-Nr.</b>	33Q5910 33Q5911
<b>Beschreibung</b>	Einspritzdüse Bohrung $\varnothing$ 7/0,6mm D1 $\varnothing$ 12mm D2 $\varnothing$ 12mm L 60mm SW 17 Messing für Kombidämpfer Gewinde 1/8"		
<b>Für Modelle:</b>	FC101, FC101E, FCV101, FCV101-CSA, FCV101DM, FCV101DM-CSA, FCV101DS, FCV101DS-CSA, FCV101E, FCV101EDM, FCV101EDM-UL, FCV101EDS, FCV101EDS-UL, FCV101E-UL, FCV401DM, FM1011E1, FM1011E2, FM1011E3, FM1011G1, FM1011G2, FM1011G3		
<b>Zubehör für</b>	541487		
		<b>GEV-Nr.</b>	541508 <b>Vergl.-Nr.</b> 33D1680
	Manometer $\varnothing$ 40mm Druckbereich 0-4bar Anschluss Gewinde 1/8"		

			
1			
<b>GEV-Nr.</b>	542427	<b>Vergl.-Nr.</b>	33Q6081
<b>Beschreibung</b>	Einspritzdüse Bohrung $\varnothing$ 7/0,7mm D1 $\varnothing$ 12mm D2 $\varnothing$ 12mm L 60mm SW 17 Messing für Kombidämpfer Gewinde 1/8"		
<b>Für Modelle:</b>	FC241E, FC241G, FCV141, FCV141-CSA, FCV141DM, FCV141DM-CSA, FCV141DS, FCV141DS-CSA, FCV141E, FCV141EDM, FCV141EDS, FCV241E, FCV241EDM, FCV241EDM-UL, FCV241EDS, FCV241EDS-UL, FCV241E-UL, FCV241G, FCV241G-CSA, FCV241GDM, FCV241GDM-CSA, FCV241GDS, FCV241GDS-CSA, FCV401EDM, FCV401EDM-UL, FCV72EDM-UL, FCV72EDS-UL, FCV72E-UL, FM1221E1, FM1221E2, FM1221E3, FM1221G1, FM1221G2, FM1221G3, FM721E1, FM721E2, FM721E3, FM721G1, FM721G2, FM721G3		

			
1			
<b>GEV-Nr.</b>	542425	<b>Vergl.-Nr.</b>	33Q5920 33Q5921
<b>Beschreibung</b>	Einspritzdüse Bohrung $\varnothing$ 7/4,5mm D1 $\varnothing$ 12mm D2 $\varnothing$ 12mm L 60mm SW 17 Messing für Kombidämpfer Gewinde 1/8"		
<b>Für Modelle:</b>	FC101, FC101E, FC241, FC241E, FC241G, FC61, FC61E, FCV101, FCV101-CSA, FCV101DM, FCV101DM-CSA, FCV101DS, FCV101DS-CSA, FCV101E, FCV101EDM, FCV101EDM-UL, FCV101EDS, FCV101EDS-UL, FCV101E-UL, FCV141, FCV141-CSA, FCV141DM, FCV141DM-CSA, FCV141DS, FCV141DS-CSA, FCV141E, FCV141EDM, FCV141EDS, FCV241, FCV241DM, FCV241DS, FCV241E, FCV241EDM, FCV241EDM-UL, FCV241EDS, FCV241EDS-UL, FCV241E-UL, FCV241G, FCV241G-CSA, FCV241GDM, FCV241GDM-CSA, FCV241GDS, FCV241GDS-CSA, FCV401DM, FCV401DM-CSA, FCV401EDM, FCV401EDM-UL, FCV61, FCV61-CSA, FCV61DM... (Weitere Modelle finden Sie in unserem Webshop)		

<b>Ersatzteile und Zubehör</b>			
			
1			
<b>GEV-Nr.</b>	691177	<b>Vergl.-Nr.</b>	35S8650
<b>Beschreibung</b>	Befestigungsring für Lampenfassung		

			
1			
<b>GEV-Nr.</b>	108153	<b>Vergl.-Nr.</b>	6300748
<b>Beschreibung</b>	Brennergebläse Kombidämpfer 230V 65W LA 50mm NRG118/0800-3612-030204		
<b>Für Modelle:</b>	BX101G, BX101G-VERS.122013, BX122G, BX122G-VERS.122013, BX61G, BX61G-VERS.122013, BX82G, BX82G-VERS.122013, FX101G1, FX101G1R, FX101G2, FX101G2C, FX101G2C-VERS.032014, FX101G2R, FX101G2R-VERS.032014, FX101G2-VERS.032014, FX101G3, FX101G3C, FX101G3C-VERS.022014, FX101G3R, FX101G3R-VERS.022014, FX101G3-VERS.022014, FX10G2CR, FX10G2CR-VERS.032014, FX10G3CR, FX10G3CR-VERS.022014, FX122G1, FX122G2, FX122G2C, FX122G2T, FX122G2T-VERS.032014, FX122G3, FX122G3C, FX122G3T, FX122G3T-VERS.022014, FX12G3CT, FX12G3CT-VERS.022014, FX201G2, FX201G2P, FX201G2P-VERS.032014, FX201G2-VERS.032014, FX201G3P, FX201G3-VERS.022014, FX202G2, FX202G2-VERS.032014, FX202G3, FX202G3-VERS.022014, FX61G1, FX61G1R, FX61G2... (Weitere Modelle finden Sie in unserem Webshop)		

			
1			
<b>GEV-Nr.</b>	521194	<b>Vergl.-Nr.</b>	36E2350
<b>Beschreibung</b>	Dichtung für Wärmetauscher Kombidämpfer ID $\varnothing$ 40mm LA 52mm Materialstärke 4mm		
<b>Für Modelle:</b>	BX101G, BX101G-VERS.122013, BX61G, BX61G-VERS.122013, FC1011G, FM1011G1, FM1011G1-VERS.2006, FM1011G2, FM1011G2-VERS.2006, FM1011G3, FM1011G3-VERS.2006, FX101G1, FX101G1R, FX101G2, FX101G2C, FX101G2C-VERS.032014, FX101G2R, FX101G2R-VERS.032014, FX101G2-VERS.032014, FX101G3, FX101G3C, FX101G3C-VERS.022014, FX101G3R, FX101G3R-VERS.022014, FX101G3-VERS.022014, FX10G2CR, FX10G2CR-VERS.032014, FX10G3CR, FX10G3CR-VERS.022014, FX201G2, FX201G2P, FX201G2P-VERS.032014, FX201G2-VERS.032014, FX201G3P, FX201G3-VERS.022014, FX61G1, FX61G1R, FX61G2, FX61G2C, FX61G2CR, FX61G2CR-VERS.032014, FX61G2C-VERS.032014, FX61G2R, FX61G2R-VERS.032014, FX61G2-VERS.032014, FX61G3, FX61G3C, FX61G3CR, FX61G3CR-VERS.022014, FX61G3C-VERS.022014... (Weitere Modelle finden Sie in unserem Webshop)		

			
1			
<b>GEV-Nr.</b>	541503	<b>Vergl.-Nr.</b>	33Q0530
<b>Beschreibung</b>	Endkappe für HeiBluftofen Gewinde 3/8"		
<b>Für Modelle:</b>	FC1011E, FC1011G, FC1221E, FC1221G, FC611E, FC611G, FCV101DM, FCV101DM-CSA, FCV101DS, FCV101DS-CSA, FCV101EDM, FCV101EDM-UL, FCV101EDS, FCV101EDS-UL, FCV141DM, FCV141DM-CSA, FCV141DS, FCV141DS-CSA, FCV141EDM, FCV141EDS, FCV241DM, FCV241DS, FCV241EDM, FCV241EDM-UL, FCV241EDS, FCV241EDS-UL, FCV241GDM, FCV241GDM-CSA, FCV241GDS, FCV241GDS-CSA, FCV401DM, FCV401DM-CSA, FCV61DM, FCV61DM-CSA, FCV61DS, FCV61DS-CSA, FCV61EDM, FCV61EDM-UL, FCV61EDS, FCV61EDS-UL, FCV72EDM-UL, FCV72EDS-UL, FM1011E1-VERS.2006, FM1011E2, FM1011E3, FM1011G1-VERS.2006, FM1011G2, FM1011G3, FM1221E1-VERS.2006, FM1221G1-VERS.2006... (Weitere Modelle finden Sie in unserem Webshop)		



			
1			
<b>GEV-Nr.</b>	691160	<b>Vergl.-Nr.</b>	36G0060
<b>Beschreibung</b>	Federführung		

			
1			
<b>GEV-Nr.</b>	691192	<b>Vergl.-Nr.</b>	36D0360
<b>Beschreibung</b>	Flansch		

			
1			
<b>GEV-Nr.</b>	691199	<b>Vergl.-Nr.</b>	36G5380
<b>Beschreibung</b>	Gegengewicht ø 37mm		
<b>Für Modelle:</b>	FC101, FC101E, FC241, FC241E, FC241G, FC61, FC61E, FCV101, FCV101-CSA, FCV101DM, FCV101DM-CSA, FCV101DS, FCV101DS-CSA, FCV101E, FCV101EDM, FCV101EDM-UL, FCV101EDS, FCV101EDS-UL, FCV101E-UL, FCV141, FCV141-CSA, FCV141DM, FCV141DM-CSA, FCV141DS, FCV141DS-CSA, FCV141E, FCV141EDM, FCV141EDS, FCV241, FCV241DM, FCV241DS, FCV241E, FCV241EDM, FCV241EDM-UL, FCV241EDS, FCV241EDS-UL, FCV241E-UL, FCV241G, FCV241G-CSA, FCV241GDM, FCV241GDM-CSA, FCV241GDS, FCV241GDS-CSA, FCV61, FCV61-CSA, FCV61DM, FCV61DM-CSA, FCV61DS, FCV61DS-CSA, FCV61E...(Weitere Modelle finden Sie in unserem Webshop)		

			
1			
<b>GEV-Nr.</b>	691176	<b>Vergl.-Nr.</b>	35T0080
<b>Beschreibung</b>	Leitblech ø 60mm		

			
1			
<b>GEV-Nr.</b>	691165	<b>Vergl.-Nr.</b>	36G0190
<b>Beschreibung</b>	Rad B 35mm ø 44mm		

			
1			
<b>GEV-Nr.</b>	541495	<b>Vergl.-Nr.</b>	33Q5630
<b>Beschreibung</b>	Reduzierung für Heißluftofen L 44mm SW 21 IG 3/8" AG M16x1,5		
<b>Für Modelle:</b>	FC101, FC101E, FC241, FC241E, FC241G, FC61, FC61E, FCV101, FCV101-CSA, FCV101DM, FCV101DM-CSA, FCV101DS, FCV101DS-CSA, FCV101E, FCV101EDM, FCV101EDM-UL, FCV101EDS, FCV101EDS-UL, FCV101E-UL, FCV141, FCV141-CSA, FCV141DM, FCV141DM-CSA, FCV141DS, FCV141DS-CSA, FCV141E, FCV141EDM, FCV141EDS, FCV241, FCV241DM, FCV241DS, FCV241E, FCV241EDM, FCV241EDM-UL, FCV241EDS, FCV241EDS-UL, FCV241E-UL, FCV241G, FCV241G-CSA, FCV241GDM, FCV241GDM-CSA, FCV241GDS, FCV241GDS-CSA, FCV401DM, FCV401DM-CSA, FCV401EDM, FCV401EDM-UL, FCV61, FCV61-CSA, FCV61DM...(Weitere Modelle finden Sie in unserem Webshop)		

			
1			
<b>GEV-Nr.</b>	691167	<b>Vergl.-Nr.</b>	36D9150
<b>Beschreibung</b>	Ring ID ø 26mm Außen-ø 30 Stärke 1.5mm		

			
1			
<b>GEV-Nr.</b>	696791	<b>Vergl.-Nr.</b>	3011590 3253680
<b>Beschreibung</b>	Schutzhülle für Zündkerze L 80mm ID ø 7/9 Gummi		
<b>Für Modelle:</b>	091FR11, 091FR11A, 091FR11D, 091FR11D-VERS.052012, 091FR11-VERS.032012, 091FR7G, 091FR7GS, 091FR7G-VERS.052012, 091FR7GX, 10CP11A, 12CP11A, 18CP21A, 191FR21, 191FR21D, 191FR21D-VERS.092012, 191FR21-VERS.032012, BX101G, BX122G, BX61G, BX82G, FC1011G, FC1221G, FC611G, FM1011G1, FM1011G1-VERS.2006, FM1011G2, FM1011G2-VERS.2006, FM1011G3, FM1011G3-VERS.2006, FM1221G1, FM1221G1-VERS.2006, FM1221G2, FM1221G2-VERS.2006, FM1221G3, FM1221G3-VERS.2006, FM2011G2-VERS.2006, FM2011G3-VERS.2006, FM2021G1, FM2021G2, FM2021G2-VERS.2006, FM2021G3, FM2021G3-VERS.2006, FM611G1, FM611G1-VERS.2006, FM611G2, FM611G2-VERS.2006, FM611G3, FM611G3-VERS.2006, FM721G1, FM721G1-VERS.2006...(Weitere Modelle finden Sie in unserem Webshop)		

			
1			
<b>GEV-Nr.</b>	551447	<b>Vergl.-Nr.</b>	3091170
<b>Beschreibung</b>	Verbindungsstück für Kombidämpfer Edelstahl L 162mm ø 10mm		

			
1			
<b>GEV-Nr.</b>	542426	<b>Vergl.-Nr.</b>	3007200
<b>Beschreibung</b>	Verbindungsstück für Kombidämpfer L 22mm ø 13.5mm SW 14 1/8" AG - 1/8" IG		
<b>Für Modelle:</b>	FM1011E2-VERS.2006, FM1011E3, FM1011E3-VERS.2006, FM1011G2-VERS.2006, FM1011G3, FM1011G3-VERS.2006, FM1221E2-VERS.2006, FM1221E3, FM1221E3-VERS.2006, FM1221G2-VERS.2006, FM1221G3, FM1221G3-VERS.2006, FM2011E2-VERS.2006, FM2011E3-VERS.2006, FM2011G2-VERS.2006, FM2011G3-VERS.2006, FM2021E2-VERS.2006, FM2021E3, FM2021E3-VERS.2006, FM2021G2-VERS.2006, FM2021G3, FM2021G3-VERS.2006, FM423E2, FM611E2-VERS.2006, FM611E3, FM611E3-VERS.2006, FM611G2-VERS.2006, FM611G3, FM611G3-VERS.2006, FM721E2-VERS.2006, FM721E3, FM721E3-VERS.2006, FM721G2-VERS.2006, FM721G3, FM721G3-VERS.2006		



			
1			
<b>GEV-Nr.</b>	551446	<b>Vergl.-Nr.</b>	3003760
<b>Beschreibung</b>	Verbindungsstück L 42mm SW 14 1/8" IG - 1/8" AG		
<b>Für Modelle:</b>	FM1011E2-VERS.2006, FM1011E3, FM1011E3-VERS.2006, FM1011G2-VERS.2006, FM1011G3, FM1011G3-VERS.2006, FM1221E2-VERS.2006, FM1221E3, FM1221E3-VERS.2006, FM1221G2-VERS.2006, FM1221G3, FM1221G3-VERS.2006, FM2011E2-VERS.2006, FM2011E3-VERS.2006, FM2011G2-VERS.2006, FM2011G3-VERS.2006, FM2021E2-VERS.2006, FM2021E3, FM2021E3-VERS.2006, FM2021G2-VERS.2006, FM2021G3, FM2021G3-VERS.2006, FM611E2-VERS.2006, FM611E3, FM611E3-VERS.2006, FM611G2-VERS.2006, FM611G3, FM611G3-VERS.2006, FM721E2-VERS.2006, FM721E3, FM721E3-VERS.2006, FM721G2-VERS.2006, FM721G3, FM721G3-VERS.2006, FX201E3, FX201E3P, FX201E3P-VERS.022014, FX201E3-VERS.022014, FX201G3P, FX201G3-VERS.022014, FX202E3, FX202E3-230V-3-50Hz-60Hz, FX202E3-230V-3-50Hz-60Hz-VERS.022014, FX202E3-VERS.022014, FX202G3, FX202G3-VERS.022014		

			
1			
<b>GEV-Nr.</b>	552007	<b>Vergl.-Nr.</b>	33Q5641
<b>Beschreibung</b>	Verbindungsstück mit Reduzierung 1/2" - 3/4" L 48mm Messing für Kombidämpfer		
<b>Für Modelle:</b>	FCV101, FCV101-CSA, FCV101DM, FCV101DM-CSA, FCV101DS, FCV101DS-CSA, FCV101E, FCV101EDM, FCV101EDM-UL, FCV101EDS, FCV101EDS-UL, FCV101E-UL, FCV141, FCV141-CSA, FCV141DM, FCV141DM-CSA, FCV141DS, FCV141DS-CSA, FCV141E, FCV141EDM, FCV141EDS, FCV241, FCV241DM, FCV241DS, FCV241E, FCV241EDM, FCV241EDM-UL, FCV241EDS, FCV241EDS-UL, FCV241E-UL, FCV241G, FCV241G-CSA, FCV241GDM, FCV241GDM-CSA, FCV241GDS, FCV241GDS-CSA, FCV3EM, FCV401DM, FCV401DM-CSA, FCV401EDM, FCV401EDM-UL, FCV4E, FCV4EDS, FCV4EM, FCV61, FCV61-CSA, FCV61DM, FCV61DM-CSA, FCV61DS, FCV61DS-CSA...(Weitere Modelle finden Sie in unserem Webshop)		

			
1			
<b>GEV-Nr.</b>	541498	<b>Vergl.-Nr.</b>	33Q5410
<b>Beschreibung</b>	Verschraubung SW 50 Gewinde 1 1/4" ID ø 31mm		
<b>Für Modelle:</b>	FC101, FC101E, FC241, FC241E, FC241G, FC61, FC61E, FCV101, FCV101-CSA, FCV101DM, FCV101DM-CSA, FCV101DS, FCV101DS-CSA, FCV101E, FCV101EDM, FCV101EDM-UL, FCV101EDS, FCV101EDS-UL, FCV101E-UL, FCV141, FCV141-CSA, FCV141DM, FCV141DM-CSA, FCV141DS, FCV141DS-CSA, FCV141E, FCV141EDM, FCV141EDS, FCV241, FCV241DM, FCV241DS, FCV241E, FCV241EDM, FCV241EDM-UL, FCV241EDS, FCV241EDS-UL, FCV241E-UL, FCV241G, FCV241G-CSA, FCV241GDM, FCV241GDM-CSA, FCV241GDS, FCV401DM, FCV401DM-CSA, FCV401EDM, FCV401EDM-UL, FCV61, FCV61-CSA, FCV61DM, FCV61DM-CSA...(Weitere Modelle finden Sie in unserem Webshop)		
<b>Zubehör für</b>	541498		
	<b>GEV-Nr.</b>	541499	<b>Vergl.-Nr.</b> 3151450
	 Dichtung passend für ANGELO PO Größe 1 1/4"		

			
1			
<b>GEV-Nr.</b>	551445	<b>Vergl.-Nr.</b>	3004791
<b>Beschreibung</b>	Wasserverteiler für Kombidämpfer Stahlblech verchromt L 92mm ø 35mm		
<b>Für Modelle:</b>	FM1011E1, FM1011E1-VERS.2006, FM1011E2, FM1011E2-VERS.2006, FM1011E3, FM1011E3-VERS.2006, FM1011G1, FM1011G1-VERS.2006, FM1011G2, FM1011G2-VERS.2006, FM1011G3, FM1011G3-VERS.2006, FM1221E1, FM1221E1-VERS.2006, FM1221E2, FM1221E2-VERS.2006, FM1221E3, FM1221E3-VERS.2006, FM1221G1, FM1221G1-VERS.2006, FM1221G2, FM1221G2-VERS.2006, FM1221G3, FM1221G3-VERS.2006, FM2011E2-VERS.2006, FM2011E3-VERS.2006, FM2011G2-VERS.2006, FM2011G3-VERS.2006, FM2021E1, FM2021E2, FM2021E2-VERS.2006, FM2021E3, FM2021E3-VERS.2006, FM2021G1, FM2021G2, FM2021G2-VERS.2006, FM2021G3, FM2021G3-VERS.2006, FM611E1, FM611E1-VERS.2006, FM611E2, FM611E2-VERS.2006, FM611E3, FM611E3-VERS.2006, FM611G1, FM611G1-VERS.2006, FM611G2, FM611G2-VERS.2006, FM611G3, FM611G3-VERS.2006...(Weitere Modelle finden Sie in unserem Webshop)		

			
1			
<b>GEV-Nr.</b>	521197	<b>Vergl.-Nr.</b>	36E4290
<b>Beschreibung</b>	Y-Stück Gewinde 1/8" IG - 1/8" IG - 1/8" IG Edelstahl SW 13		
<b>Für Modelle:</b>	FM1011E3, FM1011G3, FM1221E3, FM1221G3, FM611E3, FM611G3, FM721E3, FM721G3		

## Glasscheiben

			
1			
<b>GEV-Nr.</b>	691146	<b>Vergl.-Nr.</b>	3000770
<b>Beschreibung</b>	Glasscheibe L 515mm B 505mm Materialstärke 6mm rechteckig		
<b>Für Modelle:</b>	FM611E1, FM611E2, FM611E3, FM611G1, FM611G2, FM611G3		

			
1			
<b>GEV-Nr.</b>	691147	<b>Vergl.-Nr.</b>	3000760
<b>Beschreibung</b>	Glasscheibe L 720mm B 515mm Materialstärke 6mm rechteckig		
<b>Für Modelle:</b>	FM1011E1, FM1011E2, FM1011E3, FM1011G1, FM1011G2, FM1011G3		



Reinigungssystem

Verschraubungen



<b>GEV-Nr.</b>	362028	<b>Vergl.-Nr.</b>	3041000
<b>Beschreibung</b>	Verteiler 4+2 L 116mm Kunststoff Gewinde M10 IG		
<b>Für Modelle:</b>	FM1011E3-VERS.2006, FM1011G3-VERS.2006, FM1221E3-VERS.2006, FM1221G3-VERS.2006, FM2011E3-VERS.2006, FM2011G3-VERS.2006, FM2021E3-VERS.2006, FM2021G3-VERS.2006, FM611E3-VERS.2006, FM611G3-VERS.2006, FM721E3-VERS.2006, FM721G3-VERS.2006		

Rohre



<b>GEV-Nr.</b>	521196	<b>Vergl.-Nr.</b>	3120710
<b>Beschreibung</b>	Ablaufrohr L 568mm B 182mm ø 30mm für Kombidämpfer ID ø 21mm EPDM		
<b>Für Modelle:</b>	BX101E, BX101E-VERS.122013, BX122E, BX122E-VERS.122013, BX122G, BX122G-VERS.122013, BX61E, BX61E-VERS.122013, BX82E, BX82E-VERS.122013, BX82G, BX82G-VERS.122013, FM423E1, FM423E2, FX101E1, FX101E1R, FX101E2, FX101E2C, FX101E2C-VERS.032014, FX101E2R, FX101E2R-VERS.032014, FX101E2-VERS.032014, FX101E3, FX101E3C, FX101E3C-VERS.022014, FX101E3R, FX101E3R-VERS.022014, FX101E3-VERS.022014, FX101G1, FX101G1R, FX101G2, FX101G2C, FX101G2R, FX101G3, FX101G3C, FX101G3R, FX10E2CR, FX10E2CR-VERS.032014, FX10E3CR, FX10E3CR-VERS.022014, FX10G2CR, FX10G3CR, FX122E1, FX122E2, FX122E2C, FX122E2T, FX122E2T-VERS.032014, FX122E3, FX122E3C, FX122E3T... (Weitere Modelle finden Sie in unserem Webshop)		



<b>GEV-Nr.</b>	521198	<b>Vergl.-Nr.</b>	30Z2050
<b>Beschreibung</b>	Wasserrohr L 180mm B 120mm ø 11/12mm Gewinde M16x1,5		
<b>Für Modelle:</b>	FC101, FC1011E, FC1011G, FC101E, FC1221E, FC1221G, FC241E, FC241G, FC61, FC611E, FC611G, FC61E, FCV101, FCV101-CSA, FCV101DM, FCV101DM-CSA, FCV101DS, FCV101DS-CSA, FCV101E, FCV101EDM, FCV101EDM-UL, FCV101EDS, FCV101E-UL, FCV141, FCV141-CSA, FCV141DM, FCV141DM-CSA, FCV141DS, FCV141DS-CSA, FCV141E, FCV141EDM, FCV141EDS, FCV241E, FCV241EDM, FCV241EDM-UL, FCV241EDS, FCV241EDS-UL, FCV241E-UL, FCV241G, FCV241G-CSA, FCV241GDM, FCV241GDM-CSA, FCV241GDS, FCV241GDS-CSA, FCV401DM, FCV401DM-CSA, FCV401EDM, FCV401EDM-UL, FCV61, FCV61-CSA... (Weitere Modelle finden Sie in unserem Webshop)		

Schläuche



<b>GEV-Nr.</b>	696792	<b>Vergl.-Nr.</b>	3067460
<b>Beschreibung</b>	Schlauch ID ø 32mm AD ø 40mm L 1000mm Kombidämpfer		
<b>Für Modelle:</b>	08WGREV, 091CP1E, 091CP1G, 10CP1EA, 10CP1GA, 10CP1IA, 12CP1EA, 12CP1GA, 12CP1IA, 18CP2EA, 18CP2GA, 18CP2IA, 191CP1G, 191CP2G, 6040090, 6040310, 6043850, 6043980, FMS, FMSX, PIER-06HD, PIER15HD		

Service Kits



<b>GEV-Nr.</b>	696773	<b>Vergl.-Nr.</b>	6300833
<b>Beschreibung</b>	Ablaufventil Set für Kombidämpfer Schlauch ø 8mm		
<b>Für Modelle:</b>	FX101E3, FX101E3C, FX101E3C-VERS.022014, FX101E3R, FX101E3R-VERS.022014, FX101E3-VERS.022014, FX101G3, FX101G3C, FX101G3C-VERS.022014, FX101G3R, FX101G3R-VERS.022014, FX101G3-VERS.022014, FX10E3CR, FX10E3CR-VERS.022014, FX10G3CR, FX10G3CR-VERS.022014, FX122E3, FX122E3C, FX122E3T, FX122E3T-VERS.022014, FX122G3, FX122G3C, FX122G3T, FX122G3T-VERS.022014, FX12E3CT, FX12E3CT-VERS.022014, FX12G3CT, FX12G3CT-VERS.022014, FX201E3, FX201E3P, FX201E3P-VERS.022014, FX201E3-VERS.022014, FX201G3P, FX201G3-VERS.022014, FX202E3, FX202E3-230V-3-50Hz-60Hz, FX202E3-230V-3-50Hz-60Hz-VERS.022014, FX202E3-VERS.022014, FX202G3, FX202G3-VERS.022014, FX61E3, FX61E3C, FX61E3CR, FX61E3CR-VERS.022014, FX61E3C-VERS.022014, FX61E3R, FX61E3R-VERS.022014, FX61E3-VERS.022014, FX61G3, FX61G3C... (Weitere Modelle finden Sie in unserem Webshop)		

Türmechanik

Halter



<b>GEV-Nr.</b>	692858	<b>Vergl.-Nr.</b>	6300798
<b>Beschreibung</b>	Halter für Glastür Kombidämpfer		
<b>Für Modelle:</b>	FX101E1, FX101E2, FX101E2C, FX101E2C-VERS.032014, FX101E2-VERS.032014, FX101E3, FX101E3C, FX101E3C-VERS.022014, FX101E3R, FX101E3-VERS.022014, FX101G1, FX101G2, FX101G2C, FX101G2C-VERS.032014, FX101G2-VERS.032014, FX101G3, FX101G3C, FX101G3C-VERS.022014, FX101G3-VERS.022014, FX10E2CR-VERS.032014, FX122E1, FX122E2, FX122E2C, FX122E2T, FX122E2T-VERS.032014, FX122E3, FX122E3C, FX122E3T, FX122E3T-VERS.022014, FX122G1, FX122G3, FX122G3C, FX122G3T, FX122G3T-VERS.022014, FX12E3CT, FX12E3CT-VERS.022014, FX12G3CT, FX12G3CT-VERS.022014, FX61E1, FX61E2, FX61E2C, FX61E2C-VERS.032014, FX61E2-VERS.032014, FX61E3, FX61E3C, FX61E3C-VERS.022014, FX61E3-VERS.022014, FX61G1, FX61G2, FX61G2C... (Weitere Modelle finden Sie in unserem Webshop)		



## Verschlussmechanik



<b>GEV-Nr.</b>	698503	<b>Vergl.-Nr.</b>	6300965
<b>Beschreibung</b>	Treibriegelverschluss komplett		
<b>Für Modelle:</b>	FX201E2, FX201E2P, FX201E2P-VERS.032014, FX201E2-VERS.032014, FX201E3, FX201E3P, FX201E3P-VERS.022014, FX201E3-VERS.022014, FX201G2, FX201G2P, FX201G2P-VERS.032014, FX201G2-VERS.032014, FX201G3P, FX201G3-VERS.022014, FX202E2, FX202E2-VERS.032014, FX202E3, FX202E3-230V-3-50Hz-60Hz, FX202E3-230V-3-50Hz-60Hz-VERS.022014, FX202E3-VERS.022014, FX202G2, FX202G2-VERS.032014, FX202G3, FX202G3-VERS.022014		
<b>Zubehör für</b>	698503		
	<b>GEV-Nr.</b>	690041	<b>Vergl.-Nr.</b> 3088460
	Riegel L 148mm BA 32mm		
	<b>GEV-Nr.</b>	694409	<b>Vergl.-Nr.</b> —
	Montagesatz für Treibriegelverschluss 694382		
	<b>GEV-Nr.</b>	700604	<b>Vergl.-Nr.</b> —
	Verschlussgetriebe rechts öffnend Achsaufnahme ø 8x8mm L 170mm B 40mm H 40mm		

## Zubehör



<b>GEV-Nr.</b>	692859	<b>Vergl.-Nr.</b>	3019510
<b>Beschreibung</b>	Befestigungsplatte für Verschluss B 42mm Stahlblech verzinkt L 93.5mm		
<b>Für Modelle:</b>	FC1011E, FC1011G, FC1221E, FC1221G, FC611E, FC611G, FM1011E1, FM1011E1-VERS.2006, FM1011E2, FM1011E2-VERS.2006, FM1011E3, FM1011E3-VERS.2006, FM1011G1, FM1011G1-VERS.2006, FM1011G2, FM1011G2-VERS.2006, FM1011G3, FM1011G3-VERS.2006, FM1221E1, FM1221E1-VERS.2006, FM1221E2, FM1221E2-VERS.2006, FM1221E3, FM1221E3-VERS.2006, FM1221G1, FM1221G1-VERS.2006, FM1221G2, FM1221G2-VERS.2006, FM1221G3, FM1221G3-VERS.2006, FM2011E2-VERS.2006, FM2011E3-VERS.2006, FM2011G2-VERS.2006, FM2011G3-VERS.2006, FM2021E1, FM2021E2, FM2021E2-VERS.2006, FM2021E3, FM2021E3-VERS.2006, FM2021G1, FM2021G2, FM2021G2-VERS.2006, FM2021G3, FM2021G3-VERS.2006, FM611E1, FM611E1-VERS.2006, FM611E2, FM611E2-VERS.2006, FM611E3, FM611E3-VERS.2006... (Weitere Modelle finden Sie in unserem Webshop)		



<b>GEV-Nr.</b>	696774	<b>Vergl.-Nr.</b>	3171920
<b>Beschreibung</b>	Buchse für Türgriff ø 43mm Loch ø 20mm Kunststoff		
<b>Für Modelle:</b>	FX101E1, FX101E2, FX101E2C, FX101E2C-VERS.032014, FX101E2-VERS.032014, FX101E3, FX101E3C, FX101E3C-VERS.022014, FX101E3R, FX101E3-VERS.022014, FX101G1, FX101G2, FX101G2C, FX101G2C-VERS.032014, FX101G2-VERS.032014, FX101G3, FX101G3C, FX101G3C-VERS.022014, FX101G3-VERS.022014, FX10E2CR-VERS.032014, FX122E1, FX122E2, FX122E2C, FX122E2T, FX122E2T-VERS.032014, FX122E3, FX122E3C, FX122E3T, FX122E3T-VERS.022014, FX122G1, FX122G3, FX122G3C, FX122G3T, FX122G3T-VERS.022014, FX12E3CT, FX12E3CT-VERS.022014, FX12G3CT, FX12G3CT-VERS.022014, FX61E1, FX61E2, FX61E2C, FX61E2C-VERS.032014, FX61E2-VERS.032014, FX61E3, FX61E3C, FX61E3C-VERS.022014, FX61E3-VERS.022014, FX61G1, FX61G2, FX61G2C... (Weitere Modelle finden Sie in unserem Webshop)		



<b>GEV-Nr.</b>	696775	<b>Vergl.-Nr.</b>	36E2781
<b>Beschreibung</b>	Puffer für Tür ø 15mm Silikon L 20mm		
<b>Für Modelle:</b>	BX101E, BX101E-VERS.122013, BX101G, BX101G-VERS.122013, BX122E, BX122E-VERS.122013, BX122G, BX122G-VERS.122013, BX61E, BX61E-VERS.122013, BX61G, BX61G-VERS.122013, BX82E, BX82E-VERS.122013, BX82G, BX82G-VERS.122013, FC1011E, FC1011G, FC1221E, FC1221G, FC611E, FC611G, FM1011E1, FM1011E1-VERS.2006, FM1011E2, FM1011E2-VERS.2006, FM1011E3, FM1011E3-VERS.2006, FM1011G1, FM1011G1-VERS.2006, FM1011G2, FM1011G2-VERS.2006, FM1011G3, FM1011G3-VERS.2006, FM1221E1, FM1221E1-VERS.2006, FM1221E2, FM1221E2-VERS.2006, FM1221E3, FM1221E3-VERS.2006, FM1221G1, FM1221G1-VERS.2006, FM1221G2, FM1221G2-VERS.2006, FM1221G3, FM1221G3-VERS.2006, FM2011E2-VERS.2006, FM2011E3-VERS.2006, FM2011G2-VERS.2006, FM2011G3-VERS.2006...(Weitere Modelle finden Sie in unserem Webshop)		

## Vibrationspumpen



<b>GEV-Nr.</b>	500972	<b>Vergl.-Nr.</b>	32M7000 32M7001
<b>Beschreibung</b>	Vibrationspumpe 230V 47W 50Hz Eingang ø 7 Ausgang ø 1/8" IG CEME Typ E507		
<b>Für Modelle:</b>	FM1011E3, FM1011E3-VERS.2006, FM1011G3, FM1011G3-VERS.2006, FM1221E3, FM1221E3-VERS.2006, FM1221G3-VERS.2006, FM2011E3-VERS.2006, FM2011G3-VERS.2006, FM2021E3, FM2021E3-VERS.2006, FM2021G3, FM2021G3-VERS.2006, FM611E3, FM611E3-VERS.2006, FM611G3, FM611G3-VERS.2006, FM721E3, FM721E3-VERS.2006, FM721G3, FM721G3-VERS.2006		

## Wärmetauscher





<b>GEV-Nr.</b>	521194	<b>Vergl.-Nr.</b>	36E2350
<b>Beschreibung</b>	Dichtung für Wärmetauscher Kombidämpfer ID ø 40mm LA 52mm Materialstärke 4mm		
<b>Für Modelle:</b>	BX101G, BX101G-VERS.122013, BX61G, BX61G-VERS.122013, FC1011G, FM1011G1, FM1011G1-VERS.2006, FM1011G2, FM1011G2-VERS.2006, FM1011G3, FM1011G3-VERS.2006, FX101G1, FX101G1R, FX101G2, FX101G2C, FX101G2C-VERS.032014, FX101G2R, FX101G2R-VERS.032014, FX101G2-VERS.032014, FX101G3, FX101G3C, FX101G3C-VERS.022014, FX101G3R, FX101G3R-VERS.022014, FX101G3-VERS.022014, FX10G2CR, FX10G2CR-VERS.032014, FX10G3CR, FX10G3CR-VERS.022014, FX201G2, FX201G2P, FX201G2P-VERS.032014, FX201G2-VERS.032014, FX201G3P, FX201G3-VERS.022014, FX61G1, FX61G1R, FX61G2, FX61G2C, FX61G2CR, FX61G2CR-VERS.032014, FX61G2C-VERS.032014, FX61G2R, FX61G2R-VERS.032014, FX61G3, FX61G3C, FX61G3C, FX61G3CR, FX61G3CR-VERS.022014, FX61G3C-VERS.022014...(Weitere Modelle finden Sie in unserem Webshop)		

Mechanik und Gerätezubehör







			
<b>GEV-Nr.</b>	521195	<b>Vergl.-Nr.</b>	36E3570
<b>Beschreibung</b>	Dichtung für Wärmetauscher Kombidämpfer ID ø 52mm LA 63mm Materialstärke 3mm		
<b>Für Modelle:</b>	BX122G, BX122G-VERS.122013, BX82G, BX82G-VERS.122013, FC1221G, FM1221G1, FM1221G1-VERS.2006, FM1221G2, FM1221G2-VERS.2006, FM1221G3, FM1221G3-VERS.2006, FM2021G1, FM2021G2, FM2021G2-VERS.2006, FM2021G3, FM2021G3-VERS.2006, FM721G1, FM721G1-VERS.2006, FM721G2, FM721G2-VERS.2006, FM721G3, FM721G3-VERS.2006, FX122G1, FX122G2, FX122G2C, FX122G2T, FX122G2T-VERS.032014, FX122G3, FX122G3C, FX122G3T, FX122G3T-VERS.022014, FX12G3CT, FX12G3CT-VERS.022014, FX202G2, FX202G2-VERS.032014, FX202G3, FX202G3-VERS.022014, FX82G1, FX82G2, FX82G2C, FX82G2T, FX82G2T-VERS.032014, FX82G3, FX82G3C, FX82G3CT, FX82G3CT-VERS.022014, FX82G3T, FX82G3T-VERS.022014		

<h3>Sonstiges</h3>			
			
<b>GEV-Nr.</b>	697869	<b>Vergl.-Nr.</b>	3010750
<b>Beschreibung</b>	Befestigungsflansch für Ventilator Stahl		
<b>Für Modelle:</b>	FM1011G1, FM1011G2, FM1011G3, FM611G1, FM611G2, FM611G3, FM721G1, FM721G2, FM721G3		

			
<b>GEV-Nr.</b>	691179	<b>Vergl.-Nr.</b>	33Q0730
<b>Beschreibung</b>	Buchse Gewinde M10x1 ø 5mm		
<b>Für Modelle:</b>	FCV101DM, FCV101DM-CSA, FCV101DS, FCV101DS-CSA, FCV101EDM, FCV101EDM-UL, FCV101EDS, FCV101EDS-UL, FCV141DM, FCV141DM-CSA, FCV141DS, FCV141DS-CSA, FCV141EDM, FCV141EDS, FCV241DM, FCV241DS, FCV241EDM, FCV241EDM-UL, FCV241EDS, FCV241EDS-UL, FCV241GDM, FCV241GDM-CSA, FCV241GDS, FCV241GDS-CSA, FCV401DM, FCV401DM-CSA, FCV401EDM, FCV401EDM-UL, FCV4EDS, FCV61DM, FCV61DM-CSA, FCV61DS, FCV61DS-CSA, FCV61EDM, FCV61EDM-UL, FCV61EDS, FCV61EDS-UL, FCV72EDM-UL, FCV72EDS-UL, FM1011E2, FM1011E3, FM1011G2, FM1011G3, FM1221E2, FM1221E3, FM1221G2, FM1221G3, FM2021E2, FM2021E3, FM2021G2... (Weitere Modelle finden Sie in unserem Webshop)		
<b>Zubehör für</b>	691179		
	<b>GEV-Nr.</b>	519385	<b>Vergl.-Nr.</b> 3150220
	Dichtung für Kerntemperaturfühler AD ø 8mm ID ø 4mm Materialstärke 5mm		
	<b>GEV-Nr.</b>	560332	<b>Vergl.-Nr.</b> —
	Unterlegscheibe ID ø 4.3mm AD ø 9mm Materialstärke 0.8mm CNS VPE 1 Stück		

			
<b>GEV-Nr.</b>	691123	<b>Vergl.-Nr.</b>	36E2060
<b>Beschreibung</b>	Durchführung für Türöffner		
<b>Für Modelle:</b>	FCV3EM, FCV4E, FCV4EDS, FCV4EM, FM423E1, FM423E2		

			
<b>GEV-Nr.</b>	541486	<b>Vergl.-Nr.</b>	33Q5901
<b>Beschreibung</b>	Schlauchanschluss für Manometer Bohrung ø 0.4mm Gewinde 1/8"		
<b>Für Modelle:</b>	FM423E1, FM423E2		
<b>Zubehör für</b>	541486		
	<b>GEV-Nr.</b>	541508	<b>Vergl.-Nr.</b> 33D1680
	Manometer ø 40mm Druckbereich 0-4bar Anschluss Gewinde 1/8"		

			
<b>GEV-Nr.</b>	542121	<b>Vergl.-Nr.</b>	3032890
<b>Beschreibung</b>	Schlauchanschluss für Manometer L 60mm SW 17 Messing Gewinde 1/8" ø 12mm G2: M8		
<b>Für Modelle:</b>	BX101E, BX101E-VERS.122013, BX101G, BX101G-VERS.122013, FC1011E, FC1011G, FC1221E, FC1221G, FC611E, FC611G, FM1011E1, FM1011E1-VERS.2006, FM1011E2, FM1011E2-VERS.2006, FM1011E3, FM1011E3-VERS.2006, FM1011G1, FM1011G1-VERS.2006, FM1011G2, FM1011G2-VERS.2006, FM1011G3, FM1011G3-VERS.2006, FM1221E1-VERS.2006, FM1221E2-VERS.2006, FM1221E3, FM1221E3-VERS.2006, FM1221G1-VERS.2006, FM1221G2-VERS.2006, FM1221G3, FM1221G3-VERS.2006, FM2011E2-VERS.2006, FM2011E3-VERS.2006, FM2011G2-VERS.2006, FM2011G3-VERS.2006, FM2021E1, FM2021E2, FM2021E2-VERS.2006, FM2021E3, FM2021E3-VERS.2006, FM2021G1, FM2021G2, FM2021G2-VERS.2006, FM2021G3, FM2021G3-VERS.2006, FM611E1, FM611E1-VERS.2006, FM611E2, FM611E2-VERS.2006, FM611E3, FM611E3-VERS.2006... (Weitere Modelle finden Sie in unserem Webshop)		

			
<b>GEV-Nr.</b>	697870	<b>Vergl.-Nr.</b>	3010670
<b>Beschreibung</b>	Schutz für Luftansaugung		
<b>Für Modelle:</b>	FM1011G1, FM1011G2, FM1011G3, FM1221G1, FM1221G2, FM1221G3, FM2021G1, FM2021G2, FM2021G3, FM611G1, FM611G2, FM611G3		



für Kochkessel

			
1			
<b>GEV-Nr.</b>	692717	<b>Vergl.-Nr.</b>	3033400 3278360 35Q7830 35S5900
<b>Beschreibung</b>	Ablaufilter für Kochkessel ø 83mm		
<b>Für Modelle:</b>	0A1CP1E, 0A1CP1G, 0B1CP1G, 0D1CP1E, 0D1CP1G, 1A1CP1G, 1A1CP2G, 1D1CP1G, 1D1CP2G, BX101E, BX101E-VERS.122013, BX101G, BX101G-VERS.122013, BX122E, BX122E-VERS.122013, BX122G, BX122G-VERS.122013, BX61E, BX61E-VERS.122013, BX61G, BX61G-VERS.122013, BX82E, BX82E-VERS.122013, BX82G, BX82G-VERS.122013, FC101, FC1011E, FC1011G, FC101E, FC1221E, FC1221G, FC241, FC241E, FC241G, FC61, FC611E, FC611G, FC61E, FCV101, FCV101-CSA, FCV101DM, FCV101DM-CSA, FCV101DS, FCV101DS-CSA, FCV101E, FCV101EDM, FCV101EDM-UL, FCV101EDS, FCV101EDS-UL, FCV101E-UL...(Weitere Modelle finden Sie in unserem Webshop)		

für Öfen

Ersatzteile und Zubehör

			
1			
<b>GEV-Nr.</b>	691172	<b>Vergl.-Nr.</b>	35S5970
<b>Beschreibung</b>	Führung für Gegengewicht		
<b>Für Modelle:</b>	FC101, FC101E, FC241, FC241E, FC241G, FC61, FC61E, FCV101, FCV101-CSA, FCV101DM, FCV101DM-CSA, FCV101DS, FCV101DS-CSA, FCV101E, FCV101EDM, FCV101EDM-UL, FCV101EDS, FCV101EDS-UL, FCV101E-UL, FCV141, FCV141-CSA, FCV141DM, FCV141DM-CSA, FCV141DS, FCV141DS-CSA, FCV141E, FCV141EDM, FCV141EDS, FCV241, FCV241DM, FCV241DS, FCV241E, FCV241EDM, FCV241EDM-UL, FCV241EDS, FCV241EDS-UL, FCV241E-UL, FCV241G, FCV241G-CSA, FCV241GDM, FCV241GDM-CSA, FCV241GDS, FCV241GDS-CSA, FCV61, FCV61-CSA, FCV61DM, FCV61DM-CSA, FCV61DS, FCV61DS-CSA, FCV61E...(Weitere Modelle finden Sie in unserem Webshop)		

Sonstiges



			
1			
<b>GEV-Nr.</b>	698478	<b>Vergl.-Nr.</b>	3142670
<b>Beschreibung</b>	Kupplung für Ofen für Tür L 80mm B 26mm Aufnahme 8x8		
<b>Für Modelle:</b>	FX201E2, FX201E2P, FX201E2P-VERS.032014, FX201E2-VERS.032014, FX201E3, FX201E3P, FX201E3P-VERS.022014, FX201E3-VERS.022014, FX201G2, FX201G2P, FX201G2P-VERS.032014, FX201G2-VERS.032014, FX201G3P, FX201G3-VERS.022014, FX202E2, FX202E2-VERS.032014, FX202E3, FX202E3-230V-3-50Hz-60Hz, FX202E3-230V-3-50Hz-60Hz-VERS.022014, FX202E3-VERS.022014, FX202G2, FX202G2-VERS.032014, FX202G3, FX202G3-VERS.022014		

Knebel

Herstellerspezifische Knebel

ANGELO PO

			
1			
<b>GEV-Nr.</b>	111745	<b>Vergl.-Nr.</b>	36M4970
<b>Beschreibung</b>	Knebel Schalter Nullstrich ø 45mm Achse ø 6x4,6mm Abflachung oben blau/schwarz		
<b>Für Modelle:</b>	FCV3EM, FCV4EM		

			
1			
<b>GEV-Nr.</b>	110925	<b>Vergl.-Nr.</b>	36M4560
<b>Beschreibung</b>	Knebel Schalter Nullstrich ø 45mm Achse ø 6x4,6mm Abflachung oben rot		
<b>Für Modelle:</b>	030FE1B, 091FE28B, 30F1B, 30FES2B, 30FS2B, 70F1B, 70FE1B, 70FES2, 70FES2B, 71F2B, 71FE2B, 90F110B, 91AR, 91ARE, 91F210B, 91F223B, 91RA, FC101, FC101E, FC241, FC241E, FC241G, FC61, FC61E, FCV101, FCV101-CSA, FCV101E, FCV101E-UL, FCV141, FCV141-CSA, FCV141E, FCV241, FCV241E, FCV241E-UL, FCV241G, FCV241G-CSA, FCV61, FCV61-CSA, FCV61E, FCV61E-UL, FCV72E-UL		
<b>Zubehör für</b>	110925		
		<b>GEV-Nr.</b>	550965
		<b>Vergl.-Nr.</b>	3170290
	Knebelfeder ø 6x4,6mm VPE 1 Stück		

			
1			
<b>GEV-Nr.</b>	112860	<b>Vergl.-Nr.</b>	3104141 3104142 3104143
<b>Beschreibung</b>	Knebel ø 60mm Achse ø 6x9mm silber		

			
1			
<b>GEV-Nr.</b>	110081	<b>Vergl.-Nr.</b>	36M0770
<b>Beschreibung</b>	Knebel ø 70mm Achse ø 8x6,5mm Abflachung universal		

3 Mechanik und Gerätezubehör



<b>GEV-Nr.</b>	112570	<b>Vergl.-Nr.</b>	36H0900 36H0901
<b>Beschreibung</b>	Knebel Potentiometer ø 62mm Achse ø 6x4,6mm Abflachung universal schwarz		
<b>Für Modelle:</b>	FM1011E1, FM1011E1-VERS.2006, FM1011E2, FM1011E2-VERS.2006, FM1011E3, FM1011E3-VERS.2006, FM1011G1, FM1011G1-VERS.2006, FM1011G2, FM1011G2-VERS.2006, FM1011G3, FM1011G3-VERS.2006, FM1221E1, FM1221E1-VERS.2006, FM1221E2, FM1221E2-VERS.2006, FM1221E3, FM1221E3-VERS.2006, FM1221G1, FM1221G1-VERS.2006, FM1221G2, FM1221G2-VERS.2006, FM1221G3, FM1221G3-VERS.2006, FM2011E2-VERS.2006, FM2011E3-VERS.2006, FM2011G2-VERS.2006, FM2011G3-VERS.2006, FM2021E1, FM2021E2, FM2021E2-VERS.2006, FM2021E3, FM2021E3-VERS.2006, FM2021G1, FM2021G2, FM2021G2-VERS.2006, FM2021G3, FM2021G3-VERS.2006, FM423E1, FM423E2, FM611E1, FM611E1-VERS.2006, FM611E2, FM611E2-VERS.2006, FM611E3, FM611E3-VERS.2006, FM611G1, FM611G1-VERS.2006, FM611G2, FM611G2-VERS.2006...(Weitere Modelle finden Sie in unserem Webshop)		

## Verschlüsse

### Drehhebelverschlüsse

Universal

RAHRBACH



<b>GEV-Nr.</b>	690500	<b>Vergl.-Nr.</b>	36M0880 36M3180 36M6380 6300421
<b>Beschreibung</b>	Hebelverschluss rechts L 185mm H 66mm Griffmaterial Kunststoff Typ Serie 6300		
<b>Für Modelle:</b>	FC101, FC101E, FC241, FC241E, FC241G, FC61, FC61E, FCV101, FCV101-CSA, FCV101DM, FCV101DM-CSA, FCV101DS, FCV101DS-CSA, FCV101E, FCV101EDM, FCV101EDM-UL, FCV101EDS, FCV101EDS-UL, FCV101E-UL, FCV141, FCV141-CSA, FCV141DM, FCV141DM-CSA, FCV141DS, FCV141DS-CSA, FCV141E, FCV141EDM, FCV141EDS, FCV241, FCV241DM, FCV241DS, FCV241E, FCV241EDM, FCV241EDM-UL, FCV241EDS, FCV241EDS-UL, FCV241E-UL, FCV241G, FCV241G-CSA, FCV241GDM, FCV241GDM-CSA, FCV241GDS, FCV241GDS-CSA, FCV401DM, FCV401DM-CSA, FCV401EDM, FCV401EDM-UL, FCV61, FCV61-CSA, FCV61DM...(Weitere Modelle finden Sie in unserem Webshop)		
<b>Ersatzteile für</b>	690500		
	<b>GEV-Nr.</b>	699841	<b>Vergl.-Nr.</b> —
	Abdeckkappe für Drehhebelverschluss ø 32mm H 14mm		
<b>Zubehör für</b>	690500		
	<b>GEV-Nr.</b>	514281	<b>Vergl.-Nr.</b> 36M1570
	Unterlegplatte L 110mm B 35mm für Kloben Stärke 10mm		
	<b>GEV-Nr.</b>	690136	<b>Vergl.-Nr.</b> 3FL0197
	Gleitplatte EP rechts L 28mm H 3mm B 21mm H2 12.5mm		
	<b>GEV-Nr.</b>	691174	<b>Vergl.-Nr.</b> 35V9050
	Gegenstück L 90mm B 60mm für Türverschluss		
	<b>GEV-Nr.</b>	700091	<b>Vergl.-Nr.</b> —
	Kloben EP rechts Überschlag 20mm L 110mm H 56mm B 33mm BA 68/68mm Zink Druckguss Serie 6300		
	<b>GEV-Nr.</b>	700098	<b>Vergl.-Nr.</b> 36M0820
	Kloben EP rechts Überschlag 38mm L 110mm H 74mm B 33mm BA 68/68mm Serie 1750		

## Zubehör

### Knebel Federn



<b>GEV-Nr.</b>	550965	<b>Vergl.-Nr.</b>	3170290
<b>Beschreibung</b>	Knebel Feder ø 6x4,6mm VPE 1 Stück		
<b>Für Modelle:</b>	030BME, 030E, 030EBM, 030FE, 030FE1, 030FE1B, 030FTE, 030FTE1, 031BME, 031E, 031EBM, 031FTE, 031FTE04, 031FTE06, 031FTE08, 031FTE10, 031FTE12, 031FTE14, 031FTE16, 031FTE18, 031FTE20, 031FTE22, 031FTE24, 031FTE26, 031FTE28, 031FTE30, 031FTE32, 031FTE34, 031FTE36, 031FTE38, 031FTE40, 031FTE42, 031FTE44, 031FTE46, 031FTE48, 031FTE50, 031FTE52, 031FTE54, 031FTE56, 031FTE58, 031FTE60, 031FTE62, 031FTE64, 031FTE66, 031FTE68, 031FTE70, 031FTE72, 031FTE74, 031FTE76, 031FTE78, 031FTE80, 031FTE82, 031FTE84, 031FTE86, 031FTE88, 031FTE90, 031FTE92, 031FTE94, 031FTE96, 031FTE98, 031FTE100, 031FTE102, 031FTE104, 031FTE106, 031FTE108, 031FTE110, 031FTE112, 031FTE114, 031FTE116, 031FTE118, 031FTE120, 031FTE122, 031FTE124, 031FTE126, 031FTE128, 031FTE130, 031FTE132, 031FTE134, 031FTE136, 031FTE138, 031FTE140, 031FTE142, 031FTE144, 031FTE146, 031FTE148, 031FTE150, 031FTE152, 031FTE154, 031FTE156, 031FTE158, 031FTE160, 031FTE162, 031FTE164, 031FTE166, 031FTE168, 031FTE170, 031FTE172, 031FTE174, 031FTE176, 031FTE178, 031FTE180, 031FTE182, 031FTE184, 031FTE186, 031FTE188, 031FTE190, 031FTE192, 031FTE194, 031FTE196, 031FTE198, 031FTE200...		

### Dichtungen







<b>GEV-Nr.</b>	550493	<b>Vergl.-Nr.</b>	3150790
<b>Beschreibung</b>	Dichtung für Knebel		
<b>Für Modelle:</b>	030E, 030EBM, 030FE1, 030FE1B, 030FTE, 030FTE1, 031E, 031EBM, 031FTE04, 031FTE06, 04WCP1EM, 06WFR3GD, 070E, 070FTE04, 070FTE05, 071E, 071FTE04, 071FTE06, 08WCP1GM, 08WFPAE, 090, 090BM, 090BME, 090E, 090FT, 090FTE04, 090FTE05, 090FTR, 090GG, 091, 091BM, 091BME, 091CP1E, 091CP1G, 091E, 091FE28, 091FE28B, 091FR1E, 091FR1ED, 091FR1GD, 091FR3G, 091FR3GD, 091FT, 091FTE04, 091FTE06, 091FTR, 091FTR1, 091FTR2, 091FTL, 091GG, 091TP, 092...(Weitere Modelle finden Sie in unserem Webshop)		



3 Mechanik und Gerätezubehör



			
<b>GEV-Nr.</b>	690137	<b>Vergl.-Nr.</b>	36E2530 6300843
<b>Beschreibung</b>	Gleitplatte EP links L 28mm H 3mm B 21mm H2 12.5mm		
<b>Für Modelle:</b>	FC101, FC101E, FC1011G, FC101E, FC1221E, FC1221G, FC241, FC241E, FC241G, FC61, FC611E, FC611G, FC61E, FCV101, FCV101DM, FCV101DS, FCV101E, FCV101EDM, FCV101EDS, FCV141, FCV141DM, FCV141DS, FCV141E, FCV141EDM, FCV141EDS, FCV241, FCV241DM, FCV241DS, FCV241E, FCV241EDM, FCV241EDS, FCV241G, FCV241GDM, FCV241GDS, FCV401DM, FCV401EDM, FCV61, FCV61DM, FCV61DS, FCV61E, FCV61EDM, FCV61EDS, FM1011E1, FM1011E1-VERS.2006, FM1011E2, FM1011E2-VERS.2006, FM1011E3, FM1011E3-VERS.2006, FM1011G1, FM1011G1-VERS.2006...(Weitere Modelle finden Sie in unserem Webshop)		

			
<b>GEV-Nr.</b>	690136	<b>Vergl.-Nr.</b>	3FL0197
<b>Beschreibung</b>	Gleitplatte EP rechts L 28mm H 3mm B 21mm H2 12.5mm		
<b>Für Modelle:</b>	FCV101-CSA, FCV101DM-CSA, FCV101DS-CSA, FCV101EDM-UL, FCV101EDS-UL, FCV101E-UL, FCV141-CSA, FCV141DM-CSA, FCV141DS-CSA, FCV241EDM-UL, FCV241EDS-UL, FCV241E-UL, FCV241G-CSA, FCV241GDM-CSA, FCV241GDS-CSA, FCV401DM-CSA, FCV401EDM-UL, FCV61-CSA, FCV61DM-CSA, FCV61DS-CSA, FCV61EDM-UL, FCV61EDS-UL, FCV61E-UL, FCV72EDM-UL, FCV72EDS-UL, FCV72E-UL		

			
<b>GEV-Nr.</b>	700098	<b>Vergl.-Nr.</b>	36M0820
<b>Beschreibung</b>	Kloben EP rechts Überschlag 38mm L 110mm H 74mm B 33mm BA 68/68mm Serie 1750		
<b>Für Modelle:</b>	FC101, FC101E, FC241, FC241E, FC241G, FC61, FC61E, FCV101, FCV101-CSA, FCV101DM, FCV101DM-CSA, FCV101DS, FCV101DS-CSA, FCV101E, FCV101EDM, FCV101EDM-UL, FCV101EDS, FCV101EDS-UL, FCV101E-UL, FCV141, FCV141-CSA, FCV141DM, FCV141DM-CSA, FCV141DS, FCV141DS-CSA, FCV141E, FCV141EDM, FCV141EDS, FCV241, FCV241DM, FCV241DS, FCV241E, FCV241EDM, FCV241EDM-UL, FCV241EDS, FCV241EDS-UL, FCV241E-UL, FCV241G, FCV241G-CSA, FCV241GDM, FCV241GDM-CSA, FCV241GDS, FCV241GDS-CSA, FCV401DM, FCV401DM-CSA, FCV401EDM, FCV401EDM-UL, FCV61, FCV61-CSA, FCV61DM...(Weitere Modelle finden Sie in unserem Webshop)		
<b>Ersatzteile für</b>	700098		
		<b>GEV-Nr.</b>	690136
		<b>Vergl.-Nr.</b>	3FL0197
	Gleitplatte EP rechts L 28mm H 3mm B 21mm H2 12.5mm		
<b>Zubehör für</b>	700098		
		<b>GEV-Nr.</b>	514281
		<b>Vergl.-Nr.</b>	36M1570
	Unterlegplatte L 110mm B 35mm für Kloben Stärke 10mm		

<b>STUV</b>			
			
<b>GEV-Nr.</b>	700098	<b>Vergl.-Nr.</b>	36M0820
<b>Beschreibung</b>	Kloben EP rechts Überschlag 38mm L 110mm H 74mm B 33mm BA 68/68mm Serie 1750		
<b>Für Modelle:</b>	FC101, FC101E, FC241, FC241E, FC241G, FC61, FC61E, FCV101, FCV101-CSA, FCV101DM, FCV101DM-CSA, FCV101DS, FCV101DS-CSA, FCV101E, FCV101EDM, FCV101EDM-UL, FCV101EDS, FCV101EDS-UL, FCV101E-UL, FCV141, FCV141-CSA, FCV141DM, FCV141DM-CSA, FCV141DS, FCV141DS-CSA, FCV141E, FCV141EDM, FCV141EDS, FCV241, FCV241DM, FCV241DS, FCV241E, FCV241EDM, FCV241EDM-UL, FCV241EDS, FCV241EDS-UL, FCV241E-UL, FCV241G, FCV241G-CSA, FCV241GDM, FCV241GDM-CSA, FCV241GDS, FCV241GDS-CSA, FCV401DM, FCV401DM-CSA, FCV401EDM, FCV401EDM-UL, FCV61, FCV61-CSA, FCV61DM...(Weitere Modelle finden Sie in unserem Webshop)		
<b>Zubehör für</b>	700098		
		<b>GEV-Nr.</b>	514281
		<b>Vergl.-Nr.</b>	36M1570
	Unterlegplatte L 110mm B 35mm für Kloben Stärke 10mm		

<b>Herstellerspezifisch</b>			
<b>ANGELO PO</b>			
			
<b>GEV-Nr.</b>	694227	<b>Vergl.-Nr.</b>	36E2570
<b>Beschreibung</b>	Hebelverschluss MEC		
<b>Für Modelle:</b>	FC1011E, FC1011G, FC1221E, FC1221G, FC611E, FC611G, FM1011E1, FM1011E1-VERS.2006, FM1011E2, FM1011E2-VERS.2006, FM1011E3, FM1011E3-VERS.2006, FM1011G1, FM1011G1-VERS.2006, FM1011G2, FM1011G2-VERS.2006, FM1011G3, FM1011G3-VERS.2006, FM1221E1, FM1221E1-VERS.2006, FM1221E2, FM1221E2-VERS.2006, FM1221E3, FM1221E3-VERS.2006, FM1221G1, FM1221G1-VERS.2006, FM1221G2, FM1221G2-VERS.2006, FM1221G3, FM1221G3-VERS.2006, FM2011E2-VERS.2006, FM2011E3-VERS.2006, FM2011G2-VERS.2006, FM2011G3-VERS.2006, FM2021E1, FM2021E2, FM2021E2-VERS.2006, FM2021E3, FM2021E3-VERS.2006, FM2021G1, FM2021G2, FM2021G2-VERS.2006, FM2021G3, FM2021G3-VERS.2006, FM611E1, FM611E1-VERS.2006, FM611E2, FM611E2-VERS.2006, FM611E3, FM611E3-VERS.2006...(Weitere Modelle finden Sie in unserem Webshop)		
<b>Zubehör für</b>	694227		
		<b>GEV-Nr.</b>	694640
		<b>Vergl.-Nr.</b>	36E2580 36E2581
	Kloben H 42mm EP links L 98mm B 42mm für Drehhebelschluss		





			
<b>GEV-Nr.</b>	694640	<b>Vergl.-Nr.</b>	36E2580 36E2581
<b>Beschreibung</b>	Kloben H 42mm EP links L 98mm B 42mm für Drehhebelverschluss		
<b>Für Modelle:</b>	FC1011E, FC1011G, FC1221E, FC1221G, FC611E, FC611G, FM1011E1, FM1011E1-VERS.2006, FM1011E2, FM1011E2-VERS.2006, FM1011E3, FM1011E3-VERS.2006, FM1011G1, FM1011G1-VERS.2006, FM1011G2, FM1011G2-VERS.2006, FM1011G3, FM1011G3-VERS.2006, FM1221E1, FM1221E1-VERS.2006, FM1221E2, FM1221E2-VERS.2006, FM1221E3, FM1221E3-VERS.2006, FM1221G1, FM1221G1-VERS.2006, FM1221G2, FM1221G2-VERS.2006, FM1221G3, FM1221G3-VERS.2006, FM2011E2-VERS.2006, FM2011E3-VERS.2006, FM2011G2-VERS.2006, FM2011G3-VERS.2006, FM2021E1, FM2021E2, FM2021E2-VERS.2006, FM2021E3, FM2021E3-VERS.2006, FM2021G1, FM2021G2, FM2021G2-VERS.2006, FM2021G3, FM2021G3-VERS.2006, FM611E1, FM611E1-VERS.2006, FM611E2, FM611E2-VERS.2006, FM611E3, FM611E3-VERS.2006... (Weitere Modelle finden Sie in unserem Webshop)		
<b>Zubehör für</b>	694640		
		<b>GEV-Nr.</b> 694227	<b>Vergl.-Nr.</b> 36E2570
	Hebelverschluss MEC		

			
<b>GEV-Nr.</b>	691174	<b>Vergl.-Nr.</b>	35V9050
<b>Beschreibung</b>	Gegenstück L 90mm B 60mm für Türverschluss		
<b>Für Modelle:</b>	FC101, FC101E, FC241E, FC241G, FC61, FC61E, FCV101, FCV101-CSA, FCV101DM, FCV101DM-CSA, FCV101DS, FCV101DS-CSA, FCV101E, FCV101EDM, FCV101EDM-UL, FCV101EDS, FCV101EDS-UL, FCV101E-UL, FCV141, FCV141-CSA, FCV141DM, FCV141DM-CSA, FCV141DS, FCV141DS-CSA, FCV141E, FCV141EDM, FCV141EDS, FCV241E, FCV241EDM, FCV241EDM-UL, FCV241EDS, FCV241EDS-UL, FCV241G, FCV241G-CSA, FCV241GDM, FCV241GDM-CSA, FCV241GDS, FCV241GDS-CSA, FCV61, FCV61-CSA, FCV61DM, FCV61DM-CSA, FCV61DS, FCV61DS-CSA, FCV61E, FCV61EDM, FCV61EDM-UL, FCV61EDS, FCV61EDS-UL, FCV61E-UL... (Weitere Modelle finden Sie in unserem Webshop)		

			
<b>GEV-Nr.</b>	690136	<b>Vergl.-Nr.</b>	3FL0197
<b>Beschreibung</b>	Gleitplatte EP rechts L 28mm H 3mm B 21mm H2 12.5mm		
<b>Für Modelle:</b>	FCV101-CSA, FCV101DM-CSA, FCV101DS-CSA, FCV101EDM-UL, FCV101EDS-UL, FCV101E-UL, FCV141-CSA, FCV141DM-CSA, FCV141DS-CSA, FCV241EDM-UL, FCV241EDS-UL, FCV241E-UL, FCV241G-CSA, FCV241GDM-CSA, FCV241GDS-CSA, FCV401DM-CSA, FCV401EDM-UL, FCV61-CSA, FCV61DM-CSA, FCV61DS-CSA, FCV61EDM-UL, FCV61EDS-UL, FCV61E-UL, FCV72EDM-UL, FCV72EDS-UL, FCV72E-UL		

			
<b>GEV-Nr.</b>	690500	<b>Vergl.-Nr.</b>	36M0880 36M3180 36M6380 6300421
<b>Beschreibung</b>	Hebelverschluss rechts L 185mm H 66mm Griffmaterial Kunststoff Typ Serie 6300		
<b>Für Modelle:</b>	FC101, FC101E, FC241, FC241E, FC241G, FC61, FC61E, FCV101, FCV101-CSA, FCV101DM, FCV101DM-CSA, FCV101DS, FCV101DS-CSA, FCV101E, FCV101EDM, FCV101EDM-UL, FCV101EDS, FCV101EDS-UL, FCV101E-UL, FCV141, FCV141-CSA, FCV141DM, FCV141DM-CSA, FCV141DS, FCV141DS-CSA, FCV141E, FCV141EDM, FCV141EDS, FCV241, FCV241DM, FCV241DS, FCV241E, FCV241EDM, FCV241EDM-UL, FCV241EDS, FCV241EDS-UL, FCV241E-UL, FCV241G, FCV241G-CSA, FCV241GDM, FCV241GDM-CSA, FCV241GDS, FCV241GDS-CSA, FCV401DM, FCV401DM-CSA, FCV401EDM, FCV401EDM-UL, FCV61, FCV61-CSA, FCV61DM... (Weitere Modelle finden Sie in unserem Webshop)		
<b>Zubehör für</b>	690500		
		<b>GEV-Nr.</b> 514281	<b>Vergl.-Nr.</b> 36M1570
	Unterlegplatte L 110mm B 35mm für Kloben Stärke 10mm		
		<b>GEV-Nr.</b> 690136	<b>Vergl.-Nr.</b> 3FL0197
	Gleitplatte EP rechts L 28mm H 3mm B 21mm H2 12.5mm		
		<b>GEV-Nr.</b> 691174	<b>Vergl.-Nr.</b> 35V9050
	Gegenstück L 90mm B 60mm für Türverschluss		
		<b>GEV-Nr.</b> 700091	<b>Vergl.-Nr.</b> —
	Kloben EP rechts Überschlag 20mm L 110mm H 56mm B 33mm BA 68/68mm Zink Druckguss Serie 6300		
		<b>GEV-Nr.</b> 700098	<b>Vergl.-Nr.</b> 36M0820
	Kloben EP rechts Überschlag 38mm L 110mm H 74mm B 33mm BA 68/68mm Serie 1750		

			
<b>GEV-Nr.</b>	700711	<b>Vergl.-Nr.</b>	6300420
<b>Beschreibung</b>	Kloben		
<b>Für Modelle:</b>	FC101, FC101E, FC241, FC241E, FC241G, FC61, FC61E, FCV101, FCV101-CSA, FCV101DM, FCV101DM-CSA, FCV101DS, FCV101DS-CSA, FCV101E, FCV101EDM, FCV101EDM-UL, FCV101EDS, FCV101EDS-UL, FCV101E-UL, FCV141, FCV141-CSA, FCV141DM, FCV141DM-CSA, FCV141DS, FCV141DS-CSA, FCV141E, FCV141EDM, FCV141EDS, FCV241, FCV241DM, FCV241DS, FCV241E, FCV241EDM, FCV241EDM-UL, FCV241EDS, FCV241EDS-UL, FCV241E-UL, FCV241G, FCV241G-CSA, FCV241GDM, FCV241GDM-CSA, FCV241GDS, FCV241GDS-CSA, FCV401DM, FCV401DM-CSA, FCV401EDM, FCV401EDM-UL, FCV61, FCV61-CSA, FCV61DM... (Weitere Modelle finden Sie in unserem Webshop)		
<b>Zubehör für</b>	700711		
		<b>GEV-Nr.</b> 514281	<b>Vergl.-Nr.</b> 36M1570
	Unterlegplatte L 110mm B 35mm für Kloben Stärke 10mm		

Tabellenfortsetzung auf der nächsten Seite

<b>Zubehör für</b>	700711		
	<b>GEV-Nr.</b>	700098	<b>Vergl.-Nr.</b> 36M0820
Kloben EP rechts Überschlag 38mm L 110mm H 74mm B 33mm BA 68/68mm Serie 1750			



<b>GEV-Nr.</b>	700098	<b>Vergl.-Nr.</b>	36M0820
<b>Beschreibung</b>	Kloben EP rechts Überschlag 38mm L 110mm H 74mm B 33mm BA 68/68mm Serie 1750		
<b>Für Modelle:</b>	FC101, FC101E, FC241, FC241E, FC241G, FC61, FC61E, FCV101, FCV101-CSA, FCV101DM, FCV101DM-CSA, FCV101DS, FCV101DS-CSA, FCV101E, FCV101EDM, FCV101EDM-UL, FCV101EDS, FCV101EDS-UL, FCV101E-UL, FCV141, FCV141-CSA, FCV141DM, FCV141DM-CSA, FCV141DS, FCV141DS-CSA, FCV141E, FCV141EDM, FCV141EDS, FCV241, FCV241DM, FCV241DS, FCV241E, FCV241EDM, FCV241EDM-UL, FCV241EDS, FCV241EDS-UL, FCV241E-UL, FCV241G, FCV241G-CSA, FCV241GDM, FCV241GDM-CSA, FCV241GDS, FCV241GDS-CSA, FCV401DM, FCV401DM-CSA, FCV401EDM, FCV401EDM-UL, FCV61, FCV61-CSA, FCV61DM...(Weitere Modelle finden Sie in unserem Webshop)		

<b>Ersatzteile für</b>	700098		
	<b>GEV-Nr.</b>	690136	<b>Vergl.-Nr.</b> 3FL0197
Gleitplatte EP rechts L 28mm H 3mm B 21mm H2 12.5mm			

<b>Zubehör für</b>	700098		
	<b>GEV-Nr.</b>	514281	<b>Vergl.-Nr.</b> 36M1570
Unterlegplatte L 110mm B 35mm für Kloben Stärke 10mm			



<b>GEV-Nr.</b>	514281	<b>Vergl.-Nr.</b>	36M1570
<b>Beschreibung</b>	Unterlegplatte L 110mm B 35mm für Kloben Stärke 10mm		
<b>Für Modelle:</b>	FC101, FC101E, FC241, FC241E, FC241G, FC61, FC61E, FCV101, FCV101-CSA, FCV101DM, FCV101DM-CSA, FCV101DS, FCV101DS-CSA, FCV101E, FCV101EDM, FCV101EDM-UL, FCV101EDS, FCV101EDS-UL, FCV101E-UL, FCV141, FCV141-CSA, FCV141DM, FCV141DM-CSA, FCV141DS, FCV141DS-CSA, FCV141E, FCV141EDM, FCV141EDS, FCV241, FCV241DM, FCV241DS, FCV241E, FCV241EDM, FCV241EDM-UL, FCV241EDS, FCV241EDS-UL, FCV241E-UL, FCV241G, FCV241G-CSA, FCV241GDM, FCV241GDM-CSA, FCV241GDS, FCV241GDS-CSA, FCV61, FCV61-CSA, FCV61DM, FCV61DM-CSA, FCV61DS, FCV61DS-CSA, FCV61E...(Weitere Modelle finden Sie in unserem Webshop)		

## Hebelverschlüsse

### Universal

### Innenbefestigung

### Verschlüsse





<b>GEV-Nr.</b>	694054	<b>Vergl.-Nr.</b>	36M7000
<b>Beschreibung</b>	Türgriff für Heißgeräte L 145mm B 40mm H 62mm Federlänge 33mm innen schwarz		
<b>Für Modelle:</b>	BX101E, BX101E-VERS.122013, BX101G, BX101G-VERS.122013, BX122E, BX122E-VERS.122013, BX122G, BX122G-VERS.122013, BX61E, BX61E-VERS.122013, BX61G, BX61G-VERS.122013, BX82E, BX82E-VERS.122013, BX82G, BX82G-VERS.122013, FCV3EM, FCV4E, FCV4EDS, FCV4EM, FM423E1, FM423E2		

<b>Ersatzteile für</b>	694054		
------------------------	--------	--	--

	<b>GEV-Nr.</b>	514390	<b>Vergl.-Nr.</b>	3005920 3236250
Feder für Türgriff ø 6mm L 54mm B 27.5mm				

	<b>GEV-Nr.</b>	694675	<b>Vergl.-Nr.</b>	—
Türverschluss L 88mm B 40mm H 37mm Federlänge 33mm BA 60mm				

	<b>GEV-Nr.</b>	694734	<b>Vergl.-Nr.</b>	—
Türgriff L 165mm B 40mm H 25mm schwarz				

	<b>GEV-Nr.</b>	694735	<b>Vergl.-Nr.</b>	—
Verschlusskappe ø 32mm schwarz				

<b>Zubehör für</b>	694054			
--------------------	--------	--	--	--

	<b>GEV-Nr.</b>	691123	<b>Vergl.-Nr.</b>	36E2060
Durchführung für Türöffner				

	<b>GEV-Nr.</b>	694055	<b>Vergl.-Nr.</b>	3238740 3238750 36C4391
Kloben L 25mm B 14mm Gesamtlänge 54mm Gewinde M8 Gewinde L 29mm				

	<b>GEV-Nr.</b>	694066	<b>Vergl.-Nr.</b>	—
Kloben mit Zapfen 2-stufig L 28mm B 14mm H 15mm H1 16mm Gesamtlänge 51mm Gewinde M8 Gewinde L 23mm Edelstahl				

	<b>GEV-Nr.</b>	694067	<b>Vergl.-Nr.</b>	3108770
Kloben mit Zapfen 1-stufig L 26mm Gesamtlänge 51mm Gewinde M8				





Herstellerspezifisch			
ANGELO PO			
			
1			
<b>GEV-Nr.</b>	514289	<b>Vergl.-Nr.</b>	36D3670
<b>Beschreibung</b>	Buchse für Türmechanik		
<b>Für Modelle:</b>	FCV3EM, FCV4E, FCV4EDS, FCV4EM		



			
1			
<b>GEV-Nr.</b>	514287	<b>Vergl.-Nr.</b>	36Q1360
<b>Beschreibung</b>	Buchse H 8mm Materialstärke 2mm D1 ø 14mm D2 ø 10mm		
<b>Für Modelle:</b>	FCV3EM, FCV4E, FCV4EDS, FCV4EM		

			
1			
<b>GEV-Nr.</b>	514286	<b>Vergl.-Nr.</b>	36D8011
<b>Beschreibung</b>	Hülse L 15mm M20x1,5		
<b>Für Modelle:</b>	FCV3EM, FCV4E, FCV4EDS, FCV4EM		

			
1			
<b>GEV-Nr.</b>	111746	<b>Vergl.-Nr.</b>	37M4700
<b>Beschreibung</b>	Knebsymbol B 1mm ø 36mm		
<b>Für Modelle:</b>	FCV3EM, FCV4EM		

				
1				
<b>GEV-Nr.</b>	514290	<b>Vergl.-Nr.</b>	36M5340	
<b>Beschreibung</b>	Türgriff L 150mm B 42mm H 57mm schwarz Kunststoff Achse 8x8mm Aufnahme vierkant			
<b>Für Modelle:</b>	FCV3EM, FCV4E, FCV4EDS, FCV4EM			
<b>Zubehör für</b>	514290			
	<b>GEV-Nr.</b>	111746	<b>Vergl.-Nr.</b>	37M4700
	Knebsymbol B 1mm ø 36mm			
	<b>GEV-Nr.</b>	111786	<b>Vergl.-Nr.</b>	37M4040
	Knebsymbol			
	<b>GEV-Nr.</b>	514286	<b>Vergl.-Nr.</b>	36D8011
	Hülse L 15mm M20x1,5			

<b>Zubehör für</b>	514290			
	<b>GEV-Nr.</b>	514287	<b>Vergl.-Nr.</b>	36Q1360
	Buchse H 8mm Materialstärke 2mm D1 ø 14mm D2 ø 10mm			
	<b>GEV-Nr.</b>	514288	<b>Vergl.-Nr.</b>	30G1650 30G2192
	Türverschluss ø 10mm L 102mm Klobenhöhe 24mm G1: M8 G2: M20x1,5			
	<b>GEV-Nr.</b>	514289	<b>Vergl.-Nr.</b>	36D3670
	Buchse für Türmechanik			

				
1				
<b>GEV-Nr.</b>	514288	<b>Vergl.-Nr.</b>	30G1650 30G2192	
<b>Beschreibung</b>	Türverschluss ø 10mm L 102mm Klobenhöhe 24mm G1: M8 G2: M20x1,5			
<b>Für Modelle:</b>	FCV3EM, FCV4E, FCV4EDS, FCV4EM			
<b>Zubehör für</b>	514288			
	<b>GEV-Nr.</b>	514287	<b>Vergl.-Nr.</b>	36Q1360
	Buchse H 8mm Materialstärke 2mm D1 ø 14mm D2 ø 10mm			

			
1			
<b>GEV-Nr.</b>	691123	<b>Vergl.-Nr.</b>	36E2060
<b>Beschreibung</b>	Durchführung für Türöffner		
<b>Für Modelle:</b>	FCV3EM, FCV4E, FCV4EDS, FCV4EM, FM423E1, FM423E2		

			
1			
<b>GEV-Nr.</b>	514390	<b>Vergl.-Nr.</b>	3005920 3236250
<b>Beschreibung</b>	Feder für Türgriff ø 6mm L 54mm B 27.5mm		
<b>Für Modelle:</b>	BX101E, BX101E-VERS.122013, BX101G, BX101G-VERS.122013, BX122E, BX122E-VERS.122013, BX122G, BX122G-VERS.122013, BX61E, BX61E-VERS.122013, BX61G, BX61G-VERS.122013, BX82E, BX82E-VERS.122013, BX82G, BX82G-VERS.122013, FCV3EM, FCV4E, FCV4EDS, FCV4EM, FM423E1, FM423E2, FX101E1R, FX101E2R, FX101E2R-VERS.032014, FX101E3R, FX101E3R-VERS.022014, FX101G1R, FX101G2R, FX101G2R-VERS.032014, FX101G3R, FX101G3R-VERS.022014, FX10E2CR, FX10E2CR-VERS.032014, FX10E3CR, FX10E3CR-VERS.022014, FX10G2CR, FX10G2CR-VERS.032014, FX10G3CR, FX10G3CR-VERS.022014, FX61E1R, FX61E2CR, FX61E2CR-VERS.032014, FX61E2R, FX61E2R-VERS.032014, FX61E3CR, FX61E3CR-VERS.022014, FX61E3R, FX61E3R-VERS.022014, FX61G1R...(Weitere Modelle finden Sie in unserem Webshop)		

			
1			
<b>GEV-Nr.</b>	694055	<b>Vergl.-Nr.</b>	3238740 3238750 36C4391
<b>Beschreibung</b>	Kloben L 25mm B 14mm Gesamtlänge 54mm Gewinde M8 Gewinde L 29mm		
<b>Für Modelle:</b>	BX101E, BX101E-VERS.122013, BX101G, BX101G-VERS.122013, BX122E, BX122E-VERS.122013, BX122G, BX122G-VERS.122013, BX61E, BX61E-VERS.122013, BX61G, BX61G-VERS.122013, BX82E, BX82E-VERS.122013, BX82G, BX82G-VERS.122013, FCV3EM, FCV4E, FCV4EDS, FCV4EM, FM423E1, FM423E2, FX101E1, FX101E1R, FX101E2, FX101E2C, FX101E2C-VERS.032014, FX101E2R, FX101E2R-VERS.032014, FX101E2-VERS.032014, FX101E3, FX101E3C, FX101E3C-VERS.022014, FX101E3R, FX101E3R-VERS.022014, FX101E3-VERS.022014, FX101G1, FX101G1R, FX101G2, FX101G2C, FX101G2C-VERS.032014, FX101G2R, FX101G2R-VERS.032014, FX101G2-VERS.032014, FX101G3, FX101G3C, FX101G3C-VERS.022014, FX101G3R, FX101G3R-VERS.022014, FX101G3-VERS.022014...(Weitere Modelle finden Sie in unserem Webshop)		
<b>Zubehör für</b>	694055		
	<b>GEV-Nr.</b>	694772	<b>Vergl.-Nr.</b> 36E2490
Schutzkappe für Kloben ø 21mm			

			
1			
<b>GEV-Nr.</b>	517174	<b>Vergl.-Nr.</b>	3110050 33Q6470
<b>Beschreibung</b>	Mutter Gewinde M8 H 6.5mm SW 13 CNS DIN/ISO DIN 934 / ISO 4032/8673 VPE 1 Stück		
<b>Für Modelle:</b>	04WBMEV, 091FR1EA, 091FR1EX, 091FR1IA, 091FR7GS, 091FR7GX, 6043850, 6043980, 71ARE, 91ARE, BRE21HD, BRE31HD, C165D, C165S, C165VD, C165VS, C207D, C207D-VERS.2006, C207S, C207S-VERS.2006, C207VD, C207VD-VERS.2006, C207VS, C207VS-VERS.2006, C304AD, C304AD-VERS.2006, C304AS, C304AS-VERS.2006, C304AVD, C304AVD-VERS.2006, C304AVS, C304AVS-VERS.2006, C304D, C304D-VERS.2006, C304S, C304S-VERS.2006, C304VD, C304VD-VERS.2006, C304VS, C304VS-VERS.2006, C92D-VERS.2006, C92S-VERS.2006, C92VD-VERS.2006, C92VS-VERS.2006, CS243D, CS243D-VERS.2006, CS243S, CS243S-VERS.2006, CS243VD, CS243VD-VERS.2006...(Weitere Modelle finden Sie in unserem Webshop)		

			
1			
<b>GEV-Nr.</b>	694772	<b>Vergl.-Nr.</b>	36E2490
<b>Beschreibung</b>	Schutzkappe für Kloben ø 21mm		
<b>Für Modelle:</b>	BX101E, BX101E-VERS.122013, BX101G, BX101G-VERS.122013, BX122E, BX122E-VERS.122013, BX122G, BX122G-VERS.122013, BX61E, BX61E-VERS.122013, BX61G, BX61G-VERS.122013, BX82E, BX82E-VERS.122013, BX82G, BX82G-VERS.122013, FCV3EM, FCV4E, FCV4EDS, FCV4EM, FM423E1, FM423E2, FX101E1, FX101E1R, FX101E2, FX101E2C, FX101E2C-VERS.032014, FX101E2R, FX101E2R-VERS.032014, FX101E2-VERS.032014, FX101E3, FX101E3C, FX101E3C-VERS.022014, FX101E3R, FX101E3R-VERS.022014, FX101E3-VERS.022014, FX101G1, FX101G1R, FX101G2, FX101G2C, FX101G2C-VERS.032014, FX101G2R, FX101G2R-VERS.032014, FX101G2-VERS.032014, FX101G3, FX101G3C, FX101G3C-VERS.022014, FX101G3R, FX101G3R-VERS.022014, FX101G3-VERS.022014...(Weitere Modelle finden Sie in unserem Webshop)		

			
1			
<b>GEV-Nr.</b>	694054	<b>Vergl.-Nr.</b>	36M7000
<b>Beschreibung</b>	Türgriff für Heißgeräte L 145mm B 40mm H 62mm Federlänge 33mm innen schwarz		
<b>Für Modelle:</b>	BX101E, BX101E-VERS.122013, BX101G, BX101G-VERS.122013, BX122E, BX122E-VERS.122013, BX122G, BX122G-VERS.122013, BX61E, BX61E-VERS.122013, BX61G, BX61G-VERS.122013, BX82E, BX82E-VERS.122013, BX82G, BX82G-VERS.122013, FCV3EM, FCV4E, FCV4EDS, FCV4EM, FM423E1, FM423E2		
<b>Ersatzteile für</b>	694054		
	<b>GEV-Nr.</b>	514390	<b>Vergl.-Nr.</b> 3005920 3236250
Feder für Türgriff ø 6mm L 54mm B 27.5mm			
	<b>GEV-Nr.</b>	694675	<b>Vergl.-Nr.</b> —
Türverschluss L 88mm B 40mm H 37mm Federlänge 33mm BA 60mm			
	<b>GEV-Nr.</b>	694734	<b>Vergl.-Nr.</b> —
Türgriff L 165mm B 40mm H 25mm schwarz			
	<b>GEV-Nr.</b>	694735	<b>Vergl.-Nr.</b> —
Verschlusskappe ø 32mm schwarz			
<b>Zubehör für</b>	694054		
	<b>GEV-Nr.</b>	691123	<b>Vergl.-Nr.</b> 36E2060
Durchführung für Türöffner			
	<b>GEV-Nr.</b>	694055	<b>Vergl.-Nr.</b> 3238740 3238750 36C4391
Kloben L 25mm B 14mm Gesamtlänge 54mm Gewinde M8 Gewinde L 29mm			
	<b>GEV-Nr.</b>	694066	<b>Vergl.-Nr.</b> —
Kloben mit Zapfen 2-stufig L 28mm B 14mm H 15mm H1 16mm Gesamtlänge 51mm Gewinde M8 Gewinde L 23mm Edelstahl			
	<b>GEV-Nr.</b>	694067	<b>Vergl.-Nr.</b> 3108770
Kloben mit Zapfen 1-stufig L 26mm Gesamtlänge 51mm Gewinde M8			







Griffe			
			
1			
GEV-Nr.	694631	Vergl.-Nr.	3104201 3104202 3104203
Beschreibung	Türgriff für Kombidämpfer L 210mm B 170mm H 55mm silber Kunststoff		
Für Modelle:	FX101E1, FX101E2, FX101E2C, FX101E2C-VERS.032014, FX101E2-VERS.032014, FX101E3, FX101E3C, FX101E3C-VERS.022014, FX101E3R, FX101E3-VERS.022014, FX101G1, FX101G2, FX101G2C, FX101G2C-VERS.032014, FX101G2-VERS.032014, FX101G3, FX101G3C, FX101G3C-VERS.022014, FX101G3-VERS.022014, FX10E2CR-VERS.032014, FX122E1, FX122E2, FX122E2C, FX122E2T, FX122E2T-VERS.032014, FX122E3, FX122E3C, FX122E3T, FX122E3T-VERS.022014, FX122G1, FX122G3, FX122G3C, FX122G3T, FX122G3T-VERS.022014, FX12E3CT, FX12E3CT-VERS.022014, FX12G3CT, FX12G3CT-VERS.022014, FX201E2, FX201E2P, FX201E2P-VERS.032014, FX201E2-VERS.032014, FX201E3, FX201E3P, FX201E3P-VERS.022014, FX201E3-VERS.022014, FX201G2, FX201G2P, FX201G2P-VERS.032014, FX201G2-VERS.032014...(Weitere Modelle finden Sie in unserem Webshop)		

Herstellerspezifisch			
ANGELO PO			
			
1			
GEV-Nr.	692718	Vergl.-Nr.	3104151 3104152 3104153
Beschreibung	Abdeckkappe ø 38.5mm		
Für Modelle:	FX101E1, FX101E2, FX101E2C, FX101E2C-VERS.032014, FX101E2-VERS.032014, FX101E3, FX101E3C, FX101E3C-VERS.022014, FX101E3R, FX101E3-VERS.022014, FX101G1, FX101G2, FX101G2C, FX101G2C-VERS.032014, FX101G2-VERS.032014, FX101G3, FX101G3C, FX101G3C-VERS.022014, FX101G3-VERS.022014, FX10E2CR-VERS.032014, FX122E1, FX122E2, FX122E2C, FX122E2T, FX122E2T-VERS.032014, FX122E3, FX122E3C, FX122E3T, FX122E3T-VERS.022014, FX122G1, FX122G3, FX122G3C, FX122G3T, FX122G3T-VERS.022014, FX12E3CT, FX12E3CT-VERS.022014, FX12G3CT, FX12G3CT-VERS.022014, FX201E2, FX201E2P, FX201E2P-VERS.032014, FX201E2-VERS.032014, FX201E3, FX201E3P, FX201E3P-VERS.022014, FX201E3-VERS.022014, FX201G2, FX201G2P, FX201G2P-VERS.032014, FX201G2-VERS.032014...(Weitere Modelle finden Sie in unserem Webshop)		

Kantenverschlüsse			
Kloben			
			
1			
GEV-Nr.	690428	Vergl.-Nr.	36M0480
Beschreibung	Kloben H 51mm B 13.9mm BA 30mm Kunststoff KS 16.5mm		

			
1			
GEV-Nr.	692720	Vergl.-Nr.	3101630
Beschreibung	Dichtung für Türverschluss PTFE D1 ø 26mm D2 ø 11.7mm Stärke 2mm		
Für Modelle:	FX201E2, FX201E2P, FX201E2P-VERS.032014, FX201E2-VERS.032014, FX201E3, FX201E3P, FX201E3P-VERS.022014, FX201E3-VERS.022014, FX201G2, FX201G2P, FX201G2P-VERS.032014, FX201G2-VERS.032014, FX201G3P, FX201G3-VERS.022014, FX202E2, FX202E2-VERS.032014, FX202E3, FX202E3-230V-3-50Hz-60Hz, FX202E3-230V-3-50Hz-60Hz-VERS.022014, FX202E3-VERS.022014, FX202G2, FX202G2-VERS.032014, FX202G3, FX202G3-VERS.022014		

Schnappverschlüsse			
Universal			
			
1			
GEV-Nr.	690596	Vergl.-Nr.	36M3600
Beschreibung	Schnappverschluss L 60mm B 15mm H 36mm BA 48/28mm Federstärke 1.5mm komplett mit Kloben Zamak		

			
1			
GEV-Nr.	698478	Vergl.-Nr.	3142670
Beschreibung	Kupplung für Ofen für Tür L 80mm B 26mm Aufnahme 8x8		
Für Modelle:	FX201E2, FX201E2P, FX201E2P-VERS.032014, FX201E2-VERS.032014, FX201E3, FX201E3P, FX201E3P-VERS.022014, FX201E3-VERS.022014, FX201G2, FX201G2P, FX201G2P-VERS.032014, FX201G2-VERS.032014, FX201G3P, FX201G3-VERS.022014, FX202E2, FX202E2-VERS.032014, FX202E3, FX202E3-230V-3-50Hz-60Hz, FX202E3-230V-3-50Hz-60Hz-VERS.022014, FX202E3-VERS.022014, FX202G2, FX202G2-VERS.032014, FX202G3, FX202G3-VERS.022014		

Treibriegelverschlüsse			
Universal			
			
1			
GEV-Nr.	690041	Vergl.-Nr.	3088460
Beschreibung	Riegel L 148mm BA 32mm		



			
<b>GEV-Nr.</b>	698503	<b>Vergl.-Nr.</b>	6300965
<b>Beschreibung</b>	Treibriegelverschluss komplett		
<b>Für Modelle:</b>	FX201E2, FX201E2P, FX201E2P-VERS.032014, FX201E2-VERS.032014, FX201E3, FX201E3P, FX201E3P-VERS.022014, FX201E3-VERS.022014, FX201G2, FX201G2P, FX201G2P-VERS.032014, FX201G2-VERS.032014, FX201G3P, FX201G3-VERS.022014, FX202E2, FX202E2-VERS.032014, FX202E3, FX202E3-230V-3-50Hz-60Hz, FX202E3-230V-3-50Hz-60Hz-VERS.022014, FX202E3-VERS.022014, FX202G2, FX202G2-VERS.032014, FX202G3, FX202G3-VERS.022014		
<b>Zubehör für</b>	698503		
	<b>GEV-Nr.</b>	690041	<b>Vergl.-Nr.</b> 3088460
	Riegel L 148mm BA 32mm		
	<b>GEV-Nr.</b>	694409	<b>Vergl.-Nr.</b> —
	Montagesatz für Treibriegelverschluss 694382		
	<b>GEV-Nr.</b>	700604	<b>Vergl.-Nr.</b> —
	Verschlussgetriebe rechts öffnend Achsaufnahme ø 8x8mm L 170mm B 40mm H 40mm		

			
<b>GEV-Nr.</b>	694631	<b>Vergl.-Nr.</b>	3104201 3104202 3104203
<b>Beschreibung</b>	Türgriff für Kombidämpfer L 210mm B 170mm H 55mm silber Kunststoff		
<b>Für Modelle:</b>	FX101E1, FX101E2, FX101E2C, FX101E2C-VERS.032014, FX101E2-VERS.032014, FX101E3, FX101E3C, FX101E3C-VERS.022014, FX101E3R, FX101E3-VERS.022014, FX101G1, FX101G2, FX101G2C, FX101G2C-VERS.032014, FX101G2-VERS.032014, FX101G3, FX101G3C, FX101G3C-VERS.022014, FX101G3-VERS.022014, FX10E2CR-VERS.032014, FX122E1, FX122E2, FX122E2C, FX122E2T, FX122E2T-VERS.032014, FX122E3, FX122E3C, FX122E3T, FX122E3T-VERS.022014, FX122G1, FX122G3, FX122G3C, FX122G3T, FX122G3T-VERS.022014, FX12E3CT, FX12E3CT-VERS.022014, FX12G3CT, FX12G3CT-VERS.022014, FX201E2, FX201E2P, FX201E2P-VERS.032014, FX201E2-VERS.032014, FX201E3, FX201E3P, FX201E3P-VERS.022014, FX201E3-VERS.022014, FX201G2, FX201G2P, FX201G2P-VERS.032014, FX201G2-VERS.032014...(Weitere Modelle finden Sie in unserem Webshop)		

## Scharniere

### Scharnierbänder

#### Universal

			
<b>GEV-Nr.</b>	692866	<b>Vergl.-Nr.</b>	3085860
<b>Beschreibung</b>	Scharnier L 25mm BA 14mm Loch ø 3mm Materialstärke 1mm		
<b>Für Modelle:</b>	BX101E, BX101E-VERS.122013, BX101G, BX101G-VERS.122013, BX122E, BX122E-VERS.122013, BX122G, BX122G-VERS.122013, BX61E, BX61E-VERS.122013, BX61G, BX61G-VERS.122013, BX82E, BX82E-VERS.122013, BX82G, BX82G-VERS.122013, FX101E1, FX101E1R, FX101E2, FX101E2C, FX101E2C-VERS.032014, FX101E2R, FX101E2R-VERS.032014, FX101E2-VERS.032014, FX101E3, FX101E3C, FX101E3C-VERS.022014, FX101E3R, FX101E3R-VERS.022014, FX101E3-VERS.022014, FX101G1, FX101G1R, FX101G2, FX101G2C, FX101G2C-VERS.032014, FX101G2R, FX101G2R-VERS.032014, FX101G2-VERS.032014, FX101G3, FX101G3C, FX101G3C-VERS.022014, FX101G3R, FX101G3R-VERS.022014, FX101G3-VERS.022014, FX10E2CR, FX10E2CR-VERS.032014, FX10E3CR, FX10E3CR-VERS.022014, FX10G2CR, FX10G2CR-VERS.032014... (Weitere Modelle finden Sie in unserem Webshop)		

#### Türlager

			
<b>GEV-Nr.</b>	514282	<b>Vergl.-Nr.</b>	36M4122
<b>Beschreibung</b>	Drehlager EP rechts/links ohne Bolzen		
<b>Für Modelle:</b>	FC101, FC101E, FC241, FC241E, FC241G, FC61, FC61E, FCV101, FCV101-CSA, FCV101DM, FCV101DM-CSA, FCV101DS, FCV101DS-CSA, FCV101E, FCV101EDM, FCV101EDM-UL, FCV101EDS, FCV101EDS-UL, FCV101E-UL, FCV141, FCV141-CSA, FCV141DM, FCV141DM-CSA, FCV141DS, FCV141DS-CSA, FCV141E, FCV141EDM, FCV141EDS, FCV241, FCV241DM, FCV241DS, FCV241E, FCV241EDM, FCV241EDM-UL, FCV241EDS, FCV241EDS-UL, FCV241E-UL, FCV241G, FCV241G-CSA, FCV241GDM, FCV241GDM-CSA, FCV241GDS, FCV241GDS-CSA, FCV3EM, FCV401DM, FCV401DM-CSA, FCV401EDM, FCV401EDM-UL, FCV4E, FCV4EDS...(Weitere Modelle finden Sie in unserem Webshop)		

1

<b>GEV-Nr.</b>	692861	<b>Vergl.-Nr.</b>	36E2680
<b>Beschreibung</b>	Drehlager ohne Bolzen EP oben rechts		
<b>Für Modelle:</b>	FC1011E, FC1011G, FC1221E, FC1221G, FC611E, FC611G, FM1011E1, FM1011E1-VERS.2006, FM1011E2, FM1011E2-VERS.2006, FM1011E3, FM1011E3-VERS.2006, FM1011G1, FM1011G1-VERS.2006, FM1011G2, FM1011G2-VERS.2006, FM1011G3, FM1011G3-VERS.2006, FM1221E1, FM1221E1-VERS.2006, FM1221E2, FM1221E2-VERS.2006, FM1221E3, FM1221E3-VERS.2006, FM1221G1, FM1221G1-VERS.2006, FM1221G2, FM1221G2-VERS.2006, FM1221G3, FM1221G3-VERS.2006, FM2011E2-VERS.2006, FM2011E3-VERS.2006, FM2011G2-VERS.2006, FM2011G3-VERS.2006, FM2021E1, FM2021E2, FM2021E2-VERS.2006, FM2021E3, FM2021E3-VERS.2006, FM2021G1, FM2021G2, FM2021G2-VERS.2006, FM2021G3, FM2021G3-VERS.2006, FM611E1, FM611E1-VERS.2006, FM611E2, FM611E2-VERS.2006, FM611E3, FM611E3-VERS.2006... (Weitere Modelle finden Sie in unserem Webshop)		



2

<b>GEV-Nr.</b>	692862	<b>Vergl.-Nr.</b>	3108730
<b>Beschreibung</b>	Drehlager ohne Bolzen EP unten rechts		
<b>Für Modelle:</b>	BX101E, BX101E-VERS.122013, BX101G, BX101G-VERS.122013, BX122E, BX122E-VERS.122013, BX122G, BX122G-VERS.122013, BX61E, BX61E-VERS.122013, BX61G, BX61G-VERS.122013, BX82E, BX82E-VERS.122013, BX82G, BX82G-VERS.122013, FX101E1, FX101E1R, FX101E2, FX101E2C, FX101E2C-VERS.032014, FX101E2R, FX101E2R-VERS.032014, FX101E2-VERS.032014, FX101E3, FX101E3C, FX101E3C-VERS.022014, FX101E3R, FX101E3R-VERS.022014, FX101E3-VERS.022014, FX101G1, FX101G1R, FX101G2, FX101G2C, FX101G2C-VERS.032014, FX101G2R, FX101G2R-VERS.032014, FX101G2-VERS.032014, FX101G3, FX101G3C, FX101G3C-VERS.022014, FX101G3R, FX101G3R-VERS.022014, FX101G3-VERS.022014, FX10E2CR, FX10E2CR-VERS.032014, FX10E3CR, FX10E3CR-VERS.022014, FX10G2CR, FX10G2CR-VERS.032014... (Weitere Modelle finden Sie in unserem Webshop)		

### Sonstige



1

<b>GEV-Nr.</b>	698474	<b>Vergl.-Nr.</b>	36E2820
<b>Beschreibung</b>	Scharnierblock Gesamtlänge 50mm Gesamthöhe 14mm passend für ANGELO PO		
<b>Für Modelle:</b>	FC1011E, FC1011G, FC1221E, FC1221G, FC611E, FC611G, FM1011E1, FM1011E1-VERS.2006, FM1011E2, FM1011E2-VERS.2006, FM1011E3, FM1011E3-VERS.2006, FM1011G1, FM1011G1-VERS.2006, FM1011G2, FM1011G2-VERS.2006, FM1011G3, FM1011G3-VERS.2006, FM1221E1, FM1221E1-VERS.2006, FM1221E2, FM1221E2-VERS.2006, FM1221E3, FM1221E3-VERS.2006, FM1221G1, FM1221G1-VERS.2006, FM1221G2, FM1221G2-VERS.2006, FM1221G3, FM1221G3-VERS.2006, FM2011E2-VERS.2006, FM2011E3-VERS.2006, FM2011G2-VERS.2006, FM2011G3-VERS.2006, FM2021E1, FM2021E2, FM2021E2-VERS.2006, FM2021E3, FM2021E3-VERS.2006, FM2021G1, FM2021G2, FM2021G2-VERS.2006, FM2021G3, FM2021G3-VERS.2006, FM611E1, FM611E1-VERS.2006, FM611E2, FM611E2-VERS.2006, FM611E3, FM611E3-VERS.2006... (Weitere Modelle finden Sie in unserem Webshop)		

### Zubehör

#### Sonstige



1

<b>GEV-Nr.</b>	692864	<b>Vergl.-Nr.</b>	3108740 3108741
<b>Beschreibung</b>	Drehlager rastend mit Bolzen EP unten rechts		



1

<b>GEV-Nr.</b>	692863	<b>Vergl.-Nr.</b>	36E2660
<b>Beschreibung</b>	Drehlager rastend ohne Bolzen EP unten rechts		
<b>Für Modelle:</b>	FC1011E, FC1011G, FC1221E, FC1221G, FC611E, FC611G, FM1011E1, FM1011E1-VERS.2006, FM1011E2, FM1011E2-VERS.2006, FM1011E3, FM1011E3-VERS.2006, FM1011G1, FM1011G1-VERS.2006, FM1011G2, FM1011G2-VERS.2006, FM1011G3, FM1011G3-VERS.2006, FM1221E1, FM1221E1-VERS.2006, FM1221E2, FM1221E2-VERS.2006, FM1221E3, FM1221E3-VERS.2006, FM1221G1, FM1221G1-VERS.2006, FM1221G2, FM1221G2-VERS.2006, FM1221G3, FM1221G3-VERS.2006, FM2011E2-VERS.2006, FM2011E3-VERS.2006, FM2011G2-VERS.2006, FM2011G3-VERS.2006, FM2021E1, FM2021E2, FM2021E2-VERS.2006, FM2021E3, FM2021E3-VERS.2006, FM2021G1, FM2021G2, FM2021G2-VERS.2006, FM2021G3, FM2021G3-VERS.2006, FM611E1, FM611E1-VERS.2006, FM611E2, FM611E2-VERS.2006, FM611E3, FM611E3-VERS.2006... (Weitere Modelle finden Sie in unserem Webshop)		

## Gerätefüße und Endkappen

### Gerätefüße

#### mit Schraubbefestigung



1

<b>GEV-Nr.</b>	701638	<b>Vergl.-Nr.</b>	3313390
<b>Beschreibung</b>	Gerätefuß Rohr ø 63.5mm Gewinde M10 IG H 145-230mm CNS VPE 1 Stück		



## Roste und Stellschienen

### Gitterroste

#### Universal

#### ohne Aufkantung



1

<b>GEV-Nr.</b>	970122	<b>Vergl.-Nr.</b>	G610X
<b>Beschreibung</b>	Gitterrost B 325mm T 530mm GN 1/1 H 8mm Edelstahl Drahtstärke Rahmen 7mm Drahtstärke Längsdrähte 4mm Querstreben 1		
<b>Zubehör für</b>	970122		
	GEV-Nr. 690330	Vergl.-Nr.	—
	Stellschienenträger L 1000mm B 22mm H 4mm Lochgröße 3x8mm LA 12.5mm Edelstahl		
	GEV-Nr. 694700	Vergl.-Nr.	—
	Fachbodenträger L 31/28mm B 22mm H 18mm CNS VPE 12 Stück		
	GEV-Nr. 694701	Vergl.-Nr.	—
	Fachbodenträger L 31/28mm B 22mm H 17mm CNS mit Haken VPE 12 Stück		



1

<b>GEV-Nr.</b>	970120	<b>Vergl.-Nr.</b>	36M3540 G610
<b>Beschreibung</b>	Gitterrost B 325mm T 530mm GN 1/1 Stahl verchromt Drahtstärke Rahmen 7mm Drahtstärke Längsdrähte 4mm Querstreben 1		
<b>Für Modelle:</b>	31GE, 31TC, 31TCE, 32TC, 32TCE		
<b>Zubehör für</b>	970120		
	GEV-Nr. 690330	Vergl.-Nr.	—
	Stellschienenträger L 1000mm B 22mm H 4mm Lochgröße 3x8mm LA 12.5mm Edelstahl		
	GEV-Nr. 694700	Vergl.-Nr.	—
	Fachbodenträger L 31/28mm B 22mm H 18mm CNS VPE 12 Stück		
	GEV-Nr. 694701	Vergl.-Nr.	—
	Fachbodenträger L 31/28mm B 22mm H 17mm CNS mit Haken VPE 12 Stück		

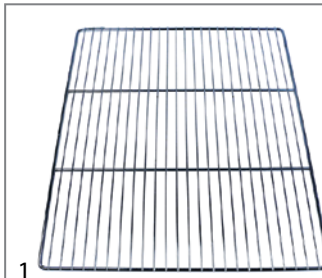

1

<b>GEV-Nr.</b>	970123	<b>Vergl.-Nr.</b>	G241X
<b>Beschreibung</b>	Gitterrost B 650mm T 530mm GN 2/1 Edelstahl Drahtstärke Rahmen 7.8mm Drahtstärke Längsdrähte 3.8mm Querstreben 2		
<b>Zubehör für</b>	970123		
	GEV-Nr. 690330	Vergl.-Nr.	—
	Stellschienenträger L 1000mm B 22mm H 4mm Lochgröße 3x8mm LA 12.5mm Edelstahl		
	GEV-Nr. 694700	Vergl.-Nr.	—
	Fachbodenträger L 31/28mm B 22mm H 18mm CNS VPE 12 Stück		
	GEV-Nr. 694701	Vergl.-Nr.	—
	Fachbodenträger L 31/28mm B 22mm H 17mm CNS mit Haken VPE 12 Stück		

#### mit Aufkantung



1

<b>GEV-Nr.</b>	970527	<b>Vergl.-Nr.</b>	36A0990 G241
<b>Beschreibung</b>	Gitterrost B 530mm T 650mm GN 2/1 Stahl verchromt mit Anschlag Querstreben 2 passend für Kühlschrank		
<b>Zubehör für</b>	970527		
	GEV-Nr. 690330	Vergl.-Nr.	—
	Stellschienenträger L 1000mm B 22mm H 4mm Lochgröße 3x8mm LA 12.5mm Edelstahl		
	GEV-Nr. 694700	Vergl.-Nr.	—
	Fachbodenträger L 31/28mm B 22mm H 18mm CNS VPE 12 Stück		
	GEV-Nr. 694701	Vergl.-Nr.	—
	Fachbodenträger L 31/28mm B 22mm H 17mm CNS mit Haken VPE 12 Stück		

## Dichtungen

### Thermikdichtungen

#### Fensterdichtungen

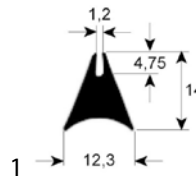

1

<b>GEV-Nr.</b>	900058	<b>Vergl.-Nr.</b>	36E2840 37Q2470
<b>Beschreibung</b>	Fensterdichtung Profil 1620 VPE Meterware		



<b>GEV-Nr.</b>	900442	<b>Vergl.-Nr.</b>	37Q7400 37Q7401
<b>Beschreibung</b>	Fensterdichtung Profil 1630 L 1075mm VPE 1		
<b>Für Modelle:</b>	FCV3EM, FCV4E, FCV4EDS, FCV4EM, FM423E1, FM423E2		

<b>GEV-Nr.</b>	900447	<b>Vergl.-Nr.</b>	37Q2981 37Q2982
<b>Beschreibung</b>	Fensterdichtung Profil 1630 L 1350mm VPE 1		
<b>Für Modelle:</b>	71AR, 71ARE, 71RA, 91AR, 91ARE, 91RA, FC61, FC61E, FCV61, FCV61-CSA, FCV61DM, FCV61DM-CSA, FCV61DS, FCV61DS-CSA, FCV61E, FCV61EDM, FCV61EDM-UL, FCV61EDS, FCV61EDS-UL, FCV61E-UL		

<b>GEV-Nr.</b>	900448	<b>Vergl.-Nr.</b>	37Q2991 37Q2992
<b>Beschreibung</b>	Fensterdichtung Profil 1630 L 1800mm VPE 1		
<b>Für Modelle:</b>	FC101, FC101E, FCV101, FCV101-CSA, FCV101DM, FCV101DM-CSA, FCV101DS, FCV101DS-CSA, FCV101E, FCV101EDM, FCV101EDM-UL, FCV101EDS, FCV101EDS-UL, FCV101E-UL		

<b>GEV-Nr.</b>	900449	<b>Vergl.-Nr.</b>	37Q7530 37Q7531
<b>Beschreibung</b>	Fensterdichtung Profil 1630 L 2050mm VPE 1		
<b>Für Modelle:</b>	FCV141, FCV141-CSA, FCV141DM, FCV141DM-CSA, FCV141DS, FCV141DS-CSA, FCV141E, FCV141EDM, FCV141EDS, FCV72EDM-UL, FCV72EDS-UL, FCV72E-UL		

<b>GEV-Nr.</b>	900450	<b>Vergl.-Nr.</b>	37Q3000 37Q3001
<b>Beschreibung</b>	Fensterdichtung Profil 1630 L 2700mm VPE 1		
<b>Für Modelle:</b>	FC241, FC241E, FC241G, FCV241, FCV241DM, FCV241DS, FCV241E, FCV241EDM, FCV241EDM-UL, FCV241EDS, FCV241EDS-UL, FCV241E-UL, FCV241G, FCV241G-CSA, FCV241GDM, FCV241GDM-CSA, FCV241GDS, FCV241GDS-CSA		

Türdichtungen

<b>GEV-Nr.</b>	900725	<b>Vergl.-Nr.</b>	37Q7621
<b>Beschreibung</b>	Türdichtung		
<b>Für Modelle:</b>	FCV401DM, FCV401DM-CSA, FCV401EDM, FCV401EDM-UL		

<b>GEV-Nr.</b>	900348	<b>Vergl.-Nr.</b>	37Q2480-15MT 37Q2480-6MT
<b>Beschreibung</b>	Türdichtung Profil 2402 VPE Meterware		

<b>GEV-Nr.</b>	900059	<b>Vergl.-Nr.</b>	37Q2480
<b>Beschreibung</b>	Türdichtung Profil 2410 VPE Meterware		

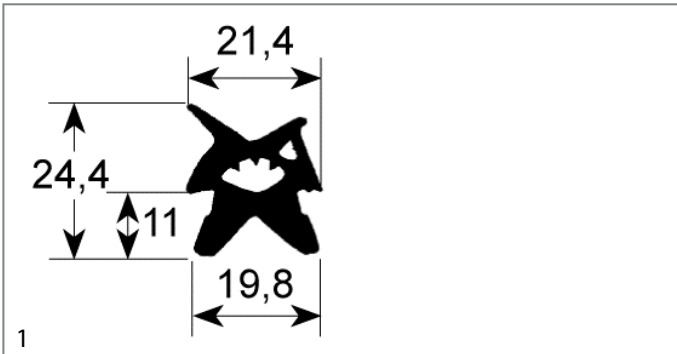

<b>GEV-Nr.</b>	900441	<b>Vergl.-Nr.</b>	37Q1001 37Q1002
<b>Beschreibung</b>	Türdichtung Profil 2420 B 330mm L 410mm Außenmaß VPE 1		
<b>Für Modelle:</b>	FCV3EM, FCV4E, FCV4EDS, FCV4EM		

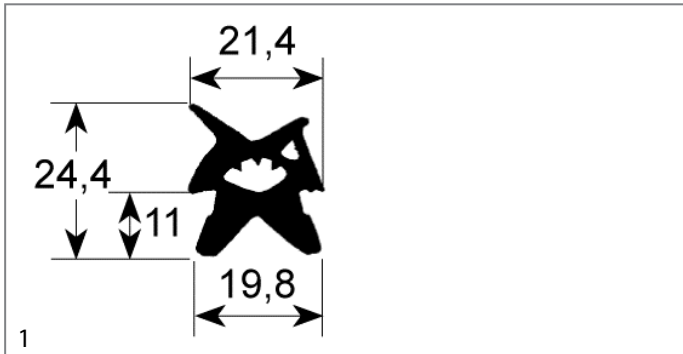

<b>GEV-Nr.</b>	900445	<b>Vergl.-Nr.</b>	37Q0981 37Q0982
<b>Beschreibung</b>	Türdichtung Profil 2420 B 565mm L 680mm Außenmaß VPE 1		
<b>Für Modelle:</b>	FCV141, FCV141-CSA, FCV141DM, FCV141DM-CSA, FCV141DS, FCV141DS-CSA, FCV141E, FCV141EDM, FCV141EDS, FCV72EDM-UL, FCV72EDS-UL, FCV72E-UL		

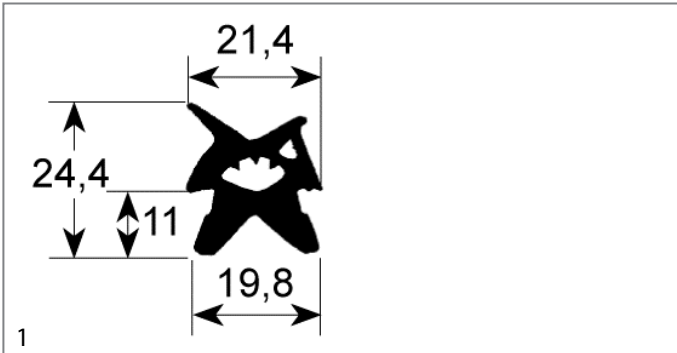

<b>GEV-Nr.</b>	900443	<b>Vergl.-Nr.</b>	37Q0951 37Q0952
<b>Beschreibung</b>	Türdichtung Profil 2420 B 450mm L 460mm Außen Steckmaß VPE 1 passend für CONVOTHERM		
<b>Für Modelle:</b>	FC61, FC61E, FCV61, FCV61-CSA, FCV61DM, FCV61DM-CSA, FCV61DS, FCV61DS-CSA, FCV61E, FCV61EDM, FCV61EDM-UL, FCV61EDS, FCV61EDS-UL, FCV61E-UL		

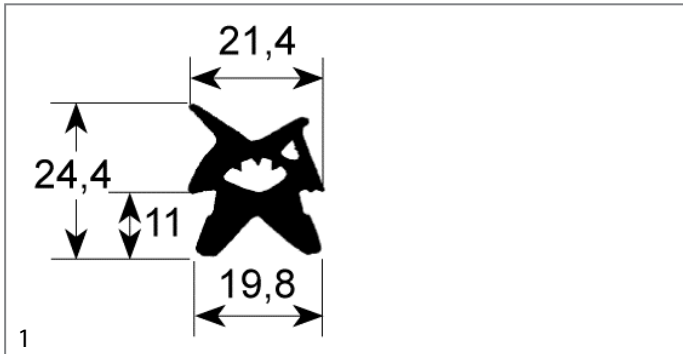

<b>GEV-Nr.</b>	900446	<b>Vergl.-Nr.</b>	37Q0990 37Q0991 37Q0992
<b>Beschreibung</b>	Türdichtung Profil 2420 B 670mm L 860mm Außenmaß VPE 1		
<b>Für Modelle:</b>	FC241, FC241E, FC241G, FCV241, FCV241DM, FCV241DS, FCV241E, FCV241EDM, FCV241EDM-UL, FCV241EDS, FCV241EDS-UL, FCV241E-UL, FCV241G, FCV241G-CSA, FCV241GDM, FCV241GDM-CSA, FCV241GDS, FCV241GDS-CSA		

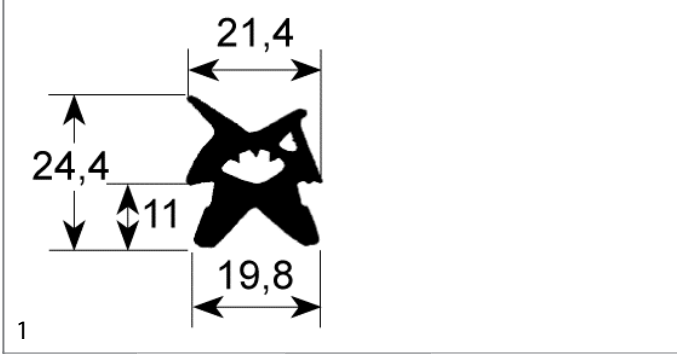

<b>GEV-Nr.</b>	900444	<b>Vergl.-Nr.</b>	37Q0970 37Q0971 37Q0972
<b>Beschreibung</b>	Türdichtung Profil 2420 B 450mm L 700mm Außen Steckmaß VPE 1 passend für CONVOTHERM		
<b>Für Modelle:</b>	FC101, FC101E, FCV101, FCV101-CSA, FCV101DM, FCV101DM-CSA, FCV101DS, FCV101DS-CSA, FCV101E, FCV101EDM, FCV101EDM-UL, FCV101EDS, FCV101EDS-UL, FCV101E-UL		

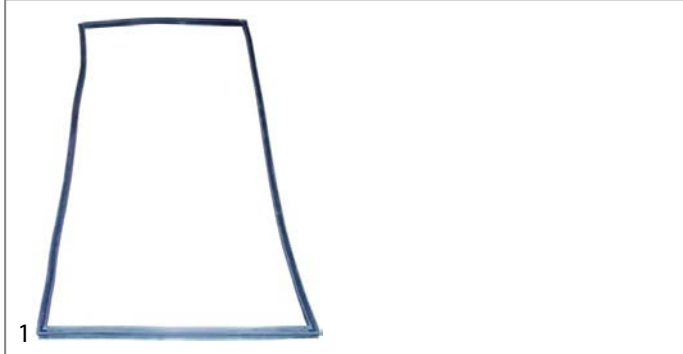

<b>GEV-Nr.</b>	900721	<b>Vergl.-Nr.</b>	37Q7633
<b>Beschreibung</b>	Türdichtung Profil 2420 B 680mm L 1380mm Außenmaß VPE 1		
<b>Für Modelle:</b>	FCV401DM, FCV401DM-CSA, FCV401EDM, FCV401EDM-UL		



<b>GEV-Nr.</b>	901394	<b>Vergl.-Nr.</b>	37Q4980
<b>Beschreibung</b>	Türdichtung Profil 2438 B 330mm L 410mm Außenmaß		
<b>Für Modelle:</b>	FCV3EM, FCV4E, FCV4EDS, FCV4EM, FM423E1, FM423E2		

<b>GEV-Nr.</b>	900749	<b>Vergl.-Nr.</b>	36E4061
<b>Beschreibung</b>	Türdichtung Profil 2780 B 630mm L 690mm Außenmaß VPE 1		
<b>Für Modelle:</b>	FM721E1, FM721E1-VERS.2006, FM721E2, FM721E2-VERS.2006, FM721E3, FM721E3-VERS.2006, FM721G1, FM721G1-VERS.2006, FM721G2, FM721G2-VERS.2006, FM721G3, FM721G3-VERS.2006		

<b>GEV-Nr.</b>	900748	<b>Vergl.-Nr.</b>	3050160
<b>Beschreibung</b>	Türdichtung Profil 2780 B 475mm L 1360mm Außenmaß VPE 1		
<b>Für Modelle:</b>	FM2011E2-VERS.2006, FM2011E3-VERS.2006, FM2011G2-VERS.2006, FM2011G3-VERS.2006		

<b>GEV-Nr.</b>	900746	<b>Vergl.-Nr.</b>	36E3921
<b>Beschreibung</b>	Türdichtung Profil 2780 B 690mm L 1360mm Außenmaß VPE 1		
<b>Für Modelle:</b>	FM2021E1, FM2021E2, FM2021E2-VERS.2006, FM2021E3, FM2021E3-VERS.2006, FM2021G1, FM2021G2, FM2021G2-VERS.2006, FM2021G3, FM2021G3-VERS.2006		

<b>GEV-Nr.</b>	900716	<b>Vergl.-Nr.</b>	36E3030 36E3031
<b>Beschreibung</b>	Türdichtung Profil 2780 B 485mm L 485mm Außenmaß VPE 1		
<b>Für Modelle:</b>	FC611E, FC611G, FM611E1, FM611E1-VERS.2006, FM611E2, FM611E2-VERS.2006, FM611E3, FM611E3-VERS.2006, FM611G1, FM611G1-VERS.2006, FM611G2, FM611G2-VERS.2006, FM611G3, FM611G3-VERS.2006		

<b>GEV-Nr.</b>	900747	<b>Vergl.-Nr.</b>	36E3520 36E3521
<b>Beschreibung</b>	Türdichtung Profil 2780 B 690mm L 860mm Außenmaß VPE 1		
<b>Für Modelle:</b>	FC1221E, FC1221G, FM1221E1, FM1221E1-VERS.2006, FM1221E2, FM1221E2-VERS.2006, FM1221E3, FM1221E3-VERS.2006, FM1221G1, FM1221G1-VERS.2006, FM1221G2, FM1221G2-VERS.2006, FM1221G3, FM1221G3-VERS.2006		

<b>GEV-Nr.</b>	900715	<b>Vergl.-Nr.</b>	36E3020 36E3021
<b>Beschreibung</b>	Türdichtung Profil 2780 B 490mm L 700mm Außenmaß VPE 1		
<b>Für Modelle:</b>	FC1011E, FC1011G, FM1011E1, FM1011E1-VERS.2006, FM1011E2, FM1011E2-VERS.2006, FM1011E3, FM1011E3-VERS.2006, FM1011G1, FM1011G1-VERS.2006, FM1011G2, FM1011G2-VERS.2006, FM1011G3, FM1011G3-VERS.2006		



<b>GEV-Nr.</b>	901624	<b>Vergl.-Nr.</b>	3077280 3077281 3077282
<b>Beschreibung</b>	Türdichtung Profil 2781 B 475mm L 1410mm Außenmaß passend für ANGELO PO		
<b>Für Modelle:</b>	FX201E2, FX201E2P, FX201E2P-VERS.032014, FX201E2-VERS.032014, FX201E3, FX201E3P, FX201E3P-VERS.022014, FX201E3-VERS.022014, FX201G2, FX201G2P, FX201G2P-VERS.032014, FX201G2-VERS.032014, FX201G3P, FX201G3-VERS.022014		

<b>GEV-Nr.</b>	901623	<b>Vergl.-Nr.</b>	3077270 3077271 3077272
<b>Beschreibung</b>	Türdichtung Profil 2781 B 475mm L 725mm Außenmaß passend für ANGELO PO		
<b>Für Modelle:</b>	BX101E, BX101E-VERS.122013, BX101G, BX101G-VERS.122013, FX101E1, FX101E1R, FX101E2, FX101E2C, FX101E2C-VERS.032014, FX101E2R, FX101E2R-VERS.032014, FX101E2-VERS.032014, FX101E3, FX101E3C, FX101E3C-VERS.022014, FX101E3R, FX101E3R-VERS.022014, FX101E3-VERS.022014, FX101G1, FX101G1R, FX101G2, FX101G2C, FX101G2C-VERS.032014, FX101G2R, FX101G2R-VERS.032014, FX101G2-VERS.032014, FX101G3, FX101G3C, FX101G3C-VERS.022014, FX101G3R, FX101G3R-VERS.022014, FX101G3-VERS.022014, FX10E2CR, FX10E2CR-VERS.032014, FX10E3CR, FX10E3CR-VERS.022014, FX10G2CR, FX10G2CR-VERS.032014, FX10G3CR, FX10G3CR-VERS.022014		

<b>GEV-Nr.</b>	901622	<b>Vergl.-Nr.</b>	3077260 3077261 3077262
<b>Beschreibung</b>	Türdichtung Profil 2781 B 475mm L 475mm Außenmaß passend für ANGELO PO		
<b>Für Modelle:</b>	BX61E, BX61E-VERS.122013, BX61G, BX61G-VERS.122013, FX61E1, FX61E1R, FX61E2, FX61E2C, FX61E2CR, FX61E2CR-VERS.032014, FX61E2C-VERS.032014, FX61E2R, FX61E2R-VERS.032014, FX61E2-VERS.032014, FX61E3, FX61E3C, FX61E3CR, FX61E3CR-VERS.022014, FX61E3C-VERS.022014, FX61E3R, FX61E3R-VERS.022014, FX61E3-VERS.022014, FX61G1, FX61G1R, FX61G2, FX61G2C, FX61G2CR, FX61G2CR-VERS.032014, FX61G2C-VERS.032014, FX61G2R, FX61G2R-VERS.032014, FX61G2-VERS.032014, FX61G3, FX61G3C, FX61G3CR, FX61G3CR-VERS.022014, FX61G3C-VERS.022014, FX61G3R, FX61G3R-VERS.022014, FX61G3-VERS.022014		

<b>GEV-Nr.</b>	901625	<b>Vergl.-Nr.</b>	3077290 3077291 3077292
<b>Beschreibung</b>	Türdichtung Profil 2781 B 628mm L 686mm Außenmaß passend für ANGELO PO		
<b>Für Modelle:</b>	BX82E, BX82E-VERS.122013, BX82G, BX82G-VERS.122013, FX82E1, FX82E2, FX82E2C, FX82E2T, FX82E2T-VERS.032014, FX82E3, FX82E3C, FX82E3CT, FX82E3CT-VERS.022014, FX82E3T, FX82E3T-VERS.022014, FX82G1, FX82G2, FX82G2C, FX82G2T, FX82G2T-VERS.032014, FX82G3, FX82G3C, FX82G3CT, FX82G3CT-VERS.022014, FX82G3T, FX82G3T-VERS.022014		





<b>GEV-Nr.</b>	901627	<b>Vergl.-Nr.</b>	3077310 3077311 3077312
<b>Beschreibung</b>	Türdichtung Profil 2781 B 688mm L 1410mm Außenmaß passend für ANGELO PO		
<b>Für Modelle:</b>	FX202E2, FX202E2-VERS.032014, FX202E3, FX202E3-230V-3-50Hz-60Hz, FX202E3-230V-3-50Hz-60Hz-VERS.022014, FX202E3-VERS.022014, FX202G2, FX202G2-VERS.032014, FX202G3, FX202G3-VERS.022014		

<b>GEV-Nr.</b>	901626	<b>Vergl.-Nr.</b>	3077300 3077301 3077302
<b>Beschreibung</b>	Türdichtung Profil 2781 B 688mm L 886mm Außenmaß passend für ANGELO PO		
<b>Für Modelle:</b>	BX122E, BX122E-VERS.122013, BX122G, BX122G-VERS.122013, FX122E1, FX122E2, FX122E2C, FX122E2T, FX122E2T-VERS.032014, FX122E3, FX122E3C, FX122E3T, FX122E3T-VERS.022014, FX122G1, FX122G3, FX122G3C, FX122G3T, FX122G3T-VERS.022014, FX12E3CT, FX12E3CT-VERS.022014, FX12G3CT, FX12G3CT-VERS.022014		

### Hordenwagendichtungen

<b>GEV-Nr.</b>	902513	<b>Vergl.-Nr.</b>	3040480
<b>Beschreibung</b>	Hordenwagendichtung Profil 4110 L 510mm VPE 1		
<b>Für Modelle:</b>	FM2011E2-VERS.2006, FM2011E3-VERS.2006, FM2011G2-VERS.2006, FM2011G3-VERS.2006		

<b>GEV-Nr.</b>	901396	<b>Vergl.-Nr.</b>	3039710
<b>Beschreibung</b>	Hordenwagendichtung Profil 4110 L 712mm VPE 1		
<b>Für Modelle:</b>	FM2021E2-VERS.2006, FM2021E3-VERS.2006, FM2021G2-VERS.2006, FM2021G3-VERS.2006		

<b>GEV-Nr.</b>	902520	<b>Vergl.-Nr.</b>	3091160 3199570
<b>Beschreibung</b>	Hordenwagendichtung Profil 4140 L 515mm VPE 1		
<b>Für Modelle:</b>	FX201E2, FX201E2P, FX201E2P-VERS.032014, FX201E2-VERS.032014, FX201E3, FX201E3P, FX201E3P-VERS.022014, FX201E3-VERS.022014, FX201G2, FX201G2P, FX201G2P-VERS.032014, FX201G2-VERS.032014, FX201G3P, FX201G3-VERS.022014		

## O-Ringe

EPDM

ø1,78mm



<b>GEV-Nr.</b>	510303	<b>Vergl.-Nr.</b>	3152180
<b>Beschreibung</b>	O-Ring EPDM Materialstärke 1.78mm ID ø 6.75mm VPE 1 Stück		
<b>Für Modelle:</b>	LC100, LC100-VERS.2001, LC130, LC130-VERS.2001, LC80, LF50, LF50E, LF50EM, LF50EMPS, LP124, LP124S-VERS.052006, LP124V, LP124-VERS.052006, LP124VS-VERS.052006, LP124V-VERS.052006, LP84, LP84S-VERS.052006, LP84V, LP84-VERS.052006, LP84VS-VERS.052006, LP84V-VERS.052006		

ø2,62mm



<b>GEV-Nr.</b>	528223	<b>Vergl.-Nr.</b>	3152100
<b>Beschreibung</b>	O-Ring EPDM Materialstärke 2.62mm ID ø 11.91mm VPE 1 Stück		
<b>Für Modelle:</b>	LT10R, LT20F, LT25F		



ø3,53mm

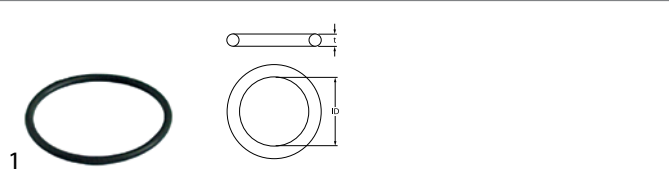

<b>GEV-Nr.</b>	511331	<b>Vergl.-Nr.</b>	3152390
<b>Beschreibung</b>	O-Ring EPDM Materialstärke 3.53mm ID ø 53.57mm VPE 1 Stück		
<b>Für Modelle:</b>	LC100-VERS.2001, LC130, LC130-VERS.2001, LC80		

ø5,34mm

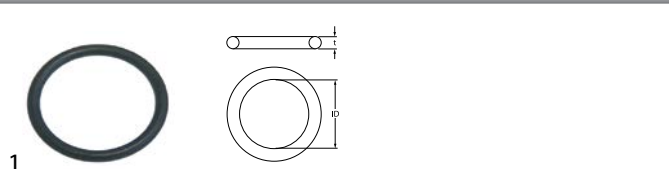

<b>GEV-Nr.</b>	510408	<b>Vergl.-Nr.</b>	3152650
<b>Beschreibung</b>	O-Ring EPDM Materialstärke 5.34mm ID ø 47mm VPE 1 Stück		

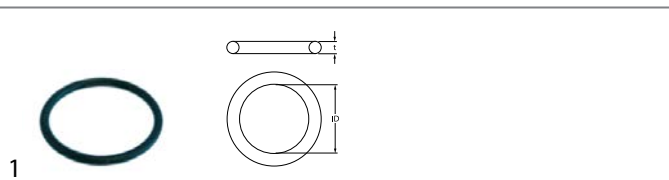

<b>GEV-Nr.</b>	510409	<b>Vergl.-Nr.</b>	3150430 3151960 37Q5260
<b>Beschreibung</b>	O-Ring EPDM Materialstärke 5.34mm ID ø 56.52mm VPE 1 Stück		

**Für Modelle:**

091CP1E, 0A1CP1E, 0G1CP1E, 0G1CP1EC, 0G1CP1E-VERS.2004, 191PI2E, 191PI2EA, 1A1PI2E, 1A1PI2EA, 1D1PI2E, 1D1PI2EA, 1G1PI1E, 30CPSE, 31PIE6, 6040090, 6040310, 6043850, 6043980, 70CPE, 71PIE15, 71PIE15A, 90CPE, 91PIE15, 91PIE15A, F60P, F60PR, F60T, F80P, F80PR, KD100, KD100A, KD100PSD, KD130, KD130A, KD130E, KD130EAT, KD60, KD60E, KD60EAT, KD60M, KD60MA, KD60ME, KD60MPS, KD60MPSA, KD60PS, KD60PSD, KD6EATSD, KD85, KD85A, KD85E...(Weitere Modelle finden Sie in unserem Webshop)

## Dichtungsringe

### Fiberdichtungen



<b>GEV-Nr.</b>	510123	<b>Vergl.-Nr.</b>	37Q4070
<b>Beschreibung</b>	Flachdichtung FIBER AD ø 60mm ID ø 46mm Materialstärke 2mm VPE 1 Stück		
<b>Für Modelle:</b>	191PD1G, 191PD2G, 191PI1G, 191PI1GA, 191PI2E, 191PI2EA, 191PI2G, 191PI2GA, 191PI2V, 191PI2VA, 1A1PI2G, 1A1PI2GA, 1D1PI2G, 1D1PI2GA, MCF20, MCF40, PV200, PV200A, PV300, PV300A		

## Gummidichtungen



<b>GEV-Nr.</b>	511435	<b>Vergl.-Nr.</b>	37Q3420
<b>Beschreibung</b>	Flachdichtung Gummi AD ø 47mm ID ø 39mm Materialstärke 2mm VPE 1 Stück		



<b>GEV-Nr.</b>	505405	<b>Vergl.-Nr.</b>	3045960
<b>Beschreibung</b>	Flachdichtung NBR AD ø 58mm ID ø 40mm Materialstärke 3mm Abfluss		

**Für Modelle:**

BX101E, BX101E-VERS.122013, BX101G, BX101G-VERS.122013, BX122E, BX122E-VERS.122013, BX122G, BX122G-VERS.122013, BX61E, BX61E-VERS.122013, BX61G, BX61G-VERS.122013, BX82E, BX82E-VERS.122013, BX82G, BX82G-VERS.122013, FC1011E, FC1011G, FC1221E, FC1221G, FC611E, FC611G, FM1011E1, FM1011E1-VERS.2006, FM1011E2, FM1011E2-VERS.2006, FM1011E3, FM1011E3-VERS.2006, FM1011G1, FM1011G1-VERS.2006, FM1011G2, FM1011G2-VERS.2006, FM1011G3, FM1011G3-VERS.2006, FM1221E1, FM1221E1-VERS.2006, FM1221E2, FM1221E2-VERS.2006, FM1221E3, FM1221E3-VERS.2006, FM1221G1, FM1221G1-VERS.2006, FM1221G2, FM1221G2-VERS.2006, FM1221G3, FM1221G3-VERS.2006, FM2011E2-VERS.2006, FM2011E3-VERS.2006, FM2011G2-VERS.2006, FM2011G3-VERS.2006...(Weitere Modelle finden Sie in unserem Webshop)

## Silikondichtungen



<b>GEV-Nr.</b>	694916	<b>Vergl.-Nr.</b>	36E3320
<b>Beschreibung</b>	Dichtung Silikon AD ø 45mm ID ø 34mm Materialstärke 5mm		

**Für Modelle:**

BX101E, BX101E-VERS.122013, BX101G, BX101G-VERS.122013, BX122E, BX122E-VERS.122013, BX122G, BX122G-VERS.122013, BX61E, BX61E-VERS.122013, BX61G, BX61G-VERS.122013, BX82E, BX82E-VERS.122013, BX82G, BX82G-VERS.122013, FC1011E, FC1011G, FC1221E, FC1221G, FC611E, FC611G, FM1011E1, FM1011E1-VERS.2006, FM1011E2, FM1011E2-VERS.2006, FM1011E3, FM1011E3-VERS.2006, FM1011G1, FM1011G1-VERS.2006, FM1011G2, FM1011G2-VERS.2006, FM1011G3, FM1011G3-VERS.2006, FM1221E1, FM1221E1-VERS.2006, FM1221E2, FM1221E2-VERS.2006, FM1221E3, FM1221E3-VERS.2006, FM1221G1, FM1221G1-VERS.2006, FM1221G2, FM1221G2-VERS.2006, FM1221G3, FM1221G3-VERS.2006, FM2011E2-VERS.2006, FM2011E3-VERS.2006, FM2011G2-VERS.2006, FM2011G3-VERS.2006...(Weitere Modelle finden Sie in unserem Webshop)



Wellendichtungen

Wellendichtungen



<b>GEV-Nr.</b>	520473	<b>Vergl.-Nr.</b>	3004400
<b>Beschreibung</b>	Dichtung D1 ø 35mm D2 ø 18mm Materialstärke 7mm		
<b>Für Modelle:</b>	FC1011E, FC1011G, FC1221E, FC1221G, FC611E, FC611G, FM1011E1, FM1011E1-VERS.2006, FM1011E2, FM1011E2-VERS.2006, FM1011E3, FM1011E3-VERS.2006, FM1011G1, FM1011G1-VERS.2006, FM1011G2, FM1011G2-VERS.2006, FM1011G3, FM1011G3-VERS.2006, FM1221E1, FM1221E1-VERS.2006, FM1221E2, FM1221E2-VERS.2006, FM1221E3, FM1221E3-VERS.2006, FM1221G1, FM1221G1-VERS.2006, FM1221G2, FM1221G2-VERS.2006, FM1221G3, FM1221G3-VERS.2006, FM2011E2-VERS.2006, FM2011E3-VERS.2006, FM2011G2-VERS.2006, FM2011G3-VERS.2006, FM2021E1, FM2021E2, FM2021E2-VERS.2006, FM2021E3, FM2021E3-VERS.2006, FM2021G1, FM2021G2, FM2021G2-VERS.2006, FM2021G3, FM2021G3-VERS.2006, FM611E1, FM611E1-VERS.2006, FM611E2, FM611E2-VERS.2006, FM611E3, FM611E3-VERS.2006... (Weitere Modelle finden Sie in unserem Webshop)		



<b>GEV-Nr.</b>	550685	<b>Vergl.-Nr.</b>	3151670
<b>Beschreibung</b>	Simmerring ID ø 12mm AD ø 32mm Materialstärke 7mm		
<b>Für Modelle:</b>	FCV3EM, FCV4E, FCV4EDS, FCV4EM		



<b>GEV-Nr.</b>	516246	<b>Vergl.-Nr.</b>	2103111
<b>Beschreibung</b>	Simmerring ID ø 17mm AD ø 35mm Materialstärke 7mm		

Spezialdichtungen

für Kombidämpfer



<b>GEV-Nr.</b>	699497	<b>Vergl.-Nr.</b>	3332580
<b>Beschreibung</b>	Dichtung für Gebläse-Brenner AD ø 92.5mm ID ø 51mm Graphit Materialstärke 2mm		



<b>GEV-Nr.</b>	696776	<b>Vergl.-Nr.</b>	36E3780
<b>Beschreibung</b>	Dichtung für Wärmetauscher L 50mm B 50mm Flansch ID ø 34mm Materialstärke 1mm LA 40mm		
<b>Für Modelle:</b>	FM1011G1, FM1011G2, FM1011G3, FM1221G1, FM1221G2, FM1221G3, FM2021G1, FM2021G2, FM2021G3, FM611G1, FM611G2, FM611G3, FM721G1, FM721G2, FM721G3		



<b>GEV-Nr.</b>	696779	<b>Vergl.-Nr.</b>	36E3400
<b>Beschreibung</b>	Dichtung für Wärmetauscher L 60mm B 60mm Flansch ID ø 34mm Materialstärke 3mm LA 40mm		
<b>Für Modelle:</b>	FC1011G, FC1221G, FC611G, FM1011G1, FM1011G1-VERS.2006, FM1011G2, FM1011G2-VERS.2006, FM1011G3, FM1011G3-VERS.2006, FM1221G1, FM1221G1-VERS.2006, FM1221G2, FM1221G2-VERS.2006, FM1221G3, FM1221G3-VERS.2006, FM2011G2-VERS.2006, FM2011G3-VERS.2006, FM2021G1, FM2021G2, FM2021G2-VERS.2006, FM2021G3, FM2021G3-VERS.2006, FM611G1, FM611G1-VERS.2006, FM611G2, FM611G2-VERS.2006, FM611G3, FM611G3-VERS.2006, FM721G1, FM721G1-VERS.2006, FM721G2, FM721G2-VERS.2006, FM721G3, FM721G3-VERS.2006		



<b>GEV-Nr.</b>	505405	<b>Vergl.-Nr.</b>	3045960
<b>Beschreibung</b>	Flachdichtung NBR AD ø 58mm ID ø 40mm Materialstärke 3mm Abfluss		
<b>Für Modelle:</b>	BX101E, BX101E-VERS.122013, BX101G, BX101G-VERS.122013, BX122E, BX122E-VERS.122013, BX122G, BX122G-VERS.122013, BX61E, BX61E-VERS.122013, BX61G, BX61G-VERS.122013, BX82E, BX82E-VERS.122013, BX82G, BX82G-VERS.122013, FC1011E, FC1011G, FC1221E, FC1221G, FC611E, FC611G, FM1011E1, FM1011E1-VERS.2006, FM1011E2, FM1011E2-VERS.2006, FM1011E3, FM1011E3-VERS.2006, FM1011G1, FM1011G1-VERS.2006, FM1011G2, FM1011G2-VERS.2006, FM1011G3, FM1011G3-VERS.2006, FM1221E1, FM1221E1-VERS.2006, FM1221E2, FM1221E2-VERS.2006, FM1221E3, FM1221E3-VERS.2006, FM1221G1, FM1221G1-VERS.2006, FM1221G2, FM1221G2-VERS.2006, FM1221G3, FM1221G3-VERS.2006, FM2011E2-VERS.2006, FM2011E3-VERS.2006, FM2011G2-VERS.2006, FM2011G3-VERS.2006... (Weitere Modelle finden Sie in unserem Webshop)		

Sonstige



<b>GEV-Nr.</b>	519385	<b>Vergl.-Nr.</b>	3150220
<b>Beschreibung</b>	Dichtung für Kerntemperaturfühler AD ø 8mm ID ø 4mm Materialstärke 5mm		
<b>Für Modelle:</b>	FCV101DM, FCV101DM-CSA, FCV101DS, FCV101DS-CSA, FCV101EDM, FCV101EDM-UL, FCV101EDS, FCV101EDS-UL, FCV141DM, FCV141DM-CSA, FCV141DS, FCV141DS-CSA, FCV141EDM, FCV141EDS, FCV241DM, FCV241DS, FCV241EDM, FCV241EDM-UL, FCV241EDS, FCV241EDS-UL, FCV241GDM, FCV241GDM-CSA, FCV241GDS, FCV241GDS-CSA, FCV401DM, FCV401DM-CSA, FCV401EDM, FCV401EDM-UL, FCV4EDS, FCV61DM, FCV61DM-CSA, FCV61DS, FCV61DS-CSA, FCV61EDM, FCV61EDM-UL, FCV61EDS, FCV61EDS-UL, FCV72EDM-UL, FCV72EDS-UL, FM1011E2, FM1011E3, FM1011G2, FM1011G3, FM1221E2, FM1221E3, FM1221G2, FM1221G3, FM2021E2, FM2021E3, FM2021G2... (Weitere Modelle finden Sie in unserem Webshop)		

Mechanik und Gerätezubehör



1

<b>GEV-Nr.</b>	541499	<b>Vergl.-Nr.</b>	3151450
<b>Beschreibung</b>	Dichtung passend für ANGELO PO Größe 1¼"		
<b>Für Modelle:</b>	FC101, FC1011E, FC1011G, FC101E, FC1221E, FC1221G, FC241, FC241E, FC241G, FC61, FC611E, FC611G, FC61E, FCV101, FCV101-CSA, FCV101DM, FCV101DM-CSA, FCV101DS, FCV101DS-CSA, FCV101E, FCV101EDM, FCV101EDM-UL, FCV101EDS, FCV101EDS-UL, FCV101E-UL, FCV141, FCV141-CSA, FCV141DM, FCV141DM-CSA, FCV141DS, FCV141DS-CSA, FCV141E, FCV141EDM, FCV141EDS, FCV241, FCV241DM, FCV241DS, FCV241E, FCV241EDM, FCV241EDM-UL, FCV241EDS, FCV241EDS-UL, FCV241E-UL, FCV241G, FCV241G-CSA, FCV241GDM, FCV241GDM-CSA, FCV241GDS, FCV241GDS-CSA, FCV401DM...(Weitere Modelle finden Sie in unserem Webshop)		

## Manometer



1

<b>GEV-Nr.</b>	541508	<b>Vergl.-Nr.</b>	33D1680
<b>Beschreibung</b>	Manometer ø 40mm Druckbereich 0-4bar Anschluss Gewinde 1/8"		
<b>Für Modelle:</b>	BX101E, BX101E-VERS.122013, BX101G, BX101G-VERS.122013, BX122E, BX122E-VERS.122013, BX122G, BX122G-VERS.122013, BX61E, BX61E-VERS.122013, BX61G, BX61G-VERS.122013, BX82E, BX82E-VERS.122013, BX82G, BX82G-VERS.122013, FCV101, FCV101-CSA, FCV101DM, FCV101DM-CSA, FCV101DS, FCV101DS-CSA, FCV101E, FCV101EDM, FCV101EDM-UL, FCV101EDS, FCV101EDS-UL, FCV101E-UL, FCV141, FCV141-CSA, FCV141DM, FCV141DM-CSA, FCV141DS, FCV141DS-CSA, FCV141E, FCV141EDM, FCV141EDS, FCV241, FCV241DM, FCV241DS, FCV241E, FCV241EDM, FCV241EDM-UL, FCV241EDS, FCV241EDS-UL, FCV241E-UL, FCV241G, FCV241G-CSA, FCV241GDM, FCV241GDM-CSA...(Weitere Modelle finden Sie in unserem Webshop)		

## Antriebstechnik und Kugellager

### Kugellager

#### Rillenkugellager 2RS



1

<b>GEV-Nr.</b>	523512	<b>Vergl.-Nr.</b>	3103840
<b>Beschreibung</b>	Rillenkugellager Typ 6204-2RS Welle ø 20mm AD ø 47mm B 14mm mit Dichtscheiben Rillenkugellager DIN 625-1		
<b>Für Modelle:</b>	MPCO, MPK10, MPK10I, MPK20, MPK20I, MPK5, PCO, PK10, PK10I, PK20, PK20I, PK5, PK5I		



1

<b>GEV-Nr.</b>	541062	<b>Vergl.-Nr.</b>	32Z0060
<b>Beschreibung</b>	Manometer ø 63mm Druckbereich 0 bis 1 bar Anschluss Markierung einstellbar Kochkessel Gewinde 1/4"		
<b>Für Modelle:</b>	191PI1G, 191PI1GA, 191PI2E, 191PI2EA, 191PI2G, 191PI2GA, 191PI2V, 191PI2VA, 1A1PI1G, 1A1PI1GA, 1A1PI2E, 1A1PI2EA, 1A1PI2V, 1A1PI2VA, 1D1PI1G, 1D1PI1GA, 1D1PI2E, 1D1PI2EA, 1D1PI2V, 1D1PI2VA, 1G1PI1E, 1G1PI1G, 291PI3E, 291PI3G, 2A1PI3E, 31PI6, 31PIE6, 71PI10, 71PI10A, 71PIE15, 71PIE15A, 71PV15, 71PV15A, 91PI10, 91PI10A, 91PIE15, 91PIE15A, BPV2, PV200, PV200A, PV300, PV300A		
<b>Ersatzteile für</b>	541062		
	<b>GEV-Nr.</b>	541130	<b>Vergl.-Nr.</b> —
Glasscheibe ø 58mm Stärke 2mm			

## Federn

### Drehfedern



1

<b>GEV-Nr.</b>	700221	<b>Vergl.-Nr.</b>	36E0220
<b>Beschreibung</b>	Drehfeder ø 17mm Drahtstärke ø 1.5mm L1 48mm		
<b>Für Modelle:</b>	C1424		

### Druckfedern



1

<b>GEV-Nr.</b>	514284	<b>Vergl.-Nr.</b>	36G5320
<b>Beschreibung</b>	Druckfeder ø 9mm L 18mm Drahtstärke ø 0.5mm		
<b>Für Modelle:</b>	04WCP1EM, 08WCP1GM, BX101E, BX101E-VERS.122013, BX101G, BX101G-VERS.122013, BX122E, BX122E-VERS.122013, BX122G, BX122G-VERS.122013, BX61E, BX61E-VERS.122013, BX61G, BX61G-VERS.122013, BX82E, BX82E-VERS.122013, BX82G, BX82G-VERS.122013, FC101, FC1011E, FC1011G, FC101E, FC1221E, FC1221G, FC241, FC241E, FC241G, FC61, FC611E, FC611G, FC61E, FCV101, FCV101-CSA, FCV101DM, FCV101DM-CSA, FCV101DS, FCV101DS-CSA, FCV101E, FCV101EDM, FCV101EDM-UL, FCV101EDS, FCV101EDS-UL, FCV101E-UL, FCV141, FCV141-CSA, FCV141DM, FCV141DM-CSA, FCV141DS, FCV141DS-CSA, FCV141E...(Weitere Modelle finden Sie in unserem Webshop)		

## Schlauchaufroller und Gerätehandbrausen

### Gerätehandbrausen



1

<b>GEV-Nr.</b>	542068	<b>Vergl.-Nr.</b>	33D1700
<b>Beschreibung</b>	Gerätehandbrause 1/2" IG L 219mm mit Halteöse Typ KLARCO		



			
1			
<b>GEV-Nr.</b>	540675	<b>Vergl.-Nr.</b>	3212740 3FL0182
<b>Beschreibung</b>	Brausekopf		
<b>Für Modelle:</b>	LDL		

## Dosiergeräte

### Schlauchpumpendosiergeräte

<b>SEKO</b>			
Ersatzteile			
			
1			
<b>GEV-Nr.</b>	362021	<b>Vergl.-Nr.</b>	3186560
<b>Beschreibung</b>	Pumpenschlauch SEKO Schlauch ø 6x10mm Schlauch Santoprene		
<b>Für Modelle:</b>	FX101E3, FX101E3C, FX101E3C-VERS.022014, FX101E3R, FX101E3R-VERS.022014, FX101E3-VERS.022014, FX101G3, FX101G3C, FX101G3C-VERS.022014, FX101G3R, FX101G3R-VERS.022014, FX101G3-VERS.022014, FX10E3CR, FX10E3CR-VERS.022014, FX10G3CR, FX10G3CR-VERS.022014, FX122E3, FX122E3C, FX122E3T, FX122E3T-VERS.022014, FX122G3, FX122G3C, FX122G3T, FX122G3T-VERS.022014, FX12E3CT, FX12E3CT-VERS.022014, FX12G3CT, FX12G3CT-VERS.022014, FX201E3, FX201E3P, FX201E3P-VERS.022014, FX201E3-VERS.022014, FX201G3P, FX201G3-VERS.022014, FX202E3, FX202E3-230V-3-50Hz-60Hz, FX202E3-230V-3-50Hz-60Hz-VERS.022014, FX202E3-VERS.022014, FX202G3, FX202G3-VERS.022014, FX61E3, FX61E3C, FX61E3CR, FX61E3CR-VERS.022014, FX61E3C-VERS.022014, FX61E3R, FX61E3R-VERS.022014, FX61E3-VERS.022014, FX61G3, FX61G3C...(Weitere Modelle finden Sie in unserem Webshop)		

## Membranpumpen

### selbstsaugend

### LANG

### Zubehör

			
1			
<b>GEV-Nr.</b>	101286	<b>Vergl.-Nr.</b>	36Q0020
<b>Beschreibung</b>	Schneidring ID ø 6mm VPE 1 Stück		
<b>Für Modelle:</b>	04WFAAV, 08WFA4E, 08WFA4G, 08WFAAE, 08WFAAG, 08WFAAV, 090FAA, 0A0FA1, 0A0FA4, 0A0FAA, 0D0FA1, 0D0FA4, 0D0FAA, 0G0FA0, 12WFA6E, 12WFA6G, 12WFAAA, 12WFAAE, 12WFAAG, 12WFAAN, 190FA, 190FAA, 190FAB, 190FAD, 191FAAE, 191FAAG, 191FABG, 191FADG, 191FAE, 191FAG, 1A0FA1, 1A0FA2, 1A0FA4, 1A0FA5, 1A0FAA, 1A0FAB, 1A1FA1G, 1A1FA2G, 1A1FA4G, 1A1FA5G, 1A1FAAG, 1A1FABG, 1D0FA1, 1D0FA2, 1D0FA4, 1D0FA5, 1D0FAA, 1D0FAB, 1D1FA1G, 1D1FA2G...(Weitere Modelle finden Sie in unserem Webshop)		
<b>Zubehör für</b>	101286		
	<b>GEV-Nr.</b>	100909	<b>Vergl.-Nr.</b>
			36Q0060
	Überwurfschraube Gewinde M10x1 für Rohr-ø 6mm VPE 1 Stück		
	<b>GEV-Nr.</b>	101464	<b>Vergl.-Nr.</b>
			—
	Überwurfmutter Gewinde M12x1 für Rohr ø 6mm		

## Zubehör

### Schläuche

#### Silikonschläuche

			
1			
<b>GEV-Nr.</b>	570611 <sup>1</sup>	<b>Vergl.-Nr.</b>	131AA32
<b>Beschreibung</b>	Silikon Schlauch für Schlauchpumpe ID ø 5mm AD ø 8mm Lm Wandstärke 1.5mm T.max. 200°C Shore A 55° Dosiertechnik		

<sup>1</sup>Meterware

### Schlauchverschraubungen

#### Metall

			
1			
<b>GEV-Nr.</b>	361507	<b>Vergl.-Nr.</b>	3016150
<b>Beschreibung</b>	Rohrverschraubung gewinkelt Messing vernickelt Gewinde 1/4" Schlauch ø 6/8mm VPE 1 Stück		
<b>Für Modelle:</b>	FM101E3-VERS.2006, FM101G3-VERS.2006, FM1221E3, FM1221E3-VERS.2006, FM1221G3-VERS.2006, FM2011E3-VERS.2006, FM2011G3-VERS.2006, FM2021E3, FM2021E3-VERS.2006, FM2021G3, FM2021G3-VERS.2006, FM611E3-VERS.2006, FM611G3-VERS.2006, FM721E3, FM721E3-VERS.2006, FM721G3, FM721G3-VERS.2006		



			
1			
<b>GEV-Nr.</b>	361506	<b>Vergl.-Nr.</b>	3014470
<b>Beschreibung</b>	Rohrverschraubung gewinkelt Messing vernickelt Gewinde 1/8" Schlauch ø 6/8mm VPE 1 Stück		
<b>Für Modelle:</b>	FM101E2-VERS.2006, FM101E3, FM101E3-VERS.2006, FM101G2-VERS.2006, FM101G3, FM101G3-VERS.2006, FM1221E2-VERS.2006, FM1221E3, FM1221E3-VERS.2006, FM1221G2-VERS.2006, FM1221G3, FM1221G3-VERS.2006, FM2011E2-VERS.2006, FM2011E3-VERS.2006, FM2011G2-VERS.2006, FM2011G3-VERS.2006, FM2021E2-VERS.2006, FM2021E3-VERS.2006, FM2021G2-VERS.2006, FM2021G3-VERS.2006, FM423E2, FM611E2-VERS.2006, FM611E3, FM611E3-VERS.2006, FM611G2-VERS.2006, FM611G3, FM611G3-VERS.2006, FM721E2-VERS.2006, FM721E3, FM721E3-VERS.2006, FM721G2-VERS.2006, FM721G3, FM721G3-VERS.2006, FX101E2, FX101E2C, FX101E2C-VERS.032014, FX101E2R, FX101E2R-VERS.032014, FX101E2-VERS.032014, FX101E3, FX101E3C, FX101E3C-VERS.022014, FX101E3R, FX101E3R-VERS.022014, FX101E3-VERS.022014, FX101G2, FX101G2C, FX101G2C-VERS.032014, FX101G2R, FX101G2R-VERS.032014...(Weitere Modelle finden Sie in unserem Webshop)		

# Schläuche

## Zulaufschläuche

### PVC-Zulaufschläuche



<b>GEV-Nr.</b>	520010	<b>Vergl.-Nr.</b>	33M0350
<b>Beschreibung</b>	Zulaufschlauch PVC gerade-gebogen DN13 Anschlüsse 3/4" L 1500mm Arbeitsdruck 10bar Platzdruck 32bar T.max. 90°C blau Zulassung VDE flachdichtend		
<b>Für Modelle:</b>	04WBMEV, 04WCP1EM, 06WCP1GM, 08WCP1GM, 08WGREV, 091CP1E, 091CP1G, 0G1CP1EC, 0G1CP1E-VERS.2004, 0G1CP1G-VERS.2004, 10CP1EA, 10CP1GA, 10CP1IA, 12CP1EA, 12CP1GA, 12CP1IA, 18CP2EA, 18CP2GA, 18CP2IA, 191CP1G, 191CP2G, 1G1CP1G-VERS.2004, 1G1CP2G-VERS.2004, 6040110, 6042680, BX101E, BX101E-VERS.122013, BX101G, BX101G-VERS.122013, BX122E, BX122E-VERS.122013, BX122G, BX122G-VERS.122013, BX61E, BX61E-VERS.122013, BX61G, BX61G-VERS.122013, BX82E, BX82E-VERS.122013, BX82G, BX82G-VERS.122013, F60P, F60PR, F60T, F80P, F80PR, FC1011E, FC1011G, FC1221E, FC1221G...(Weitere Modelle finden Sie in unserem Webshop)		
<b>Zubehör für</b>	520010		
	<b>GEV-Nr.</b>	520053	<b>Vergl.-Nr.</b> —
	Sieb Anschluss 3/4" D1 ø 26mm D2 ø 15mm VPE 10 Stück Gummi Materialstärke 8mm		
	<b>GEV-Nr.</b>	520054	<b>Vergl.-Nr.</b> 3152480
	Flachdichtung Gummi AD ø 23.5mm ID ø 14mm Materialstärke 2.3mm VPE 10 Stück		

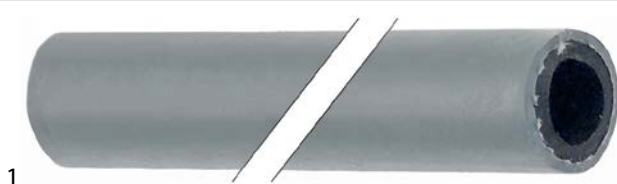

<b>GEV-Nr.</b>	520014	<b>Vergl.-Nr.</b>	131AA12-40MT
<b>Beschreibung</b>	Zulaufschlauch ID ø 10mm AD ø 17mm L 40m Arbeitsdruck 20bar Platzdruck 60bar T.max. 95°C grau VPE 40m		

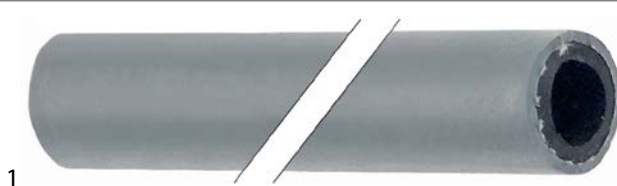

<b>GEV-Nr.</b>	520015	<b>Vergl.-Nr.</b>	131AA12-5MT
<b>Beschreibung</b>	Zulaufschlauch ID ø 10mm AD ø 17mm L 5m Arbeitsdruck 20bar Platzdruck 60bar T.max. 95°C grau VPE 5m		
<b>Zubehör für</b>	520015		
	<b>GEV-Nr.</b>	504377	<b>Vergl.-Nr.</b> —
	Schlauchverbinder Tülle ø 23mm Tüllenlänge 25mm Gesamtlänge 55mm für Wasserfüllung		

## Industrieschläuche

### Niplaflex-Schläuche



<b>GEV-Nr.</b>	570561	<b>Vergl.-Nr.</b>	111AA05-40MT
<b>Beschreibung</b>	Druckschlauch ID ø 10mm AD ø 17mm L 40m Wandstärke 3.5mm Arbeitsdruck 10bar Platzdruck 30bar T.max. 110°C		



<b>GEV-Nr.</b>	530561	<b>Vergl.-Nr.</b>	111AA05 131AA12 131AA14 131AA16
<b>Beschreibung</b>	Druckschlauch ID ø 10mm AD ø 17mm L 5m Wandstärke 3.5mm Arbeitsdruck 10bar Platzdruck 30bar T.max. 110°C		
<b>Für Modelle:</b>	04WBMEV, 04WCP1EM, 06WCP1GM, 06WFR3GD, 08WCP1GM, 08WGREV, 090BM1E, 090BM1G, 091CP1E, 091CP1G, 0G1CP1EC, 0G1CP1E-VERS.2004, 0G1CP1G-VERS.2004, 10CP1EA, 10CP1GA, 10CP1IA, 10WFR4GD, 12CP1EA, 12CP1GA, 12CP1IA, 18CP2EA, 18CP2GA, 18CP2IA, 190BM2E, 190BM2G, 190GRE, 191BR1E, 191BR1G, 191BR1GA, 191BR2E, 191BR2EA, 191BR2G, 191BR2GA, 191CP1G, 191CP2G, 1G0GRE, 1G1CP1G-VERS.2004, 1G1CP2G-VERS.2004, 291BR1E, 291BR1G, 291BR1GA, 291BR2E, 291BR2EA, 291BR2G, 291BR2GA, 6040090, 6040110, 6040310, 6042610, 6042630...(Weitere Modelle finden Sie in unserem Webshop)		

### PU-Schläuche



<b>GEV-Nr.</b>	512475	<b>Vergl.-Nr.</b>	3003920
<b>Beschreibung</b>	Dosierschlauch AD ø 8mm ID ø 6mm Polyurethan blau VPE Meterware		
<b>Für Modelle:</b>	FM1011E3, FM1011E3-VERS.2006, FM1011G3, FM1011G3-VERS.2006, FM1221E3, FM1221E3-VERS.2006, FM1221G3-VERS.2006, FM2011E3-VERS.2006, FM2011G3-VERS.2006, FM2021E3, FM2021E3-VERS.2006, FM2021G3, FM2021G3-VERS.2006, FM611E3, FM611E3-VERS.2006, FM611G3, FM611G3-VERS.2006, FM721E3, FM721E3-VERS.2006, FM721G3, FM721G3-VERS.2006, FX101E3, FX101E3C, FX101E3C-VERS.022014, FX101E3R, FX101E3R-VERS.022014, FX101E3-VERS.022014, FX101G3, FX101G3C, FX101G3C-VERS.022014, FX101G3R, FX101G3R-VERS.022014, FX101G3-VERS.022014, FX10E3CR, FX10E3CR-VERS.022014, FX10G3CR, FX10G3CR-VERS.022014, FX122E3, FX122E3C, FX122E3T, FX122E3T-VERS.022014, FX122G3, FX122G3C, FX122G3T, FX122G3T-VERS.022014, FX12E3CT, FX12E3CT-VERS.022014, FX12G3CT, FX12G3CT-VERS.022014, FX201E3...(Weitere Modelle finden Sie in unserem Webshop)		



			
1			
<b>GEV-Nr.</b>	510677	<b>Vergl.-Nr.</b>	3000290
<b>Beschreibung</b>	Dosierschlauch AD ø 8mm ID ø 6mm Polyurethan rot VPE Meterware		
<b>Für Modelle:</b>	FM1011E3, FM1011E3-VERS.2006, FM1011G3, FM1011G3-VERS.2006, FM1221E3, FM1221E3-VERS.2006, FM1221G3-VERS.2006, FM2011E3-VERS.2006, FM2011G3-VERS.2006, FM2021E3, FM2021E3-VERS.2006, FM2021G3, FM2021G3-VERS.2006, FM611E3, FM611E3-VERS.2006, FM611G3, FM611G3-VERS.2006, FM721E3, FM721E3-VERS.2006, FM721G3, FM721G3-VERS.2006, FX101E3, FX101E3C, FX101E3R, FX101G3, FX101G3C, FX101G3R, FX10E3CR, FX10G3CR, FX122E3, FX122E3C, FX122G3, FX122G3C, FX201E3, FX202E3, FX61E3, FX61E3C, FX61E3CR, FX61E3R, FX61G3, FX61G3C, FX61G3CR, FX61G3R, FX82E3, FX82E3C, FX82G3, FX82G3C		

<h3>Saug- und Druckschläuche</h3>			
			
1			
<b>GEV-Nr.</b>	530449	<b>Vergl.-Nr.</b>	111AA08
<b>Beschreibung</b>	Universalschlauch ID ø 50mm AD ø 64mm L 1m Arbeitsdruck 10bar Platzdruck 30bar Temp.Best. -30 bis +80°C		

<h3>Silikonschläuche</h3>			
<h4>für Schlauchpumpen</h4>			
			
1			
<b>GEV-Nr.</b>	570611 <sup>1</sup>	<b>Vergl.-Nr.</b>	131AA32
<b>Beschreibung</b>	Silikonschlauch für Schlauchpumpe ID ø 5mm AD ø 8mm Lm Wandstärke 1.5mm T.max. 200°C Shore A 55° Dosiertechnik		

<sup>1</sup>Meterware

## Fittinge, Schlauch- und Rohrverbinder

<h3>Schlauchverbinder</h3>			
<h4>ohne Verschraubung</h4>			
			
1			
<b>GEV-Nr.</b>	519630	<b>Vergl.-Nr.</b>	3008090
<b>Beschreibung</b>	T-Stück Kunststoff Schlauch ø 6x6x6mm 3-Wege		
<b>Für Modelle:</b>	191CP1G, 1G1CP1G-VERS.2004, FM1011E3, FM1011E3-VERS.2006, FM1011G3, FM1011G3-VERS.2006, FM1221E3-VERS.2006, FM1221G3-VERS.2006, FM2011E3-VERS.2006, FM2011G3-VERS.2006, FM2021E3-VERS.2006, FM2021G3-VERS.2006, FM611E3, FM611E3-VERS.2006, FM611G3, FM611G3-VERS.2006, FM721E3-VERS.2006, FM721G3-VERS.2006		

<h3>Fittinge</h3>			
<h4>Doppelnippel</h4>			
			
1			
<b>GEV-Nr.</b>	520160	<b>Vergl.-Nr.</b>	3005480
<b>Beschreibung</b>	Doppelnippel Messing vernickelt Gewinde 1/8" - 1/8" VPE 1 Stück		
<b>Für Modelle:</b>	FM1011E3, FM1011G3, FM1221E3, FM2021E3, FM2021G3, FM611E3, FM611G3, FM721E3, FM721G3		

			
1			
<b>GEV-Nr.</b>	541504	<b>Vergl.-Nr.</b>	33Q5880
<b>Beschreibung</b>	Doppelnippel Gewinde 1/2" - 1/2"		
<b>Für Modelle:</b>	FC101, FC241G, FC61, FCV101, FCV101-CSA, FCV101DM, FCV101DM-CSA, FCV101DS, FCV101DS-CSA, FCV141-CSA, FCV141DM-CSA, FCV141DS-CSA, FCV241G, FCV241G-CSA, FCV241GDM, FCV241GDM-CSA, FCV241GDS, FCV241GDS-CSA, FCV401DM, FCV401DM-CSA, FCV61, FCV61-CSA, FCV61DM, FCV61DM-CSA, FCV61DS, FCV61DS-CSA		

<h3>Reduzierungen</h3>			
			
1			
<b>GEV-Nr.</b>	520177	<b>Vergl.-Nr.</b>	3040920
<b>Beschreibung</b>	Reduzierung Gewinde 1/4" AG - 1/8" IG Messing vernickelt Gesamtlänge 13mm SW 17		
<b>Für Modelle:</b>	FM1011E3-VERS.2006, FM1011G3-VERS.2006, FM1221E3-VERS.2006, FM1221G3-VERS.2006, FM2011E3-VERS.2006, FM2011G3-VERS.2006, FM2021E3-VERS.2006, FM2021G3-VERS.2006, FM423E2, FM611E3-VERS.2006, FM611G3-VERS.2006, FM721E3-VERS.2006, FM721G3-VERS.2006		

<h3>Winkelstücke</h3>			
			
1			
<b>GEV-Nr.</b>	520825	<b>Vergl.-Nr.</b>	3115710
<b>Beschreibung</b>	Winkelstück Gewinde 1/4" AG - 1/4" IG Messing vernickelt		



1

<b>GEV-Nr.</b>	520824	<b>Vergl.-Nr.</b>	3003750
<b>Beschreibung</b>	Winkelstück Gewinde 1/8" AG - 1/8" IG Messing vernickelt		
<b>Für Modelle:</b>	FM1011E3, FM1011G3, FM1221E3, FM1221G3, FM2021E3, FM2021G3, FM611E3, FM611G3		

## Y-Stücke



1

<b>GEV-Nr.</b>	521197	<b>Vergl.-Nr.</b>	36E4290
<b>Beschreibung</b>	Y-Stück Gewinde 1/8" IG - 1/8" IG - 1/8" IG Edelstahl SW 13		
<b>Für Modelle:</b>	FM1011E3, FM1011G3, FM1221E3, FM1221G3, FM611E3, FM611G3, FM721E3, FM721G3		

## Schlauchanschlüsse

### Messing vernickelt



1

<b>GEV-Nr.</b>	520159	<b>Vergl.-Nr.</b>	3007950 33Q6630
<b>Beschreibung</b>	Schlauchanschluss Messing vernickelt gerade Gewinde 1/8" Schlauch ø 6mm VPE 1 Stück SW 12 Gesamtlänge 32mm Gewinde L 7.5mm Tülle ø 6mm Tüllenlänge 19.5mm		
<b>Für Modelle:</b>	FM1011E3, FM1011G3, FM1221E3, FM1221G3, FM2021E3, FM2021G3, FM423E2, FM611E3, FM611G3, FM721E3, FM721G3		



1

<b>GEV-Nr.</b>	361507	<b>Vergl.-Nr.</b>	3016150
<b>Beschreibung</b>	Rohrverschraubung gewinkelt Messing vernickelt Gewinde 1/4" Schlauch ø 6/8mm VPE 1 Stück		
<b>Für Modelle:</b>	FM1011E3-VERS.2006, FM1011G3-VERS.2006, FM1221E3, FM1221E3-VERS.2006, FM1221G3-VERS.2006, FM2011E3-VERS.2006, FM2011G3-VERS.2006, FM2021E3, FM2021E3-VERS.2006, FM2021G3, FM2021G3-VERS.2006, FM611E3-VERS.2006, FM611G3-VERS.2006, FM721E3, FM721E3-VERS.2006, FM721G3, FM721G3-VERS.2006		



1

<b>GEV-Nr.</b>	361506	<b>Vergl.-Nr.</b>	3014470
<b>Beschreibung</b>	Rohrverschraubung gewinkelt Messing vernickelt Gewinde 1/8" Schlauch ø 6/8mm VPE 1 Stück		
<b>Für Modelle:</b>	FM1011E2-VERS.2006, FM1011E3, FM1011E3-VERS.2006, FM1011G2-VERS.2006, FM1011G3, FM1011G3-VERS.2006, FM1221E2-VERS.2006, FM1221E3, FM1221E3-VERS.2006, FM1221G2-VERS.2006, FM1221G3, FM1221G3-VERS.2006, FM2011E2-VERS.2006, FM2011E3-VERS.2006, FM2011G2-VERS.2006, FM2011G3-VERS.2006, FM2021E2-VERS.2006, FM2021E3-VERS.2006, FM2021G2-VERS.2006, FM2021G3-VERS.2006, FM423E2, FM611E2-VERS.2006, FM611E3, FM611E3-VERS.2006, FM611G2-VERS.2006, FM611G3, FM611G3-VERS.2006, FM721E2-VERS.2006, FM721E3, FM721E3-VERS.2006, FM721G2-VERS.2006, FM721G3, FM721G3-VERS.2006, FX101E2, FX101E2C, FX101E2C-VERS.032014, FX101E2R, FX101E2R-VERS.032014, FX101E2-VERS.032014, FX101E3, FX101E3C, FX101E3C-VERS.022014, FX101E3R, FX101E3R-VERS.022014, FX101E3-VERS.022014, FX101G2, FX101G2C, FX101G2C-VERS.032014, FX101G2R, FX101G2R-VERS.032014...(Weitere Modelle finden Sie in unserem Webshop)		

## Herstellerspezifisch





1

<b>GEV-Nr.</b>	520337	<b>Vergl.-Nr.</b>	3007980
<b>Beschreibung</b>	Schlauchanschluss Gewinde 1/4" Tülle ø 7mm ID ø 4.5mm Tüllenlänge 19mm SW 14 Gesamtlänge 35mm Gewinde L 10mm		
<b>Für Modelle:</b>	04WCP1EM, 06WCP1GM, 08WCP1GM, 091CP1E, 091CP1G, 0G1CP1EC, 0G1CP1E-VERS.2004, 0G1CP1G-VERS.2004, 191CP1G, 191CP2G, 1G1CP1G-VERS.2004, 1G1CP2G-VERS.2004, 6040090, 6040310, 6043850, 6043980, FM1011E3, FM1011G3, FM1221E3, FM1221G3, FM611E3, FM611G3, FM721E3, FM721G3		



1

<b>GEV-Nr.</b>	541488	<b>Vergl.-Nr.</b>	33Q5591 33Q5592
<b>Beschreibung</b>	Schlauchanschluss Gewinde M14x1 AG - 1/8"IG gewinkelt		
<b>Für Modelle:</b>	FC101, FC101E, FC241, FC241E, FC241G, FC61, FC61E, FCV101, FCV101-CSA, FCV101DM, FCV101DM-CSA, FCV101DS, FCV101DS-CSA, FCV101E, FCV101EDM, FCV101EDM-UL, FCV101EDS, FCV101EDS-UL, FCV101E-UL, FCV141, FCV141-CSA, FCV141DM, FCV141DM-CSA, FCV141DS, FCV141DS-CSA, FCV141E, FCV141EDM, FCV141EDS, FCV241, FCV241DM, FCV241DS, FCV241E, FCV241EDM, FCV241EDM-UL, FCV241EDS, FCV241EDS-UL, FCV241E-UL, FCV241G, FCV241G-CSA, FCV241GDM, FCV241GDM-CSA, FCV241GDS, FCV241GDS-CSA, FCV3EM, FCV401DM, FCV401DM-CSA, FCV401EDM, FCV401EDM-UL, FCV4E, FCV4EDS...(Weitere Modelle finden Sie in unserem Webshop)		

<b>Zubehör für</b>	541488			
	<b>GEV-Nr.</b>	541507	<b>Vergl.-Nr.</b>	33T4110
				Düse Kühlung Gewinde 1/8"
	<b>GEV-Nr.</b>	541509	<b>Vergl.-Nr.</b>	33T3720
				Düse Kühlung Gewinde 1/8"





## Getränketechnik

### Ventile

#### Rückschlagventile



1

<b>GEV-Nr.</b>	440729	<b>Vergl.-Nr.</b>	3114800
<b>Beschreibung</b>	Rückschlagventil John Guest Rohranschluss 5/16" - 5/16" Arbeitsdruck bei 20°C 10bar Öffnungsdruck 0.02bar POM für Schlauch ø 8mm		
<b>Für Modelle:</b>	FM1011E3-VERS.2006, FM1011G3-VERS.2006, FM1221E3-VERS.2006, FM1221G3-VERS.2006, FM2011E3-VERS.2006, FM2011G3-VERS.2006, FM2021E3-VERS.2006, FM2021G3-VERS.2006, FM611E3-VERS.2006, FM611G3-VERS.2006, FM721E3-VERS.2006, FM721G3-VERS.2006, FX101E3, FX101E3C, FX101E3C-VERS.022014, FX101E3R, FX101E3R-VERS.022014, FX101E3-VERS.022014, FX101G3, FX101G3C, FX101G3C-VERS.022014, FX101G3R, FX101G3R-VERS.022014, FX101G3-VERS.022014, FX10E3CR, FX10E3CR-VERS.022014, FX10G3CR, FX10G3CR-VERS.022014, FX122E3, FX122E3C, FX122E3T, FX122E3T-VERS.022014, FX122G3, FX122G3C, FX122G3T, FX122G3T-VERS.022014, FX12E3CT, FX12E3CT-VERS.022014, FX12G3CT, FX12G3CT-VERS.022014, FX201E3, FX201E3P, FX201E3P-VERS.022014, FX201E3-VERS.022014, FX201G3P, FX201G3-VERS.022014, FX202E3, FX202E3-230V-3-50Hz-60Hz, FX202E3-230V-3-50Hz-60Hz-VERS.022014, FX202E3-VERS.022014...(Weitere Modelle finden Sie in unserem Webshop)		
<b>Zubehör für</b>	440729		
	<b>GEV-Nr.</b>	520983	<b>Vergl.-Nr.</b>
			—
	Schlauch ID ø 6 Außen-ø 8 John Guest Wandstärke 1mm LLDPE blau		

## Wasserkreislaufkomponenten

### Druckminderer

#### Druckminderer

##### Universal



1

<b>GEV-Nr.</b>	520967	<b>Vergl.-Nr.</b>	33D1650
<b>Beschreibung</b>	Druckminderer Serie HP WR01 Anschluss 1/2" Voreinstellung 3bar Einstellbereich 1-6bar p max 16bar T.max. 40°C Messing verchromt IMPORT		

### Zulauffilter



1

<b>GEV-Nr.</b>	520261	<b>Vergl.-Nr.</b>	35Q2780
<b>Beschreibung</b>	Zulauffilter Gewinde 1/2" IG - 1/2" IG Baulänge 58mm Rotguss Maschenweite 0.4mm		



1

<b>GEV-Nr.</b>	520262	<b>Vergl.-Nr.</b>	33Q6090 33Q6091 35Q2790
<b>Beschreibung</b>	Zulauffilter Gewinde 3/4" IG - 3/4" IG Baulänge 70mm Rotguss DN20 Maschenweite 0.4mm		
<b>Für Modelle:</b>	FC101, FC101E, FC241, FC241E, FC241G, FC61, FC61E, FCV101, FCV101-CSA, FCV101DM, FCV101DM-CSA, FCV101DS, FCV101DS-CSA, FCV101E, FCV101EDM, FCV101EDM-UL, FCV101EDS, FCV101EDS-UL, FCV101E-UL, FCV141, FCV141-CSA, FCV141DM, FCV141DM-CSA, FCV141DS, FCV141DS-CSA, FCV141E, FCV141EDM, FCV141EDS, FCV241, FCV241DM, FCV241DS, FCV241E, FCV241EDM, FCV241EDM-UL, FCV241EDS, FCV241EDS-UL, FCV241E-UL, FCV241G, FCV241G-CSA, FCV241GDM, FCV241GDM-CSA, FCV241GDS, FCV241GDS-CSA, FCV401DM, FCV401DM-CSA, FCV401EDM, FCV401EDM-UL, FCV4E, FCV4EDS, FCV61...(Weitere Modelle finden Sie in unserem Webshop)		

## Hilfsmittel

### Schellen

#### Schlauchschellen

##### DIN 3017 - W2



1

<b>GEV-Nr.</b>	520111	<b>Vergl.-Nr.</b>	36E4320
<b>Beschreibung</b>	Schlauchschelle Edelstahl/Stahl ø 10-16mm Breite 9mm VPE 10 Stück DIN 3017		
<b>Für Modelle:</b>	FM1011E2-VERS.2006, FM1011E3, FM1011E3-VERS.2006, FM1011G2-VERS.2006, FM1011G3, FM1011G3-VERS.2006, FM1221E2-VERS.2006, FM1221E3, FM1221E3-VERS.2006, FM1221G2-VERS.2006, FM1221G3, FM1221G3-VERS.2006, FM2011E2-VERS.2006, FM2011E3-VERS.2006, FM2011G2-VERS.2006, FM2011G3-VERS.2006, FM2021E2-VERS.2006, FM2021E3, FM2021E3-VERS.2006, FM2021G2-VERS.2006, FM2021G3, FM2021G3-VERS.2006, FM423E2, FM611E2-VERS.2006, FM611E3, FM611E3-VERS.2006, FM611G2-VERS.2006, FM611G3, FM611G3-VERS.2006, FM721E2-VERS.2006, FM721E3, FM721E3-VERS.2006, FM721G2-VERS.2006, FM721G3, FM721G3-VERS.2006		

			
1			
<b>GEV-Nr.</b>	520115	<b>Vergl.-Nr.</b>	3140220
<b>Beschreibung</b>	Schlauchschelle Edelstahl/Stahl ø 25-40mm Breite 9mm VPE 10 Stück DIN 3017		
<b>Für Modelle:</b>	191CP1G, 6040110, 6042610, 6042630, 6042680, 6043850, 6043980, 6044340, 6044350, FC101, FC1011E, FC1011G, FC101E, FC1221E, FC1221G, FC241, FC61, FC611E, FC611G, FC61E, FCV101, FCV101DM, FCV101DS, FCV101E, FCV101EDM, FCV101EDM-UL, FCV101EDS, FCV241, FCV241DM, FCV241DS, FCV4E, FCV4EDS, FCV61, FCV61DM, FCV61DS, FCV61E, FCV61EDM, FCV61EDS, FM1011E1-VERS.2006, FM1011E2-VERS.2006, FM1011E3-VERS.2006, FM1011G1-VERS.2006, FM1011G2-VERS.2006, FM1011G3-VERS.2006, FM1221E1, FM1221E1-VERS.2006, FM1221E2, FM1221E2-VERS.2006, FM1221E3, FM1221E3-VERS.2006...(Weitere Modelle finden Sie in unserem Webshop)		

			
1			
<b>GEV-Nr.</b>	520119	<b>Vergl.-Nr.</b>	3140200
<b>Beschreibung</b>	Schlauchschelle Edelstahl/Stahl ø 60-80mm Breite 9mm VPE 5 Stück DIN 3017		
<b>Für Modelle:</b>	L100, L80, LP202, LP202HC, LP302, LP302HC, LP402, LP402HC, LP402V		

**DIN 3017 - W4**

			
1			
<b>GEV-Nr.</b>	520121	<b>Vergl.-Nr.</b>	3140230
<b>Beschreibung</b>	Schlauchschelle CNS W4 ø 16-27mm Breite 9mm VPE 1 Stück DIN 3017		

			
1			
<b>GEV-Nr.</b>	801198	<b>Vergl.-Nr.</b>	3019160
<b>Beschreibung</b>	Schraube für Abzieher Gewinde M16x1,5 L 63mm SW 17		

**Messtechnik**
**Thermometer**
**Einbauthermometer**

ø52mm

			
1			
<b>GEV-Nr.</b>	541347	<b>Vergl.-Nr.</b>	32Z0151
<b>Beschreibung</b>	Thermometer Einbau ø 52mm T.max. 350°C +50 bis +350°C Fühler ø 4mm Fühler L 60mm Kapillarrohr 1000mm		
<b>Für Modelle:</b>	FC101, FC1011E, FC1011G, FC101E, FC1221E, FC1221G, FC241, FC241E, FC241G, FC61, FC611E, FC611G, FC61E		

			
1			
<b>GEV-Nr.</b>	541582	<b>Vergl.-Nr.</b>	32Z0040
<b>Beschreibung</b>	Thermometer Einbau ø 52mm T.max. 350°C +50 bis +350°C Fühler ø 6mm Fühler L 17mm Kapillarrohr 1700mm		

**Werkzeuge**
**Handwerkzeuge**
**Abzieher**

			
1			
<b>GEV-Nr.</b>	801197	<b>Vergl.-Nr.</b>	3018670 6003060
<b>Beschreibung</b>	Abzieher für Lüfterrad Aufnahme ø 27-33mm Gewinde M16x1,5 SW 17		
<b>Für Modelle:</b>	FM1011E1, FM1011E2, FM1011E3, FM1011G1, FM1011G2, FM1011G3, FM1221E1, FM1221E2, FM1221E3, FM1221G1, FM1221G2, FM1221G3, FM611E1, FM611E2, FM611E3, FM611G1, FM611G2, FM611G3		
<b>Ersatzteile für</b>	801197		
	<b>GEV-Nr.</b>	<b>Vergl.-Nr.</b>	3019160
	 Schraube für Abzieher Gewinde M16x1,5 L 63mm SW 17		



## Befestigungsmaterialien

### Schrauben

#### Sechskantschrauben



<b>GEV-Nr.</b>	506445	<b>Vergl.-Nr.</b>	3016470
<b>Beschreibung</b>	Sechskantschraube Gewinde M10 Gewinde L 35mm CNS SW 17 VPE 1 Stück DIN 933 / ISO 4017		
<b>Für Modelle:</b>	BX101E, BX101E-VERS.122013, BX101G, BX101G-VERS.122013, BX122E, BX122E-VERS.122013, BX122G, BX122G-VERS.122013, BX61E, BX61E-VERS.122013, BX61G, BX61G-VERS.122013, BX82E, BX82E-VERS.122013, BX82G, BX82G-VERS.122013, FC1011E, FC1011G, FC1221E, FC1221G, FC611E, FC611G, FM1011E1, FM1011E1-VERS.2006, FM1011E2, FM1011E2-VERS.2006, FM1011E3, FM1011E3-VERS.2006, FM1011G1, FM1011G1-VERS.2006, FM1011G2, FM1011G2-VERS.2006, FM1011G3, FM1011G3-VERS.2006, FM1221E1, FM1221E1-VERS.2006, FM1221E2, FM1221E2-VERS.2006, FM1221E3, FM1221E3-VERS.2006, FM1221G1, FM1221G1-VERS.2006, FM1221G2, FM1221G2-VERS.2006, FM1221G3, FM1221G3-VERS.2006, FM2011E2-VERS.2006, FM2011E3-VERS.2006, FM2011G2-VERS.2006, FM2011G3-VERS.2006...(Weitere Modelle finden Sie in unserem Webshop)		



<b>GEV-Nr.</b>	560081	<b>Vergl.-Nr.</b>	31B8800
<b>Beschreibung</b>	Sechskantschraube Gewinde M4 Gewinde L 10mm CNS SW 7 VPE 20 Stück DIN 933 / ISO 4017		



<b>GEV-Nr.</b>	560086	<b>Vergl.-Nr.</b>	31A0560
<b>Beschreibung</b>	Sechskantschraube Gewinde M6 Gewinde L 10mm CNS SW 10 VPE 20 Stück DIN 933 / ISO 4017		
<b>Für Modelle:</b>	BX101E, BX101E-VERS.122013, BX101G, BX101G-VERS.122013, BX122E, BX122E-VERS.122013, BX122G, BX122G-VERS.122013, BX61E, BX61E-VERS.122013, BX61G, BX61G-VERS.122013, BX82E, BX82E-VERS.122013, BX82G, BX82G-VERS.122013, FX101E1, FX101E1R, FX101E2, FX101E2C, FX101E2C-VERS.032014, FX101E2R, FX101E2R-VERS.032014, FX101E2-VERS.032014, FX101E3, FX101E3C, FX101E3C-VERS.022014, FX101E3R, FX101E3R-VERS.022014, FX101E3-VERS.022014, FX101G1, FX101G1R, FX101G2, FX101G2C, FX101G2C-VERS.032014, FX101G2R, FX101G2R-VERS.032014, FX101G2-VERS.032014, FX101G3, FX101G3C, FX101G3C-VERS.022014, FX101G3R, FX101G3R-VERS.022014, FX101G3-VERS.022014, FX10E2CR, FX10E2CR-VERS.032014, FX10E3CR, FX10E3CR-VERS.022014, FX10G2CR, FX10G2CR-VERS.032014...(Weitere Modelle finden Sie in unserem Webshop)		

#### Sonstige



<b>GEV-Nr.</b>	514285	<b>Vergl.-Nr.</b>	3190040
<b>Beschreibung</b>	Schraube		
<b>Für Modelle:</b>	090GRG, 190GRG, FC101, FC1011E, FC1011G, FC101E, FC1221E, FC1221G, FC241, FC241E, FC241G, FC61, FC611E, FC611G, FC61E, FCV101, FCV101-CSA, FCV101DM, FCV101DM-CSA, FCV101DS, FCV101DS-CSA, FCV101E, FCV101EDM, FCV101EDM-UL, FCV101EDS, FCV101EDS-UL, FCV101E-UL, FCV141, FCV141-CSA, FCV141DM, FCV141DM-CSA, FCV141DS, FCV141DS-CSA, FCV141E, FCV141EDM, FCV141EDS, FCV241, FCV241DM, FCV241DS, FCV241E, FCV241EDM, FCV241EDM-UL, FCV241EDS, FCV241EDS-UL, FCV241E-UL, FCV241G, FCV241G-CSA, FCV241GDM, FCV241GDM-CSA, FCV241GDS...(Weitere Modelle finden Sie in unserem Webshop)		



<b>GEV-Nr.</b>	691459	<b>Vergl.-Nr.</b>	3190020
<b>Beschreibung</b>	Schraube Gewinde M6 L 10mm SW 14		
<b>Für Modelle:</b>	FC101, FC1011E, FC1011G, FC101E, FC1221E, FC1221G, FC241, FC241E, FC241G, FC61, FC611E, FC611G, FC61E, FCV101, FCV101-CSA, FCV101DM, FCV101DM-CSA, FCV101DS, FCV101DS-CSA, FCV101E, FCV101EDM, FCV101EDM-UL, FCV101EDS, FCV101EDS-UL, FCV101E-UL, FCV141, FCV141-CSA, FCV141DM, FCV141DM-CSA, FCV141DS, FCV141DS-CSA, FCV141E, FCV141EDM, FCV141EDS, FCV241, FCV241DM, FCV241DS, FCV241E, FCV241EDM, FCV241EDM-UL, FCV241EDS, FCV241EDS-UL, FCV241E-UL, FCV241G, FCV241G-CSA, FCV241GDM, FCV241GDM-CSA, FCV241GDS, FCV241GDS-CSA, FCV3EM...(Weitere Modelle finden Sie in unserem Webshop)		

### Muttern

#### Sechskantmutter

DIN 934 / ISO 4032/8673



<b>GEV-Nr.</b>	517174	<b>Vergl.-Nr.</b>	3110050 33Q6470
<b>Beschreibung</b>	Mutter Gewinde M8 H 6.5mm SW 13 CNS DIN/ISO DIN 934 / ISO 4032/8673 VPE 1 Stück		
<b>Für Modelle:</b>	04WBMEV, 091FR1EA, 091FR1EX, 091FR1IA, 091FR7G5, 091FR7GX, 6043850, 6043980, 71ARE, 91ARE, BRE21HD, BRE31HD, C165D, C165S, C165VD, C165VS, C207D, C207D-VERS.2006, C207S, C207S-VERS.2006, C207VD, C207VD-VERS.2006, C207VS, C207VS-VERS.2006, C304AD, C304AD-VERS.2006, C304AS, C304AS-VERS.2006, C304AVD, C304AVD-VERS.2006, C304AVS, C304AVS-VERS.2006, C304D, C304D-VERS.2006, C304S, C304S-VERS.2006, C304VD, C304VD-VERS.2006, C304VS, C304VS-VERS.2006, C92D-VERS.2006, C92S-VERS.2006, C92VD-VERS.2006, C92VS-VERS.2006, CS243D, CS243D-VERS.2006, CS243S, CS243S-VERS.2006, CS243VD, CS243VD-VERS.2006...(Weitere Modelle finden Sie in unserem Webshop)		



## Scheiben

### Unterlegscheiben

#### DIN 125A



1

<b>GEV-Nr.</b>	560312	<b>Vergl.-Nr.</b>	3120080
<b>Beschreibung</b>	Unterlegscheibe ID ø 10.5mm AD ø 20mm Materialstärke 2mm CNS VPE 1 Stück DIN 125A für Gewinde M10		
<b>Für Modelle:</b>	10CP1EA, 10CP1GA, 10CP1IA, 12CP1EA, 12CP1GA, 12CP1IA, 18CP2EA, 18CP2GA, 18CP2IA, BRE21HD, BRE31HD, FCV101-CSA, FCV101DM-CSA, FCV101DS-CSA, FCV101EDM-UL, FCV101EDS-UL, FCV101E-UL, FCV141-CSA, FCV141DM-CSA, FCV141DS-CSA, FCV241EDM-UL, FCV241EDS-UL, FCV241E-UL, FCV401DM-CSA, FCV401EDM-UL, FCV61-CSA, FCV61DM-CSA, FCV61DS-CSA, FCV61EDM-UL, FCV61EDS-UL, FCV61E-UL, FCV72EDS-UL, FCV72E-UL, PIER06HD, PIER10HD, PIER15HD		



1

<b>GEV-Nr.</b>	560113	<b>Vergl.-Nr.</b>	3121480
<b>Beschreibung</b>	Unterlegscheibe ID ø 6.4mm AD ø 12mm Materialstärke 1.6mm CNS VPE 20 Stück DIN 125A für Gewinde M6		
<b>Für Modelle:</b>	030FE1, 30F1, 30FES2, 30FS2, 70F1, 70FE1, 70FES2, 70FES2B, 71F2, 71FE2, 91F210		

#### DIN 9021



1

<b>GEV-Nr.</b>	560210	<b>Vergl.-Nr.</b>	3014810
<b>Beschreibung</b>	Unterlegscheibe ID ø 11mm AD ø 30mm Materialstärke 2mm CNS VPE 1 Stück DIN 9021 für Gewinde M10		
<b>Für Modelle:</b>	FC1011E, FC1011G, FC1221E, FC1221G, FC611E, FC611G, FM1011E1, FM1011E1-VERS.2006, FM1011E2, FM1011E2-VERS.2006, FM1011E3, FM1011E3-VERS.2006, FM1011G1, FM1011G1-VERS.2006, FM1011G2, FM1011G2-VERS.2006, FM1011G3, FM1011G3-VERS.2006, FM1221E1, FM1221E1-VERS.2006, FM1221E2, FM1221E2-VERS.2006, FM1221E3, FM1221E3-VERS.2006, FM1221G1, FM1221G1-VERS.2006, FM1221G2, FM1221G2-VERS.2006, FM1221G3, FM1221G3-VERS.2006, FM2011E2-VERS.2006, FM2011E3-VERS.2006, FM2011G2-VERS.2006, FM2011G3-VERS.2006, FM2021E1, FM2021E2, FM2021E2-VERS.2006, FM2021E3, FM2021E3-VERS.2006, FM2021G1, FM2021G2, FM2021G2-VERS.2006, FM2021G3, FM2021G3-VERS.2006, FM611E1, FM611E1-VERS.2006, FM611E2, FM611E2-VERS.2006, FM611E3, FM611E3-VERS.2006... (Weitere Modelle finden Sie in unserem Webshop)		

## Befestigungen

### Schellen

#### Schlauchschellen

#### DIN 3017 - W2



1

<b>GEV-Nr.</b>	520111	<b>Vergl.-Nr.</b>	36E4320
<b>Beschreibung</b>	Schlauchschelle Edelstahl/Stahl ø 10-16mm Breite 9mm VPE 10 Stück DIN 3017		
<b>Für Modelle:</b>	FM1011E2-VERS.2006, FM1011E3, FM1011E3-VERS.2006, FM1011G2-VERS.2006, FM1011G3, FM1011G3-VERS.2006, FM1221E2-VERS.2006, FM1221E3, FM1221E3-VERS.2006, FM1221G2-VERS.2006, FM1221G3, FM1221G3-VERS.2006, FM2011E2-VERS.2006, FM2011E3-VERS.2006, FM2011G2-VERS.2006, FM2011G3-VERS.2006, FM2021E2-VERS.2006, FM2021E3, FM2021E3-VERS.2006, FM2021G2-VERS.2006, FM2021G3, FM2021G3-VERS.2006, FM423E2, FM611E2-VERS.2006, FM611E3, FM611E3-VERS.2006, FM611G2-VERS.2006, FM611G3, FM611G3-VERS.2006, FM721E2-VERS.2006, FM721E3, FM721E3-VERS.2006, FM721G2-VERS.2006, FM721G3, FM721G3-VERS.2006		



1

<b>GEV-Nr.</b>	520115	<b>Vergl.-Nr.</b>	3140220
<b>Beschreibung</b>	Schlauchschelle Edelstahl/Stahl ø 25-40mm Breite 9mm VPE 10 Stück DIN 3017		
<b>Für Modelle:</b>	191CP1G, 6040110, 6042610, 6042630, 6042680, 6043850, 6043980, 6044340, 6044350, FC101, FC1011E, FC1011G, FC101E, FC1221E, FC1221G, FC241, FC61, FC611E, FC611G, FC61E, FCV101, FCV101DM, FCV101DS, FCV101E, FCV101EDM, FCV101EDM-UL, FCV101EDS, FCV241, FCV241DM, FCV241DS, FCV4E, FCV4EDS, FCV61, FCV61DM, FCV61DS, FCV61E, FCV61EDM, FCV61EDS, FM1011E1-VERS.2006, FM1011E2-VERS.2006, FM1011E3-VERS.2006, FM1011G1-VERS.2006, FM1011G2-VERS.2006, FM1011G3-VERS.2006, FM1221E1-VERS.2006, FM1221E2, FM1221E2-VERS.2006, FM1221E3, FM1221E3-VERS.2006...(Weitere Modelle finden Sie in unserem Webshop)		



1

<b>GEV-Nr.</b>	520119	<b>Vergl.-Nr.</b>	3140200
<b>Beschreibung</b>	Schlauchschelle Edelstahl/Stahl ø 60-80mm Breite 9mm VPE 5 Stück DIN 3017		
<b>Für Modelle:</b>	L100, L80, LP202, LP202HC, LP302, LP302HC, LP402, LP402HC, LP402V		



DIN 3017 - W4			
1			
<b>GEV-Nr.</b>	520121	<b>Vergl.-Nr.</b>	3140230
<b>Beschreibung</b>	Schlauchschelle CNS W4 ø 16-27mm Breite 9mm VPE 1 Stück DIN 3017		

Sicherungsringe			
DIN 6799			
1			
<b>GEV-Nr.</b>	518557	<b>Vergl.-Nr.</b>	3120460
<b>Beschreibung</b>	Sicherungsring E D1 ø 5mm D2 ø 11mm CNS DIN 6799 Stärke 0.7mm		
<b>Für Modelle:</b>	04WFAAV, 04WVT1IV, 04WVT2IV, 08WFA4E, 08WFA4G, 08WFAAE, 08WFAAG, 08WFAAV, 08WVT1IV, 08WVT2IV, 090FAA, 091VT1I, 091VT2I, 0A0FA1, 0A0FA4, 0A0FAA, 0A1VT1I, 0A1VT2I, 0D0FA1, 0D0FA4, 0D0FAA, 0D1VT1I, 0D1VT2I, 0G0FA0, 12WFA6E, 12WFA6G, 12WFAAA, 12WFAAE, 12WFAAG, 12WFAAN, 190FA, 190FAA, 190FAB, 190FAD, 191FAAE, 191FAAG, 191FABG, 191FADG, 191FAE, 191FAG, 191VT1I, 191VT2I, 1A0FA1, 1A0FA2, 1A0FA4, 1A0FA5, 1A0FAA, 1A0FAB, 1A1FA1G, 1A1FA2G...(Weitere Modelle finden Sie in unserem Webshop)		

Schraubkappen			
1			
<b>GEV-Nr.</b>	512516	<b>Vergl.-Nr.</b>	3005450
<b>Beschreibung</b>	Schraubkappe Gewinde 1/2" Gewinde L 8mm CNS VPE 1 SW 17 Kopfstärke 4.5mm		
<b>Für Modelle:</b>	FM1011E3, FM1011G3, FM1221E3, FM611E3, FM611G3, FM721E3, FM721G3		

## Verbrauchsgüter

### Sicherungen

Feinsicherungen			
1			
<b>GEV-Nr.</b>	358668	<b>Vergl.-Nr.</b>	3201540
<b>Beschreibung</b>	Feinsicherung Größe ø5x20mm 0.5A flink Nennspannung 250V VPE 10 Stück		
<b>Für Modelle:</b>	04WFR3ED, 08WFR4ED, 08WGREV, 091FR3ED, 0A1FR1ED, 0A1FR3ED, 0D1FR1ED, 0D1FR3ED, 0G0FR3ED, 10CP1EA, 10CP1GA, 10CP1IA, 12CP1EA, 12CP1GA, 12CP1IA, 18CP2EA, 18CP2GA, 18CP2IA, 191FR4ED, 1A1FR2ED, 1A1FR4ED, 1D1FR2ED, 1D1FR4ED, 71RA, 91RA, FC101, FC1011E, FC1011G, FC101E, FC1221E, FC1221G, FC241, FC241E, FC241G, FC61, FC611E, FC611G, FC61E, FCV101, FCV101DM, FCV101DS, FCV101E, FCV101EDM, FCV101EDS, FCV141, FCV141DM, FCV141DS, FCV141E, FCV141EDM, FCV141EDS...(Weitere Modelle finden Sie in unserem Webshop)		

1			
<b>GEV-Nr.</b>	358671	<b>Vergl.-Nr.</b>	3200020
<b>Beschreibung</b>	Feinsicherung Größe ø5x20mm 1A flink Nennspannung 250V VPE 10 Stück		
<b>Für Modelle:</b>	06WBR3E, 0G1BR3E, 191BR1E, 191BR1GA, 191BR2E, 191BR2EA, 191BR2GA, 1A1BR1E, 1A1BR1GA, 1A1BR2E, 1A1BR2EA, 1A1BR2GA, 1D1BR1E, 1D1BR1GA, 1D1BR2E, 1D1BR2EA, 1D1BR2GA, 1G1BR3E, 291BR1E, 291BR1GA, 291BR2E, 291BR2EA, 291BR2GA, 2A1BR1E, 2A1BR1GA, 2A1BR2E, 2A1BR2EA, 2A1BR2GA, 2D1BR1E, 2D1BR1GA, 2D1BR2E, 2D1BR2EA, 2D1BR2GA, 71ARE, 91ARE, FCV401DM, FCV401EDM		

ø10x38mm 500V			
1			
<b>GEV-Nr.</b>	358031	<b>Vergl.-Nr.</b>	32V6210
<b>Beschreibung</b>	Feinsicherung Größe ø10x38mm 10A Nennspannung 500V Typ gG flink VPE 1 Stück		
<b>Für Modelle:</b>	BX101E, BX101E-VERS.122013, BX122E, BX122E-VERS.122013, BX61E, BX61E-VERS.122013, BX82E, BX82E-VERS.122013, FC1011E, FC1221E, FC611E, FM1011E1, FM1011E1-VERS.2006, FM1011E2, FM1011E2-VERS.2006, FM1011E3, FM1011E3-VERS.2006, FM1221E1, FM1221E1-VERS.2006, FM1221E2, FM1221E2-VERS.2006, FM1221E3-VERS.2006, FM2011E2-VERS.2006, FM2011E3-VERS.2006, FM2021E1, FM2021E2, FM2021E2-VERS.2006, FM2021E3, FM2021E3-VERS.2006, FM611E1, FM611E1-VERS.2006, FM611E2, FM611E2-VERS.2006, FM611E3, FM611E3-VERS.2006, FM721E1, FM721E1-VERS.2006, FM721E2, FM721E2-VERS.2006, FM721E3, FM721E3-VERS.2006, FX101E1, FX101E1R, FX101E2, FX101E2C, FX101E2C-VERS.032014, FX101E2R, FX101E2R-VERS.032014, FX101E3...(Weitere Modelle finden Sie in unserem Webshop)		



<b>A</b>		<b>I</b>	
Abzieher	90	Industrieschläuche	86
Alarmgeber	20	<b>K</b>	
Anlegethermostate	4, 4	Kabel	40
Axiallüfter	33	Kantenverschlüsse	73
<b>B</b>		Klemmen	40
Backofenlampen	15	Kloben	73
Befestigungen	92	Kondensatoren & Entstörfilter	38
Befestigungsmaterialien	91	<b>L</b>	
Betriebskondensatoren	38	Lampen	13
<b>D</b>		Lüfter	33
Dichtungsringe	82	<b>M</b>	
Doppelnippel	87	Magnetschalter	11
Dosiergeräte	85	Magnetventile	28
Drehhebelverschlüsse	67	Messtechnik	90
Druckminderer	89, 89	Mikroschalter	8
Druckschalter/-taster	7	Muttern	91
<b>E</b>		<b>N</b>	
Elektrozubehör	40	Niplaflex-Schläuche	86
Energieregler	4	Nockenschalter	10
Erdungskabel	40	<b>O</b>	
<b>F</b>		O-Ringe	81
Feinsicherungen	93	<b>P</b>	
Fensterdichtungen	76	Pressostate	32
Filter	39	Programmtimer	19
Fittinge	87	Pumpen	38
Fühler	25	Pumpenschläuche	85
<b>G</b>		PU-Schläuche	86
Gasbrenner	54	PVC-Zulaufschläuche	86
Gasdüsen	54	<b>R</b>	
Gasfeuerungsautomaten	45	Radiallüfter	38
Gasregelventile	41	Reduzierungen	87
Gebläsebrenner	54	Regelthermostate	4, 6
Gerätehandbrausen	84	Relais	23
Getränketechnik	89	Roste und Stellschienen	76
GEV	2	Rückschlagventile	89
Gitterroste	76	<b>S</b>	
Glühlampen	14	Saug- und Druckschläuche	87
<b>H</b>		Schalter und Taster	7
Halogenleuchtmittel	15	Scharnierbänder	74
Handwerkzeuge	90	Schellen	89, 92
Heißluftmotoren	33	Schlauchanschlüsse	88
Heißluftventilatoren	37	Schläuche	86
Heizkörper	2	Schlauchschellen	89, 92
Horndenwagendichtungen	81		

Schlauchverbinder	87
Schlauchverschraubungen	85
Schnappverschlüsse	73
Schrauben	91
Schraubkappen	93
Schütze	20
Schwimmerschalter	10
Sechskantmuttern	91
Sechskantschrauben	91
Sicherheitsthermostate	5
Sicherungen	39, 93
Sicherungsringe	93
Signallampen	13
Signallampen komplett	13
Silikonschläuche	85, 87
Stabbrenner	54
Systemschalter ROLD	10

**T**

Tauchheizkörper	2
Temperaturfühler	25
Thermikdichtungen	76
Thermoelemente	51
Thermostate	4
Timer	19
Transformatoren	24
Treibriegelverschlüsse	73
Türdichtungen	77

**U**

Umluftheizkörper	2
Universalfühler	25
Unterlegscheiben	92

**V**

Ventile	89
Verbindungskabel	40
Verbrauchsgüter	93
Vibrationspumpen	38

**W**

Wasserkreislaufkomponenten	89
Wellendichtungen	83
Werkzeuge	90
Wippenschalter/-taster	7

**Z**

Zeitschalter mechanisch	20
Zulauffilter	89, 89
Zulaufschläuche	86
Zündbrenner	45
Zündgruppen	51
Zündkabel	50