



Spare Parts for Ovens & Combi Ovens



Spare parts suitable for

ÖZTIRYAKILER

2018

Find the complete and up-to-date range of products in our GEV Webshop

energy regulators

EGO

1-circuit



| | | | |
|--------------------|---|-----------------|---------------|
| GEV No. | 380019 | Ref. No. | 6234.00001.11 |
| description | energy regulator 240V 13A single-circuit turn direction right shaft ø 6x4.6mm shaft L 23mm mounting thread M4 power release 6-100% no. 50.57071.010 | | |

thermostats

control and safety thermostats

EGO

control thermostats

55.34_ series



| | | | |
|---|--|-----------------|-------------------|
| GEV No. | 375038 | Ref. No. | 6234.00001.14 |
| description | thermostat t.max. 300°C temperature range 50-300°C 3-pole 3NO 16A probe ø 6mm probe L 79mm capillary pipe 1740mm capillary pipe isolated 800mm gland nut shaft ø 6x4.6mm shaft L 23mm shaft position upper rotation 270° | | |
| accessories for | 375038 | | |
|  | GEV No. | 110123 | Ref. No. — |
| | knob thermostat t.max. 300°C ø 50mm shaft ø 6x4.6mm shaft flat upper black temperature range 50-300°C rotation 270° | | |

safety thermostats

55.32_ series



| | | | |
|--------------------|---|-----------------|---------------|
| GEV No. | 390141 | Ref. No. | 6234.00001.28 |
| description | safety thermostat switch-off temp. 350°C 3-pole 3NC 20A probe ø 6mm probe L 77mm capillary pipe 1490mm capillary pipe isolated 800mm gland nut probe SS | | |

switches and momentary switches

rocker/momentary rocker switches

30x22mm



| | | | |
|---|---|-----------------|-------------------|
| GEV No. | 301003 | Ref. No. | 62320001900 |
| description | rocker switch mounting measurements 30x22mm green 2NO 250V 16A illuminated 0-1 connection male faston 6.3mm ambient temperature max. 125/55°C protection IP65 | | |
| accessories for | 301003 | | |
|  | GEV No. | 301036 | Ref. No. — |
| | protective cover internal size 30x22mm for rocker switch mounting measurementsmm | | |



| | | | |
|--------------------|--|-----------------|------------------------------|
| GEV No. | 301251 | Ref. No. | 6232.00001.21 7AYS0000136 |
| description | rocker switch mounting measurements 30x22mm green 2NO 250V 16A illuminated lighting connection male faston 6.3mm ambient temperature max. 85°C protection IP40 | | |

ø20mm





| | | | |
|--------------------|---|-----------------|--------------------------------|
| GEV No. | 348204 | Ref. No. | 6232.00011.01 6232.00011.27 |
| description | rocker switch mounting measurements 20mm green 1NO 250V 4A 0-1 connection 4.8mm | | |



| | | | |
|--|--|-----------------|--------------------------------|
|  <p>1</p> | | | |
| GEV No. | 348203 | Ref. No. | 6232.00011.00 6232.00011.28 |
| description | rocker switch mounting measurements 20mm orange 1NO 250V 4A 0-1 connection 4.8mm | | |

cam switches

on/off

| | | | |
|--|---|-----------------|-------------------|
|  <p>1</p> | | | |
| GEV No. | 300020 | Ref. No. | 6254.00005.03 |
| description | cam switch 4 operating positions 2NO sequence 0-1-0-1 16A shaft ø 6x4.6mm shaft L 23mm connection screw ceramic | | |
| accessories for | 300020 | | |
|  | GEV No. | 110135 | Ref. No. — |
| | rosette knob up to ø 52mm | | |
|  | GEV No. | 110231 | Ref. No. — |
| | knob switch 0-1-0-1 t.max.°C°C ø 50mm shaft ø 6x4.6mm shaft flat upper black | | |

7-position



| | | | |
|--|---|-----------------|---------------|
|  <p>1</p> | | | |
| GEV No. | 300106 | Ref. No. | 6254.00005.00 |
| description | cam switch 7 operating positions 1NO/2CO sequence 0-1-2-3-4-5-6 32A shaft ø 6x4.6mm shaft L 23mm connection screw 7-position shaft flat upper | | |

operation switches

| | | | |
|---|---|-----------------|---------------|
|  <p>1</p> | | | |
| GEV No. | 300002 | Ref. No. | 6254.00005.04 |
| description | cam switch 2 operating positions 4NO 16A sequence 0-1 shaft ø 6x4.6mm shaft L 23mm connection male faston 6.3mm ceramic | | |

magnetic switches



miscellaneous

| | | | |
|---|--|-----------------|-------------------|
|  <p>1</p> | | | |
| GEV No. | 347961 | Ref. No. | 6232.00005.10 |
| description | magnetic switch 250V 3A P max. 750W 1NO connection cable L 12mm cable length 1000mm L1 37mm mounting measurements 58x13mm H 9mm mounting distance 49.5mm voltage AC nominal 5A | | |
| For models: | OBK1500 | | |
| accessories for | 347961 | | |
|  | GEV No. | 699294 | Ref. No. — |
| | magnet ø 20.8mm H 12.5mm ID ø 5mm with screw | | |

control equipment

MOELLER/EATON

switch blocks

| | | | |
|--|-----------------------------|-----------------|---------------|
|  <p>1</p> | | | |
| GEV No. | 346292 | Ref. No. | 6232.00012.05 |
| description | contact block screw 1NO | | |
|  <p>1</p> | | | |
| GEV No. | 346293 | Ref. No. | 6232.00012.07 |
| description | contact block holder triple | | |



lamps

indicator lights

indicator lights (complete)

ø10mm

with screw socket



1

| | | | |
|--------------------|--|-----------------|---------------|
| GEV No. | 360649 | Ref. No. | 6251.00004.10 |
| description | indicator light ø 10mm green 240V cable length 300mm | | |



oven lamps

universal oven lamps

mounting diameter 35.5mm



1

| | | | | |
|---|--|-----------------|-----------------|---|
| GEV No. | 359718 | Ref. No. | 62600016006 | |
| description | oven lamp mounting ø 35.5mm 230V 15W socket E14 temp.-resist. 300°C connection male faston 6.3mm hard glas | | | |
| spare parts for | 359718 | | | |
|  | GEV No. | 359701 | Ref. No. | — |
| | lamp socket socket E14 220-230V mounting ø 35.5mm connection male faston 6.3mm 15W | | | |
|  | GEV No. | 359740 | Ref. No. | — |
| | light bulb t.max. 300°C socket E14 15W 230V ø 22mm L 48mm lens L 20mm for oven lamp IMPORT 70 1000 | | | |

timers

mechanical timers



1

| | | | |
|--------------------|---|-----------------|---------------|
| GEV No. | 350205 | Ref. No. | 6259.00002.05 |
| description | timer M11 with bell 1-pole operation time 90min impulse mechanical 1NO at 250V 16A permanent position yes shaft ø 6x4.6mm shaft 6x4.6mm shaft L 25mm mounting distance 28mm mounting thread M4 connection male faston 6.3mm | | |
| For models: | OM20G, OM40G, OM60G | | |

contactors

MOELLER/EATON

power contactors



1

| | | | |
|--------------------|--|-----------------|---------------|
| GEV No. | 380171 | Ref. No. | 6230.00014.12 |
| description | power contactor resistive load 20A 230VAC (AC3/400V) 9A/4kW main contacts 3NO auxiliary contacts 1NO connection screw connection type DILEM 10 | | |



relays

plug-in/print relays

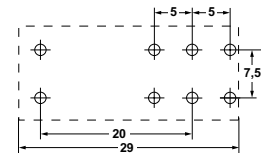

1



| | | | | |
|---|---|-----------------|---|---|
| GEV No. | 380333 | Ref. No. | 6231.00020.02 6231.00023.15 6231.00025.07 | |
| description | print relay 230VAC 2CO at 250V 8A connection pins raster size 5mm FINDER manuf. no. 40.52.8.230.0000 95.65/95.75 | | | |
| For models: | OBK1500 | | | |
| accessories for | 380333 | | | |
|  | GEV No. | 380340 | Ref. No. | — |
| | relay socket dimensions 62x36x15mm 250V voltage AC 10A Italiana Relè manuf. no. ZMEM/5 | | | |
|  | GEV No. | 380505 | Ref. No. | — |
| | relay socket 2CO 40.52 dimensions 81.9x15.5x75mm 250V voltage AC 10A FINDER manuf. no. 95.95.3 | | | |
|  | GEV No. | 381181 | Ref. No. | — |
| | relay socket 2-pole 40.51/40.52/40.61 connection screw clamp dimensions 15.8x78.6mm 250V voltage AC 10A FINDER manuf. no. 95.75 | | | |



solenoid valves

solenoid valves (water)

ELTEK

ELTEK



1

| | | | |
|--------------------|--|-----------------|---------------|
| GEV No. | 370750 | Ref. No. | 6262.00008.00 |
| description | solenoid valve single straight 230VAC inlet 3/4" outlet 11.5mm DN10 t.max. 90°C ELTEK plastic flow regulating valve inlet blue | | |
| For models: | OBK1500 | | |

fans

hot air motors



1

| | | | |
|---|---|-----------------|-------------------|
| GEV No. | 601503 | Ref. No. | 5FIR.35011.12 |
| description | fan wheel D1 ø 350mm H1 125mm blades 12 D2 ø 13mm D3 ø 16mm | | |
| accessories for | 601503 | | |
|  | GEV No. | 500505 | Ref. No. — |
| | fan motor 220-240/380-415V 3 phase 50/60Hz 0.16-0.26kW 1440/1700rpm speeds 2 L1 140mm L2 27mm L3 35mm M10R IT 1.2/0.7A Cos(f) 0.63 type L7zAw4D-014 D1 ø 17mm D2 ø 13mm | | |



gas valves and ignition boxes

gas control valves

HONEYWELL



1

| | | | |
|---|---|-----------------|-------------------|
| GEV No. | 106004 | Ref. No. | 6267.00005.30 |
| description | gas valve type VK4105C 220-240V 50/60Hz gas inlet flange 32x32mm gas outlet flange 32x32mm thermocouple connection pilot connection pressure range 15-60mbar max 60mbar operator type pressure controller type V5306E 1234 1 suitable for HONEYWELL hole distance 24mm flange 32x32mm | | |
| accessories for | 106004 | | |
|  | GEV No. | 102845 | Ref. No. — |
| | gas connection angled 1/2" flange 32x32mm hole distance 24x24mm Tandem | | |
|  | GEV No. | 102846 | Ref. No. — |
| | gas connection straight 1/2" flange 32x32mm hole distance 24x24mm suitable for Tandem | | |

ignition boxes

HONEYWELL

Honeywell



1

| | | | |
|--------------------|---|-----------------|----------------|
| GEV No. | 102343 | Ref. No. | 6259.00020.061 |
| description | ignition box HONEYWELL type S4565A 2019 1 electrodes 2 waiting times safety time 10s 220-240V 4VA 50/60Hz | | |

ignition parts

pilot burners

SIT

100 series



| | | | |
|----------------|--------|-----------------|---------------|
| GEV No. | 106907 | Ref. No. | 6267.00023.07 |
|----------------|--------|-----------------|---------------|

description pilot burner SIT type 100 series 3 flames nozzle \varnothing 0.35mm gas connection 6mm

spare parts for 106907

| | | | |
|----------------|--------|-----------------|---|
| GEV No. | 100246 | Ref. No. | — |
|----------------|--------|-----------------|---|

 pilot burner nozzle natural gas bore \varnothing 0.35mm Qty 1 pcs thread M8x0.75

| | | | |
|----------------|--------|-----------------|---|
| GEV No. | 100855 | Ref. No. | — |
|----------------|--------|-----------------|---|

 pilot burner bracket triple

| | | | |
|----------------|--------|-----------------|---|
| GEV No. | 100885 | Ref. No. | — |
|----------------|--------|-----------------|---|

 air mixing sleeve for pilot burner Qty 1 pcs

| | | | |
|----------------|--------|-----------------|---|
| GEV No. | 100916 | Ref. No. | — |
|----------------|--------|-----------------|---|

 compression spring for pilot burner Qty 1 pcs

| | | | |
|----------------|--------|-----------------|---|
| GEV No. | 100917 | Ref. No. | — |
|----------------|--------|-----------------|---|

 gasket for pilot burner Qty 1 pcs aluminium ID \varnothing 8.5mm ED \varnothing 11mm thickness 1.2mm

| | | | |
|----------------|--------|-----------------|---|
| GEV No. | 100918 | Ref. No. | — |
|----------------|--------|-----------------|---|

 screw for pilot burner

| | | | |
|----------------|--------|-----------------|---|
| GEV No. | 107162 | Ref. No. | — |
|----------------|--------|-----------------|---|

 pilot burner cap SIT 3 flames Hmm Lmm Qty 1 pcs

| | | | |
|----------------|--------|-----------------|---|
| GEV No. | 107702 | Ref. No. | — |
|----------------|--------|-----------------|---|

 pilot burner bottom part SIT 100 series nozzle \varnothing 0.35mm

accessories for 106907

| | | | |
|----------------|--------|-----------------|---|
| GEV No. | 100245 | Ref. No. | — |
|----------------|--------|-----------------|---|

 pilot burner nozzle LPG code 20 bore \varnothing 0.2mm Qty 1 pcs thread M8x0.75

| | | | |
|----------------|--------|-----------------|---|
| GEV No. | 100904 | Ref. No. | — |
|----------------|--------|-----------------|---|

 locking screw M10x1 for pipe \varnothing 4mm Qty 1 pcs

| | | | |
|----------------|--------|-----------------|---|
| GEV No. | 100905 | Ref. No. | — |
|----------------|--------|-----------------|---|

 locking screw M10x1 for pipe \varnothing 6mm Qty 1 pcs

| | | | |
|----------------|--------|-----------------|---|
| GEV No. | 102110 | Ref. No. | — |
|----------------|--------|-----------------|---|



 pilot tube copper pipe \varnothing 4mm thickness 1mm L 3000mm

| | | | |
|----------------|--------|-----------------|---|
| GEV No. | 102111 | Ref. No. | — |
|----------------|--------|-----------------|---|

 pilot tube copper pipe \varnothing 6mm thickness 1mm L 3000mm

| | | | |
|----------------|--------|-----------------|---|
| GEV No. | 107171 | Ref. No. | — |
|----------------|--------|-----------------|---|

 pilot burner nozzle SIT natural/liquid gas bore \varnothing 0.25mm Qty 1 pcs

| | | | | |
|---|---|--------|-----------------|---|
| accessories for | 106907 | | | |
|  | GEV No. | 107700 | Ref. No. | — |
| | pilot burner bottom part SIT 100 series nozzle \varnothing 0.25mm | | | |
|  | GEV No. | 107701 | Ref. No. | — |
| | pilot burner bottom part SIT 100 series nozzle \varnothing 0.2mm | | | |

ignition cables

pre-assembled cables



| | | | |
|----------------|--------|-----------------|---------------|
| GEV No. | 100140 | Ref. No. | 6267.00031.01 |
|----------------|--------|-----------------|---------------|

description ignition cable cable length 400mm connection \varnothing 2.4mm / \varnothing 4mm



| | | | |
|----------------|--------|-----------------|---------------|
| GEV No. | 100019 | Ref. No. | 6267.00031.05 |
|----------------|--------|-----------------|---------------|

description ignition cable cable length 900mm connection \varnothing 2.4mm / \varnothing 4mm

thermocouples

plug-in thermocouples

plug-in thermocouples standard

with barrel socket \varnothing 6(6.5)mm

thermocouples SIT

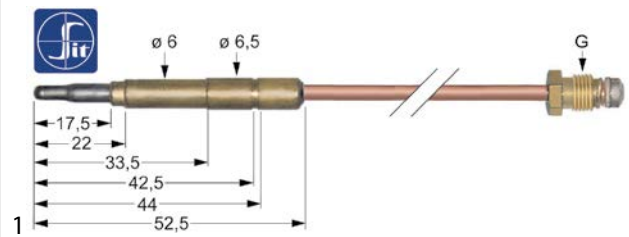

| | | | |
|----------------|--------|-----------------|---------------|
| GEV No. | 107604 | Ref. No. | 6267.00024.04 |
|----------------|--------|-----------------|---------------|

description thermocouple SIT M8x1 L 1200mm plug connection \varnothing 6.0(6.5)mm

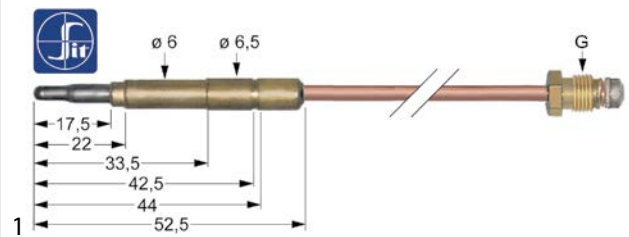

| | | | |
|----------------|--------|-----------------|-------------------------------|
| GEV No. | 107613 | Ref. No. | 6267.00024.07 T1005191200E |
|----------------|--------|-----------------|-------------------------------|

description thermocouple SIT M9x1 L 1200mm plug connection \varnothing 6.0(6.5)mm

gas components



gaskets

O-rings

EPDM

ø2.62mm

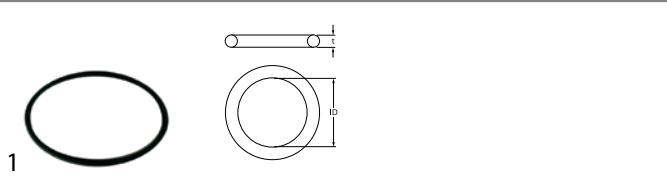

| | | | |
|--------------------|--|-----------------|---------------|
| GEV No. | 540222 | Ref. No. | 6228.00059.60 |
| description | O-ring EPDM thickness 2.62mm ID ø 47.3mm Qty 1 pcs | | |

ø5.34mm

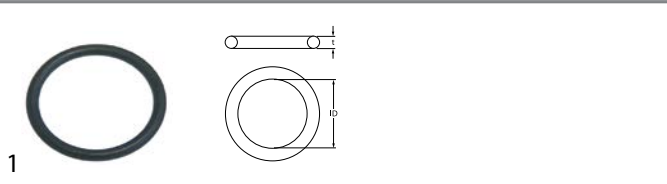

| | | | |
|--------------------|--|-----------------|--------------------------------|
| GEV No. | 510408 | Ref. No. | 6228.00001.22 6228.00001.26 |
| description | O-ring EPDM thickness 5.34mm ID ø 47mm Qty 1 pcs | | |

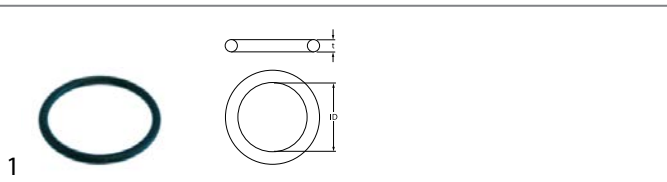

| | | | |
|--------------------|---|-----------------|---------------|
| GEV No. | 510409 | Ref. No. | 6228.00002.14 |
| description | O-ring EPDM thickness 5.34mm ID ø 56.52mm Qty 1 pcs | | |

transmission technology and ball bearings

ball bearings

deep-groove ball bearings 2RS

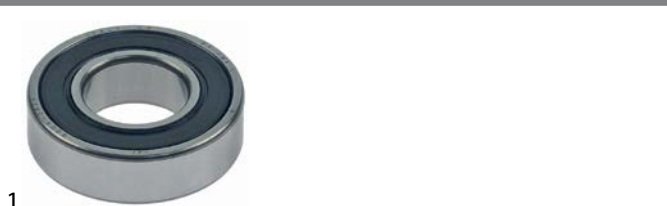



| | | | |
|--------------------|--|-----------------|---------------|
| GEV No. | 523522 | Ref. No. | 6211.00210.01 |
| description | deep-groove ball bearing type 6004-2RS shaft ø 20mm ED ø 42mm W 12mm with sealing discs deep-groove ball bearing DIN 625-1 | | |
| For models: | OM10G | | |

hoses

supply hoses

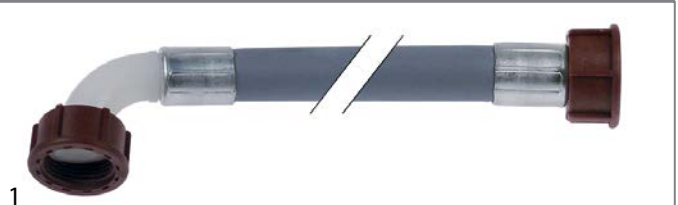
PVC supply hoses



| | | | | |
|---|--|-----------------|-----------------|---|
| GEV No. | 520010 | Ref. No. | 6262.00021.12 | |
| description | supply hose PVC straight-curved DN13 connections 3/4" L 1500mm operating p. 10bar burst p. 32bar t.max. 90°C blue approval VDE flat seal | | | |
| For models: | OBK1500 | | | |
| accessories for | 520010 | | | |
|  | GEV No. | 520053 | Ref. No. | — |
| | screen connection 3/4" D1 ø 26mm D2 ø 15mm Qty 10 pcs rubber thickness 8mm | | | |
|  | GEV No. | 520054 | Ref. No. | — |
| | flat gasket rubber ED ø 23.5mm ID ø 14mm thickness 2.3mm Qty 10 pcs | | | |

fastening material

screws

hexagonal screws



| | | | |
|--------------------|---|-----------------|---------------|
| GEV No. | 550682 | Ref. No. | 6262.00003.10 |
| description | hexagonal screw thread M8 thread L 20mm SS WS 13 Qty 1 pcs DIN 933 / ISO 4017 | | |

nuts

hexagonal nuts

DIN 985



| | | | |
|--------------------|--|-----------------|---------------|
| GEV No. | 560143 | Ref. No. | 6214.00013.15 |
| description | hexagonal nut thread M8 H 8.5mm SS WS 13 Qty 20 pcs DIN/ISO DIN 985 self-locking | | |

washers

washers

miscellaneous



1

| | | | |
|--------------------|--|-----------------|---------------|
| GEV No. | 506160 | Ref. No. | 6215.00001.03 |
| description | plain washer ID ø 8.6mm ED ø 16mm thickness 1.5mm SS Qty 1 pcs | | |

C

| | |
|---------------------|---|
| cam switches | 3 |
| contactors | 4 |
| control equipment | 3 |
| control thermostats | 2 |

E

| | |
|-------------------|---|
| energy regulators | 2 |
|-------------------|---|

F

| | |
|--------------------|---|
| fans | 5 |
| fastening material | 7 |

G

| | |
|--------------------|---|
| gas control valves | 5 |
| GEV | 2 |

H

| | |
|------------------|---|
| hexagonal nuts | 7 |
| hexagonal screws | 7 |
| hoses | 7 |
| hot air motors | 5 |

I

| | |
|-----------------------------|---|
| ignition boxes | 5 |
| ignition cables | 6 |
| indicator lights | 4 |
| indicator lights (complete) | 4 |

L

| | |
|-------|---|
| lamps | 4 |
|-------|---|

M

| | |
|-------------------|---|
| magnetic switches | 3 |
| mechanical timers | 4 |

N

| | |
|------|---|
| nuts | 7 |
|------|---|

O

| | |
|------------|---|
| O-rings | 7 |
| oven lamps | 4 |

P

| | |
|------------------|---|
| pilot burners | 6 |
| PVC supply hoses | 7 |

R

| | |
|----------------------------------|---|
| relays | 4 |
| rocker/momentary rocker switches | 2 |

S

| | |
|---------------------------------|---|
| safety thermostats | 2 |
| screws | 7 |
| solenoid valves | 5 |
| supply hoses | 7 |
| switches and momentary switches | 2 |

T

| | |
|---------------|---|
| thermocouples | 6 |
| thermostats | 2 |
| timers | 4 |

W

| | |
|---------|---|
| washers | 8 |
|---------|---|