



Spare Parts for Ovens & Combi Ovens



Spare parts suitable for

PRIMAX

2018

Find the complete and up-to-date range of products in our GEV Webshop



heating elements

heating elements for convection



1

GEV No.	417555	Ref. No.	4663091
description	heating element 9000W 230V heating circuits 3 ID ϕ 240mm ED ϕ 257mm L 300mm H 100mm L1 38mm W1 104mm H1 8.5mm H2 85mm flange length 142mm flange width 25mm hole distance 126mm connection Faston 6.3mm connection length 85mm tube ϕ 8.5mm convection heating element hole ϕ 6.2mm rectangular flange INCOLOY-800		

energy regulators

ROBERTSHAW

MSA series



1

GEV No.	380858	Ref. No.	4620700
description	energy regulator ROBERTSHAW 240V 15A turn direction right shaft ϕ 6x4.6mm shaft L 23mm mounting thread 8"-32UNC		

thermostats

control and safety thermostats

EGO

control thermostats

55.10/19_ series



1

GEV No.	390068	Ref. No.	4620600
description	thermostat t.max. 269°C temperature range 55-269°C 1-pole 1CO 16A probe ϕ 3.1mm probe L 219mm capillary pipe 1280mm capillary pipe isolated 1270mm gland nut shaft ϕ 6x4.6mm shaft L 23mm shaft position upper ^o rotation 318°		

safety thermostats

55.32_ series



1

GEV No.	375228	Ref. No.	4620530
description	safety thermostat switch-off temp. 350°C 3-pole 20A probe ϕ 3mm probe L 188mm capillary pipe 900mm capillary pipe isolated 900mm gland nut probe SS		

CAEM

safety thermostats



1

GEV No.	376072	Ref. No.	4620510
description	safety thermostat switch-off temp. 320°C 1-pole 16A probe ϕ 3mm probe L 160mm capillary pipe 900mm capillary pipe isolatedmm gland nut 250V		

switches and momentary switches

microswitches

pin-plunger actuated



M10



1

GEV No.	347288	Ref. No.	4611020	
description	microswitch with plunger thread M10x0.75 thread L 10mm 250V 16A 1NO connection male faston 6.3mm stroke 6mm mounting distance 22mm ambient temperature max. 125°C type VRSRB1AA1 actuating force: 160g			
accessories for	347288			
	GEV No.	100779	Ref. No.	—
	nut thread M10x0.75 H 3mm WS 14 SS Qty 2 pcs			



			
GEV No.	346369	Ref. No.	4611050
description	microswitch with plunger thread M10x0.75 thread L 27mm 250V 16A 1CO connection male faston 6.3mm stroke 14mm mounting distance 22mm L 43mm L1 15mm L2 42mm ambient temperature max. 125°C type VRSRE1DA1 actuating force: 150g		
accessories for	346369		
	GEV No.	Ref. No.	—
	 nut thread M10x0.75 H 3mm WS 14 SS Qty 2 pcs		

			
GEV No.	359705	Ref. No.	4640020 7750040 7750041
description	oven lamp glass thr.ø 33.5mm ø 52mm hard glas temp.-resist. 350°C		
accessories for	359705		
	GEV No.	Ref. No.	—
	 PHILIPS light bulb t.max. 300°C socket E14 15W 230V ø 22mm L 47mm lens L 20mm for oven lamp type Philips		
	GEV No.	Ref. No.	—
	 gasket for pizza oven fibre glass ID ø 32.5mm ED ø 55mm thickness 5mm		
	GEV No.	Ref. No.	—
	 gasket silicone ED ø 48mm ID ø 39.5mm thickness 5mm Qty 1 pcs		
	GEV No.	Ref. No.	—
	 gasket ID ø 33mm ED ø 46mm thickness 1mm graphite		
	GEV No.	Ref. No.	—
	 gasket ID ø 33mm ED ø 45mm		

magnetic switches

M10x0.75			
			
GEV No.	348190	Ref. No.	4611010
description	magnetic switch thread M10x0.75 1NO 100 DC/150 ACV 0.5A P max. 10W connection 2-wire cable length 1200mm		

lamps

screw-on/push-on fit





halogen lamp			
for socket G4 / G6.35 / G9			
			
GEV No.	357196	Ref. No.	4640030
description	halogen lamp socket G9 230V 40W temp.-resist. 300°C OSRAM HALOPIN OVEN		

oven lamps



universal oven lamps

mounting diameter 35.5mm			
			
GEV No.	357160	Ref. No.	4640010
description	lamp socket socket G9 220-230V mounting ø 35.5mm connection cable 100mm		

55x70mm





			
GEV No.	357105	Ref. No.	4640070
description	lamp socket socket G9 250V mounting measurements 55x70mm connection male faston 6.3mm H 32mm		
accessories for	357105		
	GEV No.	Ref. No.	4640080
	 frame L 95mm W 81mm mounting distance 68/83mm thickness 6mm		
	GEV No.	Ref. No.	3531320
	 gasket L 91mm W 77mm hole ø 3mm for oven lamp		
	GEV No.	Ref. No.	—
	 lamp glass L 80mm W 65mm mounting measurements 52x67mm		
	GEV No.	Ref. No.	—
	 halogen lamp socket G9 230V 25W temp.-resist. 300°C 200 2000		



			
1			
GEV No.	359297	Ref. No.	4640080
description	frame L 95mm W 81mm mounting distance 68/83mm thickness 6mm		
accessories for	359297		
	GEV No.	Ref. No.	3531320
	 gasket L 91mm W 77mm hole ø 3mm for oven lamp		

			
1			
GEV No.	359299	Ref. No.	3531320
description	gasket L 91mm W 77mm hole ø 3mm for oven lamp		

			
1			
GEV No.	359296	Ref. No.	4640090
description	lamp glass L 74mm W 58mm thickness 3mm		

			
1			
GEV No.	357105	Ref. No.	4640070
description	lamp socket socket G9 250V mounting measurements 55x70mm connection male faston 6.3mm H 32mm		
accessories for	357105		
	GEV No.	Ref. No.	4640080
	 frame L 95mm W 81mm mounting distance 68/83mm thickness 6mm		
	GEV No.	Ref. No.	3531320
	 gasket L 91mm W 77mm hole ø 3mm for oven lamp		
	GEV No.	Ref. No.	—
	 lamp glass L 80mm W 65mm mounting measurements 52x67mm		
	GEV No.	Ref. No.	—
	 halogen lamp socket G9 230V 25W temp.-resist. 300°C 200 2000		

lamps			
halogen lamps			
for socket G4 / G6.35 / G9			
			
1			
GEV No.	357196	Ref. No.	4640030
description	halogen lamp socket G9 230V 40W temp.-resist. 300°C OSRAM HALOPIN OVEN		

timers

electric timers			
with time spread			
			
1			
GEV No.	350154	Ref. No.	4620650
description	timer MS65 with bell operation time 120min time spread 30min 2CO/1NO at 250V 16A permanent position yes impulse electric shaft ø 6x4.6mm shaft L 20mm connection lateral Invensys 230V 3-pole		

contactors

LOVATO			
power contactors			
			
1			
GEV No.	380720	Ref. No.	4581110
description	power contactor resistive load 32A 230VAC (AC3/400V) 25A/12.5kW main contacts 3NO auxiliary contacts 1NO connection screw connection type BF2510A230		



ALLEN BRADLEY

power contactors



1

GEV No.	381121	Ref. No.	4581070
description	power contactor resistive load 32A 230VAC (AC3/400V) 16A/7.5kW main contacts 3NO auxiliary contacts 1NO connection screw connection type 100-C16KF10		

relays

power relays

with bracket mounting



1

GEV No.	380812	Ref. No.	4582040
description	power relays FINDER 230VAC 30A 2CO connection F6.3 bracket mounting manuf. no. 66.82.8.230.0000		



1

GEV No.	380687	Ref. No.	4582030 4582110
description	power relays FINDER 230VAC 30A 2NO connection F6.3 bracket mounting manuf. no. 66.82.8.230.0300		

solenoid valves



solenoid valves (water)

RPE

JOHN GUEST



1

GEV No.	370772	Ref. No.	7711520	
description	solenoid valve double straight 230VAC inlet 3/4" outlet JG 8 DN10 t.max. 60°C duty cycle 100% RPE			
accessories for	370772			
	GEV No.	371265	Ref. No.	—
	reducer flow rate 3l/min black			
	GEV No.	371269	Ref. No.	—
	reducer flow rate 0.07-0.14l/min brown			



1

GEV No.	374069	Ref. No.	7711120
description	solenoid valve single straight 230VAC inlet JG 8 outlet JG 8 input/min output/min DN8 t.max. 25/60/90°C duty cycle 100% RPE 160001230V plastic		

solenoid valves with reducers

single



1

GEV No.	374078	Ref. No.	7711110
description	solenoid valve 230VAC inlet JG 8 outlet JG 8 t.max. 60°C RPE flow regulating valve outlet brown output A 0.07-0.14l/min		



1

GEV No.	374009	Ref. No.	7711510
description	solenoid valve single straight 220-240VAC inlet 3/4" outlet JG 8 input 10-12l/min t.max. 60°C duty cycle 100% RPE plastic flow regulating valve inlet white 1-ways medium temp max. 25°C		





fans

axial fans

import





1	GEV No.	601080 ¹	Ref. No.	4650010
description axial fan L 119mm W 119mm H 38mm 230VAC 50/60Hz 23/20W bearing ball bearing connection male faston 2.8mm metal ADDA fan wheel ø 110mm temp.-resist. 70°C				
accessories for 601080				
	GEV No.	550898	Ref. No.	—
connecting cable cable length 2000mm connection F 2.8 connection distance 7.9mm for axial flow fan				
	GEV No.	692519	Ref. No.	—
guard L 120mm W 120mm plastic				

¹with ball bearings

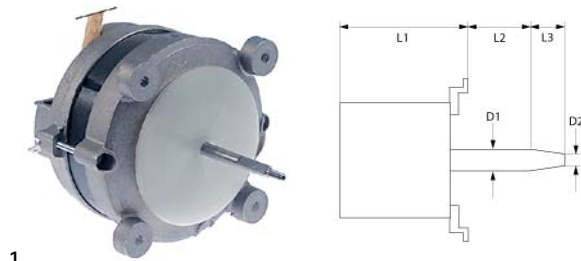
hot air motors



1	GEV No.	601362	Ref. No.	4651030
description				
accessories for 601362				
	GEV No.	365017	Ref. No.	—
operating capacitor capacity 5µF 450V tolerance 5% 50/60Hz ambient temperature max. -25 to +85°C ø 28mm L 54mm M8 plastic connection male faston 6.3mm 16.10.08 protection				
	GEV No.	694600	Ref. No.	—
bush for hot air motors ø 25mm H 10mm seat ø 8.5mm				
	GEV No.	694601	Ref. No.	—
spring for hot air motors ø 22mm H 18mm ID ø 19mm				



1	GEV No.	601778	Ref. No.	4651540
description fan wheel D1 ø 197mm H1 43mm blades 45 D2 ø 8mm D3 ø 8x6.8mm H2 14mm H3 1.5mm				

ignition parts

pilot burners

SIT

100 series

accessories

pilot burner bottom parts



1	GEV No.	107770	Ref. No.	36430130 C36430130
description pilot burner bottom part SIT 100 series nozzle ø 0.3mm gas connection 4mm Qty 1 pcs				

producer-specific pilot burners

PRIMAX



1	GEV No.	107771	Ref. No.	31140080 C31140080
description cover for pilot burner				



1	GEV No.	107770	Ref. No.	36430130 C36430130
description pilot burner bottom part SIT 100 series nozzle ø 0.3mm gas connection 4mm Qty 1 pcs				



thermocouples

plug-in thermocouples

plug-in thermocouples standard

with barrel socket $\varnothing 6(6.5)$ mm

thermocouples SIT

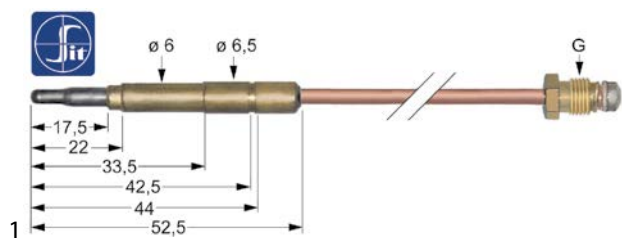

GEV No.	107769 ¹	Ref. No.	36430050 C36430050
description	thermocouple SIT aluminized tip M9x1 L 400mm plug connection $\varnothing 6.0(6.5)$ mm		

¹aluminized tip

locks

handle latches

universal

inside fixing

locks



GEV No.	694234	Ref. No.	3310040	
description	door handle for headed units L 145mm W 40mm H 62mm spring length 40mm inner black			
spare parts for	694234			
	GEV No.	514450	Ref. No.	—
	spring for door handle $\varnothing 6$ mm L 61mm W 27.5mm			
	GEV No.	694734	Ref. No.	—
	door handle L 165mm W 40mm H 25mm black			
	GEV No.	694735	Ref. No.	—
	cap $\varnothing 32$ mm black			

	GEV No.	694882	Ref. No.	3310010 3310011 3310020
	description	door handle L 165mm W 40mm H 62mm inner black		
	accessories for	694882		
	GEV No.	694881	Ref. No.	3310030
	door catch total length 40mm M8 thread L 23mm W 26mm			

gaskets

gaskets for heated units

door seals

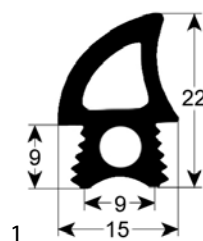

GEV No.	901997	Ref. No.	3530100
description	door seal profile 2767 L 2200mm		

hoses

industrial hoses

PE hoses

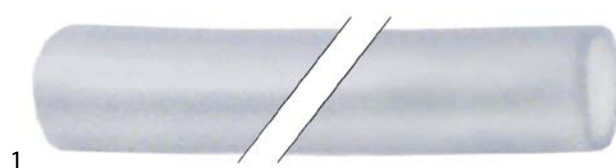

GEV No.	520549 ¹	Ref. No.	2811080
description	hose Lm operating p. 6bar burst p. 10bar t.max. 65°C LLDPE transparent ID $\varnothing 6$ mm ED $\varnothing 8$ mm John Guest supplied by meter		

¹by the meter

gas components

A

axial fans 6

C

contactors 4

control thermostats 2

D

door seals 7

E

electric timers 4

energy regulators 2

F

fans 6

G

gaskets for heated units 7

GEV 2

H

halogen lamp 3

heating elements 2

heating elements for convection 2

hoses 7

hot air motors 6

I

industrial hoses 7

L

lamps 3

M

magnetic switches 3

microswitches 2

O

oven lamps 3

P

PE hoses 7

pilot burners 6

R

relays 5

S

safety thermostats 2

solenoid valves 5

switches and momentary switches 2

T

thermocouples 7

thermostats 2

timers 4