



Spare Parts for Ovens & Combi Ovens



Spare parts suitable for

ELECTROLUX

2018

Find the complete and up-to-date range of products in our GEV Webshop



heating elements

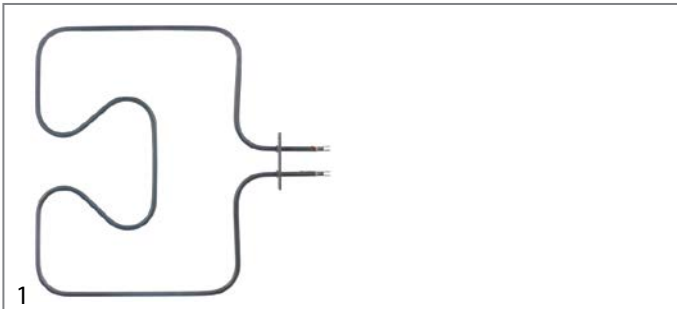

heating elements for ovens



| | | | |
|--------------------|--|-----------------|--------|
| GEV No. | 418078 | Ref. No. | 005218 |
| description | heating element 1000W 230V heating circuits 1 L 335mm W 345mm L1 55mm L2 280mm W1 154mm W2 36mm flange length 80mm flange width 16mm hole distance 60mm hole ø 5mm tube ø 6.3mm connection male faston 6.3mm connection length 60mm rectangular flange dry heating element | | |
| For models: | FCF/E4, FCF/E4-3KW, JCF/E4, JCF/E4, ECF/E4, ECF/E4-3KW, ACF/E4, ACF/E4-3KW, NCF/E4, ZCF/E4, ZCF/E4 | | |



| | | | |
|--------------------|---|-----------------|--------|
| GEV No. | 418081 | Ref. No. | 054326 |
| description | heating element 2000W 230V L 314mm W 290mm L1 11mm L2 213mm W1 126mm W2 33mm connection plug-in connection heating circuits 1 tube ø 6.5mm plug-in connection dry heating element | | |
| For models: | FCF/E4-OLD, FCF/E4D, FCFE4PH, FCF/E4OLD3, FCF/E4OLD4, FCF/E4OLD2, FCF/E4OLD1, FCF/E4D | | |

| | | | | |
|---|---|--------|-----------------|---|
| accessories for | 418081 | | | |
|  | GEV No. | 550404 | Ref. No. | — |
| | power socket I-II phase 240V max. 16A countries I with screw connection for heating element | | | |
|  | GEV No. | 550405 | Ref. No. | — |
| | power socket male faston 6.3mm for heating element 2-pole + earthing | | | |

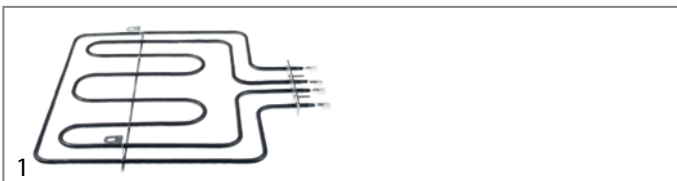

| | | | |
|--------------------|---|-----------------|--------|
| GEV No. | 418082 | Ref. No. | 005205 |
| description | heating element 2550W 230V heating circuits 2 L 333mm W 347mm L1 48mm L2 285mm W1 120mm W2 107mm flange length 120mm flange width 25mm bridge length 368mm hole ø M4mm tube ø 6.3mm connection male faston 6.3mm rectangular flange dry heating element hot air | | |
| For models: | FCF/E4, FCF/E4-3KW, JCF/E4, JCF/E4, ECF/E4, ECF/E4-3KW, ACF/E4, ACF/E4-3KW, NCF/E4, ZCF/E4, ZCF/E4 | | |

pilot heating elements



| | | | |
|--------------------|--|-----------------|----------------------------|
| GEV No. | 415460 | Ref. No. | OH6199 OK0550 OKC471 |
| description | heating element 1000W 230V heating circuits 1 flange 70x18mm L 230mm W 65mm connection male faston 6.3mm tube ø 8.5mm immersion heater expansion flange connection length 20mm silicone TD ø 8mm | | |
| For models: | 7573-3/85.KES100.(N), 7574-3/85.KES150.(N), 7575-3/85.KES250.(N), 7576-3/85.KES300.(N), 7573-3/90.KES100.(N), 7574-3/90.KES150.(N), 7575-3/90.KES250.(N), 7576-3/90.KES300.(N), 7573-3, 7574-3, 7575-3, 7576-3, 7577-3, 7773-3, 7773-3/85.KES100, 7773-3/90.KES100, 7774-3, 7774-3/85.KES150, 7774-3/90.KES150, 7775-3, 7775-3/85.KES250, 7775-3/90.KES250, 7776-3, 7776-3/85.KES300, 7776-3/90.KES300, 9100-3, 9104-3, 9113-3, 9190-3, 9191-3, 9193-3, 9195-3, 9300-3-0, 9300-3-8, 9304-3-0, 9304-3-8, 9313-3-0, 9313-3-8, 9390-3, 9391-3, 9393-3, 9395-3 | | |

| | | | | |
|---|---|--------|-----------------|------------------|
| accessories for | 415460 | | | |
|  | GEV No. | 375044 | Ref. No. | OH6141 OKE595 |
| | safety thermostat switch-off temp. 178°C 1-pole 16A probe ø 4mm probe L 91mm capillary pipe 1730mm capillary pipe isolated 1600mm gland nut probe with sealing sleeve screw connection M8x1 sealing sleeve 8.6x32mm | | | |

immersion heating elements

3 hole flange ø47.5mm

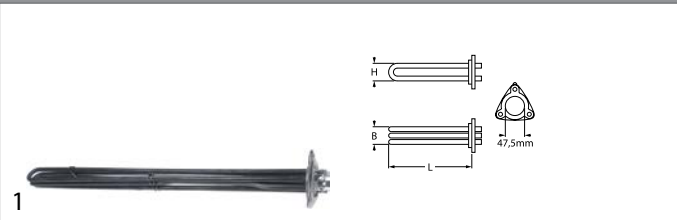

| | | | |
|--------------------|---|-----------------|------------------|
| GEV No. | 419082 | Ref. No. | OF0051 OK8362 |
| description | heating element 13000W 230V mounting ø 47.5mm heating circuits 3 L 585mm W 30mm H 40mm number of thermostat sleeves 1 thermostat sleeves ø 5mm length thermostat sleeves 225mm thermostat sleeve centred, adjacent tube ø 8.5mm hole distance 62.5mm hole ø 6.5mm connection length 17mm connection M5 3 hole flange immersion heater | | |
| For models: | CS20ME4/200-3, CS20ME4/230-3, CS20ME6/230-3, CS20ME4/400-3N, CS20ME6/400-3N, CS20ME4/400-3NE, CS20ME4/400-3, CS-20ME4/440-3, CS20MT4/400-3N, CS20MT6/400-3N, CS20GE4/200-3, CS20GE4/230-3, CS20GE6/230-3, CS20GE4/400-3N, CS20GE6/400-3N, CS20GE4/400-3NE, CS20GE4/400-3, CS20GE4/440-3, CS-20GT4/400-3N, CS20GT6/400-3N, CS20LCE4/200-3, CS20LCE4/230-3, CS20LCE6/230-3, CS20LCE4/400-3N, CS20LCE6/400-3N, CS20LCE4/400-3N, CS20LCE4/400-3, CS20LCE4/440-3, CS20LCT4/400-3N, CS20LCT6/400-3N | | |

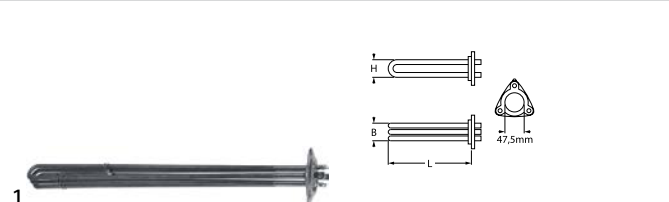
| | | | |
|------------------------|--|-----------------|---|
| GEV No. | 419083 | Ref. No. | 058214 058672 |
| description | heating element 17000W 220V mounting \varnothing 47.5mm heating circuits 3 L 590mm W 35mm H 40mm tube \varnothing 8.5mm hole distance 62.5mm hole \varnothing 6.5mm connection M5 3 hole flange immersion heater | | |
| For models: | FCVE10-2, FCVE10-4, FCVE103CE, FCVE10-2UK, FCVE10-4UK, ZOFCV/E102, ZOFCV/E104 | | |
| accessories for | 419083 | | |
| | GEV No. | 510408 | Ref. No. |
| | | | 046213 055533 065710 067620 0G0216 0G1615 0H2559 0K2935 0K5546 0K8688 0L2765 718042198 |
| | O-ring EPDM thickness 5.34mm ID \varnothing 47mm Qty 1 pcs | | |

accessories for 415063

| | | | |
|----------------|--|-----------------|---|
| GEV No. | 510562 | Ref. No. | — |
| | O-ring silicone thickness 5.34mm ID \varnothing 47mm Qty 1 pcs | | |

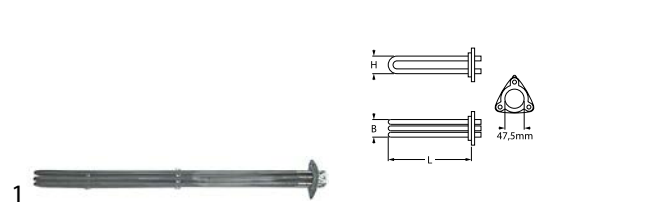

| | | | |
|------------------------|---|-----------------|---|
| GEV No. | 415063 | Ref. No. | 058995 0C5336 0H2521 0K8360 0KF066 |
| description | heating element 17000W 230V mounting \varnothing 47.5mm heating circuits 3 L 590mm W 29mm H 38mm number of thermostat sleeves 1 thermostat sleeves \varnothing 4mm length thermostat sleeves 225mm thermostat sleeve centre tube \varnothing 8.5mm hole distance 63mm hole \varnothing 10mm connection M5 3 hole flange immersion heater | | |
| For models: | FCV/E10L3, FCV/E10L6, FVC/E101/1, FCS101E4, FCS101EP, FCS101EXLN, FCS101EX, FCVE10-P, FCVE10PUK, CS10ME4/200-3, CS10ME4/230-3, CS10ME6/230-3, CS10ME4/400-3N, CS10ME6/400-3N, CS10ME4/400-3N/EO, CS10ME4/400-3/50HZ/M, CS10ME4/440-3/60HZ/M, CS10MT4/400-3N, CS10MT6/400-3N, CS10GE4/200-3, CS10GE4/230-3, CS10GE6/230-3, CS10GE4/400-3N, CS10GE6/400-3N, CS10GE4/400-3N/EO, CS10GE4/400-3/50HZ/M, CS10GE4/440-3/60HZ/M, CS10GT4/400-3N, CS10GT6/400-3N, CS10LCE4/200-3, CS10LCE4/230-3, CS10LCE6/230-3, CS10LCE4/400-3N, CS10LCE6/400-3N, CS10LCE4/400-3N/EO, CS10LCE4/400-3/50HZ/, CS10LCE4/440-3/60HZ/, CS10LCT4/400-3N, CS10LCT6/400-3N, CS20ME4/200-3, CS20ME4/230-3, CS20ME6/230-3, CS20ME4/400-3N, CS20ME6/400-3N, CS20ME4/400-3NE, CS20ME4/400-3, CS20ME4/440-3, CS20MT4/400-3N, CS20MT6/400-3N, CS20GE4/200-3... | | |
| accessories for | 415063 | | |
| | GEV No. | 510408 | Ref. No. |
| | | | 046213 055533 065710 067620 0G0216 0G1615 0H2559 0K2935 0K5546 0K8688 0L2765 718042198 |
| | O-ring EPDM thickness 5.34mm ID \varnothing 47mm Qty 1 pcs | | |

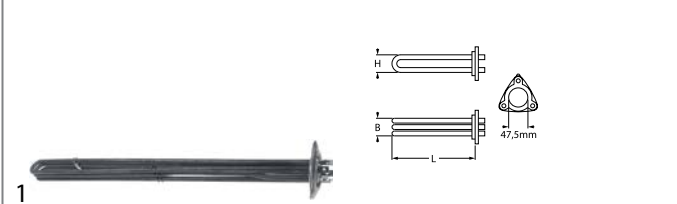

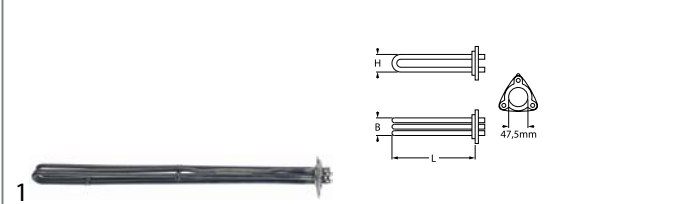

| | | | |
|--------------------|--|-----------------|--------|
| GEV No. | 419084 | Ref. No. | 059003 |
| description | heating element 17000W 240V mounting \varnothing 47.5mm heating circuits 3 L 590mm W 32mm H 40mm number of thermostat sleeves 1 thermostat sleeves \varnothing 5mm length thermostat sleeves 225mm thermostat sleeve centred, adjacent tube \varnothing 8.5mm hole distance 62.5mm hole \varnothing 6.5mm connection M5 3 hole flange immersion heater | | |
| For models: | FCVE10-P, FCVE10PUK | | |

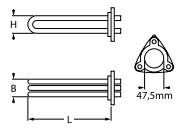

| | | | |
|--------------------|---|-----------------|------------------|
| GEV No. | 417730 | Ref. No. | 0F0095 0K8363 |
| description | heating element 17000W 254V heating circuits 3 L 585mm W 34mm H 36mm number of thermostat sleeves 1 length thermostat sleeves 225mm tube \varnothing 8.5mm hole distance 62mm hole \varnothing 6.5mm for combi-steamer | | |
| For models: | CS10ME4/200-3, CS10ME4/230-3, CS10ME6/230-3, CS10ME4/400-3N, CS10ME6/400-3N, CS10ME4/400-3N/EO, CS10ME4/400-3/50HZ/M, CS10ME4/440-3/60HZ/M, CS10MT4/400-3N, CS10MT6/400-3N, CS10GE4/200-3, CS10GE4/230-3, CS10GE6/230-3, CS10GE4/400-3N, CS10GE6/400-3N, CS10GE4/400-3N/EO, CS10GE4/400-3/50HZ/M, CS10GE4/440-3/60HZ/M, CS10GT4/400-3N, CS10GT6/400-3N, CS10LCE4/200-3, CS10LCE4/230-3, CS10LCE6/230-3, CS10LCE4/400-3N, CS10LCE6/400-3N, CS10LCE4/400-3N/EO, CS10LCE4/400-3/50HZ/, CS10LCE4/440-3/60HZ/, CS10LCT4/400-3N, CS10LCT6/400-3N, CS20ME4/200-3, CS20ME4/230-3, CS20ME6/230-3, CS20ME4/400-3N, CS20ME6/400-3N, CS20ME4/400-3NE, CS20ME4/400-3, CS20ME4/440-3, CS20MT4/400-3N, CS20MT6/400-3N, CS20GE4/200-3, CS20GE4/230-3, CS20GE6/230-3, CS20GE4/400-3N, CS20GE6/400-3N, CS20GE4/400-3NE, CS20GE4/400-3, CS20GT4/400-3N, CS20GT6/400-3N...(Other models you can see in the webshop) | | |

| | | | |
|---|---|-----------------|---|
| GEV No. | 415394 | Ref. No. | 058666 |
| description | heating element 7900W 230V mounting \varnothing 47.5mm heating circuits 3 L 287mm W 33mm H 35mm tube \varnothing 8.5mm hole distance 63mm hole \varnothing 8mm connection M5 3 hole flange immersion heater | | |
| For models: | XFV/E700, FCVE6-1U, FCVE6-3U, FCVE6-1, FCVE6-3, FCVE6-3CE, FCVE6-1UK, FCVE6-3UK, FCVM62E, FCVM62EUK, FCV/E6-1, FCV/E6-1 | | |
| accessories for | 415394 | | |
| | | | 046213 055533 065710 067620 0G0216 0G1615 0H2559 0K2935 0K5546 0K8688 0L2765 718042198 |
| | GEV No. | 510408 | Ref. No. |
|  | O-ring EPDM thickness 5.34mm ID \varnothing 47mm Qty 1 pcs | | |
| | GEV No. | 510562 | Ref. No. |
|  | O-ring silicone thickness 5.34mm ID \varnothing 47mm Qty 1 pcs | | |



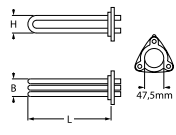



| | | | |
|--------------------|---|-----------------|--------|
| GEV No. | 419092 | Ref. No. | 0F0011 |
| description | heating element 9600W 230V mounting \varnothing 47.5mm heating circuits 3 L 585mm W 40mm H 40mm number of thermostat sleeves 1 thermostat sleeves \varnothing 5mm length thermostat sleeves 222mm thermostat sleeve centred, adjacent tube \varnothing 8.5mm hole distance 62.5mm hole \varnothing 6.5mm connection length 18mm connection M5 3 hole flange immersion heater | | |
| For models: | CS7ME4/200-3, CS7ME4/230-3, CS7ME4/400-3N, CS7ME6/400-3N, CS7ME4/400-3N/EO, CS7ME4/400-3/50HZ/MA, CS7ME4/440-3/60HZ/MA, CS7MT4/400-3N, CS7GE4/200-3, CS7GE4/230-3, CS7GE4/400-3N, CS7GE6/400-3N, CS7GE4/400-3N/EO, CS7GE4/400-3/50HZ/MA, CS7GE4/440-3/60HZ/MA, CS7GT4/400-3N, CS7LCE4/200-3, CS7LCE4/230-3, CS7LCE4/400-3N, CS7LCE6/400-3N, CS7LCE4/400-3N/EO, CS7LCE4/400-3/50HZ/M, CS7LCE4/440-3/60HZ/M, CS7LCT4/400-3N | | |

3 hole flange \varnothing 57.5mm

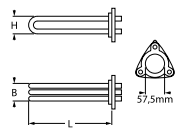



| | | | |
|--------------------|--|-----------------|--------|
| GEV No. | 419085 | Ref. No. | 007078 |
| description | heating element 17000W 230V mounting \varnothing 57.5mm heating circuits 6 L 450mm W 42mm H 42mm number of thermostat sleeves 1 thermostat sleeves \varnothing 4.5mm length thermostat sleeves 180mm thermostat sleeve eccentric, clinging tube \varnothing 6.2mm hole distance 69mm hole \varnothing 6.5mm connection length 75mm connection male faston 6.3mm 3 hole flange immersion heater | | |
| For models: | FCZ101EAN, FCZ101EBN, CL521, AOS101EA2N, AOS101EB2N, AOS101EANQ, AOS101EBNQ | | |

| | | | |
|---|--|-----------------|--|
| GEV No. | 418154 | Ref. No. | 007076 0C5384 |
| description | heating element 17000W 400V mounting \varnothing 57.5mm heating circuits 6 L 450mm W 39mm H 41mm number of thermostat sleeves 1 thermostat sleeves \varnothing 4.5mm length thermostat sleeves 180mm thermostat sleeve eccentric, clinging tube \varnothing 6.3mm hole distance 69mm hole \varnothing 6.5mm connection length 75mm connection male faston 6.3mm 3 hole flange immersion heater | | |
| For models: | FCZ101EAA, FCZ101EAH, FCZ101EBA, FCZ101EBH, CL611, AOW101EA, AOS101EA, AOS101EB, AOS101EB6M, AOS101EA0H, AOS101EB0H, AOS101EAAQ, AOS101EBAQ, AOS101EAHQ, AOS101EBHQ, EJN101EAA, RDR101EAA, EJN101EBA, RDR101EBA | | |
| spare parts for | 418154 | | |
| | | | 007029 047156 049909 0E5037 0K9011 |
| | GEV No. | 510409 | Ref. No. |
|  | O-ring EPDM thickness 5.34mm ID \varnothing 56.52mm Qty 1 pcs | | |
| accessories for | 418154 | | |
| | | | 007029 047156 049909 0E5037 0K9011 |
| | GEV No. | 510409 | Ref. No. |
|  | O-ring EPDM thickness 5.34mm ID \varnothing 56.52mm Qty 1 pcs | | |
| | GEV No. | 550002 | Ref. No. |
|  | tension strap H 10mm L 21mm W 10mm hole \varnothing 6.5mm for heating element | | |

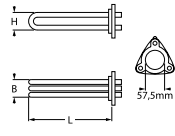

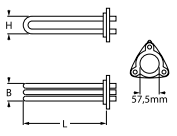

| | | | |
|--------------------|--|-----------------|------------------|
| GEV No. | 418155 | Ref. No. | 007101 0C5383 |
| description | heating element 24000W 400V mounting \varnothing 57.5mm heating circuits 6 L 570mm W 40mm H 40mm number of thermostat sleeves 1 thermostat sleeves \varnothing 4.5mm length thermostat sleeves 180mm thermostat sleeve eccentric, clinging tube \varnothing 6.3mm hole distance 69mm hole \varnothing 6.5mm connection male faston 6.3mm 3 hole flange immersion heater | | |
| For models: | FCZ102EAA, FCZ202EAA, FCZ201EAH, FCZ102EBA, FCZ201EBA, FCZ202EBA, FCZ201EBH, CL121, AOS201EA, AOS201EB, AOS201EB6M, AOS202EA2N, AOS202EB2N, AOS201EA0H, AOS201EB0H, AOS102EA, AOS102EB, AOS202EA, AOS202EB, AOS102EAAQ, AOS102EBAQ, AOS201EAAQ, AOS201EBAQ, AOS202EAAQ, AOS202EBAQ, AOS201EAHQ, AOS201EBHQ, AOS201EBFQ, AOS201EAA1, AOS202EAA1, AOS201EAH1, AOS201EAF1, AOS201EAQ1, AOS202EAK1, AOS201EBA1, AOS202EBA1, AOS201EBH1, AOS201EBF1, AOS202EBK1, AOS201ECM1, AOS201ECB1, EJN102EAA, EJN201EAA, EJN202EAA, RDR201EAA, EJN102EBA, EJN201EBA, EJN202EBA, RDR201EBA | | |

1

| | | | |
|------------------------|---|-----------------|---|
| GEV No. | 416129 | Ref. No. | 049898 0L2108 0L2725 |
| description | heating element 6000W 230V mounting ø 57.5mm heating circuits 3 L 330mm W 36mm H 40mm tube ø 8.5mm hole distance 70mm hole ø 7.8mm connection length 28mm connection male faston 6.3mm 3 hole flange immersion heater | | |
| For models: | LS6EP, LS6EP/DD, LS6EADD, LS6EA/DPDD, WT38TDE, WT38/M50, LS6EADP3, LS6EADPWS, LS6EADPWSG, WT38WS, WT38WSG, WT38MEDWS, WT38PM50, LS6EADPDWS, WT38DWS, LS6SANA, EUCAI60, WT38M50/4, LS6EA/UK, LS6EA/DPUK, EUCAIML, EUCAIMLG, EUCAICLG, EUCAIWL, LS6EA/60, EUCIM, WT38D, WT37, WT38, WT37/UK, EUCIDDC, WT38CUK, WT38UK, WT38/60, WT38MED, WT38WL, LS6EA, LS6EA/DP, LS6EAH, LS6MCD, ET12E, FL620EP, ET5EDG, LV6EP, H3300, LV6EADPWS, FL620ADPWS, H1310SANA, FL620EAG, FL620D-PWSG...(Other models you can see in the webshop) | | |
| accessories for | 416129 | | |
| | | | 007029 047156 049909 0E5037 0K9011 |
| | GEV No. | 510409 | Ref. No. |
| | | | O-ring EPDM thickness 5.34mm ID ø 56.52mm Qty 1 pcs |

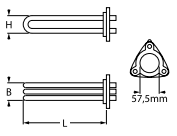
1

| | | | |
|------------------------|---|-----------------|---|
| GEV No. | 418153 | Ref. No. | 007030 0C5381 |
| description | heating element 9000W 400V mounting ø 57.5mm heating circuits 6 L 440mm W 38mm H 40mm number of thermostat sleeves 1 thermostat sleeves ø 4mm length thermostat sleeves 180mm thermostat sleeve eccentric, clinging hole distance 68mm hole ø 6mm connection male faston 6.3mm 3 hole flange immersion heater | | |
| For models: | FCZ061EAA, FCZ061EAH, FCZ061EBA, FCZ061EBH, AOS061EA, AOS061EB, AOS061EB6M, AOS061EA0H, AOS061EB0H, AOS061EAAQ, AOS061EBAQ, AOS061EAHQ, AOS061EBHQ, AOS061EAA1, AOS061EAH1, AOS061EAF1, AOS061EBA1, AOS061EBH1, AOS061EBF1, AOS061ECM1, AOS061ECB1, EJN061EAA, RDR061EAA, EJN061EBA, RDR061EBA | | |
| spare parts for | 418153 | | |
| | | | 007029 047156 049909 0E5037 0K9011 |
| | GEV No. | 510409 | Ref. No. |
| | | | O-ring EPDM thickness 5.34mm ID ø 56.52mm Qty 1 pcs |

with expansion flange 70 x 18mm



1

| | | | |
|------------------------|--|-----------------|---|
| GEV No. | 415460 | Ref. No. | 0H6199 0K0550 0KC471 |
| description | heating element 1000W 230V heating circuits 1 flange 70x18mm L 230mm W 65mm connection male faston 6.3mm tube ø 8.5mm immersion heater expansion flange connection length 20mm silicone TD ø 8mm | | |
| For models: | 7573-3/85.KES100.(N), 7574-3/85.KES150.(N), 7575-3/85.KES250.(N), 7576-3/85.KES300.(N), 7573-3/90.KES100.(N), 7574-3/90.KES150.(N), 7575-3/90.KES250.(N), 7576-3/90.KES300.(N), 7573-3, 7574-3, 7575-3, 7576-3, 7577-3, 7773-3, 7773-3/85.KES100, 7773-3/90.KES100, 7774-3, 7774-3/85.KES150, 7774-3/90.KES150, 7775-3, 7775-3/85.KES250, 7775-3/90.KES250, 7776-3, 7776-3/85.KES300, 7776-3/90.KES300, 9100-3, 9104-3, 9113-3, 9190-3, 9191-3, 9193-3, 9195-3, 9300-3-0, 9300-3-8, 9304-3-0, 9304-3-8, 9313-3-0, 9313-3-8, 9390-3, 9391-3, 9393-3, 9395-3 | | |
| accessories for | 415460 | | |
| | | | 007029 047156 049909 0E5037 0K9011 |
| | GEV No. | 375044 | Ref. No. |
| | | | 0H6141 0KE595 |
| | | | safety thermostat switch-off temp. 178°C 1-pole 16A probe ø 4mm probe L 91mm capillary pipe 1730mm capillary pipe isolated 1600mm gland nut probe with sealing sleeve screw connection M8x1 sealing sleeve 8.6x32mm |



1

| | | | |
|--------------------|--|-----------------|--|
| GEV No. | 415459 | Ref. No. | 0H6146 0K0506 0KE597 0T0012 213742 213743 |
| description | heating element 5600W 230V heating circuits 2 flange 70x18mm L 272mm W 64mm connection male faston 6.3mm tube ø 8.5mm immersion heater expansion flange H 19mm | | |
| For models: | 5611-3-10, 5611-3-6, 5611-3-8, 5612-3-10, 5612-3-6, 5612-3-8, 5614-3-10, 5614-3-6, 5614-3-8 | | |



1

| | | | |
|--------------------|--|-----------------|--------|
| GEV No. | 415557 | Ref. No. | 0H6164 |
| description | heating element 5600W 400V heating circuits 2 L 272mm W 64mm tube ø 8.5mm connection male faston 6.3mm immersion heater expansion flange 70x18mm | | |
| For models: | 7573-3/85.KES100.(N), 7574-3/85.KES150.(N), 7575-3/85.KES250.(N), 7576-3/85.KES300.(N), 7573-3/90.KES100.(N), 7574-3/90.KES150.(N), 7575-3/90.KES250.(N), 7576-3/90.KES300.(N), 7573-3, 7574-3, 7575-3, 7576-3, 7577-3, 7773-3, 7773-3/85.KES100, 7773-3/90.KES100, 7774-3, 7774-3/85.KES150, 7774-3/90.KES150, 7775-3, 7775-3/85.KES250, 7775-3/90.KES250, 7776-3, 7776-3/85.KES300, 7776-3/90.KES300, 9100-3, 9101-3, 9102-3, 9104-3, 9111-3, 9113-3, 9190-3, 9191-3, 9193-3, 9195-3, 9300-3-0, 9300-3-8, 9301-3-0, 9301-3-8, 9302-3-0, 9302-3-8, 9304-3-0, 9304-3-8, 9311-3-0, 9311-3-8, 9313-3-0, 9313-3-8, 9390-3, 9391-3, 9393-3...(Other models you can see in the webshop) | | |







| | | | |
|---|---|-----------------|------------------|
|  | | | |
| GEV No. | 415463 | Ref. No. | 0H6171 OK0584 |
| description | heating element 6000W 230V heating circuits 2 flange 70x18mm L 385mm W 59mm connection male faston 6.3mm tube ø 8.5mm immersion heater expansion flange | | |







| | | | |
|---|---|-----------------|--------|
|  | | | |
| GEV No. | 415464 | Ref. No. | 0H6198 |
| description | heating element 6000W 400V heating circuits 2 flange 70x18mm L 380mm W 65mm connection male faston 6.3mm tube ø 8.5mm immersion heater expansion flange | | |

with round flange ø47.5mm









| | | | |
|---|--|-----------------|------------------------|
|  | | | |
| GEV No. | 419086 | Ref. No. | 056012 1GIL7B176009 |
| description | heating element 17000W 220V heating circuits 6 mounting ø 47.5mm L 470mm W 42mm H 42mm round flange cable length 380mm immersion heater tube ø 6.3mm connection length 130mm | | |
| For models: | FV4E, FCVE10-2, FCVE10-4, FCVE10-2UK, FCVE10-4UK, ZOFCV/E102, ZOFCV/E104, FV4E | | |

| | | | |
|---|---|-----------------|--------|
|  | | | |
| GEV No. | 418156 | Ref. No. | 055464 |
| description | heating element 17000W 240V heating circuits 3 mounting ø 47.5mm L 470mm W 36mm H 40mm round flange connection cable cable length 350mm immersion heater tube ø 6.3mm | | |
| For models: | FCVE10-2, FCVE10-4, FCVE10-2UK, FCVE10-4UK, ZOFCV/E102, ZOFCV/E104 | | |

| | | | |
|---|----------------|--------|--|
| accessories for 418156 | | | |
|  | GEV No. | 510408 | Ref. No. 046213 055533 065710 067620 OG0216 OG1615 OH2559 OK2935 OK5546 OK8688 OL2765 718042198 |
| O-ring EPDM thickness 5.34mm ID ø 47mm Qty 1 pcs | | | |
|  | GEV No. | 510562 | Ref. No. — |
| O-ring silicone thickness 5.34mm ID ø 47mm Qty 1 pcs | | | |
|  | GEV No. | 520235 | Ref. No. — |
| 3 hole flange hole distance 70.5mm perforation ø 6.5mm ID ø 53.5mm | | | |
|  | GEV No. | 520236 | Ref. No. 003362 065558 OK2022 OK2917 OKD441 |
| flange for heating element ID ø 50mm ED ø 90mm H 3mm | | | |
|  | GEV No. | 550002 | Ref. No. — |
| tension strap H 10mm L 21mm W 10mm hole ø 6.5mm for heating element | | | |
|  | GEV No. | 550362 | Ref. No. — |
| blind flange ø 64mm mounting ø 47.5mm | | | |

| | | | |
|---|---|-----------------|--|
|  | | | |
| GEV No. | 415809 | Ref. No. | 055384 056013 |
| description | heating element 24000W 400V heating circuits 3 mounting ø 47.5mm round flange connection cable immersion heater | | |
| For models: | FCVE20-2, FCVE20-4, FCVE203CE, FCVE20-2UK, FCVE20-4UK, ZOFCV/E202, ZOFCV/E204 | | |
| accessories for 415809 | | | |
|  | GEV No. | 510408 | Ref. No. 046213 055533 065710 067620 OG0216 OG1615 OH2559 OK2935 OK5546 OK8688 OL2765 718042198 |
| O-ring EPDM thickness 5.34mm ID ø 47mm Qty 1 pcs | | | |
|  | GEV No. | 510562 | Ref. No. — |
| O-ring silicone thickness 5.34mm ID ø 47mm Qty 1 pcs | | | |
|  | GEV No. | 520235 | Ref. No. — |
| 3 hole flange hole distance 70.5mm perforation ø 6.5mm ID ø 53.5mm | | | |
|  | GEV No. | 520236 | Ref. No. 003362 065558 OK2022 OK2917 OKD441 |
| flange for heating element ID ø 50mm ED ø 90mm H 3mm | | | |
|  | GEV No. | 550002 | Ref. No. — |
| tension strap H 10mm L 21mm W 10mm hole ø 6.5mm for heating element | | | |
|  | GEV No. | 550362 | Ref. No. — |
| blind flange ø 64mm mounting ø 47.5mm | | | |





| | | | |
|---|---|-----------------|---|
|  | | | |
| GEV No. | 415652 | Ref. No. | 002751 0C5337 |
| description | heating element 24000W 400V heating circuits 6 mounting ø 47.5mm L 585mm W 32mm H 35mm round flange connection male faston 6.3mm immersion heater tube ø 6.3mm connection length 86mm thermostat sleeves ø 5mm number of thermostat sleeves 1 length thermostat sleeves 155mm thermostat sleeve clinging | | |
| For models: | FCV/E102/1L3, FCV/E20L3, FCVE202L3, FCV/E102/1L6, FCV/E20L6, FCVE202L6, FVC/E102/1, FVC/E201/1, FVC/E202/1, FCS102E4, FCS102EP, FCS201E4, FCS201EP, FCS202E4, FCS202EP, FCS102EX, FCS201EX, 5714-3-6, 5714-3-7, 5714-3-8, 5714-3-8E, 5714-3-10, 5717-3-6, 5717-3-7, 5717-3-8, 5717-3-8E, 5717-3-10, 5717-3-8C, ECVE102T4, ECV/E20T4, ECVE202T4, ECV/E102/1T6, ECV/E20T6, ECVE202T6, ACVE102C4, ACV/E20C4, ACVE202C4, ACV/E102/1C6, ACVE20C6, ACV/E202/1, ZCV/E102/1, ZCV/E20T4, ZCV/E202/1, ZCV/E102/1T6, ZCV/E20T6, ZCV/E202/1 | | |
| spare parts for | 415652 | | |
| | | | 046213 055533 065710 067620 0G0216 0G1615 0H2559 0K2935 0K5546 0K8688 0L2765 718042198 |
|  | GEV No. | 510408 | Ref. No. |
| | O-ring EPDM thickness 5.34mm ID ø 47mm Qty 1 pcs | | |
| accessories for | 415652 | | |
| | | | 046213 055533 065710 067620 0G0216 0G1615 0H2559 0K2935 0K5546 0K8688 0L2765 718042198 |
|  | GEV No. | 510408 | Ref. No. |
| | O-ring EPDM thickness 5.34mm ID ø 47mm Qty 1 pcs | | |
|  | GEV No. | 510562 | Ref. No. |
| | O-ring silicone thickness 5.34mm ID ø 47mm Qty 1 pcs | | |
|  | GEV No. | 520235 | Ref. No. |
| | 3 hole flange hole distance 70.5mm perforation ø 6.5mm ID ø 53.5mm | | |
|  | GEV No. | 520236 | Ref. No. |
| | flange for heating element ID ø 50mm ED ø 90mm H 3mm | | |
|  | GEV No. | 550002 | Ref. No. |
| | tension strap H 10mm L 21mm W 10mm hole ø 6.5mm for heating element | | |
|  | GEV No. | 550362 | Ref. No. |
| | blind flange ø 64mm mounting ø 47.5mm | | |
|  | GEV No. | 550460 | Ref. No. |
| | kable set | | |

| | | | |
|--|--|-----------------|--------|
|  | | | |
| GEV No. | 417657 | Ref. No. | OK4798 |
| description | heating element 3x1500W 230V heating circuits 3 mounting ø 47.5mm L 500mm W 38mm H 38mm round flange immersion heater tube ø 6.3mm thermostat sleeves ø 7mm number of thermostat sleeves 1 length thermostat sleeves 280mm thermostat sleeve eccentric, clinging | | |

| | | | |
|--|--|-----------------|--|
|  | | | |
| GEV No. | 419097 | Ref. No. | 0H9761 0H9762 0K4801 0K4802 0K4807 |
| description | heating element 6000W 230V heating circuits 3 mounting ø 47.5mm L 500mm W 38mm H 38mm round flange immersion heater tube ø 6.3mm thermostat sleeves ø 7mm number of thermostat sleeves 1 length thermostat sleeves 280mm thermostat sleeve eccentric, clinging | | |

| | | | |
|--|--|-----------------|--|
|  | | | |
| GEV No. | 418188 | Ref. No. | 055431 055463 056011 0K9195 1GIL7B176003 |
| description | heating element 7500W 220V heating circuits 3 mounting ø 47.5mm L 260mm W 35mm H 32mm round flange cable length 1040mm immersion heater tube ø 6.2mm | | |
| For models: | FCVE6-1U, FCVE6-3U, FCVE6-1, FCVE6-3, FCVE6-1UK, FCVE6-3UK, FCVE203CE, FCV/E6-1, FCV/E6-1 | | |
| accessories for | 418188 | | |

| | | | |
|---|--|--------|---|
| | | | 046213 055533 065710 067620 0G0216 0G1615 0H2559 0K2935 0K5546 0K8688 0L2765 718042198 |
|  | GEV No. | 510408 | Ref. No. |
| | O-ring EPDM thickness 5.34mm ID ø 47mm Qty 1 pcs | | |

| | | | |
|---|--|--------|---|
| | | | 046213 055533 065710 067620 0G0216 0G1615 0H2559 0K2935 0K5546 0K8688 0L2765 718042198 |
|  | GEV No. | 510562 | Ref. No. |
| | O-ring silicone thickness 5.34mm ID ø 47mm Qty 1 pcs | | |
|  | GEV No. | 520235 | Ref. No. |
| | 3 hole flange hole distance 70.5mm perforation ø 6.5mm ID ø 53.5mm | | |

| | | | |
|---|--|--------|--|
| | | | 003362 065558 0K2022 0K2917 0KD441 |
|  | GEV No. | 520236 | Ref. No. |
| | flange for heating element ID ø 50mm ED ø 90mm H 3mm | | |



| | | | |
|---|---|--------|-----------------|
|  | GEV No. | 550002 | Ref. No. |
| | tension strap H 10mm L 21mm W 10mm hole ø 6.5mm for heating element | | |

| | | | |
|---|---------------------------------------|--------|-----------------|
|  | GEV No. | 550362 | Ref. No. |
| | blind flange ø 64mm mounting ø 47.5mm | | |



| with round flange ø57.5mm | | | |
|---|--|-----------------|--------|
|  | | | |
| GEV No. | 419087 | Ref. No. | OK7528 |
| description | heating element 6900/7500W 230/240V heating circuits 3 mounting ø 57.5mm L 325mm W 40mm H 40mm round flange connection male faston 6.3mm immersion heater tube ø 6.3mm thermostat sleeves ø 6.2mm number of thermostat sleeves 1 length thermostat sleeves 300mm thermostat sleeve eccentric, clinging | | |
| For models: | AR170S, AR170S, AR170S, AR170S, AR170S, AR170S, AR170S, AR170S, AR170S, AR340S, AR340S, AR340S, AR340S, AR340S, AR340S, AR340S, AR10ES, AR10ES, AR10ES, AR10ES, AR10ES, AR10ES, AR10ES, AR10ES, AR10ESP, AR10ESP, AR10ESP, AR10ESP, AR10ESP, AR10ESP, AR10ES, AR10ES, AR10ES, AR10ES, AR10ES, AR10ES, AR10ESP, AR10ESP, AR10ESP, AR10ESP, AR10ESP, AR10ESP, AR10ESP, AR10ESP, AR10ESP, AR10ESP...(Other models you can see in the webshop) | | |

| special flanges | | | |
|---|--|-----------------|--------------------------|
|  | | | |
| GEV No. | 419089 | Ref. No. | OKJ275 6010187206SVAR |
| description | heating element 6000W 220V heating circuits 3 L 225mm W 140mm H 100mm hole ø 9mm cable length 250mm tube ø 8.5mm flange length 235mm flange width 125mm immersion heater | | |

| miscellaneous | | | | |
|---|---|-----------------|-----------------|--------|
|  | | | | |
| GEV No. | 420305 | Ref. No. | OC5840 | |
| description | heating element 17000W 400V heating circuits 6 L 395mm W 76mm H 61mm flange connection hole ø 6mm connection male faston 6.3mm flange length 105mm flange width 87mm tube ø 8.5mm immersion heater number of thermostat sleeves 1 length thermostat sleeves 120mm thermostat sleeve eccentric, clinging/not clinging | | | |
| For models: | FCZ101EAA, FCZ101EAH, FCZ101EAN, FCZ101ETA, FCZ101ETH, FCZ101ETN, FCZ101EBA, FCZ101EBH, FCZ101EBN, FCZ101EBC, FCZ101EBA2, FCZ101EBH2, FCZ101EBN2, FCZ101EBC2, FCZ101ECA, FCZ101ECH, FCZ101ECN, FCZ101ECA2, FCZ101ECH2, FCZ101ECN2, AOW101EA, AOW101EABU, AOS101EAA1, AOS101EAH1, AOS101EAN1, AOS101EAC1, AOS101EAE1, AOS101EAF1, AOS101EAQ1, AOS101EAM1, AOS101EAB1, AOS101EAK1, AOS101EAT1, AOS101ETA1, AOS101ETH1, AOS101ETN1, AOS101ETC1, AOS101ETE1, AOS101ETF1, AOS101ETM1, AOS101ETK1, AOS101EBA1, AOS101EBH1, AOS101EBN1, AOS101EBC1, AOS101EBE1, AOS101EBF1, AOS101EBK1, AOS101EBA2, AOS101EBH2...(Other models you can see in the webshop) | | | |
| accessories for | 420305 | | | |
|  | GEV No. | 901629 | Ref. No. | OC5834 |
| | flange gasket L 101mm W 83mm hole ø 6mm hole distancemm 7 holes thickness 5mm for heating element | | | |

| | | | | |
|--|--|-----------------|-----------------|--------|
|  | | | | |
| GEV No. | 420284 | Ref. No. | OC5841 | |
| description | heating element 24000W 400V heating circuits 6 L 535mm W 60mm H 75mm 7 hole fixing connection male faston 6.3mm flange length 105mm flange width 87mm tube ø 8.4mm immersion heater number of thermostat sleeves 1 length thermostat sleeves 120mm thermostat sleeve eccentric, clinging thermostat sleeves ø 4.7mm | | | |
| For models: | FCZ102EAA, FCZ102ETA, FCZ201ETA, FCZ202ETA, FCZ201ETH, FCZ201ETN, FCZ102EBA, FCZ102EBA2, FCZ201EBA2, FCZ202EBA2, FCZ201EBH2, FCZ201EBN2, FCZ201EBC2, FCZ102ECA, FCZ102ECA2, FCZ201ECA2, FCZ202ECA2, FCZ201ECH2, FCZ201ECN2, AOS102EAA1, AOS201EAA1, AOS202EAA1, AOS201EAH1, AOS102EAC1, AOS201EAF1, AOS102EAS1, AOS201EAQ1, AOS102EAM1, AOS102EAB1, AOS102EAK1, AOS201EAK1, AOS202EAK1, AOS102EAT1, AOS201EAT1, AOS202EAT1, AOS102ETA1, AOS201ETA1, AOS202ETA1, AOS201ETH1, AOS201ETN1, AOS201ETC1, AOS201ETE1, AOS201ETF1, AOS102ETM1, AOS201ETM1, AOS202ETM1, AOS102ETK1, AOS201ETK1, AOS202ETK1, AOS102EBA1...(Other models you can see in the webshop) | | | |
| accessories for | 420284 | | | |
|  | GEV No. | 901629 | Ref. No. | OC5834 |
| | flange gasket L 101mm W 83mm hole ø 6mm hole distancemm 7 holes thickness 5mm for heating element | | | |

| | | | |
|--|---|-----------------|--------|
|  | | | |
| GEV No. | 420548 | Ref. No. | OC5839 |
| description | heating element 9000W 400V heating circuits 6 L 235mm W 85mm H 58mm flange connection hole ø 6mm connection male faston 6.3mm flange length 105mm flange width 90mm tube ø 8.5mm number of thermostat sleeves 1 length thermostat sleeves 125mm thermostat sleeve eccentric, clinging | | |
| For models: | FCZ061EAA, FCZ061EAH, FCZ061EAN, FCZ061ETA, FCZ061ETH, FCZ061ETN, FCZ061EBA, FCZ061EBH, FCZ061EBN, FCZ061EBC, FCZ061EBA2, FCZ061EBH2, FCZ061EBN2, FCZ061EBC2, FCZ061ECA, FCZ061ECH, FCZ061ECN, FCZ061ECA2, FCZ061ECH2, FCZ061ECN2, AOS061EAA1, AOS061EAH1, AOS061EAN1, AOS061EAC1, AOS061EAE1, AOS061EAF1, AOS061EAM1, AOS061EAB1, AOS061EAK1, AOS061EAT1, AOS061ETA1, AOS061ETH1, AOS061ETN1, AOS061ETC1, AOS061ETE1, AOS061ETF1, AOS061ETM1, AOS061ETK1, AOS061EBA1, AOS061EBH1, AOS061EBN1, AOS061EBC1, AOS061EBE1, AOS061EBF1, AOS061EBK1, AOS061EBA2, AOS061EBH2, AOS061EBN2, AOS061EBC2, AOS061EBE2...(Other models you can see in the webshop) | | |

















| 3/4" | | | | |
|--|---|-----------------|--|---|
|  | | | | |
| GEV No. | 415580 | Ref. No. | OG0334 OH9764 OK4804 1GVL0C955001 | |
| description | heating element 5000W 400V heating circuits 1 L 404mm W 23mm H 80mm cable length 400mm connection length 85mm immersion heater flange with thread H1 52mm H2 28mm thread 3/4" | | | |
| For models: | VARIOSTEAM/S-33.3/F, STEAM-O-MAT | | | |
| accessories for | 415580 | | | |
|  | GEV No. | 510403 | Ref. No. | — |
| | flat gasket fibre ED ø 36.5mm ID ø 27mm thickness 2mm Qty 1 pcs | | | |
|  | GEV No. | 510421 | Ref. No. | — |
| | gasket copper ED ø 31.8mm ID ø 26.4mm thickness 2.2mm for thread 3/4" | | | |







Table continues overleaf









| | | | | |
|---|---|--------|----------|---|
| accessories for | 415580 | | | |
|  | GEV No. | 520234 | Ref. No. | — |
| | nut thread 3/4" H 5mm brass WS 30 Qty 1 pcs | | | |

| | | | | |
|---|--|-----------------|----------|--------|
| 1 1/2" | | | | |
|  | | | | |
| GEV No. | 415401 | Ref. No. | 214119 | |
| description | heating element 4500W 230V heating circuits 3 thread 1 1/2" L 315mm W 33mm H 30mm thermostat sleeves ø 6mm length thermostat sleeves 240mm connection M4x0.75 immersion heater flange with thread no original spare part | | | |
| spare parts for | 415401 | | | |
|  | GEV No. | 510406 | Ref. No. | — |
| | flat gasket fibre ED ø 60mm ID ø 48mm thickness 3mm for thread 1 1/2" Qty 1 pcs | | | |
| accessories for | 415401 | | | |
|  | GEV No. | 510424 | Ref. No. | — |
| | gasket copper ED ø 55mm ID ø 48mm thickness 2.2mm Centellen for thread 1 1/2" | | | |
|  | GEV No. | 520211 | Ref. No. | — |
| | reducer thread 2" ET - 1 1/2" IT brass | | | |
|  | GEV No. | 520212 | Ref. No. | 066079 |
| | hexagonal nut thread 1 1/2" brass WS 60 H 8mm | | | |
|  | GEV No. | 550361 | Ref. No. | — |
| | blind flange ø 58mm thread 1 1/2" | | | |

| | | | | |
|---|--|-----------------|----------------------------|--------|
|  | | | | |
| GEV No. | 415392 | Ref. No. | OK0548 214066 415392 | |
| description | heating element 6000W 400V heating circuits 3 thread 1 1/2" L 405mm W 36mm H 33mm thermostat sleeves ø 9mm length thermostat sleeves 360mm thermostat sleeve not clinging tube ø 8.5mm connection M4 immersion heater connection length 60mm flange with thread number of thermostat sleeves 1 | | | |
| spare parts for | 415392 | | | |
|  | GEV No. | 510406 | Ref. No. | — |
| | flat gasket fibre ED ø 60mm ID ø 48mm thickness 3mm for thread 1 1/2" Qty 1 pcs | | | |
| accessories for | 415392 | | | |
|  | GEV No. | 510424 | Ref. No. | — |
| | gasket copper ED ø 55mm ID ø 48mm thickness 2.2mm Centellen for thread 1 1/2" | | | |
|  | GEV No. | 520211 | Ref. No. | — |
| | reducer thread 2" ET - 1 1/2" IT brass | | | |
|  | GEV No. | 520212 | Ref. No. | 066079 |
| | hexagonal nut thread 1 1/2" brass WS 60 H 8mm | | | |
|  | GEV No. | 550361 | Ref. No. | — |
| | blind flange ø 58mm thread 1 1/2" | | | |

| | | | | |
|--|---|-----------------|------------------|--------|
|  | | | | |
| GEV No. | 415403 | Ref. No. | OH6160 415403 | |
| description | heating element 7500W 230V heating circuits 3 thread 1 1/2" L 495mm W 36mm H 33mm thermostat sleeves ø 9mm length thermostat sleeves 400mm thermostat sleeve centre not clinging tube ø 8.5mm connection M4 immersion heater connection length 35mm flange with thread number of thermostat sleeves 1 | | | |
| accessories for | 415403 | | | |
|  | GEV No. | 510406 | Ref. No. | — |
| | flat gasket fibre ED ø 60mm ID ø 48mm thickness 3mm for thread 1 1/2" Qty 1 pcs | | | |
|  | GEV No. | 510424 | Ref. No. | — |
| | gasket copper ED ø 55mm ID ø 48mm thickness 2.2mm Centellen for thread 1 1/2" | | | |
|  | GEV No. | 520211 | Ref. No. | — |
| | reducer thread 2" ET - 1 1/2" IT brass | | | |
|  | GEV No. | 520212 | Ref. No. | 066079 |
| | hexagonal nut thread 1 1/2" brass WS 60 H 8mm | | | |
|  | GEV No. | 550361 | Ref. No. | — |
| | blind flange ø 58mm thread 1 1/2" | | | |

| | | | | |
|---|--|-----------------|----------|--------|
|  | | | | |
| GEV No. | 415404 | Ref. No. | 214067 | |
| description | heating element 9000W 230V heating circuits 3 thread 1 1/2" L 600mm W 39mm H 37mm thermostat sleeves ø 9mm length thermostat sleeves 450mm thermostat sleeve centre not clinging tube ø 8.5mm connection M4 immersion heater flange with thread number of thermostat sleeves 1 | | | |
| spare parts for | 415404 | | | |
|  | GEV No. | 510406 | Ref. No. | — |
| | flat gasket fibre ED ø 60mm ID ø 48mm thickness 3mm for thread 1 1/2" Qty 1 pcs | | | |
| accessories for | 415404 | | | |
|  | GEV No. | 510424 | Ref. No. | — |
| | gasket copper ED ø 55mm ID ø 48mm thickness 2.2mm Centellen for thread 1 1/2" | | | |
|  | GEV No. | 520211 | Ref. No. | — |
| | reducer thread 2" ET - 1 1/2" IT brass | | | |
|  | GEV No. | 520212 | Ref. No. | 066079 |
| | hexagonal nut thread 1 1/2" brass WS 60 H 8mm | | | |
|  | GEV No. | 550361 | Ref. No. | — |
| | blind flange ø 58mm thread 1 1/2" | | | |

heating elements for convection





1

| | | | |
|---|---|-----------------|------------------------|
| GEV No. | 415119 | Ref. No. | 0A2017 |
| description | heating element 1600W 230V heating circuits 1 ID ø 179mm ED ø 197mm L 254mm H 30mm L1 51mm W1 31mm H1 9mm H2 21mm flange length 70mm flange width 22mm hole distance 56mm connection male faston 6.3mm connection length 41mm tube ø 6.3mm convection heating element hole ø 4mm rectangular flange | | |
| For models: | 655-00-106, 655-00-107 | | |
| accessories for | 415119 | | |
|  | GEV No. | 510368 | Ref. No. 057534 |
| | gasket L 70mm W 23.5mm hole ø 5mm hole distance 56mm FIBER thickness 2mm for heating element | | |





1

| | | | |
|---|--|-----------------|----------------------------|
| GEV No. | 415117 | Ref. No. | 054317 054843 055028 |
| description | heating element 2500W 220V heating circuits 1 ID ø 175mm ED ø 195mm L 245mm H 55mm L1 50mm W1 30mm H1 25mm H2 10mm flange length 70mm flange width 22mm hole distance 56mm connection male faston 6.3mm horizontal tube ø 6.5mm convection heating element hole ø 5mm rectangular flange | | |
| For models: | FCF02EV, FCF02EOEM, FCF/E2, FCF/E2D, FCF/E2UK, FCF/E4-OLD, FCF/E4D, FCFE4PH, FCF/E4OLD3, FCF/E2, FCF/E4OLD4, FCF/E2, FCF/E4OLD2, FCF/E4OLD1, FCF/E4D, FCF/E2D, BCFCV101/1, BCFCV102/1, BCFCV101/1, BCFCV102/1 | | |
| spare parts for | 415117 | | |
|  | GEV No. | 510368 | Ref. No. 057534 |
| | gasket L 70mm W 23.5mm hole ø 5mm hole distance 56mm FIBER thickness 2mm for heating element | | |
| accessories for | 415117 | | |
|  | GEV No. | 510426 | Ref. No. 0H6829 |
| | gasket L 72mm W 20mm hole distance 56mm silicone thickness 2mm for heating element | | |



1

| | | | |
|---|--|-----------------|---------------------------|
| GEV No. | 415966 | Ref. No. | 004934 00568 0K3580 |
| description | heating element 2500W 230V heating circuits 1 ID ø 176mm ED ø 188mm L 210mm H 28mm L1 22mm W1 30mm H1 3mm H2 25mm flange length 70mm flange width 22mm hole distance 56mm connection male faston 6.3mm tube ø 6.3mm convection heating element hole ø 5mm rectangular flange | | |
| accessories for | 415966 | | |
|  | GEV No. | 510368 | Ref. No. 057534 |
| | gasket L 70mm W 23.5mm hole ø 5mm hole distance 56mm FIBER thickness 2mm for heating element | | |



1

| | | | |
|--------------------|---|-----------------|--|
| GEV No. | 415351 | Ref. No. | 054609 054610 054613 054614 056945 058145 |
| description | heating element 2500W 230V heating circuits 1 ID ømm L 544mm L1 100mm W1 160mm flange length 70mm flange width 22mm hole distance 56mm ED ømm connection male faston 6.3mm tube ø 8.5mm dry heating element hole ø 50mm rectangular flange L2 444mm W2 33mm W 350mm | | |
| For models: | FCF/E6-0, FCF061ELN, FCF6EHOR, FCF061ENS, FCFE6-1J, FCFE6D, FCFE6D, FCFE6, FCFE6UK, PFCFE6, ECF/E6-0, ECF061ENS, ECF061E5M, ECF061ECV, FCF/E6, ACF/E6-0, JCF/E6-1, JCF/E6-2, RCF061E, AFCF/E6, NCF/E6-0, COCO6E, FCFE061, ZCF/E6-0 | | |



1

| | | | |
|--------------------|--|-----------------|--------|
| GEV No. | 419091 | Ref. No. | 005217 |
| description | heating element 2500W 230V heating circuits 1 ID ø 180mm ED ø 199mm L 245mm H 28mm L1 46mm W1 27mm H1 4mm H2 24mm flange length 70mm flange width 22mm hole distance 56mm connection male faston 6.3mm vertical connection length 45mm tube ø 6.3mm convection heating element hole ø 5mm rectangular flange | | |
| For models: | FCF/E4, FCF/E4-3KW, JCF/E4, JCF/E4, ECF/E4, ECF/E4-3KW, ACF/E4, ACF/E4-3KW, NCF/E4, ZCF/E4, ZCF/E4 | | |

1

| | | | |
|---|--|-----------------|------------------------|
| GEV No. | 418083 | Ref. No. | 054980 055503 |
| description | heating element 3000W 230V heating circuits 1 ID \varnothing 179mm ED \varnothing 190mm L 245mm H 35mm L1 45mm W1 30mm H1 10mm H2 25mm flange length 70mm flange width 22mm hole distance 56mm connection male faston 6.3mm connection length 18mm tube \varnothing 6.3mm convection heating element hole \varnothing 5mm rectangular flange | | |
| For models: | FCF/E4, FCF/E4-3KW, FCF/E4-OLD, FCF/E4D, FCFE4PH, FCVE20/P-V, FCVE20-V, FCVE20VUK, JCF/E4, JCF/E4, ECF/E4, ECF/E4-3KW, FCF/E4OLD3, ACF/E4, ACF/E4-3KW, NCF/E4, FCF/E4OLD2, FCF/E4OLD1, FCF/E4D, ZCF/E4, ZCF/E4, FCV/E20-V | | |
| accessories for | 418083 | | |
|  | GEV No. | 510368 | Ref. No. 057534 |
| | gasket L 70mm W 23.5mm hole \varnothing 5mm hole distance 56mm FIBER thickness 2mm for heating element | | |



1

| | | | |
|--------------------|--|-----------------|----------------------------|
| GEV No. | 418470 | Ref. No. | 0H6168 214154 214166 |
| description | heating element 3000W 230V heating circuits 2 ID \varnothing 350mm ED \varnothing 365mm L 390mm H 118mm W1 62mm H1 34mm H2 84mm flange length 85mm flange width 30mm connection length 90mm tube \varnothing 6.5mm dry heating element hole \varnothing 6.5mm rectangular flange L1 40mm | | |
| For models: | 5611-3-10, 5611-3-6, 5611-3-8 | | |





1

| | | | |
|--------------------|--|-----------------|--------------------|
| GEV No. | 419088 | Ref. No. | 0K8242 20408701 |
| description | heating element 3200W 230V heating circuits 3 ID \varnothing 384mm ED \varnothing 400mm L 440mm H 106mm L1 35mm W1 166mm H1 16mm H2 90mm flange length 205mm flange width 43mm connection length 160mm tube \varnothing 8.5mm cable length 480mm convection heating element mounting thread M14x1.5 rectangular flange | | |



1



| | | | |
|---|--|-----------------|----------------------------|
| GEV No. | 418150 | Ref. No. | 006984 0C5362 0C6500 |
| description | heating element 3200W 400V heating circuits 2 ID \varnothing 383mm ED \varnothing 400mm L 536mm H 60mm L1 136mm W1 32mm H1 36mm H2 24mm flange length 80mm flange width 45mm hole distance 60mm connection male faston 6.3mm connection length 30mm tube \varnothing 8.5mm convection heating element hole \varnothing 6mm rectangular flange | | |
| For models: | FCZ061EAA, FCZ061EAH, FCZ061EAN, FCZ061ETA, FCZ061ETH, FCZ061ETN, FCZ061EBA, FCZ061EBH, FCZ061EBN, FCZ061EBC, FCZ061EBA2, FCZ061EBH2, FCZ061EBN2, FCZ061EBC2, FCZ061ECA, FCZ061ECH, FCZ061ECN, FCZ061ECA2, FCZ061ECH2, FCZ061ECN2, AOS061EA, AOS061EB, AOS061EB6M, AOS061EA0H, AOS061EB0H, AOS061EAAQ, AOS061EBAQ, AOS061EAHQ, AOS061EBHQ, AOS061EAA1, AOS061EAH1, AOS061EAN1, AOS061EAC1, AOS061EAE1, AOS061EAF1, AOS061EAM1, AOS061EAB1, AOS061EAK1, AOS061EAT1, AOS061ETA1, AOS061ETH1, AOS061ETN1, AOS061ETC1, AOS061ETE1, AOS061ETF1, AOS061ETM1, AOS061ETK1, AOS061EBA1, AOS061EBH1, AOS061EBN1... (Other models you can see in the webshop) | | |
| accessories for | 418150 | | |
|  | GEV No. | 550257 | Ref. No. 002689 |
| | gasket L 137mm W 79mm thickness 3.5mm for heating element suitable for JUNO equiv. no. 02689 | | |





1

| | | | |
|--------------------|---|-----------------|----------------------------|
| GEV No. | 415368 | Ref. No. | 055430 055439 056930 |
| description | heating element 3750W 220V heating circuits 3 L 535mm H 34mm L1 95mm W1 157mm flange length 78mm flange width 50mm hole distance 60mm connection male faston 6.3mm connection length 97mm tube \varnothing 8.5mm dry heating element hole \varnothing 6mm rectangular flange L2 440mm W2 33mm W 348mm | | |
| For models: | FCVE6-1U, FCVE6-3U, FCVE6-1, FCVE6-3, FCVE6-3CE, FCVE6-1UK, FCVE6-3UK, FCV/E6-1, FCV/E6-1 | | |





| | | | |
|---|---|-----------------|------------------------|
| GEV No. | 415657 | Ref. No. | 002757 OK0537 |
| description | heating element 4500W 230V heating circuits 3 L 534mm W 350mm H 70mm L1 96mm L2 438mm W1 160mm W2 33mm H1 37mm H2 33mm flange length 76mm flange width 50mm hole distance 60mm hole ø 6mm tube ø 8.5mm convection heating element connection male faston 6.3mm connection length 103mm rectangular flange | | |
| For models: | FCV/E6L3, FCV/E6L4, FCS061EP, FCS061E3CI, FCS061E4, FCS061EXLN, FCS061EX, 5711-3-6, 5711-3-7, 5711-3-8, 5711-3-10, 5711-3-8CH, 5711-3-10CH, 5701-3-2, 5701-3-3, ECV/E6T4, RCV061E2, RCV061E4, ACV/E6C3, NCV/E6L2, ZCV/E6T4 | | |
| accessories for | 415657 | | |
|  | GEV No. | 550256 | Ref. No. 055327 |
| | gasket L 75mm W 50mm hole ø 5mm hole distance 59.5mm rubber thickness 3mm for heating element suitable for JUNO equiv. no. 55327 | | |
|  | GEV No. | 550257 | Ref. No. 002689 |
| | gasket L 137mm W 79mm thickness 3.5mm for heating element suitable for JUNO equiv. no. 02689 | | |



| | | | |
|---|---|-----------------|--|
| GEV No. | 415389 | Ref. No. | 053838 053839 054620 054621 058196 058197 |
| description | heating element 5666W 230V heating circuits 2 ID ø 470mm ED ø 487mm L 590mm H 66mm L1 105mm W1 33mm H1 37mm H2 29mm flange length 80mm flange width 45mm hole distance 60mm connection M5 tube ø 8.5mm convection heating element hole ø 6mm rectangular flange | | |
| For models: | FCFE10, FCFE10UK, FCVE10, FCVE10-2, FCVE10-4, FCVE103CE, FCVE10-2UK, FCVE10-4UK, FCVE20/P-V, FCVE20-V, FCVE20VUK, FCVE10-P, FCVE10PUK, FCF/E10, ZOFVCV/E102, ZOFVCV/E104, FF/E10, COCO10E, FCFE101, FCV/E20-V | | |
| accessories for | 415389 | | |
|  | GEV No. | 550256 | Ref. No. 055327 |
| | gasket L 75mm W 50mm hole ø 5mm hole distance 59.5mm rubber thickness 3mm for heating element suitable for JUNO equiv. no. 55327 | | |





| | | | |
|---|---|-----------------|------------------------|
| GEV No. | 415654 | Ref. No. | 002688 |
| description | heating element 5666W 230V heating circuits 2 ID ø 465mm ED ø 480mm L 580mm H 65mm L1 90mm W1 32mm H1 34mm H2 31mm flange length 80mm flange width 45mm hole distance 56mm connection M5 connection length 108mm tube ø 8.5mm convection heating element hole ø 6mm rectangular flange | | |
| For models: | FCV/E10L2, FCV/E10L3, FCV/E20L3, FCV/E10L6, FCV/E20L6, FVC/E101/1, FVC/E201/1, FCFE101-0, FCFE201-0, FCS101E2, FCS101E4, FCS101EP, FCS201E4, FCS201EP, FCS101EXLN, FCS101EX, FCS201EX, FCS201EXLN, 5712-3-6, 5712-3-7, 5712-3-8, 5712-3-8E, 5712-3-10, 5712-3-8CH, 5712-3-10C, 5714-3-6, 5714-3-7, 5714-3-8, 5714-3-8E, 5714-3-10, 5717-3-6, 5702-3-2, 5702-3-3, 5704-3-2, 5704-3-3, ECFE101-0, ECV/E10T4, ECV/E20T4, ECV/E10T6, ECV/E20T6, ECV/E10IGP, ACFE101-0, ACFE201-0, JCF/E101/1-1, JCF/E101/1-2, RCV101E2, RCV101E4, RCF101E, ACV/E10C2, ACV/E10C4...(Other models you can see in the webshop) | | |
| accessories for | 415654 | | |
|  | GEV No. | 550256 | Ref. No. 055327 |
| | gasket L 75mm W 50mm hole ø 5mm hole distance 59.5mm rubber thickness 3mm for heating element suitable for JUNO equiv. no. 55327 | | |
|  | GEV No. | 550257 | Ref. No. 002689 |
| | gasket L 137mm W 79mm thickness 3.5mm for heating element suitable for JUNO equiv. no. 02689 | | |







| | | | |
|---|---|-----------------|----------------------------|
| GEV No. | 418151 | Ref. No. | 007064 0C5364 0C6501 |
| description | heating element 5670W 400V heating circuits 2 ID ø 467mm ED ø 483mm L 585mm H 60mm L1 102mm W1 33mm H1 32mm H2 28mm flange length 80mm flange width 45mm hole distance 60mm connection male faston 6.3mm tube ø 8.5mm convection heating element hole ø 6mm rectangular flange | | |
| For models: | FCZ101EAA, FCZ201EAA, FCZ101EAH, FCZ201EAH, FCZ101EAN, FCZ101ETA, FCZ201ETA, FCZ101ETH, FCZ201ETH, FCZ101ETN, FCZ201ETN, FCZ101EBA, FCZ201EBA, FCZ101EBH, FCZ201EBH, FCZ101EBN, FCZ101EBC, FCZ201EBC, FCZ101EBA2, FCZ201EBA2, FCZ101EBH2, FCZ201EBH2, FCZ101EBN2, FCZ201EBN2, FCZ101EBC2, FCZ201EBC2, FCZ101ECA, FCZ201ECA, FCZ101ECH, FCZ201ECH, FCZ101ECN, FCZ101ECA2, FCZ201ECA2, FCZ101ECH2, FCZ201ECH2, FCZ101ECN2, FCZ201ECN2, AOS101EA, AOS101EB, AOS201EA, AOS201EB, AOS101EB6M, AOS201EB6M, AOS101EA0H, AOS101EB0H, AOS201EA0H, AOS201EB0H, AOS101EAAQ, AOS101EBAQ, AOS201EAAQ...(Other models you can see in the webshop) | | |
| accessories for | 418151 | | |
|  | GEV No. | 550257 | Ref. No. 002689 |
| | gasket L 137mm W 79mm thickness 3.5mm for heating element suitable for JUNO equiv. no. 02689 | | |



| | | | |
|--|---|-----------------|------------------|
|  <p>1</p> | | | |
| GEV No. | 415393 | Ref. No. | 055481 056970 |
| description | heating element 8000W 230V heating circuits 2 L 150mm W 545mm H 134mm L1 33mm L2 117mm W1 29mm H1 19mm H2 115mm flange length 76mm flange width 50mm hole distance 60mm connection M5 tube ø 8.5mm convection heating element hole ø 6mm rectangular flange | | |
| For models: | FCVE20-2, FCVE20-4, FCVE203CE, FCVE20-2UK, FCVE20-4UK, FCVE20-P, FCVE20PUK, ZOFCV/E202, ZOFCV/E204 | | |

| | | | |
|---|---|-----------------|--|
|  <p>1</p> | | | |
| GEV No. | 415391 | Ref. No. | 054050 054051 054288 054289 056929 056934 |
| description | heating element 8000W 230V heating circuits 2 L 170mm W 505mm H 128mm L1 33mm L2 138mm W1 29mm H1 13mm H2 115mm flange length 76mm flange width 50mm hole distance 60mm connection M5 connection length 104mm tube ø 8.5mm convection heating element hole ø 6mm rectangular flange | | |
| For models: | FCFE20, FCFE20UK, FCFE40, FCFE40D, FCFE40UK, PFCFE40F, FCVE20, FCF/E20, FCFE202, FF/E40, FF/E20, AFCE/E40, COCO20E, 4238N, FCFE201 | | |

| | | | |
|---|--|-----------------|---|
|  <p>1</p> | | | |
| GEV No. | 415656 | Ref. No. | 0A5330 0G2201 0K0553 1054392577921 |
| description | heating element 8000W 400V heating circuits 2 ID ø 560mm ED ø 580mm L 630mm H 68mm L1 50mm W1 33mm H1 37mm H2 29mm flange length 80mm flange width 45mm hole distance 60mm connection M5 connection length 15mm tube ø 8.5mm convection heating element hole ø 6mm rectangular flange | | |
| For models: | FCV/E102/1L3, FCVE202L3, FCV/E102/1L6, FCVE202L6, FVC/E102/1, FVC/E202/1, FCFE102-0, FCFE201-0, FCFE202-0, FCF201ENS, FCS102E4, FCS102EP, FCS202E4, FCS202EP, FCS102EX, FCS202EX, 5717-3-7, 5717-3-8, 5717-3-8E, 5717-3-10, 5717-3-8C, 5707-3-2, 5707-3-3, ECFE102-0, ECFE201-0, ECFE202-0, ECF201ENS, ECVE102T4, ECVE202T4, ECV/E102/1T6, ECVE202T6, ACVE102-0, ACVE201-0, ACVE202-0, JCF/E102/1-1, JCF/E102/1-2, RCF201E, ACVE102C4, ACVE202C4, ACV/E102/1C6, ACV/E202/1, NCF/E102/1, ZCV/E102/1, ZCV/E202/1, ZCV/E102/1T6, ZCV/E202/1, ZCF/E102/1, ZCF/E202/1-0 | | |
| accessories for | 415656 | | |
|  | GEV No. | 550256 | Ref. No. 055327 |
| | gasket L 75mm W 50mm hole ø 5mm hole distance 59.5mm rubber thickness 3mm for heating element suitable for JUNO equiv. no. 55327 | | |
|  | GEV No. | 550257 | Ref. No. 002689 |
| | gasket L 137mm W 79mm thickness 3.5mm for heating element suitable for JUNO equiv. no. 02689 | | |

| | | | |
|---|--|-----------------|----------------------------|
|  <p>1</p> | | | |
| GEV No. | 418152 | Ref. No. | 0C1173 0C5365 0C6502 |
| description | heating element 8000W 400V heating circuits 2 ID ø 569mm ED ø 580mm L 700mm H 60mm L1 120mm W1 33mm H1 34mm H2 26mm flange length 80mm flange width 45mm hole distance 60mm connection male faston 6.3mm connection length 20mm tube ø 8.5mm dry heating element hole ø 6mm rectangular flange | | |
| For models: | FCZ102EAA, FCZ202EAA, FCZ102ETA, FCZ202ETA, FCZ102EBA, FCZ202EBA, FCZ102EBA2, FCZ202EBA2, FCZ102ECA, FCZ202ECA, FCZ102ECA2, FCZ202ECA2, AOS102EA, AOS102EB, AOS202EA, AOS202EB, AOS102EAAQ, AOS102EBAQ, AOS202EAAQ, AOS202EBAQ, AOS102EAA1, AOS202EAA1, AOS102EAC1, AOS102EAS1, AOS102EAM1, AOS202EAM1, AOS102EAB1, AOS202EAB1, AOS102EAK1, AOS202EAK1, AOS102EAT1, AOS202EAT1, AOS102ETA1, AOS202ETA1, AOS102ETM1, AOS202ETM1, AOS102ETK1, AOS202ETK1, AOS102EBA1, AOS202EBA1, AOS102EBC1, AOS102EBK1, AOS202EBK1, AOS102EBA2, AOS202EBA2, AOS102EBK2, AOS202EBK2, AOS102ECA1, AOS202ECA1, AOS102ECM1...(Other models you can see in the webshop) | | |
| accessories for | 418152 | | |
|  | GEV No. | 550257 | Ref. No. 002689 |
| | gasket L 137mm W 79mm thickness 3.5mm for heating element suitable for JUNO equiv. no. 02689 | | |





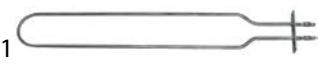

| | | | |
|--------------------|---|-----------------|------------------|
| GEV No. | 420117 | Ref. No. | 055465 056973 |
| description | heating element 8000W 415V heating circuits 2 L 170mm W 505mm H 133mm L1 32mm L2 138mm W1 29mm H1 33mm H2 100mm flange length 76mm flange width 50mm hole distance 60mm connection M5 connection length 102mm tube ø 8.5mm convection heating element hole ø 6mm rectangular flange | | |
| For models: | FCVE20-2, FCVE20-4, FCVE203CE, FCVE20-2UK, FCVE20-4UK, FCVE20-P, FCVE20PUK, ZOFCV/E202, ZOFCV/E204 | | |





| | | | |
|---|--|-----------------|----------------------------|
| GEV No. | 415487 | Ref. No. | 0H6800 OK0601 415487 |
| description | heating element 1000W 230V heating circuits 1 L 445mm W 65mm flange length 70mm flange width 22mm hole distance 28mm connection length 25mm connection male faston 6.3mm tube ø 6.5mm hole ø 3mm W1 30mm rectangular flange convection heating element | | |
| accessories for | 415487 | | |
|  | GEV No. | 510368 | Ref. No. 057534 |
| | gasket L 70mm W 23.5mm hole ø 5mm hole distance 56mm FIBER thickness 2mm for heating element | | |



| | | | |
|---|---|-----------------|--|
| GEV No. | 415457 | Ref. No. | 0H6166 0H6186 OK0557 214137 30074001 415457 |
| description | heating element 3000W 230V heating circuits 2 L 330mm W 135mm L1 60mm L2 270mm H 30mm W2 110mm flange length 85mm flange width 30mm connection length 105mm connection male faston 6.3mm tube ø 6.5mm hole ø 6.5mm W1 25mm rectangular flange hot air | | |
| For models: | 5611-3-10, 5611-3-6, 5611-3-8, 5612-3-10, 5612-3-6, 5612-3-8, 5614-3-10, 5614-3-6, 5614-3-8 | | |
| accessories for | 415457 | | |
|  | GEV No. | 510561 | Ref. No. 0H7021 |
| | O-ring silicone thickness 3mm ID ø 55mm Qty 1 pcs | | |
|  | GEV No. | 520239 | Ref. No. 0H6648 |
| | counterflange L 110mm W 35mm | | |
|  | GEV No. | 521142 | Ref. No. 0H6665 OK1831 246294 |
| | gasket L 68mm W 13mm for heating element | | |

| | | | |
|---|---|--------|-------------------|
| accessories for | 415457 | | |
|  | GEV No. | 528203 | Ref. No. — |
| | gasket rubber ED ø 18mm ID ø 12mm thickness 3mm Qty 1 pcs | | |



| | | | |
|---|--|-----------------|----------------------------|
| GEV No. | 415458 | Ref. No. | 0H6188 214494 415458 |
| description | heating element 3000W 230V heating circuits 2 L 575mm W 150mm W2 125mm flange length 70mm flange width 22mm hole distance 55mm connection length 20mm connection male faston 6.3mm tube ø 6.5mm hole ø 3mm W1 25mm rectangular flange convection heating element | | |
| accessories for | 415458 | | |
|  | GEV No. | 510368 | Ref. No. 057534 |
| | gasket L 70mm W 23.5mm hole ø 5mm hole distance 56mm FIBER thickness 2mm for heating element | | |

accessories

| | | | |
|---|---|--------|----------------------------------|
| hexagonal nuts | | | |
|  | GEV No. | 550261 | Ref. No. 006245 OK9627 |
| description | nut thread M14x1 H 4mm WS 19 SS Qty 1 pcs | | |
| For models: | FCV/G6L3TOWNGAS, FCV/G6L3, FCV/E101/1, FCV/G20L3, FCVG202L3, FCV/E10L6JAP, FCV/E102/1L6JAP, FCV/G6L3JAP, FCV/G10L6JAP, FCV/G102/1L6JAP, FCV/E61/1, FCV/E61/1, FCV/E101/1, FCV/E101/1, FCV/E102/1, FCV/E61/1, FCV/E61/1, FCV/E101/1, FCV/G61/1, FCV/G61/1, FCV/G61/1, FCV/E102/1, FCV/E102/1, FCV/G6L4, FCV/E101/1, FCV/G10L6, FCV/E10L6, FCV/G102/1L6, FCV/E102/1L6, FCV/G101/1, FVC/E101/1, FCV/G102/1, FVC/E102/1, FCV/G201/1, FVC/E201/1, FCV/G202/1, FVC/E202/1, FCF/G6-0, FCFG101/0, FCFG102-0, FCFG201-0, FCFG202-0, FCF/E6-0, FCFE101-0, FCFE102-0, FCF061ELN, FCF101ELN, FCF6EHOR, FCFG10160H, FCF061ENS, FCF101ENS...(Other models you can see in the webshop) | | |

| | | | |
|---|---|--------|------------------------|
| washers | | | |
|  | GEV No. | 560112 | Ref. No. 0E1119 |
| description | plain washer ID ø 5.3mm ED ø 10mm thickness 1mm SS Qty 20 pcs DIN 125A for thread M5 | | |
| For models: | W3400H06, W355HE, W3400H, W3400H, W355HQSR, W355H, W355H, LC12E, LC12EC, CLC12, CLC12EC, CLC22, CLC22VC, C240, C260, WE55QSR_EL, FT36ED, FT36ES, FT36VD, FT36VS, FT50ED, FT50ES, FT50VD, FT50VS, FT72ED, FT72ES, FT72VD, FT72VS, FT36EDT, FT36EST, FT36VDT, FT36VST, FT50EDT, FT50EST, FT50VDT, FT50VST, FT72EDT, FT72EST, FT72VDT, FT72VST, FT360EDT, FT360EST, FT360VDT, FT360VST, FT500EDT, FT500EST, FT500VDT, FT500VST, FT720EDT, FT720EST...(Other models you can see in the webshop) | | |



| sealing washers | | | |
|--------------------|---|-----------------|---|
| fibre gaskets | | | |
| | | | |
| GEV No. | 510404 | Ref. No. | 0E2240 0H2578 0H2612 0K6137 0K8703 0KG502 3427TJ1,5 |
| description | flat gasket fibre ED ø 44mm ID ø 34mm thickness 2mm Qty 1 pcs | | |
| For models: | EBS50, EBS50, EBS50, EBS50, EBV50, EBV50, EBV50, EBV50, EBV50, EBS100, EBS100, EBS100, EBS100, EBV100, EBV100, EBV100, EBV100, EBV100, EBV-C100, EBV-C100, EBV-C100, EBV-C100, EBV-C100, EBS200, EBS200, EBS200, EBS200, EBV200, EBV200, EBV200, EBV200, EBV200, EBV-C200, EBV-C200, EBV-C200, EBV-C200, EBS300, EBS300, EBS300, EBS300, EBV300, EBV300, EBV300, EBV300, EBV300, EBV-C300, EBV-C300, EBV-C300...(Other models you can see in the webshop) | | |

| O-rings | | | |
|--------------------|---|-----------------|--------|
| | | | |
| GEV No. | 505092 | Ref. No. | 0C3142 |
| description | O-ring EPDM thickness 5.34mm ID ø 43.82mm Qty 1 pcs | | |

| | | | |
|--------------------|---|-----------------|---|
| | | | |
| GEV No. | 510408 | Ref. No. | 046213 055533 065710 067620 0G0216 0G1615 0H2559 0K2935 0K5546 0K8688 0L2765 718042198 |
| description | O-ring EPDM thickness 5.34mm ID ø 47mm Qty 1 pcs | | |
| For models: | MPN/EI760, MPNEI760UK, MPN/EI760D, MCP/E700, MCP/G700, MCP/E700D, MCP/G701, MCP/G710, MCP/G711, FDV40E, FDV40EL, FDV20E, FDV20EL, RPI/E240, RPI/E260, RPI/E260P, RCP/E25, XPI/E240, XPI/E260, XPI/E260P, JPI/E240, JPI/E260, MPI/E240, MPI/E260, MPI/E260P, MCP/E25, 7PIE06, RPN/EI760UK, RPN/EI760D, 7CPE07P, 7CPG07P, RCP/G701, M70EIKE, XPN/EI760UK, XPN/EI760D, M70EPC, M70GPC, M70GPC, CCP/G700, CCP/E700, Xfv/E700, PPI/E260P, ECP/E1ELHU, PCP/E25SH, PCP/E1ELH, OPI/E260P, OCP/E25, TPI/E260P, TCP/E1ELHU, TCP/E25...(Other models you can see in the webshop) | | |

| flange gaskets | | | |
|--------------------|--|-----------------|--------|
| | | | |
| GEV No. | 510368 | Ref. No. | 057534 |
| description | gasket L 70mm W 23.5mm hole ø 5mm hole distance 56mm FIBER thickness 2mm for heating element | | |

| | | | |
|--------------------|--|-----------------|--------|
| | | | |
| GEV No. | 550257 | Ref. No. | 002689 |
| description | gasket L 137mm W 79mm thickness 3.5mm for heating element suitable for JUNO equiv. no. 02689 | | |
| For models: | FCZ061EAA, FCZ101EAA, FCZ102EAA, FCZ201EAA, FCZ202EAA, FCZ061EAH, FCZ101EAH, FCZ201EAH, FCZ061EAN, FCZ101EAN, FCZ201EAN, FCZ061ETA, FCZ101ETA, FCZ102ETA, FCZ201ETA, FCZ202ETA, FCZ061ETH, FCZ101ETH, FCZ201ETH, FCZ061ETN, FCZ101ETN, FCZ201ETN, FCZ061EBA, FCZ101EBA, FCZ102EBA, FCZ201EBA, FCZ202EBA, FCZ061EBH, FCZ101EBH, FCZ201EBH, FCZ061EBN, FCZ101EBN, FCZ201EBN, FCZ061EBC, FCZ101EBC, FCZ201EBC, FCZ061EBA2, FCZ101EBA2, FCZ102EBA2, FCZ201EBA2, FCZ202EBA2, FCZ061EBH2, FCZ101EBH2, FCZ201EBH2, FCZ061EBN2, FCZ101EBN2, FCZ201EBN2, FCZ061EBC2, FCZ101EBC2, FCZ201EBC2...(Other models you can see in the webshop) | | |

| | | | |
|--------------------|--|-----------------|--------|
| | | | |
| GEV No. | 550256 | Ref. No. | 055327 |
| description | gasket L 75mm W 50mm hole ø 5mm hole distance 59.5mm rubber thickness 3mm for heating element suitable for JUNO equiv. no. 55327 | | |
| For models: | FCVE6L3J, FCV/E61/1, FCV/E61/1, FCV/E61/1, FCV/E61/1, FCV/E61/1, FCV/E61/1, FCS061E44J, FCS061EP, FCS061E3CI, FCS061E4, FCS061EXLN, FCS061EX, FCVE6-1U, FCVE6-3U, FCVE6-1, FCVE6-3, FCVE6-3CE, FCVE6-1UK, FCVE6-3UK, FCVE10-2, FCVE10-4, FCVE103CE, FCVE10-2UK, FCVE10-4UK, FCVE20-2, FCVE20-4, FCVE203CE, FCVE20/P-V, FCVE20-2UK, FCVE20-4UK, FCVE20-V, FCVE20VUK, FCVE10-P, FCVE10PUK, FCVE20-P, FCVE20PUK, 5711-3-6, 5711-3-7, 5711-3-8, 5711-3-10, 5711-3-8CH, 5711-3-10CH, 5711-3-10F, 5711-3-10S, 5701-3-2, 5701-3-3, ECV/E6T4, FCV/E6-1, FCV/E6-1...(Other models you can see in the webshop) | | |

| | | | |
|--------------------|---|-----------------|--------|
| | | | |
| GEV No. | 550546 | Ref. No. | 053840 |
| description | gasket L 76mm W 50mm hole ø 6mm thickness 2mm for heating element suitable for ZANUSSI equiv. no. 53840 | | |
| For models: | FCFE10, FCFE10UK, FCFE20, FCFE20UK, FCFE40, FCFE40D, FCFE40UK, PFCFE40F, FCVE10, FCVE20, FCFE10J, FCFE10J, FCFE20J, FCFE20J, FCFE40J, FCFE40J, FCF/E10, FCF/E20, FCFE202, FF/E40, FF/E10, FF/E20, AFcf/E40, COCO10E, COCO20E, 4238N, FCFE101, FCFE201 | | |



| | | | |
|---|--|-----------------|--------|
|  | | | |
| GEV No. | 550547 | Ref. No. | 003726 |
| description | gasket L 80mm W 45mm thickness 1.8mm for heating element suitable for ZANUSSI equiv. no. 03726 | | |
| For models: | FCFE101-0, FCFE102-0, FCFE201-0, FCFE202-0, FCF101ELN, FCFE101-1J, FCFE102-1J, ECFE101-0, ECFE102-0, ACFE101-0, ACFE102-0, ACFE201-0, ACFE202-0, JCF/E101/1-1, JCF/E102/1-1, JCF/E101/1-2, JCF/E102/1-2, RCF101E, NCF/E101/1, NCF/E102/1, ZCF/E101/1, ZCF/E102/1, ZCF/E201/1-0, ZCF/E202/1-0 | | |

| | | | |
|---|--|-----------------|--------|
|  | | | |
| GEV No. | 524460 | Ref. No. | 0C2210 |
| description | gasket ID ø 37.5mm ceramic fibre with aluminium foil thickness 5mm hole ø 7mm hole distance 62mm | | |
| For models: | AOS202GAEU, AOS202GAU, AOS202GB, AOS202GA | | |



| | | | |
|---|--|-----------------|--------|
|  | | | |
| GEV No. | 524461 | Ref. No. | 0C1069 |
| description | gasket ID ø 50mm ceramic fibre with aluminium foil thickness 2.5mm hole ø 7mm hole distance 62mm | | |
| For models: | AOS061GAEU, AOS101GAEU, AOS102GAEU, AOS201GAEU, AOS061GAU, AOS101GAU, AOS102GAU, AOS201GAU, AOS061GA, AOS061GB, AOS101GA, AOS101GB, AOS201GA, AOS201GB, AOS102GB, AOS102GA | | |



| | | | |
|---|---|-----------------|--------|
|  | | | |
| GEV No. | 524462 | Ref. No. | 0C1043 |
| description | gasket ID ø 70mm ceramic fibre with aluminium foil thickness 2.5mm hole ø 7mm hole distance 70mm | | |
| For models: | AOS061GAEU, AOS101GAEU, AOS102GAEU, AOS061GAU, AOS101GAU, AOS102GAU, AOS061GA, AOS061GB, AOS101GA, AOS101GB, AOS102GB, AOS102GA | | |

| | | | |
|---|--|-----------------|--------|
|  | | | |
| GEV No. | 511641 | Ref. No. | 002745 |
| description | gasket rubber L 119mm W 108mm thickness 3mm hole ø 4.5mm ID ø 90mm | | |
| For models: | FCVG102L3, FCVG202L3, FCVG102L3J, FCV/G102/1L6JAP, FCV/G102/1L6, FCVG202L6, ECVG102T4, ECVG202T4, ECV/G102/1T6, ECVG202T6, ACVG102C4, ACVG202C4, ACV/G102/1C6, ACVG202C6, NCV/G102/1, ZCV/G102/1, ZCV/G202/1, ZCV/G102/1T6, ZCV/G202/1 | | |

| | | | |
|---|---|-----------------|----------------------------|
|  | | | |
| GEV No. | 520239 | Ref. No. | 0H6648 |
| description | counterflange L 110mm W 35mm | | |
| For models: | 5611-3-10, 5611-3-6, 5611-3-8, 5612-3-10, 5612-3-6, 5612-3-8, 5614-3-10, 5614-3-6, 5614-3-8 | | |
| accessories for | 520239 | | |
|  | GEV No. | 521142 | Ref. No. |
| | | | 0H6665 OK1831 246294 |
| gasket L 68mm W 13mm for heating element | | | |

| | | | |
|---|--|-----------------|----------------------------|
|  | | | |
| GEV No. | 521142 | Ref. No. | 0H6665 OK1831 246294 |
| description | gasket L 68mm W 13mm for heating element | | |
| For models: | 5611-3-10, 5611-3-6, 5611-3-8, 5612-3-10, 5612-3-6, 5612-3-8 | | |

| | | | |
|---|--|-----------------|-----------------|
|  | | | |
| GEV No. | 901629 | Ref. No. | 0C5834 |
| description | flange gasket L 101mm W 83mm hole ø 6mm hole distance 7mm thickness 5mm for heating element | | |
| For models: | FCZ061EAA, FCZ101EAA, FCZ102EAA, FCZ061EAH, FCZ101EAH, FCZ061EAN, FCZ101EAN, FCZ061ETA, FCZ101ETA, FCZ202ETA, FCZ201ETA, FCZ202ETH, FCZ061ETH, FCZ101ETH, FCZ201ETH, FCZ061ETN, FCZ101ETN, FCZ201ETN, FCZ061EBA, FCZ101EBA, FCZ102EBA, FCZ061EBH, FCZ101EBH, FCZ061EBN, FCZ101EBN, FCZ061EBC, FCZ101EBC, FCZ201EBC, FCZ061EBA2, FCZ101EBA2, FCZ102EBA2, FCZ201EBA2, FCZ202EBA2, FCZ061EBH2, FCZ101EBH2, FCZ201EBH2, FCZ061EBN2, FCZ101EBN2, FCZ201EBN2, FCZ061EBC2, FCZ101EBC2, FCZ201EBC2, FCZ061ECA, FCZ101ECA, FCZ102ECA, FCZ061ECH, FCZ101ECH, FCZ061ECN, FCZ101ECN, FCZ061ECA2... (Other models you can see in the webshop) | | |
| accessories for | 901629 | | |
|  | GEV No. | 420284 | Ref. No. |
| | | | 0C5841 |
| heating element 24000W 400V heating circuits 6 L 535mm W 60mm H 75mm 7 hole fixing connection male faston 6.3mm flange length 105mm flange width 87mm tube ø 8.4mm immersion heater number of thermostat sleeves 1 length thermostat sleeves 120mm thermostat sleeve eccentric, clinging thermostat sleeves ø 4.7mm | | | |

| | | | |
|---|---|-----------------|----------------------------|
| counterflanges | | | |
|  | | | |
| GEV No. | 520239 | Ref. No. | 0H6648 |
| description | counterflange L 110mm W 35mm | | |
| For models: | 5611-3-10, 5611-3-6, 5611-3-8, 5612-3-10, 5612-3-6, 5612-3-8, 5614-3-10, 5614-3-6, 5614-3-8 | | |
| accessories for | 520239 | | |
|  | GEV No. | 521142 | Ref. No. |
| | | | 0H6665 OK1831 246294 |
| gasket L 68mm W 13mm for heating element | | | |



| | | | |
|---|---|-----------------|--|
|  | | | |
| 1 | | | |
| GEV No. | 520236 | Ref. No. | 003362 065558 OK2022 OK2917 OKD441 |
| description | flange for heating element ID ø 50mm ED ø 90mm H 3mm | | |
| For models: | MPN/EI760, MPNEI760UK, MCP/E700, MCP/G700, MCP/E700D, 7PIE06, RPN/EI760UK, 7CPE07P, 7CPG07P, M70EIKE, XPN/EI760UK, M70EPC, M70GPC, RPN/EI760, RPN/EI760, RCP/G700, RCPE700, FCV/E102/1L-3JAP, FCV/E102/1L6JAP, FCV/E102/1, FCV/E102/1, FCV/E102/1L3, FCV/E20L3, FCV/E102/1L6, FCV/E20L6, FCV/E101/1, FVC/E102/1, FVC/E201/1, FCS102E44J, FCS102EP4J, FCS102E4, FCS102EP, FCS201E4, FCS201EP, FCS202E4, FCS202EP, FCS101EX4J, FCS101EXLN, FCS101EX, FCS102EX4J, FCS102EX, FCS201EX, FCS201EXLN, FCS202EX, FCVE6-1U, FCVE6-3U, FCVE6-1, FCVE6-3, FCVE6-1UK, FCVE6-3UK...(Other models you can see in the webshop) | | |

| | | | |
|---|--|-----------------|----------------------------|
| miscellaneous | | | |
|  | | | |
| 1 | | | |
| GEV No. | 510700 | Ref. No. | 0E5127 0G7656 OK7154 |
| description | gasket L 15mm W 15mm hole ø 8mm thickness 2mm for heating element | | |
| For models: | HCCS20W, HCCS20W, WTF2ERC, WTF2ELC, WTF2SRC, WTF2SLC, WTF2HERC, WTF2HELC, WTF2HSRC, WTF2HSLC, WTF3ERC, WTF3ELC, WTF3SRC, WTF3SLC, WTF3HERC, WTF3HELC, WTF3HSRC., WTF3HSLC, WTF2ERB., WTF2ELB, WTF2SRB, WTF2SLB, WTF2HERB, WTF2HELB, WTF2HSRB, WTF2HSLB, WTF3ERB, WTF3ELB, WTF3SRB, WTF3SLB, WTF3HERB, WTF3HELB, WTF3HSRB, WTF3HSLB, WTF4HERB, WTF4HELB, WTF4HSRB, WTF4HSLB, WTF2ERA, WTF2ELA, WTF2SRA, WTF2SLA, WTF2HERA, WTF2HELA, WTF2HSRA, WTF2HSLA, WTF3ERA, WTF3ELA, WTF3SRA, WTF3SLA...(Other models you can see in the webshop) | | |

| | | | |
|---|--|-----------------|------------------|
| clamps | | | |
|  | | | |
| 1 | | | |
| GEV No. | 550401 | Ref. No. | 057519 066823 |
| description | probe clip for pipe ø 9mm for probe ø 6mm Qty 1 pcs | | |
| For models: | MCF/G1090, MCF/G1095, MCF/G995, MG/E350D, MG/E350UK, MG/E700D, MG/E700UK, MG/E350, MG/E700, RCF/G2, RCF/G3, RCF/G9, RG/E1, RG/E2, RGV/E1, RGV/E2, RTF/G2, RSF/G2, RSF/G3, MCF/G2A, MCF/G3A, XCF/G2, XCF/G3, XCF/G9, XG/E1, XG/E2, XGV/E1, XGV/E2, XTF/G2, XSF/G2, XSF/G3, JCF/G2, JCF/G3, JG/E1, JG/E2, JTF/G2, MCF/G2, MCF/G3, MCF/G9, MG/E1, MG/E2, MGV/E1, MGV/E2, MTF/G2, MSF/G2, MSF/G3, RCF/G1095, RG/E350D, RG/E350UK, RG/E700D...(Other models you can see in the webshop) | | |

energy regulators

EGO

1-circuit

| | | | |
|--|---|-----------------|---|
|  | | | |
| 1 | | | |
| GEV No. | 380015 | Ref. No. | 003030 003031 003529 005270 026861 055016 058406 06501 0A2482 0C1605 0C4929 0F0089 0G0652 0G2652 0H6103 0H6137 0H7480 0HB171 0K0502 0K2964 0K3459 0K3763 0K3874 0K5029 0K7769 0K8611 0K9374 0K9741 0K9775 0K9784 0KB064 0KE181 0KJ148 0KJ210 0KS980 0KW347 10063 203160 30001227 3016217 699800100 6998010 699801001 750011 7HAC3016217 |
| description | energy regulator 230V 13A single-circuit turn direction right shaft ø 6x4.6mm shaft L 23mm mounting thread M4 power release 6-100% no. 50.57021.010 | | |
| For models: | MPN/EI760, MPNEI760UK, MPN/EI760D, BCP/E1, RMV/E1C, RMV/E2C, RPI/G260P, RCP/E2S, XMV/E1C, XMV/E2C, XPI/G260P, JMV/E1C, JMV/E2C, MCP/E1SH, MCP/E1SUH, MCP/E2SUHS, MMV/E1C, MMV/E2C, MPI/G260P, MCP/E2S, MCP/E2SH, MCP/E2SUH, MCP/E2SUT, MCP/E2SHB, 7PIE06, RPN/EI760UK, RPN/EI760D, M70EIKE, XPN/EI760UK, XPN/EI760D, PMV/E1C, PMV/E2C, PPD/G260, PPI/G260P, PPI/E260P, PCP/E2SHP, PCP/E1SH, PCP/E2SH, PCP/E2SH3B, OMV/E1C, OMV/E2C, OPD/G260, OPI/G260P, OPI/E260P, OCP/E2S, OCP/E1SH, OCP/E2SH, TMV/E1C, TMV/E2C, TPD/G260...(Other models you can see in the webshop) | | |

thermostats

bi-metal thermostats

safety bi-metal thermostats



1

| | | | |
|--------------------|--|-----------------|--------|
| GEV No. | 390749 | Ref. No. | OKL023 |
| description | bi-metal safety thermostat switch-off temp. 210°C 2-pole connection F6.3 | | |
| For models: | FCV31E3, 7CO30, CCO30G, ECO312CF, OTS100 | | |

bi-metal thermostats



1

| | | | |
|--------------------|--|-----------------|------------------|
| GEV No. | 375666 | Ref. No. | 005203 0KG530 |
| description | bi-metal thermostat 1NO 1-pole 10A 250V connection F6.3 M4 | | |
| For models: | FCF/E4, FCF/E4-3KW, JCF/E4, JCF/E4, ECF/E4, ECF/E4-3KW, ACF/E4, ACF/E4-3KW, NCF/E4, ZCF/E4, ZCF/E4 | | |



1

| | | | |
|--------------------|--|-----------------|--------|
| GEV No. | 375927 | Ref. No. | OPE024 |
| description | bi-metal thermostat hole distance 23.5mm switch-off temp. 50°C 1NO 10A connection F6.3 | | |
| For models: | FS07C, FS11C, FS11C2, NFS15C, FS15C2, FSV07C2X, FSV11C3X, FSV15C4X, FSV07C2C, FSV11C3C, FSV15C4C, FSV11C3CX, FSV15C4CX, FSV11C3CC, FSV15C4CC | | |



1

| | | | |
|--------------------|---|-----------------|------------------|
| GEV No. | 375958 | Ref. No. | 0H2279 0K7537 |
| description | bi-metal thermostat hole distance 40mm 1NO 1-pole connection F6.3 for tank | | |
| For models: | D180, D180, D180, D180, D180, D180, D180, D180, D180, D180, D180, D180, D180, D180, AR170S, AR170S, AR170S, AR170S, AR170S, AR170S, AR170S, AR170S, AR340S, AR340S, AR340S, AR340S, AR340S, AR340S, AR340S, AR340S, AR340S, AR6ES, AR6ES, AR6ES, AR6ES, AR6ES, AR6ES, AR6ES, AR6ES, AR6ES, AR6ES, AR6ES...(Other models you can see in the webshop) | | |



1

| | | | |
|--------------------|--|-----------------|----------------------------|
| GEV No. | 375953 | Ref. No. | 0H2320 0K7651 0KB609 |
| description | bi-metal thermostat switch-off temp. 110°C 1NC 1-pole 230V | | |
| For models: | AR170S, AR170S, AR170S, AR170S, AR170S, AR170S, AR170S, AR170S, AR170S, AR170S, AR340S, AR340S, AR340S, AR340S, AR340S, AR340S, AR340S, AR340S, AR10ES, AR10ES, AR10ES, AR10ES, AR10ES, AR10ES, AR10ES, AR10ES, AR10ESP, AR10ESP, AR10ESP, AR10ESP, AR10ES, AR10ES, AR10ES, AR10ES, AR10ES, AR10ES, AR10ESP, AR10ESP, AR10ESP, AR10ESP, AR10ES, AR10ES, AR10ES, AR10ES, AR10ES, AR10ES, AR10ESP, AR10ESP, AR10ESP, AR10ESP...(Other models you can see in the webshop) | | |

control and safety thermostats

EGO

control thermostats

55.10/19_series



1

| | | | |
|--------------------|---|-----------------|---|
| GEV No. | 390068 | Ref. No. | 029918 057937 0K2960 446570201 |
| description | thermostat t.max. 269°C temperature range 55-269°C 1-pole 1CO 16A probe ø 3.1mm probe L 219mm capillary pipe 1280mm capillary pipe isolated 1270mm gland nut shaft ø 6x4.6mm shaft L 23mm shaft position upper° rotation 318° | | |
| For models: | FCF02EV, FCF02EOEM, FCF/E3, FCF/E2, FCF/E2D, FCF/E2UK, FCFG6D, FCFE6D, FCFE6D, FCFG10, FCFG10D, FCFG10NL, FCFE10, FCFE10UK, FCFG20, FCFG20D, FCFG20F, PFCFG20, FCFE20, FCFE20UK, FCFG40, FCFG41, FCFG40D, FCFG40F, PFCFG40F, FCFE40, FCFE40D, FCFE40UK, PFCFE40F, FCFG6, FCFG6F, PFCFG6, FCFE6, FCFE6UK, PFCFE6, FCVE10, FCVE20, FCVE6-1U, FCVE6-3U, FCVE6-1, FCVE6-3, FCVE6-1UK, FCVE6-3UK, FCVG6-1, FCVG6-3, FCVG6-1UK, FCVG6-3UK, FCVE10-2, FCVE10-4, FCVE10-2UK...(Other models you can see in the webshop) | | |





| | | | |
|--------------------|---|-----------------|--------|
| GEV No. | 375664 | Ref. No. | 054323 |
| description | thermostat t.max. 287°C temperature range 60-287°C 1-pole 1NO 16A probe ø 3.1mm probe L 226mm capillary pipe 1470mm capillary pipe isolated 350mm gland nut shaft ø 6x4.6mm shaft L 23mm shaft position upper rotation 270° | | |
| For models: | FCF/E4-OLD, FCF/E4D, FCFE4PH, FCF/E4OLD3, FCF/E4OLD4, FCF/E4OLD2, FCF/E4OLD1, FCF/E4D | | |



| | | | |
|--------------------|--|-----------------|--------------------|
| GEV No. | 375253 | Ref. No. | 004155 91310003 |
| description | thermostat t.max. 455°C temperature range 85-455°C 1-pole 1NO 16A probe ø 3.9mm probe L 228mm capillary pipe 870mm capillary pipe isolated 660mm gland nut shaft ø 6x4.6mm shaft L 23mm shaft position upper rotation 270° | | |
| For models: | ZCMME6, ZCBME12, ZCMME4, ZCBME8, ZCMME9, ZCBME18 | | |



| | | | |
|--------------------|---|-----------------|--|
| GEV No. | 375667 | Ref. No. | 056384 0F0088 0K0645 30000815 |
| description | thermostat t.max. 300°C temperature range 68-300°C 1-pole 1NO 16A probe ø 3.1mm probe L 226mm capillary pipe 980mm capillary pipe isolated 980mm gland nut shaft ø 6x4.6mm shaft L 23mm shaft position upper rotation 318° | | |
| For models: | FCF/G6-0, FCFG101/0, FCFG102-0, FCFG201-0, FCFG202-0, FCF/E6-0, FCFE101-0, FCFE102-0, FCFE201-0, FCFE202-0, FCF061ELN, FCF101ELN, FCF6EHOR, FCFG10160H, FCF061ENS, FCF101ENS, FCF102ENS, FCF201ENS, FCFG102-0T, FCF/G6-1-JAP, FCF/G101/1-1-JAP, FCF/G102/1-1-JAP, FCFE6-1J, FCFE101-1J, FCFE102-1J, FCF/G101/1, FCFE6J50, FCFE6J60, FCFG10J, FCFG10J, FCFE10J, FCFE10J, FCFG20J, FCFG20J, FCFE20J, FCFE20J, FCFG40J, FCFG40J, FCFE40J, FCFE40J, FCFG6J, FCFG6J, FCFG6J, FCFG6J, FCFG10J, FCFG10J, FCFG20J, FCF-G20J, FCFG41J, FCFG40J...(Other models you can see in the webshop) | | |



| | | | |
|--------------------|---|-----------------|--------|
| GEV No. | 375661 | Ref. No. | 056701 |
| description | thermostat t.max. 500°C temperature range 75-500°C 1-pole 1NO 16A probe ø 3.9mm probe L 228mm capillary pipe 1470mm capillary pipe isolated 960mm gland nut shaft ø 6x4.6mm shaft L 23mm shaft position upper rotation 270° | | |
| For models: | FZG18, FZE18, FPE30, FPE18, FZ/G18, FZ/E18, FP/E30, FP/E18 | | |



| | | | |
|--------------------|--|-----------------|-----------------|
| GEV No. | 375002 | Ref. No. | 004939 00569 |
| description | thermostat t.max. 320°C temperature range 55-320°C 1-pole 1NO 16A probe ø 3.1mm probe L 226mm capillary pipe 870mm capillary pipe isolated 850mm gland nut shaft L 23mm shaft position upper rotation 270° | | |



| | | | |
|--------------------|---|-----------------|----------------------------|
| GEV No. | 375113 | Ref. No. | 055367 056671 0K2952 |
| description | thermostat t.max. 76°C temperature range fixed 76°C 1-pole 1CO 16A probe ø 3.1mm probe L 226mm capillary pipe 870mm capillary pipe isolated 870mm gland nut shaft Lmm shaft position probe material SS | | |
| For models: | FDV40G, FDV40E, FDV40GZ, FDV40EL, FDV40GA, FDV20G, FDV20E, FDV20GZ, FDV20EL, FDV20GA, FCVE6-1U, FCVE6-3U, FCVE6-1, FCVE6-3, FCVE6-3CE, FCVE6-1UK, FCVE6-3UK, FCVG6-1, FCVG6-3, FCVG6-1UK, FCVG6-3UK, FCVE10-2, FCVE10-4, FCVE103CE, FCVE10-2UK, FCVE10-4UK, FCVG10-2, FCVG10-4, FCVG10-4D, FCVG10-4D, FCVG10-2UK, FCVG10-4UK, FCVG10-2, FCVG10-4, FCVE20-2, FCVE20-4, FCVE203CE, FCVE20/P-V, FCVE20-2UK, FCVE20-4UK, FCVG20-2, FCVG20-4, FCVG20-2, FCVG20-4D, FCVG20-2UK, FCVG20-4UK, FCVG20-4, FCVG20-4D, FCVE20-V...(Other models you can see in the webshop) | | |

55.13_ series



| | | | |
|--------------------|---|-----------------|--------------------------------------|
| GEV No. | 375069 | Ref. No. | OK0634 OK0646 OK0674 375069 |
| description | thermostat t.max. 255°C temperature range 50-255°C 1-pole 1CO 16A probe ø 3.03mm probe L 160mm capillary pipe 1430mm capillary pipe isolated 800mm gland nut shaft ø 6x4.6mm shaft L 23mm probe material SS | | |

55.17_ series

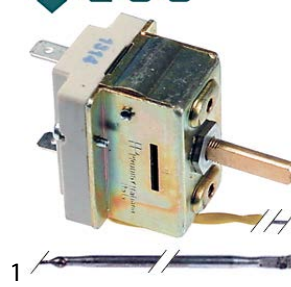

| | | | |
|--------------------|---|-----------------|--------|
| GEV No. | 375665 | Ref. No. | 005207 |
| description | thermostat t.max. 282°C temperature range 96-282°C 1-pole 1NO 16A probe ø 3.03mm probe L 196mm capillary pipe 1240mm capillary pipe isolated 350mm gland nut shaft ø 6x4.6mm shaft L 22mm shaft position left rotation 270° | | |
| For models: | FCF/E4, FCF/E4-3KW, JCF/E4, JCF/E4, ECF/E4, ECF/E4-3KW, ACF/E4, ACF/E4-3KW, NCF/E4, ZCF/E4, ZCF/E4 | | |

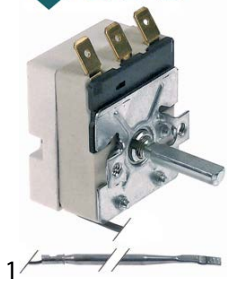

| | | | |
|--------------------|---|-----------------|------------------|
| GEV No. | 375835 | Ref. No. | 0H6241 215671 |
| description | thermostat t.max. 280°C temperature range 50-280°C 1-pole 1CO 16A probe ø 3.1mm probe L 160mm capillary pipe 1430mm capillary pipe isolated 800mm gland nut shaft ø 6x4.6mm shaft L 23mm shaft position upper rotation 270° | | |

55.18_ series



| | | | |
|--------------------|--|-----------------|------------------|
| GEV No. | 375950 | Ref. No. | 0E3691 0KB677 |
| description | thermostat t.max. 238°C temperature range 50-200°C 1-pole probe ø 3mm probe L 158mm capillary pipe 890mm capillary pipe isolated 760mm shaft ø 6x4.6mm shaft L 23mm shaft position upper rotation 270° | | |
| For models: | FCV31E3, 7CO30, CCO30G, ECO312CF, OTS100 | | |



| | | | |
|--------------------|--|-----------------|--|
| GEV No. | 375505 | Ref. No. | 0H2049 0H6124 OK0644 OK6907 OKA528 OKS225 1250212664007 375011 7FUJPE3000700 |
| description | thermostat t.max. 320°C temperature range 50-320°C 1-pole 1NO 16A probe ø 3mm probe L 160mm capillary pipe 870mm capillary pipe isolated gland nut shaft ø 6x4.6mm shaft L 23mm shaft position upper rotation 270° | | |

55.22_ series

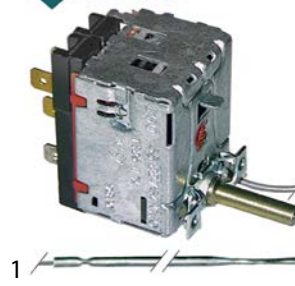

| | | | |
|--------------------|---|-----------------|------------------|
| GEV No. | 375147 | Ref. No. | 0H6138 213073 |
| description | thermostat t.max. 255°C temperature range 30-255°C 2-pole 2CO 16A probe ø 3.03mm probe L 147mm capillary pipe 1440mm capillary pipe isolated 1250mm gland nut shaft ø 6x4.6mm shaft L 23mm shaft position right rotation 270° | | |
| For models: | 5611-3-6 | | |



55.34_series



| | | | |
|--------------------|---|-----------------|---|
| GEV No. | 375143 | Ref. No. | 004911 01T01 0G0500 0G0953 0G4943 0H6220 0K0636 0K1540 0K3513 0K3852 0K3926 0K8428 0K9764 0K1132 0KQ973 0M0720 2061 214948 375143 |
| description | thermostat t.max. 110°C temperature range 32-110°C 3-pole 3NO 16A probe ø 6mm probe L 138mm capillary pipe 1480mm capillary pipe isolated 1100mm gland nut M9x1 shaft ø 6x4.6mm shaft L 23mm shaft position upper rotation 270° | | |
| For models: | SME350, SME700, SME350, SME700, BM35E6U, 7720-3/90.WB.GN1/1., 7520-3/85.WB.GN1/1., 7721-3/85.WB.GN2/1, 7520-3/90.WB.GN1/1., 7720-3/85.WB.GN1/1., 7521-3/85., 7521-3/90.WB.GN2/1., 7721-3/90.WB.GN2/1., 7521-3/85.WB.GN2/1.W, 7520-3, 7521-3, 7720-3, 7721-3, 9006-9, 9020-3, 9220-3-0, 9220-3-8 | | |

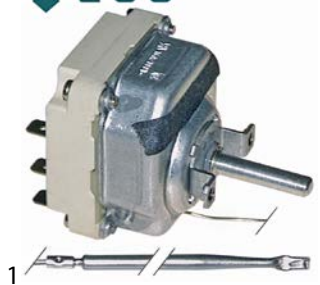

| | | | |
|--------------------|--|-----------------|--------|
| GEV No. | 390074 | Ref. No. | 051362 |
| description | thermostat t.max. 260°C temperature range 60-240/80-260°C 3-pole 3NO 10A probe ø 4mm probe L 130mm capillary pipe 1300mm capillary pipe isolated gland nut shaft ø 6x4.6mm | | |
| For models: | FCVE10, FCVE20, HBR/E801, HBR/E801 | | |

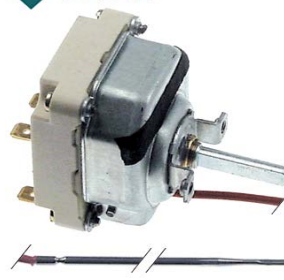

| | | | |
|--------------------|---|-----------------|------------------|
| GEV No. | 375587 | Ref. No. | 059235 375587 |
| description | thermostat t.max. 285°C temperature range 100-285°C 3-pole 3NO 16A probe ø 3mm probe L 219mm capillary pipe 1150mm capillary pipe isolated 1130mm gland nut shaft ø 6x4.6mm shaft L 23mm shaft position upper rotation 270° | | |
| For models: | BCF/E2, BR/E1FL, BR/E1FR, BR/E2FL, BR/E2FR, PCF/M2, PCF/M3, PCV/E2, PCV/E3, PCF/E2, PC/E2Q, PCF/E2Q, PCV/E2Q, PI/E1, PI/E2, PIF/E2, PIV/E2, PC/E2QE5, PCF/E2QE5, PI/E1E5, PI/E2E5, PIF/E2E5, PCF/E2E5, PCF/M2E5, PCF/M2A, PCF/M3A, OCF/M2, OCF/E2, OC/E2Q, OCF/E2Q, OI/E1, OI/E2, OIF/E2, TCF/M2, TCF/M3, TCF/E2, TCV/E2Q, TIF/E2, TCF/E2QE5, TI/E2E5, TCF/E2E5, TCF/M2E5, TCF/M2A, TCF/M3A, TCF/E2M0, TCF/E2QM0, TCF/E3QM0, TCF/E2M4, TCF/E2QM4, TCF/E3QM4...(Other models you can see in the webshop) | | |

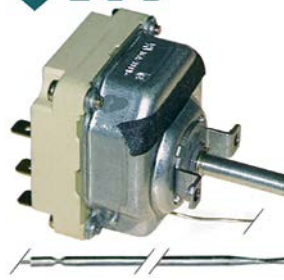

| | | | |
|--------------------|--|-----------------|---------------------------|
| GEV No. | 375183 | Ref. No. | 00285 004917 0K3517 |
| description | thermostat t.max. 298°C temperature range 50-298°C 3-pole 3NO 16A probe ø 3mm probe L 219mm capillary pipe 900mm capillary pipe isolated gland nut shaft ø 6x4.6mm shaft L 23mm shaft position upper rotation 318° | | |
| For models: | SRE350, SRE360, SRE370, SRE700, SRE710, SRE720, SRE350, SRE360, SRE370, SRE700, SRE710, SRE720 | | |



| | | | |
|--------------------|---|-----------------|--------|
| GEV No. | 375025 | Ref. No. | 0G3031 |
| description | thermostat t.max. 300°C temperature range 50-300°C 3-pole 3CO 16A probe ø 6mm probe L 77mm capillary pipe 2980mm capillary pipe isolated 2260mm gland nut shaft ø 6x4.6mm shaft L 23mm shaft position upper rotation 270° | | |



| | | | |
|--------------------|--|-----------------|--------|
| GEV No. | 375192 | Ref. No. | OK5018 |
| description | thermostat t.max. 300°C temperature range 50-300°C 3-pole 3NO 16A probe ø 3mm probe L 219mm capillary pipe 900mm capillary pipe isolated gland nut shaft ø 6x4.6mm shaft L 23mm shaft position upper rotation 270° | | |

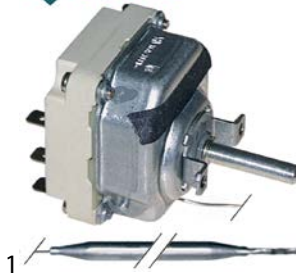

| | | | |
|----------------|--------|-----------------|--|
| GEV No. | 375038 | Ref. No. | OC1413 OG0955 OH6217 OK2827 OK3758 OK7279 OK9355 OK9763 OKC023 OKG661 OKI522 OKK117 OM0722 1025534054058 203494 232030 CODE:180706 |
|----------------|--------|-----------------|--|

description thermostat t.max. 300°C temperature range 50-300°C 3-pole 3NO 16A probe ø 6mm probe L 79mm capillary pipe 1740mm capillary pipe isolated 800mm gland nut shaft ø 6x4.6mm shaft L 23mm shaft position upper rotation 270°

For models: APABPETOOC, APABPGTOOC, APACPITOOC, APACPGTOOC, APABPIOOOC, APABPITOOOC, APACPIOOOC, APACPITOOOC, APABPGOOOC, APACPFOOOC, 7744-3/85.KB.(N), 7542-3/85., 7544-3/85.KB.(N), 7542-3/90.KB.(N), 7544-3/90.KB.(N), 7742-3/90.KB.(N), 7742-3/85.KB.(N), 7744-3/90.KB.(N), 7746-3/90.KB.(N), 7748-3/90.KB.(N), 7747-3/90.KB.(N), 7541-3/85.KB.(N), 7545-3/85.KB.(N), 7546-3/85.KB.(N), 7547-3/85.KB.(N), 7548-3/85.KB.(N), 7545-3/90.KB.(N), 7546-3/90., 7547-3/90.KB.(N), 7548-3/90.KB.(N), 7745-3/90.KB.(N), 7745-3/85.KB.(N), 7746-3/85.KB.(N), 7747-3/85.KB.(N), 7748-3/85.KB.(N), 7542-3/85.KB.DWD, 7544-3/85.KB.220V3, 7545-3/85.KB.DWD, 7742-3/85.KB.DWD.ETR, ZFT/E1, ZFT/E1E5, ZFT/E1M4, ZFT/E1M0, ZFT/E1L, ZFT/E1LE5, RFT/E1, RFT/E1E5, RFT/E1M4, RFT/E1M0, ZFT/E2...(Other models you can see in the webshop)

accessories for 375038

| | | | | |
|---|---|--------|-----------------|---|
|  | GEV No. | 110123 | Ref. No. | — |
| | knob thermostat t.max. 300°C ø 50mm shaft ø 6x4.6mm shaft flat upper black temperature range 50-300°C rotation 270° | | | |

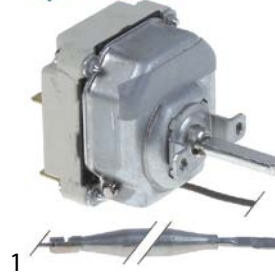

| | | | |
|----------------|--------|-----------------|------------------|
| GEV No. | 375453 | Ref. No. | 052916 OK2906 |
|----------------|--------|-----------------|------------------|

description thermostat t.max. 308°C temperature range 100-300°C 3-pole 3NO 16A probe ø 6mm probe L 75mm capillary pipe 1150mm capillary pipe isolated gland nut shaft ø 6x4.6mm shaft L 23mm rotation 270° probe material SS

For models: MR/E350D, MR/E350UK, MR/E360, MR/E700D, MR/E700UK, MR/E710, MR/E720, MR/E715, MR/E725, MR/E350, MR/E700, MR/E720D, RR/E350D, RR/E350UK, 7FTEF3R, RR/E360UK, RR/E700D, RR/E700UK, RR/E710, RR/E710UK, 7FTEC7L, 7FTEF3L, 7FTEF7L, 7FTEC7M, XR/E350D, XR/E350UK, T36EFT, XR/E700D, XR/E700UK, T71EFT, T79EFT, T35EFT, T70EFT, CR/E720, RR/E300, RRE702, RR/E300UK, RR/E311, RR/E700, RR/E700UK, RR/E711, RRV/E300, RRV/E300, RRV/E311, RRV/E700, RRV/E700, RRV/E711, HRS/E401, HRS/E401UK, HRS/E411...(Other models you can see in the webshop)



| | | | |
|----------------|--------|-----------------|------------------|
| GEV No. | 375412 | Ref. No. | 0A2206 OK2915 |
|----------------|--------|-----------------|------------------|

description thermostat t.max. 320°C temperature range 50-320°C 3-pole 3NO 16A probe ø 3.1mm probe L 226mm capillary pipe 1480mm capillary pipe isolated 1400mm gland nut shaft ø 6x4.6mm shaft L 23mm shaft position upper rotation 318°

For models: MG/E350D, MG/E350UK, MG/E700D, MG/E700UK, MG/E350, MG/E700, RG/E1, RG/E2, RGV/E1, RGV/E2, XG/E1, XG/E2, XGV/E1, XGV/E2, JG/E1, JG/E2, MG/E1, MG/E2, MGV/E1, MGV/E2, RG/E350D, RG/E350UK, RG/E700D, RG/E700UK, 7GLE03T, 7GLE07T, XG/E350D, XG/E350UK, XG/E700D, XG/E700UK, T35ECG, T70ECG, PG/E1, PG/E2, PG/E1E5, PG/E2E5, TG/E1, TG/E2, TG/E1E5, TG/E2E5



E-G-O

1

| | | | |
|--------------------|---|-----------------|--------|
| GEV No. | 375424 | Ref. No. | 052099 |
| description | thermostat t.max. 320°C temperature range 60-320°C 3-pole 3NO 16A probe ø 4mm probe L 128mm capillary pipe 1800mm capillary pipe isolated 1300mm gland nut shaft ø 6x4.6mm shaft L 23mm shaft position upper rotation 270° | | |
| For models: | MCF/GE705, MCF/GE1055, MCF/GE700, MCFGE1050, MCF/GE700D, MCFGE1050D, MCF/E700D, MCF/E700, MCF/E700UK, MCF/E1050D, MCF/E1050, MCF/GE1055UK, MIF/E700, MIF/E700D, MIF/E710, MIF/E710D, MCF/GE702, MCFGE1052, MCF/GE700, MCFGE1050, MF/E700, RCF/M2, RCF/M3, RCF/E2, RCF/E2MO, RCF/E2M4, RCVF/E3MO, RCVF/E3M4, RCF/E2E5, RIF/E2, MCF/E2Q, RCF/E2Q, XCF/M2, XCFM3, XCF/E2, XIF/E2, JCF/M2, JCFM3, JCF/E2, JIF/E2, MCF/M2, MCF/M3, MCF/E2, MCF/E2E5, MIF/E2, RCF/GE720, RCF/GE730, RCF/GE720, RCF/GE720, RCFE720...(Other models you can see in the webshop) | | |

E-G-O

2

| | | | |
|--------------------|--|-----------------|--------|
| GEV No. | 375026 | Ref. No. | 0M0725 |
| description | thermostat t.max. 350°C temperature range 100-350°C 3-pole 3NO 16A probe ø 6mm probe L 77mm capillary pipe 2430mm capillary pipe isolated 1100mm gland nut shaft ø 6x4.6mm shaft L 23mm shaft position upper rotation 270° | | |

safety thermostats

55.10/19_ series

E-G-O

1

| | | | |
|---|---|-----------------|---|
| GEV No. | 375250 | Ref. No. | 00427 004912 004931 0K3555 0K3610 7803 |
| description | safety thermostat capillary pipe 870mm probe ø 6mm 1-pole probe L 129mm 16A capillary pipe isolatedmm gland nut switch-off temp. 130°C probe SS | | |
| For models: | SME350, SME700, SME350, SME700, SMG350, SMG700, BM35E6U | | |
| spare parts for | 375250 | | |
|  | GEV No. | 551083 | Ref. No. 0A2187 |
| | cap for safety thermostat thread M8x1 | | |

E-G-O

1

| | | | |
|--------------------|---|-----------------|------------------|
| GEV No. | 375278 | Ref. No. | 056745 0K2963 |
| description | safety thermostat switch-off temp. 142°C 1-pole 16A probe ø 6mm probe L 74mm capillary pipe 900mm capillary pipe isolated 900mm gland nut probe | | |
| For models: | FCVG6-1, FCGV6-3, FCGV6-1UK, FCGV6-3UK, FCGV10-2, FCGV10-4, FCGV10-2, FCGV10-4D, FCGV10-2UK, FCGV10-4UK, FCGV10-2, FCGV10-4, FCGV20-2, FCGV20-4, FCGV20-2, FCGV20-4D, FCGV20-2UK, FCGV20-4UK, FCGV20-4, FCGV20-4D, FCGV/G6-1, ZOFV/G6-3, ZOFV/G102, ZOFV/G104, ZOFV/G202, ZOFV/G204, AFCV/G6-1, AFCV/G6-3, SCO/G6-3, AFCV/G101, AFCV/G103, SCO/G10-3, AFCV/G201, AFCV/G203, SCO/G20-3 | | |





55.13_series

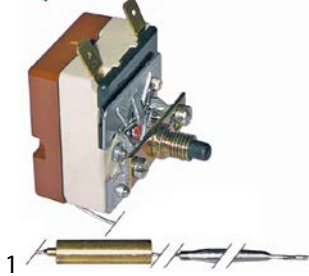

| | | | |
|--------------------|--|-----------------|--|
| GEV No. | 375854 | Ref. No. | 0E1108 0E5086 0K6886 0K6888 0K7886 0K8886 0KX072 |
| description | safety thermostat switch-off temp. 126°C 1-pole 16A probe ø 6mm probe L 129mm capillary pipe 1730mm capillary pipe isolated 800mm gland nut M9x1 shaft ø 6x4.6mm starting temperature 120°C probe | | |
| For models: | HCCS20W, HCCS20W, PW1EFL, PW1EFLF, PW1EFL/60HZ, PW2EFL, PW2EFLF, PW2EFL/60HZ, PW2VFL, WT830EFL, WT830EFLF, WT830EFL/60HZ, WT850, WT850EFL, WT850EFL/60HZ, WT850SFL, FT36ED, FT36ES, FT36VD, FT36VS, FT50ED, FT50ES, FT50VD, FT50VS, FT72ED, FT72ES, FT72VD, FT72VS, FT36EDT, FT36EST, FT36VDT, FT36VST, FT50EDT, FT50EST, FT50VDT, FT50VST, FT72EDT, FT72EST, FT72VDT, FT72VST, FT36EDTS, FT36ESTS, FT36VDTs, FT36VSTs, FT36ED, FT36ES, FT36VD, FT36VS, FT50ED, FT50ES...(Other models you can see in the webshop) | | |



| | | | |
|---|--|-----------------|--------------------------------------|
| GEV No. | 375044 | Ref. No. | 0H6141 0KE595 |
| description | safety thermostat switch-off temp. 178°C 1-pole 16A probe ø 4mm probe L 91mm capillary pipe 1730mm capillary pipe isolated 1600mm gland nut probe with sealing sleeve screw connection M8x1 sealing sleeve 8.6x32mm | | |
| For models: | 7573-3/85.KES100.(N), 7574-3/85.KES150.(N), 7575-3/85.KES250.(N), 7576-3/85.KES300.(N), 7573-3/90.KES100.(N), 7574-3/90.KES150.(N), 7575-3/90.KES250.(N), 7576-3/90.KES300.(N), 7573-3, 7574-3, 7575-3, 7576-3, 7577-3, 7773-3, 7773-3/85.KES100, 7773-3/90.KES100, 7774-3, 7774-3/85.KES150, 7774-3/90.KES150, 7775-3, 7775-3/85.KES250, 7775-3/90.KES250, 7776-3, 7776-3/85.KES300, 7776-3/90.KES300, 9100-3, 9104-3, 9113-3, 9300-3-0, 9300-3-8, 9304-3-0, 9304-3-8, 9313-3-0, 9313-3-8 | | |
| accessories for | 375044 | | |
|  | GEV No. | 102067 | Ref. No. 055033 0992014 |
| | nut thread M8x1 H 3mm brass Qty 1 pcs type SEF 1 | | |
|  | GEV No. | 551083 | Ref. No. 0A2187 |
| | cap for safety thermostat thread M8x1 | | |



| | | | |
|--------------------|--|-----------------|------------------|
| GEV No. | 375076 | Ref. No. | 0H6243 215673 |
| description | safety thermostat switch-off temp. 350°C 1-pole 1NO 16A probe ø 3.03mm probe L 141mm capillary pipe 830mm capillary pipe isolated 450mm gland nut probe SS | | |
| For models: | 5611-3-10, 5611-3-6, 5611-3-8, 5612-3-10, 5612-3-6, 5612-3-8, 5614-3-10, 5614-3-6, 5614-3-8 | | |

55.31_series



| | | | |
|--------------------|--|-----------------|------------------|
| GEV No. | 375571 | Ref. No. | 051454 0K2887 |
| description | safety thermostat switch-off temp. 350°C 3-pole 20A probe ø 6mm probe L 157mm capillary pipe 940mm capillary pipe isolated 890mm gland nut probe SS | | |
| For models: | MCF/GE705, MCF/GE1055, MCF/GE700, MCFGE1050, MCF/GE700D, MCFGE1050D, MCF/E700D, MCF/E700, MCF/E700UK, MCF/E1050D, MCF/E1050, MCF/GE1055UK, MIF/E700, MIF/E700D, MIF/E710, MIF/E710D, MCF/GE702, MCFGE1052, MCF/GE700, MCFGE1050, MBR/E710D, MBR/E700, MBR/E700UK, MBR/E716, MBR/E706, RCF/E700D, RCF/GE700D, RCF/E1050D, RCFGE1050D, RCF/E700UK, 74CE07F, 76CE10F, RCF/GE700, RC/G702, RC/G1052, RCF/GE702, RCF/GE1052, 74FE07F, RCF/GE1051, 7BRE60XN, 7BRE60X, RBR/E700UK, RBR/E716, RBR/E706, XCF/GE700D, M70GCK/E, M70ECK/E, XCF/E1050, XCF/E700UK, XMIF/E710...(Other models you can see in the webshop) | | |





| | | | |
|--------------------|---|-----------------|------------------|
| GEV No. | 375377 | Ref. No. | 051643 OK2892 |
| description | safety thermostat switch-off temp. 350°C 3-pole 3NC 1x20/2x0.5A probe ø 6mm probe L 157mm capillary pipe 1230mm capillary pipe isolated 1100mm gland nut probe | | |
| For models: | MR/G721, MR/G1071, MR/G1070, MR/G720, MR/G725, MR/G1075, MR/G726, MR/G1076, RR/G720D, 7FTGC7L, 7FTGC1L, RR/G1070D, 7FTGC7M, RR/G1076, XR/G720D, XR/G1070D, T79GFT, T109GFT, HBR/G820, HBR/G825, ABR/G820, ABR/G825, HQN/G1225, HBR/G803, HBR/G804, HBR/G803, HBR/G804, HBR/G803, HBR/G1003, HBR/G1003, HBR/G1004, HBR/G803, HBR/G804, HBR/G1013, HBR/G803, HBR/G804, HBR/G1003, HBR/G1013, HQN/G1225, HBR/G1004 | | |



| | | | |
|--------------------|---|-----------------|--------|
| GEV No. | 390920 | Ref. No. | 0C2983 |
| description | safety thermostat switch-off temp. 140°C 3-pole 3CO 20A probe ø 6mm probe L 88mm capillary pipe 900mm capillary pipe isolated 770mm gland nut probe | | |
| For models: | PPI/E260P, OPI/E260P, TPI/E260P, FCZ061EAA, FCZ101EAA, FCZ102EAA, FCZ061EAH, FCZ101EAH, FCZ061EAN, FCZ101EAN, FCZ201ETA, FCZ202ETA, FCZ201ETH, FCZ201ETN, FCZ061EBA, FCZ101EBA, FCZ102EBA, FCZ061EBH, FCZ101EBH, FCZ061EBN, FCZ101EBN, FCZ061EBC, FCZ101EBC, FCZ201EBC, FCZ201EBA2, FCZ202EBA2, FCZ201EBH2, FCZ201EBN2, FCZ201EBC2, FCZ061ECA, FCZ101ECA, FCZ102ECA, FCZ061ECH, FCZ101ECH, FCZ061ECN, FCZ101ECN, FCZ201ECA2, FCZ202ECA2, FCZ201ECH2, FCZ201ECN2, AOS061EAA1, AOS101EAA1, AOS102EAA1, AOS201EAA1, AOS202EAA1, AOS061EAH1, AOS101EAH1, AOS201EAH1, AOS061EAN1, AOS101EAN1...(Other models you can see in the webshop) | | |

55.32_series



| | | | |
|--------------------|---|-----------------|------------------|
| GEV No. | 375394 | Ref. No. | OK3967 375015 |
| description | safety thermostat switch-off temp. 135°C 3-pole 1CO/2NC 20A probe ø 6mm probe L 73mm capillary pipe 1490mm capillary pipe isolated 1350mm gland nut M9x1 probe SS | | |



| | | | |
|--------------------|---|-----------------|--------|
| GEV No. | 375170 | Ref. No. | 002711 |
| description | safety thermostat switch-off temp. 150°C 1-pole 20A probe ø 6mm probe L 74mm capillary pipe 1700mm capillary pipe isolated 1100mm gland nut probe | | |
| For models: | FDV40G, FDV40GZ, FDV40GA, FDV20G, FDV20GZ, FDV20GA, FCV/G10L3, FCVG10L3T, FCVG102L3, FCV/G20L3, FCVG202L3, FCVG10L3J, FCVG102L3J, FCV/G10L6JAP, FCV/G102/1L6JAP, FCV/G61/1, FCV/G6L4, FCV/G10L6, FCV/G102/1L6, FCV/G20L6, FCVG202L6, FCV/G101/1, FCV/G102/1, FCV/G201/1, FCV/G202/1, FCS061G4, FCS101G4, FCS101G4DT, FCS101GP9J, FCS101G49J, FCS101GP, FCS102G4, FCS102GA9J, FCS102G49J, FCS102GP, FCS201G4, FCS201GP, FCS202G4, FCS202GP, FCS101GX9J, FCS101GX, FCS102GX9J, FCS102GX, FCS201GX, FCS202GX, FCF/E4-OLD, FCF/E4D, FCFE4PH, 5711-2-6, 5711-2-7...(Other models you can see in the webshop) | | |



| | | | |
|--------------------|--|-----------------|--------|
| GEV No. | 375209 | Ref. No. | 004862 |
| description | safety thermostat switch-off temp. 140°C 3-pole 20A probe ø 6mm probe L 89mm capillary pipe 900mm capillary pipe isolated 900mm gland nut probe SS | | |
| For models: | FDV40E, FDV40EL, FDV20E, FDV20EL, RPI/E240, RPI/E260, RPI/E260P, XPI/E240, XPI/E260, XPI/E260P, JPI/E240, JPI/E260, MPI/E240, MPI/E260, MPI/E260P, KPI/E10, KPI/E15, KPI/E15A, KPI/E06, KPI/G18, KPI/G25, KPI/E15H, KPI/E10H, HPN/EI815D, HPN/EI810, HPN/EI815, HPA/EI825, HPNS/EI815, HPNS/EI815D, QPI/E10, QPI/E15, QPI/E06, QPI/G18, QPI/G25, QPI/E15H, QPI/E10H, ZPN/EI815D, ZPN/EI810, ZPN/EI815, ZPNS/EI815, ZPNS/EI815D, WB/E1, WB/E2, WPI/E10, WPI/E15, WPI/E15A, WPI/E06, WPI/E15H, WPI/E10H, APN/EI810...(Other models you can see in the webshop) | | |

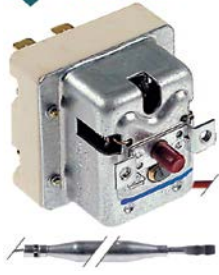

| | | | |
|--------------------|---|-----------------|----------------------------|
| GEV No. | 375657 | Ref. No. | 005319 005681 0C1147 |
| description | safety thermostat switch-off temp. 150°C 2-pole 1x20/1x0.5A probe ø 6mm probe L 74mm capillary pipe 1700mm capillary pipe isolated 1100mm gland nut probe SS | | |
| For models: | FCZ061GAG, FCZ101GAG, FCZ102GAG, FCZ201GAG, FCZ202GAG, FCZ061GAD, FCZ101GAD, FCZ102GAD, FCZ201GAD, FCZ202GAD, FCZ101GTG, FCZ102GTG, FCZ201GTG, FCZ202GTG, FCZ101GTD, FCZ102GTD, FCZ201GTD, FCZ202GTD, FCZ061GBG, FCZ101GBG, FCZ102GBG, FCZ201GBG, FCZ202GBG, FCZ061GBD, FCZ101GBD, FCZ102GBD, FCZ201GBD, FCZ202GBD, FCZ061GBI, FCZ101GBI, FCZ201GBI, FCZ101GBG2, FCZ102GBG2, FCZ201GBG2, FCZ202GBG2, FCZ101GBD2, FCZ102GBD2, FCZ201GBD2, FCZ202GBD2, FCZ101GBI2, FCZ102GBI2, FCZ201GBI2, FCZ061GCG, FCZ061GCD, FCZ101GCG2, FCZ102GCG2, FCZ201GCG2, FCZ202GCG2, FCZ101GCD2, FCZ102GCD2...(Other models you can see in the webshop) | | |



| | | | |
|--------------------|--|-----------------|------------------|
| GEV No. | 375789 | Ref. No. | 005320 005680 |
| description | safety thermostat switch-off temp. 338°C 2-pole 20A probe ø 11mm probe L 16mm capillary pipe 900mm capillary pipe isolated 900mm gland nut screw-in probe probe thread M14x1 | | |
| For models: | FCVG6L3CJ, FCV/G6L3C, FCV/G61/1, FCV/G61/1, FCV/G61/1, FCV/G61/1, FCV/G6L3CT, FCVG6L3CJ, 5711-2-8CH, 5711-2-10CH, 5721-2-7, 5721-2-10, 5711-3-8CH, 5711-3-10CH, 5712-3-8CH, 5712-3-10C, 5717-3-8M, 5717-3-8C, 5717-3-8M, 5712-2-10F, 5712-2-10S, 5714-2-10F, 5714-2-10S, 5711-3-10F, 5711-3-10S, 5712-3-10F, 5712-3-10S, 5714-3-10F, 5714-3-10S, 5702-2-2, 5702-2-3, 5704-2-2, 5704-2-3, 5707-2-2, 57074-2-3, 5701-3-2, 5701-3-3, 5702-3-2, 5702-3-3, 5704-3-2, 5704-3-3, 5707-3-2, 5707-3-3, ECV/G6T4C, ECV/G61/1, ECV/G61/1, ECV/E101GP, RCV061G2, ACV/G6C3C, ZCV/G6T4C, ZCV/G61/1 | | |



| | | | |
|--------------------|--|-----------------|--------|
| GEV No. | 375649 | Ref. No. | 005815 |
| description | safety thermostat switch-off temp. 160°C 3-pole 20A probe ø 6mm probe L 87mm capillary pipe 890mm capillary pipe isolated 880mm gland nut probe SS | | |



| | | | |
|--------------------|---|-----------------|--|
| GEV No. | 375455 | Ref. No. | 002599 002730 0F0057 0K0515 0K8486 911986 |
| description | safety thermostat switch-off temp. 350°C 1-pole 16A probe ø 11mm probe L 16mm capillary pipe 900mm capillary pipe isolated 900mm gland nut probe screw-in probe probe thread M14x1 | | |
| For models: | FCV/G10L3, FCVG10L3T, FCVG102L3, FCV/G20L3, FCVG202L3, FCVE6L3J, FCV/E10L3JAP, FCV/E102/1L3JAP, FCV/E10L6JAP, FCV/E102/1L6JAP, FCVG10L3J, FCVG102L3J, FCV/G10L6JAP, FCV/G102/1L6JAP, FCV/G10L2, FCV/E10L2, FCV/G61/1, FCV/E10L3, FCV/E6L3, FCV/E102/1L3, FCV/E20L3, FCVE202L3, FCV/E6L4, FCV/G10L6, FCV/E10L6, FCV/G102/1L6, FCV/E102/1L6, FCV/G20L6, FCV/E20L6, FCVG202L6, FCVE202L6, FCV/E101/1, FCV/G101/1, FVC/E101/1, FCV/G102/1, FVC/E102/1, FCV/G201/1, FVC/E201/1, FCV/G202/1, FVC/E202/1, FCF/E6-0, FCFE101-0, FCFE102-0, FCFE201-0, FCFE202-0, FCF061ELN, FCF101ELN, FCF6EHOR, FCF061ENS, FCF101ENS...(Other models you can see in the webshop) | | |



| | | | |
|--------------------|--|-----------------|--------|
| GEV No. | 375659 | Ref. No. | 007042 |
| description | safety thermostat switch-off temp. 338°C 2-pole 1x20/1x0.5A probe ø 6mm probe L 53mm capillary pipe 900mm capillary pipe isolated 900mm gland nut probe screw-in probe probe thread M10x1 | | |
| For models: | FCZ061EAA, FCZ101EAA, FCZ102EAA, FCZ201EAA, FCZ202EAA, FCZ061EAH, FCZ101EAH, FCZ201EAH, FCZ061EAN, FCZ101EAN, FCZ201EAN, FCZ061ETA, FCZ101ETA, FCZ102ETA, FCZ201ETA, FCZ202ETA, FCZ061ETH, FCZ101ETH, FCZ201ETH, FCZ061ETN, FCZ101ETN, FCZ201ETN, FCZ061GAG, FCZ101GAG, FCZ102GAG, FCZ201GAG, FCZ202GAG, FCZ061GAD, FCZ101GAD, FCZ102GAD, FCZ201GAD, FCZ202GAD, FCZ101GTG, FCZ102GTG, FCZ201GTG, FCZ202GTG, FCZ101GTD, FCZ102GTD, FCZ201GTD, FCZ202GTD, FCZ061EBA, FCZ101EBA, FCZ102EBA, FCZ201EBA, FCZ202EBA, FCZ061EBH, FCZ101EBH, FCZ201EBH, FCZ061EBN, FCZ101EBN...(Other models you can see in the webshop) | | |

| | | | |
|--------------------|--|-----------------|----------------------------|
| GEV No. | 390141 | Ref. No. | 006826 0H6135 0KI518 |
| description | safety thermostat switch-off temp. 350°C 3-pole 3NC 20A probe ø 6mm probe L 77mm capillary pipe 1490mm capillary pipe isolated 800mm gland nut probe SS | | |
| For models: | APABPETOOC, APABPGTOOC, APACPITOOC, APACPGTOOC, APABPI- OOOC, APABPITOOC, APACPIOOC, APACPITOOC, APRBPETOOC, APR- BPEOOOB, APRBPPTOOC, APRBPPTOOC, APRBPPTOOC, APRBPPTOOC, APRCPEOOOB, APRCPGTOOC, APRCPGTOOC, APRCPGTOOC, APRCP- TOOC, APRCPPTOOC, APABPGOOOC, APACPFOOOC, 7731-3/85.GRPL. VCHR., 7744-3/85.KB.(N), 7531-3/85., 7531-3/90.GRPL.(N), 7542-3/85., 7544-3/85.KB.(N), 7542-3/90.KB.(N), 7544-3/90.KB.(N), 7742-3/90. KB.(N), 7742-3/85.KB.(N), 7744-3/90.KB.(N), 7746-3/90.KB.(N), 7748- 3/90.KB.(N), 7747-3/90.KB.(N), 7541-3/85.KB.(N), 7545-3/85.KB.(N), 7546-3/85.KB.(N), 7547-3/85.KB.(N), 7548-3/85.KB.(N), 7545-3/90. KB.(N), 7546-3/90., 7547-3/90.KB.(N), 7548-3/90.KB.(N), 7745-3/90. KB.(N), 7745-3/85.KB.(N), 7746-3/85.KB.(N), 7747-3/85.KB.(N), 7748- 3/85.KB.(N)...(Other models you can see in the webshop) | | |



| | | | |
|--------------------|---|-----------------|--------------------------------------|
| GEV No. | 375579 | Ref. No. | 003594 053980 057442 0G2269 |
| description | safety thermostat switch-off temp. 360°C 1-pole 0.5A probe ø 6mm probe L 74mm capillary pipe 1500mm capillary pipe isolated 1500mm gland nut probe | | |
| For models: | MBR/G701, MBR/G706, MBR/G701UK, MBR/G751, MBR/G756, RBR/ G2FM, RBR/G2IM, XBR/G2FM, XBR/G2IM, JBR/G2FM, MBR/G2FM, MBR/ G2IM, 7BRG60, 7BRG60X, RBR/G701UK, RBR/G751, RBR/G756, XBR/ G701, M70GBP, XBR/G751, XBR/G756, PBR/G2FM, PBR/G2IM, OBR/ G2FM, OBR/G2IM, TBR/G2FM, TBR/G2IM, HR/G420D, HR/G820D, HR/ G420, HR/G820, HR/G821, HBR/G800, HBR/G805, HBR/G801, HBR/ G806, HBR/G810, HBR/G815, HBR/G811, HBR/G816, HBR/G800D, HBR/ G805D, HBR/G801D, HBR/G806D, HBR/G810D, HBR/G815D, HBR/ G811D, HBR/G816D, HBR/E800, HBR/E805...(Other models you can see in the webshop) | | |

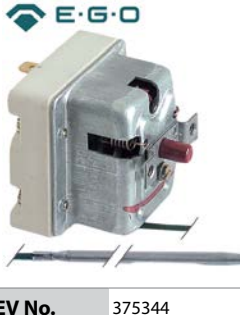

| | | | |
|--------------------|---|-----------------|--------|
| GEV No. | 375344 | Ref. No. | OPRE75 |
| description | safety thermostat switch-off temp. 360°C 1-pole 0.5A probe ø 4mm probe L 120mm capillary pipe 1500mm capillary pipe isolated 1500mm gland nut probe | | |



| | | | |
|--------------------|---|-----------------|--------|
| GEV No. | 375562 | Ref. No. | 004269 |
| description | safety thermostat switch-off temp. 360°C 3-pole 20A probe ø 4mm probe L 120mm capillary pipe 900mm capillary pipe isolated 900mm gland nut probe SS | | |
| For models: | RCF/M2, RCF/M3, RCF/E2, RCF/E2MO, RCF/E2M4, RCVF/E3MO, RCVF/ E3M4, RCF/E2E5, RBR/E2FM, RBR/E2IM, RMV/E1C, RMV/E2C, RMV/ G1C, RMV/G2C, RIF/E2, MCF/E2Q, RCF/E2Q, XCF/M2, XCFM3, XCF/ E2, XBR/E2FM, XBR/E2IM, XMV/E1C, XMV/E2C, XMV/G1C, XMV/G2C, XIF/E2, JCF/M2, JCFM3, JCF/E2, JBR/E2FM, JMV/E1C, JMV/E2C, JIF/E2, MCF/M2, MCF/M3, MCF/E2, MCF/E2E5, MBR/E2FM, MBR/E2IM, MMV/ E1C, MMV/E2C, MMV/G1C, MMV/G2C, MIF/E2, PBR/E2FM, PBR/E2IM, PMV/G1C, PMV/G2C, PMV/E1C...(Other models you can see in the webshop) | | |



accessories

| | | | |
|---|--|-----------------|--------|
|  | | | |
| 1 | | | |
| GEV No. | 551083 | Ref. No. | 0A2187 |
| description | cap for safety thermostat thread M8x1 | | |
| For models: | MBR/E710D, MBR/E700, MBR/E700UK, MBR/G701, MBR/G706, MBR/G701UK, MBR/G751, MBR/G756, MBR/E716, MBR/E706, 7BRE60XN, 7BRE60X, RBR/E700UK, 7BRG60, 7BRG60X, RBR/G701UK, RBR/G751, RBR/G756, RBR/E716, RBR/E706, XBR/E710D, M70EBP, XBR/E710, XBR/G701, M70GBP, XBR/G701UK, XBR/G751, XBR/G756, CBR/G700, CBR/E700, XBR/E716, XBR/E706, HFR/E410, HFR/E810, HFR/E411, HFR/E412, HFR/E418, HFR/E818, HBR/G800, HBR/G805, HBR/G810, HBR/G815, HBR/G811, HBR/G816, HBR/G800UK, HBR/G821UK, ZFR/E410, ZFR/E810, ZFR/E411, ZFR/E412...(Other models you can see in the webshop) | | |

control thermostats with operation switch

| | | | |
|--|---|-----------------|--------|
| 55.34_ series | | | |
|  | | | |
| 1 | | | |
| GEV No. | 375570 | Ref. No. | 0K0662 |
| description | thermostat t.max. 470°C temperature range 100-470°C 1-pole 1NO 16A probe ø 3.9mm probe L 228mm capillary pipe 1110mm capillary pipe isolated 600mm gland nut shaft ø 6x4.6mm shaft L 24mm shaft position upper rotation 270° outer switch 2NO | | |
| For models: | 7511-3/85.KF.(N), 7512-3/85.KF.BO.(N), 7511-3/90.KF.(N), 7512-3/90.KF.BO.(N), 7711-3/85.KF.(N), 7711-3/90.KF.(N), 7511-3, 7512-3, 7711-3 | | |

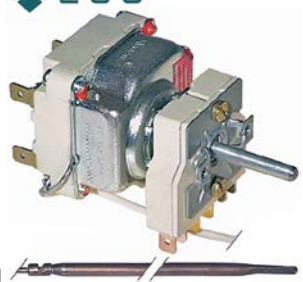
| | | | |
|---|--|-----------------|---|
|  | | | |
| 1 | | | |
| GEV No. | 375246 | Ref. No. | 01R77 01T05 01T09 0G0956 0K0496 0M0724 0M0728 |
| description | thermostat t.max. 645°C temperature range 100-615/645°C 2-pole 2NO 16A probe ø 4mm probe L 230mm capillary pipe 1100mm capillary pipe isolated 600mm gland nut shaft ø 6x4.6mm shaft L 25mm shaft position lower rotation 270° outer switch 2NO probe material copper | | |
| For models: | 7508-3/85., 7506-3/85.HE.CER.2KZ, 7507-3/85., 7506-3/90.HE.CER.2KZ, 7507-3/90.HE.CER.4KZ, 7508-3/90.HE.CER.BO., 7706-3/85.HE.CER.2KZ, 7707-3/85.HE.4KF.CER, 7706-3/90.HE.CER.2KZ, 7707-3/90.HE.4KF.CER, 7508-3/85.HE.CER.BO., 7508-3/85.HE.CER.BO., 7506-3/85.HE.CER.2KZ, 7506-3/85.HE.CER.2KZ, 7508-3/85.HE.CER.BO., 7507-3/85.HE.CER.4KZ, 7506-3/85.HE.CER.2KZ, 7510-3/85.HE.CER.6KZ, 7507-3/85.HE.CER.4KZ, 7507-3/85.HE.CER.4KZ, 7506-3, 7507-3, 7508-3, 7510-3/90.HE.CER.6KZ, 7706-3, 7707-3, 9012-3, 9211-3-0, 9211-3-8 | | |

IMIT / TEMPOMATIC / ARTERMO

| | | | |
|--|---|-----------------|--------|
| safety thermostats | | | |
|  | | | |
| 1 | | | |
| GEV No. | 375941 | Ref. No. | 053012 |
| description | safety thermostat switch-off temp. 238°C 1-pole 1NC 16A probe ø 5mm probe L 100mm capillary pipe 1050mm capillary pipe isolated-mm gland nut 250V | | |
| For models: | FE250D, FE250S, FEC/250D, FEC/250S, HFR/G1680, HFR/E1680, HFR/G2480, HFR/E2480 | | |

control thermostats with actual value

| | | | |
|--|---|-----------------|------------------|
|  | | | |
| 1 | | | |
| GEV No. | 379722 | Ref. No. | 0K7631 0KB607 |
| description | thermostat t.max. 120°C temperature range 0-120°C 1-pole 1CO 10A probe ø 8.5mm probe L 32mm capillary pipe 1600mm mounting ø 60mm | | |
| For models: | HC-AR, HC-CS | | |

accessories

| | | | |
|---|---|-----------------|--------|
| fitting parts | | | |
|  | | | |
| 1 | | | |
| GEV No. | 697994 | Ref. No. | 002774 |
| description | bracket for probe | | |
| For models: | RR/E1CL, RR/E2CL, RRV/E1CL, RRV/E2CL, RR/E2CM, XR/E1CL, XR/E2CL, XRV/E1CL, XRV/E2CL, JR/E1CL, JR/E2CL, JRV/E1CL, JRV/E2CL, MR/E1CL, MR/E2CL, MRV/E1CL, MRV/E2CL, MR/E2CM, FCV/G10L3, FCVG10L3T, FCVG102L3, FCV/G20L3, FCVG202L3, FCVG10L3J, FCVG102L3J, FCV/G10L6JAP, FCV/G102/1L6JAP, FCV/G61/1, FCV/G61/1, FCV/G61/1, FCV/G6L4, FCV/G10L6, FCV/G102/1L6, FCV/G20L6, FCVG202L6, FCV/G101/1, FCV/G102/1, FCV/G201/1, FCV/G202/1, FCF/E4-OLD, FCF/E4D, FCFE4PH, 5711-2-6, 5711-2-7, 5711-2-8, 5711-2-10, 5711-2-8CH, 5711-2-10CH, 5712-2-6, 5712-2-7...(Other models you can see in the webshop) | | |

| probe clips | | | |
|---|---|----------|------------------|
| clamps | | | |
|  | | | |
| 1 | | | |
| GEV No. | 550401 | Ref. No. | 057519 066823 |
| description | probe clip for pipe \varnothing 9mm for probe \varnothing 6mm Qty 1 pcs | | |
| For models: | MCF/G1090, MCF/G1095, MCF/G995, MG/E350D, MG/E350UK, MG/E700D, MG/E700UK, MG/E350, MG/E700, RCF/G2, RCF/G3, RCF/G9, RG/E1, RG/E2, RGV/E1, RGV/E2, RTF/G2, RSF/G2, RSF/G3, MCF/G2A, MCF/G3A, XCF/G2, XCF/G3, XCF/G9, XG/E1, XG/E2, XGV/E1, XGV/E2, XTF/G2, XSF/G2, XSF/G3, JCF/G2, JCF/G3, JG/E1, JG/E2, JTF/G2, MCF/G2, MCF/G3, MCF/G9, MG/E1, MG/E2, MGV/E1, MGV/E2, MTF/G2, MSF/G2, MSF/G3, RCF/G1095, RG/E350D, RG/E350UK, RG/E700D... (Other models you can see in the webshop) | | |

| gland nut accessories | | | | |
|---|---|----------|----------|---|
| bolts with slot | | | | |
|  | | | | |
| 1 | | | | |
| GEV No. | 520243 | Ref. No. | 027061 | |
| description | bolt with slot thread M9x1 Qty 10 pcs nickel-plated brass | | | |
| accessories for | 520243 | | | |
|  | GEV No. | 510591 | Ref. No. | — |
| | washer with slot ED \varnothing 8.8mm slit width 1.2mm Qty 10 | | | |
|  | GEV No. | 510592 | Ref. No. | — |
| | gasket \varnothing 8x8.7mm Qty 10 pcs slotted silicone | | | |



| connecting bows | | | |
|---|---|----------|--|
|  | | | |
| 1 | | | |
| GEV No. | 550060 | Ref. No. | 006712 01103 01P01 054376 0A2039 0H6283 0KQ972 0M0643 |
| description | connecting bow long for thermostat Qty 1 pcs | | |
| For models: | RF/E1S08, RF/E2D08, RFR/E1S08, RFR/E2D08, RFR/E1S14, RFR/E2D14, RF/E1S07, RF/E2D07, RFR/E1S07, RFR/E2D07, XF/E1S08, XF/E2D08, XFR/E1S08, XFR/E2D08, XFR/E1S14, XFR/E2D14, XF/E1S07, XF/E2D07, XFR/E1S07, XFR/E2D07, JF/E1S08, JF/E2D08, JFR/E1S08, JFR/E2D08, JFR/E1S14, JFR/E2D14, JF/E1S07, JF/E2D07, JFR/E1S07, JFR/E2D07, MF/E1S08, MF/E2D08, MFR/E1S08, MFR/E2D08, MFR/E1S14, MFR/E2D14, MF/E1S07, MF/E2D07, MFR/E1S07, MFR/E2D07, PF/E1S07, PF/E2D07, PFR/E1S07, PFR/E2D07, PF/E1S07E5, PFRE2D07E5, OF/E1S07, OFR/E1S07, OFR/E2D07, TF/E1S07... (Other models you can see in the webshop) | | |

|  | | | |
|---|---|----------|--|
| 1 | | | |
| GEV No. | 550059 | Ref. No. | 0A2205 0G0270 0H6775 0K5001 0KM937 0KT779 253566 |
| description | connecting bow short for switch Qty 1 pcs | | |
| For models: | BR/E1FL, BR/E1FR, BR/E2FL, BR/E2FR, RR/E1FL, RR/E1FR, RR/E1CL, RR/E2FL, RR/E2FM, RR/E2CL, RRV/E1FL, RRV/E1FR, RRV/E1CL, RRV/E2FL, RRV/E2FM, RRV/E2CL, RR/E2CM, RG/E1, RG/E2, RGV/E1, RGV/E2, XR/E1FL, XR/E1FR, XR/E1CL, XR/E2FL, XR/E2FM, XR/E2CL, XRV/E1FL, XRV/E1FR, XRV/E1CL, XRV/E2FL, XRV/E2FM, XRV/E2CL, XG/E1, XG/E2, XGV/E1, XGV/E2, JR/E1FL, JR/E1FR, JR/E1CL, JR/E2FL, JR/E2FM, JR/E2CL, JRV/E1FL, JRV/E1FR, JRV/E1CL, JRV/E2FL, JRV/E2FM, JRV/E2CL, JG/E1... (Other models you can see in the webshop) | | |



switches and momentary switches

rocker/momentary rocker switches

| 30x11mm | | | |
|---|---|----------|--------|
|  | | | |
| 1 | | | |
| GEV No. | 301012 | Ref. No. | 004110 |
| description | rocker switch mounting measurements 30x11mm green 1NO/indicator light 250V 16A 0-1 connection male faston 6.3mm ambient temperature max. 85/125°C protection IP40 | | |
| For models: | ZCMDG6, ZCMDG4, ZCMDG9 | | |



| 30x22mm | | | | |
|---|---|----------|--------------------|--------|
|  | | | | |
| 1 | | | | |
| GEV No. | 301003 | Ref. No. | 004158 91310085 | |
| description | rocker switch mounting measurements 30x22mm green 2NO 250V 16A illuminated 0-1 connection male faston 6.3mm ambient temperature max. 125/55°C protection IP65 | | | |
| For models: | ZCMDE6, ZCBDE12, ZCMMME6, ZCBME12, ZCMDE4, ZCBDE8, ZCMMME4, ZCBME8, ZCMDE9, ZCBDE18, ZCMMME9, ZCBME18, ZCBDE8, ZCBDE12, ZCBDE18, FFPS16, FFPS32, PDE830, PDE1230, PDE12L30, PDE1830, PDE835, PDE1235, PDE12L35, PDE1835, PME430, PME630, PME6L30, PME930, PME435, PME635, PME6L35, PME935, PME830, PME1230, PME12L30, PME1830, PME835, PME1235, PME12L35, PME1835, PDG433, PDG633, PDG933 | | | |
| accessories for | 301003 | | | |
|  | GEV No. | 301036 | Ref. No. | 002150 |
| | protective cover internal size 30x22mm for rocker switch mounting measurementsmm | | | |







| | | | |
|---|---|-----------------|------------------------------|
|  | | | |
| 1 | | | |
| GEV No. | 301001 | Ref. No. | 005899 0C4924 91310090 |
| description | rocker switch mounting measurements 30x22mm red 2NO 250V 16A illuminated 0-I connection male faston 6.3mm ambient temperature max. 125/55°C protection IP65 | | |
| For models: | ZCBDG8, ZCBDG12, ZCBDG18 | | |
| accessories for | 301001 | | |
|  | GEV No. | 301036 | Ref. No. 002150 |
| | protective cover internal size 30x22mm for rocker switch mounting measurementsmm | | |



| | | | |
|---|--|-----------------|--------|
|  | | | |
| 1 | | | |
| GEV No. | 301036 | Ref. No. | 002150 |
| description | protective cover internal size 30x22mm for rocker switch mounting measurementsmm | | |
| For models: | HBR/G801, HBR/G806, HBR/G811, HBR/G816, HBR/G801D, HBR/G806D, HBR/G811D, HBR/G816D, HBR/E801, HBR/E806, HBR/E811, HBR/E816, ZBR/G801, ZBR/G806, ZBR/G811, ZBR/G816, ZBR/G801D, ZBR/G806D, ZBR/G811D, ZBR/G816D, ZR/G413, BR/E806, ZBR/E811, ZBR/E816, ABR/G801, ABR/G806, ABR/G811, ABR/G816, ABR/G801D, ABR/G806D, ABR/G811D, ABR/G816D, ABR/E801, ABR/E806, ABR/E811, ABR/E816 | | |

| | | | |
|---|--|-----------------|--------|
|  | | | |
| 1 | | | |
| GEV No. | 301251 | Ref. No. | OKM977 |
| description | rocker switch mounting measurements 30x22mm green 2NO 250V 16A illuminated lighting connection male faston 6.3mm ambient temperature max. 85°C protection IP40 | | |



| | | | |
|---|---|-----------------|------------------------|
| blank | | | |
|  | | | |
| 1 | | | |
| GEV No. | 345390 | Ref. No. | 054547 055014 |
| description | momentary rocker switch mounting measurements 30x22mm red 1NC 230V 16A illuminated connection male faston 6.3mm ambient temperature max. 125/55°C protection IP65 with cover cap | | |
| For models: | FCFG10, FCFG10D, FCFG10NL, FCFG20, FCFG20D, FCFG20F, PFCFG20, FCFG40, FCFG41, FCFG40D, FCFG40F, PFCFG40F, FCFG20J, FCFG20J, FCFG40J, FCFG40J, FCFG20J, FCFG20J, FCFG41J, FCFG40J, FCFG101, FCFG201, FCFG202, FCFG202, FF/G20, FF/G40, COCO10G, COCO20G, 4236N, ZOFCE/G10D, ZOFCE/G20D | | |
| accessories for | 345390 | | |
|  | GEV No. | 301036 | Ref. No. 002150 |
| | protective cover internal size 30x22mm for rocker switch mounting measurementsmm | | |

| | | | |
|--|---|-----------------|---|
| labelled | | | |
|  | | | |
| 1 | | | |
| GEV No. | 300125 | Ref. No. | 053810 056702 056703 081680 085609 0HA083 0K8650 0KM979 0PE186 20528 23327 9020528 |
| description | rocker switch mounting measurements 30x22mm green 2NO 230V 16A 0-I connection male faston 6.3mm ambient temperature max. 125/55°C protection IP65 with cover cap | | |
| For models: | WMMGHUK, WMMHPLUK, MTC1200P, MTC1400P, MTC1600P, MTC1800P, MTC2000P, MTC1210P, MTC1410P, MTC1610P, MTC1810P, MTC2010P, MTC1200P, MTC1400P, MTC1600P, MTC1800P, MTC2000P, MSR1207, MSR1407, MSR1607, MSR1807, MSR2007, MSR1217, MSR1417, MSR1617, MSR1817, MSR2017, MSRP1207, MSRP1407, MSRP1607, MSRP1807, MSRP2007, TC1200E, TC1210E, TC1400E, TC1410E, TC1600E, TC1610E, TC1800E, TC1810E, TC2000E, TC2010E, TCD1400E, TCD1600E, TCD1800E, TCD2000E, TC1200FB, TC1210FB, TC1400FB, TC1410FB...(Other models you can see in the webshop) | | |
| accessories for | 300125 | | |
|  | GEV No. | 301036 | Ref. No. 002150 |
| | protective cover internal size 30x22mm for rocker switch mounting measurementsmm | | |

| | | | |
|---|--|-----------------|------------------------|
| with symbol | | | |
|  | | | |
| 1 | | | |
| GEV No. | 346385 | Ref. No. | 054552 401D3501 |
| description | rocker switch mounting measurements 30x22mm green 2CO 230V 16A illuminated fan connection male faston 6.3mm ambient temperature max. 125/55°C protection IP65 with cover cap | | |
| For models: | FCFG10, FCFG10D, FCFG10NL, FCFE10, FCFE10UK, FCFG20, FCFG20D, FCFG20F, PFCFG20, FCFE20, FCFE20UK, FCFG101, FCFG201, FCF/E10, FCF/E20, COCO10G, COCO10E, COCO20G, COCO20E, FCFE101, FCFE201, ZOFCE/G10D, ZOFCE/G20D | | |
| accessories for | 346385 | | |
|  | GEV No. | 301036 | Ref. No. 002150 |
| | protective cover internal size 30x22mm for rocker switch mounting measurementsmm | | |

| | | | |
|---|---|-----------------|------------------------|
|  | | | |
| 1 | | | |
| GEV No. | 346386 | Ref. No. | 058808 |
| description | rocker switch mounting measurements 30x22mm green 2CO 250V 16A illuminated I-II connection male faston 6.3mm ambient temperature max. 85°C protection IP65 with cover cap | | |
| For models: | FCFE10, FCFE10UK, FCFE20, FCFE20UK, FCFE10J, FCFE10J, FCFE20J, FCFE20J, COCO10E, COCO20E, FCFE101, FCFE201 | | |
| accessories for | 346386 | | |
|  | GEV No. | 301036 | Ref. No. 002150 |
| | protective cover internal size 30x22mm for rocker switch mounting measurementsmm | | |





| | | | |
|---|---|-----------------|--------|
|  | | | |
| 1 | | | |
| GEV No. | 346384 | Ref. No. | 053837 |
| description | rocker switch mounting measurements 30x22mm green 2NO 250V 16A illuminated I-II connection male faston 6.3mm ambient temperature max. 125/55°C protection IP65 with cover cap | | |
| For models: | FCFE10, FCFE10UK, FCFE20, FCFE20UK, FCF/E10, FCF/E20, COCO10E, COCO20E, FCFE101, FCFE201 | | |
| accessories for | 346384 | | |
|  | | | |
| 1 | | | |
| GEV No. | 301036 | Ref. No. | 002150 |
| description | protective cover internal size 30x22mm for rocker switch mounting measurementsmm | | |

push/momentary push switches

| | | | |
|--|---|-----------------|-----------------------|
| <p>30x22mm</p>  | | | |
| 1 | | | |
| GEV No. | 301040 ¹ | Ref. No. | 00716605202 0H6697 |
| description | push switch mounting measurements 30x22mm green 2NO 250V 16A illuminated connection male faston 6.3mm ambient temperature max. 85°C protection IP40 | | |
| For models: | 7550-5.KES40, 7551-5.KES60, 7552-5.KES80, 7553-5.KES100, 7554-5.KES150, 7561-3.KES60.RW, 7562-3.KES80.RW, 7563-3.KES100.RW, 7564-3.KES150.RW, 7581-5.KK60, 7582-5.KK80, 7583-5.KK100, 7574-5.KES150, 7575-5.KES250, 7750-5.KES40, 7751-5.KES60, 7752-5.KES80, 7753-5.KES100, 7754-5.KES150, 7781-5.KK60, 7782-5.KK80, 7783-5.KK100, 7576-5.KES300, 7573-5.KES100, 7580-5.KK40, 7584-5.KK150, 7780-5.KK40, 7720-3/90.WB.GN1/1., 7520-3/85.WB.GN1/1., 7731-3/85.GRPL.VCHR., 7721-3/85.WB.GN2/1., 7751-3/85.KES60, 7744-3/85.KB.(N), 7531-3/85., 7531-3/90.GRPL.(N), 7520-3/90.WB.GN1/1., 7720-3/85.WB.GN1/1., 7542-3/85., 7544-3/85.KB.(N), 7542-3/90.KB.(N), 7544-3/90.KB.(N), 7742-3/90.KB.(N), 7742-3/85.KB.(N), 7744-3/90.KB.(N), 7746-3/90.KB.(N), 7748-3/90.KB.(N), 7747-3/90.KB.(N), 7550-3/85.KES40.(N), 7551-3/85.KES60, 7552-3/85.KES80.(N)...(Other models you can see in the webshop) | | |

¹illuminated

| | | | |
|---|--|-----------------|--------|
|  | | | |
| 1 | | | |
| GEV No. | 301036 | Ref. No. | 002150 |
| description | protective cover internal size 30x22mm for rocker switch mounting measurementsmm | | |
| For models: | HBR/G801, HBR/G806, HBR/G811, HBR/G816, HBR/G801D, HBR/G806D, HBR/G811D, HBR/G816D, HBR/E801, HBR/E806, HBR/E811, HBR/E816, ZBR/G801, ZBR/G806, ZBR/G811, ZBR/G816, ZBR/G801D, ZBR/G806D, ZBR/G811D, ZBR/G816D, ZR/G413, BR/E806, ZBR/E811, ZBR/E816, ABR/G801, ABR/G806, ABR/G811, ABR/G816, ABR/G801D, ABR/G806D, ABR/G811D, ABR/G816D, ABR/E801, ABR/E806, ABR/E811, ABR/E816 | | |

| | | | |
|--|---|-----------------|--|
| <p>ø16mm</p>  | | | |
| 1 | | | |
| GEV No. | 346287 ¹ | Ref. No. | 002418 006848 0G2313 0G2315 0K2049 |
| description | momentary push switch mounting ø 16mm red 1NO 250V 3A illuminated connection male faston 2.8mm ambient temperature max. 125/55°C protection IP65 with cover cap | | |
| For models: | FDV40G, FDV40GZ, FDV40GA, FDV20G, FDV20GZ, FDV20GA, HI/G400, HI/G800, HI/G400N, HI/G800N, BRN70G, BRN/70GZ, BR70GZ, BRNG70A, FCV/G10L3, FCVG10L3T, FCVG10L3, FCV/G20L3, FCVG20L3, FCVG10L3J, FCVG10L3J, FCVG10L6JAP, FCV/G102/1L-6JAP, FCVG6L3CJ, FCV/G10L2, FCV/G6L3C, FCV/G61/1, FCV/G61/1, FCV/G61/1, FCV/G61/1, FCVG6L3CT, FCVG6L3CJ, FCV/G6L4, FCV/G10L6, FCV/G102/1L6, FCV/G20L6, FCVG20L6, FCV/G101/1, FCV/G102/1, FCV/G201/1, FCV/G202/1, FCS061G48J, FCS061GP, FCS061G-3DI, FCS061G4, FCS061G4DT, FCS061G49J, FCS101G2, FCS101G4, FCS101G4DT...(Other models you can see in the webshop) | | |



¹illuminated

| | | | |
|--|--|-----------------|------------------|
| <p>ø25mm</p>  | | | |
| 1 | | | |
| GEV No. | 345038 | Ref. No. | 053978 058274 |
| description | momentary push switch mounting ø 25mm black 2NO 250V 16A connection male faston 6.3mm ambient temperature max. 85°C protection IP40 | | |
| For models: | RC/G320, RC/G330, RC/G320F, RC/G720, RC/G730, MCF/G705, MCF/G1055, MCF/G700, MCF/G1050, MCF/G705E, MCF/G1055E, MCF/G700D, MCF/G700, MCF/G705F, MCF/G1055F, MCF/G705NL, MCF/GE705, MCF/GE1055, MCF/GE700, MCFGE1050, MCF/GE700D, MCFGE1050D, MCF/G1050D, MCFG1055NL, MC/G355, MC/G350, MC/G355E, MC/G350D, MC/G355F, MC/G355NL, MC/G705, MC/G700, MC/G705E, MC/G700D, MC/G705NL, MC/G1055, MC/G1050, MC/G1050D, MC/G1055NL, MC/G705F, MCF/GE1055UK, MCF/G1090, MCF/G1095, MC/G352, MC/G702, MC/G1052, MCF/G702, MCF/GE702, MCF/G1052, MCFGE1052...(Other models you can see in the webshop) | | |

| | | | |
|---|--|-----------------|--------------------------------------|
|  | | | |
| 1 | | | |
| GEV No. | 345161 ¹ | Ref. No. | 054518 082446 0K2150 0K3029 |
| description | push switch mounting ø 25mm green 2NO 250V 16A illuminated connection male faston 6.3mm ambient temperature max. 85°C protection IP40 | | |
| For models: | MFR/G350, MFR/G700, MFR/G350D, MFR/G700D, MFR/G350F, MFR/G700F, MFR/G350E, MFR/G700E, MVR/E1400, MVR/E1050, MVR/E1060, MCP/G700, RC/G1, RC/G2, RCV/G2, RCV/G3, RCF/G2, RCF/G3, RSF/G2, RSV/G2, RSF/G3, MCF/G2A, MCF/G3A, XC/G1, XC/G2, XCV/G2, XCV/G3, XCF/G2, XCF/G3, XSF/G2, XSV/G2, XSF/G3, JC/G1, JC/G2, JCV/G2, JCV/G3, JCF/G2, JCF/G3, MC/G1, MC/G2, MCV/G2, MCV/G3, MCF/G2, MCF/G3, MSF/G2, MSV/G2, MSF/G3, RFR/G350, RFR/G700, RFR/G350D...(Other models you can see in the webshop) | | |

¹illuminated



| | | | |
|---|--|-----------------|------------------|
|  | | | |
| 1 | | | |
| GEV No. | 345039 | Ref. No. | 053979 OK3030 |
| description | protective cover round ED ø 33mm external size 23mm internal size 21mm H 12mm clear mounting ø 25mm | | |
| For models: | RC/G320, RC/G330, RC/G320F, RC/G720, RC/G730, MCF/G705, MCF/G1055, MCF/G700, MCF/G1050, MCF/G705E, MCF/G1055E, MCF/G700D, MCF/G700, MCF/G705F, MCF/G1055F, MCF/G705NL, MCF/GE705, MCF/GE1055, MCF/GE700, MCFGE1050, MCF/GE700D, MCFGE1050D, MCF/G1050D, MCFG1055NL, MC/G355, MC/G350, MC/G355E, MC/G350D, MC/G355F, MC/G355NL, MC/G705, MC/G700, MC/G705E, MC/G700D, MC/G705NL, MC/G1055, MC/G1050, MC/G1050D, MC/G1055NL, MC/G705F, MCF/GE1055UK, MCF/G1090, MCF/G1095, MC/G352, MC/G702, MC/G1052, MCF/G702, MCF/GE702, MCF/G1052, MCFGE1052...(Other models you can see in the webshop) | | |
| accessories for | 345039 | | |
| |  | GEV No. | 345001 |
| | | Ref. No. | — |
| | momentary push switch mounting ø 25mm yellow 1NO/indicator light 250V 16A cover connection male faston 6.3mm ambient temperature max. 85°C protection IP65 | | |

accessories

push buttons

| | | | |
|--|---|-----------------|--------|
|  | | | |
| 1 | | | |
| GEV No. | 346311 | Ref. No. | 003768 |
| description | push button | | |
| For models: | FCF/G6-0, FCFG101/0, FCFG102-0, FCFG201-0, FCFG202-0, FCF/E6-0, FCFE101-0, FCFE102-0, FCFE201-0, FCFE202-0, FCF061ELN, FCF101ELN, FCF6EHOR, FCFG10160H, FCF061ENS, FCF101ENS, FCF102ENS, FCF201ENS, FCFG102-0T, FCF/G6-1-JAP, FCF/G101/1-1-JAP, FCF/G102/1-1-JAP, FCFE6-1J, FCFE101-1J, FCFE102-1J, FCF/G101/1, 5702-2-3, 5704-2-3, 57074-2-3, 5701-3-3, 5702-3-3, 5704-3-3, 5707-3-3, ECF/G6/0, ECFG101-0, ECFG102-0, ECFG201-0, ECFG202-0, ECF/E6-0, ECFE101-0, ECFE102-0, ECFE201-0, ECFE202-0, ECF061ENS, ECF101ENS, ECF102ENS, ECF201ENS, ECF061E5M, ECF061ECV, ACF/G6-0...(Other models you can see in the webshop) | | |

element holders

| | | | |
|---|---|-----------------|--------|
|  | | | |
| 1 | | | |
| GEV No. | 346310 | Ref. No. | 003767 |
| description | element holder ø 24mm | | |
| For models: | FCF/G6-0, FCFG101/0, FCFG102-0, FCFG201-0, FCFG202-0, FCF/E6-0, FCFE101-0, FCFE102-0, FCFE201-0, FCFE202-0, FCF061ELN, FCF101ELN, FCF6EHOR, FCFG10160H, FCF061ENS, FCF101ENS, FCF102ENS, FCF201ENS, FCFG102-0T, FCF/G6-1-JAP, FCF/G101/1-1-JAP, FCF/G102/1-1-JAP, FCFE6-1J, FCFE101-1J, FCFE102-1J, FCF/G101/1, 5702-2-3, 5704-2-3, 57074-2-3, 5701-3-3, 5702-3-3, 5704-3-3, 5707-3-3, ECF/G6/0, ECFG101-0, ECFG102-0, ECFG201-0, ECFG202-0, ECF/E6-0, ECFE101-0, ECFE102-0, ECFE201-0, ECFE202-0, ECF061ENS, ECF101ENS, ECF102ENS, ECF201ENS, ECF061E5M, ECF061ECV, ACF/G6-0...(Other models you can see in the webshop) | | |

microswitches

universal





| | | | |
|------------------------|--|-----------------|----------------------------|
| 1 | | | |
| GEV No. | 345042 | Ref. No. | 085298 0D6615 OKQ309 |
| description | microswitch with plunger 250V 16A 1CO connection male faston 6.3mm L 28mm ambient temperature max. 125°C mounting distance 22mm type EF83161.3 actuating force: 75g blue/black | | |
| For models: | MULTI2-01, TRS-3-02, TRS-3-03, TRS-1-02, TRS-1-03, MINIG-01, MULTIG-01, MULTI2-02, BE5-01, BE5-02, TRS-3-04, TRS-3-05, BE5-03, TRS-1-04, MULTIG-02, BE5-04, TRS-1-05, MULTIG-03, BE5A-01, TRS-1-06, MULTI2-03, TRS-1-07, MULTIG-04, MULTIG-05, TRS-1-08, TRS-3-06, BE5-05, TRS-3-07, TRS-1-09, EL25-01, BE5A-02, TR200-04, TR200-03, MULTI2-04, CPX-01, TBX130-09, TR200-01, TR200-02, MULTI2-05, TRX-01, TRX-02, TBX130-10, TBX1201OLD, MULTIG-06, TRS-1-10, TRS-1-11, MULTIG-07, TR22-01, TR24, TRS-3-08...(Other models you can see in the webshop) | | |
| accessories for | 345042 | | |
| |  | GEV No. | 345043 |
| | | Ref. No. | — |
| | lever set 5-piece | | |

lever actuated



| | | | |
|---|--|-----------------|--|
|  | | | |
| 1 | | | |
| GEV No. | 345254 | Ref. No. | 046286 053671 054550 057580 058405 066874 081352 081692 OK7808 |
| description | microswitch with lever 250V 16A 1CO connection male faston 6.3mm ambient temperature max. 120°C mounting distance 22mm actuating force: 60g lever length 58mm | | |
| For models: | AP20, BC44, BCF44, ALP110, ALP120, ALP111, ALP220, ALP240, ALP221, ALN110, ALN120, ALN111, ALN220, ALN240, ALN221, ALNN120, ALNN220, ALNN230, ALNSO120, ALP110UK, ALN110UK, ALNN220UK, ALF110, ALF220UK, ALNF220, ALF110, ALF120, ALF220, ALF240, ALNF120, ALNF220, ALNF230, BC44, BCF44, ILP110, ILP110UK, ILN120, ILP111, ILP220, ILP220UK, ILP240, ILP221, ILN110, ILN110UK, ILN120, ILN111, ILN220, ILN220UK, ILN240, ILNSO120...(Other models you can see in the webshop) | | |





| | | | |
|---|--|-----------------|------------------|
|  | | | |
| 1 | | | |
| GEV No. | 345257 | Ref. No. | 069484 218002 |
| description | microswitch with lever 250V 16A 1CO connection male faston 6.3mm L 29mm L1 33mm ambient temperature max. 120°C mounting distance 22mm actuating force: 130g lever length 31.5mm | | |
| For models: | LTB11, LTB12, LTB22, LTB11UK, LTB12UK, LTB22UK, LTB11, LTB22, 910-00-021, 910-00-023, 910-00-031, 910-00-033, 911-00-022, 911-00-024, 911-00-032, 911-00-034, CRYSTAL 11, CRYSTAL 22 | | |

| | | | |
|---|--|-----------------|---|
|  | | | |
| 1 | | | |
| GEV No. | 345107 | Ref. No. | 046379 047485 0H2586 0KB678 306E2334 640606500 |
| description | microswitch with lever 250V 16A 1CO connection male faston 6.3mm L 98mm ambient temperature max. 125°C mounting distance 22mm actuating force: 30g lever length 90mm | | |
| For models: | FCV31E3, 7CO30, CCO30G, ECO312CF, OTS100, LB80EPH, LB80E, LB120EPH, LB120E, LB160EPH, LB160E, LB160V, CLB160E, CLB160V, LB70E, LB110E, LS540F, LS540DK, LS541F, LS365D, LS540, LSD551, LSD55V, LS540D, LS540/63, LS541, LS510, LS520, LS520D, LS520F, LS520M, LS520K, LS521, LS521D, LS521F, LS521M, LS521K, LS521, LS4, LS540, ZLS510, ZLS520, ZLS521, ALS540, ALLS521, ALLS520, ALS510, LB80E, LB70E, LB120E...(Other models you can see in the webshop) | | |

| | | | |
|---|--|-----------------|--------|
|  | | | |
| 1 | | | |
| GEV No. | 345757 | Ref. No. | OK1003 |
| description | microswitch with plunger 250V 16A 1CO connection male faston 6.3mm L 28mm ambient temperature max. 125°C mounting distance 22mm type EF83161.3 actuating force: 75g blue/black | | |
| For models: | 5611-3-10, 5611-3-8, 5612-3-10, 5612-3-8, 5614-3-10, 5614-3-8 | | |

| | | | | | | | |
|---|--|--|----------------------------|--------|-----------------|---|--|
| pin-plunger actuated | | | | | | | |
|  | | | | | | | |
|  | | | | | | | |
| 1 | | | | | | | |
| GEV No. | 345042 | Ref. No. | 085298 0D6615 0KQ309 | | | | |
| description | microswitch with plunger 250V 16A 1CO connection male faston 6.3mm L 28mm ambient temperature max. 125°C mounting distance 22mm type EF83161.3 actuating force: 75g blue/black | | | | | | |
| For models: | MULTI2-01, TRS-3-02, TRS-3-03, TRS-1-02, TRS-1-03, MINIG-01, MULTIG-01, MULTI2-02, BE5-01, BE5-02, TRS-3-04, TRS-3-05, BE5-03, TRS-1-04, MULTIG-02, BE5-04, TRS-1-05, MULTIG-03, BE5A-01, TRS-1-06, MULTI2-03, TRS-1-07, MULTIG-04, MULTIG-05, TRS-1-08, TRS-3-06, BE5-05, TRS-3-07, TRS-1-09, EL25-01, BE5A-02, TR200-04, TR200-03, MULTI2-04, CPX-01, TBX130-09, TR200-01, TR200-02, MULTI2-05, TRX-01, TRX-02, TBX130-10, TBX1201OLD, MULTIG-06, TRS-1-10, TRS-1-11, MULTIG-07, TR22-01, TR24, TRS-3-08...(Other models you can see in the webshop) | | | | | | |
| accessories for | 345042 | | | | | | |
| |  | <table border="1"> <tr> <td>GEV No.</td> <td>345043</td> <td>Ref. No.</td> <td>—</td> </tr> </table> | GEV No. | 345043 | Ref. No. | — | |
| GEV No. | 345043 | Ref. No. | — | | | | |
| | lever set 5-piece | | | | | | |

| | | | |
|---|--|-----------------|--------|
|  | | | |
| 1 | | | |
| GEV No. | 345105 | Ref. No. | OKI505 |
| description | microswitch with plunger 250V 16A 1CO connection male faston 6.3mm L 28mm ambient temperature max. 125°C mounting distance 22mm type SM-51 actuating force: 280g black | | |
| For models: | MF250WB20 | | |

| | | | |
|---|---|-----------------|--------|
| M10 | | | |
|  | | | |
| 1 | | | |
| GEV No. | 347216 | Ref. No. | OPR613 |
| description | microswitch with plunger thread M10x0.75 thread L 14mm 250V 10A 1CO connection male faston 6.3mm stroke 7.5mm mounting distance 22mm L 28mm ambient temperature max. 125°C type NR6K5 actuating force: 260g | | |

| | | | |
|---|---|-----------------|--------|
|  | | | |
| 1 | | | |
| GEV No. | 345156 | Ref. No. | OKW537 |
| description | microswitch with plunger thread M10x1 thread L 13mm 250V 16A 1CO connection male faston 6.3mm stroke 6mm mounting distance 25mm L 46mm L1 13mm ambient temperature max. 85°C type C4A-ZN3 actuating force: 340g | | |



M12



1

| | | | |
|--------------------|--|-----------------|------------------|
| GEV No. | 347009 | Ref. No. | 0H2312 0K7633 |
| description | microswitch with plunger thread M12x1 380V 20A 1CO connection screw ambient temperature max. 85°C | | |
| For models: | AR170, AR170, AR170, AR170, AR170, AR170, AR170, AR170, AR170, AR170S, AR170S, AR170S, AR170S, AR170S, AR170S, AR170S, AR170S, AR170S, AR170S, AR340, AR340, AR340, AR340, AR340, AR340, AR340, AR340, AR340, AR340S, AR340S, AR340S, AR340S, AR340S, AR340S, AR340S, AR340S, AR340S, AR340S, AR85, AR85, AR85, AR85, AR85, AR85, AR85, AR85...(Other models you can see in the webshop) | | |



1

| | | | |
|--------------------|---|-----------------|------------------|
| GEV No. | 345651 | Ref. No. | 003766 0K3391 |
| description | switch 2CO 250V 16A connection male faston 6.3mm | | |
| For models: | FCF/G6-0, FCFG101/0, FCFG102-0, FCFG201-0, FCFG202-0, FCF/E6-0, FCFE101-0, FCFE102-0, FCFE201-0, FCFE202-0, FCF061ELN, FCF101ELN, FCF6EHOR, FCFG10160H, FCF061ENS, FCF101ENS, FCF102ENS, FCF201ENS, FCFG102-0T, FCF/G6-1-JAP, FCF/G101/1-1-JAP, FCF/G102/1-1-JAP, FCFE6-1J, FCFE101-1J, FCFE102-1J, FCF/G101/1, 5702-2-3, 5704-2-3, 57074-2-3, 5701-3-3, 5702-3-3, 5704-3-3, 5707-3-3, ECF/G6/0, ECFG101-0, ECFG102-0, ECFG201-0, ECFG202-0, ECF/E6-0, ECFE101-0, ECFE102-0, ECFE201-0, ECFE202-0, ECF061ENS, ECF101ENS, ECF102ENS, ECF201ENS, ECF061E5M, ECF061ECV, ACF/G6-0...(Other models you can see in the webshop) | | |

non-standard



1

| | | | |
|--------------------|---|-----------------|------------------|
| GEV No. | 346389 | Ref. No. | 0G1829 0H7125 |
| description | microswitch connection male faston | | |
| For models: | 5611-3-10, 5611-3-6, 5611-3-8, 5612-3-10, 5612-3-6, 5612-3-8, 5614-3-10, 5614-3-6, 5614-3-8 | | |



1

| | | | |
|--------------------|--|-----------------|--------|
| GEV No. | 345720 | Ref. No. | 0A8754 |
| description | switch 2NO 250V 16A connection male faston 6.3mm | | |
| For models: | ALP110, ALP120, ALP111, ALP220, ALP240, ALP221, ALN110, ALN120, ALN111, ALN220, ALN240, ALN221, ALNN120, ALNN220, ALNN230, ALNSO120, ALP110UK, ALN110UK, ALNN220UK, ALF110, ALF220UK, ALNF220, ALF110, ALF120, ALF220, ALNF120, ALNF220, ALNF230, ALP110UK, ALN110UK, ALNN220UK, ALF110UK, ALNF220UK, ALP110, ALP120, ALP111, ALP220, ALP240, ALP221, ALN110, ALN120, ALN111, ALN220, ALN240, ALN221, ALF110, ALF120, ALF220, ALF240...(Other models you can see in the webshop) | | |

accessories



1

| | | | |
|--------------------|---|-----------------|--------|
| GEV No. | 348103 | Ref. No. | 045404 |
| description | insulation for microswitch L 46mm W 26mm | | |
| For models: | AP20, BC44, BCF44, ALP110, ALP120, ALP111, ALP220, ALP240, ALP221, ALN110, ALN120, ALN111, ALN220, ALN240, ALN221, ALNN220, ALNN230, ALNSO120, ALP110UK, ALN110UK, ALNN220UK, ALF110, ALF220UK, ALNF220, ALF110, ALF120, ALF220, ALNF120, ALNF220, ALNF230, BC44, BCF44, ILP110, ILP110UK, ILN120, ILP111, ILP220, ILP220UK, ILP240, ILP221, ILN110, ILN110UK, ILN120, ILN111, ILN220, ILN220UK, ILN240, ILN221, ILNN220, ILNN220UK...(Other models you can see in the webshop) | | |

cam switches

on/off



1

| | | | |
|--------------------|---|-----------------|--------|
| GEV No. | 300129 | Ref. No. | 003142 |
| description | cam switch 2 operating positions 2NO sequence 0-1 16A shaft ø 6x4.6mm shaft L 23mm connection male faston 6.3mm ceramic | | |

system switches (ROLD)



1

| | | | |
|--------------------|--|-----------------|--------|
| GEV No. | 345601 | Ref. No. | 0A8268 |
| description | indicator lamp holder V ø 11mm | | |
| For models: | EMVN500, MVN112V12C, DVP500V11C, DVP501V11C, MVP502V11C, DVN500V11C, DVN501V11C, DVP500V11V, DVP501V11V, MVP502V11V, EDVN500, DVN501V11V, DVP600V11C, DVP601V11C, MVP602V11C, DVP600V12C, DVP601V12C, DVN600V11C, DVN601V11C, DVN600V12C, DVN601V12C, DVP600V11V, DVP601V11V, EMVP602, DVN600V11V, EDVN601, DVP110V12C, DVP111V12C, MVP112V12C, DVN110V12C, DVN111V12C, DVP110V12V, DVP111V12V, MVP112V12V, EDVN1100, EDVN1101, DVP130V12C, DVP131V12C, MVP132V12C, DVN130V12C, DVN131V12C, DVP130V14C, DVP131V14C, DVN130V14C, DVN131V14C, DVP130V12V, DVP131V12V, EEVN1301, DVN130V12V, EDVN1300...(Other models you can see in the webshop) | | |

1

| | | | |
|--------------------|---|-----------------|----------------------------|
| GEV No. | 300088 | Ref. No. | 002382 003119 032677 |
| description | cam switch 2 operating positions 4NO sequence 0-1 16A shaft ø 6x4.6mm shaft L 23mm connection male faston 6.3mm ceramic | | |
| For models: | FCVMG62, QFE302, QFE602, DL14/C, DL14/CP, DL21/C, DL21/CP, SM08C., SM15CP, SM15C., SM15CA., SM15/CS., SM21/CP, SM21C., SM21CA., SM15VP, SM15VA., SM21VP, SM21VA., DI-RT2, DI-RT3, DI-RT4, DI-RT5, DI-RT6, DI-BARW2, DI-BARW3, DI-BARW4, DI-BARW5, DI-BARW6, DI-RW2, DI-RW3, DI-RW4, DI-RW5, DI-RW6, DB/G31, DB/G21, DB/G33, DB/G22, SM08C, SM15CP, SM15C, SM15CA, SM15/CS, SM21C, SM21C, SM21CA, SM15VP, SM15VA, SM21VP, SM21VA | | |





2

| | | | |
|--------------------|--|-----------------|----------------------------|
| GEV No. | 300074 | Ref. No. | 0A2162 0A2227 0KE807 |
| description | cam switch 4 operating positions 2NO sequence 0-1-0-1 16A shaft ø 6x4.6mm shaft L 23mm connection male faston 6.3mm ceramic | | |
| For models: | MBR/G710D, MBR/E710D, MBR/E700, MBR/E700UK, MBR/E716, MBR/E706, MCC/E350D, MCC/E350, FDV40G, FDV40GZ, FDV40GA, FDV20G, FDV20GZ, FDV20GA, RW/E1, XW/E1, JW/E1, MW/E1, RBR/G710D, 7BRE60XN, 7BRE60X, RBR/E700UK, RBR/E716, RBR/E706, RCC/E350, XBR/E710D, M70EBP, XBR/E710, XBR/G751, XBR/G756, CBR/E700, XBR/E716, XBR/E706, T35ECS, CCC/E350, PW/E1, OW/E1, TW/E1, RBR/E700, RBR/E700, KW/E1, HFR/G410NL, HFR/G810NL, HPN/GI810, HPN/GI815, HPN/GI806, HPN/GI805, QW/E1, ZPN/GI810, 2PIG15...(Other models you can see in the webshop) | | |



1

| | | | |
|--|--|-----------------|--------------------------------------|
| GEV No. | 300020 | Ref. No. | 003565 028390 0C3192 I01591 |
| description | cam switch 4 operating positions 2NO sequence 0-1-0-1 16A shaft ø 6x4.6mm shaft L 23mm connection screw ceramic | | |
| For models: | KPI/G18, KPI/G25, HPN/GI855, HPN/GI1255, QPI/G18, QPI/G25, ZPN/GI1255, FCVE6-3CE, FCVE103CE, FCVE203CE, HQN/EI917, HQN/EI1225, HPN/EI810, HPN/EI810, HPA/EI810, HBR/G803, HBR/G804, HBR/G803, HBR/G804, HBR/G803, HBR/G805, HBR/G1003, HBR/G1003, HBR/G1004, HBR/G803, HBR/G804, HBR/G1013, HBR/G803, HBR/G804, HBR/G1003, HBR/G1013, HPN/EI810, HPN/EI810, HPA/EI815, HQNEI817, HQNEI122, AFCV/G6-3, AFCV/G103, AFCV/G203, HBR/G1004, ZHMA/E400 | | |
| accessories for | 300020 | | |
|  | GEV No. | 110135 | Ref. No. — |
| | rosette knob up to ø 52mm | | |
|  | GEV No. | 110231 | Ref. No. — |
| | knob switch 0-1-0-1 t.max.°C ø 50mm shaft ø 6x4.6mm shaft flat upper black | | |

4-position

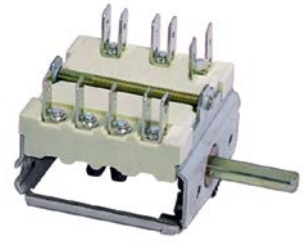

1

| | | | |
|--------------------|--|-----------------|--------------------------------------|
| GEV No. | 300007 | Ref. No. | 0H6602 0H9803 0K4913 300007 |
| description | cam switch 4 operating positions 1NO/2CO sequence 0-1-2-3 16A shaft ø 6x4.6mm shaft L 23mm connection male faston 6.3mm 4-position ceramic | | |
| For models: | BE1-TA.3, BE1-W.3, BE1-WS-M.3, BE2-A-C.3, BE2-A-M.3, BE2-WS-C.3, BE2-WS-M.3, BE3-C.3, BE3-M.3, BE1-WS-C.3 | | |

1

| | | | |
|--------------------|---|-----------------|--|
| GEV No. | 300103 | Ref. No. | 029147 0H1255 0H6389 0H6598 OK1383 OK2147 |
| description | cam switch 4 operating positions 1NO/2CO sequence 0-1-2-3 32A shaft ø 6x4.6mm shaft L 23mm connection screw ceramic | | |
| For models: | 7508-3/85., 7502-3/85., 7500-3/85.HE.2PL.(N), 7504-3/85.HE.6PL.BO, 7505-3/85, 7506-3/85.HE.CER.2KZ, 7512-3/85.KF.BO.(N), 7502-3/90. HE.4PL.BO., 7504-3/90.HE.6PL.BO., 7505-3/90.HE.6PL.BO., 7506-3/90. HE.CER.2KZ, 7508-3/90.HE.CER.BO., 7512-3/90.KF.BO.(N), 7700-3/85, 7700-3/90.HE.2PL.(N), 7502-3/85.HE.4PL.BO., 7508-3/85.HE.CER.BO., 7505-3/85.HE.6PL.BO., 7508-3/85.HE.CER.BO., 7506-3/85.HE.CER.2KZ, 7506-3/85.HE.CER.2KZ, 7508-3/85.HE.CER.BO., 7509-3/85.HE.CER.6KZ, 7506-3/85.HE.CER.2KZ, 7510-3/85.HE.CER.6KZ, 7509-3/85.HE.CER.6KZ, 7509-3/85.HE.CER.6KZ, 7504-3/90.HE.6PL.BO., 7502-3, 7502-9, 7504-3, 7504-9, 7505-3, 7505-9-9, 7508-3, 7510-3/90.HE.CER.6KZ, 7512-3, 7512-9, 7709-3/85, 7709-3/90, 9002-3, 9004-2, 9004-3, 9006-3, 9012-3, 9015-3, 9598-3-0, 9598-3-8 | | |



1

| | | | |
|--------------------|--|-----------------|--|
| GEV No. | 300104 | Ref. No. | 01C16 01C21 0H6683 0KE653 0M0519 247202 |
| description | cam switch 4 operating positions 3NO/1CO sequence 0-1-2-3 32A shaft ø 6x4.6mm shaft L 23mm connection screw ceramic | | |
| For models: | 7561-3.KES60.RW, 7562-3.KES80.RW, 7563-3.KES100.RW, 7564-3. KES150.RW, 7751-3/85.KES60, 7550-3/85.KES40.(N), 7551-3/85.KES60, 7552-3/85.KES80.(N), 7553-3/85.KES100.(N), 7554-3/85.KES150.(N), 7550-3/90.KES40.(N), 7551-3/90.KES60, 7552-3/90.KES80.(N), 7553-3/90.KES100.(N), 7554-3/90.KES150.(N), 7561-3/85.KES60.RW., 7562-3/85.KES80.RW., 7563-3/85.KES100.RW., 7564-3/85.KES150.RW., 7561-3/90.KES60.RW., 7562-3/90.KES80.RW., 7563-3/90.KES100.RW., 7564-3/90.KES150.RW., 7573-3/85.KES100.(N), 7574-3/85.KES150.(N), 7575-3/85.KES250.(N), 7576-3/85.KES300.(N), 7573-3/90.KES100.(N), 7574-3/90.KES150.(N), 7575-3/90.KES250.(N), 7576-3/90.KES300.(N), 7585-3/85.KK40.MOTK., 7586-3/85.KK60.MOTK., 7587-3/85.KK80.MOTK., 7588-3/85.KK100.MOTK., 7585-3/90.KK40.MOTK., 7586-3/90.KK60.MOTL., 7587-3/90.KK80.MOTK., 7588-3/90.KK100.MOTK., 7550-3, 7551-3, 7552-3, 7553-3, 7554-3, 7560-3, 7561-3, 7562-3, 7563-3, 7564-2, 7568-3...(Other models you can see in the webshop) | | |

7-position



1

| | | | |
|--------------------|---|-----------------|--|
| GEV No. | 300106 | Ref. No. | 01C25 01C32 0A2022 0G0920 0H1256 0H6394 0H9805 0K4922 0K6968 0K7289 0KC015 0M0527 30000755 |
| description | cam switch 7 operating positions 1NO/2CO sequence 0-1-2-3-4-5-6 32A shaft ø 6x4.6mm shaft L 23mm connection screw 7-position shaft flat upper | | |
| For models: | CE128-106, CE158-133.3.HV, CE158-244.3, CE158-246.3, CK248-209. D1ABBB, CK248-211.D1ABBB, HCE128-100, HCE128-104, HCE158-252W.3, HCE158-253.3, CK248-205.D1ABBB, CK248-207.D1ABBB, HCE128-100W, HCE128-103W, HCE128-104W, CE128-101, CE128-102, CE128-105, CE128-107, CE128-108, HCE158-262W.3, HCE158-264.3, HCE158-261.3, HCE158-261W.3, HCE158-263.3, HCE158-232W.3, HCE158-233.3, HCE158-231.3, HCE158-231W.3, HCE158-230.3, CE158-234.3, CE158-236.3, HCE158-254.3, HCE158-251.3, HCE158-251W.3, HCE158-242W.3, HCE158-243.3, HCE158-241.3, HCE158-241W.3, HCE158-240.3, CE158-235.3, CE158-237.3, CE158-245.3, CE158-247.3, HCE158-131W.3.HV, HCE158-135.3.HV, HCE158-121W.3.HV, HCE158-125.3.HV, HCE158-132.3.HV, HCE158-132W.3.HV...(Other models you can see in the webshop) | | |

3 operating positions



1

| | | | |
|---|---|-----------------|---|
| GEV No. | 345171 | Ref. No. | 048271 |
| description | cam switch 3 operating positions 3NO sequence 0-1-2 16A shaft ø 6x4.6mm shaft L 26mm connection male faston 6.3mm ceramic | | |
| For models: | LS7D, LS7, LS7UK/RP, LV70, LS7F, LS7DEK, LS7/1UK, LS7/9, LS7/60, WT40/9, WT40/F, LS7HD, WT40/J50, WT40/J60, WT40UKRP, PH4/ WT40, PH4RBP/WT40, LS10D, LS10, LS10UKRP, LC100, LS10/60, LS10/1, LS10/12KW, LS10F, LS10DEK, LS10/1UKRP, LS10SW, LS12D, LS12, LS12UK/RP, LC120, LS12/60, LS12F, LS12DEK, RT10ED, RT10ES, RT10SR, RT10SL, RT10ED/230, RT10ES/230, RT10ERF60, RT10ELF60, RT10ERF, RT10ELF, RT10ERBF60, RT10ELBF60, RT10ERG, RT10ELG, RT10EDH...(Other models you can see in the webshop) | | |
| accessories for | 345171 | | |
|  | GEV No. | 112340 | Ref. No. 046356 048340 048527 089816 46356 7MIS46356 |
| knob switch zero mark t.max.°C temperature range°C ø 40mm shaft ø 6x4.6mm shaft flat left black | | | |



1

| | | | |
|--------------------|--|-----------------|-------------------------|
| GEV No. | 300042 | Ref. No. | 0116060033001 0H6101 |
| description | cam switch 3 operating positions speed/power sequence 1-2-3 shaft \varnothing 6x4.6mm connection male faston 16-pole | | |

4 operating positions

1

| | | | |
|--------------------|---|-----------------|--------|
| GEV No. | 300010 | Ref. No. | 057934 |
| description | cam switch 4 operating positions 2NO/2CO sequence 0-1-2-3 16A shaft \varnothing 6x4.6mm shaft L 23mm connection male faston 6.3mm ceramic | | |

1

| | | | |
|--------------------|---|-----------------|--------|
| GEV No. | 300037 | Ref. No. | 0H6387 |
| description | cam switch 4 operating positions 4NO sequence 0-1-2-3 16A shaft \varnothing 6x4.6mm shaft L 23mm connection male faston 6.3mm | | |

5 operating positions

1

| | | | |
|--------------------|---|-----------------|--------|
| GEV No. | 301229 | Ref. No. | 005213 |
| description | cam switch 5 operating positions sequence 0-1-2-3-4 shaft \varnothing 6x4.6mm connection male faston 3-pole | | |
| For models: | FCF/E4, FCF/E4-3KW, JCF/E4, JCF/E4, ECF/E4, ECF/E4-3KW, ACF/E4, ACF/E4-3KW, NCF/E4, ZCF/E4, ZCF/E4 | | |

6 operating positions

1

| | | | |
|--------------------|--|-----------------|--------|
| GEV No. | 301092 | Ref. No. | 058806 |
| description | cam switch 6 operating positions selection/ program shaft \varnothing 6x4.6mm connection male faston 7-pole | | |
| For models: | FCVE6-1U, FCVE6-3U, FCVE6-1, FCVE6-3, FCVE6-1UK, FCVE6-3UK, FCVE10-2, FCVE10-4, FCVE10-2UK, FCVE10-4UK, FCVE20-2, FCVE20-4, FCVE20-2UK, FCVE20-4UK, FCV/E6-1, FCV/E6-1, ZOFCV/E102, ZOFCV/E104, ZOFCV/E202, ZOFCV/E204 | | |

7 operating positions

1

| | | | |
|--------------------|---|-----------------|--------------------------------------|
| GEV No. | 300233 | Ref. No. | 002661 0K2019 245029 245034 |
| description | cam switch 7 operating positions shaft \varnothing 6x4.6mm shaft L 23mm 5-pole | | |
| For models: | FCV/G10L3, FCV/G6L3TOWNGAS, FCV/G6L3, FCVG10L3T, FCVG102L3, FCV/G20L3, FCVG202L3, FCVE6L3J, FCV/E10L3JAP, FCV/E102/1L3JAP, FCV/G6L3JAP, FCVG10L3J, FCVG102L3J, FCVG6L3CJ, FCV/E61/1, FCV/G10L2, FCV/E101/1, FCV/E10L2, FCV/E61/1, FCV/E101/2, FCV/G6L3C, FCV/G61/1, FCVG6L3CT, FCVG6L3CJ, FCV/E10L3, FCV/E102/1, FCV/E6L3, FCV/E102/1L3, FCV/E20L3, FCVE202L3, FCV/E101/1, FCS061E44J, FCS061G48J, FCS061G3DI, FCS061E3CI, FCS101E2, FCS061G4DT, FCS061G49J, FCS101G2, FCS201E4, FCS202E4, FCS201G4, FCS202G4, 5711-2-6, 5711-2-7, 5712-2-6, 5712-2-7, 5714-2-6, 5714-2-7, 5717-2-6...(Other models you can see in the webshop) | | |



8 operating positions

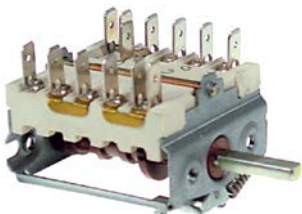

1

| | | | |
|--------------------|---|-----------------|------------------|
| GEV No. | 301094 | Ref. No. | 055017 780517 |
| description | cam switch 8 operating positions 7NO sequence 0-1-2-3-4-5-6-7 16A shaft \varnothing 6x4.6mm shaft L 23mm connection male faston 6.3mm ceramic | | |
| For models: | FCF/G6-0, FCFG101/0, FCFG102-0, FCFG201-0, FCFG202-0, FCF/E6-0, FCFE101-0, FCFE102-0, FCFE201-0, FCFE202-0, FCF061ELN, FCF101ELN, FCF6EHOR, FCFG10160H, FCFG102-0T, FCF/G6-1-JAP, FCF/G101/1-1-JAP, FCF/G102/1-1-JAP, FCFE6-1J, FCFE101-1J, FCFE102-1J, FCF/G101/1, FCFG10, FCFG10D, FCFG10NL, FCFE10, FCFE10UK, FCFG20, FCFG20D, FCFG20F, PFCFG20, FCFE20, FCFE20UK, FCFG40, FCFG41, FCFG40D, FCFG40F, PFCFG40F, FCFE40, FCFE40D, FCFE40UK, PFCFE40F, FCFG10J, FCFG10J, FCFE10J, FCFE10J, FCFG20J, FCFG20J, FCFE20J, FCFE20J...(Other models you can see in the webshop) | | |



| | | | |
|---|--|-----------------|------------------|
|  | | | |
| 1 | | | |
| GEV No. | 301238 | Ref. No. | 003761 005450 |
| description | cam switch 8 operating positions shaft \varnothing 6x4.6mm connection male faston 4-pole | | |
| For models: | 5702-2-2, 5702-2-3, 5704-2-2, 5704-2-3, 5707-2-2, 5707-2-3, 5701-3-2, 5701-3-3, 5702-3-2, 5702-3-3, 5704-3-2, 5704-3-3, 5707-3-2, 5707-3-3, JCF/G6-1, JCF/G101/1-1, JCF/G102/1-1, JCF/E6-1, JCF/E101/1-1, JCF/E102/1-1, JCF/G6-2, JCF/G101/1-2, JCF/G102/1-2, JCF/E6-2, JCF/E101/1-2, JCF/E102/1-2 | | |

| | | | |
|---|---|-----------------|---|
| operation switches | | | |
|  | | | |
|  | | | |
| 1 | | | |
| GEV No. | 300002 | Ref. No. | 00070 004908 0A2134 0G0268 0G0517 0G0921 0G2119 0H6605 0K3016 0K3500 0K4911 0K5472 0K9781 |
| description | cam switch 2 operating positions 4NO 16A sequence 0-1 shaft \varnothing 6x4.6mm shaft L 23mm connection male faston 6.3mm ceramic | | |
| For models: | BR/E1FL, BR/E1FR, BR/E2FL, BR/E2FR, MM/E700, MM/E700UK, MM/E700D, MG/E350D, MG/E350UK, MG/E700D, MG/E700UK, MG/E350, MG/E700, RR/E1FL, RR/E1FR, RR/E1CL, RR/E2FL, RR/E2FM, RR/E2CL, RRV/E1FL, RRV/E1FR, RRV/E1CL, RRV/E2FL, RRV/E2FM, RRV/E2CL, RR/E2CM, RG/E1, RG/E2, RGV/E1, RGV/E2, XR/E1FL, XR/E1FR, XR/E1CL, XR/E2FL, XR/E2FM, XR/E2CL, XRV/E1FL, XRV/E1FR, XRV/E1CL, XRV/E2FL, XRV/E2FM, XRV/E2CL, XG/E1, XG/E2, XGV/E1, XGV/E2, JR/E1FL, JR/E1FR, JR/E1CL, JR/E2FL...(Other models you can see in the webshop) | | |

| | | | |
|--|---|-----------------|---|
|  | | | |
| 1 | | | |
| GEV No. | 300080 | Ref. No. | 002164 01553PB 026945 0G3354 0K2928 0K3015 0K4968 0K8419 2317 |
| description | cam switch 2 operating positions 4NO 16A sequence 0-1 shaft \varnothing 6x4.6mm shaft L 23mm connection screw operation switch ceramic ambient temperature max. 150°C | | |
| For models: | MR/E350D, MR/E350UK, MR/E360, MR/E700D, MR/E700UK, MR/E710, MR/E720, MR/E715, MR/E725, MR/E350, MR/E700, MR/E720D, RR/E350D, RR/E350UK, 7FTEF3R, RR/E360UK, RR/E700D, RR/E700UK, RR/E710, RR/E710UK, 7FTEC7L, 7FTEF3L, 7FTEF7L, 7FTEC7M, XR/E350D, XR/E350UK, T36EFT, XR/E700D, XR/E700UK, T71EFT, T79EFT, T35EFT, T70EFT, CR/E720, RR/E300, RRE702, RR/E300UK, RR/E311, RR/E700, RR/E700UK, RR/E711, RM/E700, PRM/E700, RM/E700U, RRV/E300, RRV/E300, RRV/E311, RRV/E700, RRV/E700, RRV/E711...(Other models you can see in the webshop) | | |
| accessories for | 300080 | | |
| |  | GEV No. | 551456 |
| | | Ref. No. | — |
| | gasket for switch ED \varnothing 14mm ID \varnothing 2.5mm thickness 3.5mm white | | |

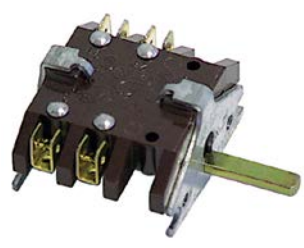
| | | | |
|--|--|-----------------|-----------------------|
|  | | | |
| 1 | | | |
| GEV No. | 300040 | Ref. No. | 0K2151 10302025000 |
| description | cam switch 2 operating positions operation switch 16A sequence 0-1 shaft \varnothing 6x4.6mm connection male faston 2-pole ambient temperature max. 270°C | | |
| For models: | 9100-3, 9101-3, 9102-3, 9104-3, 9106-3, 9108-3, 9111-3, 9113-2, 9113-3, 9114-2, 9114-3, 9115-2, 9115-3, 9116-2, 9116-3, 9171-3, 9172-3, 9173-3, 9174-3, 9175-3, 9176-3, 9181-3, 9182-3, 9183-3, 9184-3, 9185-3, 9300-3-0, 9300-3-8, 9301-3-0, 9301-3-8, 9302-3-0, 9302-3-8, 9304-3-0, 9304-3-8, 9306-3-0, 9306-3-8, 9308-3-0, 9311-3-0, 9311-3-8, 9313-3-0, 9313-3-8, 9314-3-0, 9314-3-8, 9315-3-0, 9315-3-8, 9316-3-0, 9316-3-8, 9317-3-8, 9371-3-0, 9371-3-8...(Other models you can see in the webshop) | | |

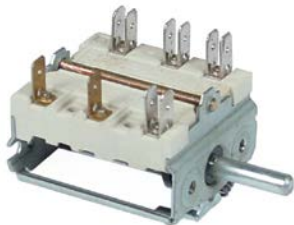
1

| | | | |
|--------------------|---|-----------------|--------|
| GEV No. | 301142 | Ref. No. | 055473 |
| description | cam switch 2 operating positions operation switch sequence 1-2 shaft \varnothing 6x4.6mm connection male faston 3-pole ambient temperature max. 270°C | | |
| For models: | FCVE20-V, FCVE20VUK, FCVM62E, FCVM62EUK, FCVMG62, ZOFCV/G6-3, FCV/E20-V | | |



1

| | | | |
|--------------------|---|-----------------|--------|
| GEV No. | 301095 | Ref. No. | 054324 |
| description | cam switch 4 operating positions operation switch sequence 0-1-2-3 shaft \varnothing 6x4.6mm connection male faston 3-pole ambient temperature max. 270°C | | |
| For models: | FCF/E4-OLD, FCF/E4D, FCFE4PH, FCF/E4OLD3, FCF/E4OLD4, FCF/E4OLD2, FCF/E4OLD1, FCF/E4D | | |



1

| | | | |
|--------------------|---|-----------------|--|
| GEV No. | 300200 | Ref. No. | 01C29 031481 054375 058125 0A2036 0H6589 0H6688 0H9802 0K4287 0K4443 0K4912 0K5045 0K8843 0KT763 0KW856 0M0524 12344145 6030015 722894 |
| description | operation switch 2 operating positions 2NO 16A sequence 0-1 shaft \varnothing 6x4.6mm shaft L 23mm connection male faston 6.3mm operation switch ceramic | | |
| For models: | TC1200TOP, TC1210TOP, TC1400TOP, TC1410TOP, TC1600TOP, TC1610TOP, TC1800TOP, TC1810TOP, TC2000TOP, TC2010TOP, TCD1200TOP, TCD1400TOP, TCD1600TOP, TCD1800TOP, TCD2000TOP, TC1000, TC1010, TC1200, TC1210, TC1400, TC1410, TC1600, TC1610, TC1800, TC1810, TC2000, TC2010, TCD1000, TCD1200, TCD1400, TCD1600, TCD1800, TCD2000, TC1200, TC1210, TC1400, TC1410, TC1600, TC1610, TC1800, TC1810, TC2000, TC2010, TCD1200, TCD1400, TCD1600, TCD1800, TCD2000, TC1000, TC1000...(Other models you can see in the webshop) | | |

miscellaneous

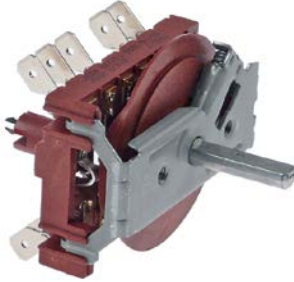

1

| | | | |
|--------------------|---|-----------------|--------|
| GEV No. | 301299 | Ref. No. | 0C6245 |
| description | cam switch 8 operating positions 5NO sequence 0-1-2-3-4-5-6-7 16A shaft \varnothing 6x4.6mm shaft L 23mm connection male faston 6.3mm plastic | | |
| For models: | FCF/E6-0, FCFE101-0, FCFE102-0, FCFE201-0, FCFE202-0, FCF061ELN, FCF101ELN, FCF6EHOR, FCF061ENS, FCF101ENS, FCF102ENS, FCF201ENS, FCFE6-1J, FCFE101-1J, FCFE102-1J, ECF/E6-0, ECFE101-0, ECFE102-0, ECFE201-0, ECFE202-0, ECF061ENS, ECF101ENS, ECF102ENS, ECF201ENS, ECF061E5M, ECF061ECV, ACF/E6-0, ACFE101-0, ACFE102-0, ACFE201-0, ACFE202-0, RCF061E, RCF101E, RCF201E | | |

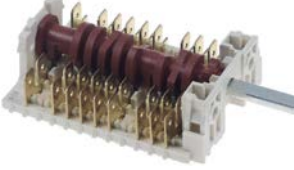

1

| | | | |
|--------------------|--|-----------------|--------|
| GEV No. | 345198 | Ref. No. | 0E3697 |
| description | cam switch shaft \varnothing 6x4.6mm shaft L 23mm 6-pole | | |
| For models: | FCV31E3, 7CO30, CCO30G, ECO312CF, OTS100 | | |

rotary switches

BREMAS

A1600 series



1

| | | | |
|--------------------|--|-----------------|--------------------|
| GEV No. | 345315 ¹ | Ref. No. | 004156 91310060 |
| description | rotary switch 3 1-0-2 sets of contacts 6 type CA160007 400V 16A shaft \varnothing 5x5mm shaft L 23mm shaft square with knob connection screw | | |
| For models: | ZCMME6, ZCBME12, ZCMME4, ZCBME8, ZCMME9, ZCBME18, PME430, PME630, PME6L30, PME930, PME435, PME635, PME6L35, PME935, PME830, PME1230, PME12L30, PME1830, PME835, PME1235, PME12L35, PME1835 | | |

¹incl. knob



M10x1



| | | | |
|--------------------|---|-----------------|--------|
| 1 | | | |
| GEV No. | 346376 | Ref. No. | 056468 |
| description | magnetic switch thread M10x1 L 40mm 1NO 250V 1A connection cable 50W | | |
| For models: | 7CPE07P, 7CPG07P, M70EPC, M70GPC, FCVE6-1U, FCVE6-3U, FCVE6-1, FCVE6-3, FCVE6-1UK, FCVE6-3UK, FCVG6-1, FCVG6-3, FCVG6-1UK, FCVG6-3UK, FCV/E6-1, FCV/E6-1, FCV/G6-1, ZOFV/G6-3, AFCV/G6-1, AFCV/G6-3, RCP/G700 | | |

accessories

magnets

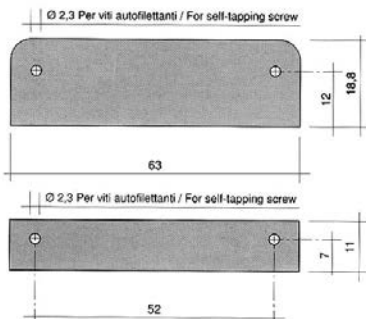

| | | | |
|---|--|-----------------|-----------------|
| 1 | | | |
| GEV No. | 519049 | Ref. No. | 049627 |
| description | magnet ømm L 63mm H 10.7mm W 18.8mm hole distance 52mm M2 hole ø 2mm | | |
| For models: | FCZ061EAA, FCZ101EAA, FCZ102EAA, FCZ201EAA, FCZ202EAA, FCZ061EAH, FCZ101EAH, FCZ201EAH, FCZ061EAN, FCZ101EAN, FCZ201EAN, FCZ061ETA, FCZ101ETA, FCZ102ETA, FCZ201ETA, FCZ202ETA, FCZ061ETH, FCZ101ETH, FCZ201ETH, FCZ061ETN, FCZ101ETN, FCZ201ETN, FCZ061GAG, FCZ101GAG, FCZ102GAG, FCZ202GAG, FCZ061GAD, FCZ101GAD, FCZ102GAD, FCZ202GAD, FCZ101GTG, FCZ102GTG, FCZ101GTD, FCZ102GTD, FCZ061EBA, FCZ101EBA, FCZ102EBA, FCZ201EBA, FCZ202EBA, FCZ061EBH, FCZ101EBH, FCZ201EBH, FCZ061EBN, FCZ101EBN, FCZ201EBN, FCZ061EBC, FCZ101EBC, FCZ201EBC, FCZ061EBA2, FCZ101EBA2...(Other models you can see in the webshop) | | |
| accessories for | 519049 | | |
| | GEV No. | 560095 | Ref. No. |
|  | sheet metal screws ø 2.9mm L 9.5mm SS Qty 20 pcs DIN 7981/ISO 7049 head ø 5.6mm oval head | | |

control equipment

MOELLER/EATON

switch blocks



| | | | |
|--------------------|--|-----------------|--------|
| 1 | | | |
| GEV No. | 346292 | Ref. No. | 0K2181 |
| description | contact block screw 1NO | | |
| For models: | 7573-2, 7574-2, 7575-2, 7576-2, 7773-2, 7774-2, 7775-2, 7776-2 | | |

GEV special

ø16mm

push buttons



| | | | |
|--------------------|---|-----------------|------------------|
| 1 | | | |
| GEV No. | 345754 | Ref. No. | 005139 0H6288 |
| description | push button square clear ø 16mm | | |
| For models: | FCVG202L3, FCS201G4, FCS202G4, 5717-2-6, 5714-2-7, 5714-2-6L, 5714-2-7L, ECVG202T4, ACVG202C4, ZCV/G202/1, 9100-2, 9101-2, 9102-2, 9104-2, 9113-2, 9114-2, 9115-2, 9116-2 | | |



| | | | |
|--------------------|---|-----------------|------------------|
| 1 | | | |
| GEV No. | 345751 | Ref. No. | 005138 0H6286 |
| description | contact block 2NO/2NC | | |
| For models: | FCVG202L3, FCS201G4, FCS202G4, FCS202GP, 5717-2-6, 5714-2-7, 5714-2-6L, 5714-2-7L, ECVG202T4, ACVG202C4, ZCV/G202/1 | | |

switches



| | | | |
|--------------------|---|-----------------|----------------------------|
| 1 | | | |
| GEV No. | 345753 | Ref. No. | 005137 0H6285 512850 |
| description | switch mounting measurements ø16mm latching | | |
| For models: | FCVG202L3, FCS201G4, FCS202G4, 5717-2-6, 5714-2-7, 5714-2-6L, 5714-2-7L, ECVG202T4, ACVG202C4, ZCV/G202/1 | | |



TELEMECANIQUE (EFA)

XB4 series

switches (complete)





1

| | | | |
|--------------------|---|-----------------|------------------|
| GEV No. | 347525 | Ref. No. | OH2641 OK9113 |
| description | push button mounting measurements ø22mm green 2NO 240V 2-pole 3A illuminated | | |
| For models: | D820, D820, D820, D820, D840, D840, HC-AR, AR85, AR85, AR85, AR85, AR85, AR85, AR85, AR85, HC-CS, EBS50L, EBS100L, EBA100L, EBP100L, EBS200L, EBA200L, EBP200L, EBS300L, EBA300L, EBP300L | | |

lamps



1

| | | | |
|---|--|-----------------|--|
| GEV No. | 359606 | Ref. No. | OH9799 OK2043 OK4896 OK4897 176769 |
| description | neon light bulb socket Ba9s 230V 2W clear ø 10mm L 28mm | | |
| For models: | 7573-2, 7574-2, 7575-2, 7576-2, 7773-2, 7774-2, 7775-2, 7776-2 | | |
| accessories for | 359606 | | |
|  | GEV No. | 359832 | Ref. No. — |
| | lamp socket mounting measurements ø16.2mm socket Ba9s connection male faston 6.3mm | | |
|  | GEV No. | 359853 | Ref. No. — |
| | lamp socket mounting measurements ø18.2mm socket Ba9s connection male faston 6.3mm | | |

encoders and potentiometers



1

| | | | |
|--------------------|--|-----------------|--------|
| GEV No. | 403557 | Ref. No. | OC0974 |
| description | potentiometer 0.6kOhm shaft ø 6mm shaft L 14mm thread M9 plug type male faston cable length 155mm | | |
| For models: | FCS061GP, FCS061EP, FCS101EP4J, FCS101EP, FCS101GP9J, FCS102EP4J, FCS101GP, FCS102EP, FCS102GA9J, FCS201EP, FCS102GP, FCS202EP, FCS201GP, FCS202GP, FCS061EXLN, FCS061EX, FCS101EX4J, FCS101EXLN, FCS101EX, FCS102EX4J, FCS102EX, FCS201EX, FCS201EXLN, FCS202EX, FCS101GX9J, FCS101GX, FCS102GX9J, FCS102GX, FCS201GX, FCS202GX | | |

lamps

indicator lights

indicator lights 2-piece (lens and indicator lamp)

indicator light lenses

ø 6mm (type SQ-20)



1

| | | | |
|--------------------|---|-----------------|--|
| GEV No. | 359803 | Ref. No. | 054151 0HB189 OK2899 OK9373 6608012 660801201 |
| description | indicator light lens green Qty 1 pcs ø 6mm | | |
| For models: | RC/E320, RC/E320U, RC/E720, RC/E720, RCF/GE720, RCF/GE730, RCF/GE720, RCF/GE720, RCV/G320, RCV/E720, RCFE720, RCF/E720, RR/E300, RRE702, RR/E300UK, RR/E311, RR/E700, RR/E700UK, RR/E711, RG/E300, PRG/E300, RG/E300UK, RG/E700, PRG/E700, RG/E700U, RME300, PRM/E300, M/E300UK, RM/E700, PRM/E700, RM/E700U, RFR/E302, RFR/E302UK, RFR/E305, RFR/E305, RFR/E701, RFR/E701, RFR/E312, RFR/E312, RFR/E315, RFR/E315, RFR/E711, RFR/E711U, RRV/E300, RRV/E300, RRV/E311, RRV/E700, RRV/E700, RRV/E711, RMV/E300...(Other models you can see in the webshop) | | |





1

| | | | |
|--------------------|---|-----------------|----------------------------|
| GEV No. | 359804 | Ref. No. | 053812 056706 075589 |
| description | indicator light lens yellow Qty 1 pcs ø 6mm | | |
| For models: | WMGHUK, RCF/GE720, RCF/GE730, RCF/GE720, RCF/GE720, RCFE720, RCF/E720, RR/E300, RRE702, RR/E300UK, RR/E311, RR/E700, RR/E700UK, RR/E711, RME300, PRM/E300, M/E300UK, RM/E700, PRM/E700, RM/E700U, RFR/E302, RFR/E302UK, RFR/E305, RFR/E305, RFR/E701, RFR/E701, RFR/E701, RFR/E312, RFR/E312, RFR/E315, RFR/E315, RFR/E711, RFR/E711U, RRV/E300, RRV/E300, RRV/E311, RRV/E700, RRV/E700, RRV/E711, RMV/E300, PRMV/E300, RMV/E300UK, RMV/E700, PRMV/E700, RMV/E700, RMAE700, PRMA/E700, RMA/E700, RPN/EI760, RPN/EI760, RFR/G301...(Other models you can see in the webshop) | | |





| ø10mm (type SRZ-3) | | | | | | | |
|--|--|-----------------|-------------------------------------|----------------|--------|-----------------|---------------------------|
|  <p>1</p> | | | | | | | |
| GEV No. | 359123 | Ref. No. | 00053 004896 0K3498 0K1364 | | | | |
| description | indicator light housings mounting measurements ø10mm green round Qty 1 pcs | | | | | | |
| For models: | SCE350, SCE700, SCFE700, SIE350, SVE700, SRE350, SRE360, SRE370, SRE700, SRE710, SRE720, SFRE700, SCCE350, SME350, SME700, SGE350, SBRE350, SCPE350, SCE350, SCE700, SCFE700, SIE350, SVE700, SRE350, SRE360, SRE370, SRE700, SRE710, SRE720, SFRE350, SFRE700, SCCE350, SME350, SME700, SGE350, SBRE350, SCPE350, PC35E6U, PC70E6U, BM35E6U, FTL35E6U, FTR35E6U, FTC35E6U, FT-L70E6U, FTR70E6U, FTC70E6U, SFRE350, SFRE351, SFRE700, SFRE701... (Other models you can see in the webshop) | | | | | | |
| accessories for | 359123 | | | | | | |
|  <table border="1"> <tr> <td>GEV No.</td> <td>359132</td> <td>Ref. No.</td> <td>00052 004895 0K3497</td> </tr> </table> <p>indicator lamp green 250V connection male faston 6.3mm protection IP54 ambient temperature max. 85°C</p> | | | | GEV No. | 359132 | Ref. No. | 00052 004895 0K3497 |
| GEV No. | 359132 | Ref. No. | 00052 004895 0K3497 | | | | |

| | | | | | | | |
|--|---|-----------------|---------------------------|----------------|--------|-----------------|---------------------------|
|  <p>1</p> | | | | | | | |
| GEV No. | 359124 | Ref. No. | 00319 004928 0K3526 | | | | |
| description | indicator light housings mounting measurements ø10mm yellow round Qty 1 pcs | | | | | | |
| For models: | SFRE700, SFRE350, SFRE700, SFRE350, SFRE351, SFRE700, SFRE701 | | | | | | |
| accessories for | 359124 | | | | | | |
|  <table border="1"> <tr> <td>GEV No.</td> <td>359132</td> <td>Ref. No.</td> <td>00052 004895 0K3497</td> </tr> </table> <p>indicator lamp green 250V connection male faston 6.3mm protection IP54 ambient temperature max. 85°C</p> | | | | GEV No. | 359132 | Ref. No. | 00052 004895 0K3497 |
| GEV No. | 359132 | Ref. No. | 00052 004895 0K3497 | | | | |

| ø13mm (type SFK-3) | | | |
|--|---|-----------------|--------|
|  <p>1</p> | | | |
| GEV No. | 359225 | Ref. No. | 046289 |
| description | indicator light housings mounting measurements ø13mm clear Qty 1 pcs | | |
| For models: | LS360F, LS360DK, LS365F, LS365, LS365PH, LS500F, LS501F, LS540F, LS540DK, LS541F, LS360D, LS365D, LS360, LS365, LS360/63, LS365/63, LS367, LS720F, LSE720DK, LSE720PH, LS860F, LS860DK, LS860PH, LS1080F, LS1080UK, LS1080PH, LSE721F, LS861F, LS540, LS1080M, LS1080, LS1080D, LS1080UK, LS1080/63, LS500F, LS500UK, LS501, LS501UK, LS540D, LS540/63, LSE721, LS720, LSE720UK, LS721UK, LSE720D, LS541, LS860, LS860D, LS860UK... (Other models you can see in the webshop) | | |

| | | | |
|--|--|-----------------|----------------------------|
|  <p>1</p> | | | |
| GEV No. | 359126 | Ref. No. | 075096 0C2587 0L3030 |
| description | indicator light housings mounting measurements ø13mm green Qty 1 pcs | | |
| For models: | TC1200TOP, TC1210TOP, TC1400TOP, TC1410TOP, TC1600TOP, TC1610TOP, TC1800TOP, TC1810TOP, TC2000TOP, TC2010TOP, TCD1200TOP, TCD1400TOP, TCD1600TOP, TCD1800TOP, TCD2000TOP, TC1000, TC1010, TC1200, TC1210, TC1400, TC1410, TC1600, TC1610, TC1800, TC1810, TC2000, TC2010, TCD1000, TCD1200, TCD1400, TCD1600, TCD1800, TCD2000, TC1000, TC1000, TC1010, 134TCA0, TCD1000, TCD1000, TC1400, TC1400, TCD1410, TCD1400, TC1410, 4061410, TC1600, TC1600, TC1610, TC1610, TCD1600... (Other models you can see in the webshop) | | |

| | | | |
|--|--|-----------------|---|
|  <p>1</p> | | | |
| GEV No. | 359127 | Ref. No. | 031611 075095 0C2182 0HB339 665601400 |
| description | indicator light housings mounting measurements ø13mm yellow Qty 1 pcs | | |
| For models: | TC1200TOP, TC1210TOP, TC1400TOP, TC1410TOP, TC1600TOP, TC1610TOP, TC1800TOP, TC1810TOP, TC2000TOP, TC2010TOP, TCD1200TOP, TCD1400TOP, TCD1600TOP, TCD1800TOP, TCD2000TOP, TC1000, TC1010, TC1200, TC1210, TC1400, TC1410, TC1600, TC1610, TC1800, TC1810, TC2000, TC2010, TCD1000, TCD1200, TCD1400, TCD1600, TCD1800, TCD2000, TC1200, TC1210, TC1400, TC1410, TC1600, TC1610, TC1800, TC1810, TC2000, TC2010, TCD1200, TCD1400, TCD1600, TCD1800, TCD2000, LPS/75, LPS/75... (Other models you can see in the webshop) | | |

| indicator lamps for socket type SQ | | | | | | | |
|--|--|-----------------|--|----------------|--------|-----------------|---|
|  <p>1</p> | | | | | | | |
| GEV No. | 359109 | Ref. No. | 054150 0HB138 0K2894 6608011 660801101 | | | | |
| description | indicator lamp 230V green connection male faston 6.3mm no lens ø 6mm | | | | | | |
| For models: | RC/E320, RC/E320U, RC/E720, RC/E720, RCF/GE720, RCF/GE730, RCF/GE720, RCF/GE720, RCV/G320, RCV/E720, RCFE720, RCF/E720, RR/E300, RRE702, RR/E300UK, RR/E311, RR/E700, RR/E700UK, RR/E711, RG/E300, PRG/E300, RG/E300UK, RG/E700, PRG/E700, RG/E700U, RME300, PRM/E300, M/E300UK, RM/E700, PRM/E700, RM/E700U, RFRE302, RFR/E302UK, RFRE305, RFR/E305, RFR/E701, RFR/E701, RFRE312, RFR/E312, RFRE315, RFR/E315, RFR/E711, RFR/E711U, RRV/E300, RRV/E300, RRV/E311, RRV/E700, RRV/E700, RRV/E711, RMV/E300... (Other models you can see in the webshop) | | | | | | |
| accessories for | 359109 | | | | | | |
|  <table border="1"> <tr> <td>GEV No.</td> <td>359806</td> <td>Ref. No.</td> <td>—</td> </tr> </table> <p>indicator light lens clear Qty 1 pcs ø 6mm</p> | | | | GEV No. | 359806 | Ref. No. | — |
| GEV No. | 359806 | Ref. No. | — | | | | |







| | | | |
|---|---|-----------------|---|
|  | | | |
| GEV No. | 359110 | Ref. No. | 053811 056707 06601 0K9372 0KE182 |
| description | indicator lamp 230V white connection male faston 6.3mm no lens ø 6mm | | |
| For models: | TC1000, TC1000, TC1010, 134TCA0, TCD1000, TCD1000, TC1400, TC1400, TCD1410, TCD1400, TC1410, 4061410, TC1600, TC1600, TC1610, TC1610, TCD1600, TCD1600, TC2000, TC2000, TCD2000, TCD2000, TC2010, TC2010, RCF/GE720, RCF/GE730, RCF/GE720, RCF/GE720, RCF/GE720, RCF/E720, RR/E300, RRE702, RR/E300UK, RR/E311, RR/E700, RR/E700UK, RR/E711, RME300, PRM/E300, M/E300UK, RM/E700, PRM/E700, RM/E700U, RFRE302, RFR/E302UK, RFRE305, RFR/E305, RFR/E701, RFR/E701, RFRE312...(Other models you can see in the webshop) | | |

| | | | |
|---|---|-----------------|---|
| indicator lamps for socket type SRZ / SDK / SDY / SFK | | | |
|  | | | |
| GEV No. | 359130 | Ref. No. | 031607 046076 046241 048488 048691 048832 072049 0C0249 0HA088 0HB343 0W1E5Y 0W3318 20042 655600901 9020042 |
| description | indicator lamp 230V clear connection male faston 6.3mm ø 8mm | | |
| For models: | TC1200TOP, TC1210TOP, TC1400TOP, TC1410TOP, TC1600TOP, TC1610TOP, TC1800TOP, TC1810TOP, TC2000TOP, TC2010TOP, TCD1200TOP, TCD1400TOP, TCD1600TOP, TCD1800TOP, TCD2000TOP, TC1000, TC1010, TC1200, TC1210, TC1400, TC1410, TC1600, TC1610, TC1800, TC1810, TC2000, TC2010, TCD1000, TCD1200, TCD1400, TCD1600, TCD1800, TCD2000, TC1200, TC1210, TC1400, TC1410, TC1600, TC1610, TC1800, TC1810, TC2000, TC2010, TCD1200, TCD1400, TCD1600, TCD1800, TCD2000, TC1000, TC1000...(Other models you can see in the webshop) | | |

| | | | |
|---|--|-----------------|---------------------------|
|  | | | |
| GEV No. | 359132 | Ref. No. | 00052 004895 0K3497 |
| description | indicator lamp green 250V connection male faston 6.3mm protection IP54 ambient temperature max. 85°C | | |
| For models: | SCE350, SCE700, SCFE700, SIE350, SVE700, SRE350, SRE360, SRE370, SRE700, SRE710, SRE720, SFRE700, SCCE350, SME350, SME700, SGE350, SBRE350, SCPE350, SCFGE700, SCFGE1050, SCE350, SCE700, SCFE700, SIE350, SVE700, SRE350, SRE360, SRE370, SRE700, SRE710, SRE720, SFRE350, SFRE700, SCCE350, SME350, SME700, SGE350, SBRE350, SCPE350, SCFGE700, SCFGE1050, PC35E6U, PC70E6U, BM35E6U, FTL35E6U, FTR35E6U, FTC35E6U, FTL70E6U, FTR70E6U, FTC70E6U...(Other models you can see in the webshop) | | |

| | | | |
|--|--|-----------------|----------------------------|
| indicator lights 3-piece (housing, lens and bulb) | | | |
| lamps | | | |
| light bulbs | | | |
|  | | | |
| GEV No. | 359656 | Ref. No. | 0H2639 0K9109 0KC506 |
| description | light bulb socket Ba9s 130V 2W ø 10mm L 28mm | | |
| For models: | AR85, AR85, AR85, AR85, AR85, AR85, AR85, AR85, HC-CS, EBS50L, EBS100L, EBA100L, EBP100L, EBS200L, EBA200L, EBP200L, EBS300L, EBA300L, EBP300L | | |

| | | | |
|---|--|-----------------|--|
| neon light bulbs | | | |
|  | | | |
| GEV No. | 359606 | Ref. No. | 0H9799 0K2043 0K4896 0K4897 176769 |
| description | neon light bulb socket Ba9s 230V 2W clear ø 10mm L 28mm | | |
| For models: | 7573-2, 7574-2, 7575-2, 7576-2, 7773-2, 7774-2, 7775-2, 7776-2 | | |
| accessories for | 359606 | | |
|  | GEV No. | 359832 | Ref. No. — |
| | lamp socket mounting measurements ø16.2mm socket Ba9s connection male faston 6.3mm | | |
|  | GEV No. | 359853 | Ref. No. — |
| | lamp socket mounting measurements ø18.2mm socket Ba9s connection male faston 6.3mm | | |

| | | | |
|---|---|-----------------|---|
|  | | | |
| GEV No. | 359602 | Ref. No. | 002592 07150205 0H7036 0H7144 0K3356 0K4892 0K9814 0KC231 188211410 30001874 |
| description | neon light bulb socket E14 230V clear ø 14mm L 30mm | | |
| For models: | BE1-TA.3, BE1-W.3, BE1-WS-M.3, BE2-A-C.3, BE2-A-M.3, BE2-WS-C.3, BE2-WS-M.3, BE3-C.3, BE3-M.3, BE1-WS-C.3 | | |





| | | | |
|--|---|-----------------|---|
|  <p>1</p> | | | |
| GEV No. | 359603 | Ref. No. | 002585 052204 07150215 0G0967 0H7037 0K4893 0K7293 0K9813 0KC232 188211420 565628 |
| description | neon light bulb socket E14 380V clear ø 14mm L 30mm | | |
| For models: | BE1-TA.3, BE1-W.3, BE1-WS-M.3, BE2-A-C.3, BE2-A-M.3, BE2-WS-C.3, BE2-WS-M.3, BE3-C.3, BE3-M.3, BE1-WS-C.3 | | |

| indicator lights (complete) | | | |
|--|----------------------------------|-----------------|---------------|
| ø 6mm | | | |
|  <p>1</p> | | | |
| GEV No. | 359031 | Ref. No. | 054150+054151 |
| description | indicator light ø 6mm 230V green | | |

| | | | |
|---|-----------------------------------|-----------------|---------------|
|  <p>1</p> | | | |
| GEV No. | 359032 | Ref. No. | 053811+053812 |
| description | indicator light ø 6mm 230V yellow | | |

| ø10mm | | | |
|--|--|-----------------|---|
| with screw socket | | | |
|  <p>1</p> | | | |
| GEV No. | 359378 | Ref. No. | 0A2224 0G2390 0H6615 0K2046 0KD884 0KI684 0U4330 63406 7GBN6326 |
| description | indicator light ø 10mm 230V green connection male faston 6.3mm socket screw base | | |
| For models: | 5702-2-2, 5702-2-3, 5704-2-2, 5704-2-3, 5707-2-2, 5707-2-3, 5701-3-2, 5701-3-3, 5702-3-2, 5702-3-3, 5704-3-2, 5704-3-3, 5707-3-2, 5707-3-3, ROMA/E500, BOFR/G500, ROFR/G1000, ROBR/G1000, ROBR/G1010, ROBR/G1510, ROPN/G1000, ROPN/G1015, ROPN/G1020, ROM/E500, 5611-3-6, 5612-3-6, 5614-3-6 | | |

| | | | |
|--|--|-----------------|---|
|  <p>1</p> | | | |
| GEV No. | 359380 | Ref. No. | 0A2408 0KI685 0KV042 6327 63408 |
| description | indicator light ø 10mm 230V red connection male faston 6.3mm socket screw base | | |
| For models: | MVR/E1400, MVR/E1050, MVR/E1060, 7BAE10C, 7BAE14S, 7BAE10S, B105RC, B140RC, KVRC/E3, HVR/E1200, QVRC/E3, WVRC/E3, MVR/E3C, MVR/E3, MVR/E4C, MVR/E4 | | |

| | | | |
|--|--|-----------------|--------|
|  <p>1</p> | | | |
| GEV No. | 359379 | Ref. No. | 0A2225 |
| description | indicator light ø 10mm 230V yellow connection male faston 6.3mm socket screw base | | |
| For models: | ROMA/E500, BOFR/G500, ROFR/G1000, ROBR/G1000, ROBR/G1010, ROBR/G1510, ROPN/G1000, ROPN/G1015, ROPN/G1020, ROM/E500 | | |

| with plug-in socket | | | |
|--|---|-----------------|----------------------------|
|  <p>1</p> | | | |
| GEV No. | 359139 | Ref. No. | 004169 058544 0K2965 |
| description | indicator light ø 10mm green 230V connection male faston 6.3mm Qty 1 pcs | | |
| For models: | MCP/E700, MCP/E700D, FDV40G, FDV40E, FDV40GZ, FDV40EL, FDV40GA, FDV20G, FDV20E, FDV20GZ, FDV20EL, FDV20GA, 7CPE07P, M70EPC, CCP/E700, FCF/G6-0, FCFG101/0, FCFG102-0, FCFG201-0, FCFG202-0, FCF/E6-0, FCFE101-0, FCFE102-0, FCFE201-0, FCFE202-0, FCF061ELN, FCF101ELN, FCF6EHOR, FCFG10160H, FCF061ENS, FCF101ENS, FCF102ENS, FCF201ENS, FCFG102-0T, FCF/G6-1-JAP, FCF/G101/1-1-JAP, FCF/G102/1-1-JAP, FCFE6-1J, FCFE101-1J, FCFE102-1J, FCF/G101/1, FCF/E2, FCF/E2D, FCF/E2UK, FCF/E4-OLD, FCF/E4D, FCFE4PH, FCFG6D, FCFE6D, FCFE6D...(Other models you can see in the webshop) | | |

| | | | |
|--|--|-----------------|--------------------------------------|
|  <p>1</p> | | | |
| GEV No. | 359138 | Ref. No. | 005214 056429 0C3052 0C4181 |
| description | indicator light ø 10mm red 230V connection male faston 6.3mm Qty 1 pcs | | |
| For models: | FCF/E4, FCF/E4-3KW, FCF4E, FCF4E-3KW, ECF4E, ECF4E3KW, JCF/E4, JCF/E4, ECF/E4, ECF/E4-3KW, ACF/E4, ACF/E4-3KW, ACF4E, ACF4E3KW, NCF/E4, ZCF/E4, ZCF/E4 | | |

| | | | |
|---|--|-----------------|------------------|
|  | | | |
| 1 | | | |
| GEV No. | 359140 | Ref. No. | 005215 058522 |
| description | indicator light ø 10mm yellow 230V connection male faston 6.3mm Qty 1 pcs | | |
| For models: | FDV40G, FDV40E, FDV40GZ, FDV40EL, FDV40GA, FDV20G, FDV20E, FDV20GZ, FDV20EL, FDV20GA, FCF/G6-0, FCFG101/0, FCFG102-0, FCFG201-0, FCFG202-0, FCF/E6-0, FCFE101-0, FCFE102-0, FCFE201-0, FCFE202-0, FCF061ELN, FCF101ELN, FCF6EHOR, FCFG10160H, FCF061ENS, FCF101ENS, FCF102ENS, FCF201ENS, FCFG102-0T, FCF/G6-1-JAP, FCF/G101/1-1-JAP, FCF/G102/1-1-JAP, FCFE6-1J, FCFE101-1J, FCFE102-1J, FCF/G101/1, FCF/E4, FCF/E4-3KW, FCF/E2, FCF/E2D, FCF/E2UK, FCF/E4-OLD, FCF/E4D, FCFE4PH, FCFG6D, FCFE6D, FCFE6D, FCFG10, FCFG10D, FCFG10NL...(Other models you can see in the webshop) | | |

| | | | |
|---|--|-----------------|--------|
| ø12mm | | | |
| with screw socket | | | |
|  | | | |
| 1 | | | |
| GEV No. | 359027 | Ref. No. | 003531 |
| description | indicator light ø 12mm 250V green connection male faston 6.3mm | | |
| For models: | HPN/EI855, HPN/EI1255, ZPN/EI1255 | | |

| | | | |
|---|---|-----------------|---|
| ø14mm | | | |
| with plug-in socket | | | |
|  | | | |
| 1 | | | |
| GEV No. | 359151 | Ref. No. | 026456 053148 053154 068694 0HB053 0W2002 4619400 |
| description | indicator light ø 14mm green 400V connection male faston 6.3mm temp.-resist. 120°C | | |
| For models: | HCF/E800, HCF/E800UK, HCF/E800, HCF/GE81, HCF/GE81, HCF/GE80, HCF/GE80, HRS/E401, HRS/E401UK, HRS/E411, HRS/E801, HRS/E801U, HRS/E802, HRS/E812, HRS/E811, HRA/E802, HR/E401T, HR/E411, HR/E801T, HR/E811T, HR/E802, HMS/E400, HMS/E800, HMA/E800, HMS/E400, HMS/E800, HMA/E800, HM/E400T, HM/E800T, HQN/EI917, HQN/EI1225, HPN/E810, HPN/EI810, HPN/E815, HPN/EI810, HPA/EI810, HBR/G803, HBR/G804, HBR/G803, HBR/G804, HBR/G803, HBR/G805, HBR/G1003, HBR/G1003, HBR/G1004, HBR/E801, HBR/E803, HBR/E804, HBR/E805UK, HBR/E1003...(Other models you can see in the webshop) | | |

| | | | |
|---|---|-----------------|--|
|  | | | |
| 1 | | | |
| GEV No. | 359150 | Ref. No. | 026385 053150 053153 068624 0K7814 |
| description | indicator light ø 14mm red 400V connection male faston 6.3mm temp.-resist. 105°C square | | |
| For models: | HQN/EI917, HQN/EI1225, HPN/E810, HPN/EI810, HPN/E815, HPN/EI810, HPA/EI810, HBR/G803, HBR/G804, HBR/G803, HBR/G804, HBR/G803, HBR/G805, HBR/G1003, HBR/G1003, HBR/G1004, HBR/E803, HBR/E804, HBR/E805UK, HBR/E1003, HBR/G803, HBR/G804, HBR/G1013, HBR/E1013, HCP/E800, HCP/E400, HBR/G803, HBR/G804, HBR/G1003, HBR/G1013, HBR/E803, HBR/E804, HBR/E1003, HBR/E1013, HPN/E810, HPN/E815, HPN/EI810, HPN/EI810, HPA/EI815, HQNEI817, HQNEI122 | | |

| | | | |
|---|---|-----------------|--------------------------------------|
|  | | | |
| 1 | | | |
| GEV No. | 359152 | Ref. No. | 045272 053149 053155 068625 |
| description | indicator light ø 14mm yellow 400V connection male faston 6.3mm temp.-resist. 105°C square | | |
| For models: | HCF/E800, HCF/E800UK, HCF/E800, HCF/GE81, HCF/GE81, HCF/GE80, HCF/GE80, HRS/G802, HRS/G812, HRS/E411, HRS/E801U, HRS/E802, HRS/E812, HRA/G802, HRA/E802, HR/E411, HR/E802, HMS/E400, HMS/E800, HMA/E800, HMS/E400, HMS/E800, HMA/E800, HM/E400T, HM/E800T, HBR/G803, HBR/G804, HBR/G803, HBR/G804, HBR/G803, HBR/G805, HBR/G1003, HBR/G1003, HBR/G1004, HBR/E801, HBR/E803, HBR/E804, HBR/E805UK, HBR/E1003, HBR/G803, HBR/G804, HBR/G1013, HBR/E1013, HFR/G420, HFR/G420NL, HFR/G840, HFR/G840, HFR/G840, HFR/G840...(Other models you can see in the webshop) | | |

| | | | |
|---|---|-----------------|--|
| ø19mm | | | |
|  | | | |
| 1 | | | |
| GEV No. | 359519 | Ref. No. | 002584 0H2175 0K4898 0K7286 0KE384 30000074 |
| description | indicator light housings mounting measurements ø19mm socket E14 clear | | |
| For models: | BE1-TA.3, BE1-W.3, BE1-WS-M.3, BE2-A-C.3, BE2-A-M.3, BE2-WS-C.3, BE2-WS-M.3, BE3-C.3, BE3-M.3, BE1-WS-C.3 | | |

| | | | |
|---|--|-----------------|--------|
| 30x22mm | | | |
|  | | | |
| 1 | | | |
| GEV No. | 359156 | Ref. No. | 0KM981 |
| description | indicator light mounting measurements 30x22mm 230V yellow connection male faston 6.3mm temp.-resist. 125/55°C type RL2 | | |







| 33x10mm | | | |
|---|---|-----------------|--------|
|  | | | |
| 1 | | | |
| GEV No. | 359842 | Ref. No. | 056501 |
| description | indicator light mounting measurements 33x10mm 24V white | | |
| For models: | FCVE6-3CE, FCVE103CE, FCVE203CE, FCVM62E, FCVM62EUK, FCV-MG62, AFCV/G6-1, AFCV/G6-3, SCO/G6-3, AFCV/G101, AFCV/G103, SCO/G10-3, AFCV/G201, AFCV/G203, SCO/G20-3 | | |

| blank elements | | | |
|---|--|-----------------|------------------|
|  | | | |
| 1 | | | |
| GEV No. | 359844 | Ref. No. | 005212 0C3049 |
| description | indicator light lens red ø 6mm | | |
| For models: | FCF/E4, FCF/E4-3KW, FCF4E, FCF4E-3KW, ECF4E, ECF4E3KW, JCF/E4, JCF/E4, ECF/E4, ECF/E4-3KW, ACF/E4, ACF/E4-3KW, ACF4E, ACF4E3KW, NCF/E4, ZCF/E4, ZCF/E4 | | |

| | | | |
|---|--|-----------------|--------|
|  | | | |
| 1 | | | |
| GEV No. | 359845 | Ref. No. | 005211 |
| description | indicator light lens yellow ø 6mm | | |
| For models: | FCF/E4, FCF/E4-3KW, FCF4E, FCF4E-3KW, ECF4E, ECF4E3KW, JCF/E4, JCF/E4, ECF/E4, ECF/E4-3KW, ACF/E4, ACF/E4-3KW, ACF4E, ACF4E3KW, NCF/E4, ZCF/E4, ZCF/E4 | | |

screw-on/push-on fit

| neon light bulbs | | | |
|---|--|-----------------|--|
|  | | | |
| 1 | | | |
| GEV No. | 359606 | Ref. No. | 0H9799 0K2043 0K4896 0K4897 176769 |
| description | neon light bulb socket Ba9s 230V 2W clear ø 10mm L 28mm | | |
| For models: | 7573-2, 7574-2, 7575-2, 7576-2, 7773-2, 7774-2, 7775-2, 7776-2 | | |
| accessories for | 359606 | | |
|  | GEV No. | 359832 | Ref. No. — |
| lamp socket mounting measurements ø16.2mm socket Ba9s connection male faston 6.3mm | | | |
|  | GEV No. | 359853 | Ref. No. — |
| lamp socket mounting measurements ø18.2mm socket Ba9s connection male faston 6.3mm | | | |

| | | | |
|---|---|-----------------|---|
|  | | | |
| 1 | | | |
| GEV No. | 359602 | Ref. No. | 002592 07150205 0H7036 0H7144 0K3356 0K4892 0K9814 0KC231 188211410 30001874 |
| description | neon light bulb socket E14 230V clear ø 14mm L 30mm | | |
| For models: | BE1-TA.3, BE1-W.3, BE1-WS-M.3, BE2-A-C.3, BE2-A-M.3, BE2-WS-C.3, BE2-WS-M.3, BE3-C.3, BE3-M.3, BE1-WS-C.3 | | |

| | | | |
|---|---|-----------------|---|
|  | | | |
| 1 | | | |
| GEV No. | 359603 | Ref. No. | 002585 052204 07150215 0G0967 0H7037 0K4893 0K7293 0K9813 0KC232 188211420 565628 |
| description | neon light bulb socket E14 380V clear ø 14mm L 30mm | | |
| For models: | BE1-TA.3, BE1-W.3, BE1-WS-M.3, BE2-A-C.3, BE2-A-M.3, BE2-WS-C.3, BE2-WS-M.3, BE3-C.3, BE3-M.3, BE1-WS-C.3 | | |

light bulbs

| for ovens | | | |
|--|--|-----------------|--|
|  | | | |
| 1 | | | |
| GEV No. | 359610 | Ref. No. | 0A2883 0H7035 0K6588 0KE265 0KS867 321837901 6061052 |
| description | light bulb t.max. 300°C socket E14 15W 230V ø 22mm L 47mm lens L 20mm for oven lamp type Philips | | |



1

| | | | |
|--------------------|--|-----------------|--|
| GEV No. | 359612 | Ref. No. | 004112 004161 054319 054840 056709 0C3044 0C3568 0H2405 0H6613 0K3859 0K6585 0K7928 245812 300003101 440403 8996610016405 91310191 |
| description | light bulb t.max. 300°C socket E14 25W 230V ø 25mm L 56mm lens L 30mm for oven lamp type Philips | | |
| For models: | HCCS20W, HCCS20W, FCF02EV, FCF02EOEM, FCF/G6-0, FCFG101/0, FCFG102-0, FCFG201-0, FCFG202-0, FCF/E6-0, FCFE101-0, FCFE102-0, FCFE201-0, FCFE202-0, FCF061ELN, FCF101ELN, FCF6EHOR, FCFG10160H, FCF061ENS, FCF101ENS, FCF102ENS, FCF201ENS, FCFG102-0T, FCF/G6-1-JAP, FCF/G101/1-1-JAP, FCF/G102/1-1-JAP, FCFE6-1J, FCFE101-1J, FCFE102-1J, FCF/G101/1, FCF/E3, FCF/E4, FCF/E4-3KW, FCF4E, FCF4E-3KW, FCF/E2, FCF/E2D, FCF/E2UK, FCF/E4-OLD, FCF/E4D, FCFE4PH, FCFG40, FCFG41, FCFG40D, FCFG40F, PFCFG40F, FCFE40, FCFE40D, FCFE40UK, PFCFE40F...(Other models you can see in the webshop) | | |



1

| | | | |
|--------------------|---|-----------------|------------------|
| GEV No. | 359611 | Ref. No. | 081696 0S0596 |
| description | light bulb t.max. 300°C socket E14 40W 230V ø 45mm L 75mm lens L 50mm for oven lamp IMPORT | | |
| For models: | AP20, ALP110, ALP120, ALP220, ALP240, ALN110, ALN120, ALN220, ALN240, ALNN120, ALNN220, ALNN230, ALNSO120, ALP110UK, ALN110UK, ALNN220UK, ALF110, ALF220UK, ALNF220, ALF110, ALF120, ALF220, ALF240, ALNF120, ALNF220, ALNF230, ADN220ES, ADF110ES, ADF220ES, ADN110ESP, ADF110ESP, ILP110, ILP110UK, ILN120, ILP111, ILP220, ILP220UK, ILP240, ILP221, ILN110, ILN110UK, ILN120, ILN111, ILN220, ILN220UK, ILN240, ILN221, ILNN220, ILN220UK, ALP110UK...(Other models you can see in the webshop) | | |

for indicator lights



1

| | | | |
|--------------------|--|-----------------|----------------------------|
| GEV No. | 359656 | Ref. No. | 0H2639 0K9109 0KC506 |
| description | light bulb socket Ba9s 130V 2W ø 10mm L 28mm | | |
| For models: | AR85, AR85, AR85, AR85, AR85, AR85, AR85, HC-CS, EBS50L, EBS100L, EBA100L, EBP100L, EBS200L, EBA200L, EBP200L, EBS300L, EBA300L, EBP300L | | |

halogen lamp

for socket E14 / E27



1

| | | | |
|--------------------|--|-----------------|--------|
| GEV No. | 359728 | Ref. No. | 006645 |
| description | halogen lamp socket E14 230V 40W ø 25mm lens L 54mm L 80mm temp.-resist. 300°C Qty 1 200 500 | | |
| For models: | MAX18/35X | | |

for socket G4 / G6.35 / G9



1

| | | | |
|--------------------|---|-----------------|------------------|
| GEV No. | 357191 | Ref. No. | 0C4396 0C9877 |
| description | halogen lamp socket G4 12V 10W temp.-resist. 300°C OSRAM HALOSTAR OVEN | | |
| For models: | FCZ061EAA, FCZ101EAA, FCZ102EAA, FCZ202EAA, FCZ061EAH, FCZ101EAH, FCZ061EAN, FCZ101EAN, FCZ061ETA, FCZ101ETA, FCZ102ETA, FCZ201ETA, FCZ202ETA, FCZ061ETH, FCZ101ETH, FCZ201ETH, FCZ061ETN, FCZ101ETN, FCZ201ETN, FCZ061GAG, FCZ102GAG, FCZ201GAG, FCZ202GAG, FCZ061GAD, FCZ102GAD, FCZ201GAD, FCZ202GAD, FCZ101GTG, FCZ102GTG, FCZ201GTG, FCZ202GTG, FCZ101GTD, FCZ102GTD, FCZ201GTD, FCZ202GTD, FCZ061EBA, FCZ101EBA, FCZ102EBA, FCZ202EBA, FCZ061EBH, FCZ101EBH, FCZ061EBN, FCZ101EBN, FCZ061EBC, FCZ101EBC, FCZ061EBA2, FCZ101EBA2, FCZ102EBA2, FCZ201EBA2, FCZ202EBA2...(Other models you can see in the webshop) | | |



1

| | | | |
|--------------------|---|-----------------|--------------------------------------|
| GEV No. | 359596 | Ref. No. | 0H7038 0H7039 359596 565729 |
| description | halogen lamp socket G4 12V 10W temp.-resist. 500°C 100 2000 | | |
| For models: | 5611-3-10, 5611-3-6, 5611-3-8, 5612-3-10, 5612-3-6, 5612-3-8, 5614-3-10, 5614-3-6, 5614-3-8 | | |



| | | | |
|---|---|-----------------|--|
|  | | | |
| GEV No. | 359599 | Ref. No. | 002956 007056 0C2803 0K2984 0K8586 0KE767 0W1780 |
| description | halogen lamp socket G4 12V 20W temp.-resist. 500°C 250 2000 | | |
| For models: | FCZ201EAA, FCZ201EAH, FCZ201EAN, FCZ101GAG, FCZ101GAD, FCZ201EBA, FCZ201EBH, FCZ201EBN, FCZ201EBC, FCZ101GBG, FCZ101GBD, FCZ101GBI, FCZ201ECA, FCZ201ECH, FCZ201ECN, FCZ101GCG, FCZ101GCD, FCV/G10L3, FCV/G6L3TOWNGAS, FCV/G6L3, FCVG10L3T, FCVG102L3, FCV/E101/1, FCV/G20L3, FCVG202L3, FCVE6L3J, FCV/E10L3JAP, FCV/E102/1L3JAP, FCV/E10L6JAP, FCV/E102/1L6JAP, FCV/G6L3JAP, FCVG10L3J, FCVG102L3J, FCV/G10L6JAP, FCV/G102/1L6JAP, FCVG6L3CJ, FCV/E61/1, FCV/G10L2, FCV/E61/1, FCV/E101/1, FCV/E101/1, FCV/E10L2, FCV/E102/1, FCV/E61/1, FCV/E61/1, FCV/E101/1, FCV/E101/2, FCV/G6L3C, FCV/G61/1, FCV/G61/1... (Other models you can see in the webshop) | | |

| | | | |
|---|---|-----------------|----------------------------|
|  | | | |
| GEV No. | 359946 | Ref. No. | 0C5605 0C5813 0C8662 |
| description | halogen lamp socket G9 230V 40W temp.-resist. 300°C 560 2000 | | |
| For models: | MAX18/35X, PDE830, PDE1230, PDE12L30, PDE1830, PDE835, PDE1235, PDE12L35, PDE1835 | | |

linear lamps

halogen lamps

| | | | |
|---|--|-----------------|--------------------------------------|
|  | | | |
| GEV No. | 359313 | Ref. No. | 032118 093041 099154 0TTF29 |
| description | halogen lamp socket R7s L 117.6mm 230V 150W IMPORT 2500 2000 | | |
| For models: | WMGHUK, DL07/NA, DL14/NA, DL14/AC, DL07/C, DL14/F, DL21/F, DL-P14/F, DLP21/F, SM08C., SM15CP, SM15C., SM15CA., SM15/CS., SM21/CP, SM21C., SM21CA., SM15VP, SM15VA., SM21VP., SM21VA., SMPV07, FSV07C2X, FSV11C3X, FSV15C4X, FSV07C2C, CM07C, FSV11C3C, FSV15C4C, FSV11C3CX, CM07C2, FSV15C4CX, FSV11C3CC, FSV15C4CC, CM11C, CM11C2, CM15C, CM15C2, DI07HWD, SM08C, SM15C, SM15/CS, SM21C, SM15F, SM21F, SMP15F, SMP21F, ZSM08/C, ZSM15/C, ZSM15/CS...(Other models you can see in the webshop) | | |

infrared lamps



with base type X lug

| | | | |
|---|--|-----------------|--------|
|  | | | |
| GEV No. | 359617 | Ref. No. | 0k3359 |
| description | infrared lamp 1000W 220V L 365mm lens L 340mm total length 480mm with mounting strap | | |

oven lamps

universal oven lamps



mounting diameter 28.5mm





| | | | |
|---|---|-----------------|----------------------------|
|  | | | |
| GEV No. | 359317 | Ref. No. | 0H7040 0K3358 567783 |
| description | oven lamp mounting ø 28.5mm 12V 5W socket G4 temp.-resist. 300°C cable length 300mm | | |
| For models: | 5611-3-10, 5611-3-6, 5611-3-8, 5612-3-10, 5612-3-6, 5612-3-8, 5614-3-10, 5614-3-6, 5614-3-8 | | |
| spare parts for | 359317 | | |
|  | GEV No. | 359308 | Ref. No. 0H6582 |
| oven lamp glass | | | |

| | | | |
|---|---|-----------------|--------|
|  | | | |
| GEV No. | 359308 | Ref. No. | 0H6582 |
| description | oven lamp glass | | |
| For models: | 5611-3-10, 5611-3-6, 5611-3-8, 5612-3-10, 5612-3-6, 5612-3-8, 5614-3-10, 5614-3-6, 5614-3-8 | | |





mounting diameter 35.5mm

| | | | |
|--|--|-----------------|--------|
|  | | | |
| GEV No. | 360738 | Ref. No. | 0E3681 |
| description | oven lamp complete L 69mm W 42mm 250V 15W socket E14 temp.-resist. 350°C connection F6.3x0.8 | | |
| For models: | FCV31E3, 7CO30, CCO30G, ECO312CF, OTS100 | | |

| | | | |
|--|--|-----------------|----------------------------------|
|  | | | |
| GEV No. | 359718 | Ref. No. | 0H6105 |
| description | oven lamp mounting ø 35.5mm 230V 15W socket E14 temp.-resist. 300°C connection male faston 6.3mm hard glas | | |
| spare parts for | 359718 | | |
|  | GEV No. | 359701 | Ref. No. 002625 0C5508 |
| lamp socket socket E14 220-230V mounting ø 35.5mm connection male faston 6.3mm 15W | | | |
|  | GEV No. | 359740 | Ref. No. — |
| light bulb t.max. 300°C socket E14 15W 230V ø 22mm L 48mm lens L 20mm for oven lamp IMPORT 70 1000 | | | |

| | | | |
|--|--|-----------------|-------------------|
|  | | | |
| 1 | | | |
| GEV No. | 359701 | Ref. No. | 002625 0C5508 |
| description | lamp socket socket E14 220-230V mounting ø 35.5mm connection male faston 6.3mm 15W | | |
| For models: | FCF/G6-0, FCFG101/0, FCFG102-0, FCFG201-0, FCFG202-0, FCF/E6-0, FCFE101-0, FCFE102-0, FCFE201-0, FCFE202-0, FCF061ELN, FCF101ELN, FCF6EHOR, FCFG10160H, FCF061ENS, FCF101ENS, FCF102ENS, FCF201ENS, FCFG102-0T, FCF/G6-1-JAP, FCF/G101/1-1-JAP, FCF/G102/1-1-JAP, FCFE6-1J, FCFE101-1J, FCFE102-1J, FCF/G101/1, ECF/G6/0, ECFG101-0, ECFG102-0, ECFG201-0, ECFG202-0, ECF/E6-0, ECFE101-0, ECFE102-0, ECFE201-0, ECFE202-0, ECF061ENS, ECF101ENS, ECF102ENS, ECF201ENS, ECF061E5M, ECF061ECV, ACF/G6-0, ACFG101-0, ACFG102-0, ACFG201-0, ACFG202-0, ACF/E6-0, ACFE101-0, ACFE102-0...(Other models you can see in the webshop) | | |
| accessories for | 359701 | | |
|  | GEV No. | 359705 | Ref. No. — |
| | oven lamp glass thr.ø 33.5mm ø 52mm hard glas temp.-resist. 350°C | | |
|  | GEV No. | 359709 | Ref. No. — |
| | oven lamp glass thr.ø 33.5mm ø 42mm hard glas temp.-resist. 350°C | | |
|  | GEV No. | 359721 | Ref. No. — |
| | gasket silicone ED ø 48mm ID ø 39.5mm thickness 5mm Qty 1 pcs | | |
|  | GEV No. | 359942 | Ref. No. — |
| | oven lamp glass thr.ø 33.5mm H 39mm ø 40mm hard glas temp.-resist. 350°C | | |

| | | | |
|---|--|-----------------|--------|
|  | | | |
| 1 | | | |
| GEV No. | 357080 | Ref. No. | 007055 |
| description | lamp socket socket G4 mounting ø 35.5mm connection cable 2400mm | | |
| For models: | FCZ061EAA, FCZ101EAA, FCZ061EAH, FCZ101EAH, FCZ061EAN, FCZ101EAN, FCZ061ETA, FCZ101ETA, FCZ061ETH, FCZ101ETH, FCZ061ETN, FCZ101ETN, FCZ061GAG, FCZ101GAG, FCZ102GAG, FCZ061GAD, FCZ101GAD, FCZ102GAD, FCZ101GTG, FCZ102GTG, FCZ101GTD, FCZ102GTD, FCZ061EBA, FCZ101EBA, FCZ061EBH, FCZ101EBH, FCZ061EBN, FCZ101EBN, FCZ061EBC, FCZ101EBC, FCZ061EBA2, FCZ101EBA2, FCZ061EBH2, FCZ101EBH2, FCZ061EBN2, FCZ101EBN2, FCZ061EBC2, FCZ101EBC2, FCZ061GBG, FCZ101GBG, FCZ102GBG, FCZ061GBD, FCZ101GBD, FCZ102GBD, FCZ061GBI, FCZ101GBI, FCZ101GBG2, FCZ102GBG2, FCZ101GBD2, FCZ102GBD2...(Other models you can see in the webshop) | | |



| | | | |
|---|--|-----------------|---|
|  | | | |
| 1 | | | |
| GEV No. | 359841 | Ref. No. | 007105 |
| description | lamp socket socket G4 mounting ø 35.5mm connection cable 3500mm | | |
| For models: | FCZ201EAA, FCZ202EAA, FCZ201EAH, FCZ201EAN, FCZ201ETA, FCZ202ETA, FCZ201ETH, FCZ201ETN, FCZ201GAG, FCZ202GAG, FCZ201GAD, FCZ202GAD, FCZ201GTG, FCZ202GTG, FCZ201GTD, FCZ202GTD, FCZ201EBA, FCZ202EBA, FCZ201EBH, FCZ201EBN, FCZ201EBC, FCZ201EBA2, FCZ202EBA2, FCZ201EBH2, FCZ201EBN2, FCZ201EBC2, FCZ201GBG, FCZ202GBG, FCZ201GBD, FCZ202GBD, FCZ201GBI, FCZ201GBG2, FCZ202GBG2, FCZ201GBD2, FCZ202GBD2, FCZ201GBI2, FCZ201ECA, FCZ202ECA, FCZ201ECH, FCZ201ECN, FCZ201ECA2, FCZ202ECA2, FCZ201ECH2, FCZ201ECN2, FCZ201GCG, FCZ202GCG, FCZ201GCD, FCZ202GCD, FCZ201GCG2, FCZ202GCG2...(Other models you can see in the webshop) | | |
| accessories for | 359841 | | |
|  | GEV No. | 359763 | Ref. No. 002626 012532200 0F0075 0K8368 0KE752 30001788 |
| | frame without socket | | |
|  | GEV No. | 359764 | Ref. No. 002627 0F0071 0K8365 |
| | lamp glass ø 44mm | | |
|  | GEV No. | 359765 | Ref. No. 002628 0F0150 0K8376 |
| | lamp holder ID ø 38mm ED ø 76mm | | |

| | | | |
|--|--|-----------------|----------------------------|
|  | | | |
| 1 | | | |
| GEV No. | 359762 | Ref. No. | 002709 006106 0C1555 |
| description | lamp socket socket G4 mounting ø 35.5mm connection cable 450mm | | |
| For models: | FCV/G10L3, FCV/G6L3TOWNGAS, FCV/G6L3, FCVG10L3T, FCVG102L3, FCV/E101/1, FCV/G20L3, FCVG202L3, FCVE6L3J, FCV/E10L3JAP, FCV/E102/1L3JAP, FCV/E10L6JAP, FCV/E102/1L6JAP, FCV/G6L-3JAP, FCVG10L3J, FCVG102L3J, FCV/G10L6JAP, FCV/G102/1L6JAP, FCVG6L3CJ, FCV/E61/1, FCV/G10L2, FCV/E61/1, FCV/E101/1, FCV/E101/1, FCV/E10L2, FCV/E102/1, FCV/E61/1, FCV/E61/1, FCV/E101/1, FCV/E101/2, FCV/G6L3C, FCV/G61/1, FCV/G61/1, FCV/G61/1, FCV/G61/1, FCV/G6L3CT, FCVG6L3CJ, FCV/E10L3, FCV/E102/1, FCV/E6L3, FCV/E102/1L3, FCV/E20L3, FCVE202L3, FCV/G6L4, FCV/E6L4, FCV/E101/1, FCV/G10L6, FCV/E10L6, FCV/G102/1L6, FCV/E102/1L6...(Other models you can see in the webshop) | | |



mounting diameter 47.8mm







| | | | |
|---|--|-----------------|--|
| GEV No. | 357187 | Ref. No. | 056708 |
| description | oven lamp mounting ø 47.8mm 230V 15W socket E14 temp.-resist. 300°C connection male faston 6.3mm hard glas | | |
| For models: | FZG18, FZE18, FPE30, FPE18, FZ/G18, FZ/E18, FP/E30, FP/E18 | | |
| spare parts for | 357187 | | |
|  | GEV No. | 359610 | Ref. No. |
| | | | 0A2883 0H7035 0K6588 0KE265 0KS867 321837901 6061052 |
| | light bulb t.max. 300°C socket E14 15W 230V ø 22mm L 47mm lens L 20mm for oven lamp type Philips | | |
|  | GEV No. | 359725 | Ref. No. |
| | | | — |
| | oven lamp glass thread ø 44mm H 43mm ø 54mm hard glas temp.-resist. 350°C | | |



| | | | |
|--------------------|---|-----------------|--------|
| GEV No. | 357078 | Ref. No. | 033804 |
| description | oven lamp mounting ø 65.5mm 230V 40W socket G9 temp.-resist. 300°C connection male faston 6.3mm hard glas | | |
| For models: | MP712BT, MP928BT, MC2036BT, MPV920BT, MPV924BT, MCV2032BT, BP1124BT, BC1432BT, BC1832BT, BC2232BT, EP1112T, EP1428T, EC1428T, EC1828T, EC2228T, EP1116T, EP1120T, EP1124T, EP1128T, EP1132T, EP1136T, EP1140T, EP1140T, EP1412T, EP1416T, EP1420T, EP1424T, EP1432T, EP1436T, EP1440T, EC1412T, EC1416T, EC1420T, EC1424T, EC1432T, EC1436T, EC1440T, EC1816T, EC1820T, EC1824T, EC1832T, EC1836T, EC1840T, EC2220T, EC2224T, EC2232T, EC2236T, EC2240T, MPV712BT, MPV716BT, MPV720BT...(Other models you can see in the webshop) | | |

mounting diameter 65.5mm



| | | | |
|---|--|-----------------|----------------------|
| GEV No. | 359712 | Ref. No. | 004163+004160+054840 |
| description | oven lamp mounting ø 65.5mm 230V 40W socket E14 temp.-resist. 300°C connection male faston 6.3mm hard glas | | |
| spare parts for | 359712 | | |
|  | GEV No. | 359022 | Ref. No. |
| | | | 004160 |
| | lamp socket socket E14 mounting ø 65.5mm connection male faston 6.3mm | | |
|  | GEV No. | 359611 | Ref. No. |
| | | | 081696 0S0596 |
| | light bulb t.max. 300°C socket E14 40W 230V ø 45mm L 75mm lens L 50mm for oven lamp IMPORT | | |
|  | GEV No. | 359722 | Ref. No. |
| | | | — |
| | gasket silicone ID ø 57.5mm ED ø 68mm thickness 2mm | | |
|  | GEV No. | 359724 | Ref. No. |
| | | | 003451 004163 |
| | oven lamp glass thread ø 62mm H 46mm ø 74mm hard glas temp.-resist. 350°C | | |





| | | | |
|--------------------|--|-----------------|--------|
| GEV No. | 359022 | Ref. No. | 004160 |
| description | lamp socket socket E14 mounting ø 65.5mm connection male faston 6.3mm | | |
| For models: | MAX18/35X, ZCMDG6, ZCMDE6, ZCBDE12, ZCMM6, ZCBME12, ZCMDG4, ZCMDE4, ZCBDE8, ZCMM4, ZCBME8, ZCMDG9, ZCMDE9, ZCBDE18, ZCMM9, ZCBME18, ZCBDG8, ZCBDG12, ZCBDG18, FFPS16, FFPS32, PDE830, PDE1230, PDE12L30, PDE1830, PDE835, PDE1235, PDE12L35, PDE1835, PME430, PME630, PME6L30, PME930, PME435, PME635, PME6L35, PME935, PME830, PME1230, PME12L30, PME1830, PME835, PME1235, PME12L35, PME1835 | | |



| | | | |
|--------------------|---|-----------------|------------------|
| GEV No. | 359724 | Ref. No. | 003451 004163 |
| description | oven lamp glass thread ø 62mm H 46mm ø 74mm hard glas temp.-resist. 350°C | | |
| For models: | MAX18/35X, ZCMDE6, ZCBDE12, ZCMM6, ZCBME12, ZCMDE4, ZCBDE8, ZCMM4, ZCBME8, ZCMDE9, ZCBDE18, ZCMM9, ZCBME18, ZCBDG8, ZCBDG12, ZCBDG18, FFPS16, FFPS32, ZMMDG4, ZMBDG8, ZMMD4, ZMMDG6, ZMBDG12, ZMMD6, FPS/18, FPS/30, PDE830, PDE1230, PDE12L30, PDE1830, PDE835, PDE1235, PDE12L35, PDE1835, PME430, PME630, PME6L30, PME930, PME435, PME635, PME6L35, PME935, PME830, PME1230, PME12L30, PME1830, PME835, PME1235, PME12L35, PME1835 | | |



| | | | |
|---|--|-----------------|--------|
|  | | | |
| 1 | | | |
| GEV No. | 357083 | Ref. No. | 005875 |
| description | sealing ring metal ID ø 62.5mm ED ø 80mm thickness 3mm | | |
| For models: | MAX18/35X, ZCMM6, ZCBME12, ZCMM4, ZCBME8, ZCMM9, ZCBME18, PDE830, PDE1230, PDE12L30, PDE1830, PDE835, PDE1235, PDE12L35, PDE1835, PME430, PME630, PME6L30, PME930, PME435, PME635, PME6L35, PME935, PME830, PME1230, PME12L30, PME1830, PME835, PME1235, PME12L35, PME1835 | | |

| | | | |
|---|--|-----------------|---------------------------------|
| 55x70mm | | | |
|  | | | |
| 1 | | | |
| GEV No. | 359298 | Ref. No. | 0K3363 0K3364 77705U10323 |
| description | lamp socket 230V 25W socket E14 mounting measurements 70x55mm connection male faston 6.3mm | | |
| accessories for | 359298 | | |
|  | GEV No. | 359937 | Ref. No. — |
| lamp glass L 80mm W 65mm mounting measurements 52x67mm | | | |

| | | | |
|--|---|-----------------|--------|
|  | | | |
| 1 | | | |
| GEV No. | 359375 | Ref. No. | 003956 |
| description | lamp socket complete version socket E14 mounting measurements 55x70mm | | |
| For models: | FCF/E3, 5711-2-6, 5711-2-7, 5711-2-8, 5711-2-10, 5712-2-6, 5712-2-7, 5712-2-8, 5712-2-10, 5714-2-6, 5714-2-7, 5714-2-8, 5714-2-10, 5717-2-6, 5714-2-7, 5714-2-8, 5714-2-10, 5711-2-6L, 5711-2-7L, 5711-2-8L, 5711-2-10L, 5712-2-6L, 5712-2-7L, 5712-2-8L, 5712-2-10L, 5714-2-6L, 5714-2-7L, 5714-2-8L, 5714-2-10L, 5714-2-6L, 5714-2-7L, 5714-2-8L, 5714-2-10L, 5711-3-6, 5711-3-7, 5711-3-8, 5711-3-10, 5712-3-6, 5712-3-7, 5712-3-8, 5712-3-8E, 5712-3-10, 5714-3-6, 5714-3-7, 5714-3-8, 5714-3-8E, 5714-3-10, 5717-3-6, 5717-3-7, 5717-3-8...(Other models you can see in the webshop) | | |











| | | | |
|--|--|-----------------|--|
| 55x100mm | | | |
|  | | | |
| 1 | | | |
| GEV No. | 359698 | Ref. No. | 054991 055021 0G3691 77722210423 |
| description | lamp socket L 100mm W 55mm socket E14 connection male faston 6.3mm | | |
| For models: | FCFG40, FCFG41, FCFG40D, FCFG40F, PFCFG40F, FCFE40, FCFE40D, FCFE40UK, PFCFE40F, FCFG40J, FCFG40J, FCFE40J, FCFE40J, FCFG41J, FCFG40J, FCVE6-1U, FCVE6-3U, FCVE6-1, FCVE6-3, FCVE6-3CE, FCVE6-1UK, FCVE6-3UK, FCVG6-1, FCVG6-3, FCVG6-1UK, FCVG6-3UK, FCVE10-2, FCVE10-4, FCVE103CE, FCVE10-2UK, FCVE10-4UK, FCVG10-2, FCVG10-4, FCVG10-1SG, FCVG10-2, FCVG10-4D, FCVG10-2UK, FCVG10-4UK, FCVG10-2, FCVG10-4, FCVE20-2, FCVE20-4, FCVE203CE, FCVE20/P-V, FCVE20-2UK, FCVE20-4UK, FCVG20-2, FCVG20-4, FCVG20-2, FCVG20-4D...(Other models you can see in the webshop) | | |
| spare parts for | 359698 | | |
|  | GEV No. | 358119 | Ref. No. — |
| frame L 118mm W 72mm mounting distance 143mm for bulb socket | | | |
|  | GEV No. | 358122 | Ref. No. — |
| gasket L 112mm W 68mm silicone thickness 3mm for bulb socket | | | |
|  | GEV No. | 358123 | Ref. No. — |
| lamp glass L 112mm W 68mm | | | |
|  | GEV No. | 359612 | Ref. No. 004112 004161 054319 054840 056709 0C3044 0C3568 0H2405 0H6613 0K3859 0K6585 0K7928 245812 300003101 440403 8996610016405 91310191 |
| light bulb t.max. 300°C socket E14 25W 230V ø 25mm L 56mm lens L 30mm for oven lamp type Philips | | | |
|  | GEV No. | 359714 | Ref. No. 055022 0H2410 0H6672 0K7946 |
| gasket silicone L 140mm W 75mm for bulb socket | | | |
|  | GEV No. | 359715 | Ref. No. 0H6989 284255 |
| lamp glass L 110mm W 65mm thickness 5mm | | | |

Table continues overleaf



| | | | | |
|--|---------|--------|----------|--|
| accessories for 359698 | | | | 004112 004161 054319 054840 056709 0C3044 0C3568 0H2405 0H6613 0K3859 0K6585 0K7928 245812 300003101 440403 8996610016405 91310191 |
|  | GEV No. | 359612 | Ref. No. | |
| light bulb t.max. 300°C socket E14 25W 230V ø 25mm L 56mm lens L 30mm for oven lamp type Philips | | | | |
|  | GEV No. | 359938 | Ref. No. | — |
| borosilicate glass L 115mm W 69mm | | | | |

| | | | | |
|---|-----------------------|----------|--------|--|
| 1  | | | | |
| GEV No. | 359716 | Ref. No. | 0H7118 | |
| description | frame for bulb socket | | | |
| For models: | 9030-2, 9031-2 | | | |

| | | | | |
|---|--|----------|--------------------------------------|--|
| 1  | | | | 004112 004161 054319 054840 056709 0C3044 0C3568 0H2405 0H6613 0K3859 0K6585 0K7928 245812 300003101 440403 8996610016405 91310191 |
| GEV No. | 359714 | Ref. No. | 055022 0H2410 0H6672 0K7946 | |
| description | gasket silicone L 140mm W 75mm for bulb socket | | | |
| For models: | FCFG40, FCFG41, FCFG40D, FCFG40F, PFCFG40F, FCFE40, FCFE40D, FCFE40UK, PFCFE40F, FCFG40J, FCFG40J, FCFE40J, FCFE40J, FCFG41J, FCFG40J, FCVE6-1U, FCVE6-3U, FCVE6-1, FCVE6-3, FCVE6-3CE, FCVE6-1UK, FCVE6-3UK, FCFG6-1, FCFG6-3, FCFG6-1UK, FCFG6-3UK, FCVE10-2, FCVE10-4, FCVE103CE, FCVE10-2UK, FCVE10-4UK, FCFG10-2, FCFG10-4, FCFG10-1SG, FCFG10-2, FCFG10-4D, FCFG10-2UK, FCFG10-4UK, FCFG10-2, FCFG10-4, FCVE20-2, FCVE20-4, FCVE203CE, FCVE20/P-V, FCVE20-2UK, FCVE20-4UK, FCFG20-2, FCFG20-4, FCFG20-2, FCFG20-4D...(Other models you can see in the webshop) | | | |

| | | | | |
|---|--|----------|------------------|--|
| 1  | | | | |
| GEV No. | 359715 | Ref. No. | 0H6989 284255 | |
| description | lamp glass L 110mm W 65mm thickness 5mm | | | |
| For models: | 9030-2, 9031-2, 9100-2, 9101-2, 9102-2, 9104-2 | | | |











| | | | | |
|--|--|----------|---|--|
| 1  | | | | |
| GEV No. | 359698 | Ref. No. | 054991 055021 0G3691 77722210423 | |
| description | lamp socket L 100mm W 55mm socket E14 connection male faston 6.3mm | | | |
| For models: | FCFG40, FCFG41, FCFG40D, FCFG40F, PFCFG40F, FCFE40, FCFE40D, FCFE40UK, PFCFE40F, FCFG40J, FCFG40J, FCFE40J, FCFE40J, FCFG41J, FCFG40J, FCVE6-1U, FCVE6-3U, FCVE6-1, FCVE6-3, FCVE6-3CE, FCVE6-1UK, FCVE6-3UK, FCFG6-1, FCFG6-3, FCFG6-1UK, FCFG6-3UK, FCVE10-2, FCVE10-4, FCVE103CE, FCVE10-2UK, FCVE10-4UK, FCFG10-2, FCFG10-4, FCFG10-1SG, FCFG10-2, FCFG10-4D, FCFG10-2UK, FCFG10-4UK, FCFG10-2, FCFG10-4, FCVE20-2, FCVE20-4, FCVE203CE, FCVE20/P-V, FCVE20-2UK, FCVE20-4UK, FCFG20-2, FCFG20-4, FCFG20-2, FCFG20-4D...(Other models you can see in the webshop) | | | |
| spare parts for 359698 | | | | |
|  | GEV No. | 358119 | Ref. No. | — |
| frame L 118mm W 72mm mounting distance 143mm for bulb socket | | | | |
|  | GEV No. | 358122 | Ref. No. | — |
| gasket L 112mm W 68mm silicone thickness 3mm for bulb socket | | | | |
|  | GEV No. | 358123 | Ref. No. | — |
| lamp glass L 112mm W 68mm | | | | |
| 1  | | | | 004112 004161 054319 054840 056709 0C3044 0C3568 0H2405 0H6613 0K3859 0K6585 0K7928 245812 300003101 440403 8996610016405 91310191 |
| GEV No. | 359612 | Ref. No. | | |
| light bulb t.max. 300°C socket E14 25W 230V ø 25mm L 56mm lens L 30mm for oven lamp type Philips | | | | |
|  | GEV No. | 359714 | Ref. No. | 055022 0H2410 0H6672 0K7946 |
| gasket silicone L 140mm W 75mm for bulb socket | | | | |
|  | GEV No. | 359715 | Ref. No. | 0H6989 284255 |
| lamp glass L 110mm W 65mm thickness 5mm | | | | |
|  | GEV No. | 359716 | Ref. No. | 0H7118 |
| frame for bulb socket | | | | |

Table continues overleaf







| | | | |
|--|--|-----------------|----------------------------|
|  <p>1</p> | | | |
| GEV No. | 359765 | Ref. No. | 002628 0F0150 OK8376 |
| description | lamp holder ID ø 38mm ED ø 76mm | | |
| For models: | FCZ061EAA, FCZ101EAA, FCZ102EAA, FCZ201EAA, FCZ202EAA, FCZ061EAH, FCZ101EAH, FCZ201EAH, FCZ061EAN, FCZ101EAN, FCZ201EAN, FCZ061ETA, FCZ101ETA, FCZ102ETA, FCZ201ETA, FCZ202ETA, FCZ061ETH, FCZ101ETH, FCZ201ETH, FCZ061ETN, FCZ101ETN, FCZ201ETN, FCZ061GAG, FCZ101GAG, FCZ102GAG, FCZ201GAG, FCZ202GAG, FCZ061GAD, FCZ101GAD, FCZ102GAD, FCZ201GAD, FCZ202GAD, FCZ101GTG, FCZ102GTG, FCZ201GTG, FCZ202GTG, FCZ101GTD, FCZ102GTD, FCZ201GTD, FCZ202GTD, FCZ061EBA, FCZ101EBA, FCZ102EBA, FCZ201EBA, FCZ202EBA, FCZ061EBH, FCZ101EBH, FCZ201EBH, FCZ061EBN, FCZ101EBN...(Other models you can see in the webshop) | | |



| | | | |
|--|---|-----------------|----------------------------|
|  <p>1</p> | | | |
| GEV No. | 359762 | Ref. No. | 002709 006106 0C1555 |
| description | lamp socket socket G4 mounting ø 35.5mm connection cable 450mm | | |
| For models: | FCV/G10L3, FCV/G6L3TOWNGAS, FCV/G6L3, FCV/G10L3T, FCV/G10L3, FCV/E101/1, FCV/G20L3, FCV/G20L3, FCVE6L3J, FCV/E10L3JAP, FCV/E102/1L3JAP, FCV/E10L6JAP, FCV/E102/1L6JAP, FCV/G6L-3JAP, FCV/G10L3J, FCV/G10L3J, FCV/G10L6JAP, FCV/G102/1L6JAP, FCV/G6L3CJ, FCV/E61/1, FCV/G10L2, FCV/E61/1, FCV/E101/1, FCV/E101/1, FCV/E10L2, FCV/E102/1, FCV/E61/1, FCV/E61/1, FCV/E101/1, FCV/E101/2, FCV/G6L3C, FCV/G61/1, FCV/G61/1, FCV/G61/1, FCV/G61/1, FCV/G6L3CT, FCV/G6L3CJ, FCV/E10L3, FCV/E102/1, FCV/E6L3, FCV/E102/1L3, FCV/E20L3, FCVE20L3, FCV/G6L4, FCV/E6L4, FCV/E101/1, FCV/G10L6, FCV/E10L6, FCV/G102/1L6, FCV/E102/1L6...(Other models you can see in the webshop) | | |



| | | | |
|--|--|-----------------|--------|
|  <p>1</p> | | | |
| GEV No. | 359841 | Ref. No. | 007105 |
| description | lamp socket socket G4 mounting ø 35.5mm connection cable 3500mm | | |
| For models: | FCZ201EAA, FCZ202EAA, FCZ201EAH, FCZ201EAN, FCZ201ETA, FCZ202ETA, FCZ201ETH, FCZ201ETN, FCZ201GAG, FCZ202GAG, FCZ201GAD, FCZ202GAD, FCZ201GTG, FCZ202GTG, FCZ201GTD, FCZ202GTD, FCZ201EBA, FCZ202EBA, FCZ201EBH, FCZ201EBN, FCZ201EBC, FCZ201EBA2, FCZ202EBA2, FCZ201EBH2, FCZ201EBN2, FCZ201EBC2, FCZ201GBG, FCZ202GBG, FCZ201GBD, FCZ202GBD, FCZ201GBI, FCZ201GBG2, FCZ202GBG2, FCZ201GBD2, FCZ202GBD2, FCZ201GBI2, FCZ201ECA, FCZ202ECA, FCZ201ECH, FCZ201ECN, FCZ201ECA2, FCZ202ECA2, FCZ201ECH2, FCZ201ECN2, FCZ201GCG, FCZ202GCG, FCZ201GCD, FCZ202GCD, FCZ201GCG2, FCZ202GCG2...(Other models you can see in the webshop) | | |



| | | | |
|--|--|-----------------|--------|
|  <p>1</p> | | | |
| GEV No. | 360647 | Ref. No. | 0C4459 |
| description | reflector | | |
| For models: | FCZ061EAA, FCZ101EAA, FCZ102EAA, FCZ201EAA, FCZ202EAA, FCZ061EAH, FCZ101EAH, FCZ201EAH, FCZ061EAN, FCZ101EAN, FCZ201EAN, FCZ061ETA, FCZ101ETA, FCZ102ETA, FCZ201ETA, FCZ202ETA, FCZ061ETH, FCZ101ETH, FCZ201ETH, FCZ061ETN, FCZ101ETN, FCZ201ETN, FCZ061GAG, FCZ101GAG, FCZ102GAG, FCZ201GAG, FCZ202GAG, FCZ061GAD, FCZ101GAD, FCZ102GAD, FCZ201GAD, FCZ202GAD, FCZ101GTG, FCZ102GTG, FCZ201GTG, FCZ202GTG, FCZ101GTD, FCZ102GTD, FCZ201GTD, FCZ202GTD, FCZ061EBA, FCZ101EBA, FCZ102EBA, FCZ201EBA, FCZ202EBA, FCZ061EBH, FCZ101EBH, FCZ201EBH, FCZ061EBN, FCZ101EBN...(Other models you can see in the webshop) | | |

| | | | |
|---|----------------|--------|--|
| accessories for 359841 | | | |
|  | GEV No. | 359763 | Ref. No. 002626 012532200 0F0075 OK8368 0KE752 30001788 |
| frame without socket | | | |
|  | GEV No. | 359764 | Ref. No. 002627 0F0071 OK8365 |
| lamp glass ø 44mm | | | |
|  | GEV No. | 359765 | Ref. No. 002628 0F0150 OK8376 |
| lamp holder ID ø 38mm ED ø 76mm | | | |

| | | | |
|---|---|-----------------|---------------------------|
|  <p>1</p> | | | |
| GEV No. | 359376 | Ref. No. | 054320 |
| description | lamp socket socket E14 | | |
| For models: | FCF/E4, FCF/E4-3KW, FCF/E4-OLD, FCF/E4D, FCFE4PH, JCF/E4, JCF/E4, ECF/E4, ECF/E4-3KW, FCF/E4OLD3, ACF/E4, ACF/E4-3KW, FCF/E4OLD4, NCF/E4, FCF/E4OLD2, FCF/E4OLD1, FCF/E4D, ZCF/E4, ZCF/E4 | | |
| accessories for 359376 | | | |
|  | GEV No. | 359377 | Ref. No. 054318 |
| oven lamp glass H 30mm ø 47mm | | | |



| | | | |
|---|---|-----------------|------------------------|
|  | | | |
| 1 | | | |
| GEV No. | 359377 | Ref. No. | 054318 |
| description | oven lamp glass H 30mm ø 47mm | | |
| For models: | FCF/E4, FCF/E4-3KW, FCF/E4-OLD, FCF/E4D, FCFE4PH, JCF/E4, JCF/E4, ECF/E4, ECF/E4-3KW, FCF/E4OLD3, ACF/E4, ACF/E4-3KW, FCF/E4OLD4, NCF/E4, FCF/E4OLD2, FCF/E4OLD1, FCF/E4D, ZCF/E4, ZCF/E4 | | |
| accessories for | 359377 | | |
|  | GEV No. | 359376 | Ref. No. 054320 |
| | lamp socket socket E14 | | |

| | | | |
|---|--|-----------------|--|
| lamps | | | |
| light bulbs | | | |
|  | | | |
|  | | | |
| 1 | | | |
| GEV No. | 359610 | Ref. No. | 0A2883 0H7035 0K6588 0KE265 0KS867 321837901 6061052 |
| description | light bulb t.max. 300°C socket E14 15W 230V ø 22mm L 47mm lens L 20mm for oven lamp type Philips | | |

| | | | |
|---|--|-----------------|--|
|  | | | |
|  | | | |
| 1 | | | |
| GEV No. | 359612 | Ref. No. | 004112 004161 054319 054840 056709 0C3044 0C3568 0H2405 0H6613 0K3859 0K6585 0K7928 245812 300003101 440403 8996610016405 91310191 |
| description | light bulb t.max. 300°C socket E14 25W 230V ø 25mm L 56mm lens L 30mm for oven lamp type Philips | | |
| For models: | HCCS20W, HCCS20W, FCF02EV, FCF02EOEM, FCF/G6-0, FCFG101/0, FCFG102-0, FCFG201-0, FCFG202-0, FCF/E6-0, FCFE101-0, FCFE102-0, FCFE201-0, FCFE202-0, FCF061ELN, FCF101ELN, FCF6EHOR, FCFG10160H, FCF061ENS, FCF101ENS, FCF102ENS, FCF201ENS, FCFG102-0T, FCF/G6-1-JAP, FCF/G101/1-1-JAP, FCF/G102/1-1-JAP, FCFE6-1J, FCFE101-1J, FCFE102-1J, FCF/G101/1, FCF/E3, FCF/E4, FCF/E4-3KW, FCF4E, FCF4E-3KW, FCF/E2, FCF/E2D, FCF/E2UK, FCF/E4-OLD, FCF/E4D, FCFE4PH, FCFG40, FCFG41, FCFG40D, FCFG40F, PFCFG40F, FCFE40, FCFE40D, FCFE40UK, PFCFE40F...(Other models you can see in the webshop) | | |

| | | | |
|---|---|-----------------|------------------|
|  | | | |
| 1 | | | |
| GEV No. | 359611 | Ref. No. | 081696 0S0596 |
| description | light bulb t.max. 300°C socket E14 40W 230V ø 45mm L 75mm lens L 50mm for oven lamp IMPORT | | |
| For models: | AP20, ALP110, ALP120, ALP220, ALP240, ALN110, ALN120, ALN220, ALN240, ALNN120, ALNN220, ALNN230, ALNSO120, ALP110UK, ALN110UK, ALNN220UK, ALF110, ALF220UK, ALNF220, ALF110, ALF120, ALF220, ALF240, ALNF120, ALNF220, ALNF230, ADN220ES, ADF110ES, ADF220ES, ADN110ESP, ADF110ESP, ILP110, ILP110UK, ILN120, ILP111, ILP220, ILP220UK, ILP240, ILP221, ILN110, ILN110UK, ILN120, ILN111, ILN220, ILN220UK, ILN240, ILN221, ILNN220, ILN-N220UK, ALP110UK...(Other models you can see in the webshop) | | |

| | | | |
|---|--|-----------------|--------|
| halogen lamps | | | |
| for socket E14 / E27 | | | |
|  | | | |
| 1 | | | |
| GEV No. | 359728 | Ref. No. | 006645 |
| description | halogen lamp socket E14 230V 40W ø 25mm lens L 54mm L 80mm temp.-resist. 300°C Qty 1 200 500 | | |
| For models: | MAX18/35X | | |

| | | | |
|---|---|-----------------|------------------|
| for socket G4 / G6.35 / G9 | | | |
|  | | | |
|  | | | |
| 1 | | | |
| GEV No. | 357191 | Ref. No. | 0C4396 0C9877 |
| description | halogen lamp socket G4 12V 10W temp.-resist. 300°C OSRAM HALOSTAR OVEN | | |
| For models: | FCZ061EAA, FCZ101EAA, FCZ102EAA, FCZ202EAA, FCZ061EAH, FCZ101EAH, FCZ061EAN, FCZ101EAN, FCZ061ETA, FCZ101ETA, FCZ102ETA, FCZ201ETA, FCZ202ETA, FCZ061ETH, FCZ101ETH, FCZ201ETH, FCZ061ETN, FCZ101ETN, FCZ201ETN, FCZ061GAG, FCZ102GAG, FCZ201GAG, FCZ202GAG, FCZ061GAD, FCZ102GAD, FCZ201GAD, FCZ202GAD, FCZ101GTG, FCZ102GTG, FCZ201GTG, FCZ202GTG, FCZ101GTD, FCZ102GTD, FCZ201GTD, FCZ202GTD, FCZ061EBA, FCZ101EBA, FCZ102EBA, FCZ202EBA, FCZ061EBH, FCZ101EBH, FCZ061EBN, FCZ101EBN, FCZ061EBC, FCZ101EBC, FCZ061EBA2, FCZ101EBA2, FCZ102EBA2, FCZ201EBA2, FCZ202EBA2...(Other models you can see in the webshop) | | |

| | | | |
|---|---|-----------------|--------------------------------------|
|  | | | |
| 1 | | | |
| GEV No. | 359596 | Ref. No. | 0H7038 0H7039 359596 565729 |
| description | halogen lamp socket G4 12V 10W temp.-resist. 500°C 100 2000 | | |
| For models: | 5611-3-10, 5611-3-6, 5611-3-8, 5612-3-10, 5612-3-6, 5612-3-8, 5614-3-10, 5614-3-6, 5614-3-8 | | |



| | | | |
|---|--|-----------------|--|
|  | | | |
| GEV No. | 359599 | Ref. No. | 002956 007056 0C2803 0K2984 0K8586 0KE767 0W1780 |
| description | halogen lamp socket G4 12V 20W temp.-resist. 500°C 250 2000 | | |
| For models: | FCZ201EAA, FCZ201EAH, FCZ201EAN, FCZ101GAG, FCZ101GAD, FCZ201EBA, FCZ201EBH, FCZ201EBN, FCZ201EBC, FCZ101GBG, FCZ101GBD, FCZ101GBI, FCZ201ECA, FCZ201ECH, FCZ201ECN, FCZ101GCG, FCZ101GCD, FCV/G10L3, FCV/G6L3TOWNGAS, FCV/G6L3, FCVG10L3T, FCVG102L3, FCV/E101/1, FCV/G20L3, FCVG20L3, FCVE6L3J, FCV/E10L3JAP, FCV/E102/1L3JAP, FCV/E10L6JAP, FCV/E102/1L6JAP, FCV/G6L3JAP, FCVG10L3J, FCVG102L3J, FCV/G10L6JAP, FCV/G102/1L6JAP, FCVG6L3CJ, FCV/E61/1, FCV/G10L2, FCV/E61/1, FCV/E101/1, FCV/E101/1, FCV/E10L2, FCV/E102/1, FCV/E61/1, FCV/E61/1, FCV/E101/1, FCV/E101/2, FCV/G6L3C, FCV/G61/1, FCV/G61/1... (Other models you can see in the webshop) | | |

| | | | |
|---|---|-----------------|----------------------------|
|  | | | |
| GEV No. | 359946 | Ref. No. | 0C5605 0C5813 0C8662 |
| description | halogen lamp socket G9 230V 40W temp.-resist. 300°C 560 2000 | | |
| For models: | MAX18/35X, PDE830, PDE1230, PDE12L30, PDE1830, PDE835, PDE1235, PDE12L35, PDE1835 | | |

lamp accessories

| | | | |
|---|---|-----------------|------------------|
| gaskets | | | |
|  | | | |
| GEV No. | 359766 | Ref. No. | 0K2106 246314 |
| description | gasket L 100mm W 76mm | | |
| For models: | 5611-3-10, 5611-3-6, 5611-3-8, 5612-3-10, 5612-3-6, 5612-3-8, 5614-3-10, 5614-3-6, 5614-3-8 | | |

timers

programme timers

| | | | |
|--|--|-----------------|------------------|
|  | | | |
| GEV No. | 360633 | Ref. No. | 0C8731 0C8755 |
| description | time switch kit 14000F3 operation time 120min impulse electric shaft ø 6x4.6mm shaft L 20mm CDC 230V engines 1 chambers 2 | | |
| For models: | FDV40G, FDV40E, FDV40GZ, FDV40EL, FDV40GA, FDV20G, FDV20E, FDV20GZ, FDV20EL, FDV20GA, FCF02EV, FCF02EOEM, FCV/G10L3, FCV/G6L3TOWNGAS, FCV/G6L3, FCVG10L3T, FCVG102L3, FCV/G20L3, FCVG20L3, FCVE6L3J, FCV/E10L3JAP, FCV/E102/1L3JAP, FCV/G6L3JAP, FCVG10L3J, FCVG102L3J, FCV/G10L2, FCV/E10L2, FCV/G6L3C, FCV/G61/1, FCVG6L3CT, FCVG6L3CJ, FCV/E10L3, FCV/E6L3, FCV/E102/1L3, FCV/E20L3, FCVE20L3, FCF/G6-0, FCFG101/0, FCFG102-0, FCFG201-0, FCFG202-0, FCF/E6-0, FCFE101-0, FCFE102-0, FCFE201-0, FCFE202-0, FCF061ELN, FCF101ELN, FCF6EHOR...(Other models you can see in the webshop) | | |

| | | | |
|---|------------------------------|-----------------|----------------------------|
|  | | | |
| GEV No. | 350017 | Ref. No. | 0H6755 0KE659 252205 |
| description | timer | | |
| For models: | 5611-3-6, 5612-3-6, 5614-3-6 | | |

| | | | |
|--|---|-----------------|--------|
|  | | | |
| GEV No. | 360508 | Ref. No. | 0KU798 |
| description | timer BIGATTI engines 1 chambers 2 operation time 60min 230V 50/60Hz shaft ø 6x5mm shaft L 19.5mm manuf. no. D94.04 / CCS011 motor type UDS11UD5RKZ253 for oven | | |



| | | | |
|--------------------|--|-----------------|--------|
| 1 | | | |
| GEV No. | 360719 | Ref. No. | OCA557 |
| description | timer CDC 11902F3 engines 1 chambers 2 operation time 144min 230V shaft ø 6x4.6mm shaft L 20mm manif. no. 11902F3DFE000.0010 | | |



| | | | |
|--------------------|---|-----------------|------------------|
| 1 | | | |
| GEV No. | 360456 | Ref. No. | 045909 066907 |
| description | timer FIBER P34 engines 1 chambers 2 operation time 36min 230V shaft ø 5X3mm shaft L 22mm manif. no. P345J02L867 motor type M51BJ0L6400 | | |

electric timers



| | | | |
|--------------------|--|-----------------|--------|
| 1 | | | |
| GEV No. | 350197 | Ref. No. | OKI405 |
| description | timer M11 operation time 120min time spreadmin 1CO/1NO at 250V 16A permanent position yes impulse electric shaft ø 6x4.6mm shaft L 23mm mounting distance 28mm connection lateral 2-pole | | |





| | | | |
|--------------------|--|-----------------|--------------------------------------|
| 1 | | | |
| GEV No. | 350143 | Ref. No. | OH6117 OK0484 212606 350006 |
| description | timer M565 without bell operation time 60min time spreadmin 2CO at 250V 16A permanent position no time range 0-60min impulse electric shaft ø 6x4.6mm shaft L 22mm EATON (INVENSYS) ambient temperature max. 85°C 50Hz 2-pole 230V | | |

mechanical timers





| | | | |
|--------------------|---|-----------------|----------------------------|
| 1 | | | |
| GEV No. | 350061 | Ref. No. | 003431 005216 OC6345 |
| description | timer DTJ with bell 2-pole operation time 120min impulse mechanical 2NO at 250V 16A permanent position yes shaft ø 6x4.6mm shaft 6x4.6mm shaft L 24mm mounting distance 28mm connection lateral | | |
| For models: | FCF/E4, FCF/E4-3KW, FCF/E4-OLD, FCF/E4D, FCFE4PH, JCF/E4, JCF/E4, ECF/E4, ECF/E4-3KW, FCF/E4OLD3, ACF/E4, ACF/E4-3KW, FCF/E4OLD4, NCF/E4, FCF/E2, FCF/E4OLD2, FCF/E4OLD1, FCF/E4D, ZCF/E4, ZCF/E4 | | |





| | | | |
|---|---|-----------------|-------------------|
| 1 | | | |
| GEV No. | 350030 | Ref. No. | OK3053 |
| description | timer M2 2-pole operation time 120min impulse mechanical 2NO at 250V 16A permanent position no shaft ø 6x4.6mm shaft 6x4.6mm shaft L 23mm mounting distance 28mm connection lateral | | |
| accessories for | 350030 | | |
|  | GEV No. | 110366 | Ref. No. — |
| | knob switch zero mark t.max.°C°C ø 44mm shaft ø 6x4.6mm shaft flat upper black | | |
|  | GEV No. | 111199 | Ref. No. — |
| | dial plate graduation 120min permanent position no rotation 0-330° ø 60mm timers knob ø 45mm | | |



| | | | |
|---|--|-----------------|-------------------|
| 1 | | | |
| GEV No. | 350009 | Ref. No. | 056485 |
| description | timer M2 with bell 2-pole operation time 60min impulse mechanical 2NO at 250V 16A permanent position no shaft ø 6x4.6mm shaft 6x4.6mm shaft L 24mm mounting distance 28mm connection lateral | | |
| For models: | FVE3, FVE3, VAPE3 | | |
| accessories for | 350009 | | |
|  | GEV No. | 110366 | Ref. No. — |
| | knob switch zero mark t.max.°C°C ø 44mm shaft ø 6x4.6mm shaft flat upper black | | |
|  | GEV No. | 110373 | Ref. No. — |
| | dial plate graduation 60min permanent position no rotation 30-300° ø 60mm timers knob ø 45mm | | |



| | | | |
|---|--|-----------------|--------|
|  | | | |
| 1 | | | |
| GEV No. | 350141 | Ref. No. | OK6863 |
| description | timer TF 2-pole operation time 120min 2NO at 250V 16A permanent position no shaft ø 6x4.6mm shaft L 23mm mounting distance 28mm mounting thread M3 ambient temperature max. 80°C | | |

| | | | |
|---|--|-----------------|--------|
|  | | | |
| 1 | | | |
| GEV No. | 350222 | Ref. No. | OC3935 |
| description | timer with bell 2-pole operation time 90min impulse mechanical at 250V 16A shaft ø 6x4.6mm shaft L 21mm ambient temperature max. 125°C | | |
| For models: | FCF/E4, FCF/E4-3KW, FCF4E, FCF4E-3KW, ECF4E, ECF4E3KW, ECF/E4, ECF/E4-3KW, ACF/E4, ACF/E4-3KW, ACF4E, ACF4E3KW | | |

audible timers

| | | | |
|---|---|-----------------|--------|
|  | | | |
| 1 | | | |
| GEV No. | 350036 | Ref. No. | 004938 |
| description | audible timer operation time 60min ø 55mm shaft ø 6x4.6mm shaft L 22mm mounting distance 28mm | | |
| For models: | PPL5GG, PPFL5GG | | |

alarm devices

alarm units

| | | | |
|--|--|-----------------|--|
|  | | | |
| 1 | | | |
| GEV No. | 350056 | Ref. No. | 055368 0A2504 0A2505 0F0169 OKN825 |
| description | alarm device 220-240VAC ømm H 25mm wall-mounted version mounting distancemm 83dB protection IPx0 | | |
| For models: | FDV40G, FDV40E, FDV40GZ, FDV40EL, FDV40GA, FDV20G, FDV20E, FDV20GZ, FDV20EL, FDV20GA, RCP/E2S, MCP/E2S, PCP/E2SHP, OCP/E2S, TCP/E2S, TFRE1S12M0, TFRE2D12M0, TFRE1S12M4, TFRE2D12M4, FCF02EV, FCF02EOEM, FCF/G6-0, FCFG101/0, FCFG102-0, FCFG201-0, FCFG202-0, FCF/E6-0, FCFE101-0, FCFE102-0, FCFE201-0, FCFE202-0, FCF061ELN, FCF101ELN, FCF6EHOR, FCFG10160H, FCF061ENS, FCF101ENS, FCF102ENS, FCF201ENS, FCFG102-0T, FCF/G6-1-JAP, FCF/G101/1-1-JAP, FCF/G102/1-1-JAP, FCFE6-1J, FCFE101-1J, FCFE102-1J, FCF/G101/1, FCF/E3, FCF/E2, FCF/E2D...(Other models you can see in the webshop) | | |

buzzers

| | | | |
|---|---|-----------------|--|
|  | | | |
| 1 | | | |
| GEV No. | 350050 | Ref. No. | OG1057 0H6572 0H6596 OK2031 244123 245527 |
| description | buzzer 230VAC connection male faston 6.3mm screw mounting thread M4 60dB | | |
| For models: | 5702-2-2, 5702-2-3, 5704-2-2, 5704-2-3, 5707-2-2, 57074-2-3, 5701-3-2, 5701-3-3, 5702-3-2, 5702-3-3, 5704-3-2, 5704-3-3, 5707-3-2, 5707-3-3, 5611-3-6, 5612-3-6, 5614-3-6 | | |

| | | | |
|--|---|-----------------|------------------|
|  | | | |
| 1 | | | |
| GEV No. | 350085 | Ref. No. | 059001 0G1993 |
| description | buzzer connection plug-in connection | | |
| For models: | FCVE20/P-V, FCVE10-P, FCVE10PUK, FCVG10-P, FCVG10PUK, FCVE20-P, FCVE20PUK, FCVG20-P, FCVG20PUK, 5611-3-10, 5612-3-10, 5614-3-10 | | |



contactors

ABB

power contactors



1

| | | | |
|--------------------|--|-----------------|---------|
| GEV No. | 380108 | Ref. No. | 0033108 |
| description | power contactor resistive load 30A 230VAC (AC3/400V) 17A/7.5kW main contacts 3NO auxiliary contacts 1NO connection screw connection type A16-30-10 | | |

BENEDIKT & JÄGER

power contactors



1

| | | | |
|--------------------|---|-----------------|--------|
| GEV No. | 381471 | Ref. No. | 0C2244 |
| description | power contactor resistive load 110A 230 (AC3/400V) 50A/22kW main contacts 3NO connection screw type K3-50A00 | | |
| For models: | FCZ102EAA, FCZ102ETA, FCZ202ETA, FCZ102EBA, FCZ102EBA2, FCZ202EBA2, FCZ102ECA, FCZ102ECA2, FCZ202ECA2, AOS102EAMQ, AOS102EABQ, AOS102EAA1, AOS102EAC1, AOS102EAS1, AOS102EAM1, AOS202EAM1, AOS102EAB1, AOS202EAB1, AOS102EAK1, AOS102EAT1, AOS102ETA1, AOS202ETA1, AOS102ETM1, AOS202ETM1, AOS102ETK1, AOS202ETK1, AOS102EBA1, AOS102EBC1, AOS102EBK1, AOS102EBA2, AOS202EBA2, AOS102EBK2, AOS202EBK2, AOS102ECA1, AOS102ECM1, AOS102ECB1, AOS102ECA2, AOS202ECA2, AOS102ECM2 | | |



1

| | | | |
|--------------------|--|-----------------|--------|
| GEV No. | 381472 | Ref. No. | 0C7622 |
| description | power contactor resistive load 25A 230 (AC3/400V) 4kW main contacts 4NO connection screw | | |



1

| | | | |
|--------------------|--|-----------------|---|
| GEV No. | 380773 | Ref. No. | 045920 047048 048403 048825 069129 069130 072319 0E0580 0E3757 0K9120 0KA631 0KC418 0KL558 0KV050 0L0285 6282 628211 CA312 |
| description | power contactor resistive load 25A 230VAC (AC3/400V) 10A/4kW main contacts 3NO auxiliary contacts 1NC connection screw connection type K3-10A01230 | | |
| For models: | EPPWELG, EBS50, EBS50, EBS50, EBS50, EBV50, EBV50, EBV50, EBV50, EBV50, EBS100, EBS100, EBS100, EBS100, EBV100, EBV100, EBV100, EBV100, EBV-C100, EBV-C100, EBV-C100, EBV-C100, EBS200, EBS200, EBS200, EBS200, EBV200, EBV200, EBV200, EBV200, EBV-C200, EBV-C200, EBV-C200, EBV-C200, EBS300, EBS300, EBS300, EBS300, EBV300, EBV300, EBV300, EBV300, EBV-C300, EBV-C300, EBV-C300...(Other models you can see in the webshop) | | |



| | | | |
|--|---|-----------------|--|
|  <p>1</p> | | | |
| GEV No. | 380772 | Ref. No. | 045981 045982 048519 052370 053116 054544 057896 057951 066726 072058 075796 081676 082986 088477 0K2975 0KL557 440034000 767514100 |
| description | power contactor resistive load 25A 230VAC (AC3/400V) 10A/4kW main contacts 3NO auxiliary contacts 1NO connection screw connection type K3-10A10230 | | |
| For models: | AP20, BC100A, BC100DA, BC100RA, BC100RDA, BC180A, BC180DA, BC180RA, BC180RDA, BC180RPA, BC22, BC44, BC44H, BCF11, BCF22, BCF44, BCF44H, BCF100A, BCF100DA, BCF100RA, BCF100RDA, BCF180A, BCF180DA, BCF180RA, BCF180RDA, BCF180RPA, BCW061, BCW101, BCW102, BCFW061, BCFW101, BC22, BC44, BC44H, BCF11, BCF22, BCF44, BCF44H, BC120A, BC120RA, BCF120A, BCF120RA, BCWS061T, BCFW102, BLAST C/FREEZER, BLAST C/FREEZER, BLAST C/FREEZER, BLAST C/FREEZER, BLAST C/FREEZER...(Other models you can see in the webshop) | | |

| | | | |
|--|---|-----------------|--------|
|  <p>2</p> | | | |
| GEV No. | 381083 | Ref. No. | 0K3383 |
| description | power contactor resistive load 25A 230VAC (AC3/400V) 14A/5.5kW main contacts 3NO auxiliary contacts 1NC connection screw connection type K3-1401230 | | |

| | | | |
|--|--|-----------------|--------|
|  <p>1</p> | | | |
| GEV No. | 381084 | Ref. No. | 0H7051 |
| description | power contactor resistive load 25A 230VAC (AC3/400V) 14A/5.5kW main contacts 4NO auxiliary contacts connection screw connection type K3-14NA00 | | |

| | | | |
|---|--|-----------------|--------|
|  <p>1</p> | | | |
| GEV No. | 380959 | Ref. No. | 0KZ813 |
| description | power contactor resistive load 25A 24VAC (AC3/400V) 10A/4kW main contacts 3NO auxiliary contacts 1NO connection screw connection type K3-10ND10 24 | | |
| For models: | FCVE6-3CE, FCVE103CE, FCVE203CE, FCVE20/P-V, FCVMG62, FCVE10-P, FCVE10PUK, FCVG10-P, FCVG10PUK, FCVE20-P, FCVE20PUK, FCVG20-P, FCVG20PUK, EFT1W, WTF2ERC, WTF2ELC, WTF2SRC, WTF2SLC, WTF2HERC, WTF2HEL, WTF2HSRC, WTF2HSLC, WTF3ERC, WTF3ELC, WTF3SRC, WTF3SLC, WTF3HERC, WTF3HEL, WTF3HSRC, WTF3HSLC, WTF2ERB., WTF2ELB, WTF2SRB, WTF2SLB, WTF2HERB, WTF2HELB, WTF2HSRB, WTF2HSLB, WTF3ERB, WTF3ELB, WTF3SRB, WTF3SLB, WTF3HERB, WTF3HELB, WTF3HSRB, WTF3HSLB, WTF4HERB, WTF4HELB, WTF4HSRB, WTF4HSLB...(Other models you can see in the webshop) | | |

| | | | |
|--|---|-----------------|--|
|  <p>1</p> | | | |
| GEV No. | 380779 | Ref. No. | 046994 054259 058004 075723 0E0020 0E1291 0K3968 0K8545 0K9127 0KG583 0L0360 0TR640 30001827 |
| description | power contactor resistive load 25A 24VAC (AC3/400V) 14A/5.5kW main contacts 3NO auxiliary contacts 1NO connection screw connection type K3-14ND10 | | |
| For models: | LV4800HERC, WT200ELP, Z480PESECO, DTVSX, H512LVELEPL, H512LVLEPL, WT150HEL, WT730ERT, WTF4HSRB, WT150ELEPL+RBP, RT10ERCBF, WT140ELP, H522VELECO, WT730WSRST, CT191SXE, WT100EL, H522LVERC, ECRT200LA, RT140ERCF, NRT200LAA6, WT200HERC, RT190ELG, WT95ERF, RT34HDEDEP, CT191DXE, WT790WSLTM, CT190SXV, A/DTEDEX, LV4800ELC, RT100ELCG, RT270EDEPLU, RT140EPLS, HABER/ERT, WT190HEL, WT150SLEPL, RT270HDESECOFWHIRPOO, WTF4HELA, NRT250LA6, RT2500EDBERGERAND, WT150SLM, WT95SL, FT72VDT, RT4800HDEDEPLBERGERA, NRT200RAA, WT100SRP, RT142ESECOFWHIRPOOL, RT140EDEPLF, WT150HSLC, CT140EDX, RT100ESECO...(Other models you can see in the webshop) | | |



1

| | | | |
|--------------------|--|-----------------|---|
| GEV No. | 380774 | Ref. No. | 006437 006438 006879 058805 OKA632 OKI328 62790702 68767513210 |
| description | power contactor resistive load 32A 230VAC (AC3/400V) 18A/7.5kW main contacts 3NO auxiliary contacts 1NO connection screw connection type K3-18ND10 | | |
| For models: | BF/E1S12, BFR/E1S14, MCP/E1SH, MCP/E1SUH, MCP/E2SUHS, MCP/E2SH, MCP/E2SUH, MCP/E2SUT, MCP/E2SHB, PBR/E2FM, PBR/E2IM, PMV/E1C, PMV/E2C, PF/E1D05, PF/E1S12, PF/E2D12, PF/E1D05E5, PF/E1S12E5, PF/E2D12E5, PPI/E260P, ECP/E1ELHU, PCP/E2SHP, PCP/E1SH, PCP/E2SH, PCP/E2SH3B, PCP/E1ELH, OBR/E2FM, OBR/E2IM, OMV/E1C, OMV/E2C, OF/E1S12, OF/E2D12, OPI/E260P, OCP/E2S, OCP/E1SH, OCP/E2SH, TBR/E2FM, TBR/E2IM, TMV/E1C, TMV/E2C, TF/E1D05, TF/E1S12, TF/E2D12, TFR/E1S12, TFR/E2D12, TFR/E1S14, TFR/E2D14, TF/E1D05E5, TF/E1S12E5, TF/E2D12E5...(Other models you can see in the webshop) | | |



1

| | | | |
|--------------------|--|-----------------|---|
| GEV No. | 381171 | Ref. No. | 006157 056600 0E0177 OK3969 OK6190 OK9124 767511112 |
| description | power contactor resistive load 32A 24VAC (AC3/400V) 22A/11kW main contacts 3NO auxiliary contacts 1NO connection screw connection type K3-22ND10 | | |
| For models: | HFH/E430, ZFH/E430, FV4E, FV4E, FT36ED, FT36ES, FT36VD, FT36VS, FT50ED, FT50ES, FT50VD, FT50VS, FT72ED, FT72ES, FT72VD, FT72VS, FT36EDT, FT36EST, FT36VDT, FT36VST, FT50EDT, FT50EST, FT50VDT, FT50VST, FT72EDT, FT72EST, FT72VDT, FT72VST, FT36EDTS, FT36ESTS, FT36VDTS, FT36VSTS, FT36ED, FT36ES, FT36VD, FT36VS, FT50ED, FT50ES, FT50VD, FT50VS, FT72ED, FT72ES, FT72VD, FT72VS, FT36EDT, FT36EST, FT36VDT, FT36VST, FT50EDT, FT50EST...(Other models you can see in the webshop) | | |



1

| | | | |
|--------------------|--|-----------------|--------------------------------------|
| GEV No. | 380673 | Ref. No. | 0H7052 OK3384 OK9307 582311 |
| description | power contactor resistive load 45A 230VAC (AC3/400V) 11kW | | |
| For models: | FDV40E, FDV40EL, FDV20E, FDV20EL, FCV/E20L3, FCVE202L3, FCVE202L6, 5717-3-7, 5717-3-8, 5717-3-8E, 5717-3-10, 5717-3-8M, 5717-3-8C, 5711-3-10F, 5711-3-10S, 5707-3-2, 5707-3-3, ECVE202T4, ECVE202T6, ZFT/E1M0, ACVE202C4, ACV/E202/1, ZCV/E202/1, ZCV/E202/1, 5612-3-10, 5612-3-6, 5612-3-8, 5614-3-10, 5614-3-6, 5614-3-8 | | |



1

| | | | |
|--------------------|--|-----------------|------------------|
| GEV No. | 380521 | Ref. No. | 005238 OK3385 |
| description | power contactor resistive load 45A 230VAC (AC3/400V) 23A/11kW main contacts 4NO connection screw connection type K2-23A0040230 | | |
| For models: | 5717-3-7, 5717-3-8, 5717-3-8E, 5717-3-10, 5717-3-8M, 5717-3-8C | | |



| | | | | |
|--------------------|--|-----------------|--|---|
| 1 | | | | 002167 052329 054928 057950 059943 0H9713 0K4938 0K9129 0KE717 0KI949 0W0690 767511412 |
| GEV No. | 380637 | Ref. No. | | |
| description | power contactor resistive load 45A 230VAC main contacts 3NO auxiliary contacts 1NO connection screw type K2-23A10 230 | | | |
| For models: | MFR/E740, RFR/E2S40, XFR/E2S40, JFR/E2S40, MFR/E2S40, RFR/E741, CFR/E702, HFR/E418, HFR/E818, HFR/E430, HFR/E830, HFRS/E430, HFR/E431, HFR/E831, HBR/E810, HBR/E815, HBR/E811, HBR/E816, HPN/EI815D, HPN/EI815, HPA/EI825, HPNS/EI815, HPNS/EI815D, ZFR/E418, ZFR/E818, ZFR/E430, ZFR/E830, ZFRS/E430, ZFR/E431, ZFR/E831, ZBR/E810, ZBR/E815, ZBR/E811, ZBR/E816, ZPN/EI815D, ZPN/EI815, ZPNS/EI815, ZPNS/EI815D, AFR/E430, AFR/E830, AFRS/E430, AFR/E431, AFR/E831, ABR/E810, ABR/E815, ABR/E811, ABR/E816, ABR/E810, ABR/E815, ABR/E811...(Other models you can see in the webshop) | | | |

| | | | | |
|--------------------|--|-----------------|--|--------|
| 2 | | | | |
| GEV No. | 381173 | Ref. No. | | 0C9763 |
| description | power contactor resistive load 50A 230VAC (AC3/400V) 24A/11kW main contacts 3NO auxiliary contacts 1NO connection torx type K3-24B00 50/60Hz | | | |

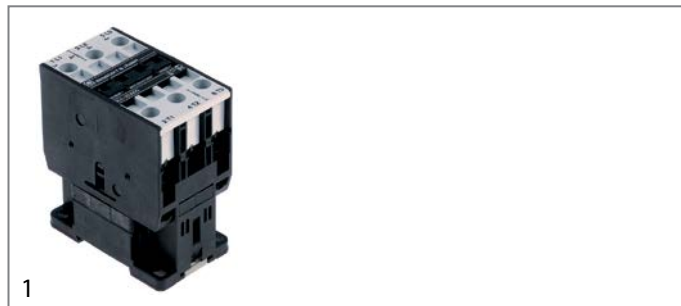

| | | | | |
|--------------------|--|-----------------|--|--------|
| 1 | | | | |
| GEV No. | 381085 | Ref. No. | | 0L0355 |
| description | power contactor resistive load 50A 230VAC (AC3/400V) 24A/11kW main contacts 3NO auxiliary contacts connection screw connection type K3-24A00230 | | | |
| For models: | FCZ102EAA, FCZ102ETA, FCZ202ETA, FCZ102EBA, FCZ102EBA2, FCZ202EBA2, FCZ102ECA, FCZ102ECA2, FCZ202ECA2, FCFE101-0, FCFE102-0, FCFE201-0, FCFE202-0, FCF101ELN, FCF101ENS, FCF102ENS, FCF201ENS, FCFE101-1J, FCFE102-1J, ECFE101-0, ECFE102-0, ECFE201-0, ECFE202-0, ECF101ENS, ECF102ENS, ECF201ENS, AOS102EAA1, AOS102EAC1, AOS102EAS1, AOS062EAM1, AOS102EAM1, AOS062EAB1, AOS102EAB1, AOS102EAK1, AOS102EAT1, AOS102ETA1, AOS202ETA1, AOS062ETM1, AOS102ETM1, AOS202ETM1, AOS102ETK1, AOS202ETK1, AOS102EBA1, AOS102EBC1, AOS102EBK1, AOS102EBA2, AOS202EBA2, AOS102EBK2, AOS202EBK2, AOS102ECA1...(Other models you can see in the webshop) | | | |

| | | | | |
|--------------------|--|-----------------|--|--------|
| 1 | | | | |
| GEV No. | 380775 | Ref. No. | | 007080 |
| description | power contactor resistive load 65A 230VAC (AC3/400V) 32A/15kW main contacts 3NO auxiliary contacts connection screw connection type K3-32A00230 | | | |
| For models: | KPI/E10, KPI/E15, KPI/E15A, KPI/E15H, KPI/E10H, KFR/E1E, KFR/E2F, KFR/E1C, KFR/E2D, KFR/E1CE5, KFR/E2DE5, QPI/E10, QPI/E15, QPI/E15H, QPI/E10H, QFR/E1E, QFR/E2F, QFR/E1C, QFR/E2D, WPI/E10, WPI/E15, WPI/E15A, WPI/E15H, WPI/E10H, WFR/E1E, WFR/E2F, WFR/E1C, WFR/E2D, FCZ101EAA, FCZ102EAA, FCZ101EAH, FCZ101EAN, FCZ201EAN, FCZ101ETA, FCZ102ETA, FCZ201ETA, FCZ202ETA, FCZ101ETH, FCZ201ETH, FCZ101ETN, FCZ201ETN, FCZ101EBA, FCZ102EBA, FCZ101EBH, FCZ101EBN, FCZ201EBN, FCZ101EBC, FCZ201EBC, FCZ101EBA2, FCZ102EBA2...(Other models you can see in the webshop) | | | |



1

| | | | |
|--------------------|---|-----------------|------------------|
| GEV No. | 380776 | Ref. No. | 007104 0G3044 |
| description | power contactor resistive load 80A 230VAC (AC3/400V) 40A/18.5kW main contacts 3NO auxiliary contacts connection screw connection type K3-40A00230 contacts | | |
| For models: | FCZ201EAA, FCZ202EAA, FCZ201EAH, FCZ201ETA, FCZ202ETA, FCZ201ETH, FCZ201ETN, FCZ201EBA, FCZ202EBA, FCZ201EBH, FCZ201EBC, FCZ201EBA2, FCZ202EBA2, FCZ201EBH2, FCZ201EBN2, FCZ201EBC2, FCZ202ECA, FCZ201ECA2, FCZ202ECA2, FCZ201ECH2, FCZ201ECN2, FCS101E44J, FCS101EP4J, FCS201E4, FCS201EP, FCS101EX4J, FCS201EX, CL221, AOS201EA, AOS201EB, AOS201EB5M, AOS201EB6M, AOS102EA2N, AOS102EB2N, AOS202EA2N, AOS202EB2N, AOS201EA0H, AOS201EB0H, AOS202EA, AOS202EB, AOS201EAAQ, AOS201EBAQ, AOS202EAAQ, AOS202EBAQ, AOS102EANQ, AOS102EBNQ, AOS202EANQ, AOS202EBNQ, AOS201EAHQ, AOS201EBHQ...(Other models you can see in the webshop) | | |

auxiliary contacts



1

| | | | |
|--------------------|--|-----------------|---|
| GEV No. | 380677 | Ref. No. | 047046 059086 0E0888 0H7044 0K9121 0KC515 767510292 |
| description | auxiliary contact contacts 1NC AC15 10A for contactors K2/K3 connection screw type HN01 AC1 25A | | |
| For models: | EBS50, EBS50, EBS50, EBS50, EBV50, EBV50, EBV50, EBV50, EBV50, EBS100, EBS100, EBS100, EBS100, EBV100, EBV100, EBV100, EBV100, EBV100, EBV-C100, EBV-C100, EBV-C100, EBS200, EBS200, EBS200, EBS200, EBV200, EBV200, EBV200, EBV200, EBV200, EBV-C200, EBV-C200, EBV-C200, EBV-C200, EBS300, EBS300, EBS300, EBS300, EBV300, EBV300, EBV300, EBV300, EBV300, EBV-C300, EBV-C300, EBV-C300, EBV-C300, EBV50...(Other models you can see in the webshop) | | |



1

| | | | |
|--------------------|---|-----------------|--|
| GEV No. | 380678 | Ref. No. | 046995 0C4704 0E0418 0H7043 0H7045 0K9119 0KA929 0KE890 1SHN10 |
| description | auxiliary contact contacts 1NO AC15 10A for contactors K2/K3 connection screw type HN10 AC1 25A | | |
| For models: | EBS50, EBS50, EBS50, EBS50, EBV50, EBV50, EBV50, EBV50, EBV50, EBS100, EBS100, EBS100, EBS100, EBV100, EBV100, EBV100, EBV100, EBV100, EBV-C100, EBV-C100, EBV-C100, EBV-C100, EBV-C100, EBV-C100, EBV200, EBV200, EBV200, EBV200, EBV200, EBV-C200, EBV-C200, EBV-C200, EBV-C200, EBV300, EBV300, EBV300, EBV300, EBV300, EBV-C300, EBV-C300, EBV-C300, EBV-C300, EBV-C300, AOW101EA, AOW101EABU, LC10E, LC12E, CLC12, LACE12M/EI, CLC22...(Other models you can see in the webshop) | | |

GENERAL ELECTRIC (AEG)

power contactors



1

| | | | |
|--------------------|--|-----------------|--------|
| GEV No. | 380246 | Ref. No. | 0KQ380 |
| description | power contactor resistive load 25A 400VAC (AC3/400V) 9A/4kW main contacts 3NO auxiliary contacts 1NO connection screw connection type AEG LS4K 10A type GE CL00A 310 | | |
| For models: | CUTE0523, CUTE0538, KT055, KT056, K55 | | |



1

| | | | |
|--------------------|---|-----------------|--------|
| GEV No. | 380262 | Ref. No. | 0K3374 |
| description | power contactor resistive load 32A 230VAC (AC3/400V) 17A/7.5kW main contacts 3NO auxiliary contacts 1NC connection screw connection type AEG LS7K01A type GE CL02A 301 H 85mm | | |



ISKRA (FANAL)

power contactors

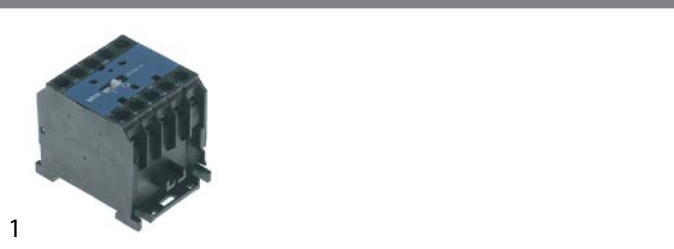

| | | | | |
|---|----------------|--------|-----------------|--------|
| 1 | GEV No. | 380213 | Ref. No. | 086215 |
| description power contactor resistive load 20A 230VAC (AC3/400V) 8.5A/5.5kW main contacts 3NO auxiliary contacts 1NO connection screw connection type Fanal DSL7 10 type ISKRA K07M 10 | | | | |



| | | | | |
|---|----------------|--------|-----------------|------------------------------------|
| 1 | GEV No. | 380204 | Ref. No. | 003027 004206 OK3606 6208 |
| description power contactor resistive load 25A 230VAC (AC3/400V) 9A/4kW main contacts 3NO auxiliary contacts 1NO connection screw connection type Fanal DSL9 10 type ISKRA KNL9 10 | | | | |
| For models: SGE350, SGE350, GR35E6U, MAX18/35X, ZCMDE6, ZCBDE12, ZCMDE4, ZCBDE8, ZCMDE9, ZCBDE18, FFPS16, FFPS32 | | | | |

LOVATO

power contactors



| | | | | |
|---|----------------|--------|-----------------|--------|
| 1 | GEV No. | 380720 | Ref. No. | OKD792 |
| description power contactor resistive load 32A 230VAC (AC3/400V) 25A/12.5kW main contacts 3NO auxiliary contacts 1NO connection screw connection type BF2510A230 | | | | |

MOELLER/EATON

power contactors



| | | | | |
|---|----------------|--------|-----------------|--|
| 1 | GEV No. | 380171 | Ref. No. | 0H6542 0H7046 0K1883 0K2061 0KN149 582249 |
| description power contactor resistive load 20A 230VAC (AC3/400V) 9A/4kW main contacts 3NO auxiliary contacts 1NO connection screw connection type DILEM 10 | | | | |

TELEMECANIQUE (Schneider Electric)

power contactors



| | | | | |
|---|----------------|--------|-----------------|--------|
| 1 | GEV No. | 380479 | Ref. No. | OK2051 |
| description power contactor resistive load 25A 230VAC (AC3/400V) 9A/4kW main contacts 3NO auxiliary contacts 1NO/1NC connection screw connection type LC1D09P7 | | | | |

TRIPUS (Eichhoff)

small relay switches

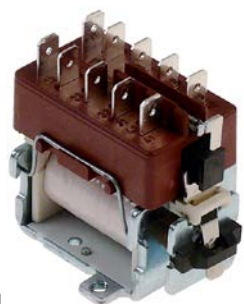

| | | | |
|--------------------|---|-----------------|-----------------------------|
| GEV No. | 380120 | Ref. No. | 0H6541 240602 307P065 |
| description | small relay switch 230V AC1 16A main contacts 4NO connection Faston 6.3mm type 307P002 resistive load 16A | | |
| For models: | 7561-3.KES60.RW, 7562-3.KES80.RW, 7563-3.KES100.RW, 7564-3.KES150.RW, 7720-3/90.WB.GN1/1., 7520-3/85.WB.GN1/1., 7731-3/85.GRPL.VCHR., 7701-3/85, 7721-3/85.WB.GN2/1, 7501-3/85., 7531-3/85., 7501-3/90.HE.4PL.(N), 7531-3/90.GRPL.(N), 7508-3/85., 7502-3/85., 7520-3/90.WB.GN1/1., 7720-3/85.WB.GN1/1., 7561-3/85.KES60.RW., 7562-3/85.KES80.RW., 7563-3/85.KES100.RW., 7564-3/85.KES150.RW., 7561-3/90.KES60.RW., 7562-3/90.KES80.RW., 7563-3/90.KES100.RW., 7564-3/90.KES150.RW., 7500-3/85.HE.2PL.(N), 7503-3/85.HE.6PL, 7504-3/85.HE.6PL.BO, 7505-3/85, 7506-3/85.HE.CER.2KZ, 7507-3/85., 7511-3/85.KF.(N), 7512-3/85.KF.BO.(N), 7530-3/85.GRIPL.(N), 7532-3/85.GRPL.GL-GR, 7521-3/85., 7500-3/90.HE.2PL.(N), 7502-3/90.HE.4PL.BO., 7503-3/90.HE.6PL.(N), 7504-3/90.HE.6PL.BO., 7505-3/90.HE.6PL.BO., 7506-3/90.HE.CER.2KZ, 7507-3/90.HE.CER.4KZ, 7508-3/90.HE.CER.BO., 7511-3/90.KF.(N), 7512-3/90.KF.BO.(N), 7530-3/90.GRIPL.(N), 7532-3/90.GRPL.GL-GR, 7521-3/90.WB.GN2/1., 7700-3/85...(Other models you can see in the webshop) | | |

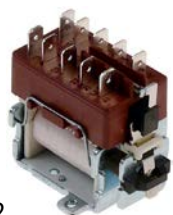

| | | | |
|--------------------|--|-----------------|----------------------------|
| GEV No. | 380121 | Ref. No. | 0H6544 0H7193 601962 |
| description | small relay switch 230V main contacts 3NO/1NC auxiliary contacts knob ø70mm (227-piece) connection Faston 6.3mm type E3250 resistive load 16A | | |
| For models: | 7560-3, 7561-3, 7562-3, 7563-3, 7564-2, 9050-3, 9100-3, 9101-3, 9102-3, 9104-3, 9106-3, 9108-3, 9111-3, 9113-3, 9114-3, 9115-3, 9116-3, 9250-3-0, 9250-3-8, 9300-3-0, 9300-3-8, 9301-3-0, 9301-3-8, 9302-3-0, 9302-3-8, 9304-3-0, 9304-3-8, 9306-3-0, 9306-3-8, 9308-3-0, 9311-3-0, 9311-3-8, 9313-3-0, 9313-3-8, 9314-3-0, 9314-3-8, 9315-3-0, 9315-3-8, 9316-3-0, 9316-3-8, 9317-3-8, 9411-3, 9413-3, 9414-3, 9415-3, 9416-3 | | |

miscellaneous

power contactors



| | | | |
|--------------------|--|-----------------|------------------------------|
| GEV No. | 380949 | Ref. No. | 004159 0C3145 91310155 |
| description | power contactor resistive load 20A 230VAC (AC3/400V) 2.5kW main contacts 3NO auxiliary contacts NC/NO connection screw connection type MC-9b | | |
| For models: | ZCMDE6, ZCBDE12, ZCMME6, ZCBME12, ZCMDE4, ZCBDE8, ZCMME4, ZCBME8, ZCMDE9, ZCBDE18, ZCMME9, ZCBME18, FFPS16, FFPS32 | | |

relays

power relays

with flange mounting



| | | | |
|--------------------|---|-----------------|----------------------------|
| GEV No. | 380131 | Ref. No. | 046001 053737 081261 |
| description | power relays Italiana Relè 230VAC 16A 3CO connection male faston 6.3mm screw mounting manuf. no. B2-3-230AC | | |
| For models: | AP20, ILP110, ILP110UK, ILN120, ILP111, ILP220, ILP220UK, ILP240, ILP221, ILN110, ILN110UK, ILN120, ILN111, ILN220, ILN220UK, ILN240, ILN221, ILNN220, ILNN220UK, ILNN230, ILF110, ILF110, ILF120, ILF220, ILF220UK, ILF240, ILNF120, ILNF220, ILNF220UK, ILNF230, FCVE10-2, FCVE10-4, FCVE10-2UK, FCVE10-4UK, FCVG10-2, FCVG10-4, FCVG10-2UK, FCVG10-4UK, FCVE20-2, FCVE20-4, FCVE20-2UK, FCVE20-4UK, FCVG20-2, FCVG20-4, FCVG20-2UK, FCVG20-4UK, ZOFCEV/E102, ZOFCEV/E104, ZOFCEV/G102, ZOFCEV/G104...(Other models you can see in the webshop) | | |



with bracket mounting

1



| | | | |
|--------------------|--|-----------------|--|
| GEV No. | 380626 | Ref. No. | 031295 031314 031609 031610 058557 058857 069882 083215 |
| description | power relays FINDER 230VAC 10A 2CO connection male faston 4.8mm bracket mounting manuf. no. 62.62.8.230.0000 | | |
| For models: | BC11, BC22, BC44, BC44H, BCF11, BCF22, BCF44, BCF44H, BCF15A6, , , BCFW061, BCFW101, ALN110, ALN120, ALNN120, ALNN220, ALNN230, ALN110UK, ALNN220UK, ALF110, ALF220UK, ALNF220, ALF110, ALF120, ALF220, ALF240, ALNF120, ALNF220, ALNF230, BC11, BC22, BC44, BC44H, BCF11, BCF22, BCF44, BCF44H, BCWS061T, BCFW102, ALN110UK, ALNN220UK, ALF110UK, ALNF220UK, ALN110, ALN120, ALF110, ALF120, ALF220, ALF240...(Other models you can see in the webshop) | | |

2



| | | | |
|--------------------|--|-----------------|--|
| GEV No. | 380312 | Ref. No. | 056446 056466 085296 086214 0D0013 |
| description | power relays FINDER 230VAC 10A 3CO connection male faston 4.8mm bracket mounting dimensions 52x32.2x36.5mm manuf. no. 60.63.8.230.0000 | | |
| For models: | MCP/G700, 7CPE07P, 7CPG07P, M70EPC, M70GPC, RCP/G700, HBR/G801, HBR/G806, HBR/G811, HBR/G816, HBR/G801D, HBR/G806D, HBR/G811D, HBR/G816D, HBR/E801, HBR/E806, HBR/E811, HBR/E816, ZBR/G801, ZBR/G806, ZBR/G811, ZBR/G816, ZBR/G801D, ZBR/G806D, ZBR/G811D, ZBR/G816D, ZR/G413, BR/E806, ZBR/E811, ZBR/E816, ABR/G801, ABR/G806, ABR/G811, ABR/G816, ABR/G801D, ABR/G806D, ABR/G811D, ABR/G816D, ABR/E801, ABR/E806, ABR/E811, ABR/E816, FCZ061EAA, FCZ101EAA, FCZ102EAA, FCZ061EAH, FCZ101EAH, FCZ061EAN, FCZ101EAN, FCZ061ETA...(Other models you can see in the webshop) | | |

1



| | | | |
|--------------------|---|-----------------|--------|
| GEV No. | 380139 | Ref. No. | OPE302 |
| description | power relays FINDER 230VAC 16A 2CO connection F6.3 bracket mounting dimensions 68x38.2x35.8mm manuf. no. 62.82.8.230.0000 | | |

1



| | | | |
|--------------------|---|-----------------|------------------|
| GEV No. | 380403 | Ref. No. | 088197 0A9596 |
| description | power relays FINDER 230VAC 16A 3CO connection F6.3 bracket mounting manuf. no. 62.83.8.230.0500 | | |
| For models: | BC100A, BC100DA, BC100RA, BC100RDA, BC180A, BC180DA, BC180RA, BC180RDA, BC180RPA, BCF100A, BCF100DA, BCF100RA, BCF100RDA, BCF180A, BCF180DA, BCF180RA, BCF180RDA, BCF180RPA, AQC119U US, , , BCW061, BCW101, BCW201R, BCW102, BCFW061, BCFW101, BCFW201R, BC120A, BC120RA, BCF120A, BCF120RA, BCWS061T, BCFW102, BLAST C/FREEZER, BLAST C/FREEZER, BLAST C/FREEZER, BLAST C/FREEZER, BLAST C/FREEZER, BLAST C/FREEZER, BCFWS102, BCFWS101, AZF1103, AZF2203, BC56VA, Crosswise 20, BC56HA, BCF28A...(Other models you can see in the webshop) | | |

1



| | | | |
|--------------------|--|-----------------|--|
| GEV No. | 380702 | Ref. No. | 005033 005034 0K2397 0K2398 0K2445 0T3793 261956 261957 |
| description | power relays FINDER 230VAC 16A 3NO connection male faston 6.3mm flange dimensions 36x38x68mm manuf. no. 62.83.8.230.0300 230V | | |
| For models: | FCZ102GTG, FCZ102GTD, FCZ102GBG2, FCZ102GBD2, FCZ102GBI2, FCZ102GCG2, FCZ102GCD2, FCV/G20L3, FCV/G20L3, FCV/G20L6, FCV/E20L6, FCV/G20L6, FCVE202L6, FCV/G201/1, FVC/E201/1, FCV/G202/1, FVC/E202/1, FCS201E4, FCS201EP, FCS202E4, FCS202EP, FCS201G4, FCS201GP, FCS202G4, FCS202GP, FCS201EX, FCS201EXLN, FCS202EX, FCS201GX, FCS202GX, 5711-2-7, 5711-2-8, 5711-2-10, 5711-2-8CH, 5711-2-10CH, 5712-2-7, 5712-2-8, 5712-2-10, 5714-2-6, 5714-2-7, 5714-2-8, 5714-2-10, 5717-2-6, 5714-2-7, 5714-2-8, 5714-2-10, 5711-2-7L, 5711-2-8L, 5711-2-10L, 5712-2-7L...(Other models you can see in the webshop) | | |

1

| | | | |
|--------------------|---|-----------------|--------|
| GEV No. | 380636 | Ref. No. | 056510 |
| description | power relays FINDER 24VAC 10A 3CO connection male faston 4.8mm bracket mounting manuf. no. 60.63.8.024.0000 | | |
| For models: | BC100A, BC100DA, BC100RA, BC100RDA, BC180A, BC180DA, BC180RA, BC180RDA, BC180RPA, BCF100A, BCF100DA, BCF100RA, BCF100RDA, BCF180A, BCF180DA, BCF180RA, BCF180RDA, BCF180RPA, AQC31U US, AQC60U, AQC119U US, , , BC28A6, Crosswise, , , BC-F15A6, , , BCW061, BCW101, BCW201R, BCW102, BCFW061, BCFW101, BCFW201R, BC120A, BC120RA, BCF120A, BCF120RA, BCWS061T, BCFW102, BLAST C/FREEZER, BLAST C/FREEZER, BLAST C/FREEZER, BLAST C/FREEZER, BLAST C/FREEZER, BLAST C/FREEZER, BLAST C/FREEZER... (Other models you can see in the webshop) | | |



1

| | | | |
|--------------------|--|-----------------|--------|
| GEV No. | 380185 | Ref. No. | 085647 |
| description | power relays Italiana Relè 230VAC 30A 1NO connection F6.3 bracket mounting dimensions 36.5x32.2x51.8mm manuf. no. A10-230AC-FA | | |
| For models: | DLV14/F, DLVT14/F, DLV21/F, DLVT21/F, ZDLV14/F, ZDLVT14/F, DLV21/F, DLVT21/F, ADLV14/F, ADLVT14/F, DLV21/F, DLVT21/F, SMV15/F, SMV21/F, SMV15/F, SMV21/F | | |



1

| | | | |
|--------------------|---|-----------------|--------|
| GEV No. | 381252 | Ref. No. | 088267 |
| description | relay OMRON 230VAC 25A 2NO connection male faston 6.3mm bracket mounting at 250V 25A manuf. no. G7L-2A-TUB 230VAC | | |





1

| | | | |
|--------------------|---|-----------------|--------|
| GEV No. | 380950 | Ref. No. | 0A9500 |
| description | relay SCHRACK 230VAC 25A 2CO connection F6.3 with mounting strap at 250V 25A manuf. no. RM805730 250V 4-pole | | |
| For models: | SSWC12, SSWC16, SSWC20, SSWB12, SSWB16, SSWB20, DRVAF12, DRVAF16, DRVAF20, DRVP12, DRVP16, DRVP20, ZLRW12C, ZLRW16C, ZLRW20C, ZLRW12B, ZLRW16B, ZLRW20B | | |

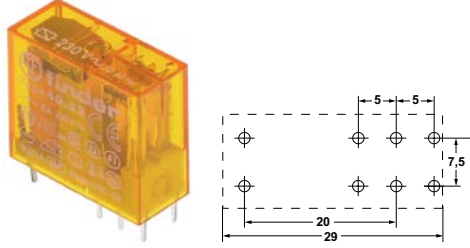
plug-in/print relays



1

| | | | |
|---|---|-----------------|--|
| GEV No. | 380333 | Ref. No. | 0E5849 0K4551 0K4947 0K6309 11031629 71331201 |
| description | print relay 230VAC 2CO at 250V 8A connection pins raster size 5mm FINDER manuf. no. 40.52.8.230.0000 95.65/95.75 | | |
| For models: | RT10ED, RT10ES, RT10SR, RT10SL, RT10ED/230, RT10ES/230, RT10ERF60, RT10ELF60, RT10ERF, RT10ELF, RT10ERBF60, RT10ELBF60, RT10ERG, RT10ELG, RT10EDH, RT10ESH, RT10SRB, RT10SLB, RT10ED/230H, RT10ES/230H, RT10ERBF, RT10ELBF, RT10ERBG, RT10ELBG, RT10EDECO, RT10ESECO, RT10SRC, RT10SLC, RT10ED/230E, RT10ES/230E, RT10ERCF, RT10ELCF, RT10ERCG, RT10ELCG, RT10EDHE, RT10ESHE, RT10SRCB, RT10SLCB, RT10ED/230HE, RT10ES/230HE, RT10ERCBF, RT10ELCBF, RT10ERCBG, RT10ELCBG, RT10ERASIA, RT10ELASIA, RT10SRASIA, RT10SLASIA, RT10ERCINA, RT10ELCINA... (Other models you can see in the webshop) | | |
| accessories for | 380333 | | |
|  | GEV No. | 380340 | Ref. No. — |
| | relay socket dimensions 62x36x15mm 250V voltage AC 10A Italiana Relè manuf. no. ZMEM/5 | | |
|  | GEV No. | 380505 | Ref. No. — |
| | relay socket 2CO 40.52 dimensions 81.9x15.5x75mm 250V voltage AC 10A FINDER manuf. no. 95.95.3 | | |
|  | GEV No. | 381181 | Ref. No. — |
| | relay socket 2-pole 40.51/40.52/40.61 connection screw clamp dimensions 15.8x78.6mm 250V voltage AC 10A FINDER manuf. no. 95.75 | | |

relay sockets



1

| | | | |
|---|--|-----------------|-------------------|
| GEV No. | 380137 | Ref. No. | 053912 |
| description | relay socket 8-pole connection plug-in connection round 8-pole dimensions 65x28x40mm 380V voltage AC 10A Italiana Relè manuf. no. ZVE8 | | |
| For models: | FVGC4, FV4G, FV4E, HCPA/G1219, HCPA/GI1219, HCPA/V1219, FV4G, FV4E, FVAC041, HCPA/G121, HCPA/G121 | | |
| accessories for | 380137 | | |
|  | GEV No. | 380805 | Ref. No. — |
| | support bracket | | |



level relays

GICAR



1

| | | | |
|--------------------|--|-----------------|--------|
| GEV No. | 401224 | Ref. No. | 031520 |
| description | level relay 230V connection F6.3 type RL30/3ES/F/G | | |



1

| | | | |
|----------------|--------|-----------------|---|
| GEV No. | 400018 | Ref. No. | 004837 005048 055359 055458 0A8502 0C0937 0H6151 0H6585 0K9194 0KE598 0M2262 18E18 213810 |
|----------------|--------|-----------------|---|

| | | | |
|--------------------|---|--|--|
| description | level relay 230V voltage AC connection F6.3 type RL30/3ES/F/G | | |
| For models: | FDV40G, FDV40E, FDV40GZ, FDV40EL, FDV40GA, FDV20G, FDV20E, FDV20GZ, FDV20EL, FDV20GA, KPI/G15H, KPI/E15H, KPI/G10H, KPI/E10H, QPI/G15H, QPI/E15H, QPI/G10H, QPI/E10H, WPI/G15H, WPI/E15H, WPI/G10H, WPI/E10H, FCVG202L3, FCVG202L6, FCV/G202/1, FCS201G4, FCS202G4, FCS202GP, FCS202GX, FVE3, FCVE6-1U, FCVE6-3U, FCVE6-1, FCVE6-3, FCVE6-1UK, FCVE6-3UK, FCVG6-1, FCVG6-3, FCVG6-1UK, FCVG6-3UK, FCVE10-2, FCVE10-4, FCVE10-2UK, FCVE10-4UK, FCVG10-2, FCVG10-4, FCVG10-2, FCVG10-4D, FCVG10-2UK, FCVG10-4UK...(Other models you can see in the webshop) | | |

miscellaneous



1

| | | | |
|--------------------|--|-----------------|--------|
| GEV No. | 402951 | Ref. No. | 053913 |
| description | level controller 50/60Hz 24V voltage AC 10A type RL30/3ES/11 | | |
| For models: | CRN22G, CRN/20G, CRN30G, CRN15G, CRN15V, CRN15E, CRN/22GZ, CRN20GZ, CRN30GZ, CRN15GZ, CRN15V-Z, CRN15EZ, CRN20GA, CRN30GA, CRN15GA, CRN15VA, CRN15EA, FCVE10, FCVE20, FVGC4, FV4G, FV4E, CR42G, CR42V, CR42E, CR/40G, CR/40V, CR40E, FV4G, FV4E, FVAC041 | | |



1

| | | | |
|--------------------|---|-----------------|------------------|
| GEV No. | 401638 | Ref. No. | 056496 911987 |
| description | level relay 24V type RL30/3ES/F/G | | |
| For models: | FCVE6-3CE, FCVE103CE, FCVE203CE, FCVM62E, FCVM62EUK, FCVE10-P, FCVE10PUK, FCVG10-P, FCVG10PUK, FCVE20-P, FCVE20PUK, FCVG20-P, FCVG20PUK, AFCV/G6-1, AFCV/G6-3, SCO/G6-3, AFCV/G101, AFCV/G103, SCO/G10-3, AFCV/G201, AFCV/G203, SCO/G20-3 | | |



1

| | | | |
|--------------------|---|-----------------|--------------------------------------|
| GEV No. | 400002 | Ref. No. | 0H6222 0K0643 0KF903 214871 |
| description | level relay type FTL 160 | | |
| For models: | 5611-3-10, 5611-3-6, 5611-3-8, 5612-3-10, 5612-3-6, 5612-3-8, 5614-3-10, 5614-3-6, 5614-3-8 | | |

time relays

time relays





1

| | | | |
|--------------------|---|-----------------|------------------|
| GEV No. | 380682 | Ref. No. | 0H6817 0K2378 |
| description | time relay CROUZET time range 1s-100h 24VDC | | |
| For models: | 5611-3-10, 5611-3-8, 5612-3-10, 5612-3-8, 5614-3-10, 5614-3-8 | | |

1

| | | | |
|---|--|-----------------|-------------------|
| GEV No. | 360104 | Ref. No. | 004181 |
| description | time relay FINDER 88.12.0.230.0002 time range 0.05s-100h 24-230V AC/DC 2x5A mounting measurements 45x45mm 2CO connection plug-in connection round 8-pole | | |
| For models: | ZFC33, ZFC45 | | |
| accessories for | 360104 | | |
|  | GEV No. | 380638 | Ref. No. — |
| | relay socket 8-pole dimensions 51x41x23mm 250V 10A FINDER manuf. no. 90.26 | | |



1

| | | | |
|--------------------|---|-----------------|--------|
| GEV No. | 401546 | Ref. No. | 0K2761 |
| description | transformer primary 230V secondary 12V 10VA | | |
| For models: | 5611-3-10, 5612-3-10, 5614-3-10 | | |

PMA



1

| | | | |
|--------------------|--|-----------------|--------|
| GEV No. | 401267 | Ref. No. | 007045 |
| description | transformer primary 230V secondary 12/24V 60/40VA secondary 5/1.7A connection screw 50Hz | | |
| For models: | FCZ102EAA, FCZ201EAA, FCZ202EAA, FCZ201EAH, FCZ102GAG, FCZ102GAD, FCZ102EBA, FCZ201EBA, FCZ202EBA, FCZ201EBH, FCZ102GBG, FCZ102GBD, FCZ102ECA, FCZ201ECA, FCZ202ECA, FCZ201ECH, FCZ102GCG, FCZ102GCD, FCS061GP, FCS061EP, FCS101EP4J, FCS101EP, FCS101GP9J, FCS101GP, FCS102GA9J, FCS201EP, FCS102GP, FCS202EP, FCS201GP, FCS202GP, FCS061EXLN, FCS061EX, FCS101EX4J, FCS101EX, FCS201EX, FCS201EXLN, FCS202EX, FCS101GX9J, FCS101GX, FCS102GX9J, FCS102GX, FCS201GX, FCS202GX, AOW101EA, AOS061EA, AOS061EB, AOS101EA, AOS101EB, AOS201EA, AOS201EB...(Other models you can see in the webshop) | | |



1

| | | | |
|--------------------|---|-----------------|--|
| GEV No. | 379054 | Ref. No. | 004120 004121 081675 083833 0A2497 |
| description | transformer primary 230VAC secondary 12VAC 3VA secondary 0.25A H 40mm L 45mm W 50mm connection screw 50/60Hz type 153/M | | |
| For models: | ALN110, ALN120, ADN111, ADF110, ALF110, ADF120, ALF120, ADNN120, ADNF120, ALN220, ALN240, ADN221, ADF220, ADF240, ADNN220, ADNF220, ADNN230, ADNF230, AKN110UK, AKF110UK, AKN220UK, AKF220UK, ASN110UK, ASF110UK, ASN220UK, ASF220UK, ARDN110, AZP1103, AZF1103, AZP2203, AZF2203, 83012001, 83012033, 83012201, ARDF110L, ARDF120, ARDNN120, 83012101, ARDN220, ARDN221, ARDNF220, 83012037, AZP1103, AZP2203, ASN110, ASF110, ASN220, ASF220, ADN110, ADN120... (Other models you can see in the webshop) | | |

transformers

open transformers

with clamp terminal



1

| | | | |
|--------------------|--|-----------------|--------------------|
| GEV No. | 401266 | Ref. No. | 056512 34432503 |
| description | transformer primary 230V secondary 12/24V 100VA | | |
| For models: | FCVE6-3CE, FCVE103CE, FCVE203CE, FCVE20/P-V, FCVE10-P, FCVE-10PUK, FCVG10-P, FCVG10PUK, FCVE20-P, FCVE20PUK, FCVG20-P, FCVG20PUK, AFCV/G6-1, AFCV/G6-3, SCO/G6-3, AFCV/G101, AFCV/G103, SCO/G10-3, AFCV/G201, AFCV/G203, SCO/G20-3 | | |

encapsulated transformers

multiple connections



1

| | | | |
|--------------------|---|-----------------|--------|
| GEV No. | 401346 | Ref. No. | 0H6808 |
| description | transformer 20VA | | |
| For models: | 5611-3-10, 5611-3-6, 5611-3-8, 5612-3-10, 5612-3-6, 5612-3-8, 5614-3-10, 5614-3-6, 5614-3-8 | | |









| | | | |
|---|---|-----------------|--------|
|  | | | |
| 1 | | | |
| GEV No. | 401174 | Ref. No. | 082378 |
| description | transformer primary 230VAC secondary 12VAC 6VA secondary 0.5A connection screw 50Hz | | |
| For models: | ICF110, ICP130, ITP120UK, ICN110UK, ICF110, ITP120UK, ILP110, ILP110UK, ILN120, ILP111, ILP220, ILP220UK, ILP240, ILP221, ILN110, ILN110UK, ILN120, ILN111, ILN220, ILN220UK, ILN240, ILNSO120, ILN221, ILNN120, ILNN220, ILNN220UK, ILNN230, ILF110, ILF110, ILF120, ILF220, ILF220UK, ILF240, ILNF120, ILNF220, ILNF220UK, ILNF230, TRNP1802, TRRN1301, TRRN1302, TRRN1303, TRRN1801, TRRN1802, TRRN1803, TRRN2201, TRRN2202, TRRN2203, KVRC/E3, HVR/E1200, QVRC/E3...(Other models you can see in the webshop) | | |

electronic controllers

ELIWELL

universal controllers





built-in version

| | | | |
|---|--|-----------------|--|
|  | | | |
| 1 | | | |
| GEV No. | 379605 | Ref. No. | 004109 |
| description | electronic controller ELIWELL type ICPlus915 model ICP22J35000 mounting measurements 71x29mm 12V voltage AC/DC Pt100/TC (J,K) relay outputs 2 NO-8A(4) NO-8A(4) Pt100/TC (J,K) cooking front measurements 78x37mm built-in depth 59mm mode of operation cooking protection IPX0 accuracy 1% built-in version defr. funct. no depend on probe°C display 3½ digits | | |
| accessories for | 379605 | | |
| | GEV No. | Ref. No. | — |
|  | temperature probe Pt100 cable Vetrotex probe -200 up to +600°C cable -50 up to +350°C probe ø6x100mm cable length 2.7m without screw connection 3-wire | | |
|  | GEV No. | Ref. No. | 004120 004121 081675 083833 0A2497 |
| | transformer primary 230VAC secondary 12VAC 3VA secondary 0.25A H 40mm L 45mm W 50mm connection screw 50/60Hz type 153/M | | |
| | GEV No. | Ref. No. | — |
|  | temperature probe Pt100 cable silicone probe -100 up to 450°C cable -50 up to +180°C probe ø6x100mm cable length 1.5m without screw connection 2-wire resistor 0.1kOhm | | |
| | GEV No. | Ref. No. | — |
|  | temperature probe Pt100 cable silicone probe -100 up to 450°C cable -50 up to +180°C probe ø6x100mm cable length 3m without screw connection 2-wire resistor 0.1kOhm | | |
| | GEV No. | Ref. No. | — |
|  | temperature probe Pt100 cable Vetrotex probe -200 up to +600°C cable -50 up to +350°C probe ø6x100mm cable length 1.4m without screw connection 2-wire resistor 0.1kOhm | | |

EVCO - EVERY CONTROL

universal controllers

built-in version

| | | | |
|---|---|-----------------|--------|
|  | | | |
| 1 | | | |
| GEV No. | 378131 | Ref. No. | 053540 |
| description | electronic controller EVERY CONTROL EVK411M mounting measurements 71x29mm 12V voltage AC/DC NTC/PTC/Pt100/Pt1000 relay outputs 1 CO-16A(8) NTC/PTC/Pt100/Pt1000/TC(J,K)/mV/mA yes protection IP65 depend on probe°C display 3½ digits | | |
| accessories for | 378131 | | |
| | GEV No. | Ref. No. | — |
|  | temperature probe Pt100 cable Vetrotex probe -200 up to +600°C cable -50 up to +350°C probe ø6x100mm cable length 2.7m without screw connection 3-wire | | |
| | GEV No. | Ref. No. | — |
|  | temperature probe NTC 10kOhm cable thermoplastic probe -40 up to +110°C cable -40 up to +110°C probe ø6x14mm cable length 1.5m without screw connection 2-wire | | |
| | GEV No. | Ref. No. | — |
|  | temperature probe PTC 1kOhm cable thermoplastic probe -50 up to +150°C cable -40 up to +110°C probe ø6x14mm cable length 1.5m without screw connection 2-wire | | |
| | GEV No. | Ref. No. | — |
|  | temperature probe Pt1000 cable Vetrotex probe -70 up to +500°C cable -50 up to +350°C connection 2-wire thread probe ø6x180mm cable length 1.7m | | |

PIXSYS

universal controllers

built-in version

| | | | |
|--|---|-----------------|--------|
|  | | | |
| 1 | | | |
| GEV No. | 379888 | Ref. No. | 0C3100 |
| description | electronic controller PIXSYS type ATR111-B mounting measurements 71x29mm 230V voltage AC NTC/PTC/Pt100/Pt1000/TC(J,K)/mV/mA relay outputs 2 CO-8A(3) 8VDC/20mA NTC/PTC/Pt100/Pt1000/TC(J,K)/mV/mA front measurements 35x77mm built-in depth 54mm protection IP64 accuracy 1% built-in version defr. funct. depend on probe°C display 3 digits | | |
| For models: | PME430, PME630, PME6L30, PME930, PME435, PME635, PME6L35, PME935, PME830, PME1230, PME12L30, PME1830, PME835, PME1235, PME12L35, PME1835, PDG433, PDG633, PDG933 | | |



SHANGFANG

accessories



| | | | |
|--------------------|---|-----------------|--|
| GEV No. | 379054 | Ref. No. | 004120 004121 081675 083833 0A2497 |
| description | transformer primary 230VAC secondary 12VAC 3VA secondary 0.25A H 40mm L 45mm W 50mm connection screw 50/60Hz type 153/M | | |
| For models: | ALN110, ALN120, ADN111, ADF110, ALF110, ADF120, ALF120, ADNN120, ADNF120, ALN220, ALN240, ADN221, ADF220, ADF240, ADNN220, ADNF220, ADNN230, ADNF230, AKN110UK, AKF110UK, AKN220UK, AKF220UK, ASN110UK, ASF110UK, ASN220UK, ASF220UK, ARDN110, AZP1103, AZF1103, AZP2203, AZF2203, 83012001, 83012033, 83012201, ARDF110L, ARDF120, ARDNN120, 83012101, ARDN220, ARDN221, ARDNF220, 83012037, AZP1103, AZP2203, ASN110, ASF110, ASN220, ASF220, ADN110, ADN120... (Other models you can see in the webshop) | | |

probes

universal probes

temperature probes

| | | | |
|--------------------|---|-----------------|--------|
| GEV No. | 379693 | Ref. No. | 004116 |
| description | temperature probe thermocouple J (Fe-CuNi) cable Vetrotex probe 0 up to +350°C cable°C probe ø6x100mm cable length 1.35m without screw connection cable colours red/blue 2-wire | | |
| For models: | ZCMDG6, ZCMDG4, ZCMDG9, ZCB DG8, ZCB DG12, ZCB DG18, PME430, PME630, PME6L30, PME930, PME435, PME635, PME6L35, PME935, PME830, PME1230, PME12L30, PME1830, PME835, PME1235, PME12L35, PME1835, PDG433, PDG633, PDG933 | | |

producer-specific probes

probes

| | | | |
|--------------------|---|-----------------|----------------------------|
| GEV No. | 379049 | Ref. No. | 0H6478 0H6482 236012 |
| description | temperature probe Pt100 cable PTFE probe -100 up to 450°C cable -40 up to +250°C connection 2-wire thread 1/4" probe ø5x100mm cable length 2m | | |
| For models: | 5611-3-10, 5611-3-8, 5612-3-10, 5612-3-8, 5614-3-10, 5614-3-8 | | |

| | | | |
|--------------------|---|-----------------|------------------|
| GEV No. | 379719 | Ref. No. | 0H2430 0K8027 |
| description | temperature probe Pt100 cable PTFE probe -100 up to 450°C cable -40 up to +250°C connection bullet receptacle ø2mm thread M8x1.25 probe ø3x90mm cable length 1m | | |
| For models: | AR6ES, AR6ES, AR6ES, AR6ES, AR6ES, AR6ES, AR6ES, AR6ES, AR6ES, AR6ES, AR6ES, AR6ES, AR6ES, AR6ES, AR6ES, AR6E, AR6E, AR6E, AR6E, AR6EP, AR6EP, AR6EP | | |

| | | | |
|--------------------|--|-----------------|--------|
| GEV No. | 379090 | Ref. No. | 0H6491 |
| description | temperature probe Pt100 cable PTFE probe -70 up to +500°C cable -40 up to +250°C connection 2-wire thread probe ø3x100mm cable length 1.9m | | |

| | | | |
|--------------------|---|-----------------|------------------|
| GEV No. | 379144 | Ref. No. | 0H6481 236011 |
| description | temperature probe Pt100 cable silicone probe -100 up to 450°C cable -50 up to +180°C connection 2-wire thread probe ø3/3.5x40/180mm cable length 1.9m | | |
| For models: | 5611-3-10, 5611-3-8, 5612-3-10, 5612-3-8, 5614-3-10, 5614-3-8 | | |

| | | | |
|--------------------|--|-----------------|------------------|
| GEV No. | 379107 | Ref. No. | 056675 058669 |
| description | temperature probe Pt100 probe -100 up to 450°C cable -40 up to +250°C connection 2-wire thread probe ø5x50mm cable length 1.4m | | |
| For models: | FCVE6-3CE, FCVE103CE, FCVE203CE, FCVE20/P-V, FCVE10-P, FCVE-10PUK, FCVG10-P, FCVG10PUK, FCVE20-P, FCVE20PUK, FCVG20-P, FCVG20PUK, AFCV/G6-1, AFCV/G6-3, SCO/G6-3, AFCV/G101, AFCV/G103, SCO/G10-3, AFCV/G201, AFCV/G203, SCO/G20-3 | | |

| | | | |
|--------------------|--|-----------------|--|
| GEV No. | 379100 | Ref. No. | 002615 0C5342 0F0087 0K0676 0K0681 0K3624 0K9704 0KE606 0KE749 0T4243 215727 |
| description | temperature probe Pt1000 cable silicone probe -70 up to +500°C cable -50 up to +180°C connection male faston 4.8mm thread probe ø4x235mm cable length 1.8m | | |
| For models: | FCV/G10L3, FCV/G6L3TOWNGAS, FCV/G6L3, FCVG10L3T, FCVG10L3L, FCV/E101/1, FCV/G20L3, FCVG20L3, FCVE6L3J, FCV/E10L3JAP, FCV/E102/1L3JAP, FCV/E10L6JAP, FCV/E102/1L6JAP, FCV/G6L-3JAP, FCVG10L3J, FCVG102L3J, FCV/G10L6JAP, FCV/G102/1L6JAP, FCVG6L3CJ, FCV/E61/1, FCV/G10L2, FCV/E61/1, FCV/E101/1, FCV/E101/1, FCV/E10L2, FCV/E102/1, FCV/E61/1, FCV/E61/1, FCV/E101/1, FCV/E101/2, FCV/G6L3C, FCV/G61/1, FCV/G61/1, FCV/G61/1, FCV/G61/1, FCV/G6L3CT, FCV/G6L3CJ, FCV/E10L3, FCV/E102/1, FCV/E6L3, FCV/E102/1L3, FCV/E20L3, FCVE20L3, FCV/G6L4, FCV/E6L4, FCV/E101/1, FCV/G10L6, FCV/E10L6, FCV/G102/1L6, FCV/E102/1L6... (Other models you can see in the webshop) | | |

| | | | |
|------------------------|---|-----------------|--------------------------------------|
| accessories for | 379100 | GEV No. | 002624 0C3641 0F0165 237382 |
| | | Ref. No. | |
| description | gasket PTFE ED ø 20mm ID ø 15mm thickness 1mm Qty 1 pcs | | |
| GEV No. | 697993 | Ref. No. | 002701 0F0158 |
| description | sleeve for temperature probe ø 11mm ID ø 4.3mm H 22.4mm | | |





| | | | |
|---|--|-----------------|--------|
|  | | | |
| 1 | | | |
| GEV No. | 379973 | Ref. No. | 003439 |
| description | temperature probe thermocouple cable ceramic probe -50 up to +750°C cable -100 up to +1300°C connection grip connection thread probe ø10x100mm cable lengthm | | |
| For models: | ZMMDE4, ZMMDE6, FPS/18, FPS/30 | | |

| | | | |
|---|--|-----------------|------------------|
|  | | | |
| 1 | | | |
| GEV No. | 379717 | Ref. No. | 0C0326 0C6539 |
| description | temperature probe thermocouple K (NiCr-Ni) cable PTFE probe -50 up to 1150°C cable -40 up to +250°C connection plug thread probe ø4x70mm cable length 1.1m | | |
| For models: | FCZ061EAA, FCZ102EAA, FCZ201EAA, FCZ202EAA, FCZ061EAH, FCZ201EAH, FCZ061EAN, FCZ201EAN, FCZ101GAG, FCZ102GAG, FCZ201GAG, FCZ202GAG, FCZ101GAD, FCZ102GAD, FCZ201GAD, FCZ202GAD, FCZ061EBA, FCZ102EBA, FCZ201EBA, FCZ202EBA, FCZ061EBH, FCZ201EBH, FCZ201EBN, FCZ101GBG, FCZ102GBG, FCZ201GBG, FCZ202GBG, FCZ101GBD, FCZ102GBD, FCZ201GBD, FCZ202GBD, FCZ061ECA, FCZ102ECA, FCZ201ECA, FCZ202ECA, FCZ061ECH, FCZ201ECH, FCZ061ECN, FCZ201ECN, FCZ101GCG, FCZ102GCG, FCZ201GCG, FCZ202GCG, FCZ101GCD, FCZ102GCD, FCZ201GCD, FCZ202GCD, AOS101GA, AOS101GB, AOS061EAAQ... (Other models you can see in the webshop) | | |

| | | | |
|---|--|-----------------|------------------|
|  | | | |
| 1 | | | |
| GEV No. | 379715 | Ref. No. | 0C0324 0C6538 |
| description | temperature probe thermocouple K (NiCr-Ni) cable PVC probe -50 up to 1150°C cable -10 up to 100°C connection plug thread probe ø4x70mm cable length 0.5m | | |
| For models: | FCZ061EAA, FCZ102EAA, FCZ201EAA, FCZ202EAA, FCZ061EAH, FCZ201EAH, FCZ061EAN, FCZ201EAN, FCZ101GAG, FCZ102GAG, FCZ201GAG, FCZ202GAG, FCZ101GAD, FCZ102GAD, FCZ201GAD, FCZ202GAD, FCZ061EBA, FCZ102EBA, FCZ201EBA, FCZ202EBA, FCZ061EBH, FCZ201EBH, FCZ201EBN, FCZ101GBG, FCZ102GBG, FCZ201GBG, FCZ202GBG, FCZ101GBD, FCZ102GBD, FCZ201GBD, FCZ202GBD, FCZ061ECA, FCZ102ECA, FCZ201ECA, FCZ202ECA, FCZ061ECH, FCZ201ECH, FCZ061ECN, FCZ201ECN, FCZ101GCG, FCZ102GCG, FCZ201GCG, FCZ202GCG, FCZ101GCD, FCZ102GCD, FCZ201GCD, FCZ202GCD, AOS101GA, AOS101GB, AOS061EAAQ... (Other models you can see in the webshop) | | |

| | | | |
|---|---|-----------------|--------|
|  | | | |
| 1 | | | |
| GEV No. | 379716 | Ref. No. | 0C0325 |
| description | temperature probe thermocouple K (NiCr-Ni) cable PVC probe -50 up to 1150°C cable -10 up to 100°C connection plug thread probe ø4x70mm cable length 0.85m | | |
| For models: | FCZ061EAA, FCZ102EAA, FCZ201EAA, FCZ202EAA, FCZ061EAH, FCZ201EAH, FCZ061EAN, FCZ201EAN, FCZ201GAG, FCZ202GAG, FCZ201GAD, FCZ202GAD, FCZ061EBA, FCZ102EBA, FCZ201EBA, FCZ202EBA, FCZ061EBH, FCZ201EBH, FCZ201EBN, FCZ201GBG, FCZ202GBG, FCZ201GBD, FCZ202GBD, FCZ061ECA, FCZ102ECA, FCZ201ECA, FCZ202ECA, FCZ061ECH, FCZ201ECH, FCZ061ECN, FCZ201ECN, FCZ101GCG, FCZ201GCG, FCZ202GCG, FCZ201GCD, FCZ202GCD, AOS101GB, AOS061EAAQ, AOS061EBAQ, AOS102EAAQ, AOS102EBAQ, AOS202EAAQ, AOS202EBAQ, AOS061EANQ, AOS061EBNQ, AOS102EANQ, AOS102EBNQ, AOS202EANQ, AOS202EBNQ, AOS061EACQ, AOS061EBCQ... (Other models you can see in the webshop) | | |

| | | | |
|--|--|-----------------|--------|
|  | | | |
| 1 | | | |
| GEV No. | 379889 | Ref. No. | 0C3457 |
| description | temperature probe thermocouple K (NiCr-Ni) cable PVC probe -50 up to 1150°C cable -10 up to 100°C connection plug thread probe ø4x70mm cable length 2m | | |
| For models: | FCS201G4 | | |

| | | | |
|--|---|-----------------|------------------|
|  | | | |
| 1 | | | |
| GEV No. | 379713 | Ref. No. | 004209 0C3567 |
| description | temperature probe thermocouple K (NiCr-Ni) cable Vetrotex probe -50 up to 1150°C cable -50 up to +350°C connection 2-wire thread probe ø3x200mm cable length 1.5m | | |
| For models: | MAX18/35X, ZCMDE6, ZCBDE12, ZCMDE4, ZCBDE8, ZCMDE9, ZCBDE18, FFPS16, FFPS32, PDE830, PDE1230, PDE12L30, PDE1830, PDE835, PDE1235, PDE12L35, PDE1835 | | |

core probes

| | | | |
|---|--|-----------------|------------------|
|  | | | |
| 1 | | | |
| GEV No. | 378412 ¹ | Ref. No. | 0C3964 0C6616 |
| description | core temperature probe multipoint probe cable SS corrugated hose probe -40 up to +250°C cable -40 up to +250°C connection plug probe ø3.5x100mm thread cable length 1.74m handle ø 10mm handle length 85mm | | |
| For models: | AOW101EA, AOW101EABU | | |

¹multipoint probe

| | | | |
|--|--|-----------------|--------|
|  | | | |
| 1 | | | |
| GEV No. | 379724 | Ref. No. | 0C1522 |
| description | core temperature probe multipoint probe cable SS corrugated hose probe -40 up to +250°C cable -40 up to +250°C connection plug probe ø3.5x95mm thread cable length 1.6m handle ø 10mm handle length 58mm | | |
| For models: | FCS101EP4J, FCS101EP, FCS101GP9J, FCS101GP, FCS102GA9J, FCS102GP, FCS101EX4J, FCS101EX, FCS101GX9J, FCS101GX, FCS102GX9J, FCS102GX | | |

| | | | |
|--------------------|--|-----------------|------------------|
| GEV No. | 401549 | Ref. No. | 0H6131 0H6496 |
| description | core temperature probe Pt100 cable PTFE probe -100 up to +450°C cable -40 up to +250°C connection 2-wire probe ø4.5x80mm thread cable length 1.8m handle ø8mm handle length 70mm | | |
| For models: | 5611-3-10, 5611-3-8 | | |



| | | | |
|--------------------|---|-----------------|--|
| GEV No. | 379721 | Ref. No. | 0E3423 0H2363 0H2364 0K7782 0K7784 0K7785 0K8594 |
| description | core temperature probe Pt100 cable SS corrugated hose probe -40 up to +250°C cable -40 up to +250°C connection bullet receptacle ø2mm probe ø4x100mm thread M16x1 cable length 3.9m handle ø10mm handle length 45mm | | |
| For models: | D820, D820, D820, D820, AR170S, AR170S, AR170S, AR170S, AR170S, AR170S, AR170S, AR170S, AR170S, AR340S, AR340S, AR340S, AR340S, AR340S, AR340S, AR340S, AR340S, AR340S, AR340S, AR10ES, AR10ES, AR10ES, AR10ES, AR10ES, AR10ES, AR10ES, AR10ES, AR10ESP, AR10ESP, AR10ESP, AR10ESP, AR10ESP, AR10ESP, AR10ESP, AR10ESP, AR10ES, AR10ES, AR10ES, AR10ES, AR10ESP, AR10ESP..(Other models you can see in the webshop) | | |



| | | | |
|--------------------|---|-----------------|---|
| GEV No. | 379091 | Ref. No. | 0H6492 0H6492+0H6777 0H6497 0T3795 |
| description | core temperature probe Pt100 cable PTFE probe -40 up to +250°C cable -40 up to +250°C connection 2-wire probe ø4.5x80mm thread cable length 1.3m handle ø8mm handle length 70mm | | |
| For models: | 5612-3-10, 5612-3-8 | | |



| | | | |
|--------------------|---|-----------------|------------------|
| GEV No. | 379095 | Ref. No. | 055472 0K2962 |
| description | core temperature probe Pt100 cable SS corrugated hose probe -40 up to +250°C cable -40 up to +250°C connection coded plug probe ø4x100mm thread M12 cable length 1.45m handle ø9mm handle length 85mm | | |
| For models: | FCVE6-3CE, FCVE203CE, FCVE20-P, FCVE20PUK, FCVG20-P, FCVG-20PUK, ZOFCV/G6-3, AFCV/G6-1, AFCV/G6-3, AFCV/G103, AFCV/G203 | | |



| | | | |
|--------------------|---|-----------------|----------------------------|
| GEV No. | 379096 | Ref. No. | 0H6493 0H6498 236147 |
| description | core temperature probe Pt100 cable PTFE probe -40 up to +250°C cable -40 up to +250°C connection 2-wire probe ø4.5x80mm thread cable length 1.5m handle ø8mm handle length 70mm | | |
| For models: | 5614-3-10, 5614-3-8 | | |



| | | | |
|--------------------|--|-----------------|------------------|
| GEV No. | 379978 | Ref. No. | 0H6490 0H6494 |
| description | core temperature probe Pt100 cable SS/plastic probe -40 up to +250°C cable -40 up to +250°C connection 2-wire probe ø5x100mm thread cable length 1.6m handle ø9mm handle length 45mm | | |





| | | | |
|--------------------|--|-----------------|--------|
| GEV No. | 379037 | Ref. No. | 059002 |
| description | core temperature probe Pt100 cable SS corrugated hose probe -40 up to +250°C cable -40 up to +250°C connection 2-wire probe ø4x100mm thread M12 cable length 2.2m handle ø9mm handle length 90mm | | |
| For models: | FCVE103CE, FCVE10-P, FCVE10PUK, FCVG10-P, FCVG10PUK, AFCV/G103 | | |





| | | | |
|--------------------|--|-----------------|------------------|
| GEV No. | 379961 | Ref. No. | 002330 058199 |
| description | core temperature probe Pt100 cable SS corrugated hose probe -40 up to +250°C cable -40 up to +250°C connection 2-wire probe ø4x100mm thread M12 cable length 2.8m handle ø9mm handle length 80mm | | |
| For models: | FCVE20/P-V, FCVE20-V, FCVE20VUK, FCV/E20-V | | |





| | | | |
|---|---|-----------------|--|
|  | | | |
| GEV No. | 379061 | Ref. No. | 003094 003853 0F0085 0H6499 0K9184 |
| description | core temperature probe Pt1000 cable SS corrugated hose probe -40 up to +250°C cable -40 up to +250°C connection 2-wire probe ø4x100mm thread M8 cable length 2.5m handle ø 10mm handle length 45mm | | |
| For models: | FCV/G20L3, FCVG202L3, FCV/E20L3, FCVE202L3, FCV/G20L6, FCV/E20L6, FCVG202L6, FCVE202L6, FCFG201-0, FCFG202-0, FCFE201-0, FCFE202-0, FCF201ENS, CS20ME4/200-3, CS20ME4/230-3, CS20ME6/230-3, CS20ME4/400-3N, CS20ME6/400-3N, CS20ME4/400-3NE, CS20ME4/400-3, CS20ME4/440-3, CS20MT4/400-3N, CS20MT6/400-3N, CS20GE4/200-3, CS20GE4/230-3, CS20GE6/230-3, CS20GE4/400-3N, CS20GE6/400-3N, CS20GE4/400-3NE, CS20GE4/400-3, CS20GE4/440-3, CS20GT4/400-3N, CS20GT6/400-3N, CS20LCE4/200-3, CS20LCE4/230-3, CS20LCE6/230-3, CS20LCE4/400-3N, CS20LCE6/400-3N, CS20LCE4/400-3N, CS20LCE4/440-3, CS20LCT4/400-3N, CS20LCT6/400-3N, C204200-3, C20230-3, C204400-3N, C206400-3N, C20T4/400-, C20P4200-3, C20P4230-3...(Other models you can see in the webshop) | | |

| | | | |
|--|--|-----------------|--------|
|  | | | |
| GEV No. | 379407 | Ref. No. | 0K8488 |
| description | core temperature probe Pt1000 cable SS corrugated hose probe -40 up to +250°C cable -40 up to +250°C connection 2-wire probe ø4x100mm thread M8 cable length 2.7m handle ø 10mm handle length 45mm | | |

| | | | |
|---|--|-----------------|------------------------------------|
|  | | | |
| GEV No. | 379060 | Ref. No. | 002673 0F0084 0K8487 L675 |
| description | core temperature probe Pt1000 cable SS corrugated hose probe -40 up to +250°C cable -40 up to +250°C connection 2-wire probe ø4x100mm thread M8 cable length 2m handle ø 10mm handle length 45mm | | |
| For models: | FCV/G10L3, FCV/G6L3TOWNGAS, FCV/G6L3, FCVG10L3T, FCVE6L3J, FCV/E10L3JAP, FCV/E10L6JAP, FCV/G6L3JAP, FCVG10L3J, FCV/G10L6JAP, FCVG6L3CJ, FCV/E61/1, FCV/E61/1, FCV/E61/1, FCV/E61/1, FCV/E101/1, FCV/E101/2, FCV/G6L3C, FCV/G61/1, FCV/G61/1, FCV/G61/1, FCV/G61/1, FCV/G6L3CT, FCVG6L3CJ, FCV/E10L3, FCV/E6L3, FCV/G6L4, FCV/E6L4, FCV/G10L6, FCV/E10L6, FCF/G6-0, FCFG101/0, FCFG102-0, FCF/E6-0, FCFE101-0, FCFE102-0, FCF061ELN, FCF101ELN, FCF6EHOR, FCFG10160H, FCF061ENS, FCF101ENS, FCF102ENS, FCFG102-0T, FCF/G6-1-JAP, FCF/G101/1-1-JAP, FCFE6-1J, FCFE101-1J, FCFE102-1J, FCF/G101/1...(Other models you can see in the webshop) | | |

| | | | |
|--|---|-----------------|--------|
|  | | | |
| GEV No. | 379406 | Ref. No. | 006192 |
| description | core temperature probe Pt1000 cable SS corrugated hose probe -40 up to +250°C cable -40 up to +250°C connection 2-wire probe ø4x100mm thread M8 cable length 2m handle ø 10mm handle length 50mm | | |
| For models: | FCV/G10L3, FCVG10L3T, FCV/E101/1, FCVG10L3J, FCV/E101/1, FCV/E101/1, FCV/E101/1, FCFE101-0, FCFE102-0, FCF101ELN, FCF101ENS, FCF102ENS, FCFE101-1J, FCFE102-1J, FCS101E44J, FCS101E4, FCS101G4, FCS101G4DT, FCS102E44J, FCS101G49J, FCS102E4, FCS102G4, FCS102G49J, 5712-2-7, 5712-2-8, 5712-2-10, 5712-2-7L, 5712-2-8L, 5712-2-10L, 5712-3-7, 5712-3-8, 5712-3-8E, 5712-3-10, ECFE101-0, ECFE102-0, ECF101ENS, ECF102ENS, ECV/G10T4, ECV/E10T4, ECV/G10T4J, ACFE101-0, ACFE102-0, RCV101G4, RCV101E4, RCF101E, ACV/G10C4, ACV/E10C4, NCV/G10L4, ZCV/G10T4, ZCV/E10T4 | | |

| | | | |
|---|--|-----------------|--------|
|  | | | |
| GEV No. | 379976 | Ref. No. | 002821 |
| description | core temperature probe Pt1000 cable SS corrugated hose probe -40 up to +250°C cable -40 up to +250°C connection male faston 6.3mm probe ø4x100mm thread M8 cable length 3.1m handle ø 9mm handle length 50/55mm | | |
| For models: | FCVG102L3, FCV/E102/1L3JAP, FCV/E102/1L6JAP, FCVG102L3J, FCV/G102/1L6JAP, FCV/E102/1, FCV/E102/1, FCV/E102/1L3, FCV/G102/1L6, FCV/E102/1L6, FCFG101/0, FCFG102-0, FCFE102-0, FCFG102-0T, FCF/G102/1-1-JAP, FCFE102-1J, FCS101G4, FCS101G4DT, FCS101G49J, FCS102G4, FCS102G49J, ECFG101-0, ECFG102-0, ECFE102-0, ECVG102T4, ECVE102T4, ECV/G102/1T6, ECV/E102/1T6, ACFG101-0, ACFG102-0, ACFE102-0, JCF/G102/1-2, JCF/E102/1-2, RCF101G, ACVG102C4, ACVE102C4, ACV/G102/1C6, ACV/E102/1C6, NCF/G101/1, NCF/G102/1, NCF/E102/1, NCV/G102/1, ZCV/G102/1, ZCV/E102/1, ZCV/G102/1T6, ZCV/E102/1T6, ZCF/G101/1, ZCF/G102/1, ZCF/E102/1 | | |

| | | | |
|--|---|-----------------|--------|
|  | | | |
| GEV No. | 379977 | Ref. No. | 006174 |
| description | core temperature probe Pt1000 cable SS corrugated hose probe -40 up to +250°C cable -40 up to +250°C connection male faston probe ø4x100mm thread cable length 2.6m handle ø 10mm handle length 50mm | | |
| For models: | FCV/G20L3, FCVG202L3, FCV/G20L6, FCVG202L6, FCS201E4, FCS202E4, FCS201G4, FCS202G4, 5714-2-7, 5714-2-8, 5714-2-10, 5714-2-7L, 5714-2-8L, 5714-2-10L, 5714-2-7L, 5714-2-8L, 5714-2-10L, 5714-3-7, 5714-3-8, 5714-3-8E, 5714-3-10, 5717-3-7, 5717-3-8, 5717-3-8E, 5717-3-10, 5717-3-8M, 5717-3-8M, ECV/G20T4, ECVG202T4, ECV/G20T4J, ECV/G20T6, ECVG202T6, ACV/G20C4, ACVG202C4, ACV/G20C6, ACVG202C6, ZCV/G20T4, ZCV/G202/1, ZCV/G20T6, ZCV/G202/1 | | |



| | | | |
|--------------------|---|-----------------|--------|
| GEV No. | 379964 | Ref. No. | 006525 |
| description | core temperature probe Pt1000 cable SS corrugated hose probe -40 up to +250°C cable -40 up to +250°C connection male faston probe ø5.5x110mm thread cable length 2.5m handle ø 10mm handle length 100mm | | |
| For models: | FCV/G101/1, FVC/E101/1 | | |



| | | | |
|--------------------|---|-----------------|--------|
| GEV No. | 379965 | Ref. No. | 006526 |
| description | core temperature probe Pt1000 cable SS corrugated hose probe -40 up to +250°C cable -40 up to +250°C connection male faston probe ø5x100mm thread cable length 2.6m handle ø 10mm handle length 100mm | | |
| For models: | FCV/G201/1, FVC/E201/1, FCV/G202/1, FVC/E202/1 | | |



| | | | |
|--------------------|--|-----------------|--------|
| GEV No. | 379954 | Ref. No. | 006527 |
| description | core temperature probe Pt1000 cable SS corrugated hose probe -40 up to +250°C cable -40 up to +250°C connection plug probe ø5x100mm thread M8 cable length 3.2m handle ø 9mm handle length 50/50mm | | |
| For models: | FCV/G102/1, FVC/E102/1 | | |

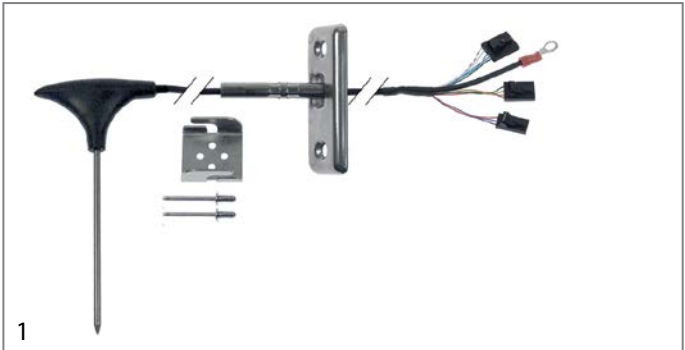

| | | | |
|--------------------|--|-----------------|------------------|
| GEV No. | 381473 | Ref. No. | 0C6574 0CB236 |
| description | core temperature probe TC (K) cable PTFE cable length 800/1700m | | |
| For models: | FCZ201ETA, FCZ202ETA, FCZ201ETH, FCZ201ETN, FCZ201EBA2, FCZ202EBA2, FCZ201EBH2, FCZ201EBN2, FCZ201EBC2, FCZ201ECA2, FCZ202ECA2, FCZ201ECH2, FCZ201ECN2, AOS201ETA1, AOS202ETA1, AOS201ETH1, AOS201ETN1, AOS201ETC1, AOS201ETE1, AOS201ETF1, AOS201ETM1, AOS202ETM1, AOS201ETK1, AOS202ETK1, AOS201EBA2, AOS202EBA2, AOS201EBH2, AOS201EBN2, AOS201EBC2, AOS201EBE2, AOS201EBF2, AOS201EBK2, AOS202EBK2, AOS201ECA2, AOS202ECA2, AOS201ECH2, AOS201ECN2 | | |

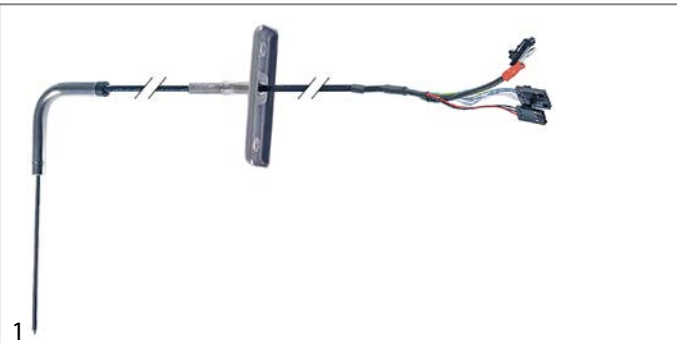

| | | | |
|--------------------|---|-----------------|--------|
| GEV No. | 379718 ¹ | Ref. No. | 0C4240 |
| description | core temperature probe thermocouple K (NiCr-Ni) cable PTFE probe -40 up to +250°C cable -40 up to +250°C connection plug probe ø3.5x100mm thread cable length 2.2m handle ø 9mm handle length 45/50mm | | |

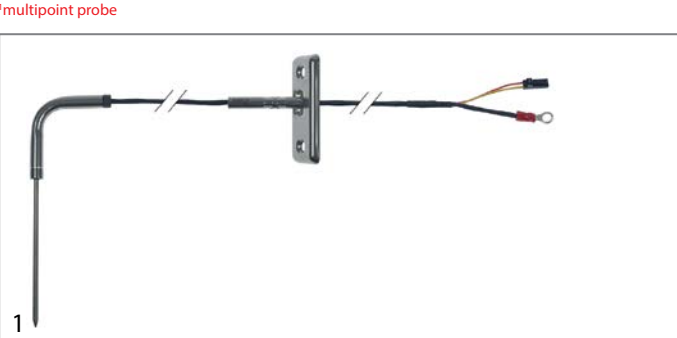

| | | | |
|--------------------|---|-----------------|--------|
| GEV No. | 381460 | Ref. No. | 0C4241 |
| description | core temperature probe thermocouple K (NiCr-Ni) cable PTFE probe -40 up to +250°C cable -40 up to +250°C connection plug probe ø3.5x100mm thread cable length 2.2m handle ø 9mm handle length 45/50mm | | |
| For models: | FCZ061EAA, FCZ101EAA, FCZ102EAA, FCZ061EAH, FCZ101EAH, FCZ061EAN, FCZ101EAN, FCZ061ETA, FCZ101ETA, FCZ102ETA, FCZ061ETH, FCZ101ETH, FCZ061ETN, FCZ101ETN, FCZ101GTG, FCZ102GTG, FCZ101GTD, FCZ102GTD, FCZ061EBA, FCZ101EBA, FCZ102EBA, FCZ061EBH, FCZ101EBH, FCZ061EBN, FCZ101EBN, FCZ061EBC, FCZ101EBC, FCZ061EBA2, FCZ101EBA2, FCZ102EBA2, FCZ061EBH2, FCZ101EBH2, FCZ061EBN2, FCZ101EBN2, FCZ061EBC2, FCZ101EBC2, FCZ061GBG, FCZ101GBG, FCZ102GBG, FCZ061GBD, FCZ101GBD, FCZ102GBD, FCZ101GBI, FCZ101GBG2, FCZ102GBG2, FCZ101GBD2, FCZ102GBD2, FCZ101GBI2, FCZ102GBI2, FCZ061ECA...(Other models you can see in the webshop) | | |

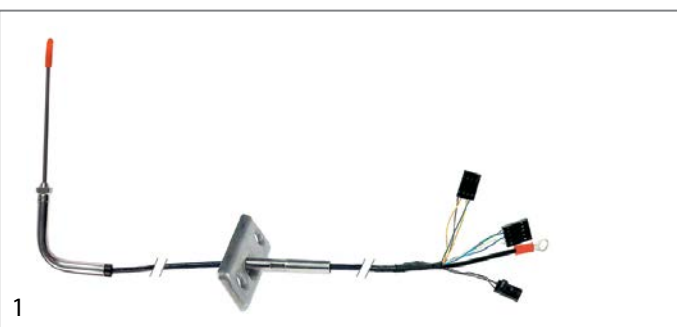

| | | | |
|--------------------|---|-----------------|--------|
| GEV No. | 379956 | Ref. No. | 006982 |
| description | core temperature probe thermocouple K (NiCr-Ni) cable PTFE probe -40 up to +250°C cable -40 up to +250°C connection plug probe ø3.5x100mm thread cable length 2.5m handle ø 9mm handle length 45/50mm | | |
| For models: | AOS061EA, AOS061EA3J, AOS061EA2N, AOS061EA0H, AOS061GA, AOS101GA | | |

¹multipoint probe



| | | | |
|--------------------|---|-----------------|--------|
| GEV No. | 379958 | Ref. No. | 006983 |
| description | core temperature probe thermocouple K (NiCr-Ni) cable PTFE probe -40 up to +250°C cable -40 up to +250°C connection plug probe ø3.5x100mm thread cable length 2.5m handle ø 9mm handle length 45/50mm | | |
| For models: | AOS061EB, AOS061EB3J, AOS061EB2N, AOS061EB5M, AOS061EB6M, AOS061EB0H | | |

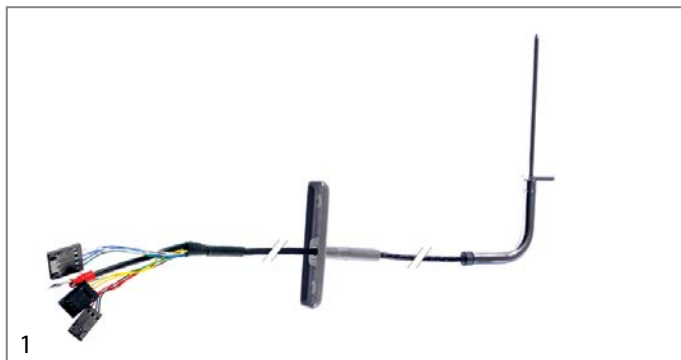

| | | | |
|--------------------|---|-----------------|--------|
| GEV No. | 379969 | Ref. No. | 0C1164 |
| description | core temperature probe thermocouple K (NiCr-Ni) cable PTFE probe -40 up to +250°C cable -40 up to +250°C connection plug probe ø3.5x100mm thread cable length 2.5m handle ø 9mm handle length 45/50mm | | |
| For models: | AOS061GAEU, AOS061GAAU, AOS061EABU, AOS061EAFU, AOS061EA, AOS061EA3J, AOS061EA2N, AOS061EA0H, AOS061GA | | |

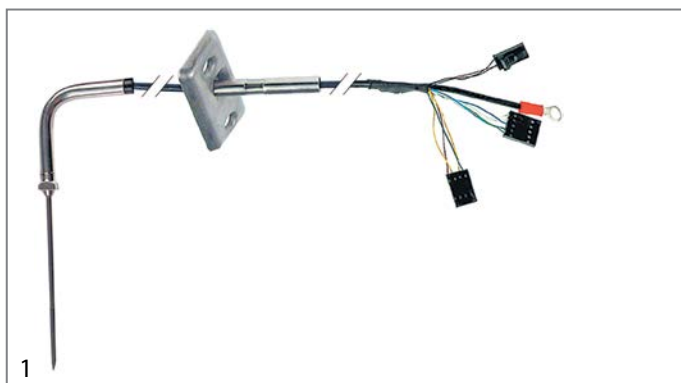

| | | | |
|--------------------|---|-----------------|--------|
| GEV No. | 379955 | Ref. No. | 007109 |
| description | core temperature probe thermocouple K (NiCr-Ni) cable PTFE probe -40 up to +250°C cable -40 up to +250°C connection plug probe ø3.5x100mm thread cable length 2.6m handle ø 9mm handle length 45/50mm | | |
| For models: | AOS101EA, AOS101EA3J, AOS101EA2N, AOS101EA0H | | |



| | | | |
|--------------------|---|-----------------|------------------|
| GEV No. | 379957 | Ref. No. | 007063 0C0224 |
| description | core temperature probe thermocouple K (NiCr-Ni) cable PTFE probe -40 up to +250°C cable -40 up to +250°C connection plug probe ø3.5x100mm thread cable length 2.6m handle ø 9mm handle length 45/50mm | | |
| For models: | AOS101EB, AOS101EB3J, AOS101EB2N, AOS101EB5M, AOS101EB6M, AOS101EB0H | | |

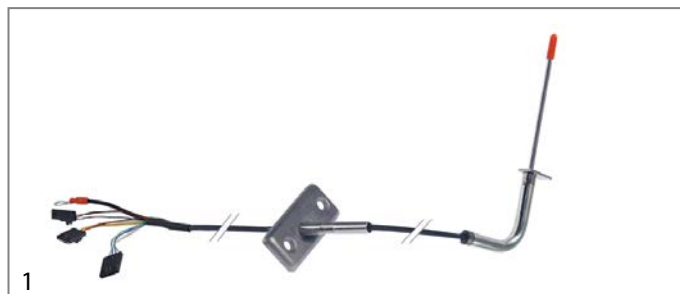

| | | | |
|--------------------|---|-----------------|--------|
| GEV No. | 379960 | Ref. No. | 0C0956 |
| description | core temperature probe thermocouple K (NiCr-Ni) cable PTFE probe -40 up to +250°C cable -40 up to +250°C connection plug probe ø3.5x100mm thread cable length 2.6m handle ø 9mm handle length 45/50mm | | |
| For models: | AOS101GAEU, AOS101GAAU, AOS101EABU, AOS101EAFU, AOS061EA, AOS101EA, AOS061EA3J, AOS101EA3J, AOS061EA2N, AOS101EA2N, AOS061EA0H, AOS101EA0H, AOS101GA | | |

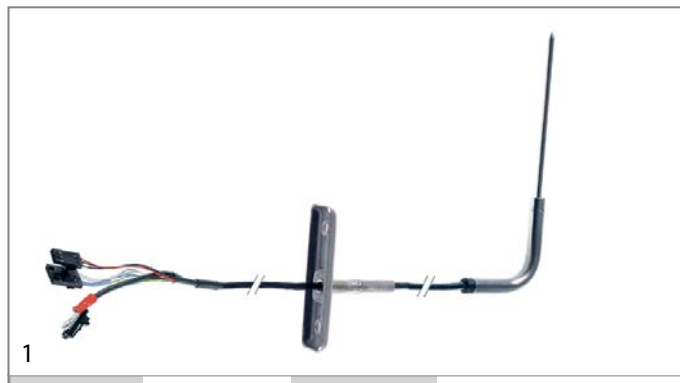

| | | | |
|--------------------|--|-----------------|--------|
| GEV No. | 379723 | Ref. No. | 0C1212 |
| description | core temperature probe thermocouple K (NiCr-Ni) cable PTFE probe -40 up to +250°C cable -40 up to +250°C connection plug probe ø3.5x100mm thread cable length 2.85m handle ø 9mm handle length 50/50mm | | |
| For models: | AOS102GAEU, AOS102GAAU, AOS102EA2N, AOS102EA, AOS102GB | | |

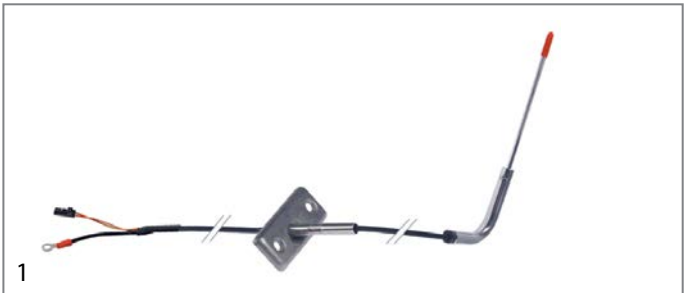

| | | | |
|--------------------|--|-----------------|--------|
| GEV No. | 379959 | Ref. No. | OC1383 |
| description | core temperature probe thermocouple K (NiCr-Ni) cable PTFE probe -40 up to +250°C cable -40 up to +250°C connection plug probe ø3.5x100mm thread cable length 3.2m handle ø 9mm handle length 45/50mm | | |
| For models: | FCZ201GTG, FCZ202GTG, FCZ201GTD, FCZ202GTD, FCZ201EBA, FCZ202EBA, FCZ201EBH, FCZ201EBN, FCZ201EBC, FCZ201GBG, FCZ202GBG, FCZ201GBD, FCZ202GBD, FCZ201GBI, FCZ201GBG2, FCZ202GBG2, FCZ201GBD2, FCZ202GBD2, FCZ201GBI2, FCZ201ECA, FCZ202ECA, FCZ201ECH, FCZ201ECN, FCZ201GCG, FCZ202GCG, FCZ201GCD, FCZ202GCD, FCZ201GCG2, FCZ202GCG2, FCZ201GCD2, FCZ202GCD2, AOS201EB, AOS201EB3J, AOS201EB2N, AOS202EB2N, AOS201EB0H, AOS202EB, AOS202GB, AOS201EBAQ, AOS202EBAQ, AOS201EBNQ, AOS202EBNQ, AOS201EBCQ, AOS201EBHQ, AOS201GBGQ, AOS202GBGQ, AOS201GBDQ, AOS202GBDQ, AOS201EAC1, AOS201EAQ1...(Other models you can see in the webshop) | | |

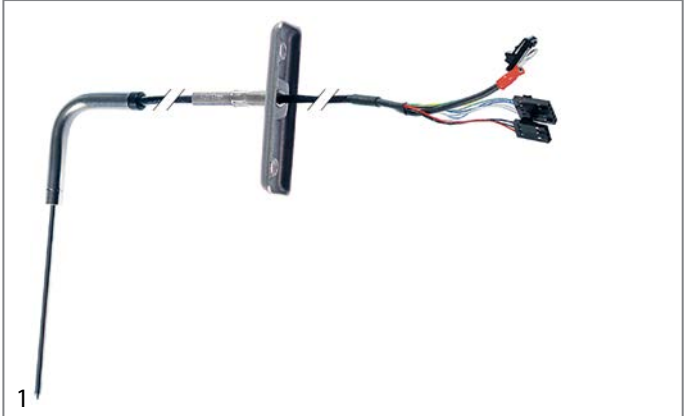

| | | | |
|--------------------|---|-----------------|--------|
| GEV No. | 379970 ¹ | Ref. No. | OC1404 |
| description | core temperature probe thermocouple K (NiCr-Ni) cable PTFE probe -40 up to +250°C cable -40 up to +250°C connection plug probe ø3.5x100mm thread cable length 3.2m handle ø 9mm handle length 45/50mm | | |
| For models: | FCZ201EAA, FCZ202EAA, FCZ201EAH, FCZ201EAN, FCZ201GAG, FCZ202GAG, FCZ201GAD, FCZ202GAD, FCZ201GTG, FCZ202GTG, FCZ201GTD, FCZ202GTD, FCZ201EBC, FCZ201GBG2, FCZ202GBG2, FCZ201GBD2, FCZ202GBD2, FCZ201GBI2, FCZ201GCG2, FCZ202GCG2, FCZ201GCD2, FCZ202GCD2, AOS201GAEU, AOS202GAEU, AOS201GAAU, AOS202GAAU, AOS201EABU, AOS201EAFU, AOS201EA, AOS201EA3J, AOS201EA2N, AOS202EA2N, AOS201EA0H, AOS202EA, AOS202GA, AOS201EAAQ, AOS202EAAQ, AOS201EANQ, AOS202EANQ, AOS201EACQ, AOS201EAHQ, AOS201EBFQ, AOS201GAGQ, AOS202GAGQ, AOS201GADQ, AOS202GADQ, AOS201GAIQ, AOS201GALQ, AOS201EAMQ, AOS201EABQ...(Other models you can see in the webshop) | | |

¹multipoint probe

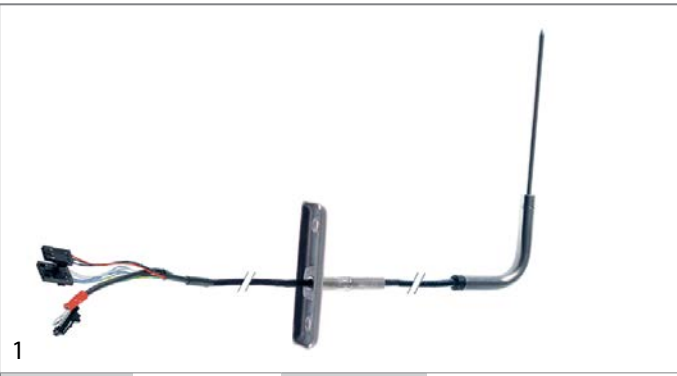

| | | | |
|--------------------|---|-----------------|--------|
| GEV No. | 379725 | Ref. No. | 007093 |
| description | core temperature probe thermocouple K (NiCr-Ni) cable PTFE probe -40 up to +250°C cable -40 up to +250°C connection plug probe ø3.5x100mm thread cable length 3m handle ø 9mm handle length 50/50mm | | |
| For models: | CL511, CL521, AOS201EA, AOS201EA3J, AOS201EA2N, AOS201EA0H | | |





| | | | |
|--------------------|--|-----------------|--------|
| GEV No. | 379967 | Ref. No. | OC0225 |
| description | core temperature probe thermocouple K (NiCr-Ni) cable PTFE probe -40 up to +250°C cable -40 up to +250°C connection plug probe ø3.5x90mm thread cable length 3.1m handle ø 9mm handle length 45/50mm | | |
| For models: | AOS201EB, AOS201EB3J, AOS201EB2N, AOS201EB0H, AOS201GB | | |



| | | | |
|--------------------|---|-----------------|--------|
| GEV No. | 379968 | Ref. No. | OC1146 |
| description | core temperature probe thermocouple K (NiCr-Ni) cable PTFE probe -50 up to +250°C cable -50 up to +250°C connection plug probe ø3.5x100mm thread cable length 3.9m handle ø 9mm handle length 45/50mm | | |
| For models: | AOS201GA | | |



sensors

| | | | | | | | |
|--|--|-----------------|---|----------------|--------|-----------------|---|
|  <p>1</p> | | | | | | | |
| GEV No. | 379966 | Ref. No. | 006995 0C6465 | | | | |
| description | lambda sensor probe ø 12mm 5-pole probe L 50mm | | | | | | |
| For models: | FCZ061EAA, FCZ101EAA, FCZ102EAA, FCZ201EAA, FCZ202EAA, FCZ061EAH, FCZ101EAH, FCZ201EAH, FCZ061EAN, FCZ101EAN, FCZ201EAN, FCZ061ETA, FCZ101ETA, FCZ102ETA, FCZ061ETH, FCZ101ETH, FCZ061ETN, FCZ101ETN, FCZ061GAG, FCZ101GAG, FCZ102GAG, FCZ201GAG, FCZ202GAG, FCZ061GAD, FCZ101GAD, FCZ102GAD, FCZ201GAD, FCZ202GAD, FCZ101GTG, FCZ102GTG, FCZ201GTG, FCZ202GTG, FCZ101GTD, FCZ102GTD, FCZ201GTD, FCZ202GTD, FCZ061EBA, FCZ101EBA, FCZ102EBA, FCZ061EBH, FCZ101EBH, FCZ061EBN, FCZ101EBN, FCZ061EBC, FCZ101EBC, FCZ201EBC, FCZ061EBA2, FCZ101EBA2, FCZ102EBA2, FCZ061EBH2... (Other models you can see in the webshop) | | | | | | |
| accessories for | 379966 | | | | | | |
|  <table border="1"> <tr> <td>GEV No.</td> <td>101251</td> <td>Ref. No.</td> <td>—</td> </tr> </table> <p>union nut thread M20x1.5 for pipe ø 12mm</p> | | | | GEV No. | 101251 | Ref. No. | — |
| GEV No. | 101251 | Ref. No. | — | | | | |
|  <table border="1"> <tr> <td>GEV No.</td> <td>101273</td> <td>Ref. No.</td> <td>027478 050682 058370 0957007 0G2222 0K4315</td> </tr> </table> <p>olive for pipe ø 12mm L 9.5mm brass Qty 1 pcs suitable for universal</p> | | | | GEV No. | 101273 | Ref. No. | 027478 050682 058370 0957007 0G2222 0K4315 |
| GEV No. | 101273 | Ref. No. | 027478 050682 058370 0957007 0G2222 0K4315 | | | | |

accessories

fasteners

| | | | |
|--|---|-----------------|--------------------------------------|
|  <p>1</p> | | | |
| GEV No. | 693748 | Ref. No. | 002674 0K2277 0K9619 0KD468 |
| description | bracket for core temperature probe | | |
| For models: | FDV40G, FDV40E, FDV40GZ, FDV40EL, FDV40GA, FDV20G, FDV20E, FDV20GZ, FDV20EL, FDV20GA, FCV/G10L3, FCV/G6L3TOWNGAS, FCV/G6L3, FCVG10L3T, FCV/G20L3, FCVG20L3, FCVE6L3J, FCV/E10L3JAP, FCV/E10L6JAP, FCV/G6L3JAP, FCVG10L3J, FCV/G10L6JAP, FCVG6L3CJ, FCV/E61/1, FCV/E61/1, FCV/E61/1, FCV/E61/1, FCV/E101/1, FCV/E101/2, FCV/G6L3C, FCV/G61/1, FCV/G61/1, FCV/G61/1, FCV/G61/1, FCVG6L3CT, FCVG6L3CJ, FCV/E10L3, FCV/E6L3, FCV/E20L3, FCVE20L3, FCV/G6L4, FCV/E6L4, FCV/G10L6, FCV/E10L6, FCV/G20L6, FCV/E20L6, FCVG20L6, FCVE20L6, FCF/G6-0, FCFG101/0... (Other models you can see in the webshop) | | |

miscellaneous

| | | | |
|--|---|-----------------|------------------|
|  <p>1</p> | | | |
| GEV No. | 697993 | Ref. No. | 002701 0F0158 |
| description | sleeve for temperature probe ø 11mm ID ø 4.3mm H 22.4mm | | |
| For models: | FCZ101EAA, FCZ102EAA, FCZ101EAH, FCZ101EAN, FCZ101ETA, FCZ102ETA, FCZ202ETA, FCZ101ETH, FCZ101ETN, FCZ101EBA, FCZ102EBA, FCZ101EBH, FCZ101EBN, FCZ101EBC, FCZ101EBA2, FCZ102EBA2, FCZ202EBA2, FCZ101EBH2, FCZ101EBN2, FCZ101EBC2, FCZ101ECA, FCZ102ECA, FCZ101ECH, FCZ101ECN, FCZ101ECA2, FCZ102ECA2, FCZ202ECA2, FCZ101ECH2, FCZ101ECN2, FCV/G10L3, FCV/G6L3TOWNGAS, FCV/G6L3, FCVG10L3T, FCVG102L3, FCV/E101/1, FCV/G20L3, FCVG202L3, FCVE6L3J, FCV/E10L3JAP, FCV/E102/1L3JAP, FCV/E10L6JAP, FCV/E102/1L6JAP, FCV/G6L3JAP, FCVG10L3J, FCVG102L3J, FCV/G10L6JAP, FCVG102/1L6JAP, FCVG6L3CJ, FCV/E61/1, FCV/G10L2... (Other models you can see in the webshop) | | |

electronics

frequency converters

| | | | |
|--|---|-----------------|--|
|  <p>1</p> | | | |
| GEV No. | 403904 | Ref. No. | 0W1UUA 0W5543 0W6668 32106001 |
| description | frequency converter 200-240V 50/60 L 131mm W 72mm H 143mm | | |
| For models: | IC44819E, IC44819G, IC4481901, IC4481902, IC4481903, IC4481904, IC4481905, IC4482101, IC4482102, IC4482103, IC4482104, IC4482105, IC4482501, IC4482502, IC4482503, IC4482504, IC4482505, IC4482801, IC4482802, IC4482803, IC4482804, IC4482805, IC4483201, IC4483202, IC4483203, IC4483204, IC4483205, IC44819LF1, IC44819LF2, IC44819LF3, IC44819LF4, IC44819LF5, IC44821LF1, IC44821LF2, IC44821LF3, IC44821LF4, IC44821LF5, IC44825LF1, IC44825LF2, IC44825LF3, IC44825LF4, IC44825LF5, IC44828LF1, IC44828LF2, IC44828LF3, IC44828LF4, IC44828LF5, IC44832LF1, IC44832LF2, IC44832LF3... (Other models you can see in the webshop) | | |



rectifiers



| | | | |
|--------------------|---|-----------------|-------------------|
| 1 | | | |
| GEV No. | 401257 | Ref. No. | 002715 0960150 |
| description | plug with rectifier | | |
| For models: | FDV40G, FDV40GZ, FDV40GA, FDV20G, FDV20GZ, FDV20GA, BRN70G, BRN/70GZ, BR70GZ, BRNG70A, FCV/G10L6JAP, FCV/G102/1L6JAP, FCV/G6L4, FCV/G10L6, FCV/G102/1L6, FCV/G20L6, FCVG202L6, FCV/G101/1, FCV/G102/1, FCS101GP9J, FCS101GP, FCS102G4, FCS102GA9J, FCS102GP, FCS101GX9J, FCS101GX, FCS102GX9J, FCS102GX, 5711-2-6, 5711-2-7, 5711-2-8, 5711-2-10, 5711-2-8CH, 5711-2-10CH, 5712-2-6, 5712-2-7, 5712-2-8, 5712-2-10, 5714-2-7, 5714-2-8, 5714-2-10, 5714-2-7, 5714-2-8, 5714-2-10, 5711-2-6L, 5711-2-7L, 5711-2-8L, 5711-2-10L, 5712-2-6L, 5712-2-7L...(Other models you can see in the webshop) | | |

PCBs



| | | | |
|--------------------|------------------------------|-----------------|----------------------------|
| 1 | | | |
| GEV No. | 401527 | Ref. No. | 0H6957 0KE675 281061 |
| description | control PCB | | |
| For models: | 5611-3-8, 5612-3-8, 5614-3-8 | | |



| | | | |
|--------------------|----------------------------------|-----------------|----------------------------|
| 1 | | | |
| GEV No. | 401575 | Ref. No. | 0H9793 0K4880 0K4881 |
| description | control PCB | | |
| For models: | VARIOSTEAM/S-33.3/F, STEAM-O-MAT | | |



| | | | |
|--------------------|--|-----------------|----------------------------|
| 1 | | | |
| GEV No. | 400179 | Ref. No. | 002665 0C3758 OK1014 |
| description | control PCB combi-steamer FCV/G 101/1 102/1 | | |
| For models: | FCV/G10L3, FCV/G6L3TOWNGAS, FCV/G6L3, FCVG10L3T, FCVG102L3, FCV/G20L3, FCVG202L3, FCVE6L3J, FCV/E10L3JAP, FCV/E102/1L3JAP, FCV/G6L3JAP, FCVG10L3J, FCVG102L3J, FCVG6L3CJ, FCV/E61/1, FCV/G10L2, FCV/E101/1, FCV/E10L2, FCV/E61/1, FCV/E101/2, FCV/G6L3C, FCV/G61/1, FCVG6L3CT, FCVG6L3CJ, FCV/E10L3, FCV/E102/1, FCV/E6L3, FCV/E102/1L3, FCV/E20L3, FCVE202L3, FCV/E101/1, FCS061G-3DI, FCS061E3CI, FCS101E2, FCS101G2, 5711-2-6, 5711-2-7, 5712-2-6, 5712-2-7, 5714-2-6, 5714-2-7, 5717-2-6, 5714-2-7, 5711-2-6L, 5711-2-7L, 5721-2-7, 5712-2-6L, 5712-2-7L, 5714-2-6L, 5714-2-7L...(Other models you can see in the webshop) | | |



| | | | |
|--------------------|--|-----------------|------------------|
| 1 | | | |
| GEV No. | 400188 | Ref. No. | 002725 OK1015 |
| description | control PCB combi-steamer FCV/G 101/1 102/1 | | |
| For models: | FCV/G61/1, FCV/G61/1, FCV/G6L4, FCV/E6L4, FCV/G101/1, FVC/E101/1, FCV/G102/1, FVC/E102/1, FCV/G201/1, FVC/E201/1, FCV/G202/1, FVC/E202/1, FCS061E44J, FCS061G48J, FCS061G4, FCS061G4DT, FCS101E44J, FCS061G49J, FCS101E4, FCS101G4, FCS101G4DT, FCS102E44J, FCS101G49J, FCS102E4, FCS102G4, FCS201E4, FCS102G49J, FCS202E4, 5711-2-8, 5711-2-8CH, 5712-2-8, 5714-2-8, 5714-2-8, 5711-2-8L, 5712-2-8L, 5714-2-8L, 5714-2-8L, 5711-3-8, 5711-3-8CH, 5712-3-8, 5712-3-8E, 5712-3-8CH, 5714-3-8, 5714-3-8E, 5717-3-8, 5717-3-8E, 5717-3-8M, 5717-3-8C, 5717-3-8M, ECV/G6T4...(Other models you can see in the webshop) | | |



| | | | |
|--------------------|---|-----------------|------------------|
| 1 | | | |
| GEV No. | 403583 | Ref. No. | 0C4891 0C7350 |
| description | control PCB combi-steamer FCZ06/10/20 L 450mm W 155mm display with core temperature probe | | |
| For models: | FCZ061EAA, FCZ101EAA, FCZ102EAA, FCZ061EAH, FCZ101EAH, FCZ061EAN, FCZ101EAN, FCZ061ETA, FCZ101ETA, FCZ102ETA, FCZ201ETA, FCZ202ETA, FCZ061ETH, FCZ101ETH, FCZ201ETH, FCZ061ETN, FCZ101ETN, FCZ201ETN, FCZ101GTG, FCZ102GTG, FCZ201GTG, FCZ202GTG, FCZ101GTD, FCZ102GTD, FCZ201GTD, FCZ202GTD, FCZ061EBA, FCZ101EBA, FCZ102EBA, FCZ061EBH, FCZ101EBH, FCZ061EBN, FCZ101EBN, FCZ061EBC, FCZ101EBC, FCZ061EBA2, FCZ101EBA2, FCZ102EBA2, FCZ201EBA2, FCZ202EBA2, FCZ061EBH2, FCZ101EBH2, FCZ201EBH2, FCZ061EBN2, FCZ101EBN2, FCZ201EBN2, FCZ061EBC2, FCZ101EBC2, FCZ201EBC2, FCZ101GBG2...(Other models you can see in the webshop) | | |





| | | | |
|---|---|-----------------|----------------------------|
|  | | | |
| 1 | | | |
| GEV No. | 400184 | Ref. No. | 002720 0C3765 0K1017 |
| description | control PCB with keypad | | |
| For models: | FCV/E101/1, FCV/E10L6JAP, FCV/E102/1L6JAP, FCV/G10L6JAP, FCV/G102/1L6JAP, FCV/E61/1, FCV/E101/1, FCV/E102/1, FCV/E61/1, FCV/E101/1, FCV/G61/1, FCV/G10L6, FCV/E10L6, FCV/G102/1L6, FCV/E102/1L6, FCV/G20L6, FCV/E20L6, FCV/G202L6, FCV/E202L6, FCV/E101/1, 5711-2-10, 5711-2-10CH, 5712-2-10, 5714-2-10, 5714-2-10L, 5711-2-10L, 5721-2-10, 5712-2-10L, 5714-2-10L, 5714-2-10L, 5711-3-10, 5711-3-10CH, 5712-3-10, 5712-3-10C, 5714-3-10, 5717-3-6, 5717-3-10, 5712-2-10F, 5712-2-10S, 5714-2-10F, 5714-2-10S, 5711-3-10F, 5711-3-10S, 5712-3-10F, 5712-3-10S, 5714-3-10F, 5714-3-10S, ECV/G10T6, ECV/E10T6, ECV/G102/1T6...(Other models you can see in the webshop) | | |

| | | | |
|--|---|-----------------|----------------------------|
|  | | | |
| 1 | | | |
| GEV No. | 361953 | Ref. No. | 0C6571 0C8805 0CA070 |
| description | display L 162mm W 308mm suitable for combi-steamer suitable for ELECTROLUX model FCZ/AOS | | |
| For models: | FCZ061ETA, FCZ101ETA, FCZ102ETA, FCZ201ETA, FCZ202ETA, FCZ061ETH, FCZ101ETH, FCZ201ETH, FCZ061ETN, FCZ101ETN, FCZ201ETN, FCZ101GTG, FCZ102GTG, FCZ201GTG, FCZ202GTG, FCZ101GTD, FCZ102GTD, FCZ201GTD, FCZ202GTD, FCZ061EBA2, FCZ101EBA2, FCZ102EBA2, FCZ201EBA2, FCZ202EBA2, FCZ061EBH2, FCZ101EBH2, FCZ201EBH2, FCZ061EBN2, FCZ101EBN2, FCZ201EBN2, FCZ061EBC2, FCZ101EBC2, FCZ201EBC2, FCZ101GBG2, FCZ102GBG2, FCZ201GBG2, FCZ202GBG2, FCZ101GBD2, FCZ102GBD2, FCZ201GBD2, FCZ202GBD2, FCZ101GBI2, FCZ102GBI2, FCZ201GBI2, FCZ061ECA2, FCZ101ECA2, FCZ102ECA2, FCZ201ECA2, FCZ202ECA2, FCZ061ECH2...(Other models you can see in the webshop) | | |

| | | | |
|---|---------------------------------|-----------------|--------------------------------------|
|  | | | |
| 1 | | | |
| GEV No. | 401531 | Ref. No. | 0H6956 0K2759 0K2760 281056 |
| description | keypad PCB | | |
| For models: | 5611-3-10, 5612-3-10, 5614-3-10 | | |

| | | | |
|--|--|-----------------|----------------------------|
|  | | | |
| 1 | | | |
| GEV No. | 401667 | Ref. No. | 002683 0C3759 0H6292 |
| description | keypad PCB | | |
| For models: | FCV/G10L2, FCV/E10L2, FCS101E2, FCS101G2, 5711-2-6, 5712-2-6, 5714-2-6, 5717-2-6, 5711-2-6L, 5712-2-6L, 5714-2-6L, 5714-2-6L, 5711-3-6, 5712-3-6, 5714-3-6, RCV101G2, RCV101E2, ACV/G10C2, ACV/E10C2, NCV/G6L2, NCV/G10L2, NCV/E6L2, NCV/E10L2 | | |

| | | | |
|--|--|-----------------|---------------------|
|  | | | |
| 1 | | | |
| GEV No. | 400747 | Ref. No. | 0C0043 675837902 |
| description | keypad PCB combi-steamer FCZ06/10/20 | | |
| For models: | FCZ061EAA, FCZ101EAA, FCZ102EAA, FCZ201EAA, FCZ202EAA, FCZ061EAH, FCZ101EAH, FCZ201EAH, FCZ061EAN, FCZ101EAN, FCZ201EAN, FCZ061GAG, FCZ101GAG, FCZ102GAG, FCZ201GAG, FCZ202GAG, FCZ061GAD, FCZ101GAD, FCZ102GAD, FCZ201GAD, FCZ202GAD, FCZ061EBA, FCZ101EBA, FCZ102EBA, FCZ061EBH, FCZ101EBH, FCZ061EBN, FCZ101EBN, FCZ061EBC, FCZ101EBC, FCZ061ECA, FCZ101ECA, FCZ102ECA, FCZ061ECH, FCZ101ECH, FCZ061ECN, FCZ101ECN, AOS061GAEU, AOS101GAEU, AOS102GAEU, AOS201GAEU, AOS202GAEU, AOS061GAU, AOS101GAU, AOS102GAU, AOS201GAU, AOS202GAU, AOS061EABU, AOS101EABU, AOS201EABU...(Other models you can see in the webshop) | | |

| | | | |
|--|--|-----------------|---------------------|
|  | | | |
| 1 | | | |
| GEV No. | 400749 | Ref. No. | 0C0041 675838802 |
| description | keypad PCB combi-steamer FCZ06/10/20 | | |
| For models: | FCZ061EAA, FCZ101EAA, FCZ102EAA, FCZ061EAH, FCZ101EAH, FCZ061EAN, FCZ101EAN, FCZ061ETA, FCZ101ETA, FCZ102ETA, FCZ201ETA, FCZ202ETA, FCZ061ETH, FCZ101ETH, FCZ201ETH, FCZ061ETN, FCZ101ETN, FCZ201ETN, FCZ101GTG, FCZ102GTG, FCZ201GTG, FCZ202GTG, FCZ101GTD, FCZ102GTD, FCZ201GTD, FCZ202GTD, FCZ061EBA, FCZ101EBA, FCZ102EBA, FCZ201EBA, FCZ202EBA, FCZ061EBH, FCZ101EBH, FCZ201EBH, FCZ061EBN, FCZ101EBN, FCZ201EBN, FCZ061EBC, FCZ101EBC, FCZ201EBC, FCZ061EBA2, FCZ101EBA2, FCZ102EBA2, FCZ201EBA2, FCZ202EBA2, FCZ061EBH2, FCZ101EBH2, FCZ201EBH2, FCZ061EBN2, FCZ101EBN2...(Other models you can see in the webshop) | | |

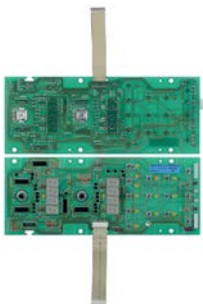
| | | | |
|---|---|-----------------|--------|
|  | | | |
| 1 | | | |
| GEV No. | 403859 | Ref. No. | OC3763 |
| description | keypad PCB for combi-steamer L 275mm W 110mm suitable for ELECTROLUX, ZANUSSI | | |
| For models: | FCS201G4, FCS202G4 | | |

| | | | |
|---|---|-----------------|---|
|  | | | |
| 1 | | | |
| GEV No. | 400189 | Ref. No. | 005463 006435 006674 OK1018 OK1027 221507 675835400 |
| description | main PCB combi-steamer 260200-245 | | |
| For models: | 5711-2-6, 5711-2-7, 5711-2-8, 5711-2-8CH, 5712-2-6, 5712-2-7, 5712-2-8, 5714-2-6, 5714-2-7, 5714-2-8, 5717-2-6, 5714-2-7, 5714-2-8, 5711-2-6L, 5711-2-7L, 5711-2-8L, 5721-2-7, 5712-2-6L, 5712-2-7L, 5712-2-8L, 5714-2-6L, 5714-2-7L, 5714-2-8L, 5714-2-6L, 5714-2-7L, 5714-2-8L, 5711-3-6, 5711-3-7, 5711-3-8, 5711-3-8CH, 5712-3-6, 5712-3-7, 5712-3-8, 5712-3-8E, 5712-3-8CH, 5714-3-6, 5714-3-7, 5714-3-8, 5714-3-8E, 5717-3-7, 5717-3-8, 5717-3-8E, 5717-3-8M, 5717-3-8C | | |

| | | | |
|---|--|-----------------|------------------|
|  | | | |
| 1 | | | |
| GEV No. | 403025 | Ref. No. | OC0968 OC4347 |
| description | main PCB combi-steamer COP35 LIV. ACTIVE L 334mm W 110mm 230V | | |
| For models: | FCS061GP, FCS061EP, FCS101EP4J, FCS101EP, FCS101GP9J, FCS102EP4J, FCS101GP, FCS102EP, FCS102GA9J, FCS201EP, FCS102GP, FCS202EP, FCS201GP, FCS202GP, FCS061EXLN, FCS061EX, FCS101EX4J, FCS101EXLN, FCS101EX, FCS102EX4J, FCS102EX, FCS201EX, FCS201EXLN, FCS202EX, FCS101GX9J, FCS101GX, FCS102GX9J, FCS102GX, FCS201GX, FCS202GX | | |

| | | | |
|--|---|-----------------|--------------------------------------|
|  | | | |
| 1 | | | |
| GEV No. | 403608 | Ref. No. | 003546 006613 006717 OC3764 |
| description | main PCB convection oven L 340mm W 115mm display | | |
| For models: | FCV/E101/1, FCV/E101L6JAP, FCV/E102/1L6JAP, FCV/G10L6JAP, FCV/G102/1L6JAP, FCV/E61/1, FCV/E101/1, FCV/E102/1, FCV/E61/1, FCV/E101/1, FCV/G61/1, FCV/G10L6, FCV/E10L6, FCV/G102/1L6, FCV/E102/1L6, FCV/G20L6, FCV/E20L6, FCV/G202L6, FCVE202L6, FCV/E101/1, ECV/G10T6, ECV/E10T6, ECV/G102/1T6, ECV/E102/1T6, ECV/G20T6, ECV/E20T6, ECVG202T6, ECV202T6, ECV/E10IGP, ACV/G10C6, ACV/G102/1C6, ACV/G20C6, ACV/G202C6, ACV/E10C6, ACV/E102/1C6, ACVE20C6, ACV/E202/1, ZCV/G10T6, ZCV/E10T6, ZCV/G102/1T6, ZCV/E102/1T6, ZCV/G20T6, ZCV/E20T6, ZCV/G202/1, ZCV/E202/1 | | |

| | | | |
|--|---|-----------------|---|
|  | | | |
| 1 | | | |
| GEV No. | 400744 | Ref. No. | 003763 0590893 0F0170 OK0671 OKE777 |
| description | PCB | | |
| For models: | FCF/G6-0, FCFG101/0, FCFG102-0, FCFG201-0, FCFG202-0, FCF/E6-0, FCFE101-0, FCFE102-0, FCFE201-0, FCFE202-0, FCF061ELN, FCF101ELN, FCF6EHOR, FCFG10160H, FCF061ENS, FCF101ENS, FCF102ENS, FCF201ENS, FCFG102-0T, FCF/G6-1-JAP, FCF/G101/1-1-JAP, FCF/G102/1-1-JAP, FCFE6-1J, FCFE101-1J, FCFE102-1J, FCF/G101/1, C7E4/200-3, C7E4/230-3, C7E4/400-3N, C7E6/400-3N, C7PE4/200-3, C7PE4/230-3, C7PE4/400-3N, C7PT4/400-3N, C104200-3, C104230-3, C104400-3N, C106400-3N, C10T4/400-, C10P4200-3, C10P4230-3, C10P44003N, C10P64003N, C10PT4/400, C204200-3, C20230-3, C204400-3N, C206400-3N, C20T4/400-, C20P4200-3...(Other models you can see in the webshop) | | |

| | | | |
|--|--|-----------------|--------|
|  | | | |
| 1 | | | |
| GEV No. | 400752 | Ref. No. | OC1071 |
| description | PCB | | |
| For models: | AOS061GAEU, AOS101GAEU, AOS102GAEU, AOS201GAEU, AOS-202GAEU, AOS061GAAU, AOS101GAAU, AOS102GAAU, AOS201GAAU, AOS202GAAU, AOS061GA, AOS061GB, AOS101GA, AOS101GB, AOS-201GA, AOS201GB, AOS102GB, AOS102GA, AOS202GB, AOS202GA | | |

1

| | | | |
|--------------------|--|-----------------|--------|
| GEV No. | 401343 | Ref. No. | 059033 |
| description | PCB | | |
| For models: | FCVG10-P, FCVG10PUK, FCVG20-P, FCVG20PUK, AFCV/G101, AFCV/G103, SCO/G10-3, AFCV/G201, AFCV/G203, SCO/G20-3 | | |



1

| | | | |
|--------------------|---|-----------------|--------|
| GEV No. | 400751 | Ref. No. | 007047 |
| description | PCB combi-steamer FCZ06/10/20 level A | | |
| For models: | FCZ061EAA, FCZ101EAA, FCZ102EAA, FCZ201EAA, FCZ202EAA, FCZ061EAH, FCZ101EAH, FCZ201EAH, FCZ061EAN, FCZ101EAN, FCZ201EAN, FCZ061ETA, FCZ101ETA, FCZ102ETA, FCZ201ETA, FCZ202ETA, FCZ061ETH, FCZ101ETH, FCZ201ETH, FCZ061ETN, FCZ101ETN, FCZ201ETN, FCZ061GAG, FCZ101GAG, FCZ102GAG, FCZ201GAG, FCZ202GAG, FCZ061GAD, FCZ101GAD, FCZ201GAD, FCZ202GAD, FCZ101GTG, FCZ102GTG, FCZ201GTG, FCZ202GTG, FCZ101GTD, FCZ102GTD, FCZ201GTD, FCZ202GTD, FCZ061EBA, FCZ101EBA, FCZ102EBA, FCZ061EBH, FCZ101EBH, FCZ061EBN, FCZ101EBN, FCZ061EBC, FCZ101EBC, FCZ201EBC, FCZ061EBA2...(Other models you can see in the webshop) | | |



1

| | | | |
|--------------------|--------|-----------------|------------------|
| GEV No. | 403960 | Ref. No. | OC0964 OC0970 |
| description | PCB | | |



1

| | | | |
|--------------------|---|-----------------|--------|
| GEV No. | 400814 | Ref. No. | 004213 |
| description | PCB pizza oven TH4351DC 2kW | | |
| For models: | ZCMDE9, ZCBDE18, FFPS32, PDE830, PDE1230, PDE12L30, PDE1830, PDE835, PDE1235, PDE12L35, PDE1835 | | |



1

| | | | |
|--------------------|---|-----------------|--------|
| GEV No. | 400187 | Ref. No. | 002666 |
| description | PCB combi-steamer FCV/G 101/1 102/1 | | |
| For models: | FCV/G6L3TOWNGAS, FCV/G6L3, FCV/G20L3, FCVG202L3, FCVE6L3J, FCV/E10L3JAP, FCV/E102/1L3JAP, FCV/G6L3JAP, FCVG6L3CJ, FCV/E61/1, FCV/E101/1, FCV/E61/1, FCV/E101/2, FCV/G6L3C, FCV/G61/1, FCV/G61/1, FCV/G61/1, FCVG6L3CT, FCVG6L3CJ, FCV/E10L3, FCV/E102/1, FCV/E6L3, FCV/E102/1L3, FCV/E20L3, FCVE202L3, FCV/G6L4, FCV/E6L4, FCV/E101/1, FCV/G101/1, FVC/E101/1, FCV/G102/1, FVC/E102/1, FCV/G201/1, FVC/E201/1, FCV/G202/1, FVC/E202/1, FCS061E44J, FCS061G48J, FCS061GP, FCS061G3DI, FCS061E3CI, FCS061G4, FCS061G4DT, FCS101E44J, FCS061G49J, FCS101E4, FCS101G4, FCS101G4DT, FCS102E44J, FCS101G49J...(Other models you can see in the webshop) | | |



1

| | | | |
|--------------------|---|-----------------|--------------------------------------|
| GEV No. | 401617 | Ref. No. | 002684 006611 006715 0C3757 |
| description | power PCB combi-steamer FCV 6GL | | |
| For models: | FCV/G6L3TOWNGAS, FCV/G6L3, FCVE6L3J, FCV/G6L3JAP, FCVG6L3CJ, FCV/E61/1, FCV/G10L2, FCV/E10L2, FCV/E61/1, FCV/G6L3C, FCVG6L3CT, FCVG6L3CJ, FCV/E6L3, FCV/E101/1, FCS061G3DI, FCS061E3CI, FCS101E2, FCS101G2, RCV061G2, RCV061E2, RCV101G2, RCV101E2, ACV/G10C2, ACV/E10C2, ACV/G6C3, ACV/G6C3C, ACV/E6C3, NCV/G6L2, NCV/G10L2, NCV/E6L2, NCV/E10L2 | | |



1

| | | | |
|--------------------|---|-----------------|--------------------------------------|
| GEV No. | 400748 | Ref. No. | 004105 006612 006716 0C3761 |
| description | power PCB combi-steamer FCV/G 101/1 102/1 | | |
| For models: | FCV/G10L3, FCVG10L3T, FCVG102L3, FCV/G20L3, FCVG202L3, FCV/E10L3JAP, FCV/E102/1L3JAP, FCVG10L3J, FCVG102L3J, FCV/E101/1, FCV/E101/2, FCV/G61/1, FCV/E10L3, FCV/E102/1, FCV/E102/1L3, FCV/E20L3, FCVE202L3, RCV101G2, RCV101E2 | | |



1

| | | | |
|--------------------|---|-----------------|--------------------------------------|
| GEV No. | 401572 | Ref. No. | 004079 006517 0C3762 0KE782 |
| description | power PCB combi-steamer FCV/G 101/1 102/1 | | |
| For models: | FCV/G61/1, FCV/G61/1, FCV/G6L4, FCV/E6L4, FCV/G101/1, FVC/E101/1, FCV/G102/1, FVC/E102/1, FCV/G201/1, FVC/E201/1, FCV/G202/1, FVC/E202/1, FCS061E44J, FCS061G48J, FCS061G4, FCS061G4DT, FCS101E44J, FCS061G49J, FCS101E4, FCS101G4, FCS101G4DT, FCS102E44J, FCS101G49J, FCS102E4, FCS102G4, FCS201E4, FCS102G49J, FCS202E4, FCS201G4, FCS202G4, FCS061E4, ECV/G6T4, ECV/E6T4, ECV/G10T4, ECV/E10T4, ECVG102T4, ECV/E102T4, ECV/G20T4, ECV/E20T4, ECVG202T4, ECV/E202T4, ECV/G6T4C, ECV/G10T4J, ECV/G61/1, ECV/G61/1, RCV061E4, RCV101G4, RCV101E4, ACV/G10C4, ACVG102C4...(Other models you can see in the webshop) | | |



1

| | | | |
|--------------------|---|-----------------|---|
| GEV No. | 400750 | Ref. No. | 0C0042 0C4890 0C5150 0TT685 675837800 |
| description | power PCB combi-steamer FCZ06/10/20 | | |
| For models: | FCZ061EAA, FCZ101EAA, FCZ102EAA, FCZ201EAA, FCZ202EAA, FCZ061EAH, FCZ101EAH, FCZ201EAH, FCZ061EAN, FCZ101EAN, FCZ201EAN, FCZ061ETA, FCZ101ETA, FCZ102ETA, FCZ201ETA, FCZ202ETA, FCZ061ETH, FCZ101ETH, FCZ201ETH, FCZ061ETN, FCZ101ETN, FCZ201ETN, FCZ061GAG, FCZ101GAG, FCZ102GAG, FCZ201GAG, FCZ202GAG, FCZ061GAD, FCZ101GAD, FCZ102GAD, FCZ201GAD, FCZ202GAD, FCZ101GTG, FCZ102GTG, FCZ201GTG, FCZ202GTG, FCZ101GTD, FCZ102GTD, FCZ201GTD, FCZ202GTD, FCZ061EBA, FCZ101EBA, FCZ102EBA, FCZ061EBH, FCZ101EBH, FCZ061EBN, FCZ101EBN, FCZ061EBC, FCZ101EBC, FCZ061EBA2...(Other models you can see in the webshop) | | |

keypads

front foils



1

| | | | |
|--------------------|--|-----------------|--------|
| GEV No. | 401132 | Ref. No. | 003838 |
| description | front foil | | |
| For models: | FCFG101/0, FCFG102-0, FCFG201-0, FCFG202-0, FCFE101-0, FCFE102-0, FCFE201-0, FCFE202-0, FCF101ELN, FCFG102-0T, FCF/G101/1-1-JAP, FCF/G102/1-1-JAP, FCFE101-1J, FCFE102-1J, FCF/G101/1, ECFG101-0, ECFG102-0, ACFG101-0, ACFG102-0, RCF101G, NCF/G101/1, NCF/G102/1, ZCF/G101/1, ZCF/G102/1 | | |



1

| | | | |
|--------------------|--|-----------------|--------|
| GEV No. | 401212 | Ref. No. | 003834 |
| description | front foil | | |
| For models: | FCV/G6L3TOWNGAS, FCV/G6L3, FCVE6L3J, FCV/G6L3JAP, FCVG6L3CJ, FCV/E61/1, FCV/G6L3C, FCV/G61/1, FCVG6L3CT, FCVG6L3CJ, FCV/E6L3 | | |



1

| | | | |
|--------------------|----------------------|-----------------|--------|
| GEV No. | 401216 | Ref. No. | 003835 |
| description | front foil | | |
| For models: | FCV/G10L2, FCV/E10L2 | | |



1

| | | | |
|--------------------|--|-----------------|--------|
| GEV No. | 401250 | Ref. No. | 003832 |
| description | front foil | | |
| For models: | FCV/G10L3, FCVG10L3T, FCVG102L3, FCV/G20L3, FCVG202L3, FCV/E10L3JAP, FCV/E102/1L3JAP, FCVG10L3J, FCVG102L3J, FCV/E101/2, FCV/E10L3, FCV/E102/1L3, FCV/E20L3, FCVE202L3 | | |

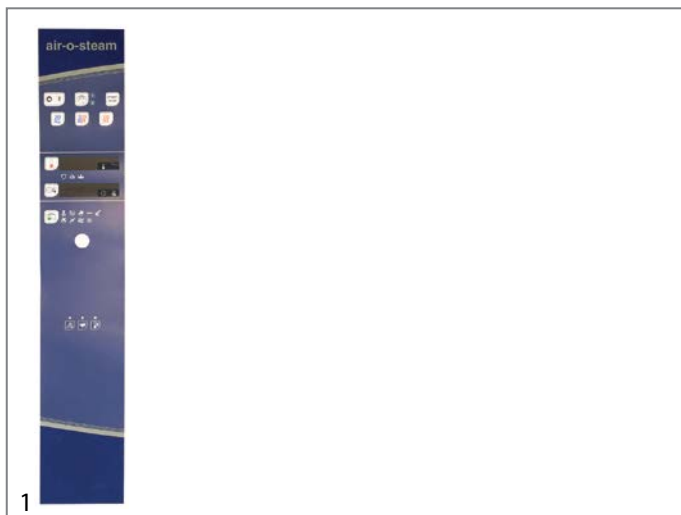

| | | | |
|--------------------|--|-----------------|--------|
| GEV No. | 512428 | Ref. No. | 0C6553 |
| description | front foil combi-steamer FCZ10 suitable for ELECTROLUX for air-o-steam L 890mm W 160mm | | |
| For models: | FCZ101ETA, FCZ102ETA, FCZ101ETH, FCZ101ETN, FCZ101GTG, FCZ102GTG, FCZ101GTD, FCZ102GTD, FCZ101EBA2, FCZ102EBA2, FCZ101EBH2, FCZ101EBN2, FCZ101EBC2, FCZ101GBG2, FCZ102GBG2, FCZ101GBD2, FCZ102GBD2, FCZ101GBI2, FCZ102GBI2, FCZ101ECA2, FCZ102ECA2, FCZ101ECH2, FCZ101ECN2, FCZ101GCG2, FCZ102GCG2, FCZ101GCD2, FCZ102GCD2, AOS101ETA1, AOS102ETA1, AOS101ETH1, AOS101ETN1, AOS101ETC1, AOS101ETE1, AOS101ETF1, AOS101ETM1, AOS102ETM1, AOS101ETK1, AOS102ETK1, AOS101GTG1, AOS102GTG1, AOS101GTD1, AOS102GTD1, AOS101GTP1, AOS102GTP1, AOS101GTW1, AOS102GTW1, AOS101EBA2, AOS102EBA2, AOS101EBH2, AOS101EBN2...(Other models you can see in the webshop) | | |

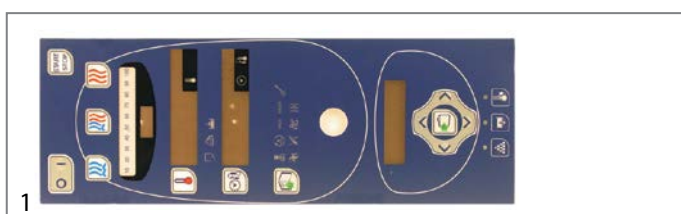

| | | | |
|--------------------|---|-----------------|--------|
| GEV No. | 401211 | Ref. No. | 007057 |
| description | keypad foil | | |
| For models: | AOS061GAEU, AOS101GAEU, AOS102GAEU, AOS201GAEU, AOS202GAEU, AOS061GAU, AOS101GAU, AOS102GAU, AOS201GAU, AOS202GAU, AOS061EABU, AOS101EABU, AOS201EABU, AOS061EAFU, AOS101EAFU, AOS201EAFU, AOS061EA, AOS101EA, AOS201EA, AOS061EA3J, AOS101EA3J, AOS201EA3J, AOS061EA2N, AOS101EA2N, AOS201EA2N, AOS102EA2N, AOS202EA2N, AOS061EA0H, AOS101EA0H, AOS201EA0H, AOS102EA, AOS202EA, AOS061GA, AOS101GA, AOS201GA, AOS102GB, AOS202GB, AOS061EAAQ, AOS101EAAQ, AOS102EAAQ, AOS201EAAQ, AOS202EAAQ, AOS061EANQ, AOS101EANQ, AOS102EANQ, AOS201EANQ, AOS202EANQ, AOS061EACQ, AOS101EACQ, AOS201EACQ...(Other models you can see in the webshop) | | |

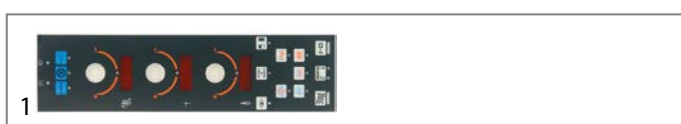

| | | | |
|--------------------|--|-----------------|--------|
| GEV No. | 401213 | Ref. No. | 003664 |
| description | keypad foil | | |
| For models: | FCV/G61/1, FCV/G61/1, FCV/G6L4, FCV/E6L4 | | |



| | | | |
|--------------------|---|-----------------|--------|
| GEV No. | 401214 | Ref. No. | 007058 |
| description | keypad foil | | |
| For models: | FCZ061EAA, FCZ101EAA, FCZ102EAA, FCZ061EAH, FCZ101EAH, FCZ061EAN, FCZ101EAN, FCZ061EBA, FCZ101EBA, FCZ102EBA, FCZ061EBH, FCZ101EBH, FCZ061EBN, FCZ101EBN, FCZ061EBC, FCZ101EBC, FCZ061ECA, FCZ101ECA, FCZ102ECA, FCZ061ECH, FCZ101ECH, FCZ061ECN, FCZ101ECN, AOS061EB, AOS101EB, AOS201EB, AOS061EB3J, AOS101EB3J, AOS201EB3J, AOS061EB2N, AOS101EB2N, AOS201EB2N, AOS061EB5M, AOS061EB6M, AOS102EB2N, AOS202EB2N, AOS061EB0H, AOS101EB0H, AOS201EB0H, AOS102EB, AOS202EB, AOS061GB, AOS101GB, AOS201GB, AOS102GA, AOS202GA, AOS061EBAQ, AOS101EBAQ, AOS102EBAQ, AOS201EBAQ...(Other models you can see in the webshop) | | |



| | | | |
|--------------------|----------------------|-----------------|--------|
| GEV No. | 401215 | Ref. No. | 056680 |
| description | keypad foil | | |
| For models: | FCVE103CE, FCVE203CE | | |



| | | | |
|--------------------|--|-----------------|--------|
| GEV No. | 401217 | Ref. No. | 059288 |
| description | keypad foil | | |
| For models: | FCVE20/P-V, FCVE10-P, FCVE10PUK, FCVG10-P, FCVG10PUK, FCVE20-P, FCVE20PUK, FCVG20-P, FCVG20PUK | | |



| | | | |
|--------------------|--|-----------------|--------|
| GEV No. | 401247 | Ref. No. | 002719 |
| description | keypad foil | | |
| For models: | FCV/E101/1, FCV/E10L6JAP, FCV/E102/1L6JAP, FCV/G10L6JAP, FCV/G102/1L6JAP, FCV/E101/1, FCV/E102/1, FCV/E101/1, FCV/G10L6, FCV/E10L6, FCV/G102/1L6, FCV/E102/1L6, FCV/G20L6, FCV/E20L6, FCVG202L6, FCVE202L6 | | |





| | | | |
|--------------------|---------------------------------|-----------------|--------|
| GEV No. | 401249 | Ref. No. | 005623 |
| description | keypad foil | | |
| For models: | FCV/E61/1, FCV/E61/1, FCV/G61/1 | | |



| | | | |
|--------------------|--|-----------------|--------|
| GEV No. | 401251 | Ref. No. | 006529 |
| description | keypad foil | | |
| For models: | FCV/G101/1, FVC/E101/1, FCV/G102/1, FVC/E102/1, FCV/G201/1, FVC/E201/1, FCV/G202/1, FVC/E202/1 | | |

| | | | |
|---|-------------|-----------------|--------|
|  | | | |
| GEV No. | 401347 | Ref. No. | OK2622 |
| description | keypad foil | | |
| For models: | 5614-3-10 | | |

| | | | |
|---|-------------|-----------------|--------|
|  | | | |
| GEV No. | 401532 | Ref. No. | OK2620 |
| description | keypad foil | | |
| For models: | 5612-3-10 | | |

| | | | |
|---|-------------|-----------------|--------|
|  | | | |
| GEV No. | 401533 | Ref. No. | OK2617 |
| description | keypad foil | | |
| For models: | 5611-3-6 | | |

| | | | |
|---|-------------|-----------------|--------|
|  | | | |
| GEV No. | 401534 | Ref. No. | 0H6893 |
| description | keypad foil | | |
| For models: | 5611-3-8 | | |

| | | | |
|---|-------------|-----------------|--------|
|  | | | |
| GEV No. | 401535 | Ref. No. | OK2618 |
| description | keypad foil | | |
| For models: | 5611-3-10 | | |

| | | | |
|---|-------------|-----------------|--------|
|  | | | |
| GEV No. | 401536 | Ref. No. | OK2619 |
| description | keypad foil | | |
| For models: | 5612-3-6 | | |

| | | | |
|---|-------------|-----------------|--------|
|  | | | |
| GEV No. | 401537 | Ref. No. | 0H6894 |
| description | keypad foil | | |
| For models: | 5612-3-8 | | |

| | | | |
|--|-------------|-----------------|--------|
|  | | | |
| GEV No. | 401538 | Ref. No. | OK2621 |
| description | keypad foil | | |
| For models: | 5614-3-6 | | |

| | | | |
|--|-------------|-----------------|--------|
|  | | | |
| GEV No. | 401539 | Ref. No. | 0H6895 |
| description | keypad foil | | |
| For models: | 5614-3-8 | | |

| | | | |
|--|--|-----------------|------------------|
|  | | | |
| GEV No. | 401543 | Ref. No. | 005282 005417 |
| description | keypad foil | | |
| For models: | 5714-2-7, 5714-2-7, 5714-2-7L, 5714-2-7L, 5714-3-7, 5717-3-7 | | |

| | | | |
|---|---|-----------------|----------------------------|
|  | | | |
| GEV No. | 401544 | Ref. No. | 005225 005325 006050 |
| description | keypad foil | | |
| For models: | 5714-2-8, 5714-2-8, 5714-2-8L, 5714-2-8L, 5714-3-8, 5714-3-8E, 5717-3-8, 5717-3-8E, 5717-3-8M, 5717-3-8C, 5717-3-8M | | |

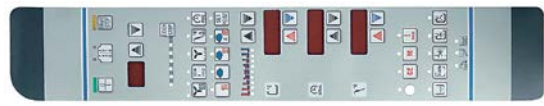
| | | | |
|--|---|-----------------|----------------------------|
|  | | | |
| GEV No. | 401545 | Ref. No. | 005418 0H6442 OK1597 |
| description | keypad foil | | |
| For models: | 5714-2-10, 5714-2-10, 5714-2-10L, 5714-2-10L, 5714-3-10, 5717-3-6, 5717-3-10, 5714-2-10F, 5714-2-10S, 5714-3-10F, 5714-3-10S, 5702-2-3, 5704-2-3, 57074-2-3, 5701-3-3, 5702-3-3, 5704-3-3, 5707-3-3 | | |

| | | | |
|--|---|-----------------|--------|
|  | | | |
| GEV No. | 401551 | Ref. No. | 005101 |
| description | keypad foil | | |
| For models: | FVC/E201/1, FVC/E202/1, 5711-2-8, 5711-2-8CH, 5711-2-8L, 5711-3-8, 5711-3-8CH | | |



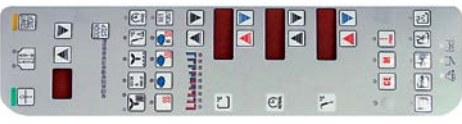

| | | | |
|---|---|-----------------|--------|
|  | | | |
| 1 | | | |
| GEV No. | 401552 | Ref. No. | 005287 |
| description | keypad foil | | |
| For models: | 5711-2-10, 5711-2-10CH, 5711-2-10L, 5721-2-10, 5711-3-10, 5711-3-10CH, 5711-3-10F, 5711-3-10S | | |

| | | | |
|---|-------------------------------|-----------------|--------|
|  | | | |
| 1 | | | |
| GEV No. | 401553 | Ref. No. | 005278 |
| description | keypad foil | | |
| For models: | 5712-2-7, 5712-2-7L, 5712-3-7 | | |

| | | | |
|---|--|-----------------|------------------|
|  | | | |
| 1 | | | |
| GEV No. | 401554 | Ref. No. | 005280 005416 |
| description | keypad foil | | |
| For models: | 5714-2-6, 5717-2-6, 5714-2-6L, 5714-2-6L, 5714-3-6 | | |

| | | | |
|---|----------------------|-----------------|--------|
|  | | | |
| 1 | | | |
| GEV No. | 401555 | Ref. No. | 006058 |
| description | keypad foil | | |
| For models: | 5721-2-10, 5711-3-10 | | |

| | | | |
|---|--------------------|-----------------|--------|
|  | | | |
| 1 | | | |
| GEV No. | 401556 | Ref. No. | 005452 |
| description | keypad foil | | |
| For models: | 5702-2-3, 5702-3-3 | | |

| | | | |
|---|-------------|-----------------|--------|
|  | | | |
| 1 | | | |
| GEV No. | 401577 | Ref. No. | 005459 |
| description | keypad foil | | |
| For models: | 5701-3-2 | | |

| | | | |
|---|-------------|-----------------|--------|
|  | | | |
| 1 | | | |
| GEV No. | 401578 | Ref. No. | 005457 |
| description | keypad foil | | |
| For models: | 5701-3-3 | | |

| | | | |
|---|--------------------|-----------------|--------|
|  | | | |
| 1 | | | |
| GEV No. | 401579 | Ref. No. | 005449 |
| description | keypad foil | | |
| For models: | 5702-2-2, 5702-3-2 | | |

| | | | |
|---|--|-----------------|--------|
|  | | | |
| 1 | | | |
| GEV No. | 401580 | Ref. No. | 005455 |
| description | keypad foil | | |
| For models: | 5704-2-2, 5707-2-2, 5704-3-2, 5707-3-2 | | |

| | | | |
|---|---|-----------------|--------|
|  | | | |
| 1 | | | |
| GEV No. | 401581 | Ref. No. | 005453 |
| description | keypad foil | | |
| For models: | 5704-2-3, 57074-2-3, 5704-3-3, 5707-3-3 | | |

| | | | |
|---|-------------------------------|-----------------|--------|
|  | | | |
| 1 | | | |
| GEV No. | 401582 | Ref. No. | 005276 |
| description | keypad foil | | |
| For models: | 5712-2-6, 5712-2-6L, 5712-3-6 | | |

| | | | |
|---|--|-----------------|----------------------------|
|  | | | |
| 1 | | | |
| GEV No. | 401583 | Ref. No. | 005266 006048 0K1596 |
| description | keypad foil | | |
| For models: | 5712-2-10, 5712-2-10L, 5712-3-10, 5712-3-10C, 5712-2-10F, 5712-2-10S, 5712-3-10F, 5712-3-10S | | |

accessories

| | | | |
|--|---|-----------------|--|
|  | | | |
| 1 | | | |
| GEV No. | 400997 | Ref. No. | 002670 0F0086 0K8489 0T5656 869066 |
| description | push button | | |
| For models: | AQC22U US, AQC31U US, AQC60U, , , BC28A6, Crosswise, , BCF15A6, , ADN220ES, ADF110ES, ADF220ES, ADN110E, ADF110E, ADN220E, ADF220E, BC15A, BC28A, Crosswise, BCF15A, BCF28A, Crosswise, BC10A, BCF7A, KFH/G1, KFH/E1, KFH/G1ELH, KFH/E1ELH, KFH/G1EH, KFH/E1EH, HFH/G435, HFH/G435, QFH/G1, QFH/E1, QFH/G1ELH, QFH/E1ELH, QFH/G1EH, QFH/E1H, ZFH/G435, ZFH/G435, WFH/G1, WFH/E1, WFH/G1ELH, WFH/E1ELH, WFH/G1EH, WFH/E1EH, AFH/G435, AFH/E435, EB550....(Other models you can see in the webshop) | | |



solenoid valves

solenoid valves (water)

ELBI

straight



| | | | |
|------------------------|---|-----------------|-------------------|
| GEV No. | 373021 | Ref. No. | 0L3028 |
| description | solenoid valve double straight 230VAC inlet 3/4" outlet 11.5mm output 1x 4.7l/min DN10 ELBI | | |
| spare parts for | 373021 | | |
| | GEV No. | 370467 | Ref. No. — |
| | solenoid valve filter suitable for ELBI | | |
| | GEV No. | 371263 | Ref. No. — |
| | reducer ELBI flow rate 4.7l/min pressure range 0 up to 10bar tolerance ±15/25% grey | | |



| | | | |
|--------------------|---|-----------------|--------------------------------------|
| GEV No. | 373009 | Ref. No. | 046795 046796 047534 048180 |
| description | solenoid valve double straight 24V inlet 3/4" outlet 13.5mm DN10 t.max. 90°C duty cycle 100% ELBI | | |
| For models: | CT92DXE, CT92SXE, CT92DXEUK, CT92SXEUK, CT92DXV, CT92SXV, CT92DXVUK, CT92SXVUK, CT140EDX, CT140ESX, CT140EDXUK, CT140SXEUK, CT140VDX, CT140VSX, CT141EDX, CT141ESX, CT141E-DUK, CT141ESUK, CT141VDX, CT141VSX, CT142DXE, CT142SXE, CT142DXEUK, CT142SXEUK, CT142DXV, CT142SXV, CT190DXE, CT190SXE, CT190DXEUK, CT190SXEUK, CT190DXV, CT190SXV, CT-191DXE, CT191SXE, CT191DXEUK, CT191SXEUK, CT191DXV, CT191SXV, CT192DXE, CT192SXE, CT192DXEUK, CT192SXEUK, CT192DXV, CT192SXV, CT240DXE, CT240SXE, CT240DXEUK, CT240SX, CT240DXV, CT240SXVUK...(Other models you can see in the webshop) | | |



| | | | |
|--------------------|--|-----------------|--|
| GEV No. | 373017 | Ref. No. | 003608 046655 047370 053827 055132 055529 056486 057577 086014 086500 0H9339 0K8513 0KD793 |
| description | solenoid valve single straight 230VAC inlet 3/4" outlet 11.5mm DN10 ELBI | | |
| For models: | CIM15A, CIM15W, CIM45A, CIM45W, CIM65A, CIM65W, VO40G, FDV40G, FDV40E, FDV40GZ, FDV40EL, FDV40GA, FDV20G, FDV20E, FDV20GZ, FDV20EL, FDV20GA, RPI/E240, RPI/E260, RPI/G260P, RPI/E260P, XPI/E240, XPI/E260, XPI/G260P, XPI/E260P, JPI/E240, JPI/E260, MPI/E240, MPI/E260, MPI/G260P, MPI/E260P, PPD/G260, PPI/G260P, PPI/E260P, OPD/G260, OPI/G260P, OPI/E260P, TPD/G260, TPI/G260P, TPI/E260P, KPI/G10, KPI/G15, KPI/E10, KPI/E15, KPD/G10, KPD/G15, KPD/G15A, KPI/G15A, KPI/E15A, KPI/G06...(Other models you can see in the webshop) | | |



| | | | |
|------------------------|--|-----------------|-------------------|
| GEV No. | 373018 | Ref. No. | 072282 |
| description | solenoid valve single straight 230VAC inlet 3/4" outlet 14mm DN10 ELBI | | |
| For models: | LC5E, LC5E | | |
| spare parts for | 373018 | | |
| | GEV No. | 370467 | Ref. No. — |
| | solenoid valve filter suitable for ELBI | | |

angled



| | | | |
|------------------------|--|-----------------|-------------------|
| GEV No. | 373019 | Ref. No. | 069295 |
| description | solenoid valve double angled 230VAC inlet 3/4" outlet 11.5mm DN10 ELBI | | |
| spare parts for | 373019 | | |
| | GEV No. | 370467 | Ref. No. — |
| | solenoid valve filter suitable for ELBI | | |

1

| | | | |
|---|--|-----------------|-------------------|
| GEV No. | 373016 | Ref. No. | 048898 |
| description | solenoid valve single angled 230VAC inlet 3/4" outlet 13.5mm DN10 ELBI | | |
| spare parts for | 373016 | | |
|  | GEV No. | 370467 | Ref. No. — |
| solenoid valve filter suitable for ELBI | | | |



1

| | | | |
|--------------------|--|-----------------|--------|
| GEV No. | 373012 | Ref. No. | 0L3440 |
| description | solenoid valve single angled 230VAC inlet 3/4" outlet 13.5mm input 20l/min t.max. 90°C duty cycle 100% ELBI flow regulating valve inlet orange | | |
| For models: | WT4, WT4B, WT4D, WT4DB, WT46, NUC3DD, WT4D60, WT4DDG, EUC1, EUC1DP, EUC3, EUC3DP, EUC1G, EUC1DP60, EUC3DD, LS5/1, LS5/1DP, LS5/3, LS5/3DP, LS5/1DP60, LS5/1DPAUS, LS5/1DPCS, KUC3, KUC3DP, NUC1, NUC1DP, NUC3, NUC3DP, NUC1DP60, NUC1DPA, LS61, LS61/60, LS6EP, LS6EP/DD, LS62, LS62D, LS62/UKRP, LS62F, LV62, LS62/60, ECOTEMP5, LS62/1P, LS62HD, LS63, LS63D, LS63/UKRP, LS63F, LV63, LS63/60, LS63/1P...(Other models you can see in the webshop) | | |



1

| | | | |
|--------------------|---|-----------------|--------|
| GEV No. | 373020 | Ref. No. | 049056 |
| description | solenoid valve double angled 230VAC inlet 3/4" outlet 14mm input 10l/min DN10 t.max. 90°C duty cycle 100% ELBI flow regulating valve inlet white | | |
| For models: | LB1, LB1/RBP, LB1/60, WT1WSDP, LB2DPSAUS, LB1G, WT2DPDI, LB2, WT2WSDP, WT1, WT1/3DP, WT2/3DP, NGW2DPG, WT2DPAUS, WT2, LB2DPDI, LB2DP3, WT2DPD3, NGWGMS, UC1, GW1, LV1WSDP, LV2WSDP, GW2DPG, GW2G, GW2 | | |



1

| | | | |
|--------------------|---|-----------------|------------------|
| GEV No. | 373008 | Ref. No. | 049077 0L3442 |
| description | solenoid valve triple angled 230VAC inlet 3/4" outlet 13.5mm ELBI output B 0.5l/min flow regulating valve outlet B red | | |
| For models: | LB1WS, LB1WSDP, LB1/TOP, WT1WSDP, LB2DPSAUS, LB1WSG, WT2TOP60, WT2WSDPDI, LB1TOP, WT2TOPDI, LB2WS, LB2WSDP, LB2/TOP, LB2/RBP, LB2WS60, WT2WSDP, WT2WSDPD, LB2WSG, WT2WS, WT1WS, WT1TOP, WT2TOP, NGW2WSDPG, LB2WSDPDI, LB2WSDPD, LB2TOP, EGWSSIC, EGWSSICW, EGWSSICWP, EGWSSICWPB, EGWSSICP3, ZGWSSIC, ZGWSSICW, ZGWSSICWP, EGWSIC, EGWSICW, EGWSICWP, EGWSICWG, EGWSICWGU, EGWSICWPB, EGWSICP3, EGWSDICG3, EGWSICWPB6, EGWSDICWGB, EGWSICWGBU, EGWSDICG, EGWSDICWG, ZGWSIC, ZGWSICW, ZGWSICWP...(Other models you can see in the webshop) | | |

spare parts and accessories

reducers

outlet side



1

| | | | |
|--------------------|--|-----------------|--------|
| GEV No. | 371261 | Ref. No. | 0L0166 |
| description | reducer ELBI flow rate 1.2l/min pressure range 0 up to 10bar tolerance ±15/25% clear | | |
| For models: | RT100ED, RT100ES, RT100SR, RT100SL, RT140ED, RT140ES, RT140SR, RT140SL, RT190ED, RT190ES, RT190SR, RT190SL, RT190HDED, RT190HDES, RT190HSR, RT190HSL, RT270ED, RT270ES, RT270SR, RT270SL, RT270HDED, RT270HDES, RT270HSR, RT270HSL, RT100ERF, RT100ELF, RT100VD, RT100VS, RT140ERF, RT140ELF, RT140VD, RT140VS, RT142ERF, RT142ELF, RT190ERF, RT190ELF, RT190VD, RT190VS, RT190HEREF, RT190HELFF, RT190HDVDF, RT190HDVSF, RT270ERF, RT270ELF, RT270VDF, RT270VSF, RT270HEREF, RT270HELFF, RT270HDVDF, RT270HDVSF...(Other models you can see in the webshop) | | |



1

| | | | |
|--------------------|---|-----------------|--------|
| GEV No. | 371262 | Ref. No. | 0L0167 |
| description | reducer ELBI flow rate 2.5l/min pressure range 0 up to 10bar tolerance ±15/25% orange | | |
| For models: | W3400H06, W355HE, W3400H, W3400H, W355HQSR, W355H, W355H, W455H04, W455HQSR, LB81E, LB81BP, LB81COP, LB121E, LB121BP, LB161E, LB161BP, LB161V, CLB161E, CLB161V, WE55QSR_EL, RT100ED, RT100ES, RT100SR, RT100SL, RT140ED, RT140ES, RT140SR, RT140SL, RT190ED, RT190ES, RT190SR, RT190SL, RT190HDED, RT190HDES, RT190HSR, RT190HSL, RT270ED, RT270ES, RT270SR, RT270SL, RT270HDED, RT270HDES, RT270HSR, RT270HSL, RT100ERF, RT100ELF, RT100VD, RT100VS, RT140ERF, RT140ELF...(Other models you can see in the webshop) | | |



1

| | | | |
|--------------------|---|-----------------|--------|
| GEV No. | 371246 | Ref. No. | 0W2908 |
| description | reducer flow rate 5.5l/min tolerance ±25% black | | |
| For models: | W3400H06, W355HE, W3400H, W3400H, W355HQSR, W355H, W355H, W455H04, W455HQSR, LC12EC, CLC12EC, CLC22VC, LB81E, LB81BP, LB81COP, LB121E, LB121BP, LB161E, LB161BP, LB161V, CLB161E, CLB161V, WE55QSR_EL, W455H01, W455H03, W3400H01, W3400H02, W3400H03, W3400H04, W3600H01, W3600H02, W3600H03, W3600H04, W3850H, W31100H, W455H05 | | |

MÜLLER

medium temperature: 90°C
duty cycle: 100%



1

| | | | |
|---|---|-----------------|--------------------------------------|
| GEV No. | 370117 | Ref. No. | 066379 0G2089 0G2196 0H6531 |
| description | solenoid valve single straight 230VAC inlet 3/4" outlet 11.5mm DN10 t.max. 90°C duty cycle 100% MÜLLER | | |
| For models: | 5611-3-10, 5611-3-6, 5611-3-8, 5612-3-10, 5612-3-6, 5612-3-8, 5614-3-10, 5614-3-6, 5614-3-8 | | |
| spare parts for | 370117 | | |
|  | GEV No. | 370133 | Ref. No. — |
| | solenoid valve body single straight inlet 3/4" outlet 11.5mm DN10 t.max. 90°C duty cycle 100% MÜLLER 230V | | |
|  | GEV No. | 371002 | Ref. No. — |
| | solenoid valve holder MÜLLER flange support | | |
|  | GEV No. | 371009 | Ref. No. — |
| | compression spring for solenoid coil | | |
|  | GEV No. | 371011 | Ref. No. — |
| | spare parts kit membrane with long star star high 8mm MÜLLER | | |
|  | GEV No. | 371017 | Ref. No. — |
| | solenoid coil MÜLLER 220-240VAC 50-60Hz connection male faston 6.3mm | | |
|  | GEV No. | 371122 | Ref. No. — |
| | solenoid valve filter ø 19mm H 10mm suitable for MÜLLER | | |
|  | GEV No. | 501161 | Ref. No. — |
| | tap head for solenoid valve holder for solenoid coils | | |
| accessories for | 370117 | | |
|  | GEV No. | 371010 | Ref. No. — |
| | solenoid coil 230VAC connection with cable cable length 2000mm | | |
|  | GEV No. | 371037 | Ref. No. — |
| | solenoid coil 24VAC 50/60Hz connection male faston 6.3mm | | |

accessories for 370117

| | | | | |
|---|--|--------|-----------------|---|
|  | GEV No. | 371038 | Ref. No. | — |
| | solenoid coil 230VAC connection appliance plug | | | |

ROBERTSHAW/INVENSYS

medium temperature: 90°C 90°C 60°C
ambient temperature: 60°C 25°C 60°C
duty cycle: 40% 100% 100%



1

| | | | |
|--------------------|--|-----------------|--|
| GEV No. | 372021 | Ref. No. | 045631 046427 047536 0H9966 0K5389 127291 |
| description | solenoid valve double straight 230VAC inlet 3/4" outlet 11.5mm DN10 EATON (INVENSYS) | | |
| For models: | LB80EPH, LB80E, LB120EPH, LB120E, LB160EPH, LB160E, LB160V, CLB160E, CLB160V, VARIOSTEAM/S-33.3/F, STEAM-O-MAT, LB80E, LB120E, LB160EZ, LB160V, CLB160E, CLB160V, EWM120, EWM160 | | |

solenoid valves with reducers

single





1

| | | | |
|--------------------|--|-----------------|----------------------------|
| GEV No. | 372028 | Ref. No. | 056350 0C0688 0C4984 |
| description | solenoid valve single angled 230VAC inlet 3/4" outlet 11.5mm input 10l/min t.max. 90°C duty cycle 100% EATON (INVENSYS) plastic flow regulating valve inlet white | | |
| For models: | KBR/G2F, KBR/G2C, KBR/G3F, KBR/G3FH, KBR/G3C, KBR/G3CH, KBR/E2F, KBR/E2C, KBR/E3F, KBR/E3FH, KBR/E3C, KBR/E3CH, KBR/G2FH, KBR/G2CH, KBR/E2FH, KBR/E2CH, QBR/G2F, QBR/G2C, QBR/G3F, QBR/G3FH, QBR/G3C, QBR/G3CH, QBR/E2F, QBR/E2C, QBR/E3F, QBR/E3FH, QBR/E3C, QBR/E3CH, QBR/G2FH, QBR/G2CH, QBR/E2FH, QBR/E2CH, WBR/G2F, WBR/G2C, WBR/G3F, WBR/G3FH, WBR/G3C, WBR/G3CH, WBR/E2F, WBR/E2C, WBR/E3F, WBR/E3FH, WBR/E3C, WBR/E3CH, WBR/G2FH, WBR/G2CH, WBR/E2FH, WBR/E2CH | | |





| | | | |
|---|---|-----------------|------------------|
|  | | | |
| GEV No. | 370254 | Ref. No. | 049626 088194 |
| description | solenoid valve single angled 230VAC inlet 3/4" outlet 14mm input 12l/min t.max. 90°C EATON (INVENSYS) plastic flow regulating valve inlet grey | | |
| For models: | SSBMHC12, SSBMHC16, SSBMHC20, SSBMB12, SSBMB16, SSBMBH20, SSBMB8, SSBMHC8, DBMAC12, DBMAC16, DBMAC20, DBMP12, DBMP16, DBMP20, ZLB12H, ZLB16H, ZLB20H, ZLB12B, ZLB16B, ZLB20B, ZLB08B, ZLB08H, DI2BM, DI3BM, DI4BM, DI2BMO, DI3BMO, DI4BMO, LS6EADD, LS6EA/DPDD, WT38/M50, LS6EADP3, WT37LEV/9, WT38M50/4, LS6EA/60, WT38D, WT37, WT38, WT37/4.5, WT38/4.5, WT38/4.5NW, WT38/60, WT38/M60, WT38MED, WT38M60/4, LS6EA, LS6EA/DP, LS6MCD, LS10, LS14EA...(Other models you can see in the webshop) | | |

| | | | |
|---|--|-----------------|--------|
| <p>2-fold</p>  | | | |
| GEV No. | 370775 | Ref. No. | 0C5517 |
| description | solenoid valve double straight 230VAC inlet 3/4 outlet 12mm EATON (INVENSYS) output A 0.25l/min output B 5l/min | | |
| For models: | FCZ102EAA, FCZ102ETA, FCZ201ETA, FCZ202ETA, FCZ201ETH, FCZ201ETN, FCZ101GTG, FCZ102GTG, FCZ201GTG, FCZ202GTG, FCZ101GTD, FCZ102GTD, FCZ201GTD, FCZ202GTD, FCZ102EBA, FCZ102EBA2, FCZ201EBA2, FCZ202EBA2, FCZ201EBH2, FCZ201EBN2, FCZ201EBC2, FCZ101GBG2, FCZ102GBG2, FCZ201GBG2, FCZ202GBG2, FCZ101GBD2, FCZ102GBD2, FCZ201GBD2, FCZ202GBD2, FCZ101GBI2, FCZ102GBI2, FCZ201GBI2, FCZ102ECA, FCZ102ECA2, FCZ201ECA2, FCZ202ECA2, FCZ201ECH2, FCZ201ECN2, FCZ101GCG2, FCZ102GCG2, FCZ201GCG2, FCZ202GCG2, FCZ101GCD2, FCZ102GCD2, FCZ201GCD2, FCZ202GCD2, AOS102EAA1, AOS201EAA1, AOS202EAA1, AOS201EAH1...(Other models you can see in the webshop) | | |

| | | | |
|---|--|-----------------|---------------------|
|  | | | |
| GEV No. | 372002 | Ref. No. | 0C5516 696808300 |
| description | solenoid valve double straight 230VAC inlet 3/4" outlet 11.5mm 10 t.max. 90°C Invensys plastic output A 0.25l/min output B 2.5l/min flow regulating valve outlet A transparent/white flow regulating valve outlet B dark brown | | |
| For models: | FCZ061EAA, FCZ101EAA, FCZ061EAH, FCZ101EAH, FCZ061EAN, FCZ101EAN, FCZ061ETA, FCZ101ETA, FCZ061ETH, FCZ101ETH, FCZ061ETN, FCZ101ETN, FCZ061GAG, FCZ061GAD, FCZ061EBA, FCZ101EBA, FCZ061EBH, FCZ101EBH, FCZ061EBN, FCZ101EBN, FCZ061EBC, FCZ101EBC, FCZ061EBA2, FCZ101EBA2, FCZ061EBH2, FCZ101EBH2, FCZ061EBN2, FCZ101EBN2, FCZ061EBC2, FCZ101EBC2, FCZ061GBG, FCZ061GBD, FCZ061ECA, FCZ101ECA, FCZ061ECH, FCZ101ECH, FCZ061ECN, FCZ101ECN, FCZ061ECA2, FCZ101ECA2, FCZ061ECH2, FCZ101ECH2, FCZ061ECN2, FCZ101ECN2, AOS061EAA1, AOS101EAA1, AOS061EAH1, AOS101EAH1, AOS061EAN1, AOS101EAN1...(Other models you can see in the webshop) | | |

| | | | |
|---|---|-----------------|----------------------------|
| <p>3-fold</p>  | | | |
| GEV No. | 370345 | Ref. No. | 002859 0C1934 0K1872 |
| description | solenoid valve triple straight 230VAC inlet 3/4" outlet 11.5mm t.max. 90°C EATON (INVENSYS) plastic output B 0.25l/min output C 1.2l/min flow regulating valve outlet B white flow regulating valve outlet C blue | | |
| For models: | FCZ061EAA, FCZ101EAA, FCZ102EAA, FCZ201EAA, FCZ061EAH, FCZ101EAH, FCZ201EAH, FCZ061EAN, FCZ101EAN, FCZ201EAN, FCZ101GAG, FCZ102GAG, FCZ201GAG, FCZ101GAD, FCZ102GAD, FCZ201GAD, FCZ061EBA, FCZ101EBA, FCZ102EBA, FCZ201EBA, FCZ061EBH, FCZ101EBH, FCZ201EBH, FCZ101EBN, FCZ201EBN, FCZ101GBG, FCZ102GBG, FCZ201GBG, FCZ101GBD, FCZ102GBD, FCZ201GBD, FCZ061GBI, FCZ101GBI, FCZ201GBI, FCV/G6L4, AOS-061GAEU, AOS101GAEU, AOS102GAEU, AOS201GAEU, AOS061GAAU, AOS101GAAU, AOS102GAAU, AOS201GAAU, AOW101EA, AOS061EABU, AOS101EABU, AOS201EABU, AOS061EAFU, AOS101EAFU, AOS201EAFU...(Other models you can see in the webshop) | | |

| | | | |
|---|--|-----------------|------------------|
| <p>with coded terminal</p>  | | | |
| GEV No. | 370269 | Ref. No. | 069262 072364 |
| description | solenoid valve double straight 230VAC inlet 3/4" outlet 11.5mm DN10 EATON (INVENSYS) | | |
| For models: | LC7E, LC10E, LC12E, CLC12E, LACE12M/EI, CLC22E, CLC22, LACE22M, CLC22V, CLC22V, LACV22M/V, CLC40V, LC7E, LC12E, CLC12E, CLC22E, CLC22V, CLC22E, CLC22V | | |

| | | | |
|--|---|-----------------|----------------------------|
|  | | | |
| GEV No. | 370355 | Ref. No. | 0C1113 0C1133 0C1933 |
| description | solenoid valve single angled 230VAC inlet 3/4" outlet 11.5mm DN10 EATON (INVENSYS) | | |
| For models: | FCZ061EAA, FCZ101EAA, FCZ102EAA, FCZ201EAA, FCZ202EAA, FCZ061EAH, FCZ101EAH, FCZ201EAH, FCZ061EAN, FCZ101EAN, FCZ201EAN, FCZ061GAG, FCZ101GAG, FCZ102GAG, FCZ201GAG, FCZ202GAG, FCZ061GAD, FCZ101GAD, FCZ102GAD, FCZ201GAD, FCZ202GAD, FCZ061EBA, FCZ101EBA, FCZ061EBH, FCZ101EBH, FCZ101EBN, FCZ061EBC, FCZ101EBC, FCZ201EBC, FCZ061GBI, FCZ101GBI, FCZ201GBI, FCZ102ECA, FCZ201ECA, FCZ202ECA, FCZ201ECH, FCZ201ECN, FCZ061GCG, FCZ101GCG, FCZ102GCG, FCZ201GCG, FCZ202GCG, FCZ061GCD, FCZ101GCD, FCZ102GCD, FCZ201GCD, FCZ202GCD, FCS201EX, FCS201EXLN, FCS202EX...(Other models you can see in the webshop) | | |



| | | | |
|--------------------|---|-----------------|--------|
| GEV No. | 374107 | Ref. No. | 0C6081 |
| description | solenoid valve single straight 230VAC inlet 1" duty cycle 100% plastic | | |
| For models: | FCF02EV, FCF02EOEM, FCF/E6-0, FCFE101-0, FCFE102-0, FCFE201-0, FCFE202-0, FCF061ELN, FCF101ELN, FCF6EHOR, FCF061ENS, FCF101ENS, FCF102ENS, FCF201ENS, FCFE6-1J, FCFE101-1J, FCFE102-1J, ECF/E6-0, ECFE101-0, ECFE102-0, ECFE201-0, ECFE202-0, ECF061ENS, ECF101ENS, ECF102ENS, ECF201ENS, ECF061E5M, ECF061ECV, ACF/E6-0, ACFE101-0, ACFE102-0, ACFE201-0, ACFE202-0, RCF061E, RCF101E, RCF201E | | |



| | | | |
|--------------------|---|-----------------|--------|
| GEV No. | 370267 | Ref. No. | 0C3254 |
| description | solenoid valve single straight 230VAC inlet 3/4" outlet 11.5mm DN10 EATON (INVENSYS) | | |
| For models: | QPD/G10, QPD/G15, FCZ102EAA, FCZ061EBA, FCZ101EBA, FCZ102EBA, FCZ201EBA, FCZ202EBA, FCZ061EBH, FCZ101EBH, FCZ201EBH, FCZ101EBN, FCZ201EBN, FCZ061EBC, FCZ101EBC, FCZ201EBC, FCZ061GBG, FCZ101GBG, FCZ102GBG, FCZ201GBG, FCZ202GBG, FCZ061GBD, FCZ101GBD, FCZ102GBD, FCZ201GBD, FCZ202GBD, FCZ061GBI, FCZ101GBI, FCZ201GBI, FCZ102ECA, FCF6EHOR, FCF-G10160H, AOS101EBEQ, AOS102EAA1, AOS102EAC1, AOS102EAS1, AOS201EAQ1, AOS102EAM1, AOS102EAB1, AOS102EAK1, AOS102EAT1, AOS202EAT1, AOS101GAQ1, AOS061GAU1, AOS101GAU1, AOS202GAU1, AOS102EBA1, AOS201EBA1, AOS202EBA1, AOS201EBH1...(Other models you can see in the webshop) | | |

RPE

special outlet



| | | | |
|--------------------|---|-----------------|--------|
| GEV No. | 514448 | Ref. No. | 0C6224 |
| description | collector 3-way 230VAC suitable for combi-steamer | | |

solenoid valves with reducers

single



| | | | |
|--------------------|---|-----------------|------------------|
| GEV No. | 698496 | Ref. No. | 0C6225 0C6374 |
| description | water distributor 230VAC RPE for combi-steamer | | |
| For models: | FCZ061EAA, FCZ101EAA, FCZ102EAA, FCZ061EAH, FCZ101EAH, FCZ061EAN, FCZ101EAN, FCZ061ETA, FCZ101ETA, FCZ102ETA, FCZ061ETH, FCZ101ETH, FCZ061ETN, FCZ101ETN, FCZ061GAG, FCZ061GAD, FCZ101GTG, FCZ102GTG, FCZ101GTD, FCZ102GTD, FCZ061EBA, FCZ101EBA, FCZ102EBA, FCZ061EBH, FCZ101EBH, FCZ061EBN, FCZ101EBN, FCZ061EBC, FCZ101EBC, FCZ061EBA2, FCZ101EBA2, FCZ102EBA2, FCZ061EBH2, FCZ101EBH2, FCZ061EBN2, FCZ101EBN2, FCZ061EBC2, FCZ101EBC2, FCZ101GBG2, FCZ102GBG2, FCZ101GBD2, FCZ102GBD2, FCZ101GBI2, FCZ102GBI2, FCZ061ECA, FCZ101ECA, FCZ102ECA, FCZ061ECH, FCZ101ECH, FCZ061ECN...(Other models you can see in the webshop) | | |

TP

















| | | | |
|---|---|-----------------|--------------------------------------|
| GEV No. | 370021 | Ref. No. | 069463 0A6046 0M2265 240003 |
| description | solenoid valve double straight 230VAC inlet 3/4" outlet 11.5mm DN10 TP flow regulating valve inlet white | | |
| For models: | LTB11, LTB11UK, LTB11, 910-00-021, 910-00-023, 910-00-031, 910-00-033, 911-00-022, 911-00-024, 911-00-032, 911-00-034, CRYSTAL 11, BBM 0401, BBM 0402 | | |
| spare parts for | 370021 | | |
|  | GEV No. | 371013 | Ref. No. — |
| accessories for | 370021 | | |
|  | GEV No. | 371220 | Ref. No. — |
|  | GEV No. | 371221 | Ref. No. — |
|  | GEV No. | 371222 | Ref. No. — |
|  | GEV No. | 371223 | Ref. No. 0E5551 |
|  | GEV No. | 371224 | Ref. No. — |
|  | GEV No. | 371225 | Ref. No. — |
|  | GEV No. | 371226 | Ref. No. 0E5526 |
|  | GEV No. | 371230 | Ref. No. — |
|  | GEV No. | 371231 | Ref. No. — |
|  | GEV No. | 371232 | Ref. No. — |
|  | GEV No. | 371233 | Ref. No. — |
|  | GEV No. | 371234 | Ref. No. — |
|  | GEV No. | 371235 | Ref. No. — |

Table continues overleaf



| accessories for | | 370021 | | |
|-----------------|----------|----------|----------|---|
| GEV No. | Ref. No. | Ref. No. | Ref. No. | — |
| | 371236 | | | |
| | 371237 | | | |
| | 371238 | | | |
| | 371239 | | | |
| | 371240 | | | |



| | | | |
|--------------------|---|-----------------|--------|
| GEV No. | 370111 | Ref. No. | OKZ810 |
| description | solenoid valve double straight 24VAC inlet 3/4" outlet 11.5mm DN10 TP | | |
| For models: | EFT1W, WTF2ERC, WTF2ELC, WTF2SRC, WTF2SLC, WTF2HERC, WTF2HEL, WTF2HSRC, WTF2HSLC, WTF3ERC, WTF3ELC, WTF3SRC, WTF3SLC, WTF3HERC, WTF3HEL, WTF3HSRC, WTF3HSLC, WTF2ERB, WTF2ELB, WTF2SRB, WTF2SLB, WTF2HERB, WTF2HELB, WTF2HSRB, WTF2HSLB, WTF3ERB, WTF3ELB, WTF3SRB, WTF3SLB, WTF3HERB, WTF3HELB, WTF3HSRB, WTF3HSLB, WTF4HERB, WTF4HELB, WTF4HSRB, WTF4HSLB, WTF2ERA, WTF2ELA, WTF2SRA, WTF2SLA, WTF2HERA, WTF2HELA, WTF2HSRA, WTF2HSLA, WTF3ERA, WTF3ELA, WTF3SRA, WTF3SLA, WTF3HERA...(Other models you can see in the webshop) | | |

| spare parts for | | 370111 | | |
|-----------------|----------|----------|----------|---|
| GEV No. | Ref. No. | Ref. No. | Ref. No. | — |
| | 371035 | | | |

| accessories for | | 370111 | | |
|-----------------|----------|----------|----------|---|
| GEV No. | Ref. No. | Ref. No. | Ref. No. | — |
| | 371220 | | | |
| | 371221 | | | |
| | 371222 | | | |
| | 371223 | | 0E5551 | |
| | 371224 | | | |
| | 371225 | | | |
| | 371226 | | 0E5526 | |

| accessories for | | 370111 | | |
|-----------------|----------|----------|----------|---|
| GEV No. | Ref. No. | Ref. No. | Ref. No. | — |
| | 371230 | | | |
| | 371231 | | | |
| | 371232 | | | |
| | 371233 | | | |
| | 371234 | | | |
| | 371235 | | | |
| | 371236 | | | |
| | 371237 | | | |
| | 371238 | | | |
| | 371239 | | | |
| | 371240 | | | |

















| | | | |
|--------------------|--|-----------------|----------------------------|
| GEV No. | 370017 | Ref. No. | 070312 20006 9020006 |
| description | solenoid valve single straight 230VAC inlet 3/4" outlet 11.5mm DN10 TP p max 10bar | | |
| For models: | LB035C, LB035R, LB035Q, LB040R, LB040Q, LB040AUS, G350C, LBICEQ010, LBIOEQ010, G350, G350DP, LBIOEQ014, G400, G400DP | | |

| spare parts for | | 370017 | | |
|-----------------|----------|----------|----------|---|
| GEV No. | Ref. No. | Ref. No. | Ref. No. | — |
| | 371013 | | | |

| accessories for | | 370017 | | |
|-----------------|----------|----------|----------|---|
| GEV No. | Ref. No. | Ref. No. | Ref. No. | — |
| | 371220 | | | |
| | 371221 | | | |

Table continues overleaf

| accessories for | | 370017 | | |
|---|--|----------|--------|--|
| GEV No. | 371222 | Ref. No. | — | |
|  | reducer TP flow rate 6l/min grey tolerance ±15% | | | |
| GEV No. | 371223 | Ref. No. | 0E5551 | |
|  | reducer TP flow rate 10l/min white tolerance ±15% | | | |
| GEV No. | 371224 | Ref. No. | — | |
|  | reducer TP flow rate 12l/min bronze tolerance ±15% | | | |
| GEV No. | 371225 | Ref. No. | — | |
|  | reducer TP flow rate 16l/min light brown tolerance ±15% | | | |
| GEV No. | 371226 | Ref. No. | 0E5526 | |
|  | reducer TP flow rate 20l/min red tolerance ±15% | | | |
| GEV No. | 371230 | Ref. No. | — | |
|  | reducer TP flow rate 0.25l/min red tolerance ±25% | | | |
| GEV No. | 371231 | Ref. No. | — | |
|  | reducer TP flow rate 0.35l/min violet tolerance ±25% | | | |
| GEV No. | 371232 | Ref. No. | — | |
|  | reducer TP flow rate 0.5l/min orange tolerance ±25% | | | |
| GEV No. | 371233 | Ref. No. | — | |
|  | reducer TP flow rate 0.8l/min white tolerance ±25% | | | |
| GEV No. | 371234 | Ref. No. | — | |
|  | reducer TP flow rate 1l/min light blue tolerance ±25% | | | |
| GEV No. | 371235 | Ref. No. | — | |
|  | reducer TP flow rate 1.2l/min brown tolerance ±25% | | | |
| GEV No. | 371236 | Ref. No. | — | |
|  | reducer TP flow rate 1.5l/min light brown tolerance ±25% | | | |
| GEV No. | 371237 | Ref. No. | — | |
|  | reducer TP flow rate 2.5l/min yellow tolerance ±25% | | | |
| GEV No. | 371238 | Ref. No. | — | |
|  | reducer TP flow rate 3.4l/min dark green tolerance ±25% | | | |
| GEV No. | 371239 | Ref. No. | — | |
|  | reducer TP flow rate 5l/min black tolerance ±25% | | | |
| GEV No. | 371240 | Ref. No. | — | |
|  | reducer TP flow rate 8l/min blue tolerance ±20% | | | |

|  | | | |
|--|---|----------|--------|
| 1 | | | |
| GEV No. | 370655 | Ref. No. | 047533 |
| description | solenoid valve single straight 230VAC inlet 3/4" outlet 11.5mm DN10 TP plastic flow regulating valve inlet pink 8VA | | |
| For models: | LB110E | | |

















|  | | | |
|---|---|----------|----------|
| 1 | | | |
| GEV No. | 370029 | Ref. No. | 058996 |
| description | solenoid valve single straight 24VAC inlet 3/4" outlet 11.5mm DN10 TP flow regulating valve inlet white | | |
| For models: | FCVE10-P, FCVE10PUK, FCVG10-P, FCVG10PUK, FCVE20-P, FCVE20PUK, FCVG20-P, FCVG20PUK | | |
| accessories for | 370029 | | |
|  | GEV No. | 371035 | Ref. No. |
| solenoid coil 24VAC | | | |
| accessories for | 370029 | | |
|  | GEV No. | 371220 | Ref. No. |
| reducer TP flow rate 3l/min red tolerance ±15% | | | |
|  | GEV No. | 371221 | Ref. No. |
| reducer TP flow rate 5.5l/min yellow tolerance ±15% | | | |
|  | GEV No. | 371222 | Ref. No. |
| reducer TP flow rate 6l/min grey tolerance ±15% | | | |
|  | GEV No. | 371223 | Ref. No. |
| reducer TP flow rate 10l/min white tolerance ±15% | | | |
|  | GEV No. | 371224 | Ref. No. |
| reducer TP flow rate 12l/min bronze tolerance ±15% | | | |
|  | GEV No. | 371225 | Ref. No. |
| reducer TP flow rate 16l/min light brown tolerance ±15% | | | |
|  | GEV No. | 371226 | Ref. No. |
| reducer TP flow rate 20l/min red tolerance ±15% | | | |
|  | GEV No. | 371230 | Ref. No. |
| reducer TP flow rate 0.25l/min red tolerance ±25% | | | |
|  | GEV No. | 371231 | Ref. No. |
| reducer TP flow rate 0.35l/min violet tolerance ±25% | | | |
|  | GEV No. | 371232 | Ref. No. |
| reducer TP flow rate 0.5l/min orange tolerance ±25% | | | |

Table continues overleaf





















| accessories for | | 370029 | | |
|---|----------|----------|----------|--|
| GEV No. | Ref. No. | Ref. No. | Ref. No. | — |
|  | 371233 | Ref. No. | — | reducer TP flow rate 0.8l/min white tolerance ±25% |
|  | 371234 | Ref. No. | — | reducer TP flow rate 1l/min light blue tolerance ±25% |
|  | 371235 | Ref. No. | — | reducer TP flow rate 1.2l/min brown tolerance ±25% |
|  | 371236 | Ref. No. | — | reducer TP flow rate 1.5l/min light brown tolerance ±25% |
|  | 371237 | Ref. No. | — | reducer TP flow rate 2.5l/min yellow tolerance ±25% |
|  | 371238 | Ref. No. | — | reducer TP flow rate 3.4l/min dark green tolerance ±25% |
|  | 371239 | Ref. No. | — | reducer TP flow rate 5l/min black tolerance ±25% |
|  | 371240 | Ref. No. | — | reducer TP flow rate 8l/min blue tolerance ±20% |

















| | | | | |
|--------------------|--|-----------------|------------------|--|
| 1 | | | | |
| GEV No. | 370032 | Ref. No. | 0E5070 OKI409 | |
| description | solenoid valve single straight 24VAC inlet 3/4" outlet 14mm DN10 TP flow regulating valve inlet white | | | |
| For models: | WTF2ERC, WTF2ELC, WTF2SRC, WTF2SLC, WTF2HERC, WTF2HELC, WTF2HSRC, WTF2HSLC, WTF3ERC, WTF3ELC, WTF3SRC, WTF3SLC, WTF3HERC, WTF3HELC, WTF3HSRC, WTF3HSLC, WTF2ERB, WTF2ELB, WTF2SRB, WTF2SLB, WTF2HERB, WTF2HELB, WTF2HSRB, WTF2HSLB, WTF3ERB, WTF3ELB, WTF3SRB, WTF3SLB, WTF3HERB, WTF3HELB, WTF3HSRB, WTF3HSLB, WTF4HERB, WTF4HELB, WTF4HSRB, WTF4HSLB, WTF2ERA, WTF2ELA, WTF2SRA, WTF2SLA, WTF2HERA, WTF2HELA, WTF2HSRA, WTF2HSLA, WTF3ERA, WTF3ELA, WTF3SRA, WTF3SLA, WTF3HERA, WTF3HELA...(Other models you can see in the webshop) | | | |





| spare parts for | | 370032 | | |
|---|----------|----------|----------|---------------------|
| GEV No. | Ref. No. | Ref. No. | Ref. No. | — |
|  | 371035 | Ref. No. | — | solenoid coil 24VAC |

| accessories for | | 370032 | | |
|---|----------|----------|----------|---|
| GEV No. | Ref. No. | Ref. No. | Ref. No. | — |
|  | 371220 | Ref. No. | — | reducer TP flow rate 3l/min red tolerance ±15% |
|  | 371221 | Ref. No. | — | reducer TP flow rate 5.5l/min yellow tolerance ±15% |
|  | 371222 | Ref. No. | — | reducer TP flow rate 6l/min grey tolerance ±15% |
|  | 371223 | Ref. No. | 0E5551 | reducer TP flow rate 10l/min white tolerance ±15% |

| accessories for | | 370032 | | |
|---|----------|----------|----------|--|
| GEV No. | Ref. No. | Ref. No. | Ref. No. | — |
|  | 371224 | Ref. No. | — | reducer TP flow rate 12l/min bronze tolerance ±15% |
|  | 371225 | Ref. No. | — | reducer TP flow rate 16l/min light brown tolerance ±15% |
|  | 371226 | Ref. No. | 0E5526 | reducer TP flow rate 20l/min red tolerance ±15% |
|  | 371230 | Ref. No. | — | reducer TP flow rate 0.25l/min red tolerance ±25% |
|  | 371231 | Ref. No. | — | reducer TP flow rate 0.35l/min violet tolerance ±25% |
|  | 371232 | Ref. No. | — | reducer TP flow rate 0.5l/min orange tolerance ±25% |
|  | 371233 | Ref. No. | — | reducer TP flow rate 0.8l/min white tolerance ±25% |
|  | 371234 | Ref. No. | — | reducer TP flow rate 1l/min light blue tolerance ±25% |
|  | 371235 | Ref. No. | — | reducer TP flow rate 1.2l/min brown tolerance ±25% |
|  | 371236 | Ref. No. | — | reducer TP flow rate 1.5l/min light brown tolerance ±25% |
|  | 371237 | Ref. No. | — | reducer TP flow rate 2.5l/min yellow tolerance ±25% |
|  | 371238 | Ref. No. | — | reducer TP flow rate 3.4l/min dark green tolerance ±25% |
|  | 371239 | Ref. No. | — | reducer TP flow rate 5l/min black tolerance ±25% |
|  | 371240 | Ref. No. | — | reducer TP flow rate 8l/min blue tolerance ±20% |



| | | | |
|--|---|-----------------|----------------------------|
|   1 | | | |
| GEV No. | 370025 | Ref. No. | 069464 0A6045 240002 |
| description | solenoid valve triple straight 230VAC inlet 3/4" outlet 11.5mm DN10 TP | | |
| For models: | LTB12, LTB22, LTB12UK, LTB22UK, LTB22, 910-00-021, 910-00-023, 910-00-031, 910-00-033, 911-00-022, 911-00-024, 911-00-032, 911-00-034, CRYSTAL 22 | | |
| spare parts for | 370025 | | |
|  | GEV No. | 371013 | Ref. No. — |
| | solenoid coil TP 230VAC 50/60Hz | | |
| accessories for | 370025 | | |
|  | GEV No. | 371220 | Ref. No. — |
| | reducer TP flow rate 3l/min red tolerance ±15% | | |
|  | GEV No. | 371221 | Ref. No. — |
| | reducer TP flow rate 5.5l/min yellow tolerance ±15% | | |
|  | GEV No. | 371222 | Ref. No. — |
| | reducer TP flow rate 6l/min grey tolerance ±15% | | |
|  | GEV No. | 371223 | Ref. No. 0E5551 |
| | reducer TP flow rate 10l/min white tolerance ±15% | | |
|  | GEV No. | 371224 | Ref. No. — |
| | reducer TP flow rate 12l/min bronze tolerance ±15% | | |
|  | GEV No. | 371225 | Ref. No. — |
| | reducer TP flow rate 16l/min light brown tolerance ±15% | | |
|  | GEV No. | 371226 | Ref. No. 0E5526 |
| | reducer TP flow rate 20l/min red tolerance ±15% | | |
|  | GEV No. | 371230 | Ref. No. — |
| | reducer TP flow rate 0.25l/min red tolerance ±25% | | |
|  | GEV No. | 371231 | Ref. No. — |
| | reducer TP flow rate 0.35l/min violet tolerance ±25% | | |
|  | GEV No. | 371232 | Ref. No. — |
| | reducer TP flow rate 0.5l/min orange tolerance ±25% | | |
|  | GEV No. | 371233 | Ref. No. — |
| | reducer TP flow rate 0.8l/min white tolerance ±25% | | |
|  | GEV No. | 371234 | Ref. No. — |
| | reducer TP flow rate 1l/min light blue tolerance ±25% | | |
|  | GEV No. | 371235 | Ref. No. — |
| | reducer TP flow rate 1.2l/min brown tolerance ±25% | | |

| | | | |
|---|--|--------|-------------------|
| accessories for | 370025 | | |
|  | GEV No. | 371236 | Ref. No. — |
| | reducer TP flow rate 1.5l/min light brown tolerance ±25% | | |
|  | GEV No. | 371237 | Ref. No. — |
| | reducer TP flow rate 2.5l/min yellow tolerance ±25% | | |
|  | GEV No. | 371238 | Ref. No. — |
| | reducer TP flow rate 3.4l/min dark green tolerance ±25% | | |
|  | GEV No. | 371239 | Ref. No. — |
| | reducer TP flow rate 5l/min black tolerance ±25% | | |
|  | GEV No. | 371240 | Ref. No. — |
| | reducer TP flow rate 8l/min blue tolerance ±20% | | |









































| | | | |
|---|--|-----------------|------------------------|
|   1 | | | |
| GEV No. | 370019 | Ref. No. | 0H6403 370020 |
| description | solenoid valve double angled 230VAC inlet 3/4" outlet 11.5mm DN10 TP plastic | | |
| spare parts for | 370019 | | |
|  | GEV No. | 371013 | Ref. No. — |
| | solenoid coil TP 230VAC 50/60Hz | | |
| accessories for | 370019 | | |
|  | GEV No. | 371220 | Ref. No. — |
| | reducer TP flow rate 3l/min red tolerance ±15% | | |
|  | GEV No. | 371221 | Ref. No. — |
| | reducer TP flow rate 5.5l/min yellow tolerance ±15% | | |
|  | GEV No. | 371222 | Ref. No. — |
| | reducer TP flow rate 6l/min grey tolerance ±15% | | |
|  | GEV No. | 371223 | Ref. No. 0E5551 |
| | reducer TP flow rate 10l/min white tolerance ±15% | | |
|  | GEV No. | 371224 | Ref. No. — |
| | reducer TP flow rate 12l/min bronze tolerance ±15% | | |
|  | GEV No. | 371225 | Ref. No. — |
| | reducer TP flow rate 16l/min light brown tolerance ±15% | | |
|  | GEV No. | 371226 | Ref. No. 0E5526 |
| | reducer TP flow rate 20l/min red tolerance ±15% | | |
|  | GEV No. | 371230 | Ref. No. — |
| | reducer TP flow rate 0.25l/min red tolerance ±25% | | |
|  | GEV No. | 371231 | Ref. No. — |
| | reducer TP flow rate 0.35l/min violet tolerance ±25% | | |

Table continues overleaf















| accessories for | | 370019 | | |
|--|---------|--------|----------|---|
|  | GEV No. | 371232 | Ref. No. | — |
| reducer TP flow rate 0.5l/min orange tolerance ±25% | | | | |
|  | GEV No. | 371233 | Ref. No. | — |
| reducer TP flow rate 0.8l/min white tolerance ±25% | | | | |
|  | GEV No. | 371234 | Ref. No. | — |
| reducer TP flow rate 1l/min light blue tolerance ±25% | | | | |
|  | GEV No. | 371235 | Ref. No. | — |
| reducer TP flow rate 1.2l/min brown tolerance ±25% | | | | |
|  | GEV No. | 371236 | Ref. No. | — |
| reducer TP flow rate 1.5l/min light brown tolerance ±25% | | | | |
|  | GEV No. | 371237 | Ref. No. | — |
| reducer TP flow rate 2.5l/min yellow tolerance ±25% | | | | |
|  | GEV No. | 371238 | Ref. No. | — |
| reducer TP flow rate 3.4l/min dark green tolerance ±25% | | | | |
|  | GEV No. | 371239 | Ref. No. | — |
| reducer TP flow rate 5l/min black tolerance ±25% | | | | |
|  | GEV No. | 371240 | Ref. No. | — |
| reducer TP flow rate 8l/min blue tolerance ±20% | | | | |

|   1 | | | | |
|--|---|-----------------|------------------|--------|
| GEV No. | 370015 | Ref. No. | 002613 OK1524 | |
| description | solenoid valve single angled 230VAC inlet 3/4" outlet 11.5mm DN10 TP | | | |
| For models: | FCV/G10L3, FCVG10L3T, FCVG102L3, FCV/E101/1, FCV/G20L3, FCV/E10L3JAP, FCV/E102/1L3JAP, FCV/E10L6JAP, FCV/E102/1L6JAP, FCVG10L3J, FCVG102L3J, FCV/G10L6JAP, FCV/G102/1L6JAP, FCVG6L3CJ, FCV/G10L2, FCV/E101/1, FCV/E101/1, FCV/E10L2, FCV/E102/1, FCV/E101/1, FCV/E101/2, FCV/G6L3C, FCV/G61/1, FCV/G61/1, FCV/G61/1, FCV/G61/1, FCVG6L3CT, FCVG6L3CJ, FCV/E10L3, FCV/E102/1, FCV/E102/1L3, FCV/E20L3, FCV/E101/1, FCV/G10L6, FCV/E10L6, FCV/G102/1L6, FCV/E102/1L6, FCV/G20L6, FCV/E20L6, FCV/E101/1, FCV/G101/1, FVC/E101/1, FCV/G102/1, FVC/E102/1, FCV/G201/1, FVC/E201/1, FCF/G6-0, FCF/E6-0, FCF061ELN, FCF/G6-1-JAP.. (Other models you can see in the webshop) | | | |
| accessories for | | 370015 | | |
|  | GEV No. | 371220 | Ref. No. | — |
| reducer TP flow rate 3l/min red tolerance ±15% | | | | |
|  | GEV No. | 371221 | Ref. No. | — |
| reducer TP flow rate 5.5l/min yellow tolerance ±15% | | | | |
|  | GEV No. | 371222 | Ref. No. | — |
| reducer TP flow rate 6l/min grey tolerance ±15% | | | | |
|  | GEV No. | 371223 | Ref. No. | 0E5551 |
| reducer TP flow rate 10l/min white tolerance ±15% | | | | |

| accessories for | | 370015 | | |
|---|---------|--------|----------|--------|
|  | GEV No. | 371224 | Ref. No. | — |
| reducer TP flow rate 12l/min bronze tolerance ±15% | | | | |
|  | GEV No. | 371225 | Ref. No. | — |
| reducer TP flow rate 16l/min light brown tolerance ±15% | | | | |
|  | GEV No. | 371226 | Ref. No. | 0E5526 |
| reducer TP flow rate 20l/min red tolerance ±15% | | | | |
|  | GEV No. | 371230 | Ref. No. | — |
| reducer TP flow rate 0.25l/min red tolerance ±25% | | | | |
|  | GEV No. | 371231 | Ref. No. | — |
| reducer TP flow rate 0.35l/min violet tolerance ±25% | | | | |
|  | GEV No. | 371232 | Ref. No. | — |
| reducer TP flow rate 0.5l/min orange tolerance ±25% | | | | |
|  | GEV No. | 371233 | Ref. No. | — |
| reducer TP flow rate 0.8l/min white tolerance ±25% | | | | |
|  | GEV No. | 371234 | Ref. No. | — |
| reducer TP flow rate 1l/min light blue tolerance ±25% | | | | |
|  | GEV No. | 371235 | Ref. No. | — |
| reducer TP flow rate 1.2l/min brown tolerance ±25% | | | | |
|  | GEV No. | 371236 | Ref. No. | — |
| reducer TP flow rate 1.5l/min light brown tolerance ±25% | | | | |
|  | GEV No. | 371237 | Ref. No. | — |
| reducer TP flow rate 2.5l/min yellow tolerance ±25% | | | | |
|  | GEV No. | 371238 | Ref. No. | — |
| reducer TP flow rate 3.4l/min dark green tolerance ±25% | | | | |
|  | GEV No. | 371239 | Ref. No. | — |
| reducer TP flow rate 5l/min black tolerance ±25% | | | | |
|  | GEV No. | 371240 | Ref. No. | — |
| reducer TP flow rate 8l/min blue tolerance ±20% | | | | |



| | | | |
|---|--|-----------------|---|
|  | | | |
|  | | | |
| 1 | | | |
| GEV No. | 370016 | Ref. No. | 045701 046320 047466 047529 047531 047532 047843 048178 048179 048571 048894 069178 069179 0T3867 319536 696609700 |
| description | solenoid valve single angled 230VAC inlet 3/4" outlet 14mm DN10 TP | | |
| For models: | RBR/E700, RBR/E700, LB120EPH, LB120E, LB160EPH, LB160E, LB160V, CLB160E, CLB160V, LB110E, LS500F, LS501F, LS540F, LS540DK, LS541F, LS720F, LSE720DK, LSE720PH, LS860F, LS860DK, LS860PH, LS1080F, LS1080UK, LS1080PH, LSE721F, LS861F, LS540, LS1080M, LS1080, LS1080D, LS1080UK, LS1080/63, LS500F, LS500UK, LS501, LS501UK, LS540D, LS540/63, LSE721, LS720, LSE720UK, LS721UK, LSE720D, LS541, LS860, LS860, LS860D, LS860UK, LS861UK, LS860/63...(Other models you can see in the webshop) | | |
| accessories for | 370016 | | |
|  | GEV No. | 371220 | Ref. No. — |
| reducer TP flow rate 3l/min red tolerance ±15% | | | |
|  | GEV No. | 371221 | Ref. No. — |
| reducer TP flow rate 5.5l/min yellow tolerance ±15% | | | |
|  | GEV No. | 371222 | Ref. No. — |
| reducer TP flow rate 6l/min grey tolerance ±15% | | | |
|  | GEV No. | 371223 | Ref. No. 0E5551 |
| reducer TP flow rate 10l/min white tolerance ±15% | | | |
|  | GEV No. | 371224 | Ref. No. — |
| reducer TP flow rate 12l/min bronze tolerance ±15% | | | |
|  | GEV No. | 371225 | Ref. No. — |
| reducer TP flow rate 16l/min light brown tolerance ±15% | | | |
|  | GEV No. | 371226 | Ref. No. 0E5526 |
| reducer TP flow rate 20l/min red tolerance ±15% | | | |
|  | GEV No. | 371230 | Ref. No. — |
| reducer TP flow rate 0.25l/min red tolerance ±25% | | | |
|  | GEV No. | 371231 | Ref. No. — |
| reducer TP flow rate 0.35l/min violet tolerance ±25% | | | |
|  | GEV No. | 371232 | Ref. No. — |
| reducer TP flow rate 0.5l/min orange tolerance ±25% | | | |

| | | | |
|--|---------|--------|------------|
| accessories for | 370016 | | |
|  | GEV No. | 371233 | Ref. No. — |
| reducer TP flow rate 0.8l/min white tolerance ±25% | | | |
|  | GEV No. | 371234 | Ref. No. — |
| reducer TP flow rate 1l/min light blue tolerance ±25% | | | |
|  | GEV No. | 371235 | Ref. No. — |
| reducer TP flow rate 1.2l/min brown tolerance ±25% | | | |
|  | GEV No. | 371236 | Ref. No. — |
| reducer TP flow rate 1.5l/min light brown tolerance ±25% | | | |
|  | GEV No. | 371237 | Ref. No. — |
| reducer TP flow rate 2.5l/min yellow tolerance ±25% | | | |
|  | GEV No. | 371238 | Ref. No. — |
| reducer TP flow rate 3.4l/min dark green tolerance ±25% | | | |
|  | GEV No. | 371239 | Ref. No. — |
| reducer TP flow rate 5l/min black tolerance ±25% | | | |
|  | GEV No. | 371240 | Ref. No. — |
| reducer TP flow rate 8l/min blue tolerance ±20% | | | |
|  | GEV No. | 503139 | Ref. No. — |
| solenoid valve filter ø 19.5mm H 16mm | | | |





















| | | | |
|--|---|-----------------|------------------|
|  | | | |
| 1 | | | |
| GEV No. | 370031 | Ref. No. | 0H2513 0L0175 |
| description | solenoid valve single angled 24VAC inlet 3/4" outlet 14mm DN10 TP | | |
| For models: | PW1EFL, PW1EFL, PW1EFL/60HZ, PW2EFL, PW2EFL, PW2EFL/60HZ, PW2VFL, WT830EFL, WT830EFL, WT830EFL/60HZ, WT850, WT850EFL, WT850EFL/60HZ, WT850SFL, FT36ED, FT36ES, FT36VD, FT36VS, FT50ED, FT50ES, FT50VD, FT50VS, FT72ED, FT72ES, FT72VD, FT72VS, FT36EDT, FT36EST, FT36VDT, FT36VST, FT50EDT, FT50EST, FT50VDT, FT50VST, FT72EDT, FT72EST, FT72VDT, FT72VST, FT36EDTS, FT36ESTS, FT36VDTS, FT36VSTS, FT36ED, FT36ES, FT36VD, FT36VS, FT50ED, FT50ES, FT50VD, FT50VS...(Other models you can see in the webshop) | | |
| spare parts for | 370031 | | |
|  | GEV No. | 371035 | Ref. No. — |
| solenoid coil 24VAC | | | |
| accessories for | 370031 | | |
|  | GEV No. | 371220 | Ref. No. — |
| reducer TP flow rate 3l/min red tolerance ±15% | | | |
|  | GEV No. | 371221 | Ref. No. — |
| reducer TP flow rate 5.5l/min yellow tolerance ±15% | | | |
|  | GEV No. | 371222 | Ref. No. — |
| reducer TP flow rate 6l/min grey tolerance ±15% | | | |

Table continues overleaf



| accessories for | | 370031 | | |
|---|--|--------|----------|--------|
| GEV No. | | 371223 | Ref. No. | 0E5551 |
|  | reducer TP flow rate 10l/min white tolerance ±15% | | | |
|  | reducer TP flow rate 12l/min bronze tolerance ±15% | | | |
|  | reducer TP flow rate 16l/min light brown tolerance ±15% | | | |
|  | reducer TP flow rate 20l/min red tolerance ±15% | | | |
|  | reducer TP flow rate 0.25l/min red tolerance ±25% | | | |
|  | reducer TP flow rate 0.35l/min violet tolerance ±25% | | | |
|  | reducer TP flow rate 0.5l/min orange tolerance ±25% | | | |
|  | reducer TP flow rate 0.8l/min white tolerance ±25% | | | |
|  | reducer TP flow rate 1l/min light blue tolerance ±25% | | | |
|  | reducer TP flow rate 1.2l/min brown tolerance ±25% | | | |
|  | reducer TP flow rate 1.5l/min light brown tolerance ±25% | | | |
|  | reducer TP flow rate 2.5l/min yellow tolerance ±25% | | | |
|  | reducer TP flow rate 3.4l/min dark green tolerance ±25% | | | |
|  | reducer TP flow rate 5l/min black tolerance ±25% | | | |
|  | reducer TP flow rate 8l/min blue tolerance ±20% | | | |

solenoid valves with reducers

|  | | | |
|--|--|----------|------------------|
| 1 | | | |
| GEV No. | 370437 | Ref. No. | 085328 099773 |
| description | solenoid valve double angled 230VAC inlet 3/4" input 10l/min output 1.2l/min DN10 t.max. 90°C TP plastic flow regulating valve inlet white outlet 11.5mm output A 1.2l/min output B 1.2l/min flow regulating valve outlet A dark brown flow regulating valve outlet B dark brown | | |
| For models: | IMF28A, IMF28W, FGC46AS42, CIM50AB, FIM50WB, CIM50AB, FIM50WB, CB425A, CIM50AB, FIM50WB, IF29W, IF55W, IF75W, IF30W, IF29A, IF30A, IF55A, IF75A | | |

|  | | | |
|---|---|----------|--------|
| 1 | | | |
| GEV No. | 370337 | Ref. No. | 056872 |
| description | solenoid valve double angled 230VAC inlet 3/4" plastic outlet 11.5mm output A 8l/min output B 0.6l/min flow regulating valve outlet A dark blue flow regulating valve outlet B orange | | |
| For models: | MCP/E700, MCP/G700, MCP/E700D, RCP/E2S, MCP/E1SH, MCP/E1SUH, MCP/E2SUHS, MCP/E2S, MCP/E2SH, MCP/E2SUH, MCP/E2SUT, MCP/E2SHB, M70GPC, RCP/G700, RCPE700, HCP/G410D, HCP/G410, HCP/G810, HCP/E410, HCP/E810, HCPS/E410, ACP/G400, ACP/G410, ACP/G800, ACP/G810, ACP/E400, ACP/E410, ACP/E800, ACP/E810, ACPS/G400, ACPS/E400, ACPS/E410 | | |

|  | | | |
|--|--|----------|--------|
| 1 | | | |
| GEV No. | 370343 | Ref. No. | 055444 |
| description | solenoid valve double angled 230VAC inlet 3/4" t.max. 90°C TP plastic outlet 11.5mm output B 1l/min flow regulating valve outlet B light blue | | |
| For models: | FDV40G, FDV40GZ, FDV40GA, FDV20G, FDV20E, FDV20GZ, FDV20EL, FDV20GA, FCV/G10L3, FCVG10L3T, FCVG102L3, FCV/G20L3, FCVG202L3, FCV/E10L3JAP, FCV/E102/1L3JAP, FCVG10L3J, FCVG102L3J, FCV/E101/1, FCV/E101/2, FCV/G61/1, FCV/E10L3, FCV/E102/1, FCV/E102/1L3, FCV/E20L3, FCVG202L6, FCV/G201/1, FCS101E44J, FCS101E4, FCS102E44J, FCS102E4, FCS201G4, FCS202GP, FCVG6-1, FCVG6-3, FCVG6-1UK, FCVG6-3UK, FCVE10-2, FCVE10-4, FCVE10-2UK, FCVE10-4UK, FCVG10-2, FCVG10-4, FCVG10-2UK, FCVG10-4UK, FCVE20-2, FCVE20-4, FCVE20-2UK, FCVE20-4UK, FCVG20-2, FCVG20-4...(Other models you can see in the webshop) | | |



1





| | | | |
|--------------------|--|-----------------|----------------------------|
| GEV No. | 370342 | Ref. No. | 046654 047579 057814 |
| description | solenoid valve double straight 230VAC inlet 3/4" input 16l/min t.max. 90°C TP plastic flow regulating valve inlet light brown outlet 11.5mm output B 0.25l/min flow regulating valve outlet B red | | |
| For models: | FCV/G6L3TOWNGAS, FCV/G6L3, FCV/E101/1, FCVE6L3J, FCV/G6L3JAP, FCVG6L3CJ, FCV/E61/1, FCV/G10L2, FCV/E10L2, FCV/E61/1, FCV/G6L3C, FCV/G61/1, FCVG6L3CT, FCVG6L3CJ, FCV/E6L3, FCV/E101/1, FCS061E44J, FCS061G48J, FCS061G3DI, FCS061E3CI, FCS101E2, FCS061G4DT, FCS061G49J, FCS101G2, FCVG10-ISG, ECV/G6T4C, ECV/E10IGP, LSDS5I, LSDS5V, RCV061G2, RCV061E2, RCV101G2, RCV101E2, ACV/G10C2, ACV/E10C2, ACV/G6C3, ACV/G6C3C, ACV/E6C3, NCV/G6L2, NCV/G10L2, NCV/E6L2, NCV/E10L2, FCVG10-ISG, ZCV/G6T4C | | |

1



| | | | |
|--------------------|---|-----------------|----------------------------|
| GEV No. | 370339 | Ref. No. | 0A2064 0K2983 0KM766 |
| description | solenoid valve single angled 230VAC inlet 3/4" outlet 11.5mm output 1l/min t.max. 90°C TP plastic flow regulating valve outlet light blue | | |

1

| | | | |
|--------------------|---|-----------------|------------------|
| GEV No. | 370660 | Ref. No. | 0H2505 0K8195 |
| description | solenoid valve double straight 230VAC inlet 3/4" input 5.5l/min 10 t. max. 90°C TP plastic flow regulating valve inlet yellow outlet 11.5mm output B 0.25l/min flow regulating valve outlet B red | | |
| For models: | AR6ES, AR10ES, AR10ES, AR10ES, AR10ES, AR10ES, AR10ES, AR10ES, AR10ES, AR10ESP, AR10ESP, AR10ESP, AR10ESP, AR10ESP, AR10ESP, AR10ESP, AR10ES, AR10ES, AR10ES, AR10ES, AR10ES, AR10ES, AR10ES, AR10ESP, AR10ESP, AR10ESP, AR10ESP, AR10ESP, AR10ESP, AR10ESP, AR10ESP, AR10ESP, AR10ESP... (Other models you can see in the webshop) | | |

1



| | | | |
|--------------------|---|-----------------|--|
| GEV No. | 370656 | Ref. No. | 046507 046633 047530 047756 068674 |
| description | solenoid valve single straight 230VAC inlet 3/4" outlet 11.5mm 10 TP plastic flow regulating valve inlet green | | |
| For models: | LS360F, LS360DK, LS365F, LS365, LS365PH, LS360D, LS365D, LS360, LS365, LS360/63, LS365/63, LS367, LS360, LS365F, HB3PNT | | |

1



| | | | |
|--------------------|---|-----------------|-------------------------------------|
| GEV No. | 370427 | Ref. No. | 055350 085327 0KK221 23001 |
| description | solenoid valve single angled 230VAC inlet 3/4" outlet 11.5mm input/ min output 1.2l/min DN10 t.max. 90°C TP plastic flow regulating valve outlet dark brown | | |
| For models: | MBR/G710D, MBR/E710D, MBR/E700, MBR/E700UK, MBR/E716, MBR/E706, RBR/G710D, 7BRE60XN, 7BRE60X, RBR/E700UK, RBR/E716, RBR/E706, XBR/E710D, M70EBP, XBR/E710, XBR/G751, XBR/G756, CBR/E700, XBR/E716, XBR/E706, FCVE6-1U, FCVE6-3U, FCVE6-1, FCVE6-3, FCVE6-1UK, FCVE6-3UK, FCVE10-2, FCVE10-4, FCVE10-2UK, FCVE10-4UK, FCVE20-2, FCVE20-4, FCVE20-2UK, FCVE20-4UK, FCV/E6-1, FCV/E6-1, ZOFCV/E102, ZOFCV/E104, ZOFCV/E202, ZOFCV/E204 | | |

1





| | | | |
|--------------------|---|-----------------|--------|
| GEV No. | 370341 | Ref. No. | 002753 |
| description | solenoid valve single straight 230VAC inlet 3/4" outlet 11.5mm output 1l/min t.max. 90°C TP plastic flow regulating valve outlet light blue output A 1l/min | | |
| For models: | FCV/G6L3TOWNGAS, FCV/G6L3, FCVE6L3J, FCV/G6L3JAP, FCV/E61/1, FCV/E61/1, FCV/E61/1, FCV/E61/1, FCV/E6L3, FCV/G6L4, FCV/E6L4, FCS061E44J, FCS061EP, FCS061E3CI, FCS061E4, FCS061EXLN, FCS061EX, 5711-2-6, 5711-2-7, 5711-2-8, 5711-2-10, 5711-2-8CH, 5711-2-10CH, 5711-2-6L, 5711-2-7L, 5711-2-8L, 5711-2-10L, 5711-3-6, 5711-3-7, 5711-3-8, 5711-3-10, 5711-3-8CH, 5711-3-10CH, 5711-3-10F, 5711-3-10S, ECV/G6T4, ECV/E6T4, RCV061E2, RCV061E4, ACV/G6C3, ACV/E6C3, NCV/G6L2, NCV/E6L2, ZCV/G6T4, ZCV/E6T4 | | |





| | | | |
|---|--|-----------------|--|
|  | | | |
| 1 | | | |
| GEV No. | 370344 | Ref. No. | 002712 047539 047540 069296 OK1519 OK1523 |
| description | solenoid valve triple angled 230VAC inlet 3/4" outlet 11.5mm t.max. 90°C TP 22507P plastic output B 0.25l/min output C 1l/min flow regulating valve outlet B red flow regulating valve outlet C light blue | | |
| For models: | FCVG202L3, FCV/E10L6JAP, FCV/E102/1L6JAP, FCV/G10L6JAP, FCV/G102/1L6JAP, FCV/E61/1, FCV/E101/1, FCV/E102/1, FCV/E61/1, FCV/E101/1, FCV/G61/1, FCV/G61/1, FCV/E6L4, FCV/G10L6, FCV/E10L6, FCV/G102/1L6, FCV/E102/1L6, FCV/G20L6, FCV/E20L6, FCVG202L6, FCV/E101/1, FCV/G101/1, FVC/E101/1, FCV/G102/1, FVC/E102/1, FCV/G201/1, FVC/E201/1, FCV/G202/1, FCS061GP, FCS061EP, FCS061G4, FCS101EP4J, FCS101G4, FCS101EP, FCS101G4DT, FCS101GP9J, FCS102EP4J, FCS101G49J, FCS101GP, FCS102EP, FCS102G4, FCS201E4, FCS102GA9J, FCS201EP, FCS102G49J, FCS102GP, FCS201GP, FCS202G4, FCS202GP, FCS061E4...(Other models you can see in the webshop) | | |

| | | | |
|--|--|-----------------|--------|
|  | | | |
| 2 | | | |
| GEV No. | 370347 | Ref. No. | 0A2415 |
| description | solenoid valve triple angled 24V inlet 3/4" outlet 11.5mm plastic output C 1l/min | | |
| For models: | FCVE103CE, FCVE203CE, FCVE10-P, FCVE10PUK, FCVG10-P, FCVG10PUK, FCVE20-P, FCVE20PUK, FCVG20-P, FCVG20PUK, AFCV/G6-1, AFCV/G6-3, SCO/G6-3, AFCV/G101, AFCV/G103, SCO/G10-3, AFCV/G201, AFCV/G203, SCO/G20-3 | | |

| | | | |
|---|--|-----------------|--------|
|  | | | |
| 1 | | | |
| GEV No. | 370658 | Ref. No. | OK8035 |
| description | solenoid valve triple straight 230VAC inlet 3/4" outlet 11.5mm input 5.5l/min 10 t.max. 90°C TP plastic flow regulating valve inlet yellow output A 1l/min output C 0.25l/min flow regulating valve outlet A light blue flow regulating valve outlet C red | | |
| For models: | AR6ES, AR6ES, AR6ES, AR6ES, AR6ES, AR6ES, AR6ES, AR6ES, AR6ES, AR6ES, AR6ES, AR6ES, AR6ES, AR10ES, AR10ES, AR10ES, AR10ES, AR10ES, AR10ES, AR10ESP, AR10ESP, AR10ESP, AR10ESP, AR10ES, AR10ES, AR10ES, AR10ES, AR10ES, AR10ES, AR10ESP, AR10ESP, AR10ESP, AR10ESP, AR10ESP, AR10ESP, AR10ESP, AR10ESP, AR10ESP, AR10ESP, AR10ESP...(Other models you can see in the webshop) | | |

| | | | |
|--|--|-----------------|------------------|
|  | | | |
| 1 | | | |
| GEV No. | 370250 | Ref. No. | 047538 0E0330 |
| description | solenoid valve triple straight 230VAC inlet 3/4" outlet 11.5mm t.max. 90°C TP 22507P plastic output B 0.25l/min flow regulating valve outlet B red | | |
| For models: | LCS5, LB70E, LB110E, LB70E, LCSZ | | |

| | | | |
|--|---|-----------------|------------------|
|  | | | |
| 1 | | | |
| GEV No. | 370375 | Ref. No. | 0F0001 0K8512 |
| description | solenoid valve triple straight 230VAC inlet 3/4" outlet 11.5mm t.max. 90°C TP plastic output A 2.5l/min output C 0.25l/min flow regulating valve outlet A yellow flow regulating valve outlet C red | | |
| For models: | FCVE202L6, FVC/E202/1, FCS202E4, FCS202EP, FCS202EX, CS-7ME4/200-3, CS7ME4/230-3, CS7ME4/400-3N, CS7ME6/400-3N, CS7ME4/400-3N/EO, CS7ME4/400-3/50HZ/MA, CS7ME4/440-3/60HZ/MA, CS7MT4/400-3N, CS7GE4/200-3, CS7GE4/230-3, CS7GE4/400-3N, CS7GE6/400-3N, CS7GE4/400-3N/EO, CS7GE4/400-3/50HZ/MA, CS7GE4/440-3/60HZ/MA, CS7GT4/400-3N, CS7LCE4/200-3, CS7LCE4/230-3, CS7LCE4/400-3N, CS7LCE6/400-3N, CS7LCE4/400-3N/EO, CS7LCE4/400-3/50HZ/M, CS7LCE4/440-3/60HZ/M, CS7LCT4/400-3N, CS10ME4/200-3, CS10ME4/230-3, CS10ME6/230-3, CS10ME4/400-3N, CS10ME6/400-3N, CS10ME4/400-3N/EO, CS10ME4/400-3/50HZ/M, CS10ME4/440-3/60HZ/M, CS10MT4/400-3N, CS10MT6/400-3N, CS10GE4/200-3, CS10GE4/230-3, CS10GE6/230-3, CS10GE4/400-3N, CS10GE6/400-3N, CS10GE4/400-3N/EO, CS10GE4/400-3/50HZ/M, CS10GE4/440-3/60HZ/M, CS10GT4/400-3N, CS10GT6/400-3N, CS10LCE4/200-3...(Other models you can see in the webshop) | | |

| | | | |
|--|--|-----------------|--------|
| metal | | | |
| CEME | | | |
| solenoid valves | | | |
|  | | | |
| 1 | | | |
| GEV No. | 370348 | Ref. No. | 007015 |
| description | solenoid valve 2-ways 230VAC connection 1/2" L 60mm t.max. 90°C membranes NBR p max 10bar p min 0.25bar brass | | |
| For models: | AOW101EA, AOS061EA, AOS101EA, AOS061EA3J, AOS101EA3J, AOS061EA2N, AOS101EA2N, AOS061EA0H, AOS101EA0H, AOS061GA, AOS101GA, AOW101EABU | | |



1

| | | | |
|--------------------|--|-----------------|--------|
| GEV No. | 370350 | Ref. No. | 007017 |
| description | solenoid valve SS 230V inlet 6.5mm outlet 6.5mm -10 up to 140°C hose ø 6mm combi-steamer body SS 50Hz | | |
| For models: | AOS061EA, AOS101EA, AOS201EA, AOS061EA3J, AOS101EA3J, AOS201EA3J, AOS061EA2N, AOS101EA2N, AOS201EA2N, AOS061EA0H, AOS101EA0H, AOS201EA0H, AOS061GA, AOS101GA, AOS201GA | | |

ODE

2-way



1

| | | | |
|---|--|-----------------|-------------------|
| GEV No. | 370356 | Ref. No. | OC1121 |
| description | solenoid valve 2-ways 230VAC inlet 3/4" outlet 3/4" connection 3/4" L 104mm DN 19mm slide-on receptacle DIN -10 up to +90°C ODE type series 21W3 coil type BDA membranes NBR (water) p max 16bar p min 0.2bar | | |
| For models: | FCZ201EAA, FCZ202EAA, FCZ201EAH, FCZ201EAN, FCZ201GAG, FCZ202GAG, FCZ201GAD, FCZ202GAD, FCZ201EBC, FCZ201GBI, FCZ201ECA, FCZ202ECA, FCZ201ECH, FCZ201ECN, FCZ201GCG, FCZ202GCG, FCZ201GCD, FCZ202GCD, AOS202GAEU, AOS202GAAU, AOS201EA, AOS201EA3J, AOS201EA2N, AOS202EA2N, AOS201EA0H, AOS202EA, AOS201GA, AOS202GA, AOS201EAAQ, AOS202EAAQ, AOS201EANQ, AOS202EANQ, AOS201EACQ, AOS201EAHQ, AOS-201GAGQ, AOS202GAGQ, AOS201GADQ, AOS202GADQ, AOS-201GAIQ, AOS201GALQ, AOS201EAA1, AOS202EAA1, AOS201EAH1, AOS201EAN1, AOS201EAC1, AOS201EAE1, AOS201EAF1, AOS201EAQ1, AOS201EAM1, AOS202EAM1...(Other models you can see in the webshop) | | |
| spare parts for | 370356 | | |
|  | GEV No. | 371150 | Ref. No. — |
| accessories for | 370356 | | |
|  | GEV No. | 371090 | Ref. No. — |



1

| | | | |
|--------------------|---|-----------------|--------|
| GEV No. | 370653 | Ref. No. | OC1148 |
| description | solenoid valve brass 2-ways 230VAC inlet 1/2" outlet 1/2" connection 1/2" L 66mm DN 13mm t.max. 90°C -10 up to +90°C ODE type series 21WA4 coil type BDF membranes NBR (water) p max 16bar p min 0.2bar 50/60Hz | | |
| For models: | FCZ061EAA, FCZ101EAA, FCZ102EAA, FCZ061EAH, FCZ101EAH, FCZ061EAN, FCZ101EAN, FCZ061GAG, FCZ101GAG, FCZ102GAG, FCZ061GAD, FCZ101GAD, FCZ102GAD, FCZ061EBC, FCZ101EBC, FCZ061GBI, FCZ101GBI, FCZ061ECA, FCZ101ECA, FCZ102ECA, FCZ061ECH, FCZ101ECH, FCZ061ECN, FCZ101ECN, FCZ061GCG, FCZ101GCG, FCZ102GCG, FCZ061GCD, FCZ101GCD, FCZ102GCD, FCS061EXLN, FCS061EX, FCS101EX4J, FCS101EXLN, FCS101EX, FCS102EX4J, FCS102EX, FCS201EX, FCS201EXLN, FCS202EX, FCS-101GX9J, FCS101GX, FCS102GX9J, FCS102GX, FCS201GX, FCS202GX, AOW101EA, AOS061EA, AOS101EA, AOS061EA3J...(Other models you can see in the webshop) | | |

solenoid valves steam (water)

21A series



1

| | | | |
|---|--|-----------------|-------------------|
| GEV No. | 370349 ¹ | Ref. No. | 007016 |
| description | solenoid valve stainless steel 230VAC connection 1/4" L 40mm 2-way DN 5.5mm slide-on receptacle DIN -10 up to 140°C ODE type series 21A coil type BDA membranes FKM (water/steam) p max 3.5bar | | |
| For models: | AOS061EA, AOS101EA, AOS201EA, AOS061EA3J, AOS101EA3J, AOS201EA3J, AOS061EA2N, AOS101EA2N, AOS201EA2N, AOS061EA0H, AOS101EA0H, AOS201EA0H, AOS061GA, AOS101GA, AOS201GA | | |
| spare parts for | 370349 | | |
|  | GEV No. | 371150 | Ref. No. — |
| accessories for | 370349 | | |
|  | GEV No. | 371090 | Ref. No. — |

¹SS housing

Solenoid valve - accessories



1

| | | | |
|--------------------|--|-----------------|--------|
| GEV No. | 370855 | Ref. No. | 058946 |
| description | reducer 0.5 ED ø 12mm for solenoid valve brass | | |
| For models: | FCV/E101/1, FCV/G10L2, FCV/E10L2, FCV/E101/1, FCS101E2, FCS101G2, FCVG10-ISG, ECV/E10IGP, RCV101G2, RCV101E2, ACV/G10C2, ACV/E10C2, NCV/G10L2, NCV/E10L2, FCVG10-ISG, BCFCV101/1, BCFCV102/1, BCFCV101/1, BCFCV102/1 | | |



| | | | |
|---|--|-----------------|--------|
|  | | | |
| GEV No. | 370856 | Ref. No. | 002752 |
| description | reducer 1.25 ED ø 11mm for solenoid valve L 30mm brass | | |
| For models: | FCV/G6L3TOWNGAS, FCV/G6L3, FCVE6L3J, FCV/G6L3JAP, FCVG6L3CJ, FCV/E61/1, FCV/E61/1, FCV/E61/1, FCV/E61/1, FCV/G6L3C, FCV/G61/1, FCV/G61/1, FCV/G61/1, FCV/G61/1, FCV/G61/1, FCV/G6L3CT, FCV/G6L3CJ, FCV/E6L3, FCV/G6L4, FCV/E6L4, FCS061E44J, FCS061G48J, FCS061GP, FCS061EP, FCS061G3DI, FCS061E3CI, FCS061G4, FCS061G4DT, FCS061G49J, FCS061E4, FCS061EXLN, FCS061EX, 5711-2-6, 5711-2-7, 5711-2-8, 5711-2-10, 5711-2-8CH, 5711-2-10CH, 5711-2-6L, 5711-2-7L, 5711-2-8L, 5711-2-10L, 5721-2-7, 5721-2-10, 5711-3-7, 5711-3-8, 5711-3-10, 5711-3-10F, 5711-3-10S, 5704-2-2, 5704-2-3...(Other models you can see in the webshop) | | |

| | | | |
|---|---|-----------------|--------|
|  | | | |
| GEV No. | 370847 | Ref. No. | 002728 |
| description | reducer 1.8 ED ø 11mm for solenoid valve brass | | |
| For models: | FCV/G10L3, FCVG10L3T, FCV/E101/1, FCV/E10L3JAP, FCV/E10L6JAP, FCVG10L3J, FCV/G10L6JAP, FCV/G10L2, FCV/E101/1, FCV/E101/1, FCV/E10L2, FCV/E101/1, FCV/E101/2, FCV/E10L3, FCV/E101/1, FCV/G10L6, FCV/E10L6, FCV/E101/1, FCV/G101/1, FVC/E101/1, FCS101E2, FCS101E44J, FCS101EP4J, FCS101G2, FCS101E4, FCS101G4, FCS101EP, FCS101G4DT, FCS101GP9J, FCS101G49J, FCS101GP, FCS101GX9J, FCS101GX, CS7ME4/200-3, CS7ME4/230-3, CS7ME4/400-3N, CS7ME6/400-3N, CS7ME4/400-3N/EO, CS7ME4/400-3/50HZ/MA, CS7ME4/440-3/60HZ/MA, CS7MT4/400-3N, CS7GE4/200-3, CS7GE4/230-3, CS7GE4/400-3N, CS7GE6/400-3N, CS7GE4/400-3N/EO, CS7GE4/400-3/50HZ/MA, CS7GE4/440-3/60HZ/MA, CS7GT4/400-3N, CS7LCE4/200-3...(Other models you can see in the webshop) | | |

ball valves electric

| | | | |
|---|---|-----------------|------------------|
|  | | | |
| GEV No. | 401140 | Ref. No. | 005026 OK1518 |
| description | ball valve inlet 1" IT outlet 1" IT with plug 230V L 152mm 50/60Hz closed off-current mode of operation electric connection cable 200mm size DN25 | | |
| For models: | FCVG202L3, FCV/G20L6, FCV/E20L6, FCVG202L6, FCVE202L6, FCV/G201/1, FVC/E201/1, FVC/E202/1, 5712-2-7, 5712-2-8, 5712-2-10, 5714-2-7, 5714-2-8, 5714-2-10, 5717-2-6, 5714-2-7, 5714-2-8, 5714-2-10, 5712-2-7L, 5712-2-8L, 5712-2-10L, 5714-2-7L, 5714-2-8L, 5714-2-10L, 5714-2-6L, 5714-2-7L, 5714-2-8L, 5714-2-10L, 5711-3-7, 5711-3-8, 5711-3-10, 5711-3-8CH, 5711-3-10CH, 5712-3-7, 5712-3-8, 5712-3-8E, 5712-3-10, 5712-3-8CH, 5712-3-10C, 5714-3-7, 5714-3-8, 5714-3-8E, 5714-3-10, 5717-3-6, 5717-3-7, 5717-3-8, 5717-3-8E, 5717-3-10, 5717-3-8M, 5717-3-8C...(Other models you can see in the webshop) | | |

| | | | |
|--|--|-----------------|------------------|
|  | | | |
| GEV No. | 400293 | Ref. No. | 059004 0L0949 |
| description | ball valve inlet 3/4" IT outlet 3/4" IT electric 24V 50/60Hz cable length 250mm | | |
| For models: | FCVE10-P, FCVE10PUK, FCVG10-P, FCVG10PUK, FCVE20-P, FCVE20PUK, FCVG20-P, FCVG20PUK, WTM140ERA, WTM140ELA, WTM140ERB, WTM140ELB, WTM165ERA, WTM165ELA, WTM165ERB, WTM165ELB, WTM200ERA, WTM200ELA, WTM200ERB, WTM200ELB, WTM250ERA, WTM250ELA, WTM250ERB, WTM250ELB, WTM300ERA, WTM300ELA, WTM300ERB, WTM300ELB, WTM180ERA, WTM180ELA, WTM180ERB, WTM180ELB, WTM140SRA, WTM140SLA, WTM165SRA, WTM165SLA, WTM180SRA, WTM180SLA, WTM200SRA, WTM200SLA, WTM250SRA, WTM250SLA, WTM300SRA, WTM300SLA, RTM140ERA, RTM140ELA, RTM140ERB, RTM140ELB, RTM165ERA, RTM165ELA...(Other models you can see in the webshop) | | |

| | | | |
|---|--|-----------------|---|
|  | | | |
| GEV No. | 401139 | Ref. No. | 002713 0C0882 0F0171 0K1526 0K8453 0K9349 2255318 696804201 867016 8670160 |
| description | ball valve inlet 3/4" IT outlet 3/4" IT with plug 230V L 65mm 50/60Hz closed off-current mode of operation electric connection cable 200mm | | |
| For models: | FCZ061EAA, FCZ101EAA, FCZ102EAA, FCZ201EAA, FCZ202EAA, FCZ061EAH, FCZ101EAH, FCZ201EAH, FCZ061EAN, FCZ101EAN, FCZ201EAN, FCZ061ETA, FCZ101ETA, FCZ102ETA, FCZ201ETA, FCZ202ETA, FCZ061ETH, FCZ101ETH, FCZ201ETH, FCZ061ETN, FCZ101ETN, FCZ201ETN, FCZ061GAG, FCZ101GAG, FCZ102GAG, FCZ201GAG, FCZ202GAG, FCZ061GAD, FCZ101GAD, FCZ102GAD, FCZ201GAD, FCZ202GAD, FCZ101GTG, FCZ102GTG, FCZ201GTG, FCZ202GTG, FCZ101GTD, FCZ102GTD, FCZ201GTD, FCZ202GTD, FCZ061EBA, FCZ101EBA, FCZ102EBA, FCZ201EBA, FCZ202EBA, FCZ061EBH, FCZ101EBH, FCZ201EBH, FCZ061EBN, FCZ101EBN...(Other models you can see in the webshop) | | |



pressure switches

for gas equipment

electric components



1

| | | | |
|--------------------|---|-----------------|-----------------------------|
| GEV No. | 541073 | Ref. No. | 002635 0360001 0K2021 |
| description | pressure control ø 45mm pressure range adjustable 5-20mbar pressure connection vertical gas technology connection 1/4" pressure connection ø 1/4"mm | | |
| For models: | FCV/G10L3, FCVG10L3T, FCVG102L3, FCVG10L3J, FCVG102L3J, FCV/G10L6JAP, FCV/G102/1L6JAP, FCVG6L3CJ, FCV/G10L2, FCV/G6L3C, FCV/G61/1, FCV/G61/1, FCV/G61/1, FCV/G61/1, FCVG6L3CT, FCVG6L3CJ, FCV/G6L4, FCV/G10L6, FCV/G102/1L6, FCV/G101/1, FCV/G102/1, FCS061G48J, FCS061G49J, FCS061G3DI, FCS061G4, FCS061G4DT, FCS061G49J, FCS101G2, FCS101G4, FCS101G4DT, FCS101GP9J, FCS101G49J, FCS101GP, FCS102G4, FCS102GA9J, FCS102G49J, FCS102GP, FCS101GX9J, FCS101GX, FCS102GX9J, FCS102GX, 5721-2-7, 5721-2-10, ECV/G6T4, ECV/G10T4, ECVG102T4, ECV/G6T4C, ECV/G10T4J, ECV/G61/1, ECV/G61/1...(Other models you can see in the webshop) | | |



1

| | | | |
|--------------------|--|-----------------|-----------------------|
| GEV No. | 541867 | Ref. No. | 003772 C6065A1275B |
| description | pressure control ø 80mm reset pressure 0.42bar triggering pressure 0.78mbar connection 7.5/10.5mm 250V voltage AC 1CO pressure connection ø 7.5-10.5mm | | |
| For models: | FDV40G, FDV40GZ, FDV40GA, FDV20G, FDV20GZ, FDV20GA, FCV/G10L3, FCVG10L3T, FCVG102L3, FCV/G20L3, FCVG202L3, FCVG10L3J, FCVG102L3J, FCV/G10L6JAP, FCV/G102/1L6JAP, FCV/G10L2, FCV/G10L6, FCV/G102/1L6, FCV/G20L6, FCVG202L6, FCV/G101/1, FCV/G102/1, FCS101G2, FCS101G4, FCS101G4DT, FCS101GP9J, FCS101G49J, FCS101GP, FCS102G4, FCS102GA9J, FCS102G49J, FCS102GP, FCS101GX9J, FCS101GX, FCS102GX9J, 5712-2-7, 5712-2-8, 5712-2-10, 5714-2-6, 5714-2-7, 5714-2-8, 5714-2-10, 5717-2-6, 5714-2-7, 5714-2-8, 5714-2-10, 5712-2-6L, 5712-2-7L...(Other models you can see in the webshop) | | |



1

| | | | |
|--------------------|---|-----------------|-------------------|
| GEV No. | 541446 | Ref. No. | 005029 0360002 |
| description | pressure control pressure range 10-50mbar connection 1/4" | | |
| For models: | FDV40G, FDV40GZ, FDV40GA, FDV20G, FDV20GZ, FDV20GA, FCV/G20L3, FCVG202L3, FCV/G20L6, FCVG202L6, FCV/G201/1, FCV/G202/1, FCS201G4, FCS201GP, FCS202G4, FCS201GX, 5711-2-6, 5711-2-7, 5711-2-8, 5711-2-10, 5711-2-8CH, 5711-2-10CH, 5712-2-6, 5712-2-7, 5712-2-8, 5712-2-10, 5714-2-6, 5714-2-7, 5714-2-8, 5714-2-10, 5717-2-6, 5714-2-7, 5714-2-8, 5714-2-10, 5711-2-6L, 5711-2-7L, 5711-2-8L, 5711-2-10L, 5712-2-6L, 5712-2-7L, 5712-2-8L, 5712-2-10L, 5714-2-6L, 5714-2-7L, 5714-2-8L, 5714-2-10L, 5714-2-6L, 5714-2-7L, 5714-2-8L, 5714-2-10L...(Other models you can see in the webshop) | | |



1

| | | | |
|--------------------|---|-----------------|--------|
| GEV No. | 541797 | Ref. No. | 006536 |
| description | pressure control triggering pressure 0.5mbar pressure range 0.8/0.6mbar pressure connection horizontal gas technology connection 6mm 250V | | |
| For models: | FCV/G20L3, FCVG202L3, FCV/G20L6, FCVG202L6, FCV/G201/1, FCV/G202/1, FCS201G4, FCS201GP, FCS202G4, FCS202GP, FCS201GX, FCS202GX, ECV/G20T4, ECVG202T4, ECV/G20T4J, ECV/G20T6, ECVG202T6, ACV/G20C4, ACVG202C4, ACVG202C6 | | |



1

| | | | |
|--------------------|---|-----------------|-------------------|
| GEV No. | 541352 | Ref. No. | 005746 0380072 |
| description | pressure control triggering pressure 1.5mbar reset pressure 1.2mbar pressure range 1.5/1.2mbar pressure connection horizontal gas technology connection 6mm suitable for ZANUSSI | | |
| For models: | FCVG6L3CJ, FCV/G6L3C, FCV/G61/1, FCV/G61/1, FCV/G61/1, FCV/G61/1, FCVG6L3CT, FCVG6L3CJ, FCS061G48J, FCS061GP, FCS061G3DI, FCS061G4, FCS061G4DT, FCS061G49J, 5721-2-7, 5721-2-10, ECV/G6T4C, ECV/G61/1, ECV/G61/1, RCV061G2, ACV/G6C3C, ZCV/G6T4C, ZCV/G61/1 | | |

for steam control



1

| | | | |
|--------------------|--|-----------------|--------|
| GEV No. | 541799 | Ref. No. | 0C1126 |
| description | pressure control ø 34mm pressure range 0.2-6.0bar connection 15mm CEME difference 0.1-0.8bar pressure connection 15mm | | |
| For models: | FCZ061EAA, FCZ101EAA, FCZ102EAA, FCZ201EAA, FCZ202EAA, FCZ061EAH, FCZ101EAH, FCZ201EAH, FCZ061EAN, FCZ101EAN, FCZ201EAN, FCZ061GAG, FCZ101GAG, FCZ102GAG, FCZ201GAG, FCZ202GAG, FCZ061GAD, FCZ101GAD, FCZ102GAD, FCZ201GAD, FCZ202GAD, FCZ061EBC, FCZ101EBC, FCZ201EBC, FCZ061GBI, FCZ101GBI, FCZ201GBI, FCZ061ECA, FCZ101ECA, FCZ102ECA, FCZ201ECA, FCZ202ECA, FCZ061ECH, FCZ101ECH, FCZ201ECH, FCZ061ECN, FCZ101ECN, FCZ201ECN, FCZ061GCG, FCZ101GCG, FCZ102GCG, FCZ201GCG, FCZ202GCG, FCZ061GCD, FCZ101GCD, FCZ102GCD, FCZ201GCD, FCZ202GCD, FCS061EXLN, FCS061EX...(Other models you can see in the webshop) | | |





for combi-steamers

| | | | |
|---|--|-----------------|--------|
|  | | | |
| 1 | | | |
| GEV No. | 541335 | Ref. No. | 054540 |
| description | pressure control | | |
| For models: | ABR/G800D, ABR/G805D, ABR/G801D, ABR/G806D, ABR/G810D, ABR/G815D, ABR/G811D, ABR/G816D, FCFG20, FCFG20D, FCFG20F, PFCFG20, FCFG40, FCFG41, FCFG40D, FCFG40F, PFCFG40F, FV4G, FCFG20J, FCFG20J, FCFG40J, FCFG40J, FCFG20J, FCFG20J, FCFG41J, FCFG40J, FCVMG62, FCFG201, FCFG202, FCFC202, FV4G, FF/G20, FF/G40, COCO20G, 4236N, ZOFCEV/G20D | | |

| | | | |
|---|---|-----------------|--------|
|  | | | |
| 1 | | | |
| GEV No. | 542127 | Ref. No. | 0C6217 |
| description | pressure control pressure range 200-3000mbar pressure range 0.2 - 3bar connection 8mm MA-TER 250V 12A pressure connection 8mm | | |
| For models: | FCZ061EAA, FCZ101EAA, FCZ102EAA, FCZ061EAH, FCZ101EAH, FCZ061EAN, FCZ101EAN, FCZ061ETA, FCZ101ETA, FCZ102ETA, FCZ201ETA, FCZ202ETA, FCZ061ETH, FCZ101ETH, FCZ201ETH, FCZ061ETN, FCZ101ETN, FCZ201ETN, FCZ061GAG, FCZ061GAD, FCZ101GTG, FCZ102GTG, FCZ201GTG, FCZ202GTG, FCZ101GTD, FCZ102GTD, FCZ201GTD, FCZ202GTD, FCZ061EBA, FCZ101EBA, FCZ102EBA, FCZ061EBH, FCZ101EBH, FCZ061EBN, FCZ101EBN, FCZ061EBC, FCZ101EBC, FCZ061EBA2, FCZ101EBA2, FCZ102EBA2, FCZ201EBA2, FCZ202EBA2, FCZ061EBH2, FCZ101EBH2, FCZ201EBH2, FCZ061EBN2, FCZ101EBN2, FCZ201EBN2, FCZ061EBC2, FCZ101EBC2...(Other models you can see in the webshop) | | |

electrodes

| | | | |
|---|---|-----------------|------------------|
|  | | | |
| 1 | | | |
| GEV No. | 401264 | Ref. No. | 007033 0C4098 |
| description | level electrode 1/4" total length 103mm probe L 76mm insulated probe length 71mm PTFE insulated connection angled, male faston 6.3mm stainless steel ø 2.5mm | | |
| For models: | FCZ061EAA, FCZ101EAA, FCZ061EAH, FCZ101EAH, FCZ061EAN, FCZ101EAN, FCZ061ETA, FCZ101ETA, FCZ061ETH, FCZ101ETH, FCZ061ETN, FCZ101ETN, FCZ061GAG, FCZ101GAG, FCZ102GAG, FCZ201GAG, FCZ202GAG, FCZ061GAD, FCZ101GAD, FCZ102GAD, FCZ201GAD, FCZ202GAD, FCZ101GTG, FCZ102GTG, FCZ201GTG, FCZ202GTG, FCZ101GTD, FCZ102GTD, FCZ201GTD, FCZ202GTD, FCZ061EBA, FCZ101EBA, FCZ061EBH, FCZ101EBH, FCZ061EBN, FCZ101EBN, FCZ061EBC, FCZ101EBC, FCZ061EBA2, FCZ101EBA2, FCZ061EBH2, FCZ101EBH2, FCZ061EBN2, FCZ101EBN2, FCZ061EBC2, FCZ101EBC2, FCZ101EBG, FCZ102GBG, FCZ201GBG...(Other models you can see in the webshop) | | |

| | | | |
|--|--|-----------------|------------------|
|  | | | |
| 1 | | | |
| GEV No. | 401258 | Ref. No. | 0A2838 0K3039 |
| description | level electrode 1/4" total length 120mm probe L 94mm insulated probe length 90mm PTFE insulated connection angled, male faston 6.3mm stainless steel ø 2.5mm | | |
| For models: | FCVE10-2, FCVE10-4, FCVE103CE, FCVE10-2UK, FCVE10-4UK, FCVG10-2, FCVG10-4, FCVG10-2, FCVG10-4D, FCVG10-2UK, FCVG10-4UK, FCVG10-2, FCVG10-4, FCVE20-2, FCVE20-4, FCVE203CE, FCVE20-2UK, FCVE20-4UK, FCVG20-2, FCVG20-4, FCVG20-2, FCVG20-4D, FCVG20-2UK, FCVG20-4UK, FCVG20-4, FCVG20-4D, FCVE10-P, FCVE10PUK, FCVG10-P, FCVG10PUK, FCVE20-P, FCVE20PUK, FCVG20-P, FCVG-20PUK, ZOFCEV/E102, ZOFCEV/E104, ZOFCEV/G102, ZOFCEV/G104, ZOFCEV/E202, ZOFCEV/E204, ZOFCEV/G202, ZOFCEV/G204, AFCV/G101, AFCV/G103, SCO/G10-3, AFCV/G201, AFCV/G203, SCO/G20-3 | | |

| | | | |
|--|--|-----------------|--|
|  | | | |
| 1 | | | |
| GEV No. | 400121 | Ref. No. | 055346 0H2444 0K2067 0K8045 908161 |
| description | level electrode 1/4" total length 121mm probe L 94mm insulated probe length 90mm PTFE insulated connection angled, male faston 6.3mm stainless steel | | |
| For models: | FCV/G6L4, FCVE6-1U, FCVE6-3U, FCVE6-1, FCVE6-3, FCVE6-1UK, FCVE6-3UK, FCVG6-1, FCVG6-3, FCVG6-1UK, FCVG6-3UK, FCVE10-2, FCVE10-4, FCVE10-2UK, FCVE10-4UK, FCVG10-2, FCVG10-4, FCVG10-2UK, FCVG10-4UK, FCVE20-2, FCVE20-4, FCVE20-2UK, FCVE20-4UK, FCVG20-2, FCVG20-4, FCVG20-2UK, FCVG20-4UK, 5711-2-6, 5711-2-7, 5711-2-8, 5711-2-10, 5711-2-8CH, 5711-2-10CH, 5711-2-6L, 5711-2-7L, 5711-2-8L, 5711-2-10L, ECV/G6T4, FCV/E6-1, FCV/E6-1, FCV/G6-1, ZOFCEV/G6-3, ZOFCEV/E102, ZOFCEV/E104, ZOFCEV/G102, ZOFCEV/G104, ZOFCEV/E202, ZOFCEV/E204, ZOFCEV/G202, ZOFCEV/G204...(Other models you can see in the webshop) | | |

| | | | |
|--|---|-----------------|--------|
|  | | | |
| 1 | | | |
| GEV No. | 401355 | Ref. No. | 0C1086 |
| description | level electrode 1/4" total length 130mm probe L 102mm insulated probe length 98mm PTFE insulated connection angled, male faston 6.3mm stainless steel | | |
| For models: | AOS061GAEU, AOS061GAU, AOS061GA, AOS061GB | | |

1 electric components



| | | | |
|---|---|-----------------|----------------------------|
|  | | | |
| GEV No. | 401261 | Ref. No. | 003878 0H6627 0K2066 |
| description | level electrode 1/4" total length 138mm probe L 112mm insulated probe length 108mm PTFE insulated connection angled, male faston 6.3mm stainless steel ø 2.5mm | | |
| For models: | FCV/E61/1, FCV/E101/1, FCV/E101/1, FCV/E102/1, FCV/E61/1, FCV/E101/1, FCV/E101/2, FCV/E10L3, FCV/E102/1, FCV/E102/1L3, FCV/E6L4, FCV/E10L6, FCV/E102/1L6, FCV/E101/1, FVC/E101/1, FVC/E102/1, FCS061EP, FCS101E44J, FCS101EP4J, FCS101E4, FCS101EP, FCS102E44J, FCS102EP4J, FCS102E4, FCS102EP, FCS061E4, FCS061EXLN, FCS061EX, FCS101EX4J, FCS101EXLN, FCS101EX, FCS102EX4J, FCS102EX, FCS201EX, FCS201EXLN, FCS202EX, 5711-3-6, 5711-3-7, 5711-3-8, 5711-3-10, 5711-3-8CH, 5711-3-10CH, 5712-3-6, 5712-3-7, 5712-3-8, 5712-3-8E, 5712-3-10, 5712-3-8CH, 5712-3-10C, 5714-3-6... (Other models you can see in the webshop) | | |

| | | | |
|---|--|-----------------|--------|
|  | | | |
| GEV No. | 401345 | Ref. No. | OC1201 |
| description | level electrode 1/4" total length 142mm probe L 116mm insulated probe length 112mm PTFE insulated connection angled, male faston 6.3mm stainless steel ø 2.5mm | | |
| For models: | FCZ102EAA, FCZ201EAA, FCZ201EAH, FCZ201EAN, FCZ102ETA, FCZ201ETA, FCZ201ETH, FCZ201ETN, FCZ102EBA, FCZ201EBA, FCZ201EBH, FCZ201EBN, FCZ201EBC, FCZ102EBA2, FCZ201EBA2, FCZ201EBH2, FCZ201EBN2, FCZ201EBC2, FCZ102ECA, FCZ102ECA2, FCZ201ECA2, FCZ201ECH2, FCZ201ECN2, AOS102GAEU, AOS102GAAU, AOS201EABU, AOS201EAFU, AOS201EA, AOS201EB, AOS201EA3J, AOS201EB3J, AOS201EA2N, AOS201EB2N, AOS201EB5M, AOS201EB6M, AOS102EA2N, AOS102EB2N, AOS201EA0H, AOS201EB0H, AOS102EA, AOS102EB, AOS102GB, AOS102GA, AOS102EAAQ, AOS102EBAQ, AOS201EAAQ, AOS201EBAQ, AOS102EANQ, AOS102EBNQ, AOS201EANQ...(Other models you can see in the webshop) | | |

| | | | |
|---|---|-----------------|------------------|
|  | | | |
| GEV No. | 401259 | Ref. No. | 053909 0C0438 |
| description | level electrode 1/4" total length 155mm probe L 128mm insulated probe length 124mm PTFE insulated connection angled, male faston 6.3mm stainless steel ø 2.5mm | | |
| For models: | FVGC4, FV4G, FV4E, FCVE6-1U, FCVE6-3U, FCVE6-1, FCVE6-3, FCVE6-3CE, FCVE6-1UK, FCVE6-3UK, FCVG10-2, FCVG10-4, FCVG10-2, FCVG10-4D, FCVG10-2UK, FCVG10-4UK, FCVG10-2, FCVG10-4, FCVE20/P-V, FCVG20-2, FCVG20-4, FCVG20-2, FCVG20-4D, FCVG20-2UK, FCVG20-4UK, FCVG20-4, FCVG20-4D, FCVE20-V, FCVE20VUK, FCVM62E, FCVM62EUK, FCVG10-P, FCVG10PUK, FCVG20-P, FCVG20PUK, FCV/E6-1, FCV/E6-1, ZOFVCV/G102, ZOFVCV/G104, ZOFVCV/G202, ZOFVCV/G204, FV4G, FV4E, FVAC041, AFCV/G101, AFCV/G103, SCO/G10-3, AFCV/G201, AFCV/G203, SCO/G20-3...(Other models you can see in the webshop) | | |

| | | | |
|---|--|-----------------|--------|
|  | | | |
| GEV No. | 401262 | Ref. No. | OC1055 |
| description | level electrode 1/4" total length 159mm probe L 130mm insulated probe length 126mm PTFE insulated connection angled, male faston 6.3mm stainless steel ø 2.5mm | | |
| For models: | AOS101GAEU, AOS202GAEU, AOS101GAAU, AOS202GAAU, AOS101GA, AOS101GB, AOS202GB, AOS202GA | | |

| | | | |
|--|--|-----------------|------------------|
|  | | | |
| GEV No. | 400403 | Ref. No. | 0H6625 908178 |
| description | level electrode 1/4" total length 210mm probe L 183mm insulated probe length 172mm PTFE insulated connection angled, male faston 6.3mm stainless steel ø 2.5mm | | |
| For models: | 5611-3-10, 5611-3-6, 5611-3-8, 5612-3-10, 5612-3-6, 5612-3-8 | | |

| | | | |
|--|--|-----------------|--------|
|  | | | |
| GEV No. | 401263 | Ref. No. | OC1105 |
| description | level electrode 1/4" total length 220mm probe L 195mm insulated probe length 189mm PTFE insulated connection angled, male faston 6.3mm stainless steel ø 2.5mm | | |
| For models: | AOS201GAEU, AOS202GAEU, AOS201GAAU, AOS202GAAU, AOS201GA, AOS201GB, AOS202GB, AOS202GA | | |

| | | | |
|--|---|-----------------|------------------|
|  | | | |
| GEV No. | 401265 | Ref. No. | 005879 0C0439 |
| description | level electrode 1/4" total length 240mm probe L 216mm insulated probe length 210mm PTFE insulated connection angled, male faston 6.3mm stainless steel ø 2.5mm | | |
| For models: | FCZ202EAA, FCZ202EBA, FCV/E20L3, FCVE20L3, FCV/E20L6, FCVE20L6, FVC/E201/1, FVC/E202/1, FCS201E4, FCS201EP, FCS202E4, FCS202EP, FCS201EX, FCS202EX, 5714-3-7, 5714-3-8, 5714-3-8E, 5714-3-10, 5717-3-7, 5717-3-8, 5717-3-8E, 5717-3-10, 5717-3-8M, 5717-3-8M, AOS202EA2N, AOS202EB2N, AOS202EA, AOS202EB, AOS202EAAQ, AOS202EBAQ, AOS202EANQ, AOS202EBNQ, ECV/E20T4, ECV/E20T4, ECV/E20T6, ECV/E20T6, AOS202EAA1, AOS202EAM1, AOS202EAB1, AOS202EAK1, AOS202EAT1, AOS202EBA1, AOS202EBK1, EJV202EAA, EJV202EBA, ACV/E20C4, ACVE202C4, ACVE20C6, ACV/E202/1, ZCV/E20T4...(Other models you can see in the webshop) | | |

| | | | |
|--|---|-----------------|----------------------------|
|  | | | |
| GEV No. | 400405 | Ref. No. | 0H6626 246024 908179 |
| description | level electrode 1/4" total length 345mm probe L 320mm insulated probe length 310mm PTFE insulated connection F6.3 stainless steel ø 2.5mm | | |
| For models: | 5614-3-6, 5614-3-8 | | |

| | | | |
|--|---|-----------------|--------|
|  | | | |
| GEV No. | 401255 | Ref. No. | 005765 |
| description | level electrode 1/4" total length 64mm probe L 37mm insulated probe length 33mm PTFE insulated connection angled, male faston 6.3mm ø 2.5mm marking L | | |
| For models: | FCV/G61/1, FCV/G61/1, FCV/G61/1, FCS061GP, FCS061G4, 5721-2-7, 5721-2-10, ECV/G61/1, ECV/G61/1, ZCV/G61/1 | | |





| | | | |
|---|---|-----------------|--------|
|  | | | |
| GEV No. | 401254 | Ref. No. | 005766 |
| description | level electrode 1/4" total length 74mm probe L 47mm insulated probe length 41mm PTFE insulated connection angled, male faston 6.3mm stainless steel ø 2.5mm marking S | | |
| For models: | FCV/G61/1, FCV/G61/1, FCV/G61/1, FCS061GP, FCS061G4, 5721-2-7, 5721-2-10, ECV/G61/1, ECV/G61/1, ZCV/G61/1 | | |

| | | | |
|--|--|-----------------|--------|
|  | | | |
| GEV No. | 401260 | Ref. No. | 002632 |
| description | level electrode total length 75mm probe L 50mm insulated probe length 46mm PTFE insulated connection angled, male faston 6.3mm ø 2.5mm | | |
| For models: | FDV40G, FDV40GZ, FDV40GA, FDV20G, FDV20GZ, FDV20GA, FCV/G10L3, FCV/G10L3T, FCV/G102L3, FCV/G20L3, FCV/G202L3, FCV/G10L3J, FCV/G102L3J, FCV/G10L6JAP, FCV/G102/1L6JAP, FCV/G10L6, FCV/G102/1L6, FCV/G20L6, FCV/G202L6, FCV/G101/1, FCV/G102/1, FCV/G201/1, FCV/G202/1, FCS101G4, FCS101G4DT, FCS101GP9J, FCS101G49J, FCS101GP, FCS102G4, FCS102GA9J, FCS102G49J, FCS102GP, FCS201G4, FCS201GP, FCS202G4, FCS202GP, FCS101GX9J, FCS101GX, FCS102GX9J, FCS102GX, FCS201GX, FCS202GX, 5712-2-6, 5712-2-7, 5712-2-8, 5712-2-10, 5714-2-6, 5714-2-7, 5714-2-8, 5714-2-10...(Other models you can see in the webshop) | | |

| | | | |
|---|--|-----------------|------------------|
|  | | | |
| GEV No. | 400120 | Ref. No. | 056449 0K2068 |
| description | level electrode 1/4" total length 83mm probe L 62mm insulated probe length 57mm PTFE insulated connection angled, male faston 6.3mm stainless steel ø 2.5mm | | |
| For models: | FCV/G6L4, FCV/G6-1, FCV/G6-3, FCV/G6-1UK, FCV/G6-3UK, 5711-2-6, 5711-2-7, 5711-2-8, 5711-2-10, 5711-2-8CH, 5711-2-10CH, 5711-2-6L, 5711-2-7L, 5711-2-8L, 5711-2-10L, ECV/G6T4, FCV/G6-1, ZOFV/G6-3, AFCV/G6-1, AFCV/G6-3, SCO/G6-3, ZCV/G6T4 | | |

| | | | |
|---|---|-----------------|------------------|
|  | | | |
| GEV No. | 400123 | Ref. No. | 002633 0F0161 |
| description | spacer piece for level electrode | | |
| For models: | FDV40G, FDV40GZ, FDV40GA, FDV20G, FDV20E, FDV20GZ, FDV20EL, FDV20GA, FCV/G10L3, FCV/G10L3T, FCV/G102L3, FCV/G20L3, FCV/G202L3, FCV/G10L3J, FCV/G102L3J, FCV/G10L6JAP, FCV/G102/1L6JAP, FCV/E20L3, FCVE202L3, FCV/G10L6, FCV/G102/1L6, FCV/G20L6, FCV/E20L6, FCV/G202L6, FCVE202L6, FCV/G101/1, FCV/G102/1, FCV/G201/1, FVC/E201/1, FCV/G202/1, FVC/E202/1, FCS101G4, FCS101G4DT, FCS101GP9J, FCS101G49J, FCS101GP, FCS102G4, FCS201E4, FCS102GA9J, FCS201EP, FCS102G49J, FCS202E4, FCS102GP, FCS202EP, FCS201G4, FCS201GP, FCS202G4, FCS202GP, FCS201EX, FCS201EXLN...(Other models you can see in the webshop) | | |

| | | | |
|---|---|-----------------|---|
|  | | | |
| GEV No. | 400124 | Ref. No. | 002694 003084 0F0010 0K8460 0K9176 0KE754 908500 9085006 |
| description | level electrode push-in total length 128mm probe L 103mm insulated probe length 93mm PTFE insulated connection F6.3 ø 2.5mm | | |
| For models: | FCV/E10L3, FCV/E102/1L3, FCV/E6L4, FCV/E10L6, FCV/E102/1L6, FCS101EP4J, FCS101EP, FCS102EP4J, FCS102EP, FCS101EX4J, FCS101EXLN, FCS101EX, FCS102EX4J, FCS102EX, CS7ME4/200-3, CS7ME4/230-3, CS7ME4/400-3N, CS7ME6/400-3N, CS7ME4/400-3N/EO, CS7ME4/400-3/50HZ/MA, CS7ME4/440-3/60HZ/MA, CS7MT4/400-3N, CS7GE4/200-3, CS7GE4/230-3, CS7GE4/400-3N, CS7GE6/400-3N, CS7GE4/400-3N/EO, CS7GE4/400-3/50HZ/MA, CS7GE4/440-3/60HZ/MA, CS7GT4/400-3N, CS7LCE4/200-3, CS7LCE4/230-3, CS7LCE4/400-3N, CS7LCE6/400-3N, CS7LCE4/400-3N/EO, CS7LCE4/400-3/50HZ/M, CS7LCE4/440-3/60HZ/M, CS7LCT4/400-3N, CS10ME4/200-3, CS10ME4/230-3, CS10ME6/230-3, CS10ME4/400-3N, CS10ME6/400-3N, CS10ME4/400-3N/EO, CS10ME4/400-3/50HZ/M, CS10ME4/440-3/60HZ/M, CS10MT4/400-3N, CS10MT6/400-3N, CS10GE4/200-3, CS10GE4/230-3...(Other models you can see in the webshop) | | |

| | | | |
|---|---|-----------------|--------|
|  | | | |
| GEV No. | 693744 | Ref. No. | 055435 |
| description | spacer piece for level electrode size 5mm | | |
| For models: | FCV/E10L3JAP, FCV/E102/1L3JAP, FCV/E10L6JAP, FCV/E102/1L6JAP, FCV/E61/1, FCV/E101/1, FCV/E101/1, FCV/E102/1, FCV/E61/1, FCV/E101/1, FCV/E101/2, FCV/E10L3, FCV/E102/1, FCV/E102/1L3, FCV/E20L3, FCVE202L3, FCV/E6L4, FCV/E10L6, FCV/E102/1L6, FCV/E20L6, FCVE202L6, FCV/E101/1, FVC/E101/1, FVC/E102/1, FVC/E201/1, FVC/E202/1, FCS061EP, FCS101E44J, FCS101EP4J, FCS101E4, FCS101EP, FCS102E44J, FCS102EP4J, FCS102E4, FCS102EP, FCS201E4, FCS202E4, FCS061E4, FCS061EXLN, FCS061EX, FCS101EX4J, FCS101EXLN, FCS101EX, FCS102EX4J, FCS102EX, FV4G, FVE3, FCVE6-1U, FCVE6-3U, FCVE6-1...(Other models you can see in the webshop) | | |

| | | | |
|---|--|-----------------|----------------------------|
|  | | | |
| GEV No. | 401548 | Ref. No. | 004891 005235 0K2064 |
| description | level electrode push-in total length 175mm probe L 151mm insulated probe length 142mm PTFE insulated connection F6.3 ø 2.5mm | | |
| For models: | 5717-3-7, 5717-3-8, 5717-3-8E, 5717-3-10, 5717-3-8M, 5717-3-8C, 5714-3-10F, 5714-3-10S | | |

| | | | |
|---|--|-----------------|------------------|
|  | | | |
| GEV No. | 693743 | Ref. No. | 055347 0K3038 |
| description | spacer piece for level electrode size 9mm | | |
| For models: | FCZ061EAA, FCZ101EAA, FCZ102EAA, FCZ201EAA, FCZ202EAA, FCZ061EAH, FCZ101EAH, FCZ201EAH, FCZ061EAN, FCZ101EAN, FCZ201EAN, FCZ061ETA, FCZ101ETA, FCZ102ETA, FCZ201ETA, FCZ202ETA, FCZ061ETH, FCZ101ETH, FCZ201ETH, FCZ061ETN, FCZ101ETN, FCZ201ETN, FCZ061EBA, FCZ101EBA, FCZ102EBA, FCZ201EBA, FCZ202EBA, FCZ061EBH, FCZ101EBH, FCZ201EBH, FCZ061EBN, FCZ101EBN, FCZ201EBN, FCZ061EBC, FCZ101EBC, FCZ201EBC, FCZ061EBA2, FCZ101EBA2, FCZ102EBA2, FCZ201EBA2, FCZ202EBA2, FCZ061EBH2, FCZ101EBH2, FCZ201EBH2, FCZ061EBN2, FCZ101EBN2, FCZ201EBN2, FCZ061EBC2, FCZ101EBC2, FCZ201EBC2...(Other models you can see in the webshop) | | |



fans

axial fans

ebm-papst



| | | | |
|--------------------|--|-----------------|--|
| GEV No. | 601715 ¹ | Ref. No. | 002690 004000 006878 058855 0C1478 |
| description | axial fan L 119mm W 119mm H 38mm 230VAC 50Hz 18W bearing ball bearing manuf. no. 4656ZW metal connection cable 310mm ebm-papst fan wheel ø 110mm temp.-resist. 75°C | | |
| For models: | MCP/E1SH, MCP/E1SUH, MCP/E2SUHS, MCP/E2SH, MCP/E2SUH, MCP/E2SUT, MCP/E2SHB, ECP/E1ELHU, PCP/E1SH, PCP/E2SH, PCP/E2SH3B, PCP/E1ELH, OCP/E1SH, OCP/E2SH, TCP/E1ELHU, TCP/E2SH, TCP/E1ELH, FCV/E101/1, FCVE6L3J, FCV/E10L3JAP, FCV/E102/1L3JAP, FCV/E10L6JAP, FCV/E102/1L6JAP, FCVG6L3CJ, FCV/E61/1, FCV/E61/1, FCV/E101/1, FCV/E101/1, FCV/E102/1, FCV/E61/1, FCV/E61/1, FCV/E101/1, FCV/E101/2, FCV/G6L3C, FCV/G61/1, FCV/G61/1, FCV/G61/1, FCV/G61/1, FCV/G6L3CT, FCV/G6L3CJ, FCV/E10L3, FCV/E102/1, FCV/E102/1L3, FCV/E6L4, FCV/E101/1, FCV/E10L6, FCV/E102/1L6, FCV/E101/1, FVC/E101/1, FVC/E102/1...(Other models you can see in the webshop) | | |

¹with ball bearings



| | | | |
|------------------------|--|-----------------|-------------------|
| GEV No. | 601458 ¹ | Ref. No. | 0C2378 |
| description | axial fan L 119mm W 119mm H 38mm 230VAC 50Hz 19W bearing ball bearing manuf. no. 4656N metal connection male faston 2.8mm ebm-papst fan wheel ø 110mm temp.-resist. 85°C | | |
| For models: | KT/E1, KT/E2, KMV/E2C, QT/E1, QT/E2, WT/E1, WT/E2 | | |
| accessories for | 601458 | | |
| | GEV No. | 692497 | Ref. No. — |
| | guard ø 105mm mounting distance 150mm for axial fan ebm-papst-mm | | |

¹with ball bearings

import



| | | | |
|--------------------|---|-----------------|------------------|
| GEV No. | 601604 ¹ | Ref. No. | 088012 088034 |
| description | axial fan L 119mm W 119mm H 38mm 230VAC 50/60Hz 17/15W bearing slide bearing manuf. no. AA1282HS-AT connection cable 300mm fan wheel ø 110mm temp.-resist. 70°C input current 0.1A airflow 130m ³ /h 2600rpm | | |
| For models: | STRP1101, STRP1102, STRP1601, STRP1602, STRP1603, STRP2201, STRP2202, STRP2203, STRP1101S, STRP1601S, STRP2201S, STRP1602R, STRP1603R, STRP2201R, STRP2202R, STRP2203R, STRP1101R, STRP1102R, STRP1601R, SSODWC12, SSODDPC12, SSODWC16, SSODDPC16, SSODWB12, SSODDPB12, SSODWB16, SSODDPD16, SSWC12, SSWC16, SSWC20, SSWB12, SSWB16, SSWB20, SSODPC12, SSODPC16, SSODPC16, SSODPD12, SSODPD16, SSODPD20, SSODWCS12, SSODWCS16, SSODWC20, SSODDPC20, DVRVAF12, DVRPAF12, DVRVAF16, DVRPAF16, DVRVP12, DVRPP12, DVRVP16...(Other models you can see in the webshop) | | |

¹with slide bearings



| | | | |
|------------------------|--|-----------------|--|
| GEV No. | 601080 ¹ | Ref. No. | 002656 087945 0C4106 0C4423 0D6787 0E2261 0K7491 0W5643 |
| description | axial fan L 119mm W 119mm H 38mm 230VAC 50/60Hz 23/20W bearing ball bearing connection male faston 2.8mm metal ADDA fan wheel ø 110mm temp.-resist. 70°C | | |
| For models: | FCZ061EAA, FCZ101EAA, FCZ102EAA, FCZ201EAA, FCZ202EAA, FCZ061EAH, FCZ101EAH, FCZ201EAH, FCZ061EAN, FCZ101EAN, FCZ201EAN, FCZ061ETA, FCZ101ETA, FCZ102ETA, FCZ201ETA, FCZ202ETA, FCZ061ETH, FCZ101ETH, FCZ201ETH, FCZ061ETN, FCZ101ETN, FCZ201ETN, FCZ061GAG, FCZ101GAG, FCZ102GAG, FCZ201GAG, FCZ202GAG, FCZ061GAD, FCZ101GAD, FCZ102GAD, FCZ201GAD, FCZ202GAD, FCZ101GTG, FCZ102GTG, FCZ201GTG, FCZ202GTG, FCZ101GTD, FCZ102GTD, FCZ201GTD, FCZ202GTD, FCZ061EBA, FCZ101EBA, FCZ102EBA, FCZ201EBA, FCZ202EBA, FCZ061EBH, FCZ101EBH, FCZ201EBH, FCZ061EBN, FCZ101EBN...(Other models you can see in the webshop) | | |
| accessories for | 601080 | | |
| | GEV No. | 550898 | Ref. No. — |
| | connecting cable cable length 2000mm connection F 2.8 connection distance 7.9mm for axial flow fan | | |
| | GEV No. | 692519 | Ref. No. — |
| | guard L 120mm W 120mm plastic | | |

¹with ball bearings





| | | | |
|---|--|-----------------|-----------------|
|  | | | |
| 1 | | | |
| GEV No. | 601130 ¹ | Ref. No. | 006125 |
| description | axial fan L 80mm W 80mm H 25mm 230VAC 50/60Hz 13/14W bearing ball bearing connection male faston 2.8mm metal ADDA fan wheel ø 75mm temp.-resist. 70°C airflow 30.6m ³ /h | | |
| For models: | KI/E1, KI/E2, KI/E2E5, KFR/E2F, HFH/G430, HFH/E430, HFR/E830, HFH/G400U, HFH/G401U, HFH/G435, HFH/G435, QI/E1, QI/E2, QI/E2E5, QFR/E2F, ZFH/G430, ZFH/E430, ZFH/G435, ZFH/G435, WI/E1, WI/E2, WI/E2E5, WFR/E2F, AFR/E830, AFH/G435, AFH/E435 | | |
| accessories for | 601130 | | |
| | GEV No. | 550898 | Ref. No. |
| | connecting cable cable length 2000mm connection F 2.8 connection distance 7.9mm for axial flow fan | | |

¹with ball bearings

hot air motors

| | | | |
|--|---|-----------------|------------------|
|  | | | |
| 1 | | | |
| GEV No. | 511313 | Ref. No. | 005132 0K9191 |
| description | centring piece for fan motor | | |
| For models: | 5711-2-6, 5711-2-7, 5711-2-8, 5711-2-10, 5711-2-8CH, 5711-2-10CH, 5712-2-6, 5712-2-7, 5712-2-8, 5712-2-10, 5714-2-6, 5714-2-7, 5714-2-8, 5714-2-10, 5717-2-6, 5714-2-7, 5714-2-8, 5714-2-10, 5711-2-6L, 5711-2-7L, 5711-2-8L, 5711-2-10L, 5712-2-6L, 5712-2-7L, 5712-2-8L, 5712-2-10L, 5714-2-6L, 5714-2-7L, 5714-2-8L, 5714-2-10L, 5714-2-6L, 5714-2-7L, 5714-2-8L, 5714-2-10L, 5711-3-6, 5711-3-7, 5711-3-8, 5711-3-10, 5711-3-8CH, 5711-3-10CH, 5712-3-6, 5712-3-7, 5712-3-8, 5712-3-8E, 5712-3-10, 5712-3-8CH, 5712-3-10C, 5714-3-6, 5714-3-7, 5714-3-8...(Other models you can see in the webshop) | | |

| | | | |
|---|---|-----------------|----------------------------|
|  | | | |
| 1 | | | |
| GEV No. | 511302 | Ref. No. | 0H6643 0K2093 246195 |
| description | engine shaft gasket ID ø 16mm ED ø 40mm for 55/56 series | | |
| For models: | 5611-3-10, 5611-3-6, 5611-3-8, 5612-3-10, 5612-3-6, 5612-3-8, 5614-3-10, 5614-3-6, 5614-3-8 | | |

| | | | |
|---|---|-----------------|--------|
|  | | | |
| 1 | | | |
| GEV No. | 511314 | Ref. No. | 0H6862 |
| description | engine shaft gasket ID ø 19mm ED ø 30mm for 54 series | | |

| | | | |
|---|--|-----------------|----------------------------|
|  | | | |
| 1 | | | |
| GEV No. | 511303 | Ref. No. | 0H6644 0K2094 246196 |
| description | engine shaft gasket ID ø 27mm ED ø 40mm for 55/56 series | | |

| | | | |
|---|---|-----------------|--------|
|  | | | |
| 1 | | | |
| GEV No. | 511315 | Ref. No. | 0H6513 |
| description | engine shaft gasket ID ø 29mm ED ø 40mm for 54 series | | |

| | | | |
|--|--|-----------------|--|
|  | | | |
| 1 | | | |
| GEV No. | 601040 | Ref. No. | 054570 054829 058587+058729+3x058731 10521400 |
| description | fan motor | | |
| For models: | FCFG6D, FCFE6D, FCFE6D, FCFG6, FCFG6F, PFCFG6, FCFE6, FCFE6UK, PFCFE6, FCVE6-1U, FCVE6-3U, FCVE6-1, FCVE6-3, FCVE6-1UK, FCVE6-3UK, FCVG6-1, FCVG6-3, FCVG6-1UK, FCVG6-3UK, FCF/G6, FCF/E6, FCF/E6-1, FCF/E6-1, FCFV/G6-1, ZOFV/G6-3, AFCV/G6-1, AFCV/G6-3, COCO6G, COCO6E, COCVE423AF, FCFE061, ZOFV/G6D | | |

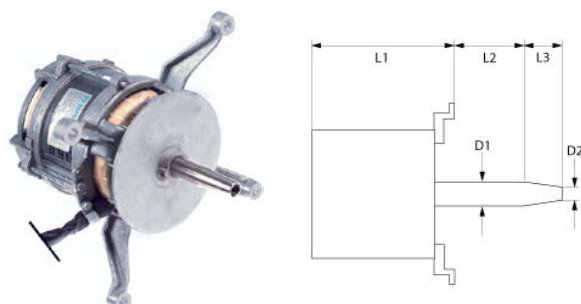
| | | | |
|--|---|-----------------|-------------------------------|
|  | | | |
| 1 | | | |
| GEV No. | 601351 | Ref. No. | 0H6556 0K1912 131058149 |
| description | fan motor 220-230V 3 phase 50Hz 0.02/0.16kW 710/1390rpm speeds 2 L1 150mm L2 27mm L3 35mm M10R IT 0.35/0.9A power input 60/250W at 50Hz 710/1390rpm type L7mw84D-149 no. R2 D1 ø 17mm D2 ø 13mm | | |

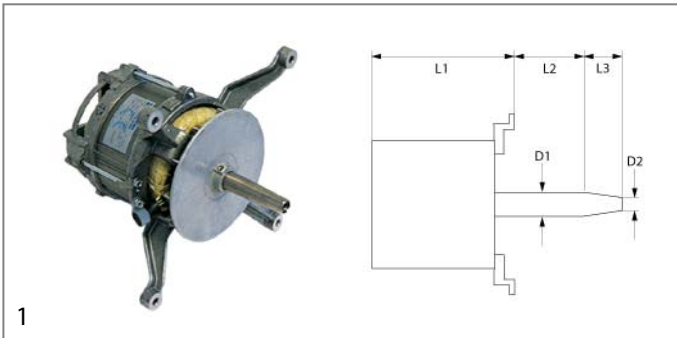

| | | | |
|------------------------|---|-----------------|-------------------------------|
| GEV No. | 500103 | Ref. No. | 0H6929 OK2763 131091099 |
| description | fan motor 220-240/380-415V 3 phase 50/60Hz 0.25kW 1400rpm speeds 1 L1 150mm L2 32mm L3 40mm ϕ 125mm M10R IT at 50Hz 1400rpm at 60Hz 1700rpm type L7Aw4D-099 no. X3 D1 ϕ 17mm D2 ϕ 14mm | | |
| For models: | 5611-3-6, 5612-3-6, 5614-3-6 | | |
| accessories for | 500103 | | |
| | GEV No. | 510537 | Ref. No. — |
| | GEV No. | 510539 | Ref. No. — |
| | GEV No. | 510541 | Ref. No. — |
| | GEV No. | 510572 | Ref. No. — |
| | GEV No. | 560309 | Ref. No. — |
| | GEV No. | 560312 | Ref. No. 0D0622 |
| | GEV No. | 601049 | Ref. No. — |
| | GEV No. | 601298 | Ref. No. — |

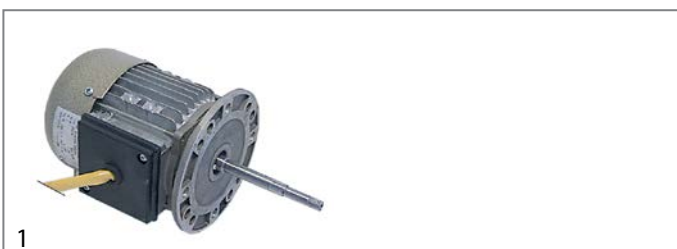

| | | | |
|--------------------|--|-----------------|------------------------------|
| GEV No. | 601041 | Ref. No. | 053826 054836 10522500 |
| description | fan motor 220-240/380-415V 3 phase 50Hz 0.19kW 1350rpm 1/0.58A | | |
| For models: | FCFG10, FCFG10D, FCFG10NL, FCFE10, FCFE10UK, FCVE10, FCVE10-2, FCVE10-4, FCVE10-2UK, FCVE10-4UK, FCVG10-2, FCVG10-4, FCVG10-2, FCVG10-4D, FCVG10-2UK, FCVG10-4UK, FCVG10-2, FCVG10-4, FCFG101, FCF/E10, ZOFVCV/E102, ZOFVCV/E104, ZOFVCV/G102, ZOFVCV/G104, COCO10G, COCO10E, FCFE101, ZOFVCV/G10D | | |

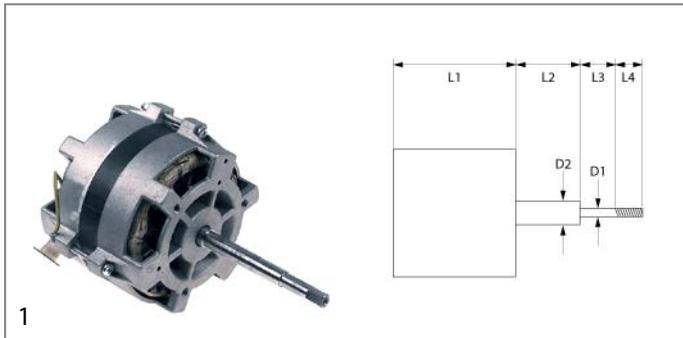

| | | | |
|------------------------|--|-----------------|----------------------------------|
| GEV No. | 601449 | Ref. No. | 058667 OK3026 10925440 |
| description | fan motor 220-240/380-415V 3 phase 50Hz 0.19kW 1350rpm speeds 1 L1 105mm L2 74mm L3 35mm L4 12mm D1 ϕ 9x10mm D2 ϕ 12mm M6R IT 0.58/1A type FIR1092 no. 1092 shaft flat length 9mm | | |
| For models: | FCFG10, FCFG10D, FCFG10NL, FCFE10, FCFE10UK, FCVE10-2, FCVE10-4, FCVE103CE, FCVE10-2UK, FCVE10-4UK, FCVG10-1SG, FCVE20VUK, FCFG101, ZOFVCV/E102, ZOFVCV/E104, FF/E10, FF/G10, COCO10G, COCO10E, FCVG10-1SG, FCFE101, ZOFVCV/G10D | | |
| accessories for | 601449 | | |
| | GEV No. | 693846 | Ref. No. 054830 058731 |
| | GEV No. | 693847 | Ref. No. 058729 |
| | GEV No. | 694297 | Ref. No. 058957 |

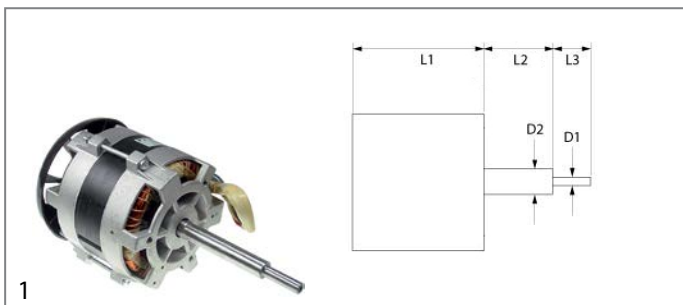

| | | | |
|--------------------|--|-----------------|---|
| GEV No. | 601378 | Ref. No. | 054011 054012 054837 058607 1093V5440 |
| description | fan motor 220-240/380-415V 3 phase 50Hz 0.35kW 1350rpm speeds 1 L1 143mm L2 91mm L3 34mm D1 ϕ 10mm D2 ϕ 16mm M6R IT 1.8/1A number of pole pairs 4 at 50Hz 1350rpm type FIR1093/V | | |
| For models: | FCFG20, FCFG20D, FCFG20F, PFCFG20, FCFE20, FCFE20UK, FCFG40, FCFG41, FCFG40D, FCFG40F, PFCFG40F, FCFE40, FCFE40D, FCFE40UK, PFCFE40F, FCVE20, FCVE20-2, FCVE20-4, FCVE203CE, FCVE20-2UK, FCVE20-4UK, FCVG20-2, FCVG20-4, FCVG20-2, FCVG20-4D, FCVG20-2UK, FCVG20-4UK, FCVG20-4, FCVG20-4D, FCFG201, FCFG202, FCFC202, FCF/E20, FCFE202, ZOFVCV/E202, ZOFVCV/E204, ZOFVCV/G202, ZOFVCV/G204, FF/E40, FF/E20, FF/G20, FF/G40, AFCE/E40, COCO20G, COCO20E, 4236N, 4238N, FCFE201, ZOFVCV/G20D | | |



| | | | |
|--------------------|--|-----------------|-------------------------------|
| GEV No. | 500836 | Ref. No. | 0H6925 131209037 280125 |
| description | fan motor 220-240/380-415V 3 phase 50Hz 0.37kW 1400rpm speeds 1 L1 175mm L2 47mm L3 31mm M14R IT 2.85/1.65A power input 580W Cos(fi) 0.55 at 50Hz 1400rpm type L9Cw4D-037 no. S2 D1 ø 23mm D2 ø 20mm | | |

| | | | |
|--------------------|---|-----------------|--------|
| GEV No. | 500814 | Ref. No. | 005750 |
| description | fan motor 230V 1 phase 50/60Hz 0.19kW 1400/1700rpm speeds 1 L1 145mm L2 51mm L3 35mm D1 ø 10mm D2 ø 16mm M6R IT 1.3A at 50Hz 1400rpm at 60Hz 1700rpm suitable capacitor 10µF shaft flat length 12mm | | |
| For models: | FCV/G6L3C, FCV/G61/1, FCV/G61/1, FCV/G6L3CT, FCS061G3DI, FC-S061G4DT, RCV061G2, ACV/G6C3C | | |

| | | | |
|--------------------|--|-----------------|-----------|
| GEV No. | 500105 | Ref. No. | 131091093 |
| description | fan motor 220-240/380-415V 3 phase 50Hz 0.37kW 1400rpm speeds 1 L1 182mm L2 26mm L3 50mm ø 125mm M14R IT 2.85/1.65A power input 580W Cos(fi) 0.55 at 50Hz 1400rpm type L9Cw4D-161 no. R7 D1 ø 25mm D2 ø 20mm | | |

| | | | |
|------------------------|--|-----------------|---|
| GEV No. | 500141 | Ref. No. | 002616 0F0007 0K8482 0KE545 |
| description | fan motor 230V 1 phase 50/60Hz 0.19kW 1450/1750rpm speeds 1 L1 150mm L2 52mm L3 35mm D1 ø 9/10mm D2 ø 14mm M6R IT 1.3A Cos(fi) 0.91 at 50Hz 1450rpm at 60Hz 1750rpm type LM80/4 no. 596477 shaft flat length 12mm | | |
| For models: | FCV/G10L3, FCV/G6L3TOWNGAS, FCV/G6L3, FCV/G10L3T, FCV/E101/1, FCV/G20L3, FCVE6L3J, FCV/E10L3JAP, FCV/E61/1, FCV/G10L2, FCV/E101/1, FCV/E10L2, FCV/E61/1, FCV/E101/2, FCV/E10L3, FCV/E6L3, FCV/E20L3, FCV/E101/1, FCF/G6-0, FCFG101/0, FCFG102-0, FCFG201-0, FCF/E6-0, FCFE101-0, FCFE102-0, FCFE201-0, FCFE202-0, FCF061ELN, FCF101ELN, FCF6EHOR, FCFG10160H, FCF061ENS, FCF101ENS, FCF102ENS, FCF201ENS, FCFG102-0T, FCFE6-1J, FCFE101-1J, FCFE102-1J, FCF/G101/1, FCS061E3CI, FC-S101E2, FCS101G2, CS7ME4/200-3, CS7ME4/230-3, CS7ME4/400-3N, CS7ME6/400-3N, CS7ME4/400-3N/EO, CS7ME4/400-3/50HZ/MA, CS-7ME4/440-3/60HZ/MA...(Other models you can see in the webshop) | | |
| accessories for | 500141 | | |
| GEV No. | 365139 | Ref. No. | 056148 0U0403 416332729 754000 |
| description | operating capacitor capacity 10µF 450V tolerance 5% 60Hz ambient temperature max. -25 up to +70°C ø 40mm L 83mm M8 aluminium connection male faston 6.3mm C.87.8BF2 MKP protection | | |

| | | | |
|--------------------|--|-----------------|--------------------|
| GEV No. | 601360 | Ref. No. | 058587 10922330 |
| description | fan motor 220V 1 phase 50Hz 0.1kW 1350rpm speeds 1 L1 105mm L2 66mm L3 35mm D1 ø 10mm D2 ø 12mm M6R IT 0.9A number of pole pairs 4 suitable capacitor 4µF/450V at 50Hz 1350rpm type FIR1092/M | | |
| For models: | FCFG6D, FCVE6D, FCVE6D, FCFG6, FCFG6F, PFCFG6, FCVE6, FCVE6UK, PFCVE6, FCVE6-1U, FCVE6-3U, FCVE6-1, FCVE6-3, FCVE6-3CE, FCVE6-1UK, FCVE6-3UK, FCVG6-1, FCVG6-3, FCVG6-1UK, FCVG6-3UK, FCF/G6, FCF/E6, FCV/E6-1, FCV/E6-1, FCV/G6-1, ZOFV/G6-3, AFCV/G6-1, AFCV/G6-3, SCO/G6-3, AFCF/E6, FF/G6, COCO6G, COCO6E, COCVE423AF, FCVE061, ZOFV/G6D | | |

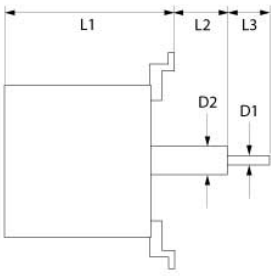

| | | | |
|--------------------|---|-----------------|--------|
| GEV No. | 501574 | Ref. No. | OC5287 |
| description | fan motor 230V 1 phase 50/60Hz 0.24/0.31kW 1400/1700rpm L1 143mm L2 52mm L3 35mm D1 ø 10mm D2 ø 11mm M5 1.1/1.4A Cos(f) 0.94/0.96 at 50Hz 230V at 60Hz 230V at 50Hz 1400rpm at 60Hz 1700rpm with capacitor type FIR no. 1096A2350 | | |
| For models: | FCZ061EAA, FCZ101EAA, FCZ061EAH, FCZ101EAH, FCZ061EAN, FCZ101EAN, FCZ061ETA, FCZ101ETA, FCZ201ETA, FCZ061ETH, FCZ101ETH, FCZ201ETH, FCZ061ETN, FCZ101ETN, FCZ201ETN, FCZ101GTG, FCZ201GTG, FCZ101GTD, FCZ201GTD, FCZ061EBA, FCZ101EBA, FCZ061EBH, FCZ101EBH, FCZ061EBN, FCZ101EBN, FCZ061EBC, FCZ101EBC, FCZ061EBA2, FCZ101EBA2, FCZ201EBA2, FCZ061EBN2, FCZ101EBH2, FCZ201EBH2, FCZ061EBN2, FCZ101EBN2, FCZ201EBN2, FCZ061EBC2, FCZ101EBC2, FCZ201EBC2, FCZ101GBG2, FCZ201GBG2, FCZ101GBD2, FCZ201GBD2, FCZ101GBI2, FCZ201GBI2, FCZ061ECA, FCZ101ECA, FCZ061ECH, FCZ101ECH, FCZ061ECN... (Other models you can see in the webshop) | | |

| | | | |
|--------------------|--|-----------------|--------|
| GEV No. | 500143 | Ref. No. | 002739 |
| description | fan motor 230V 1 phase 50/60Hz 0.35kW 1400/1700rpm speeds 1 L1 165mm L2 91mm L3 35mm D1 ø 9/10mm D2 ø 16mm M6R IT 2.7A Cos(f) 0.9 at 50Hz 230V at 60Hz 230V at 50Hz 1400rpm at 60Hz 1700rpm suitable capacitor 16µF/450V type LM80/4 no. 556749 shaft flat length 13mm | | |
| For models: | FCVG102L3, FCGV202L3, FCV/E102/1L3JAP, FCV/E102/1, FCV/E102/1L3, FCVE202L3, FCFG101/0, FCFG102-0, FCFG202-0, FCFE101-0, FCFE102-0, FCFE201-0, FCFE202-0, FCF101ELN, FCF101ENS, FCF102ENS, FCF201ENS, FCFG102-0T, FCFE101-1J, FCFE102-1J, 5717-2-6, 5714-2-6L, 5707-2-2, 5707-3-2, ECFG101-0, ECFG102-0, ECFG202-0, ECFE101-0, ECFE102-0, ECFE201-0, ECFE202-0, ECF101ENS, ECF102ENS, ECF201ENS, ACFG101-0, ACFG102-0, ACFG202-0, ACFE101-0, ACFE102-0, ACFE201-0, ACFE202-0, JCF/G102/1-1, JCF/E102/1-1, RCF101G, RCF101E, RCF201E, NCF/G101/1, NCF/G102/1, NCF/E102/1, ZCF/G101/1...(Other models you can see in the webshop) | | |

| | | | |
|--------------------|--|-----------------|--------|
| GEV No. | 601222 | Ref. No. | 006998 |
| description | fan motor 230V 1 phase 50Hz 0.06/0.19kW 890/1395rpm speeds 2 L1 165mm L2 49mm L3 35mm D1 ø 10mm D2 ø 16mm M6R IT 1.6/1.4A Cos(f) 0.85 at 50Hz 230V at 60Hz 230V at 50Hz 890/1395rpm at 60Hz 950/1695rpm suitable capacitor 12.5µF/450V 4P/6P type LM/FB80 no. 496040 shaft flat length 13mm | | |
| For models: | FCZ061EAA, FCZ101EAA, FCZ201EAA, FCZ061EAH, FCZ101EAH, FCZ201EAH, FCZ061EAN, FCZ101EAN, FCZ201EAN, FCZ061ETA, FCZ101ETA, FCZ201ETA, FCZ061ETH, FCZ101ETH, FCZ201ETH, FCZ061ETN, FCZ101ETN, FCZ201ETN, FCZ061GAG, FCZ101GAG, FCZ201GAG, FCZ061GAD, FCZ101GAD, FCZ201GAD, FCZ101GTG, FCZ201GTG, FCZ101GTD, FCZ201GTD, FCZ061EBA, FCZ101EBA, FCZ201EBA, FCZ061EBH, FCZ101EBH, FCZ201EBH, FCZ061EBN, FCZ101EBN, FCZ201EBN, FCZ061EBC, FCZ101EBC, FCZ201EBC, FCZ061EBA2, FCZ101EBA2, FCZ201EBA2, FCZ061EBH2, FCZ101EBH2, FCZ201EBH2, FCZ061EBN2, FCZ101EBN2, FCZ201EBN2...(Other models you can see in the webshop) | | |

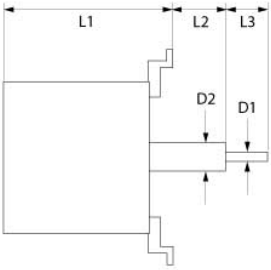

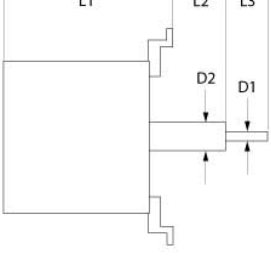

| | | | |
|--------------------|--|-----------------|------------------|
| GEV No. | 500142 | Ref. No. | 002698 005028 |
| description | fan motor 230V 1 phase 50Hz 0.06/0.19kW 930/1380rpm speeds 2 L1 160mm L2 52mm L3 35mm D1 ø 9/10mm D2 ø 16mm M6R IT 1.5/0.7A Cos(f) 0.9 at 50Hz 930/1380rpm at 60Hz 1100/1700rpm suitable capacitor 12.5µF/400V 4P/6P type LM/FB80 no. 552059 shaft flat length 12mm | | |
| For models: | FCV/E10L6JAP, FCV/E61/1, FCV/E101/1, FCV/E61/1, FCV/E101/1, FCV/G61/1, FCV/G6L4, FCV/E6L4, FCV/G10L6, FCV/E10L6, FCV/G20L6, FCV/E20L6, FCV/E101/1, FCV/G101/1, FVC/E101/1, FCV/G201/1, FVC/E201/1, FCS061E44J, FCS061EP, FCS101E44J, FCS101EP4J, FCS101E4, FCS101G4, FCS101EP, FCS101G4DT, FCS101GP, FCS201E4, FCS201EP, FCS201G4, FCS201GP, FCS061E4, FCS061EXLN, FCS061EX, FCS101EX4J, FCS101EX, FCS201EX, FCS101GX, FCS201GX, 5711-2-7, 5711-2-8, 5711-2-10, 5711-2-8CH, 5711-2-10CH, 5712-2-7, 5712-2-8, 5712-2-10, 5714-2-7, 5714-2-8, 5714-2-10, 5711-2-7L...(Other models you can see in the webshop) | | |

1

| | | | |
|--------------------|--|-----------------|--------|
| GEV No. | 500653 | Ref. No. | 005748 |
| description | fan motor 230V 1 phase 50Hz 0.06/0.19kW 930/1425rpm speeds 2 L1 150mm L2 52mm L3 35mm D1 ø 10mm D2 ø 16mm M6R IT 1.3/0.8A power input 0.19W at 50Hz 930/1425rpm suitable capacitor 10µF shaft flat length 12mm | | |
| For models: | FCV/G61/1, FCS061GP, FCS061G4, 5721-2-7, 5721-2-10, ECV/G6T4C, ECV/G61/1, ECV/G61/1, ZCV/G6T4C, ZCV/G61/1 | | |



1

| | | | |
|--------------------|---|-----------------|-------------------------------|
| GEV No. | 500816 | Ref. No. | OC1171 OC6563 611810000 |
| description | fan motor 230V 1 phase 50Hz 0.22/0.75kW 955/1460rpm speeds 2 L1 175mm L2 52mm L3 32mm D1 ø 10mm D2 ø 16mm M6R IT 1.0/2.4A number of pole pairs 4P/6P Cos(fi) 0.84 at 50Hz 230V at 60Hz 230V at 50Hz 955/1460rpm at 60Hz 1145/1750rpm suitable capacitor 31.5/16µF 4P/6P type LM/FB 100L no. 494886 shaft flat length 13mm | | |
| For models: | FCZ102EAA, FCZ202EAA, FCZ102ETA, FCZ202ETA, FCZ102GAG, FCZ202GAG, FCZ102GAD, FCZ202GAD, FCZ102GTG, FCZ202GTG, FCZ102GTD, FCZ202GTD, FCZ102EBA, FCZ202EBA, FCZ102EBA2, FCZ202EBA2, FCZ102GBG, FCZ202GBG, FCZ102GBD, FCZ202GBD, FCZ102GBG2, FCZ202GBG2, FCZ102GBD2, FCZ202GBD2, FCZ102GBI2, FCZ102ECA, FCZ102ECA2, FCZ202ECA2, FCZ102GCG2, FCZ202GCG2, FCZ102GCD2, FCZ202GCD2, AOS102GAEU, AOS202GAEU, AOS102EA2N, AOS102EB2N, AOS202EA2N, AOS202EB2N, AOS102EA, AOS102EB, AOS202EA, AOS202EB, AOS102GB, AOS102GA, AOS202GB, AOS202GA, AOS102EAAQ, AOS102EBAQ, AOS202EAAQ, AOS202EBAQ...(Other models you can see in the webshop) | | |



1

| | | | |
|--------------------|---|-----------------|--------------------------------------|
| GEV No. | 500144 | Ref. No. | 002748 005237 0K2755 0K2764 |
| description | fan motor 230V 1 phase 50Hz 0.11/0.35kW 900/1400rpm speeds 2 L1 165mm L2 91mm L3 35mm D1 ø 9/10mm D2 ø 16mm M6R IT 2.7/1.3A at 50Hz 230V at 60Hz 230V at 50Hz 900/1400rpm at 60Hz 1080/1680rpm suitable capacitor 16µF/450V 4P/6P type LM/FB80 no. 358008 shaft flat length 12mm | | |
| For models: | FCV/E102/1L6JAP, FCV/E102/1, FCV/G102/1L6, FCV/E102/1L6, FCVG202L6, FCVE202L6, FCV/G102/1, FVC/E102/1, FCV/G202/1, FVC/E202/1, FCS102E44J, FCS102EP4J, FCS102E4, FCS102EP, FCS102G4, FCS202E4, FCS102GP, FCS202EP, FCS202G4, FCS202GP, FCS102EX4J, FCS102EX, FCS202EX, FCS102GX, FCS202GX, 5714-2-7, 5714-2-8, 5714-2-10, 5714-2-7L, 5714-2-8L, 5714-2-10L, 5717-3-7, 5717-3-8, 5717-3-8E, 5717-3-10, 5717-3-8C, 57074-2-3, 5707-3-3, ECVG102T4, ECV102T4, ECVG202T4, ECVE202T4, ECV/G102/1T6, ECV/E102/1T6, ECVG202T6, ECVE202T6, JCF/G102/1-2, JCF/E102/1-2, ACVG102C4, ACVG202C4...(Other models you can see in the webshop) | | |



1

| | | | |
|--------------------|---|-----------------|--------|
| GEV No. | 602159 | Ref. No. | 058807 |
| description | fan motor 240V 1 phase 50Hz 0.1kW 1350rpm L1 105mm L2 66mm L3 35mm D1 ø 10mm D2 ø 12mm M6 IT 0.83A suitable capacitor 4µF/450V at 50Hz 1350rpm type FIR1092/M no. 611803301 | | |
| For models: | FCFE6D, FCVE6D, FCFE6, FCVE6UK, PFCFE6, FCVE6-1U, FCVE6-3U, FCVE6-1, FCVE6-3, FCVE6-1UK, FCVE6-3UK, FCVG6-1, FCVG6-3, FCVG6-1UK, FCVG6-3UK, FCF/E6, FCV/E6-1, FCV/E6-1, FCV/G6-1, ZOFCV/G6-3, COCO6E, FCFE061 | | |



1

| | | | |
|--------------------|---|-----------------|------------------|
| GEV No. | 601352 | Ref. No. | 0H6555 0K1910 |
| description | fan motor 380-400V 3 phase 50Hz 0.02/0.16kW 710/1390rpm speeds 2 L1 140mm L2 27mm L3 35mm M10R IT 0.2/0.5A power input 60/250W at 50Hz 710/1390rpm Y/YY type L7mw84D-148 no. T1 D1 ø 17mm D2 ø 13mm | | |

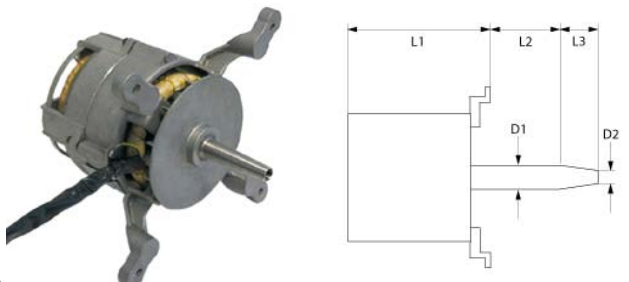

1

| | | | |
|--------------------|---|-----------------|----------------------------|
| GEV No. | 500108 | Ref. No. | OG2197 0H6930 0H6958 |
| description | fan motor 380-415V 3 phase 50/60Hz 0.03/0.2kWrpm speeds 2 L1 155mm L2 30mm L3 31mm M10R IT Y/YY type L7mw84D-097 no. V5 D1 ø 17mm D2 ø 13mm | | |
| For models: | 5611-3-10, 5611-3-8, 5612-3-10, 5612-3-8, 5614-3-10, 5614-3-8 | | |

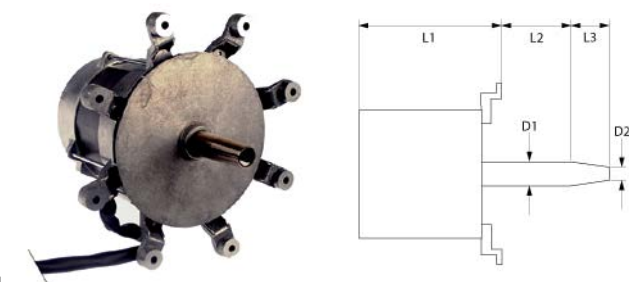

1

| | | | |
|--------------------|--|-----------------|-------------------------------|
| GEV No. | 601367 | Ref. No. | 0H6933 131098094 280162 |
| description | fan motor 380-415V 3 phase 50/60HzkWrpm speeds 2 L1 175mm L2 25mm L3 48mm M14R IT Y/YY type L9rw84D-094 no. U3 D1 ø 25mm D2 ø 20mm | | |



1

| | | | |
|---|---|-----------------|-------------------|
| GEV No. | 602139 | Ref. No. | 0H6932 |
| description | fan motor 440-480V 3 phase 60Hz 0.37kW 1600rpm L1 185mm L2 26mm L3 50mm type L9Cw4D-157 D1 ø 25mm D2 ø 20mm | | |
| accessories for | 602139 | | |
|  | GEV No. | 510574 | Ref. No. — |
| | shaft sealing type 20 for fan motor | | |



1

| | | | |
|--------------------|---|-----------------|------------------|
| GEV No. | 602082 | Ref. No. | 002740 0C8306 |
| description | fan wheel blades 6 D1 ø 440mm D2 ø 10mm D3 ø 10mm H1 154mm H2 15mm | | |
| For models: | FCVG102L3, FCVG202L3, FCV/E102/1L3, FCVE202L3, FCV/G102/1L6, FCV/E102/1L6, FCVG202L6, FCVE202L6, FCV/G102/1, FVC/E102/1, FCV/G202/1, FVC/E202/1, FCFE101-0, FCFE102-0, FCFE201-0, FCFE202-0, FCF101ELN, FCF101ENS, FCF102ENS, FCF201ENS, FCFE101-1J, FCFE102-1J, FCS102E4, FCS102EP, FCS102G4, FCS202E4, FCS102GP, FCS202EP, FCS202G4, FCS202GP, FCS102EX, FCS202EX, FCS102GX, FCS202GX, 5717-2-6, 5714-2-7, 5714-2-8, 5714-2-10, 5714-2-6L, 5714-2-7L, 5714-2-8L, 5714-2-10L, 5717-3-7, 5717-3-8, 5717-3-8E, 5717-3-10, 5717-3-8M, 5717-3-8C, 5717-3-8M, 5707-2-2... (Other models you can see in the webshop) | | |



1

| | | | |
|--------------------|--|-----------------|------------------|
| GEV No. | 601365 | Ref. No. | OG1989 280036 |
| description | fan wheel D1 ø 225mm H1 60mm blades 12 D2 ø 19.5mm D3 ø 23mm H2 25.5mm | | |



1

| | | | |
|--------------------|--|-----------------|------------------|
| GEV No. | 601235 | Ref. No. | 054585 055422 |
| description | fan wheel D1 ø 280mm H1 100mm blades 6 D2 ø 10mm D3 ø 10mm H2 37mm H3 10mm | | |
| For models: | FCFG6D, FCFE6D, FCFE6D, FCFG6, FCFG6F, PFCFG6, FCFE6, FCFE6UK, PFCFE6, FCFE6J50, FCFG6J, FCFG6J, FCVE6-1U, FCVE6-3U, FCVE6-1, FCVE6-3, FCVE6-3CE, FCVE6-1UK, FCVE6-3UK, FCFG6-1, FCFG6-3, FCFG6-1UK, FCFG6-3UK, FCF/G6, FCF/E6, FCV/E6-1, FCV/E6-1, FCV/G6-1, ZOFV/G6-3, AFCV/G6-1, AFCV/G6-3, SCO/G6-3, AFCF/E6, FF/G6, COCO6G, COCO6E, COCVE423AF, FCFE061, ZOFV/G6D | | |



1

| | | | |
|--------------------|---|-----------------|--|
| GEV No. | 601220 | Ref. No. | 002754 003560 0C6462 0F0176 0K2704 0K8507 |
| description | fan wheel D1 ø 280mm H1 100mm blades 6 D2 ø 10mm D3 ø 10mm H2 37mm H3 22mm | | |
| For models: | FCV/G6L3TOWNGAS, FCV/G6L3, FCVG6L3CJ, FCV/G6L3C, FCV/G61/1, FCV/G61/1, FCV/G61/1, FCV/G61/1, FCVG6L3CT, FCVG6L3CJ, FCV/E6L3, FCV/G6L4, FCV/E6L4, FCF/G6-0, FCF/E6-0, FCF061ELN, FCF6EHOR, FCF061ENS, FCF/G6-1-JAP, FCFE6-1J, FCS061G48J, FCS061GP, FCS061EP, FCS061G3DI, FCS061E3CI, FCS061G4, FCS061G4DT, FCS061E4, FCS061EXLN, FCS061EX, CS7ME4/200-3, CS7ME4/230-3, CS7ME4/400-3N, CS7ME6/400-3N, CS7ME4/400-3N/EO, CS7ME4/400-3/50HZ/MA, CS7ME4/440-3/60HZ/MA, CS7MT4/400-3N, CS7GE4/200-3, CS7GE4/230-3, CS7GE4/400-3N, CS7GE6/400-3N, CS7GE4/400-3N/EO, CS7GE4/400-3/50HZ/MA, CS7GE4/440-3/60HZ/MA, CS7GT4/400-3N, CS7LCE4/200-3, CS7LCE4/230-3, CS7LCE4/400-3N, CS7LCE6/400-3N...(Other models you can see in the webshop) | | |



1

| | | | |
|--------------------|---|-----------------|----------------------------|
| GEV No. | 601371 | Ref. No. | 002871 0C8325 0K2739 |
| description | fan wheel D1 ø 280mm H1 100mm blades 6 D2 ø 10mm D3 ø 10mm H2 37mm H3 23mm | | |
| For models: | FCVE6L3J, FCV/G6L3JAP, FCV/E61/1, FCV/E61/1, FCV/E61/1, FCV/E61/1, FCV/G61/1, FCV/G61/1, FCV/G61/1, FCV/G61/1, FCVG6L3CJ, FCV/G6L4, FCV/E6L4, FCF/G6-1-JAP, FCFE6-1J, FCS061E44J, FCS061G49J, 5711-2-6, 5711-2-7, 5711-2-8, 5711-2-10, 5711-2-8CH, 5711-2-10CH, 5711-2-6L, 5711-2-7L, 5711-2-8L, 5711-2-10L, 5721-2-7, 5721-2-10, 5711-3-6, 5711-3-7, 5711-3-8, 5711-3-10, 5711-3-8CH, 5711-3-10CH, 5711-3-10S, 5701-3-2, 5701-3-3, ECV/G6T4, ECV/E6T4, ECV/G61/1, ECV/G61/1, RCV061E4, ZCV/G61/1, ZCV/G6T4, ZCV/E6T4 | | |



1

| | | | |
|--------------------|---|-----------------|-----------------------------|
| GEV No. | 601344 | Ref. No. | 0H6507 237139 8330078 |
| description | fan wheel D1 ø 280mm H1 127mm blades 12 D2 ø 13mm D3 ø 16mm H2 37mm | | |
| For models: | 5611-3-10, 5611-3-6, 5611-3-8 | | |



1

| | | | |
|--------------------|--|-----------------|------------------|
| GEV No. | 601236 | Ref. No. | 007000 0C7029 |
| description | fan wheel D1 ø 280mm H1 130mm blades 10 D2 ø 10mm D3 ø 10mm H2 38mm H3 23mm | | |
| For models: | FCZ061EAA, FCZ061EAH, FCZ061EAN, FCZ061ETA, FCZ061ETH, FCZ061ETN, FCZ061GAG, FCZ061GAD, FCZ061EBA, FCZ061EBH, FCZ061EBN, FCZ061EBC, FCZ061EBA2, FCZ061EBH2, FCZ061EBN2, FCZ061EBC2, FCZ061GBG, FCZ061GBD, FCZ061GBI, FCZ061ECA, FCZ061ECH, FCZ061ECN, FCZ061ECA2, FCZ061ECH2, FCZ061ECN2, FCZ061GCG, FCZ061GCD, AOS061GAEU, AOS061GAAU, AOS061EABU, AOS061EAFU, AOS061EA, AOS061EB, AOS061EA3J, AOS061EB3J, AOS061EA2N, AOS061EB2N, AOS061EB5M, AOS061EB6M, AOS061EA0H, AOS061EB0H, AOS061GA, AOS061GB, AOS061EAAQ, AOS061EBAQ, AOS061EANQ, AOS061EBNQ, AOS061EACQ, AOS061EBCQ, AOS061EAHQ...(Other models you can see in the webshop) | | |



1

| | | | |
|--------------------|--|-----------------|---|
| GEV No. | 601343 | Ref. No. | 0H6510 0H6946 0K2738 237146 8330117 |
| description | fan wheel D1 ø 350mm H1 127mm blades 6 D2 ø 13mm D3 ø 16mm H2 37mm | | |
| For models: | 5612-3-10, 5612-3-6, 5612-3-8, 5614-3-10, 5614-3-6, 5614-3-8 | | |



1

| | | | |
|--------------------|---|-----------------|----------------------------|
| GEV No. | 601219 | Ref. No. | 002617 0C6461 0KG540 |
| description | fan wheel D1 ø 350mm H1 135mm blades 6 D2 ø 10mm D3 ø 10mm H2 13mm H3 24mm | | |
| For models: | FCV/G10L3, FCVG10L3T, FCV/G20L3, FCV/G10L2, FCV/E10L2, FCV/E10L3, FCV/E20L3, FCV/G10L6, FCV/E10L6, FCV/G20L6, FCV/E20L6, FCV/E101/1, FCV/G101/1, FVC/E101/1, FCV/G201/1, FVC/E201/1, FCFE101-0, FCFE102-0, FCFE201-0, FCFE202-0, FCF101ELN, FCF101ENS, FCF102ENS, FCF201ENS, FCFE101-1J, FCFE102-1J, FCS101E2, FCS101G2, FCS101E4, FCS101G4, FCS101EP, FCS101GP, FCS201E4, FCS201EP, FCS201G4, FCS201GP, FCS101EX, FCS201EX, FCS101GX, FCS201GX, 5712-2-6, 5712-2-7, 5712-2-8, 5712-2-10, 5714-2-6, 5714-2-7, 5714-2-8, 5714-2-10, 5712-2-6L, 5712-2-7L...(Other models you can see in the webshop) | | |



1

| | | | |
|--------------------|--|-----------------|------------------|
| GEV No. | 601197 | Ref. No. | 053782 054890 |
| description | fan wheel D1 ø 350mm H1 135mm blades 6 D2 ø 9.5mm D3 ø 9.5mm H2 38mm H3 20mm | | |
| For models: | FCFG101/0, FCFG102-0, FCFG201-0, FCFE101-0, FCFE201-0, FCF101ELN, FCFG102-0T, FCF/G101/1-1-JAP, FCFG10, FCFG10D, FCFG10NL, FCFE10, FCFE10UK, FCVE10, FCFG10J, FCFE10J, FCFG10J, FCVE10-2, FCVE10-4, FCVE103CE, FCVE10-2UK, FCVE10-4UK, FCVG10-2, FCVG10-4, FCVG10-4, FCVE10-P, FCVE10PUK, FCVG10-2, FCVG10-4, FCVG10-4, FCVG10-2, FCVG10-4D, FCVG10-2UK, FCVG10-4UK, FCVG10-2, FCVG10-4, FCVE10-P, FCVE10PUK, FCVG10-P, FCVG10PUK, ECFG101-0, ECFG102-0, ECFG201-0, ECFE101-0, FCFG101, FCF/E10, ZOFVCV/E102, ZOFVCV/E104, ZOFVCV/G102, ZOFVCV/G104, ACFG101-0, ACFG102-0, ACFG201-0, ACFE101-0, ACFE201-0...(Other models you can see in the webshop) | | |



1

| | | | |
|--------------------|--|-----------------|------------------|
| GEV No. | 601233 | Ref. No. | 0C1129 0C6463 |
| description | fan wheel D1 ø 350mm H1 135mm blades 6 D2 ø 10mm D3 ø 10mm H2 37.5mm | | |
| For models: | FCZ101EAA, FCZ201EAA, FCZ101EAH, FCZ201EAH, FCZ101EAN, FCZ201EAN, FCZ101ETA, FCZ201ETA, FCZ101ETH, FCZ201ETH, FCZ101ETN, FCZ201ETN, FCZ101GAG, FCZ201GAG, FCZ101GAD, FCZ201GAD, FCZ101GTG, FCZ201GTG, FCZ101GTD, FCZ201GTD, FCZ101EBA, FCZ201EBA, FCZ101EBH, FCZ201EBH, FCZ101EBN, FCZ201EBN, FCZ101EBC, FCZ201EBC, FCZ101EBA2, FCZ201EBA2, FCZ101EBH2, FCZ201EBH2, FCZ101EBN2, FCZ201EBN2, FCZ101EBC2, FCZ201EBC2, FCZ101GBG, FCZ201GBG, FCZ101GBD, FCZ201GBD, FCZ101GBI, FCZ201GBI, FCZ101GBG2, FCZ201GBG2, FCZ101GBD2, FCZ201GBD2, FCZ101GBI2, FCZ201GBI2, FCZ101ECA, FCZ201ECA...(Other models you can see in the webshop) | | |



1

| | | | |
|--------------------|--|-----------------|------------------|
| GEV No. | 601234 | Ref. No. | 0C1172 0C6464 |
| description | fan wheel D1 ø 380mm H1 170mm blades 12 D2 ø 10mm D3 ø 10mm H2 38mm H3 19mm | | |
| For models: | FCZ102EAA, FCZ202EAA, FCZ102ETA, FCZ202ETA, FCZ102GAG, FCZ202GAG, FCZ102GAD, FCZ202GAD, FCZ102GTG, FCZ202GTG, FCZ102GTD, FCZ202GTD, FCZ102EBA, FCZ202EBA, FCZ102EBA2, FCZ202EBA2, FCZ102GBG, FCZ202GBG, FCZ102GBD, FCZ202GBD, FCZ102GBG2, FCZ202GBG2, FCZ102GBD2, FCZ202GBD2, FCZ102GBI2, FCZ102ECA, FCZ202ECA, FCZ102ECA2, FCZ202ECA2, FCZ102GCG, FCZ202GCG, FCZ102GCD, FCZ202GCD, FCZ102GCG2, FCZ202GCG2, FCZ102GCD2, FCZ202GCD2, AOS102GAEU, AOS202GAEU, AOS102GAU, AOS202GAU, AOS102EA2N, AOS102EB2N, AOS202EA2N, AOS202EB2N, AOS102EA, AOS102EB, AOS202EA, AOS202EB, AOS102GB...(Other models you can see in the webshop) | | |



1

| | | | |
|--------------------|---|-----------------|--------------------------------------|
| GEV No. | 601218 | Ref. No. | 000274 054014 054914 055378 |
| description | fan wheel D1 ø 440mm H1 152mm blades 6 D2 ø 10mm D3 ø 10mm H2 37mm H3 31mm | | |
| For models: | FCFE102-0, FCFE202-0, FCFG20, FCFG20D, FCFG20F, PFCFG20, FCFE20, FCFE20UK, FCFG40, FCFG41, FCFG40D, FCFG40F, PFCFG40F, FCFE40, FCFE40D, FCFE40UK, PFCFE40F, FCVE20, FCFG20J, FCFE20J, FCFG40J, FCFE40J, FCFG20J, FCFG41J, FCVE20-2, FCVE20-4, FCVE203CE, FCVE20-2UK, FCVE20-4UK, FCFG20-2, FCFG20-4, FCFG20-2, FCFG20-4D, FCFG20-2UK, FCFG20-4UK, FCFG20-4, FCFG20-4D, FCVE20-P, FCVE20PUK, FCFG20-P, ECFE102-0, FCFG-20PUK, FCFG201, FCFG202, FCF202, FCF/E20, FCFE202, ZOFCV/E202, ZOFCV/E204, ZOFCV/G202...(Other models you can see in the webshop) | | |



1

| | | | |
|--------------------|--|-----------------|--------|
| GEV No. | 693847 | Ref. No. | 058729 |
| description | fixing plate for hot air motors ED ø 230mm H 2.5mm ID ø 16mm | | |
| For models: | FCFG6D, FCFE6D, FCFE6D, FCFG10, FCFG10D, FCFG10NL, FCFE10, FCFE10UK, FCFG6, FCFG6F, PFCFG6, FCFE6, FCFE6UK, PFCFE6, FCFE6J50, FCFE6J60, FCFG10J, FCFG10J, FCFE10J, FCFE10J, FCFG6J, FCFG6J, FCFG6J, FCFG6J, FCFG10J, FCFG10J, FCVE6-1U, FCVE6-3U, FCVE6-1, FCVE6-3, FCVE6-3CE, FCVE6-1UK, FCVE6-3UK, FCFG6-1, FCFG6-3, FCFG6-1UK, FCFG6-3UK, FCVE10-2, FCVE10-4, FCVE103CE, FCVE10-2UK, FCVE10-4UK, FCFG10-1SG, FCVE20/P-V, FCVE20-V, FCVE20VUK, FCFVM62E, FCFVM62EUK, FCFVM62, FCVE10-P...(Other models you can see in the webshop) | | |



2

| | | | |
|--------------------|--|-----------------|------------------|
| GEV No. | 601232 | Ref. No. | 003715 0C8307 |
| description | fan wheel D1 ø 440mm H1 155mm blades 6 D2 ø 10mm D3 ø 16mm H2 51mm H3 39mm | | |
| For models: | FCFG101/0, FCFG102-0, FCFG202-0, FCFG102-0T, FCF/G102/1-1-JAP, ECFG101-0, ECFG102-0, ECFG202-0, ACFG101-0, ACFG102-0, ACFG202-0, JCF/G102/1-1, JCF/G102/1-2, RCF101G, NCF/G101/1, NCF/G102/1, ZCF/G101/1, ZCF/G102/1, ZCF/G202/1 | | |



1

| | | | |
|--------------------|--|-----------------|--------|
| GEV No. | 693410 | Ref. No. | 055339 |
| description | gasket for hot air motors | | |
| For models: | FCVE6-1U, FCVE6-3U, FCVE6-1, FCVE6-3, FCVE6-3CE, FCVE6-1UK, FCVE6-3UK, FCFG6-1, FCFG6-3, FCFG6-1UK, FCFG6-3UK, FCVE10-2, FCVE10-4, FCVE103CE, FCVE10-2UK, FCVE10-4UK, FCFG10-2, FCFG10-4, FCFG10-1SG, FCFG10-2, FCFG10-4D, FCFG10-2UK, FCFG10-4UK, FCFG10-2, FCFG10-4, FCVE20/P-V, FCVE20-V, FCVE20VUK, FCVE10-P, FCVE10PUK, FCFG10-P, FCFG10PUK, FCF/E6-1, FCF/E6-1, FCF/G6-1, ZOFCV/G6-3, ZOFCV/E102, ZOFCV/E104, ZOFCV/G102, ZOFCV/G104, AFCV/G6-1, AFCV/G6-3, SCO/G6-3, AFCV/G101, AFCV/G103, SCO/G10-3, FCFG10-1SG, FCF/E20-V | | |



1

| | | | |
|--------------------|---|-----------------|--------|
| GEV No. | 693411 | Ref. No. | 055377 |
| description | gasket for hot air motors | | |
| For models: | FCVE20-2, FCVE20-4, FCVE203CE, FCVE20-2UK, FCVE20-4UK, FCFG20-2, FCFG20-4, FCFG20-2, FCFG20-4D, FCFG20-2UK, FCFG20-4UK, FCFG20-4, FCFG20-4D, FCVE20-P, FCVE20PUK, FCFG20-P, FCFG-20PUK, ZOFCV/E202, ZOFCV/E204, ZOFCV/G202, ZOFCV/G204, AFCV/G201, AFCV/G203, SCO/G20-3 | | |



1

| | | | |
|--------------------|--|-----------------|----------------------------|
| GEV No. | 601342 | Ref. No. | 0H0819 0H6947 280409 |
| description | fan wheel D1 ø 450mm H1 178mm blades 6 D2 ø 19.5mm D3 ø 23.5mm H2 45mm | | |



1

| | | | |
|--------------------|--|-----------------|--------|
| GEV No. | 514378 | Ref. No. | 005291 |
| description | guard ø 260mm for hot air motors | | |
| For models: | FCV/G20L3, FCF/E20L3, FCF/G20L6, FCF/E20L6, FCF/G201/1, FCF/E201/1, FCS201E4, FCS201EP, FCS202EP, FCS201G4, FCS201GP, FCS201EX, FCS201EXLN, FCS202EX, FCS201GX, 5712-2-6, 5712-2-7, 5712-2-8, 5712-2-10, 5714-2-6, 5714-2-7, 5714-2-8, 5714-2-10, 5712-2-6L, 5712-2-7L, 5712-2-8L, 5712-2-10L, 5714-2-6L, 5714-2-7L, 5714-2-8L, 5714-2-10L, 5712-3-6, 5712-3-7, 5712-3-8, 5712-3-8E, 5712-3-10, 5712-3-8CH, 5712-3-10C, 5714-3-6, 5714-3-7, 5714-3-8, 5714-3-8E, 5714-3-10, 5717-3-6, 5712-2-10F, 5712-2-10S, 5714-2-10F, 5714-2-10S, 5712-3-10F, 5712-3-10S...(Other models you can see in the webshop) | | |

| | | | |
|---|--|-----------------|--|
|  | | | |
| 1 | | | |
| GEV No. | 511300 | Ref. No. | 002873 0F0199 0G0014 0K2486 0K5556 0K8687 0K8840 |
| description | O-ring Viton thickness 3.53mm ID ø 28.17mm for 57 series for motor shaft | | |
| For models: | FCZ061EAA, FCZ101EAA, FCZ102EAA, FCZ201EAA, FCZ202EAA, FCZ061EAH, FCZ101EAH, FCZ201EAH, FCZ061EAN, FCZ101EAN, FCZ201EAN, FCZ061ETA, FCZ101ETA, FCZ102ETA, FCZ201ETA, FCZ202ETA, FCZ061ETH, FCZ101ETH, FCZ201ETH, FCZ061ETN, FCZ101ETN, FCZ201ETN, FCZ061GAG, FCZ101GAG, FCZ102GAG, FCZ201GAG, FCZ202GAG, FCZ061GAD, FCZ101GAD, FCZ102GAD, FCZ201GAD, FCZ202GAD, FCZ101GTG, FCZ102GTG, FCZ201GTG, FCZ202GTG, FCZ101GTD, FCZ102GTD, FCZ201GTD, FCZ202GTD, FCZ061EBA, FCZ101EBA, FCZ102EBA, FCZ201EBA, FCZ202EBA, FCZ061EBH, FCZ101EBH, FCZ201EBH, FCZ061EBN, FCZ101EBN...(Other models you can see in the webshop) | | |

| | | | |
|---|--|-----------------|--|
|  | | | |
| 1 | | | |
| GEV No. | 511301 | Ref. No. | 002699 0F0096 0K0447 0KE120 0KE540 |
| description | shaft seal ID ø 16mm ED ø 38mm thickness 18mm | | |
| For models: | FCZ061EAA, FCZ101EAA, FCZ102EAA, FCZ201EAA, FCZ202EAA, FCZ061EAH, FCZ101EAH, FCZ201EAH, FCZ061EAN, FCZ101EAN, FCZ201EAN, FCZ061ETA, FCZ101ETA, FCZ102ETA, FCZ201ETA, FCZ202ETA, FCZ061ETH, FCZ101ETH, FCZ201ETH, FCZ061ETN, FCZ101ETN, FCZ201ETN, FCZ061GAG, FCZ101GAG, FCZ102GAG, FCZ201GAG, FCZ202GAG, FCZ061GAD, FCZ101GAD, FCZ102GAD, FCZ201GAD, FCZ202GAD, FCZ101GTG, FCZ102GTG, FCZ201GTG, FCZ202GTG, FCZ101GTD, FCZ102GTD, FCZ201GTD, FCZ202GTD, FCZ061EBA, FCZ101EBA, FCZ102EBA, FCZ201EBA, FCZ202EBA, FCZ061EBH, FCZ101EBH, FCZ201EBH, FCZ061EBN, FCZ101EBN...(Other models you can see in the webshop) | | |

hot air fans

ebm-papst



1

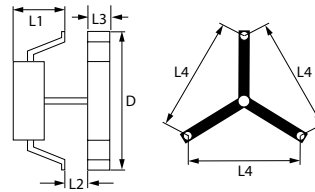

| | | | |
|--------------------|--|-----------------|--------|
| GEV No. | 602160 | Ref. No. | 0KJ865 |
| description | hot air fan 230V 31W type RRL152/0020 B42-3025LH/4iu ebm-papst | | |
| For models: | HCCS20W, HCCS20W, A-O-H/S, A-O-H/W, A-O-H/PT, A-O-H/M50, A-O-H/M60, HC-CS, HC-CS | | |



1

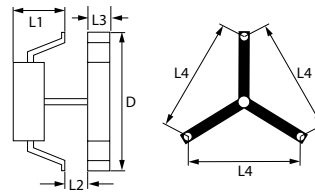

| | | | |
|--------------------|--|-----------------|--------|
| GEV No. | 601198 | Ref. No. | 054842 |
| description | hot air fan 230V 38W L1 65mm L2 20mm L3 25mm L4 130mm fan wheel ø 153mm type RRC140/0024A18 ebm-papst | | |
| For models: | FCF02EV, FCF02EOEM, FCF/E3, FCF/E2, FCF/E2D, FCF/E2UK, FCF/E2, FCF/E2, FCF/E2D, BCFCV101/1, BCFCV102/1, BCFCV101/1, BCFCV102/1 | | |

| | | | |
|------------------------|---|--------|-----------------|
| accessories for | 601198 | | |
| | GEV No. | 601261 | Ref. No. |
| | | | — |
| |  fan wheel ø 154mm W 25mm shaft intake ø 6x5mm chrome-plated blades 7 | | |



miscellaneous

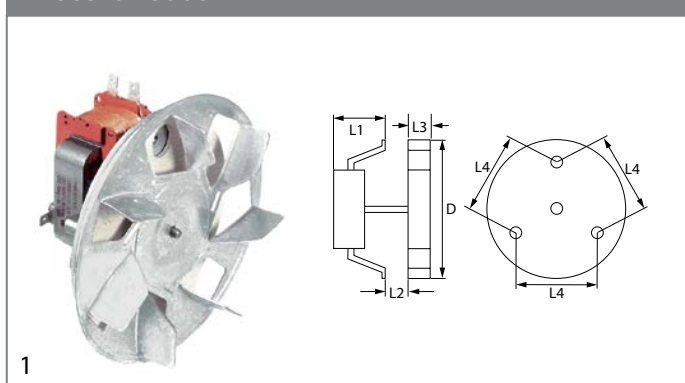

| | | | |
|--------------------|---|-----------------|--------|
| GEV No. | 601273 | Ref. No. | OK3048 |
| description | hot air fan 220-240V 32W 50/60Hz L1 60mm L2 10mm L3 25mm L4 87mm fan wheel ø 155mm FIME type C20X0E01/15CLH | | |



| | | | |
|------------------------|--|-----------------|---|
| GEV No. | 601011 | Ref. No. | 004933 00565 031063 031249 031484 OK3578 OKI639 |
| description | hot air fan 220-240V 40W 50/60Hz L1 65mm L2 15mm L3 25mm L4 87mm fan wheel ø 150mm FIME type C25R8023CLH | | |
| For models: | TC1200TOP, TC1210TOP, TC1400TOP, TC1410TOP, TC1600TOP, TC1610TOP, TC1800TOP, TC1810TOP, TC2000TOP, TC2010TOP, TCD1200TOP, TCD1400TOP, TCD1600TOP, TCD1800TOP, TCD2000TOP, TC1000, TC1010, TC1200, TC1210, TC1400, TC1410, TC1600, TC1610, TC1800, TC1810, TC2000, TC2010, TCD1000, TCD1200, TCD1400, TCD1600, TCD1800, TCD2000, TC1200, TC1210, TC1400, TC1410, TC1600, TC1610, TC1800, TC1810, TC2000, TC2010, TCD1200, TCD1400, TCD1600, TCD1800, TCD2000, MTC1200P, MTC1400P... (Other models you can see in the webshop) | | |
| accessories for | 601011 | | |

| | | | | |
|--|----------------|--|-----------------|---|
| | GEV No. | 550879 | Ref. No. | — |
| | | insulation ø 130mm thickness 3mm hole ø 18mm for hot air fan | | |
| | GEV No. | 601260 | Ref. No. | — |
| | | nut thread M6L IT for hot air fan | | |

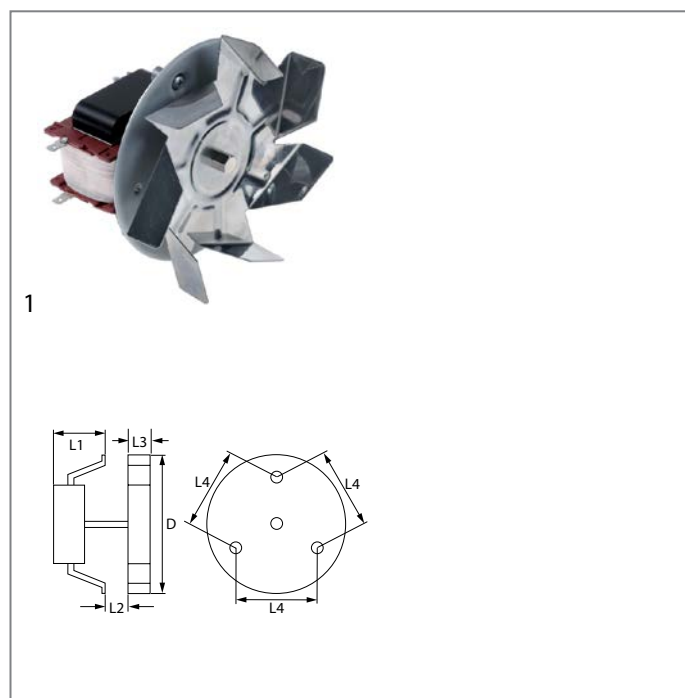

| | | | |
|------------------------|--|-----------------|--------|
| GEV No. | 601125 | Ref. No. | 0A2010 |
| description | hot air fan 220-240V 45W 50/60Hz L1 70mm L2 11mm L3 25mm L4 87mm fan wheel ø 150mm FIME type C30R0479CLF | | |
| For models: | 0WC142, 655-00-106, 655-00-107, 655-00-110, 656-00-106 | | |
| accessories for | 601125 | | |

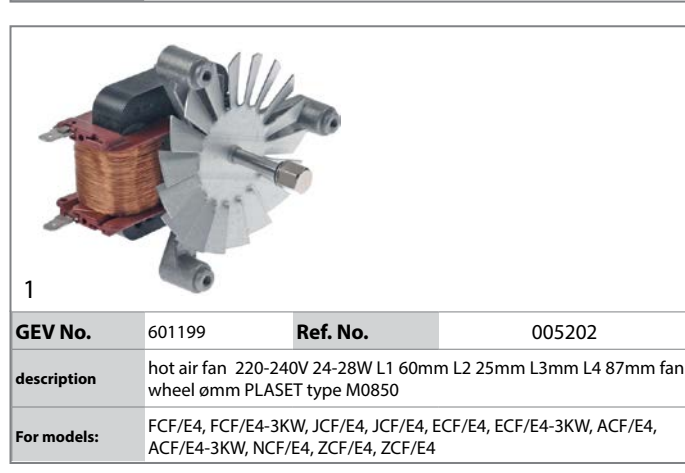

| | | | |
|--------------------|--|-----------------|--------|
| GEV No. | 601199 | Ref. No. | 005202 |
| description | hot air fan 220-240V 24-28W L1 60mm L2 25mm L3mm L4 87mm fan wheel ømm PLASET type M0850 | | |
| For models: | FCF/E4, FCF/E4-3KW, JCF/E4, JCF/E4, ECF/E4, ECF/E4-3KW, ACF/E4, ACF/E4-3KW, NCF/E4, ZCF/E4, ZCF/E4 | | |

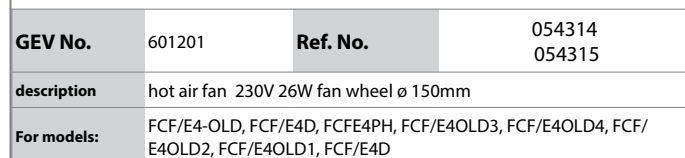

| | | | |
|--------------------|---|-----------------|------------------|
| GEV No. | 601201 | Ref. No. | 054314 054315 |
| description | hot air fan 230V 26W fan wheel ø 150mm | | |
| For models: | FCF/E4-OLD, FCF/E4D, FCFE4PH, FCF/E4OLD3, FCF/E4OLD4, FCF/E4OLD2, FCF/E4OLD1, FCF/E4D | | |



group 6



| | | | |
|--------------------|---|-----------------|--------|
| GEV No. | 601731 | Ref. No. | OKB666 |
| description | hot air fan 220-230VAC 50W L1 71mm L2 4mm L3 6mm L4 87mm fan wheel ø 81mm PLASET type P/N M4307 | | |
| For models: | FCV31E3, 7CO30, CCO30G, ECO312CF, OTS100 | | |

accessories

fan wheels for hot air fans



| | | | |
|--------------------|--|-----------------|--------|
| GEV No. | 601200 | Ref. No. | 005221 |
| description | fan wheel ø 150mm W 20mm shaft intake ø 6x5mm zinc-plated blades 7 | | |
| For models: | FCF/E4, FCF/E4-3KW, JCF/E4, JCF/E4, ECF/E4, ECF/E4-3KW, ACF/E4, ACF/E4-3KW, NCF/E4, ZCF/E4, ZCF/E4 | | |

radial fans

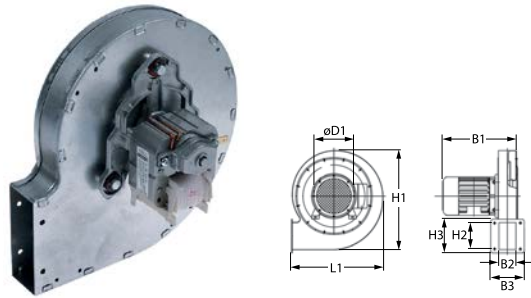

| | | | |
|--------------------|--|-----------------|--------|
| GEV No. | 601238 | Ref. No. | 002639 |
| description | radial fan 230V voltage AC 50Hz 40W H1 205mm L1 205mm D1 ø 150mm W1 103mm W2 32mm H2 83mm W3 34mm H3 86mm | | |
| For models: | FDV40G, FDV40GZ, FDV40GA, FDV20G, FDV20GZ, FDV20GA, FCV/G10L3, FCVG10L3T, FCVG102L3, FCV/G20L3, FCVG202L3, FCVG10L3J, FCVG102L3J, FCV/G10L6JAP, FCV/G102/1L6JAP, FCV/G10L2, FCV/G10L6, FCV/G102/1L6, FCV/G20L6, FCVG202L6, FCV/G101/1, FCV/G102/1, FCV/G201/1, FCV/G202/1, FCS101G2, FCS101G4, FCS101G4DT, FCS101GP9J, FCS101G49J, FCS101GP, FCS102G4, FCS102GA9J, FCS102G49J, FCS102GP, FCS201G4, FCS201GP, FCS202G4, FCS202GP, FCS101GX9J, FCS101GX, FCS102GX9J, FCS102GX, FCS201GX, FCS202GX, 5712-2-6, 5712-2-7, 5712-2-8, 5712-2-10, 5714-2-6, 5714-2-7...(Other models you can see in the webshop) | | |

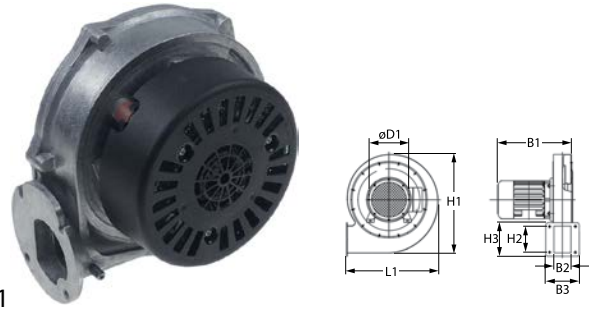

| | | | |
|--------------------|--|-----------------|--------|
| GEV No. | 601732 | Ref. No. | OC4103 |
| description | radial fan 230V voltage AC 50Hz 70W H1 174mm L1 176mm W1 99mm W2 40mm H2 45.5mm W3 83mm H3 83mm | | |
| For models: | FCZ061GAG, FCZ101GAG, FCZ102GAG, FCZ201GAG, FCZ202GAG, FCZ061GAD, FCZ101GAD, FCZ102GAD, FCZ201GAD, FCZ202GAD, FCZ101GTG, FCZ102GTG, FCZ201GTG, FCZ202GTG, FCZ101GTD, FCZ102GTD, FCZ201GTD, FCZ202GTD, FCZ061GBG, FCZ101GBG, FCZ102GBG, FCZ201GBG, FCZ202GBG, FCZ061GBD, FCZ101GBD, FCZ102GBD, FCZ201GBD, FCZ202GBD, FCZ061GBI, FCZ101GBI, FCZ102GBI, FCZ201GBI, FCZ202GBI, FCZ101GBD2, FCZ102GBD2, FCZ201GBD2, FCZ202GBD2, FCZ101GBI2, FCZ102GBI2, FCZ201GBI2, FCZ202GBI2, FCZ101GCG, FCZ102GCG, FCZ201GCG, FCZ202GCG, FCZ061GCD, FCZ101GCD, FCZ102GCD...(Other models you can see in the webshop) | | |



| | | | |
|--------------------|--|-----------------|--------|
| GEV No. | 500817 | Ref. No. | OC1112 |
| description | radial fan 24V voltage DC 50Hz 55W H1 180mm L1 180mm D1 ø 50mm W1 112mm W2 40mm H2 45mm W3 83mm H3 83mm | | |
| For models: | AOS102GAEU, AOS201GAEU, AOS202GAEU, AOS102GAAU, AOS201GAAU, AOS202GAAU, AOS201GA, AOS201GB, AOS102GB, AOS102GA, AOS202GB, AOS202GA | | |

accessories universal



| | | | |
|--------------------|---|-----------------|------------------|
| GEV No. | 693846 | Ref. No. | 054830 058731 |
| description | spacer piece for fan motor | | |
| For models: | FCFG6D, FCFE6D, FCFE6D, FCFG10, FCFG10D, FCFG10NL, FCFE10, FCFE10UK, FCFG20, FCFG20D, FCFG20F, PFCFG20, FCFE20, FCFE20UK, FCFG40, FCFG41, FCFG40D, FCFG40F, PFCFG40F, FCFE40, FCFE40D, FCFE40UK, PFCFE40F, FCFG6, FCFG6F, PFCFG6, FCFE6, FCFE6UK, PFCFE6, FCVE10, FCFG10J, FCFG10J, FCFE10J, FCFE10J, FCFG20J, FCFG20J, FCFE20J, FCFG40J, FCFG40J, FCFE40J, FCFE40J, FCFG10J, FCFG10J, FCFG20J, FCFG20J, FCFG41J, FCFG40J, FCVE6-1U, FCVE6-3U...(Other models you can see in the webshop) | | |



motors

gear motors

for ovens

for flues



| | | | |
|--------------------|--|-----------------|--------|
| GEV No. | 501529 | Ref. No. | OCA539 |
| description | gear motor CDC type BT01 2.8/2.2W 230V 50/60Hz 500/600rpm shaft ø 4mm L 58mm W 55mm H 34mm | | |

miscellaneous



| | | | |
|--------------------|--|-----------------|------------------|
| GEV No. | 501432 | Ref. No. | 0C8687 0C8692 |
| description | gear motor METEOR type 956 6W 230V 50Hz 2rpm shaft ø 6mm combi-steamer | | |

accessories

vibration absorber



| | | | |
|--------------------|--|-----------------|--|
| GEV No. | 524039 | Ref. No. | 0E0129 0H2030 463977801 463977807 |
| description | vibration damper H 22mm ø 25mm thread M8 thread L 20/8mm | | |
| For models: | LN34, LN34, LN34, LN34, LN46, LN46, LN46, LN46, LN72, LN72, LN72, LN72, RT100ED, RT100ES, RT100SR, RT100SL, RT140ED, RT140ES, RT140SR, RT140SL, RT190ED, RT190ES, RT190SR, RT190SL, RT190HDED, RT190HDES, RT190HSR, RT190HSL, RT270ED, RT270ES, RT270SR, RT270SL, RT270HDED, RT270HDES, RT270HSR, RT270HSL, RT100ERF, RT100ELF, RT100VD, RT100VS, RT140ERF, RT140ELF, RT140VD, RT140VS, RT142ERF, RT142ELF, RT190ERF, RT190ELF, RT190VD, RT190VS...(Other models you can see in the webshop) | | |

pumps

vibration pumps



| | | | |
|--------------------|---|-----------------|--------|
| GEV No. | 499317 | Ref. No. | OCA120 |
| description | vibration pump 208-240V 46-60/38-54W 50/60Hz inlet ø 6 outlet ø 5 CEME type B46 kit L 142mm | | |



| | | | |
|--------------------|--|-----------------|-------------|
| GEV No. | 499142 | Ref. No. | — ORT040 |
| description | vibration pump type CP.06.728.0 220/240V 70W 60Hz inlet ø 6 outlet ø 6 with thermal fuse L 130mm | | |



| | | | |
|--------------------|---|-----------------|---------------------|
| GEV No. | 499107 | Ref. No. | OKB664 680801400 |
| description | vibration pump type MP3 230V 5W 50Hz inlet ø 3 outlet ø 3 Invensys L 54mm | | |
| For models: | FCV31E3, 7CO30, CCO30G, ECO312CF, OTS100 | | |

condensators & interference suppression filters

starting capacitors

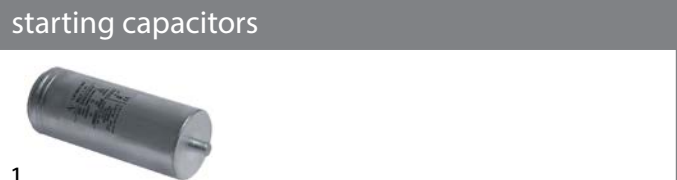

| | | | |
|--------------------|--|-----------------|--------|
| GEV No. | 365220 | Ref. No. | 0C4813 |
| description | starting capacitor 80µF 250V 60Hz ø 55mm L 137mm AL | | |
| For models: | FCZ102GTG, FCZ202GTG, FCZ102GTD, FCZ202GTD, FCZ102GBG2, FCZ202GBG2, FCZ102GBD2, FCZ202GBD2, FCZ102GBI2, FCZ102GCG2, FCZ202GCG2, FCZ102GCD2, FCZ202GCD2, AOS202GAPO, AOS062GAP1, AOS102GAP1, AOS202GAP1, AOS102GAU1, AOS102GTG1, AOS202GTG1, AOS102GTD1, AOS202GTD1, AOS062GTP1, AOS102GTP1, AOS202GTP1, AOS102GTW1, AOS202GTW1, AOS102GBG2, AOS202GBG2, AOS102GBD2, AOS202GBD2, AOS102GBW2, AOS202GBW2, AOS062GCP1, AOS202GCP1, AOS102GCG2, AOS202GCG2, AOS102GCD2, AOS202GCD2, AOS062GCP2, AOS102GCP2 | | |

operating capacitors

plastic



| | | | |
|----------------|--------|-----------------|--|
| GEV No. | 365015 | Ref. No. | 057576 0F0032 0K4727 0K8508 0KJ296 |
|----------------|--------|-----------------|--|

description operating capacitor capacity 10µF 400V tolerance 5%Hz ambient temperature max. -25 to +85°C ø 35.5mm L 59mm M8 plastic connection male faston 6.3mm protection

For models: CS7ME4/200-3, CS7ME4/230-3, CS7ME4/400-3N, CS7ME6/400-3N, CS7ME4/400-3N/EO, CS7ME4/400-3/50HZ/MA, CS7ME4/440-3/60HZ/MA, CS7MT4/400-3N, CS7GE4/200-3, CS7GE4/230-3, CS7GE4/400-3N, CS7GE6/400-3N, CS7GE4/400-3N/EO, CS7GE4/400-3/50HZ/MA, CS7GE4/440-3/60HZ/MA, CS7GT4/400-3N, CS7LCE4/200-3, CS7LCE4/230-3, CS7LCE4/400-3N, CS7LCE6/400-3N, CS7LCE4/400-3N/EO, CS7LCE4/400-3/50HZ/M, CS7LCE4/440-3/60HZ/M, CS7LCT4/400-3N, CS10ME4/200-3, CS10ME4/230-3, CS10ME6/230-3, CS10ME4/400-3N, CS10ME6/400-3N, CS10ME4/400-3N/EO, CS10ME4/400-3/50HZ/M, CS10ME4/440-3/60HZ/M, CS10MT4/400-3N, CS10MT6/400-3N, CS10GE4/200-3, CS10GE4/230-3, CS10GE6/230-3, CS10GE4/400-3N, CS10GE6/400-3N, CS10GE4/400-3N/EO, CS10GE4/400-3/50HZ/M, CS10GE4/440-3/60HZ/M, CS10GT4/400-3N, CS10GT6/400-3N, CS10LCE4/200-3, CS10LCE4/230-3, CS10LCE6/230-3, CS10LCE4/400-3N, CS10LCE6/400-3N, CS10LCE4/400-3N/EO...(Other models you can see in the webshop)



| | | | |
|----------------|--------|-----------------|--|
| GEV No. | 365014 | Ref. No. | 054922 066235 0K2386 0K3032 0L0335 |
|----------------|--------|-----------------|--|

description operating capacitor capacity 12.5µF 450V tolerance 5%Hz ambient temperature max. -25 to +85°C ø 35mm L 70mm M8 plastic connection male faston 6.3mm 45S.C3DS.12.5 protection

For models: HCPA/V1219, HCPA/EI1219



| | | | |
|----------------|--------|-----------------|------------------|
| GEV No. | 365021 | Ref. No. | 052797 0A2914 |
|----------------|--------|-----------------|------------------|

description operating capacitor capacity 16µF 425V tolerance 5% 50/60Hz ambient temperature max. -25 to +85°C ø 35mm L 73mm single M8 plastic connection male faston 6.3mm 416.10.99 protection

For models: MBR/G710D, MBR/E710D, RBR/G710D, 7BRE60XN, XBR/E710D, XBR/G751, XBR/G756, XBR/E716, RBR/E700, FCFG10J, FCFG10J, FCFG6J, FCFG6J, FCFG6J, FCFG6J, FCFG10J, FCFG10J, FCFG20-P, FCFG20PUK, FCFG20-P, FCFG20PUK, HBR/G1013, HBR/E1013, HBR/G1013, HBR/E1013, LS32, LS32/4.5, LS32UK/RP, LS32F, LV32F, C55, LV32/60, WT302, WT302/4.5, WT302UK/RP, WT302F, WT302/60, LS33, LS33/4.5, LS33UK/RP, LS33F, LV33F, C55A, LS33/60, WT303, WT303/4.5, WT303UK/RP, WT303F, WT303/60, LS61...(Other models you can see in the webshop)



| | | | |
|----------------|--------|-----------------|--------|
| GEV No. | 365031 | Ref. No. | 084721 |
|----------------|--------|-----------------|--------|

description operating capacitor capacity 4µF 450V tolerance 5% 50/60Hz ambient temperature max. -25 to +85°C ø 31mm L 58mm M8 plastic connection male faston 6.3mm protection

For models: BCF44H, AQC119U US, , , BCF15A6, , , BCW101, BCW102, BCFW101, BCF44H, BCFW102, BC44H, BCF44H, BCFWS102, BCFWS101, BC15A, Crosswise, BC56VA, Crosswise 20, BC56HA, BCF15A, Crosswise, BCF28A, Crosswise, BCF64A, Crosswise 20, BCF56HA, RBC102, AAFP-S102C, ESK40H, ESF40H, EABP51, EABC501, AAFP102U, AAFP101C, AACP102, AACP102R, AAFP102, AAFP102R, AAFP10160, Crosswise, RBC061, Crosswise, RBC6.1-15, Crosswise 20, RBC20.1-56, Crosswise, RBF061, Crosswise...(Other models you can see in the webshop)



| | | | |
|----------------|--------|-----------------|--------------------------------------|
| GEV No. | 365017 | Ref. No. | 037268 083406 0K9108 0L2035 |
|----------------|--------|-----------------|--------------------------------------|

description operating capacitor capacity 5µF 450V tolerance 5% 50/60Hz ambient temperature max. -25 to +85°C ø 28mm L 54mm M8 plastic connection male faston 6.3mm 16.10.08 protection

For models: BC22, BC44, BC44H, BCF11, BCF22, BCF44, AQC60U, AQC119U US, BC28A6, Crosswise, , , BCW061, BCW101, BCW102, BCFW061, BCFW101, BC22, BC44, BCF11, BCF22, BCF44, BCWS061T, BCFW102, BC22, BC44, BCF11, BCF22, BCF44, BCFWS102, BCFWS101, BC28A, Crosswise, BC56VA, Crosswise 20, BC56HA, BCF28A, Crosswise, BCF64A, Crosswise 20, BCF56HA, BCFWS061, BCFWS061T, BLAST C/FREEZER, EPPWELG, LS6EADD, LS6EA/DPDD, WT38TDE, LS6EADP3...(Other models you can see in the webshop)





| | | | |
|----------------|--------|-----------------|-------------------------|
| GEV No. | 365012 | Ref. No. | 049260 0KB768 909 |
|----------------|--------|-----------------|-------------------------|

description operating capacitor capacity 6.3µF 450V tolerance 5% 50Hz ambient temperature max. -25 to +85°C ø 30mm L 61mm M8 plastic connection male faston 6.3mm protection

For models: LS32UK/RP, WT302UK/RP, LS33UK/RP, WT303UK/RP, LB1, LB1WS, LB1WSDP, WT1WSDP, WT2TOP60, WT2DPDI, WT2WSDPDI, LB1TOP, WT2TOPDI, LB2WS, LB2, LB2WSDP, WT2WSDP, WT2WSDPD, WT2WS, WT1, WT1WS, WT1TOP, WT2TOP, WT1/3DP, WT2/3DP, NGW2DPG, NGW2WSDPG, WT2DPAUS, NGWP, NGWDPDDP, WT2, LB2DPDI, LB2WSDPDI, LB2WSDPD, LB2TOP, LB2DP3, WT2DPD3, NGWGM5, NGWDPDDG, NGW, NGWDPDD, NGWDPBP60, NGWDD, NGWDPDDTF, EGWSI, EGWSIGUK, EGWSIG, EGWSIDPBC6, ZGWSI, ZGWSIG...(Other models you can see in the webshop)



| | | | |
|---|--|-----------------|--------|
|  | | | |
| 1 | | | |
| GEV No. | 365027 | Ref. No. | OC4812 |
| description | operating capacitor capacity 60µF 400V tolerance 5%Hz ambient temperature max. -25 to +85°C ø 49mm L 115mm M8 plastic connection male faston 6.3mm protection | | |
| For models: | FCZ101GTG, FCZ102GTG, FCZ201GTG, FCZ202GTG, FCZ101GTD, FCZ102GTD, FCZ201GTD, FCZ202GTD, FCZ101GBG2, FCZ102GBG2, FCZ201GBG2, FCZ202GBG2, FCZ101GBD2, FCZ102GBD2, FCZ201GBD2, FCZ202GBD2, FCZ101GBI2, FCZ102GBI2, FCZ201GBI2, FCZ202GBI2, FCZ101GCG2, FCZ102GCG2, FCZ201GCG2, FCZ202GCG2, FCZ101GCD2, FCZ102GCD2, FCZ201GCD2, FCZ202GCD2, AOS061GAPQ, AOS101GAPQ, AOS102GAPQ, AOS201GAPQ, AOS202GAPQ, AOS101GAQ1, AOS061GAP1, AOS062GAP1, AOS101GAP1, AOS102GAP1, AOS201GAP1, AOS202GAP1, AOS101GTG1, AOS102GTG1, AOS201GTG1, AOS202GTG1, AOS101GTD1, AOS102GTD1, AOS201GTD1, AOS202GTD1, AOS062GTP1, AOS101GTP1, AOS102GTP1...(Other models you can see in the webshop) | | |

| | | | |
|--|---|-----------------|---|
|  | | | |
| 1 | | | |
| GEV No. | 365140 | Ref. No. | 037269 047541 047883 694604400 |
| description | operating capacitor capacity 12.5µF 450V tolerance 5% 60Hz ambient temperature max. -25 up to +70°C ø 40mm L 83mm M8 aluminium connection male faston 6.3mm C.87.8BF2 MKP protection | | |
| For models: | FCZ061EAA, FCZ101EAA, FCZ201EAA, FCZ202EAA, FCZ061EAH, FCZ101EAH, FCZ201EAH, FCZ061EAN, FCZ101EAN, FCZ201EAN, FCZ061ETA, FCZ101ETA, FCZ201ETA, FCZ061ETH, FCZ101ETH, FCZ201ETH, FCZ061ETN, FCZ101ETN, FCZ201ETN, FCZ061GAG, FCZ101GAG, FCZ201GAG, FCZ061GAD, FCZ101GAD, FCZ201GAD, FCZ101GTG, FCZ201GTG, FCZ101GTD, FCZ201GTD, FCZ061EBA, FCZ101EBA, FCZ201EBA, FCZ061EBH, FCZ101EBH, FCZ201EBH, FCZ061EBN, FCZ101EBN, FCZ201EBN, FCZ061EBC, FCZ101EBC, FCZ201EBC, FCZ061EBA2, FCZ101EBA2, FCZ201EBA2, FCZ061EBH2, FCZ101EBH2, FCZ201EBH2, FCZ061EBN2, FCZ101EBN2...(Other models you can see in the webshop) | | |

| | | | |
|---|--|-----------------|--------|
|  | | | |
| 1 | | | |
| GEV No. | 365013 | Ref. No. | 049126 |
| description | operating capacitor capacity 8µF 400V tolerance 5%Hz ambient temperature max. -25 to +85°C ø 31.5mm L 55mm M8 plastic connection male faston 6.3mm protection | | |
| For models: | LS32, LS32/4.5, LS32F, LV32F, C55, LV32/60, WT302, WT302/4.5, WT302F, WT302/60, LS33, LS33/4.5, LS33F, LV33F, C55A, LS33/60, WT303, WT303/4.5, WT303F, WT303/60, NUC3DD, EUC1, EUC1DP, EUC3, EUC3DP, EUC1G, EUC1DP60, EUC3DD, KUC3, KUC3DP, NUC1, NUC1DP, NUC3, NUC3DP, NUC1DP60, NUC1DPA, LB1, LB1WS, LB1WSDP, LB1/RBP, LB1/TOP, WT1WSDP, WT2TOP60, WT2DPDI, WT2WSDPDI, LB1TOP, WT2TOPDI, LB2WS, LB2, LB2WSDP...(Other models you can see in the webshop) | | |

| | | | |
|--|---|-----------------|---------------------------------------|
|  | | | |
| 1 | | | |
| GEV No. | 365142 | Ref. No. | 084323 0C1187 0H6812 2253262 |
| description | operating capacitor capacity 15µF 450V with metal case tolerance 5% 50/60Hz ø 40mm L 110mm M8x1.25 | | |
| For models: | ECN050, ECN075, ECB120, ADF110, ALF110, ADF120, ALF120, AEF110, AEF120, ADNF120, AENF120, ADNF220, ADNF230, AENF220, AENF230, ASF110, AKF110UK, ASF110UK, APP224/60, AZF2203, 83012201, ARDF110L, ARDF120, ASF110, ADF110, ADF120, ADF1060, ADF2206, BCF7A, STRP1101, STRP1102, STRP1601, STRP1602, STRP1603, STRP2201, STRP2202, STRP2203, STRP1101S, STRP1601S, STRP2201S, STRP1602R, AZF13430, STRP1603R, STRP2201R, STRP2202R, STRP2203R, STRP1101R, STRP1102R, STRP1601R, APP223...(Other models you can see in the webshop) | | |

| | | | |
|---|--|-----------------|---|
| metal | | | |
|  | | | |
| 1 | | | |
| GEV No. | 365139 | Ref. No. | 056148 0U0403 416332729 754000 |
| description | operating capacitor capacity 10µF 450V tolerance 5% 60Hz ambient temperature max. -25 up to +70°C ø 40mm L 83mm M8 aluminium connection male faston 6.3mm C.87.8BF2 MKP protection | | |
| For models: | FCZ061EBC, FCZ101EBC, FCV/G10L3, FCV/G6L3TOWNGAS, FCV/G6L3, FCVG10L3T, FCV/E101/1, FCVE6L3J, FCV/E10L3JAP, FCV/E10L6JAP, FCV/G6L3JAP, FCV/E61/1, FCV/G10L2, FCV/E61/1, FCV/E101/1, FCV/E101/1, FCV/E10L2, FCV/E102/1, FCV/E61/1, FCV/E61/1, FCV/E101/1, FCV/E101/2, FCV/G6L3C, FCV/G61/1, FCV/G61/1, FCV/G61/1, FCV/G61/1, FCVG6L3CT, FCV/E10L3, FCV/E102/1, FCV/E6L3, FCV/G6L4, FCV/E6L4, FCV/E101/1, FCV/G10L6, FCV/E10L6, FCV/E101/1, FCV/G101/1, FVC/E101/1, FCF/G6-0, FCFG101/0, FCFG102-0, FCFG201-0, FCF/E6-0, FCFE101-0, FCFE102-0, FCFE201-0, FCFE202-0, FCF061ELN, FCF101ELN...(Other models you can see in the webshop) | | |

| | | | |
|--|--|-----------------|-------------------------------|
|  | | | |
| 1 | | | |
| GEV No. | 365160 | Ref. No. | 047744 0H1044 416334429 |
| description | operating capacitor capacity 20µF 420V tolerance 5% 60Hz ambient temperature max. -25 up to +70°C ø 45mm L 82mm M8 aluminium connection male faston 6.3mm C.87.8BF2 protection | | |
| For models: | CUTE0523, CUTE0538, FCVG102L3, FCV/E102/1L3JAP, FCV/E102/1L6JAP, FCV/E102/1L3, FCV/G102/1L6, FCV/E102/1L6, FCV/G102/1, FVC/E102/1, FVC/E202/1, FCFG101/0, FCFG102-0, FCFG202-0, FCFE101-0, FCFE102-0, FCFE201-0, FCFE202-0, FCF101ELN, FCF101ENS, FCF102ENS, FCF201ENS, FCFG102-0T, FCFE101-1J, FCFE102-1J, FCS102E44J, FCS102EP4J, FCS102E4, FCS102EP, FCS102G4, FCS202E4, FCS102GP, FCS202EP, FCS202G4, FCS202GP, FCS102EX4J, FCS102EX, FCS202EX, FCS102GX, FCS202GX, ECFG101-0, ECFG102-0, ECFG202-0, ECFE101-0, ECFE102-0, ECFE201-0, ECFE202-0, ECF101ENS, ECF102ENS, ECF201ENS...(Other models you can see in the webshop) | | |



| | | | |
|--------------------|--|-----------------|---------------------|
| GEV No. | 365141 | Ref. No. | OC1186 416335164 |
| description | operating capacitor capacity 31.5µF 450V with metal case tolerance 5% ø 45mm L 132mm M8x1.25 | | |
| For models: | FCZ102EAA, FCZ202EAA, FCZ102ETA, FCZ202ETA, FCZ202GAG, FCZ202GAD, FCZ102GTG, FCZ202GTG, FCZ102GTD, FCZ202GTD, FCZ102EBA, FCZ202EBA, FCZ102EBA2, FCZ202EBA2, FCZ202GBG, FCZ202GBD, FCZ102GBG2, FCZ202GBG2, FCZ102GBD2, FCZ202GBD2, FCZ102GBI2, FCZ102ECA, FCZ202ECA, FCZ102ECA2, FCZ202ECA2, FCZ202GCG, FCZ202GCD, FCZ102GCG2, FCZ202GCG2, FCZ-102GCD2, FCZ202GCD2, AOS102GAEU, AOS202GAEU, AOS102EA2N, AOS102EB2N, AOS202EA2N, AOS202EB2N, AOS102EA, AOS102EB, AOS202EA, AOS202EB, AOS102GB, AOS102GA, AOS202GB, AOS-202GA, AOS102EAAQ, AOS102EBAQ, AOS202EAAQ, AOS202EBAQ, AOS102EANQ...(Other models you can see in the webshop) | | |



| | | | |
|--------------------|---|-----------------|----------------------------|
| GEV No. | 365046 | Ref. No. | 046217 084035 0G2043 |
| description | interference suppression filter type 10S7E-G1474253105-Q 115/250V 50/60Hz conductor 2 with E connection male faston 6.3mm L 40mm ø 40mm Hmm Wmm M8 plastic Qty 1 pcs | | |
| For models: | ILP111, ILP220, ILP220UK, ILP240, ILP221, ILN111, ILN220, ILN220UK, ILN240, ILN221, ILF220, ILF220UK, ILF240, TRN1301, TRNA1301, TRNM1301, TRN1302, TRNA1302, TRNM1302, TRN1303, TRNA1303, TRNM1303, TRN1801, TRNA1801, ARNM1801, TRN1802, TRNA1802, TRNM1802, TRN1803, TRNA1803, TRNM1803, TRN2201, TRNA2201, TRNM2201, TRN2202, TRNA2202, TRNM2202, TRN2203, TRNA2203, TRNM2203, TR1202, TR1221, TR1603, TR1622, TR1641, TR2004, TR2023, TR2042, MCF/G1095, MC/G352...(Other models you can see in the webshop) | | |

ferrite rings



| | | | |
|--------------------|---|-----------------|--------|
| GEV No. | 365054 | Ref. No. | 005517 |
| description | ferrite ring ID ø 22mm ED ø 38mm H 17mm for protection | | |
| For models: | MCP/E1SH, MCP/E1SUH, MCP/E2SUHS, MCP/E2SH, MCP/E2SUH, MCP/E2SUT, MCP/E2SHB, PCP/E1SH, PCP/E2SH, PCP/E2SH3B, OCP/E1SH, OCP/E2SH, TCP/E2SH, KCP/G1, KCP/G1R, KCP/G2, KCP/G2R, KCP/E1, KCP/E1R, KCP/E2, KCP/E2R, QCP/G1, QCP/G1R, QCP/G2, QCP/G2R, QCP/E1, QCP/E1R, QCP/E2, QCP/E2R, WCP/G1, WCP/G1R, WCP/G2, WCP/G2R, WCP/E1, WCP/E1R, WCP/E2, WCP/E2R, APN/ED816, DCP/G400 | | |



| | | | |
|--------------------|--|-----------------|------------------|
| GEV No. | 365050 | Ref. No. | 049303 0KE945 |
| description | interference suppression filter type 411.13.5901D 250V 50Hz conductor 4 plug connection male faston 6.3mm L 50mm ø 38mm Hmm Wmm plug plastic Qty 1 pcs | | |
| For models: | RF/E1D05, RF/E1S08, RF/E2D08, RFR/E1S08, RFR/E2D08, RFR/E1S12, RFR/E2D12, RFR/E2S40, RF/E1S12, RF/E2D12, RFR/E1S14, RFR/E2D14, RF/E1S12, RCP/E2S, RI/E1, RI/E2, RIF/E2, RIV/E2, RF/E1S07, RF/E2D07, RFR/E1S07, RFR/E2D07, RF/E1S12E5, RFR/E1S12, XF/E1D05, XF/E1S08, XF/E2D08, XFR/E1S08, XFR/E2D08, XFR/E1S12, XFR/E2D12, XFR/E2S40, XF/E1S12, XF/E2D12, XFR/E1S14, XFR/E2D14, XF/E1S12, XF/E2D12, XI/E1, XI/E2, XIF/E2, XIV/E2, XF/E1S07, XF/E2D07, XFR/E1S07, XFR/E2D07, XFR/E1S12, XFR/E2D12, JF/E1D05, JF/E1S08...(Other models you can see in the webshop) | | |

filters

interference suppression filters



| | | | |
|--------------------|---|-----------------|--------|
| GEV No. | 365143 | Ref. No. | 003510 |
| description | interference suppression filter 275V capacity 47nF 100Ohm | | |
| For models: | RBR/E2FM, RBR/E2IM, RBK/E2FM, RF/E1D05, RF/E1S08, RF/E2D08, RFR/E1S08, RFR/E2D08, RFR/E1S12, RFR/E2D12, RFR/E2S40, RF/E1S12, RF/E2D12, RF/E1S12, RF/E1S12E5, RFR/E1S12, XBR/E2FM, XBR/E2IM, XBK/E2FM, XF/E1D05, XF/E1S08, XF/E2D08, XFR/E1S08, XFR/E2D08, XFR/E1S12, XFR/E2D12, XFR/E2S40, XF/E1S12, XF/E2D12, XF/E1S12, XF/E2D12, XFR/E2D12, JBR/E2FM, JF/E1D05, JF/E1S08, JF/E2D08, JFR/E1S08, JFR/E2D08, JFR/E1S12, JFR/E2D12, JFR/E2S40, JF/E1S12, JF/E2D12, JF/E1S12, JF/E2D12, MBR/E2FM, MBR/E2IM, MBK/E2FM, MF/E1D05...(Other models you can see in the webshop) | | |

line filters

with housing





| | | | |
|--------------------|---|-----------------|-------------------------------|
| GEV No. | 365077 | Ref. No. | 059078 0K2392 411105236 |
| description | line filter type 411524410 250V 50/60Hz conductor 2 with E connection male faston 6.3mm L 50mm ø 38mm Hmm Wmm M8 plastic Qty 1 pcs | | |
| For models: | FDV40G, FDV40E, FDV40GZ, FDV40EL, FDV40GA, FDV20G, FDV20E, FDV20GZ, FDV20EL, FDV20GA, KFR/E1E, KFR/E2F, KFR/E1C, KFR/E2D, KFR/E1CE5, KFR/E2DE5, KFH/G1, KFH/E1, KFH/G1ELH, KFH/E1ELH, KFH/G1EH, KFH/E1EH, HFH/G430, HFH/E430, HFR/E430, HFR/E830, HFH/G435, HFH/G435, HFRS/E430, HFR/E431, HFR/E831, QFR/E1E, QFR/E2F, QFR/E1C, QFR/E2D, QFH/G1, QFH/E1, QFH/G1ELH, QFH/E1ELH, QFH/G1EH, QFH/E1H, ZFH/G430, ZFH/E430, ZFR/E430, ZFR/E830, ZFH/G435, ZFH/G435, ZFRS/E430, ZFR/E431, ZFR/E831...(Other models you can see in the webshop) | | |





fuses

fine fuses

| | | | |
|--|--|-----------------|--------|
|  <p>1</p> | | | |
| GEV No. | 358666 | Ref. No. | 0W3499 |
| description | fine fuse size ø5x20mm 0.315A fast-acting rated 250V Qty 10 pcs | | |
| For models: | C240, C260, D1000V, T1000, T1000, T1000, C24001, C240R01, C26001, C260R01, C290R01, C260R02, C240R02 | | |

| | | | |
|--|--|-----------------|--------|
|  <p>1</p> | | | |
| GEV No. | 358669 | Ref. No. | 0W5452 |
| description | fine fuse size ø5x20mm 0.63A fast-acting rated 250V Qty 10 pcs | | |
| For models: | T4250, T4250, T4350, T419002, T419003, PD9, T353019, T3650, T3650, T3650, T3530, T3530, T419001, T419005, T425001, T425002, T425003, T425004, T425005, T425006, T425007, T425008, T425009, T425010, T425011, T425012, T329001, T329002, T329003, T329004, T329005, T329006, T329007, T329008, T329009, T329010, T329011, T329012, T4300S01, T4300S02, T435001, T435002, T435003, T435004, T435005, T435006, T435007, T435008, T435009, T435010...(Other models you can see in the webshop) | | |

| | | | |
|---|---|-----------------|----------------------------|
|  <p>1</p> | | | |
| GEV No. | 358610 | Ref. No. | 002347 058869 0W3317 |
| description | fine fuse size ø5x20mm 10A fast-acting rated 250V Qty 10 pcs | | |
| For models: | FCZ102EAA, FCZ102ETA, FCZ102GAG, FCZ102GAD, FCZ101GTG, FCZ102GTG, FCZ101GTD, FCZ102GTD, FCZ102EBA, FCZ102EBA2, FCZ102GBG, FCZ102GBD, FCZ061GBI, FCZ101GBI, FCZ101GBG2, FCZ102GBG2, FCZ101GBD2, FCZ102GBD2, FCZ101GBI2, FCZ102GBI2, FCZ102ECA, FCZ102ECA2, FCZ102GCG, FCZ102GCD, FCZ101GCG2, FCZ102GCG2, FCZ101GCD2, FCZ102GCD2, FCFE201-0, FCFE202-0, FCFE201ENS, FCFE202E, FCFE202EUK, FCFE202G, 5714-2-7, 5714-2-8, 5714-2-10, 5717-2-6, 5714-2-7, 5714-2-8, 5714-2-10, 5714-2-7L, 5714-2-8L, 5714-2-10L, 5714-2-6L, 5714-2-7L, 5714-2-8L, 5714-2-10L, 5714-3-6, 5714-3-7...(Other models you can see in the webshop) | | |

| | | | |
|--|---|-----------------|--------|
|  <p>1</p> | | | |
| GEV No. | 358611 | Ref. No. | 005136 |
| description | fine fuse size ø5x20mm 16A fast-acting rated 250V Qty 10 pcs | | |
| For models: | FCZ202ETA, FCZ202GAG, FCZ202GAD, FCZ201GTG, FCZ202GTG, FCZ201GTD, FCZ202GTD, FCZ202EBA2, FCZ202GBG, FCZ202GBD, FCZ201GBI, FCZ201GBG2, FCZ202GBG2, FCZ201GBD2, FCZ202GBD2, FCZ201GBI2, FCZ202ECA2, FCZ202GCG, FCZ202GCD, FCZ201GCG2, FCZ202GCG2, FCZ201GCD2, FCZ202GCD2, FCV202L3, FCVE202L3, FCV202L6, FCVE202L6, FCV/G202/1, FVC/E202/1, FCFE201-0, FCFE202-0, FCFE201ENS, FCS202E4, FCS202EP, FCS201GP, FCS202G4, FCS202GP, FCS202EX, FCS201GX, FCS202GX, 5714-2-7, 5714-2-8, 5714-2-10, 5714-2-7L, 5714-2-8L, 5714-2-10L, 5717-3-7, 5717-3-8, 5717-3-8E, 5717-3-10...(Other models you can see in the webshop) | | |

| | | | |
|---|--|-----------------|--------|
|  <p>1</p> | | | |
| GEV No. | 358671 | Ref. No. | 0W5451 |
| description | fine fuse size ø5x20mm 1A fast-acting rated 250V Qty 10 pcs | | |
| For models: | T4250, T4250, T4350, T419002, T419003, PD9, T353019, T3650, T3650, T3650, T3530, T3530, T419001, T419005, T425001, T425002, T425003, T425004, T425005, T425006, T425007, T425008, T425009, T425010, T425011, T425012, T329001, T329002, T329003, T329004, T329005, T329006, T329007, T329008, T329009, T329010, T329011, T329012, T4300S01, T4300S02, T435001, T435002, T435003, T435004, T435005, T435006, T435007, T435008, T435009, T435010...(Other models you can see in the webshop) | | |

| | | | |
|---|---|-----------------|--------|
|  <p>1</p> | | | |
| GEV No. | 358532 | Ref. No. | 0A8438 |
| description | fine fuse size ø5x20mm 2A fast-acting rated 250V Qty 10 pcs | | |

| | | | |
|---|--|-----------------|--|
|  <p>1</p> | | | |
| GEV No. | 358677 | Ref. No. | 053741 057783 088227 090017 0H0516 0KD887 0KP602 0KP604 0KT789 |
| description | fine fuse size ø5x20mm 4A fast-acting rated 250V Qty 10 pcs | | |
| For models: | BCF11, AQC119U US, , , BCW061, BCFW061, BCF11, BCWS061T, BC56VA, Crosswise 20, BC56HA, BCF64A, Crosswise 20, BCF56HA, BCFWS061, BCFWS061T, BLAST C/FREEZER, MBR/E710D, MBR/E700, MBR/E700UK, MBR/E716, MBR/E706, MFR/E350, MFR/E700, MFR/E370, MFR/E350UK, MFR/E700UK, MFR/E370UK, MFR/E370D, MFR/E350D, MFR/E700D, MFR/E355, MFR/E355UK, MFR/E355D, MFR/E705, MFR/E705UK, MFR/E705D, MFR/E740, RBR/E2FM, RBR/E2IM, RBK/E2FM, RCP/E2S, XBR/E2FM, XBR/E2IM, XBK/E2FM, JBR/E2FM, MBR/E2FM, MBR/E2IM, MBK/E2FM, MCP/E2S...(Other models you can see in the webshop) | | |

electric components

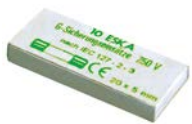

| | | | |
|---|--|-----------------|------------------|
|  | | | |
| 1 | | | |
| GEV No. | 358608 | Ref. No. | 0C5431 0L1295 |
| description | fine fuse size ϕ 5x20mm 10A slow-acting rated 250V Qty 10 pcs | | |
| For models: | EPPWELG, FCZ102EAA, FCZ102ETA, FCZ102EBA, FCZ102EBA2, FCZ102ECA, FCZ102ECA2, AOS102EAA1, AOS102EAC1, AOS102EAS1, AOS062EAM1, AOS102EAM1, AOS062EAB1, AOS102EAB1, AOS102EAK1, AOS102EAT1, AOS102ETA1, AOS062ETM1, AOS102ETM1, AOS102ETK1, AOS102EBA1, AOS102EBC1, AOS102EBK1, AOS102EBA2, AOS102EBK2, AOS102ECA1, AOS062ECM1, AOS102ECM1, AOS062ECB1, AOS102ECB1, AOS102ECA2, AOS062ECM2, AOS102ECM2, EPPWESG, EPPWESG60, EPPWEHG, ZPPWESG, ZPPWEHG, ZPPWSSG, EPPWELG, EPPWELG60, ZPPWELG, ZPPWSLG, EPPWESGFB, EPPWEHGFB, EPPWELGFB, EPPWESGM6, NPPWESG, NPPWEHG, NPPWELG...(Other models you can see in the webshop) | | |

| | | | |
|--|---|-----------------|--------|
|  | | | |
| 1 | | | |
| GEV No. | 358751 | Ref. No. | 0C2230 |
| description | fine fuse size ϕ 6.3x32mm 6.3A fast-acting rated 500V Qty 10 pcs | | |
| For models: | FCZ061EAA, FCZ101EAA, FCZ061EAH, FCZ101EAH, FCZ061EAN, FCZ101EAN, FCZ061ETA, FCZ101ETA, FCZ201ETA, FCZ061ETH, FCZ101ETH, FCZ201ETH, FCZ061ETN, FCZ101ETN, FCZ201ETN, FCZ061EBA, FCZ101EBA, FCZ061EBH, FCZ101EBH, FCZ061EBN, FCZ101EBN, FCZ061EBC, FCZ101EBC, FCZ061EBA2, FCZ101EBA2, FCZ201EBA2, FCZ061EBH2, FCZ101EBH2, FCZ201EBH2, FCZ061EBN2, FCZ101EBN2, FCZ201EBN2, FCZ061EBC2, FCZ101EBC2, FCZ201EBC2, FCZ061ECA, FCZ101ECA, FCZ061ECH, FCZ101ECH, FCZ061ECN, FCZ101ECN, FCZ061ECA2, FCZ101ECA2, FCZ201ECA2, FCZ061ECH2, FCZ101ECH2, FCZ201ECH2, FCZ061ECN2, FCZ101ECN2, FCZ201ECN2...(Other models you can see in the webshop) | | |

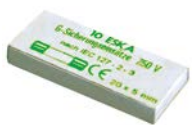
| | | | |
|---|---|-----------------|--------|
|  | | | |
| 1 | | | |
| GEV No. | 358603 | Ref. No. | 090098 |
| description | fine fuse size ϕ 5x20mm 2A slow-acting rated 250V Qty 10 pcs | | |
| For models: | BC100A, BC100DA, BC100RA, BC100RDA, BC180A, BC180DA, BC180RA, BC180RDA, BC180RPA, BCF100A, BCF100DA, BCF100RA, BCF100RDA, BCF180A, BCF180DA, BCF180RA, BCF180RDA, BCF180RPA, BCW201R, BCFW201R, BC120A, BC120RA, BCF120A, BCF120RA, BLAST C/FREEZER, BLAST C/FREEZER, BLAST C/FREEZER, BLAST C/FREEZER, BLAST C/FREEZER, BC0144, BC072, ESBC72R, ESBC144R, ESBF70, ESBF70R, ESBF144, ESBF144R, AOC2028R, AOC2028RD, AOC2028RT, AOC2028R, AOC2028RD, AOC2028RT, EABPR101, EABC101R, AOFPS201CR, AOFPS201RU, AOFPS202RU...(Other models you can see in the webshop) | | |

| | | | |
|---|---|-----------------|--------|
|  | | | |
| 1 | | | |
| GEV No. | 358020 | Ref. No. | 048995 |
| description | fine fuse size ϕ 10x38mm 1A rated 500V type Gg fast-acting Qty 1 pcs | | |
| For models: | WT33/M50, WT33/M60, WT30U400, WT30U440 | | |

fine fuse holders

| | | | |
|---|---|-----------------|------------------|
|  | | | |
| 1 | | | |
| GEV No. | 358029 | Ref. No. | 0F0031 0K8694 |
| description | fuse holder suitable fuse ϕ 5x20mm ϕ 14.5mm thread M16x1 1-pole 10A rated 500V connection F6.3 | | |
| For models: | EBE40., EBE40, EBE40., EBE040, EBE60., EBE60., EBE60., EBE60, EBE80., EBE80., EBE80, EBE100., EBE100., EBE100., EBE100, BASIC40, BASIC60, BASIC80., BASIC100, EBE40AWF, EBE60AWF, EBE80AWF, EBE100AWF, FCZ061EAA, FCZ101EAA, FCZ102EAA, FCZ201EAA, FCZ202EAA, FCZ061EAH, FCZ101EAH, FCZ201EAH, FCZ061EAN, FCZ101EAN, FCZ201EAN, FCZ061ETA, FCZ101ETA, FCZ102ETA, FCZ201ETA, FCZ202ETA, FCZ061ETH, FCZ101ETH, FCZ201ETH, FCZ061ETN, FCZ101ETN, FCZ201ETN, FCZ061GAG, FCZ101GAG, FCZ102GAG, FCZ201GAG...(Other models you can see in the webshop) | | |

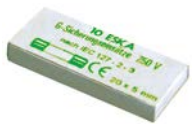
| | | | |
|---|--|-----------------|--------|
|  | | | |
| 1 | | | |
| GEV No. | 358605 | Ref. No. | 0C4996 |
| description | fine fuse size ϕ 5x20mm 3.15A slow-acting rated 250V Qty 10 pcs | | |
| For models: | BCP/E1, PCP/E1ELH, TCP/E1ELH, FCZ201GTG, FCZ201GTD, FCZ201GBG2, FCZ201GBD2, FCZ201GBI2, FCZ201GCG2, FCZ201GCD2, AOS201GTG1, AOS201GTD1, AOS201GTP1, AOS201GTW1, AOS201GBG2, AOS201GBD2, AOS201GBW2, AOS201GCG2, AOS201GCD2, ECRT66R208, ECRT66L208, ECRT66R240, ECRT66L240, ECRT44R208, ECRT44L208, ECRT44R240, ECRT44L240, LWC44AR208, LWC44AL208, LWC44AR240, LWC44AL240, LWC66AR208, LWC66AL208, LWC66AR240, LWC66AL240 | | |

| | | | |
|--|---|-----------------|--------|
|  | | | |
| 1 | | | |
| GEV No. | 358396 | Ref. No. | 056582 |
| description | fuse holder suitable fuse ϕ 5x20mm ϕ 15mm mounting ϕ 12.5mm 16A rated 250V L 46mm connection male faston 4.8mm | | |
| For models: | MBR/E710D, MBR/E700, MBR/E700UK, MBR/E716, MBR/E706, BCP/E1, FDV40G, FDV40E, FDV40GZ, FDV40EL, FDV40GA, FDV20G, FDV20E, FDV20GZ, FDV20EL, FDV20GA, 7BRE60XN, 7BRE60X, RBR/E700UK, RBR/E716, RBR/E706, XBR/E710D, M70EBP, XBR/E710, CBR/E700, XBR/E716, XBR/E706, PPD/G260, PPI/G260P, ECP/E1ELHU, PCP/E1ELH, OPD/G260, OPI/G260P, TPD/G260, TPI/G260P, TCP/E1ELHU, TCP/E1ELH, TFRE1S12M0, TFRE2D12M0, TFRE1S12M4, TFRE2D12M4, KPI/G10, KPI/G15, KPD/G10, KPD/G15, KPD/G15A, KPI/G15A, KPI/G06, KPI/G15H, KPI/G10H...(Other models you can see in the webshop) | | |

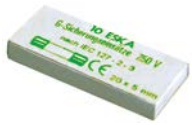
| | | | |
|---|--|-----------------|--------|
|  | | | |
| 1 | | | |
| GEV No. | 358607 | Ref. No. | 007054 |
| description | fine fuse size ϕ 5x20mm 6.3A slow-acting rated 250V Qty 10 pcs | | |
| For models: | AOS061EA, AOS061EB, AOS101EA, AOS101EB, AOS061EA3J, AOS061EB3J, AOS101EA3J, AOS101EB3J, AOS061EA2N, AOS061EB2N, AOS101EA2N, AOS101EB2N, AOS061EB5M, AOS101EB5M, AOS201EB5M, AOS061EB6M, AOS101EB6M, AOS201EB6M, AOS102EA2N, AOS102EB2N, AOS202EA2N, AOS202EB2N, AOS061EA0H, AOS061EB0H, AOS101EA0H, AOS101EB0H, AOS102EA, AOS102EB, AOS202EA, AOS202EB, AOS061GA, AOS101GA, AOS201GA, AOS201GB, AOS102GB, AOS102GA, AOS202GB, AOS202GA | | |



electric accessories

cables

cable harnesses



| | | | |
|--------------------|--|-----------------|--------|
| GEV No. | 401849 | Ref. No. | 002763 |
| description | connecting cable | | |
| For models: | FDV40G, FDV40E, FDV40GZ, FDV40EL, FDV40GA, FDV20G, FDV20E, FDV20GZ, FDV20EL, FDV20GA, FCV/G10L3, FCVG10L3T, FCVG102L3, FCV/G20L3, FCVG202L3, FCV/E10L3JAP, FCV/E102/1L3JAP, FCV/E10L6JAP, FCV/E102/1L6JAP, FCVG10L3J, FCVG102L3J, FCV/G10L-6JAP, FCV/G102/1L6JAP, FCV/E61/1, FCV/E101/1, FCV/E101/1, FCV/E102/1, FCV/E61/1, FCV/E101/1, FCV/E101/2, FCV/G61/1, FCV/G61/1, FCV/G61/1, FCV/E10L3, FCV/E102/1, FCV/E102/1L3, FCV/E20L3, FCV/E202L3, FCV/G6L4, FCV/E6L4, FCV/G10L6, FCV/E10L6, FCV/G102/1L6, FCV/E102/1L6, FCV/G20L6, FCV/E20L6, FCVG202L6, FCV/E202L6, FCV/E101/1, FCV/G101/1...(Other models you can see in the webshop) | | |

connection cables



| | | | |
|--------------------|---|-----------------|--------|
| GEV No. | 699204 | Ref. No. | 0C3678 |
| description | kable set L 630mm suitable for combi-steamer | | |
| For models: | FCZ061EAA, FCZ061EAH, FCZ061EAN, FCZ061ETA, FCZ061ETH, FCZ061ETN, FCZ061EBA, FCZ061EBH, FCZ061EBN, FCZ061EBC, FCZ061EBA2, FCZ061EBH2, FCZ061EBN2, FCZ061EBC2, FCZ061ECA, FCZ061ECH, FCZ061ECN, FCZ061ECA2, FCZ061ECH2, FCZ061ECN2, AOW101EA, AOW101EABU, AOS061EAA1, AOS061EAH1, AOS061EAN1, AOS061EAC1, AOS061EAE1, AOS061EAF1, AOS061EAM1, AOS061EAB1, AOS061EAK1, AOS061EAT1, AOS061ETA1, AOS061ETH1, AOS061ETN1, AOS061ETC1, AOS061ETE1, AOS061ETF1, AOS061ETM1, AOS061ETK1, AOS061EBA1, AOS061EBH1, AOS061EBN1, AOS061EBC1, AOS061EBE1, AOS061EBF1, AOS061EBK1, AOS061EBA2, AOS061EBH2, AOS061EBN2...(Other models you can see in the webshop) | | |

terminals and connectors

not insulated

female fastons

iron nickel-plated



| | | | |
|--------------------|---|-----------------|------------------|
| GEV No. | 550001 | Ref. No. | 0K3331 0K3332 |
| description | female faston size 6.3x0.8mm 1.0-2.5mm ² straight Fe gal Ni t.max. 340°C Qty 100 pcs | | |

terminals

porcelain clamps



| | | | |
|--------------------|---|-----------------|--------|
| GEV No. | 550115 | Ref. No. | 053805 |
| description | porcelain terminal block 2-pole 10mm ² max. 30A max 450V L 37mm W 37mm H 23mm mounting distancemm Qty 1 pcs | | |
| For models: | TC1200TOP, TC1210TOP, TC1400TOP, TC1410TOP, TC1600TOP, TC1610TOP, TC1800TOP, TC1810TOP, TC2000TOP, TC2010TOP, TCD1200TOP, TCD1400TOP, TCD1600TOP, TCD1800TOP, TCD2000TOP, TC1000, TC1010, TC1200, TC1210, TC1400, TC1410, TC1600, TC1610, TC1800, TC1810, TC2000, TC2010, TCD1000, TCD1200, TCD1400, TCD1600, TCD1800, TCD2000, TC1200, TC1210, TC1400, TC1410, TC1600, TC1610, TC1800, TC1810, TC2000, TC2010, TCD1200, TCD1400, TCD1600, TCD1800, TCD2000, TC1000, TC1000...(Other models you can see in the webshop) | | |



| | | | |
|--------------------|---|-----------------|--------|
| GEV No. | 555002 | Ref. No. | 054331 |
| description | porcelain terminal block 2-pole max. 15A max 380V L 70mm W 36mm H 39mm mounting distance 12mm | | |
| For models: | FCF/E4-OLD, FCF/E4D, FCFE4PH, FCF/E4OLD3, FCF/E4OLD4, FCF/E4OLD2, FCF/E4OLD1, FCF/E4D | | |



| | | | |
|--------------------|---|-----------------|--------|
| GEV No. | 550114 | Ref. No. | 054042 |
| description | porcelain terminal block 4-pole 2.5mm ² hole distance 18mm max. 10A max 250V L 40mm W 20mm H 15mm mounting distance 18mm Qty 1 pcs | | |
| For models: | MCF/GE705, MCF/GE1055, MCF/GE700, MCFGE1050, MCF/GE700D, MCFGE1050D, MC/E350D, MC/E350UK, MC/E700D, MC/E700UK, MC/E1050D, MCF/GE1055UK, MC/E350, MC/E700, MC/E1050, MI/E350, MI/E700, MI/E350D, MI/E700D, MI/E360, MI/E710, MI/E360D, MI/E710D, MCF/GE702, MCFGE1052, MCF/GE700, MCFGE1050, MR/E350D, MR/E350UK, MR/E360, MR/E700D, MR/E700UK, MR/E710, MR/E720, MR/E715, MR/E725, MR/E350, MR/E700, MR/E720D, MFR/E355, MFR/E355UK, MFR/E355D, MPN/EI760, MPNEI760UK, MTF/GE1050, MT/G700F, MTF/G700F, MTF/G1055F, MTFGE1055F, MM/E700...(Other models you can see in the webshop) | | |



terminal blocks



1

| | | | |
|--------------------|---|-----------------|--------|
| GEV No. | 550232 | Ref. No. | 0W3543 |
| description | lustre terminal 12-pole cross section 2.5mm ² max. 32A max 450V temp.-resist. 150°C | | |
| For models: | LB81E, LB81BP, LB81COP, LB121E, LB121BP, LB161E, LB161BP, LB161V, CLB161E, CLB161V, T3900, T3900, T390013, T353019, T2130, T2130C, T3190, T3190, T3250_EL, T3250_GAS, T3250_EL, T3250_GAS, T3650, T3650, T3650, T3350_EL, T3350_GAS, T3350_EL, T3350_GAS, T3530, T3530, T3190E, T3190G, T329001, T329002, T329003, T329004, T329005, T329006, T329007, T329008, T329009, T329010, T329011, T329012, T353001, T353002, T353003, T353004, T353005...(Other models you can see in the webshop) | | |

connection terminals with screw/faston connections



1

| | | | |
|--------------------|--|-----------------|------------------|
| GEV No. | 505212 | Ref. No. | 058873 0C9052 |
| description | power terminal block 2-pole max. 20A max 600V connection \varnothing 2.5mm ² / F6.3 temp.-resist. 150°C cross section 4mm ² | | |
| For models: | RCP/E2S, MCP/E1SH, MCP/E1SUH, MCP/E2SUHS, MCP/E2S, MCP/E2SH, MCP/E2SUH, MCP/E2SUT, MCP/E2SHB, M70EIKE, XPN/EI-760UK, XPN/EI760D, PCP/E2SH, PCP/E1SH, PCP/E2SH, PCP/E2SH3B, OCP/E2S, OCP/E1SH, OCP/E2SH, TCP/E2S, TCP/E2SH, TFRE1S12M0, TFRE2D12M0, TFRE1S12M4, TFRE2D12M4, HPN/ED811, HPN/ED816, HPA/ED825, HPN/GI806, HPN/GI805, HCP/E400, HCP/E410, HCP/E800, HCP/E810, HCPS/E400, HCPS/E410, HGRV, ZPN/ED811, ZPN/ED816, ZPN/GI805, ZCP/E400, ZCP/E410, ZCP/E800, ZCP/E810, ZCPS/E400, ZCPS/E410, APN/EI815D, APN/EI810, APN/EI815, APN/ED816...(Other models you can see in the webshop) | | |



1

| | | | |
|--------------------|---|-----------------|------------------|
| GEV No. | 550278 | Ref. No. | 046357 0KE877 |
| description | power terminal block 3-pole max. 40A max 400V connection \varnothing 6mm ² / F6.3 temp.-resist. 150°C cross section 6mm ² | | |
| For models: | MCF/G702, MCF/G1052, MCF/G700, MCF/G1050, MBR/G710D, MFR/G350, MFR/G700, MFR/G350D, MFR/G700D, MFR/G350F, MFR/G700F, MFR/G350E, MFR/G700E, FDV40G, FDV40GZ, FDV40GA, FDV20G, FDV20GZ, FDV20GA, RC/G1, RC/G2, RCV/G2, RCV/G3, RCF/G2, RCF/G3, RSF/G2, RSV/G2, RSF/G3, RPI/G260P, RW/E1, RB/E1, MCF/G2A, MCF/G3A, XC/G1, XC/G2, XCV/G2, XCV/G3, XCF/G2, XCF/G3, XSF/G2, XSV/G2, XSF/G3, XPI/G260P, XW/E1, XB/E1, JC/G1, JC/G2, JCV/G2, JCV/G3, JCF/G2...(Other models you can see in the webshop) | | |



1

| | | | |
|--------------------|--|-----------------|--|
| GEV No. | 550411 | Ref. No. | 046347 048574 0E0994 0E1603 0E5176 0KE434 0KE541 0KG206 |
| description | power terminal block 6-pole max. 40A max 450V connection \varnothing 6mm ² / F6.3 temp.-resist. 150°C cross section 6mm ² | | |
| For models: | CMV11-F, CMV11F, CMV15-F, CMV15F, CMV15F2, CM15F2, CMP15F2, CMV11-F, CMV15/F, LS32/4.5, LS32UK/RP, LS32F, LV32F, C55, LV32/60, WT302/4.5, WT302UK/RP, WT302F, WT302/60, LS33/4.5, LS33UK/RP, LS33F, LV33F, C55A, LS33/60, WT303/4.5, WT303UK/RP, WT303F, WT303/60, LB8G, LB8G/63, LB8GF, LB8GPH, LB80EPH, LB80E, LB120EPH, LB120E, LB160EPH, LB160E, LB160V, CLB160E, CLB160V, W3400H06, W355HE, W365H, W375H5, W3105H, W3130H, W3130H, W3240H...(Other models you can see in the webshop) | | |



1

| | | | |
|--------------------|---|-----------------|--------|
| GEV No. | 550977 ¹ | Ref. No. | 058613 |
| description | power terminal block 6-pole max. 40A max 450V connection \varnothing 6mm ² / F6.3 temp.-resist. 150°C cross section 6mm ² with ground lug | | |
| For models: | MPN/EI760, MPNEI760UK, MPN/EI760D, BCF/E2, RCF/M2, RCF/M3, RC/E1, RC/E2, RCV/E2, RCV/E3, RCF/E2, RCF/E2MO, RCF/E2M4, RCVF/E3MO, RCVF/E3M4, RMV/E1C, RMV/E2C, RF/E1D05, RFR/E1S12, RFR/E2D12, RFR/E2S40, RF/E1S12, RF/E2D12, RFR/E1S14, RFR/E2D14, RF/E1S12, RF/E2D12, RR/E1FL, RR/E1FR, RR/E1CL, RR/E2FL, RR/E2FM, RR/E2CL, RRV/E1FL, RRV/E1FR, RRV/E1CL, RRV/E2FL, RRV/E2FM, RRV/E2CL, RR/E2CM, RG/E1, RG/E2, RGV/E1, RGV/E2, RPI/E240, RPI/E260, RPI/E260P, RCP/E1S, RCP/E2D, RI/E1...(Other models you can see in the webshop) | | |

¹with ground lug

rail-mounted terminals

rail-mounted terminal blocks





1

| | | | |
|--------------------|---|-----------------|--------|
| GEV No. | 550598 | Ref. No. | 058875 |
| description | rail-mounted terminal block 5-pole contacts 3P+N+E cross section 1.0-10mm ² | | |
| For models: | MIF/E700, MIF/E700D, MIF/E710, MIF/E710D, MBR/E710D, MBR/E700, MBR/E700UK, MBR/E716, MBR/E706, MFR/E705, MFR/E705UK, MFR/E705D, 7BRE60XN, 7BRE60XN, RBR/E700UK, RBR/E716, RBR/E706, XMIF/E710, CIF/E710, XBR/E710D, M70EBP, XBR/E710, CBR/E700, XBR/E716, XBR/E706, PIW/Z1, PI/Z2F, PG/E1, PG/E1E5, TIW/Z1, TI/Z2F, TG/E1, TG/E1E5, HCF/E800, HCF/GE810, KRF/E2R, KRF/E2RP, ZCF/E800, ZCF/GE810, QCF/M2, QCF/W2, QRF/E2R, QRF/E2RP, ACF/GE810, WRF/E2R, WRF/E2RP, ECF/G-E810, FCZ061EAA, FCZ061EAH, FCZ061EAN...(Other models you can see in the webshop) | | |



| | | | |
|---|---|-----------------|--|
|  | | | |
| 1 | | | |
| GEV No. | 550922 | Ref. No. | 002691 0E5850 0F0112 0KT397 1090199S |
| description | rail-mounted terminal block 5-pole contacts 3P+N+E cross section 1.5-16mm ² | | |
| For models: | MI/Z1, RI/Z1, XI/Z1, MI/Z2, RI/Z2, XI/Z2, MI/Z1U, MI/Z2U, PCF/M2, PCF/M3, PC/E2Q, PCF/E2Q, PCV/E2Q, PI/Z1, PI/Z2, PC/E2QE5, PCF/E2QE5, PI/Z1E5, PI/Z2E5, PCF/M2E5, PF/E2D12E5, PFRE2D12E5, PCF/M2A, PCF/M3A, OCF/M2, OC/E2Q, OCF/E2Q, OI/Z2, TCF/M2, TCF/M3, TCF/E2Q, TCV/E2Q, TI/Z2, TCF/E2QE5, TI/Z2E5, TCF/M2E5, TF/E2D12E5, TFRE2D12E5, TCF/M2A, TCF/M3A, TCF/E2M0, TCF/E2QM0, TCF/E3QM0, TCF/E2M4, TCF/E2QM4, TCF/E3QM4, KCF/M2, KC/E1, KC/E2, KCF/E2... (Other models you can see in the webshop) | | |

| | | | |
|--|---|-----------------|--------|
|  | | | |
| 1 | | | |
| GEV No. | 551072 | Ref. No. | 059794 |
| description | rail-mounted terminal block cross section 6mm ² suitable fuse 5x20/5x25mm | | |
| For models: | MFR/E355, MFR/E355UK, MFR/E355D, MFR/E705, MFR/E705UK, MFR/E705D, RBR/E2FM, RBR/E2IM, RBK/E2FM, RCP/E2S, XBR/E2FM, XBR/E2IM, XBK/E2FM, JBR/E2FM, MBR/E2FM, MBR/E2IM, MBK/E2FM, MCP/E2S, RFR/E356, RFR/E701, PBR/E2FM, PBR/E2IM, PPI/E260P, PCP/E2SHP, OBR/E2FM, OBR/E2IM, OPI/E260P, OCP/E2S, TBR/E2FM, TBR/E2IM, TPI/E260P, TCP/E2S, KPI/E06, KCP/E1RU, KCP/G1U, KCP/G2U, KCP/E1U, HFR/E410, HFR/E411, HFR/E412, HPN/EI815D, HPN/EI810, HPN/EI815, HPN/ED811, HPN/ED816, HPA/ED825, HPA/EI825, HPNS/EI815, HPNS/EI815D, HPN/EI806... (Other models you can see in the webshop) | | |

| | | | |
|---|---|-----------------|-------------------|
|  | | | |
| 1 | | | |
| GEV No. | 551081 ¹ | Ref. No. | 058608 2238003 |
| description | rail-mounted terminal block 5-pole contacts 3P+N+E cross section 1.5-16mm ² with fuse terminal suitable fuse ø5x30mm | | |
| For models: | MFR/E740, RFR/E741, CFR/E702, HCF/E810, KPI/E10, KPI/E15, KPI/E15A, KPI/E15H, KPI/E10H, KBR/E2F, KBR/E2C, KBR/E3F, KBR/E3FH, KBR/E3C, KBR/E3CH, KBR/E2FH, KBR/E2CH, KFR/E1C, KFR/E2D, KFR/E1CE5, KFR/E2DE5, HFR/E418, HBR/E800, HBR/E805, HBR/E801, HBR/E806, HBR/E810, HBR/E815, HBR/E811, HBR/E816, HBR/E800UK, HBR/E820, HBR/E825, HBR/E800, HBR/E805, HBR/E810, HBR/E815, HBR/E811, HBR/E816, HBR/E800UK, QPI/E10, QPI/E15, QPI/E15H, QPI/E10H, QBR/E2F, QBR/E2C, QBR/E3F, QBR/E3FH, QBR/E3C, QBR/E3CH... (Other models you can see in the webshop) | | |

¹with fused terminal block

| | | | |
|---|--|-----------------|--------|
|  | | | |
| 1 | | | |
| GEV No. | 551082 | Ref. No. | 058707 |
| description | rail-mounted terminal block 5-pole cross section 35mm ² suitable fuse ø5x30mm | | |
| For models: | FDV40E, FDV40EL, FDV20E, FDV20EL, FCZ202EAA, FCZ202ETA, FCZ202EBA, FCZ202EBA2, FCZ202ECA, FCZ202ECA2, FCFE201-0, FCFE202-0, FCFE201ENS, FCFE40, FCFE40UK, PFCFE40F, FCFE40J, FCFE40J, FCVE20/P-V, AOS202EA2N, AOS202EB2N, AOS202EA, AOS202EB, AOS202EAAQ, AOS202EBAQ, ECFE201-0, ECFE202-0, ECFE201ENS, AOS202EAA1, AOS202EAK1, AOS202EAT1, AOS202ETA1, AOS202ETM1, AOS202ETK1, AOS202EBA1, AOS202EBK1, AOS202EBA2, AOS202EBK2, AOS202ECA1, AOS202ECA2, FCFE202, EJJN202EAA, EJJN202EBA, EJJN202ECA, ACFE201-0, ACFE202-0, RCF201E, FF/E40, AFCF/E40, 4238N... (Other models you can see in the webshop) | | |

electronic components

resistors

| | | | |
|---|--|-----------------|--------|
|  | | | |
| 1 | | | |
| GEV No. | 359929 | Ref. No. | 058872 |
| description | resistor 1000Ohm | | |
| For models: | FCV/G10L3, FCV/G6L3TOWNGAS, FCV/G6L3, FCVG10L3T, FCVG102L3, FCV/E101/1, FCV/G20L3, FCVG202L3, FCVE6L3J, FCV/E10L3JAP, FCV/E102/1L3JAP, FCV/E10L6JAP, FCV/E102/1L6JAP, FCV/G6L-3JAP, FCVG10L3J, FCVG102L3J, FCV/G10L6JAP, FCV/G102/1L6JAP, FCVG6L3CJ, FCV/E61/1, FCV/G10L2, FCV/E61/1, FCV/E101/1, FCV/E101/1, FCV/E10L2, FCV/E102/1, FCV/E61/1, FCV/E61/1, FCV/E101/1, FCV/E101/2, FCV/G6L3C, FCV/G61/1, FCV/G61/1, FCV/G61/1, FCV/G61/1, FCV/G6L3CT, FCV/G6L3CJ, FCV/E10L3, FCV/E102/1, FCV/E6L3, FCV/E102/1L3, FCV/E20L3, FCVE202L3, FCV/G6L4, FCV/E6L4, FCV/E101/1, FCV/G10L6, FCV/E10L6, FCV/G102/1L6, FCV/E102/1L6... (Other models you can see in the webshop) | | |



gas thermostats

MERTIK



| | | | |
|------------------------|--|-----------------|---|
| GEV No. | 106397 | Ref. No. | 0C5250 |
| description | gas thermostat MERTIK type GV30T t.max. 340°C 100-340°C gas inlet bottom 3/8" gas inlet lateral gas outlet bottom 3/8" gas outlet lateral thermocouple connection M9x1 pilot connection M10x1 capillary pipe 720mm probe ø 4mm probe L 68mm shaft ø 8x6.5mm shaft L 13mm cable length 1550mm gland nut | | |
| For models: | PCV/G2A, PCV/G3A, PCF/G2A, PCF/G3A, OCF/G9UK, TCF/G9, TCF/G9UK, TCV/G2A, TCV/G3A, TCF/G2A, TCF/G3A | | |
| spare parts for | 106397 | | |
| | GEV No. | 106221 | Ref. No. — |
| | magnet unit L 32mm D1 ø 19mm D2 ø 14mm suitable for MERTIK | | |
| accessories for | 106397 | | |
| | GEV No. | 100015 | Ref. No. — |
| | ignition cable cable length 600mm connection ø2.4mm / ø2.4mm | | |
| | GEV No. | 100018 | Ref. No. 00123 004943 059578 0U3507 |
| | ignition cable cable length 600mm connection ø2.4mm / ø4mm permanent temperature 200°C | | |
| | GEV No. | 100179 | Ref. No. — |
| | ignition cable cable length 1200mm connection F2.8mm / ø2.4mm | | |
| | GEV No. | 100193 | Ref. No. — |
| | ignition cable cable length 1200mm connection ø2.4mm / ø4mm | | |
| | GEV No. | 100197 | Ref. No. — |
| | ignition cable cable length 600mm connection F2.8mm / ø2.4mm | | |
| | GEV No. | 100904 | Ref. No. 052833 0K2497 100904 102504 |
| | locking screw M10x1 for pipe ø 4mm Qty 1 pcs | | |
| | GEV No. | 101273 | Ref. No. 027478 050682 058370 0957007 0G2222 0K4315 |
| | olive for pipe ø 12mm L 9.5mm brass Qty 1 pcs suitable for universal | | |
| | GEV No. | 101276 | Ref. No. — |
| | union screw thread 3/8" tube ø 12mm Qty 1 pcs | | |
| | GEV No. | 102180 | Ref. No. 005559 |
| | ignition cable cable length 1200mm connection ø2.4mm / ø2.4mm | | |

| | | | |
|------------------------|---|--------|------------------------|
| accessories for | 106397 | | |
| | GEV No. | 106701 | Ref. No. 0C5400 |
| | knob adapter thickness 14mm ED ø 26mm shaft 8x6.5mm plastic | | |
| | GEV No. | 106718 | Ref. No. — |
| | union screw for gas thermostat MERTIK M9x1 for thermocouple ET M22x1 | | |
| | GEV No. | 112387 | Ref. No. — |
| | knob dial plate universal red | | |
| | GEV No. | 112388 | Ref. No. — |
| | knob dial plate universal silver | | |
| | GEV No. | 112556 | Ref. No. 0C5251 |
| | knob switch zero mark t.max.°C temperature range°C ø 46mm shaft MERTIK shaft ømm shaft flat | | |
| | GEV No. | 112598 | Ref. No. — |
| | knob dial plate MERTIK gas regulator (piezoelectric igniter) silver | | |
| | GEV No. | 112599 | Ref. No. — |
| | knob dial plate MERTIK gas regulator (piezoelectric igniter) red | | |
| | GEV No. | 112601 | Ref. No. — |
| | knob dial plate silver gas thermostat MERTIK 1-8 t.max.°C ED ø 59mm ID ø 45.5mm | | |
| | GEV No. | 112602 | Ref. No. — |
| | knob dial plate red gas thermostat MERTIK 1-8 t.max.°C ED ø 59mm ID ø 45.5mm | | |
| | GEV No. | 112949 | Ref. No. — |
| | knob MERTIK gas regulator ø 62mm shaft flat upper black special fixing shaft 8x6.5 | | |
| | GEV No. | 112950 | Ref. No. — |
| | knob MERTIK gas regulator ø 32mm black for piezoelectric igniter | | |

gas components



gas valves and ignition boxes

gas control valves

HONEYWELL



1

| | | | |
|------------------------|--|-----------------|-------------------|
| GEV No. | 106007 | Ref. No. | 005925 |
| description | gas valve type VK4105A 220-240V 50/60Hz gas inlet flange 32x32mm gas outlet flange 32x32mm thermocouple connection pilot connection pressure range 15-60mbar max 60mbar operator type suitable for HONEYWELL hole distance 24mm flange 32x32mm | | |
| For models: | FCV/G20L3, FCVG20L3, FCVG6L3CJ, FCV/G6L3C, FCV/G61/1, FCV/G61/1, FCV/G61/1, FCV/G61/1, FCVG6L3CT, FCVG6L3CJ, FCS061G48J, FCS061GP, FCS061G3DI, FCS061G4, FCS061G4DT, FCS061G49J, 5721-2-7, 5721-2-10, ECV/G6T4C, ECV/G61/1, ECV/G61/1, RCV061G2, ACV/G6C3C, ZCV/G6T4C, ZCV/G61/1 | | |
| accessories for | 106007 | | |
| | GEV No. | 102845 | Ref. No. — |
| | gas connection angled 1/2" flange 32x32mm hole distance 24x24mm Tandem | | |
| | GEV No. | 102846 | Ref. No. — |
| | gas connection straight 1/2" flange 32x32mm hole distance 24x24mm suitable for Tandem | | |



1

| | | | |
|------------------------|---|-----------------|-------------------|
| GEV No. | 106008 | Ref. No. | 006596 |
| description | gas valve type VK4105P 220/240V 50/60Hz gas inlet 1/2" NPT gas outlet 1/2" NPT thermocouple connection pilot connection pressure range 15-60mbar max 60mbar operator type HONEYWELL suitable for coil type 220/240V (V4336A 2220) hole distance 24mm flange 32x32mm | | |
| For models: | FCV/G20L6, FCVG20L6, FCV/G201/1, FCV/G202/1, FCS201G4, FCS201GP, FCS202G4, FCS202GP, FCS201GX, FCS202GX, ECV/G20T4, ECVG202T4, ECV/G20T6, ECVG202T6, ACV/G20C4, ACVG202C4, ACVG202C6 | | |
| accessories for | 106008 | | |
| | GEV No. | 102845 | Ref. No. — |
| | gas connection angled 1/2" flange 32x32mm hole distance 24x24mm Tandem | | |
| | GEV No. | 102846 | Ref. No. — |
| | gas connection straight 1/2" flange 32x32mm hole distance 24x24mm suitable for Tandem | | |

SIT

ELETTROSIT



1

| | | | |
|------------------------|--|-----------------|--|
| GEV No. | 101993 | Ref. No. | 0H6072 |
| description | gas valve SIT type ELETTROSIT 230V gas inlet 1/2" gas outlet 1/2" thermocouple connection M9x1 pilot connection M10x1 lateral equiv. no. 0.810.126 | | |
| spare parts for | 101993 | | |
| | GEV No. | 101312 | Ref. No. 004217 054539 056601 0927011 0927012 0H6997 |
| | microswitch | | |
| | GEV No. | 101352 | Ref. No. — |
| | solenoid coil 230V 50Hz suitable for ELETTROSIT | | |
| accessories for | 101993 | | |
| | GEV No. | 100006 | Ref. No. — |
| | piezoelectric igniter suitable for ELETTROSIT body plastic blowing connection ø2.4mm ø 14mm | | |
| | GEV No. | 100904 | Ref. No. 052833 OK2497 100904 102504 |
| | locking screw M10x1 for pipe ø 4mm Qty 1 pcs | | |
| | GEV No. | 100905 | Ref. No. 052834 0958031 |
| | locking screw M10x1 for pipe ø 6mm Qty 1 pcs | | |
| | GEV No. | 101301 | Ref. No. — |
| | gas connection thread 1/2" straight ELETTROSIT screw with O-ring | | |
| | GEV No. | 101303 | Ref. No. — |
| | gas connection straight thread 3/4" ELETTROSIT | | |
| | GEV No. | 101309 | Ref. No. 051281 055805 |
| | extension | | |
| | GEV No. | 103104 | Ref. No. — |
| | ignition switch | | |
| | GEV No. | 541504 | Ref. No. — |
| | double nipple thread 1/2" - 1/2" | | |

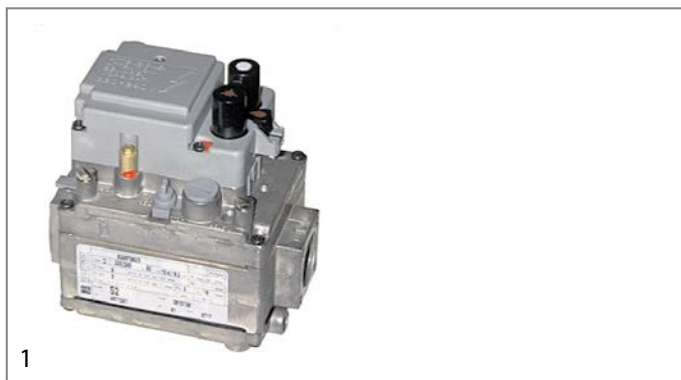

| | | | |
|------------------------|--|-----------------|---|
| GEV No. | 101123 | Ref. No. | 0810138 0A2035 |
| description | gas valve SIT type ELETROSIT 230V gas inlet 3/4" gas outlet 3/4" thermocouple connection M9x1 pilot connection M10x1 bottom equiv. no. 0.810.138 | | |
| For models: | VO40G | | |
| spare parts for | 101123 | | |
| | GEV No. | 101312 | Ref. No. 004217 054539 056601 0927011 0927012 0H6997 |
| | microswitch | | |
| | GEV No. | 101352 | Ref. No. — |
| | solenoid coil 230V 50Hz suitable for ELETROSIT | | |
| accessories for | 101123 | | |
| | GEV No. | 100006 | Ref. No. — |
| | piezoelectric igniter suitable for ELETROSIT body plastic blowing connection ø2.4mm ø 14mm | | |
| | GEV No. | 100904 | Ref. No. 052833 0K2497 100904 102504 |
| | locking screw M10x1 for pipe ø 4mm Qty 1 pcs | | |
| | GEV No. | 100905 | Ref. No. 052834 0958031 |
| | locking screw M10x1 for pipe ø 6mm Qty 1 pcs | | |
| | GEV No. | 101301 | Ref. No. — |
| | gas connection thread 1/2" straight ELETROSIT screw with O-ring | | |
| | GEV No. | 101303 | Ref. No. — |
| | gas connection straight thread 3/4" ELETROSIT | | |
| | GEV No. | 101309 | Ref. No. 051281 055805 |
| | extension | | |



| | | | |
|------------------------|--|-----------------|---|
| GEV No. | 101127 | Ref. No. | 053643 054538 057543 0810175 0K7815 |
| description | gas valve SIT type ELETROSIT 230V gas inlet 3/4" gas outlet 3/4" thermocouple connection M9x1 pilot connection M10x1 lateral equiv. no. 0.810.175 | | |
| For models: | FCFG10, FCFG10D, FCFG10NL, FCFG20, FCFG20D, FCFG20F, PFCFG20, FCFG40, FCFG41, FCFG40D, FCFG40F, PFCFG40F, FCFG10J, FCFG10, FCFG20J, FCFG20J, FCFG40J, FCFG40J, FCFG10J, FCFG10J, FCFG20J, FCFG20J, FCFG41J, FCFG40J, HCPA/G1219, HCPA/G11219, HBR/G803, HBR/G804, HBR/G803, HBR/G804, HBR/G803, HBR/G805, HBR/G1003, HBR/G1003, HBR/G1004, HBR/G803, HBR/G804, HBR/G1013, HFR/G420, HFR/G420, HFR/G420NL, HFR/G840, HFR/G840, HFR/G840, HFR/G840, HFR/G421, FCFG101, FCFG201, FCFG202, FCFC202...(Other models you can see in the webshop) | | |
| spare parts for | 101127 | | |
| | GEV No. | 101312 | Ref. No. 004217 054539 056601 0927011 0927012 0H6997 |
| | microswitch | | |
| | GEV No. | 101352 | Ref. No. — |
| | solenoid coil 230V 50Hz suitable for ELETROSIT | | |
| accessories for | 101127 | | |
| | GEV No. | 100006 | Ref. No. — |
| | piezoelectric igniter suitable for ELETROSIT body plastic blowing connection ø2.4mm ø 14mm | | |
| | GEV No. | 100904 | Ref. No. 052833 0K2497 100904 102504 |
| | locking screw M10x1 for pipe ø 4mm Qty 1 pcs | | |
| | GEV No. | 100905 | Ref. No. 052834 0958031 |
| | locking screw M10x1 for pipe ø 6mm Qty 1 pcs | | |
| | GEV No. | 101301 | Ref. No. — |
| | gas connection thread 1/2" straight ELETROSIT screw with O-ring | | |
| | GEV No. | 101303 | Ref. No. — |
| | gas connection straight thread 3/4" ELETROSIT | | |
| | GEV No. | 101309 | Ref. No. 051281 055805 |
| | extension | | |

2 gas components



| | | | | |
|------------------------|---|-----------------|---|--------------------------------------|
| 1 | | | | |
| GEV No. | 101122 | Ref. No. | 00000027 053242 054437 0810110 | |
| description | gas valve SIT type ELETTROSIT 24V gas inlet 3/4" gas outlet 3/4" thermocouple connection M9x1 equiv. no. 0.810.171 pilot outlet M10x1 | | | |
| For models: | HFR/G1680, HFR/G2480 | | | |
| spare parts for | 101122 | | | |
| | GEV No. | 101312 | Ref. No. 004217 054539 056601 0927011 0927012 0H6997 | |
| | microswitch | | | |
| accessories for | 101122 | | | |
| | GEV No. | 100006 | Ref. No. | — |
| | piezoelectric igniter suitable for ELETTROSIT body plastic blowing connection ø2.4mm ø 14mm | | | |
| | GEV No. | 100904 | Ref. No. | 052833 0K2497 100904 102504 |
| | locking screw M10x1 for pipe ø 4mm Qty 1 pcs | | | |
| | GEV No. | 100905 | Ref. No. | 052834 0958031 |
| | locking screw M10x1 for pipe ø 6mm Qty 1 pcs | | | |
| | GEV No. | 101301 | Ref. No. | — |
| | gas connection thread 1/2" straight ELETTROSIT screw with O-ring | | | |
| | GEV No. | 101303 | Ref. No. | — |
| | gas connection straight thread 3/4" ELETTROSIT | | | |
| | GEV No. | 101309 | Ref. No. | 051281 055805 |
| | extension | | | |





NOVASIT



| | | | | |
|------------------------|--|-----------------|-------------------|--|
| 1 | | | | |
| GEV No. | 101760 | Ref. No. | 006182 0820060 | |
| description | gas valve SIT series Novasit 820 220V 50Hz gas inlet 1/2" gas outlet 1/2" thermocouple connection M9x1 pilot connection M10x1 ignition pressure 3-5mbar pressure range 3-30mbar pressure regulator connection blind equiv. no. 0.820.060 | | | |
| For models: | FCFG10160H, FCF/G101/1, ACFG10160H | | | |
| spare parts for | 101760 | | | |
| | GEV No. | 101065 | Ref. No. | 0006245 056589 0K2953 |
| | magnet unit with cable L 44mm D1 ø 30mm D2 ø 20mm suitable for NOVASIT | | | |
| | GEV No. | 101867 | Ref. No. | — |
| | solenoid coil 220V 60Hz | | | |
| accessories for | 101760 | | | |
| | GEV No. | 100006 | Ref. No. | — |
| | piezoelectric igniter suitable for ELETTROSIT body plastic blowing connection ø2.4mm ø 14mm | | | |
| | GEV No. | 100904 | Ref. No. | 052833 0K2497 100904 102504 |
| | locking screw M10x1 for pipe ø 4mm Qty 1 pcs | | | |
| | GEV No. | 100905 | Ref. No. | 052834 0958031 |
| | locking screw M10x1 for pipe ø 6mm Qty 1 pcs | | | |
| | GEV No. | 101305 | Ref. No. | — |
| | gas connection straight 1/2" flange 45x45mm ELETTROSIT/V4400/4600/4605 suitable for SIT/HONEYWELL hole distance 36x36mm | | | |
| | GEV No. | 101306 | Ref. No. | 0A5398 |
| | gas connection angled flange 45x45mm hole distance 36x36mm 1/2" ELETTROSIT/V4400/4600/4605 screw with O-ring suitable for SIT/HONEYWELL | | | |
| | GEV No. | 101307 | Ref. No. | — |
| | gas connection straight flange 45x45mm hole distance 36x36mm 3/4" ELETTROSIT/V4400/4600/4605 screw with O-ring suitable for SIT/HONEYWELL | | | |
| | GEV No. | 101308 | Ref. No. | — |
| | gas connection angled flange 45x45mm hole distance 36x36mm 3/4" ELETTROSIT/V4400/4600/4605 screw with O-ring suitable for SIT/HONEYWELL | | | |
| | GEV No. | 101312 | Ref. No. | 004217 054539 056601 0927011 0927012 0H6997 |
| | microswitch | | | |
| | GEV No. | 101313 | Ref. No. | 0967064 0K3020 |
| | solenoid coil 230V 50Hz | | | |

Table continues overleaf



| | | | | |
|---|---------|--------|----------|-------------------|
| accessories for 101760 | | | | |
|  | GEV No. | 101314 | Ref. No. | — |
| solenoid coil 24V 50Hz | | | | |
|  | GEV No. | 101317 | Ref. No. | 0960103 OK3022 |
| plug with cable L 1000mm suitable for NOVASIT | | | | |
|  | GEV No. | 101318 | Ref. No. | — |
| cover cap for solenoid coil suitable for NOVASIT | | | | |
|  | GEV No. | 101503 | Ref. No. | — |
| O-ring EPDM thickness 2mm ID ø 32mm Qty 1 pcs | | | | |

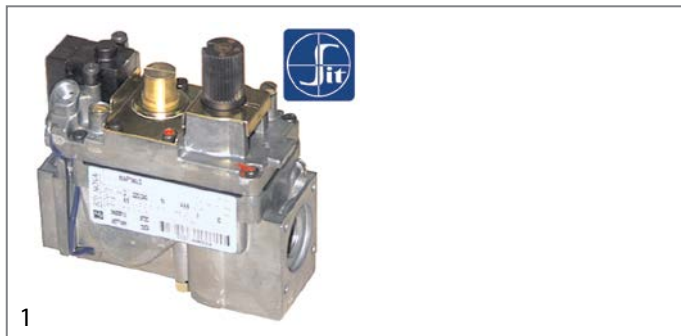

| | | | |
|----------------|--------|-----------------|-----------------------------|
| GEV No. | 101162 | Ref. No. | 055446 0820010 OKF020 |
|----------------|--------|-----------------|-----------------------------|

description gas valve SIT series Novasit 820 230V 50Hz gas inlet 1/2" gas outlet 1/2" thermocouple connection M9x1 pilot connection M10x1 ignition pressure 3-5mbar pressure range 3-30mbar pressure regulator connection blind equiv. no. 0.820.010

For models: AFR/G410D, AFR/G810D, AFR/G410NL, FCVG10-2, FCVG10-4, FCVG10-ISG, FCVG10-2, FCVG10-4D, FCVG10-2UK, FCVG10-4UK, FCVG10-2, FCVG10-4, FCVG20-2, FCVG20-4, FCVG20-2, FCVG20-4D, FCVG20-2UK, FCVG20-4UK, FCVG20-4, FCVG20-4D, ZOFCV/G102, ZOFCV/G104, ZOFCV/G202, ZOFCV/G204, FCVG10-ISG, BOFR/G500, ROFR/G1000, ROBR/G1000, ROBR/G1010, ROBR/G1510, ROPN/G1000, ROPN/G1015, ROPN/G1020

| | | | | |
|-------------------------------|--|--|--|--|
| spare parts for 101162 | | | | |
|-------------------------------|--|--|--|--|

| | | | | |
|---|---------|--------|----------|-----------------------------|
|  | GEV No. | 101065 | Ref. No. | 0006245 056589 OK2953 |
| magnet unit with cable L 44mm D1 ø 30mm D2 ø 20mm suitable for NOVASIT | | | | |

| | | | | |
|---|---------|--------|----------|-------------------|
|  | GEV No. | 101313 | Ref. No. | 0967064 OK3020 |
| solenoid coil 230V 50Hz | | | | |

| | | | | |
|-------------------------------|--|--|--|--|
| accessories for 101162 | | | | |
|-------------------------------|--|--|--|--|





| | | | | |
|---|---------|--------|----------|---|
|  | GEV No. | 100006 | Ref. No. | — |
| piezoelectric igniter suitable for ELETTROSIT body plastic blowing connection ø2.4mm ø 14mm | | | | |

| | | | | |
|---|---------|--------|----------|---|
|  | GEV No. | 101305 | Ref. No. | — |
| gas connection straight 1/2" flange 45x45mm ELETTROSIT/V4400/4600/4605 suitable for SIT/HONEYWELL hole distance 36x36mm | | | | |

| | | | | |
|---|---------|--------|----------|--------|
|  | GEV No. | 101306 | Ref. No. | 0A5398 |
| gas connection angled flange 45x45mm hole distance 36x36mm 1/2" ELETTROSIT/V4400/4600/4605 screw with O-ring suitable for SIT/HONEYWELL | | | | |

| | | | | |
|---|---------|--------|----------|---|
|  | GEV No. | 101307 | Ref. No. | — |
| gas connection straight flange 45x45mm hole distance 36x36mm 3/4" ELETTROSIT/V4400/4600/4605 screw with O-ring suitable for SIT/HONEYWELL | | | | |

| | | | | |
|---|---------|--------|----------|---|
|  | GEV No. | 101308 | Ref. No. | — |
| gas connection angled flange 45x45mm hole distance 36x36mm 3/4" ELETTROSIT/V4400/4600/4605 screw with O-ring suitable for SIT/HONEYWELL | | | | |

| | | | | |
|---|---------|--------|----------|--|
| accessories for 101162 | | | | |
|  | GEV No. | 101312 | Ref. No. | 004217 054539 056601 0927011 0927012 0H6997 |
| microswitch | | | | |
|  | GEV No. | 101314 | Ref. No. | — |
| solenoid coil 24V 50Hz | | | | |
|  | GEV No. | 101317 | Ref. No. | 0960103 OK3022 |
| plug with cable L 1000mm suitable for NOVASIT | | | | |
|  | GEV No. | 101318 | Ref. No. | — |
| cover cap for solenoid coil suitable for NOVASIT | | | | |





| | | | |
|----------------|--------|-----------------|-------------------|
| GEV No. | 101761 | Ref. No. | 003719 0820034 |
|----------------|--------|-----------------|-------------------|

description gas valve SIT series Novasit 820 230V 50Hz gas inlet 1/2" gas outlet 1/2" thermocouple connection M9x1 pilot connection M10x1 ignition pressure 3-5mbar pressure range 3-30mbar pressure regulator connection RP equiv. no. 0.820.034

For models: FCFG101/0, FCFG102-0, FCFG201-0, FCFG202-0, FCFG102-0T, FCF/G101/1-1-JAP, FCF/G102/1-1-JAP, ECFG101-0, ECFG102-0, ECFG201-0, ECFG202-0, ACFG101-0, ACFG102-0, ACFG201-0, ACFG202-0, JCF/G101/1-1, JCF/G102/1-1, RCF101G, NCF/G101/1, NCF/G102/1, ZCF/G101/1, ZCF/G102/1, ZCF/G201/1, ZCF/G202/1

| | | | | |
|-------------------------------|--|--|--|--|
| spare parts for 101761 | | | | |
|-------------------------------|--|--|--|--|

| | | | | |
|---|---------|--------|----------|-----------------------------|
|  | GEV No. | 101065 | Ref. No. | 0006245 056589 OK2953 |
| magnet unit with cable L 44mm D1 ø 30mm D2 ø 20mm suitable for NOVASIT | | | | |

| | | | | |
|---|---------|--------|----------|-------------------|
|  | GEV No. | 101313 | Ref. No. | 0967064 OK3020 |
| solenoid coil 230V 50Hz | | | | |

| | | | | |
|-------------------------------|--|--|--|--|
| accessories for 101761 | | | | |
|-------------------------------|--|--|--|--|

| | | | | |
|---|---------|--------|----------|---|
|  | GEV No. | 100006 | Ref. No. | — |
| piezoelectric igniter suitable for ELETTROSIT body plastic blowing connection ø2.4mm ø 14mm | | | | |

| | | | | |
|---|---------|--------|----------|---|
|  | GEV No. | 101305 | Ref. No. | — |
| gas connection straight 1/2" flange 45x45mm ELETTROSIT/V4400/4600/4605 suitable for SIT/HONEYWELL hole distance 36x36mm | | | | |

| | | | | |
|---|---------|--------|----------|--------|
|  | GEV No. | 101306 | Ref. No. | 0A5398 |
| gas connection angled flange 45x45mm hole distance 36x36mm 1/2" ELETTROSIT/V4400/4600/4605 screw with O-ring suitable for SIT/HONEYWELL | | | | |











| | | | | |
|---|---------|--------|----------|---|
|  | GEV No. | 101307 | Ref. No. | — |
| gas connection straight flange 45x45mm hole distance 36x36mm 3/4" ELETTROSIT/V4400/4600/4605 screw with O-ring suitable for SIT/HONEYWELL | | | | |

Table continues overleaf

| | | | | |
|---|---------|--------|----------|--|
| accessories for 101761 | | | | |
|  | GEV No. | 101308 | Ref. No. | — |
| gas connection angled flange 45x45mm hole distance 36x36mm 3/4" ELETTROSIT/V4400/4600/4605 screw with O-ring suitable for SIT/HONEYWELL | | | | |
|  | GEV No. | 101312 | Ref. No. | 004217 054539 056601 0927011 0927012 0H6997 |
| microswitch | | | | |
|  | GEV No. | 101314 | Ref. No. | — |
| solenoid coil 24V 50Hz | | | | |
|  | GEV No. | 101317 | Ref. No. | 0960103 0K3022 |
| plug with cable L 1000mm suitable for NOVASIT | | | | |
|  | GEV No. | 101318 | Ref. No. | — |
| cover cap for solenoid coil suitable for NOVASIT | | | | |



| | | | |
|---|--|-----------------|-------------------|
| GEV No. | 101956 | Ref. No. | 002903 0820031 |
| description | gas valve SIT series Novasit 820 230V 50Hz gas inlet 1/2" gas outlet 1/2" thermocouple connection M9x1 pilot connection M10x1 ignition pressure regulator pressure range 5-50mbar pressure regulator connection blind equiv. no. 0.820.031 | | |
| For models: | PPD/G260, PPI/G260P, OPD/G260, OPI/G260P, TPD/G260, TPI/G260P, KPI/G10, KPI/G15, KPD/G10, KPD/G15, KPD/G15A, KPI/G15A, KPI/G06, KPI/G15H, KPI/G10H, KBR/G2F, KBR/G2C, KBR/G3F, KBR/G3FH, KBR/G3C, KBR/G3CH, KBR/G2FH, KBR/G2CH, KFH/G1, KFH/G1ELH, KFH/G1EH, KCP/G1, KCP/G1R, KCP/G2, KCP/G2R, HFR/G410, HFR/G810, HFR/G410D, HFR/G810D, HFR/G410NL, HFR/G810NL, HFR/G411, HFR/G412, HFH/G430, HFH/G400U, HFH/G401U, HFH/G435, HBR/G820, HBR/G825, QPI/G10, QPI/G15, QPD/G10, QPD/G15, QPI/G06, QPI/G15H...(Other models you can see in the webshop) | | |
| spare parts for 101956 | | | |
|  | GEV No. | 101065 | Ref. No. |
| 0006245 056589 0K2953 | | | |
| magnet unit with cable L 44mm D1 ø 30mm D2 ø 20mm suitable for NOVASIT | | | |
|  | GEV No. | 101313 | Ref. No. |
| 0967064 0K3020 | | | |
| solenoid coil 230V 50Hz | | | |
| accessories for 101956 | | | |
|  | GEV No. | 100006 | Ref. No. |
| — | | | |
| piezoelectric igniter suitable for ELETTROSIT body plastic blowing connection ø2.4mm ø 14mm | | | |
|  | GEV No. | 101305 | Ref. No. |
| — | | | |
| gas connection straight 1/2" flange 45x45mm ELETTROSIT/V4400/4600/4605 suitable for SIT/HONEYWELL hole distance 36x36mm | | | |
|  | GEV No. | 101306 | Ref. No. |
| 0A5398 | | | |
| gas connection angled flange 45x45mm hole distance 36x36mm 1/2" ELETTROSIT/V4400/4600/4605 screw with O-ring suitable for SIT/HONEYWELL | | | |

| | | | | |
|---|---------|--------|----------|--|
| accessories for 101956 | | | | |
|  | GEV No. | 101307 | Ref. No. | — |
| gas connection straight flange 45x45mm hole distance 36x36mm 3/4" ELETTROSIT/V4400/4600/4605 screw with O-ring suitable for SIT/HONEYWELL | | | | |
|  | GEV No. | 101308 | Ref. No. | — |
| gas connection angled flange 45x45mm hole distance 36x36mm 3/4" ELETTROSIT/V4400/4600/4605 screw with O-ring suitable for SIT/HONEYWELL | | | | |
|  | GEV No. | 101312 | Ref. No. | 004217 054539 056601 0927011 0927012 0H6997 |
| microswitch | | | | |
|  | GEV No. | 101314 | Ref. No. | — |
| solenoid coil 24V 50Hz | | | | |
|  | GEV No. | 101317 | Ref. No. | 0960103 0K3022 |
| plug with cable L 1000mm suitable for NOVASIT | | | | |
|  | GEV No. | 101318 | Ref. No. | — |
| cover cap for solenoid coil suitable for NOVASIT | | | | |















| | | | |
|---|---|-----------------|-------------------|
| GEV No. | 101967 | Ref. No. | 059473 0822110 |
| description | gas valve SIT series Novasit 822 230V 50Hz gas inlet 1/2" gas outlet 1/2" thermocouple connection pilot connection M10x1 ignition pressure 3-5mbar pressure range 3-30mbar pressure regulator connection perforated equiv. no. 0.822.110 | | |
| For models: | HBR/G800, HBR/G805, HBR/G801, HBR/G806, HBR/G810, HBR/G815, HBR/G811, HBR/G816, HBR/G800D, HBR/G805D, HBR/G801D, HBR/G806D, HBR/G810D, HBR/G815D, HBR/G811D, HBR/G816D, HBR/G800NL, HBR/G805NL, HBR/G810NL, HBR/G800UK, ZBR/G800, ZBR/G805, ZBR/G801, ZBR/G806, ZBR/G810, ZBR/G815, ZBR/G811, ZBR/G816, ZBR/G800D, ZBR/G805D, ZBR/G801D, ZBR/G806D, ZBR/G810D, ZBR/G815D, ZBR/G811D, ZBR/G816D, ZBR/G800UK, ABR/G800, ABR/G805, ABR/G801, ABR/G806, ABR/G810, ABR/G815, ABR/G811, ABR/G816, ABR/G800D, ABR/G805D, ABR/G801D, ABR/G806D, ABR/G810D...(Other models you can see in the webshop) | | |
| spare parts for 101967 | | | |
|  | GEV No. | 101313 | Ref. No. |
| 0967064 0K3020 | | | |
| solenoid coil 230V 50Hz | | | |
|  | GEV No. | 101542 | Ref. No. |
| — | | | |
| solenoid coil 50Hz NOVA 822/826/827 suitable for NOVASIT 230V | | | |
| accessories for 101967 | | | |
|  | GEV No. | 100904 | Ref. No. |
| 052833 0K2497 100904 102504 | | | |
| locking screw M10x1 for pipe ø 4mm Qty 1 pcs | | | |

Table continues overleaf



| accessories for | | 101967 | | |
|---|---|--------|----------|-------------------|
|  | GEV No. | 100905 | Ref. No. | 052834 0958031 |
| | locking screw M10x1 for pipe ø6mm Qty 1 pcs | | | |
|  | GEV No. | 101305 | Ref. No. | — |
| | gas connection straight 1/2" flange 45x45mm ELETTROSIT/V4400/4600/4605 suitable for SIT/HONEYWELL hole distance 36x36mm | | | |
|  | GEV No. | 101306 | Ref. No. | 0A5398 |
| | gas connection angled flange 45x45mm hole distance 36x36mm 1/2" ELETTROSIT/V4400/4600/4605 screw with O-ring suitable for SIT/HONEYWELL | | | |
|  | GEV No. | 101307 | Ref. No. | — |
| | gas connection straight flange 45x45mm hole distance 36x36mm 3/4" ELETTROSIT/V4400/4600/4605 screw with O-ring suitable for SIT/HONEYWELL | | | |
|  | GEV No. | 101308 | Ref. No. | — |
| | gas connection angled flange 45x45mm hole distance 36x36mm 3/4" ELETTROSIT/V4400/4600/4605 screw with O-ring suitable for SIT/HONEYWELL | | | |
|  | GEV No. | 101503 | Ref. No. | — |
| | O-ring EPDM thickness 2mm ID ø 32mm Qty 1 pcs | | | |
|  | GEV No. | 101924 | Ref. No. | — |
| | plug with cable L 1090mm suitable for NOVA 822/826/827 | | | |

| | | | | |
|--|---|--------|----------|--------|
|  | | | | |
| 1 | GEV No. | 106858 | Ref. No. | 059032 |
| | description gas valve SIT series Novasit 825 24V 50Hz gas inlet 1/2" gas outlet 1/2" thermocouple connection M9x1 pilot connection M10x1 ignition pressure 3-5mbar pressure range 3-37mbar pressure regulator connection standard | | | |
| | For models: FCVG10-P, FCVG10PUK, FCVG20-P, FCVG20PUK, AFCV/G101, AFCV/G103, SCO/G10-3, AFCV/G201, AFCV/G203, SCO/G20-3 | | | |

| accessories | | | | |
|---|--|--------|----------|--------|
|  | | | | |
| 1 | GEV No. | 101306 | Ref. No. | 0A5398 |
| | description gas connection angled flange 45x45mm hole distance 36x36mm 1/2" ELETTROSIT/V4400/4600/4605 screw with O-ring suitable for SIT/HONEYWELL | | | |
| | For models: KFH/G1, KFH/G1ELH, KFH/G1EH, HFR/G410, HFR/G810, HFR/G410D, HFR/G810D, HFR/G410NL, HFR/G810NL, HFR/G411, HFR/G412, HFH/G430, HFH/G400U, HFH/G401U, HFH/G435, QFH/G1, QFH/G1ELH, QFH/G1EH, ZFR/G410, ZFR/G810, ZFR/G410D, ZFR/G810D, ZFR/G411, ZFR/G412, ZFH/G430, ZFH/G435, WFH/G1, WFH/G1ELH, WFH/G1EH, AFH/G435, FCFG101/0, FCFG102-0, FCFG201-0, FCFG202-0, FCFG10160H, FCFG102-0T, FCF/G101/1-1-JAP, FCF/G102/1-1-JAP, FCF/G101/1, ECFG101-0, ECFG102-0, ECFG201-0, ECFG202-0, ACFG101-0, ACFG102-0, ACFG201-0, ACFG202-0, ACFG10160H, RCF101G, NCF/G101/1...(Other models you can see in the webshop) | | | |
| | spare parts for 101306 | | | |
|  | GEV No. | 517104 | Ref. No. | — |
| | O-ring EPDM thickness 2.62mm ID ø 31.42mm Qty 1 pcs | | | |

| | | | | |
|---|--|--------|----------|--------|
|  | | | | |
| 1 | GEV No. | 101799 | Ref. No. | 004667 |
| | description knob adapter shaft ø 10x8mm shaft L 18mm catch lower suitable for ZANUSSI shaft flat upper | | | |
| | For models: RFR/G2S40, XFR/G2S40, JFR/G2S40, MFR/G2S40, PFR/G2S40, TFR/G2S40, KBR/G2F, KBR/G2C, KBR/G3F, KBR/G3FH, KBR/G3C, KBR/G3CH, KBR/G2FH, KBR/G2CH, QBR/G2F, QBR/G2C, QBR/G3F, QBR/G3FH, QBR/G3C, QBR/G3CH, QBR/G2FH, QBR/G2CH, WBR/G2F, WBR/G2C, WBR/G3F, WBR/G3FH, WBR/G3C, WBR/G3CH, WBR/G2FH, WBR/G2CH | | | |

| | | | | |
|---|---|--------|----------|--------------------------------------|
|  | | | | |
| 1 | GEV No. | 101928 | Ref. No. | 059305 0K4321 0T2595 757924 |
| | description knob adapter shaft ø 10x8mm shaft L 18mm catch upper suitable for ZANUSSI shaft flat upper | | | |
| | For models: CRN22G, CRN/20G, CRN30G, CRN15G, HFR/G410, HFR/G810, HFR/G410D, HFR/G810D, HFR/G410NL, HFR/G810NL, HFR/G411, HFR/G412, HFH/G430, HFH/G400U, HFH/G401U, HBR/G820, HBR/G825, HBR/G800, HBR/G805, HBR/G810, HBR/G815, HBR/G811, HBR/G816, HBR/G800UK, HBR/G821UK, CRN/22GZ, CRN20GZ, CRN30GZ, CRN15GZ, ZFR/G410, ZFR/G810, ZFR/G410D, ZFR/G810D, ZFR/G411, ZFR/G412, ZFH/G430, ZBR/G821, ZBR/G826, ZBR/G800, ZBR/G805, ZBR/G810, ZBR/G815, ZBR/G811, ZBR/G816, ZBR/G800UK, CRN20GA, CRN30GA, CRN15GA, AFR/G410, AFR/G810...(Other models you can see in the webshop) | | | |



| | | | |
|--------------------|--|-----------------|-------------------|
| GEV No. | 100905 | Ref. No. | 052834 0958031 |
| description | locking screw M10x1 for pipe ø 6mm Qty 1 pcs | | |
| For models: | MBR/G710D, MBR/G700, MBR/G700F, MBR/G700UK, MBR/G701, MBR/G706, MBR/G701UK, MBR/G751, MBR/G756, MM/G351, MM/G701, MM/G350, MM/G700, MM/G350F, MM/G700F, MM/G700E, RBR/G710D, RBR/G700, RBR/G700F, 7BRG60, 7BRG60X, RBR/G701UK, RBR/G751, RBR/G756, RM/G350D, RM/G700D, 7BMG03T, 7BMG07T, RM/G350F, RM/G700F, XBR/G710D, XBR/G700, XBR/G710, XBR/G700F, XBR/G700UK, XBR/G701, M70GBP, XBR/G701UK, XBR/G751, XBR/G756, CBR/G700, XM/G350D, XM/G700D, T35GBM, T70GBM, XM/G350F, XM/G700F, CM/G700, RMG300, RM/G300D...(Other models you can see in the webshop) | | |



| | | | |
|--------------------|--|-----------------|-----------------------------|
| GEV No. | 101065 | Ref. No. | 0006245 056589 0K2953 |
| description | magnet unit with cable L 44mm D1 ø 30mm D2 ø 20mm suitable for NOVASIT | | |



| | | | |
|--------------------|---|-----------------|--|
| GEV No. | 101312 | Ref. No. | 004217 054539 056601 0927011 0927012 0H6997 |
| description | microswitch | | |
| For models: | PPD/G260, PPI/G260P, OPD/G260, OPI/G260P, TPD/G260, TPI/G260P, KPI/G10, KPI/G15, KPD/G10, KPD/G15, KPD/G15A, KPI/G15A, KPI/G06, KPI/G15H, KPI/G10H, KFH/G1, KFH/G1ELH, KFH/G1EH, KCP/G1RU, KCP/G2RU, KCP/G1, KCP/G1R, KCP/G2, KCP/G2R, CRN22G, CRN/20G, CRN30G, CRN15G, KCP/G1U, KCP/G2U, HFR/G410, HFR/G810, HFR/G410D, HFR/G810D, HFR/G410NL, HFR/G810NL, HFR/G411, HFR/G412, HFH/G430, HFH/G400U, HFH/G401U, HFH/G435, HBR/G820, HBR/G825, QPI/G10, QPI/G15, QPD/G10, QPD/G15, QPI/G06, QPI/G15H...(Other models you can see in the webshop) | | |



| | | | |
|--------------------|---|-----------------|-------------------|
| GEV No. | 101317 | Ref. No. | 0960103 0K3022 |
| description | plug with cable L 1000mm suitable for NOVASIT | | |
| For models: | 7550-2, 7551-2, 7552-2, 7553-2 | | |



| | | | |
|--------------------|--|-----------------|--------|
| GEV No. | 101925 | Ref. No. | 059474 |
| description | plug with O-ring thread M10x1 for pilot burner suitable for NOVASIT | | |
| For models: | FDV40G, FDV40GZ, FDV40GA, FDV20G, FDV20GZ, FDV20GA, HBR/G800, HBR/G805, HBR/G801, HBR/G806, HBR/G810, HBR/G815, HBR/G811, HBR/G816, HBR/G800D, HBR/G805D, HBR/G801D, HBR/G806D, HBR/G810D, HBR/G815D, HBR/G811D, HBR/G816D, HBR/G800NL, HBR/G805NL, HBR/G810NL, HBR/G800UK, ZBR/G800, ZBR/G805, ZBR/G801, ZBR/G806, ZBR/G810, ZBR/G815, ZBR/G811, ZBR/G816, ZBR/G800D, ZBR/G805D, ZBR/G801D, ZBR/G806D, ZBR/G810D, ZBR/G815D, ZBR/G811D, ZBR/G816D, ZBR/G800UK, ABR/G800, ABR/G805, ABR/G801, ABR/G806, ABR/G810, ABR/G815, ABR/G811...(Other models you can see in the webshop) | | |



| | | | |
|---|--|-----------------|-------------------|
| GEV No. | 101313 | Ref. No. | 0967064 0K3020 |
| description | solenoid coil 230V 50Hz | | |
| For models: | PPD/G260, PPI/G260P, OPD/G260, OPI/G260P, TPD/G260, TPI/G260P, KPD/G10, KPD/G15, KPD/G15A, KPI/G06, KBR/G2F, KBR/G2C, KBR/G3F, KBR/G3FH, KBR/G3C, KBR/G3CH, KBR/G2FH, KBR/G2CH, KCP/G1, KCP/G1R, KCP/G2, KCP/G2R, QPI/G10, QPI/G15, QPD/G10, QPD/G15, QPI/G06, QPI/G15H, QPI/G10H, QBR/G2F, QBR/G2C, QBR/G3F, QBR/G3FH, QBR/G3C, QBR/G3CH, QBR/G2FH, QBR/G2CH, QCP/G1, QCP/G1R, QCP/G2, QCP/G2R, WPI/G10, WPI/G15, WPD/G10, WPD/G15, WPD/G15A, WPI/G15A, WPI/G06, WPI/G15H, WPI/G10H...(Other models you can see in the webshop) | | |
| accessories for | 101313 | | |
|  | GEV No. | 550896 | Ref. No. — |
| | gasket with screw gas valves NOVASIT | | |



SIGMA



| | | | |
|--|--|-----------------|-------------------|
| 1 | | | |
| GEV No. | 106009 | Ref. No. | 0848037 0C1057 |
| description | gas valve 230V 50Hz gas inlet 3/4" gas outlet 3/4" pressure range 0.5-12mbar Sigma equiv. no. 0.848.037 | | |
| For models: | FCZ061GAG, FCZ101GAG, FCZ102GAG, FCZ201GAG, FCZ202GAG, FCZ061GAD, FCZ101GAD, FCZ102GAD, FCZ201GAD, FCZ202GAD, FCZ101GTG, FCZ102GTG, FCZ201GTG, FCZ202GTG, FCZ101GTD, FCZ102GTD, FCZ201GTD, FCZ202GTD, FCZ061GBG, FCZ101GBG, FCZ102GBG, FCZ201GBG, FCZ202GBG, FCZ061GBD, FCZ101GBD, FCZ102GBD, FCZ201GBD, FCZ202GBD, FCZ061GBI, FCZ101GBI, FCZ201GBI, FCZ101GBG2, FCZ102GBG2, FCZ201GBG2, FCZ202GBG2, FCZ101GBD2, FCZ102GBD2, FCZ201GBD2, FCZ202GBD2, FCZ101GBI2, FCZ102GBI2, FCZ201GBI2, FCZ061GCG, FCZ101GCG, FCZ102GCG, FCZ201GCG, FCZ202GCG, FCZ061GCD, FCZ101GCD, FCZ102GCD... (Other models you can see in the webshop) | | |
| accessories for | 106009 | | |
| | GEV No. | 107222 | Ref. No. — |
| plug for solenoid valve 3-pole cable length 1070mm | | | |



| | | | |
|--|--|-----------------|-----------------------------|
| 1 | | | |
| GEV No. | 101989 | Ref. No. | 005757 0840016 0C7600 |
| description | gas valve 230V 50Hz gas inlet 3/4" gas outlet 3/4" SIT pressure range 2-50mbar equiv. no. 0.840.016 | | |
| For models: | FCVG6L3CJ, FCV/G6L3C, FCV/G61/1, FCV/G61/1, FCV/G61/1, FCV/G61/1, FCVG6L3CT, 5721-2-7, 5721-2-10, ECV/G6T4C, ECV/G61/1, ECV/G61/1, RCV061G2, ACV/G6C3C, ZCV/G6T4C, ZCV/G61/1 | | |
| spare parts for | 101989 | | |
| | GEV No. | 106214 | Ref. No. — |
| solenoid coil 230V 50Hz Sigma | | | |
| accessories for | 101989 | | |
| | GEV No. | 107222 | Ref. No. — |
| plug for solenoid valve 3-pole cable length 1070mm | | | |







| | | | |
|--|--|-----------------|-------------------|
| 1 | | | |
| GEV No. | 107547 | Ref. No. | 0G2763 |
| description | gas valve type Sigma 230V 50Hz gas inlet 3/4" ET gas outlet 3/4" ET pressure range 2-50mbar equiv. no. 0063AS4831 | | |
| For models: | AVRBOA0000, AVRCOA0000, AVREOA0000, AVRBOFO000, AVRCOFO000, AVREOFO000, AVRBOATO00, AVRCOATO00, AVREOATO00, AVRBOFTO00, AVRCOFTO00, AVREOFTO00 | | |
| spare parts for | 107547 | | |
| | GEV No. | 106214 | Ref. No. — |
| solenoid coil 230V 50Hz Sigma | | | |
| accessories for | 107547 | | |
| | GEV No. | 107222 | Ref. No. — |
| plug for solenoid valve 3-pole cable length 1070mm | | | |







TANDEM



| | | | |
|---|--|-----------------|-----------------------------------|
| 1 | | | |
| GEV No. | 101984 | Ref. No. | 002714 0K2200 |
| description | gas valve 230V 50Hz gas inlet 1/2" gas outlet 1/2" pilot connection level slow ignition ignition times pressure range 2-50mbar power supply for modulator 230VAC rectified Tandem equiv. no. 0.836.010 | | |
| For models: | FDV40G, FDV40GZ, FDV40GA, FDV20G, FDV20GZ, FDV20GA, BRN70G, BRN70GZ, BR70GZ, BRNG70A, FCV/G10L6JAP, FCV/G102/1L6JAP, FCV/G6L4, FCV/G10L6, FCV/G102/1L6, FCV/G20L6, FCVG202L6, FCV/G101/1, FCV/G102/1, FCS101G4, FCS101G4DT, FCS101GP, FCS102G4, FCS102GP, 5711-2-6, 5711-2-7, 5711-2-8, 5711-2-10, 5711-2-8CH, 5711-2-10CH, 5712-2-7, 5712-2-8, 5712-2-10, 5714-2-7, 5714-2-8, 5714-2-10, 5714-2-7, 5714-2-8, 5714-2-10, 5711-2-6L, 5711-2-7L, 5711-2-8L, 5711-2-10L, 5712-2-7L, 5712-2-8L, 5712-2-10L, 5714-2-7L, 5714-2-8L, 5714-2-10L, 5714-2-7L... (Other models you can see in the webshop) | | |
| spare parts for | 101984 | | |
| | GEV No. | 101379 | Ref. No. 002452 0967090 |
| solenoid coil 230V 50Hz suitable for Tandem | | | |
| accessories for | 101984 | | |
| | GEV No. | 101274 | Ref. No. — |
| olive for pipe ø 16mm Qty 1 pcs | | | |
| | GEV No. | 101275 | Ref. No. 052668 |
| union screw thread 1/2" for pipe ø 16mm Qty 1 pcs | | | |









Table continues overleaf

| | | | |
|---|---------|--------|-----------------|
| accessories for 101984 | | | |
|  | GEV No. | 101925 | Ref. No. 059474 |
| plug with O-ring thread M10x1 for pilot burner suitable for NOVASIT | | | |
|  | GEV No. | 102845 | Ref. No. — |
| gas connection angled 1/2" flange 32x32mm hole distance 24x24mm Tandem | | | |
|  | GEV No. | 102846 | Ref. No. — |
| gas connection straight 1/2" flange 32x32mm hole distance 24x24mm suitable for Tandem | | | |
|  | GEV No. | 102847 | Ref. No. — |
| O-ring | | | |

| | | | |
|---|--|-----------------|-------------------------|
|  | | | |
| 1 | | | |
| GEV No. | 101684 | Ref. No. | 0C6359 |
| description | gas valve 230V 50Hz gas inlet 1/2" gas outlet 1/2" pilot connection level slow ignition standard ignition time 3-7s pressure range 3-50mbar power supply for modulator type SIT equiv. no. 0.830.034 | | |
| spare parts for | 101684 | | |
|  | GEV No. | 101379 | Ref. No. 002452 0967090 |
| solenoid coil 230V 50Hz suitable for Tandem | | | |
| accessories for | 101684 | | |
|  | GEV No. | 101274 | Ref. No. — |
| olive for pipe ø 16mm Qty 1 pcs | | | |
|  | GEV No. | 101275 | Ref. No. 052668 |
| union screw thread 1/2" for pipe ø 16mm Qty 1 pcs | | | |
|  | GEV No. | 102845 | Ref. No. — |
| gas connection angled 1/2" flange 32x32mm hole distance 24x24mm Tandem | | | |
|  | GEV No. | 102846 | Ref. No. — |
| gas connection straight 1/2" flange 32x32mm hole distance 24x24mm suitable for Tandem | | | |
|  | GEV No. | 102847 | Ref. No. — |
| O-ring | | | |

| | | | |
|---|---|-----------------|--------------------------------------|
|  | | | |
| 1 | | | |
| GEV No. | 101189 | Ref. No. | 002340 005897 0K1416 |
| description | gas valve 230V 50Hz gas inlet 1/2" gas outlet 1/2" pilot connection M10x1 level slow ignition ignition times pressure range 3-50mbar power supply for modulator equiv. no. 0.830.040 suitable for Tandem | | |
| For models: | FCV/G10L3, FCVG10L3T, FCVG102L3, FCV/G20L3, FCVG202L3, FCVG10L3J, FCVG102L3J, FCV/G10L2, FCV/G6L4, FCS101G2, FCV-MG62, 5711-2-6, 5711-2-7, 5711-2-8, 5711-2-10, 5711-2-8CH, 5711-2-10CH, 5712-2-6, 5714-2-6, 5717-2-6, 5711-2-6L, 5711-2-7L, 5711-2-8L, 5711-2-10L, 5712-2-6L, 5714-2-6L, 5714-2-6L, 5712-2-10F, 5714-2-10F, 5702-2-2, 5704-2-2, 5707-2-2, ECV/G6T4, ZCBDG8, ZCBDG12, ZCBDG18, RCV101G2, ACV/G10C2, NCV/G10L2, ZCV/G6T4, 7573-2, 7574-2, 7575-2, 7576-2, 7773-2, 7774-2, 7775-2, 7776-2, 9100-2, 9101-2...(Other models you can see in the webshop) | | |
| spare parts for | 101189 | | |
|  | GEV No. | 101379 | Ref. No. 002452 0967090 |
| solenoid coil 230V 50Hz suitable for Tandem | | | |
| accessories for | 101189 | | |
|  | GEV No. | 100904 | Ref. No. 052833 0K2497 100904 102504 |
| locking screw M10x1 for pipe ø 4mm Qty 1 pcs | | | |
|  | GEV No. | 100905 | Ref. No. 052834 0958031 |
| locking screw M10x1 for pipe ø 6mm Qty 1 pcs | | | |
|  | GEV No. | 101274 | Ref. No. — |
| olive for pipe ø 16mm Qty 1 pcs | | | |
|  | GEV No. | 101275 | Ref. No. 052668 |
| union screw thread 1/2" for pipe ø 16mm Qty 1 pcs | | | |
|  | GEV No. | 101925 | Ref. No. 059474 |
| plug with O-ring thread M10x1 for pilot burner suitable for NOVASIT | | | |
|  | GEV No. | 102845 | Ref. No. — |
| gas connection angled 1/2" flange 32x32mm hole distance 24x24mm Tandem | | | |
|  | GEV No. | 102846 | Ref. No. — |
| gas connection straight 1/2" flange 32x32mm hole distance 24x24mm suitable for Tandem | | | |
|  | GEV No. | 102847 | Ref. No. — |
| O-ring | | | |



| | | | |
|---|--|-----------------|-----------------------------------|
|  | | | |
| 1 | | | |
| GEV No. | 106219 | Ref. No. | OG2188 OK4391 OK5838 |
| description | gas valve 230V 50Hz gas inlet 1/2" gas outlet 1/2" pilot connection M10x1 level slow ignition standard ignition time 3-7s Tandem equiv. no. 0.830.020 | | |
| For models: | FET100G.MS25P.H97, FET080G.MS25S.F98, FET080G.MS25S.W94, BOT060G.MS25.H97, BOT060G.MS25.F98, BOT060G.MS25.W94, BOT080G.MS25.F98, BOT080G.MS25.W94, BOT100G.MS25.F98, BOT100G.MS25.W94, BOT150G.MS25.F18, BOT150G.MS25.W14, BOT060G.MS25.F97, BOT100G.MS25.F97, BOT150G.MS25.F17, FET060G.MS25S.F98, FET060G.MS25S.W94, FET100G.MS25S.F98, FET100G.MS25S.W94, FET060G.MS25P.F98, FET060G.MS25P.W94, FET080G.MS25P.F98, FET080G.MS25P.W94, FET100G.MS25P.F98, FET100G.MS25P.W94, CGB068, CGB069, UGB068, UGB069, FET060G.MS25P.F97, FET100G.MS25P.F97, UET090G.MS25.F98, UET090G.MS25.W94, UET150G.MS25.F98, UET150G.MS25.W94, UET090G.MS25.F97, UET150G.MS25.F97, BON060G.S.F98, BON080G.S.F98, BON100G.S.F98 | | |
| spare parts for | 106219 | | |
|  | GEV No. | 101379 | Ref. No. 002452 0967090 |
| | solenoid coil 230V 50Hz suitable for Tandem | | |
| accessories for | 106219 | | |
|  | GEV No. | 101274 | Ref. No. — |
| | olive for pipe ø 16mm Qty 1 pcs | | |
|  | GEV No. | 101275 | Ref. No. 052668 |
| | union screw thread 1/2" for pipe ø 16mm Qty 1 pcs | | |
|  | GEV No. | 101925 | Ref. No. 059474 |
| | plug with O-ring thread M10x1 for pilot burner suitable for NOVASIT | | |
|  | GEV No. | 101936 | Ref. No. — |
| | gasket with screw Tandem | | |
|  | GEV No. | 102845 | Ref. No. — |
| | gas connection angled 1/2" flange 32x32mm hole distance 24x24mm Tandem | | |
|  | GEV No. | 102846 | Ref. No. — |
| | gas connection straight 1/2" flange 32x32mm hole distance 24x24mm suitable for Tandem | | |

ignition boxes

HONEYWELL



1

| | | | |
|---|---|-----------------|--------------------------------------|
| GEV No. | 101165 | Ref. No. | 002351 0C0921 0E1499 OK2372 |
| description | ignition box HONEYWELL type S4560A 1008 equiv. no. S4560A 1008 electrodes 1 waiting time 0s safety time 10s 220-240V 10VA 50Hz | | |
| For models: | BRN70G, BRN/70GZ, BR70GZ, BRNG70A, FCV/G6L4, FCVMG62, 5711-2-6, 5711-2-7, 5711-2-8, 5711-2-10, 5711-2-8CH, 5711-2-10CH, 5711-2-6L, 5711-2-7L, 5711-2-8L, 5711-2-10L, ECV/G6T4, HCPA/G1219, CPD42G-Z, CPD40GZ, CPD42V-Z, CPD42E-Z, CPD40VZ, CPD40EZ, D200E, D200G, D200GC/OP, DI200E, DI200G, D350E, D350G, D350V, TT350, TT350, TT350, TT600E, TT600G, TT600V, D650E, D650G, D650V, D1000V, T353019, T3650, T3650, T3650, T1000, T3530, T3530, T1000... (Other models you can see in the webshop) | | |
| spare parts for | 101165 | | |
|  | GEV No. | 358696 | Ref. No. — |
| | fine fuse size ø5x20mm 4A medium lag rated 250V Qty 10 pcs | | |





1

| | | | |
|--------------------|--|-----------------|--------------------------------------|
| GEV No. | 101166 | Ref. No. | OK0326 OK0327 OKC667 101166 |
| description | ignition box HONEYWELL type S4560B 1006 electrodes 1 waiting time 0s safety time 10s 220-240V 10VA 50Hz | | |
| For models: | 45-100-122, 45-100-123, 45-100-125, 45-100-132, 45-100-133, 45-100-135, 7573-2, 7574-2, 7575-2, 7576-2, 7773-2, 7774-2, 7775-2, 7776-2, 9100-2, 9101-2, 9102-2, 9104-2, 9113-2, 9114-2, 9115-2, 9116-2 | | |

2 gas components



| | | | |
|---|--|-----------------|----------------------------|
|  | | | |
| 1 | | | |
| GEV No. | 102347 | Ref. No. | 002641 OK1525 102347 |
| description | ignition box HONEYWELL type S4560M 1010 electrodes 1 waiting time 10s safety time 5s 220-240V 10VA 50Hz | | |
| For models: | FDV40G, FDV40GZ, FDV40GA, FDV20G, FDV20GZ, FDV20GA, FCV/G10L3, FCVG10L3T, FCVG102L3, FCV/G20L3, FCVG202L3, FCVG10L3J, FCVG102L3J, FCV/G10L6JAP, FCV/G102/1L6JAP, FCV/G10L2, FCV/G10L6, FCV/G102/1L6, FCV/G20L6, FCVG202L6, FCV/G101/1, FCV/G102/1, FCS101G2, FCS101G4, FCS101G4DT, FCS101GP9J, FCS-101G49J, FCS101GP, FCS102G4, FCS102GA9J, FCS102G49J, FCS102GP, 5712-2-6, 5712-2-7, 5712-2-8, 5712-2-10, 5714-2-6, 5714-2-7, 5714-2-8, 5714-2-10, 5717-2-6, 5714-2-7, 5714-2-8, 5714-2-10, 5712-2-6L, 5712-2-7L, 5712-2-8L, 5712-2-10L, 5714-2-6L, 5714-2-7L...(Other models you can see in the webshop) | | |

| | | | |
|--|---|-----------------|------------------|
|  | | | |
| 2 | | | |
| GEV No. | 101184 | Ref. No. | 005924 101184 |
| description | ignition box HONEYWELL type S4565C 1033 equiv. no. S4565C 1033 electrodes 2 waiting times safety time 5s 220-240V 4VA 50/60Hz | | |
| For models: | FCV/G20L3, FCVG202L3, FCVG6L3CJ, FCV/G6L3C, FCV/G61/1, FCV/G61/1, FCV/G61/1, FCV/G61/1, FCVG6L3CT, FCVG6L3CJ, FCV/G20L6, FCVG202L6, FCV/G201/1, FCV/G202/1, FCS061G48J, FCS061GP, FCS061G3DI, FCS061G4, FCS061G4DT, FCS061G49J, FCS101G4, FCS101G4DT, FCS101G49J, FCS102G4, FCS102G49J, FCS201G4, FCS201GP, FCS202G4, FCS202GP, FCS101GX9J, FCS101GX, FCS-102GX9J, FCS102GX, FCS201GX, FCS202GX, 5721-2-7, 5721-2-10, ECV/G20T4, ECVG202T4, ECV/G6T4C, ECV/G61/1, ECV/G20T4J, ECV/G61/1, ECV/G20T6, ECVG202T6, RCV061G2, ACV/G6C3C, ACV/G20C4, ACVG202C4, ACVG202C6...(Other models you can see in the webshop) | | |

| | | | |
|--|--|-----------------|--------------------|
|  | | | |
| 1 | | | |
| GEV No. | 101685 | Ref. No. | 005898 91310280 |
| description | ignition box SIT type 503EFD electrodes 2 waiting time 1.5s safety time 10s 220/240V 7VA 50-60Hz protection IP40 | | |
| For models: | ZCBDG8, ZCBDG12, ZCBDG18 | | |

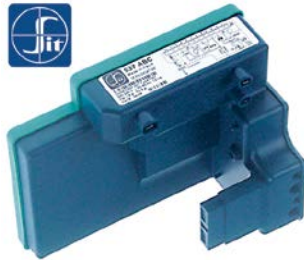
| | | | |
|--|---|-----------------|-------------------|
|  | | | |
| 1 | | | |
| GEV No. | 101990 | Ref. No. | 005908 0537307 |
| description | ignition box SIT type 537ABC electrodes 3 waiting time 1.5s safety time 5s 230V 10VA 50-60Hz protection IP40 | | |
| For models: | FCVG6L3CJ, FCV/G6L3C, FCV/G61/1, FCV/G61/1, FCV/G61/1, FCV/G61/1, FCVG6L3CT, FCVG6L3CJ, 5721-2-7, 5721-2-10, ECV/G6T4C, ECV/G61/1, ECV/G61/1, RCV061G2, ACV/G6C3C, ZCV/G6T4C, ZCV/G61/1 | | |

| | | | |
|--|--|-----------------|-----------------------------|
|  | | | |
| 1 | | | |
| GEV No. | 102346 | Ref. No. | 0577307 0C1059 0C1878 |
| description | ignition box SIT type 577DBC electrodes 2 waiting time 1.5s safety time 6s 220/240V 20VA 50/60Hz protection IP40 | | |
| For models: | AOS061GAEU, AOS101GAEU, AOS102GAEU, AOS201GAEU, AOS-202GAEU, AOS061GAAU, AOS101GAAU, AOS102GAAU, AOS201GAAU, AOS202GAAU, AOS061GA, AOS061GB, AOS101GA, AOS101GB, AOS-201GA, AOS201GB, AOS102GB, AOS102GA, AOS202GB, AOS202GA | | |



1

| | | | |
|--------------------|---|-----------------|--------|
| GEV No. | 102589 | Ref. No. | 0C4260 |
| description | ignition box SIT type 579DBC electrodes 1 waiting time 1.5s safety time 3.5s 220/240V 12VA 50/60Hz | | |
| For models: | FCZ102EAA, FCZ061GAG, FCZ101GAG, FCZ102GAG, FCZ201GAG, FCZ202GAG, FCZ061GAD, FCZ101GAD, FCZ102GAD, FCZ201GAD, FCZ202GAD, FCZ101GTG, FCZ102GTG, FCZ201GTG, FCZ202GTG, FCZ101GTD, FCZ102GTD, FCZ201GTD, FCZ202GTD, FCZ102EBA, FCZ061GBG, FCZ101GBG, FCZ102GBG, FCZ201GBG, FCZ202GBG, FCZ061GBD, FCZ101GBD, FCZ102GBD, FCZ201GBD, FCZ202GBD, FCZ061GBI, FCZ101GBI, FCZ201GBI, FCZ101GBG2, FCZ102GBG2, FCZ201GBG2, FCZ202GBG2, FCZ101GBD2, FCZ102GBD2, FCZ201GBD2, FCZ202GBD2, FCZ101GBI2, FCZ102GBI2, FCZ201GBI2, FCZ102ECA, FCZ061GCG, FCZ101GCG, FCZ102GCG, FCZ201GCG, FCZ202GCG...(Other models you can see in the webshop) | | |



1

| | | | |
|--------------------|--|-----------------|--------|
| GEV No. | 107224 | Ref. No. | 0C8189 |
| description | ignition box SIT type 579DBC electrodes 2 waiting time 1.5s safety time 6s 220/240V 12VA 50/60Hz | | |

safety valves

SIT

440 series



1

| | | | |
|---|--|-----------------|---|
| GEV No. | 101100 | Ref. No. | 0440013 050106 |
| description | gas valve pressure range 50mbar gas inlet 1/2" gas outlet 1/2" pilot connection M10x1 (tube ø 6mm) thermocouple connection M9x1 type 0.440.013 | | |
| For models: | FP/G1-ZO | | |
| accessories for | 101100 | | |
|  | GEV No. | 100904 | Ref. No. 052833 0K2497 100904 102504 |
| locking screw M10x1 for pipe ø 4mm Qty 1 pcs | | | |

| | | | |
|---|----------------|--------|--------------------------------------|
| accessories for | 101100 | | |
|  | GEV No. | 100905 | Ref. No. 052834 0958031 |
| locking screw M10x1 for pipe ø 6mm Qty 1 pcs | | | |

ignition parts

pilot burners

SIT

100 series



1













| | | | |
|---|--|-----------------|--|
| GEV No. | 106902 | Ref. No. | 029776 02R31 02V37 0G0096 0K5732 0M0903 0M0904 |
| description | pilot burner SIT type 100 series 2 flames nozzle ø 0.2mm gas connection 6mm | | |
| For models: | CG148-001.A1AB, CG148-003.A2AB, CG248-201.A1ABBB, CG248-203.A1ABBB, CK248-209.D1ABBB, CK248-211.D1ABBB, LG159-703.A1BC, LG159-703.A2BC, LG159-704.A1BC, LG159-706.A1BC, LG259-711.A1ACC, LG259-712.A1ACC, LK259-707.D1ACC, LK259-708.D1ACC, LG259-739.A1ACCB, LG259-740.A1ACCB, CK248-205.D1ABBB, CK248-207.D1ABBB, LK159-707.D1BC, LK159-708.D1BC, LK259-727.D1ACC, LK259-728.D1ACC, LG159-704.A2BC, LK159-707.D2BC, LK159-708.D2BC, LG259-711.A2ACC, LG259-712.A2ACC, LK259-727.D2ACC, LK259-728.D2ACC, LK259-707.D2ACC, LK259-708.D2ACC, CK248-205.D2ABBB, CK248-207.D2ABBB, CK248-209.D2ABBB, CK248-211.D2ABBB, CG148-004.A1AB, CG148-005.A1AB, CG148-006.A1AB, CG248-240.A1ABBB, CG248-243.A1ABBB, CG248-244.A1ABBB, CG248-212.A1ABBB, CG248-213.A1ABBB, LG159-705.A1BC, LG159-753.A1BC, LG259-758.A1ACCB, LG259-754.A1ACCB, LG259-757.A1ACCB, CG148-001.A3AB, CG148-003.A2AB...(Other models you can see in the webshop) | | |
| spare parts for | 106902 | | |
|  | GEV No. | 100245 | Ref. No. 003633 006188 056799 0977030 0G0082 0G2785 0G2786 0G5006 0K2946 0KD857 |
| pilot burner nozzle LPG code 20 bore ø 0.2mm Qty 1 pcs thread M8x0.75 | | | |
|  | GEV No. | 100842 | Ref. No. — |
| pilot burner cap 2 flames Qty 1 pcs | | | |
|  | GEV No. | 100885 | Ref. No. 057251 |
| air mixing sleeve for pilot burner Qty 1 pcs | | | |
|  | GEV No. | 100916 | Ref. No. — |
| compression spring for pilot burner Qty 1 pcs | | | |
|  | GEV No. | 100917 | Ref. No. — |
| gasket for pilot burner Qty 1 pcs aluminium ID ø 8.5mm ED ø 11mm thickness 1.2mm | | | |

Table continues overleaf

2 gas components



| | | | | |
|---|---------|--------|----------|--|
| spare parts for 106902 | | | | |
|  | GEV No. | 100918 | Ref. No. | — |
| screw for pilot burner | | | | |
|  | GEV No. | 107161 | Ref. No. | — |
| pilot burner cap SIT 2 flames Hmm Lmm Qty 1 pcs | | | | |
|  | GEV No. | 107701 | Ref. No. | — |
| pilot burner bottom part SIT 100 series nozzle ø 0.2mm | | | | |
| accessories for 106902 | | | | |
|  | GEV No. | 100246 | Ref. No. | 02137 056656 056797 0977031 0G0150 0G2787 0K1318 0K2895 0K3558 0K5866 0KW952 0M0833 |
| pilot burner nozzle natural gas bore ø 0.35mm Qty 1 pcs thread M8x0.75 | | | | |
|  | GEV No. | 100904 | Ref. No. | 052833 0K2497 100904 102504 |
| locking screw M10x1 for pipe ø 4mm Qty 1 pcs | | | | |
|  | GEV No. | 100905 | Ref. No. | 052834 0958031 |
| locking screw M10x1 for pipe ø 6mm Qty 1 pcs | | | | |
|  | GEV No. | 102110 | Ref. No. | 006249 054810 0C0152 0C0153 0C0626 0C1547 |
| pilot tube copper pipe ø 4mm thickness 1mm L 3000mm | | | | |
|  | GEV No. | 102111 | Ref. No. | — |
| pilot tube copper pipe ø 6mm thickness 1mm L 3000mm | | | | |
|  | GEV No. | 107171 | Ref. No. | 058330 058753 0977051 0G2234 |
| pilot burner nozzle SIT natural/liquid gas bore ø 0.25mm Qty 1 pcs | | | | |
|  | GEV No. | 107700 | Ref. No. | 052281 |
| pilot burner bottom part SIT 100 series nozzle ø 0.25mm | | | | |
|  | GEV No. | 107702 | Ref. No. | 052686 0901404 11061232 |
| pilot burner bottom part SIT 100 series nozzle ø 0.35mm | | | | |











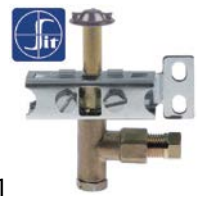







| | | | | |
|---|---|-----------------|---|---|
|  | | | | |
| 1 | | | | |
| GEV No. | 106906 | Ref. No. | 00119 004962 005783 026823 02R32 02V38 054335 0H6331 0K3507 0KQ947 0M0905 | |
| description | pilot burner SIT type 100 series 3 flames nozzle ø 0.2mm gas connection 6mm | | | |
| For models: | BR80GZ, SCPG350, SCPG350, SGG350, SGG700, HCPA/G1219, HCPA/GI1219, BR180GZ, BR100GZ, BR100G, BR80G, BR180G, NC4/FV, NC6/FVL, NC6/FV, NC6/2FV, NC8/2FV, NCG1V, NCG2V, NFG/20, NFG20+20, NFT/2GL, NFT/2GR, NFT/2GLC, 1TPG18F, 110FTL/N, 1104F/G, 1106F/2G, 1102FTL/N, 110FTR/N, 1102FTR/N, 1108F/2G, 110CP1, 110FR2, NC4/FV, NC6/FV, NC6/2FV, NC8/2FV, NC6/FVL, NFT/2GL, NFT/4GL, NFT/2GR, NFT/4GR, NFT/4GLR, NFT/4GLRC, NFT/2GLC, NFT/4GLC, NCG1V, NCG2V, NFG/20...(Other models you can see in the webshop) | | | |
| spare parts for 106906 | | | | |
|  | GEV No. | 100245 | Ref. No. | 003633 006188 056799 0977030 0G0082 0G2785 0G2786 0G5006 0K2946 0KD857 |
| pilot burner nozzle LPG code 20 bore ø 0.2mm Qty 1 pcs thread M8x0.75 | | | | |
|  | GEV No. | 100855 | Ref. No. | 00411 005618 |
| pilot burner bracket triple | | | | |
|  | GEV No. | 100885 | Ref. No. | 057251 |
| air mixing sleeve for pilot burner Qty 1 pcs | | | | |
|  | GEV No. | 100916 | Ref. No. | — |
| compression spring for pilot burner Qty 1 pcs | | | | |
|  | GEV No. | 100917 | Ref. No. | — |
| gasket for pilot burner Qty 1 pcs aluminium ID ø 8.5mm ED ø 11mm thickness 1.2mm | | | | |
|  | GEV No. | 100918 | Ref. No. | — |
| screw for pilot burner | | | | |
|  | GEV No. | 107162 | Ref. No. | — |
| pilot burner cap SIT 3 flames Hmm Lmm Qty 1 pcs | | | | |
|  | GEV No. | 107701 | Ref. No. | — |
| pilot burner bottom part SIT 100 series nozzle ø 0.2mm | | | | |

Table continues overleaf



| | | | | |
|---|---------|--------|----------|--|
| accessories for 106906 | | | | |
|  | GEV No. | 100245 | Ref. No. | 003633 006188 056799 0977030 0G0082 0G2785 0G2786 0G5006 0K2946 0KD857 |
| pilot burner nozzle LPG code 20 bore ø 0.2mm Qty 1 pcs thread M8x0.75 | | | | |
|  | GEV No. | 100246 | Ref. No. | 02137 056656 056797 0977031 0G0150 0G2787 0K1318 0K2895 0K3558 0K5866 0KW952 0M0833 |
| pilot burner nozzle natural gas bore ø 0.35mm Qty 1 pcs thread M8x0.75 | | | | |
|  | GEV No. | 100904 | Ref. No. | 052833 0K2497 100904 102504 |
| locking screw M10x1 for pipe ø 4mm Qty 1 pcs | | | | |
|  | GEV No. | 100905 | Ref. No. | 052834 0958031 |
| locking screw M10x1 for pipe ø 6mm Qty 1 pcs | | | | |
|  | GEV No. | 102110 | Ref. No. | 006249 054810 0C0152 0C0153 0C0626 0C1547 |
| pilot tube copper pipe ø 4mm thickness 1mm L 3000mm | | | | |
|  | GEV No. | 102111 | Ref. No. | — |
| pilot tube copper pipe ø 6mm thickness 1mm L 3000mm | | | | |
|  | GEV No. | 107171 | Ref. No. | 058330 058753 0977051 0G2234 |
| pilot burner nozzle SIT natural/liquid gas bore ø 0.25mm Qty 1 pcs | | | | |
|  | GEV No. | 107700 | Ref. No. | 052281 |
| pilot burner bottom part SIT 100 series nozzle ø 0.25mm | | | | |
|  | GEV No. | 107702 | Ref. No. | 052686 0901404 11061232 |
| pilot burner bottom part SIT 100 series nozzle ø 0.35mm | | | | |

















| | | | | |
|---|---|-----------------|-------------------|--|
|  | | | | |
| 1 | | | | |
| GEV No. | 106908 | Ref. No. | 0190089 051624 | |
| description | pilot burner SIT type 100 series 3 flames nozzle ø 0.2mm gas connection 6mm | | | |
| spare parts for 106908 | | | | |
|  | GEV No. | 100246 | Ref. No. | 02137 056656 056797 0977031 0G0150 0G2787 0K1318 0K2895 0K3558 0K5866 0KW952 0M0833 |
| pilot burner nozzle natural gas bore ø 0.35mm Qty 1 pcs thread M8x0.75 | | | | |
|  | GEV No. | 100854 | Ref. No. | 052246 052256 0978009 0978021 0G2925 0G2926 |
| pilot burner bracket double | | | | |
|  | GEV No. | 100885 | Ref. No. | 057251 |
| air mixing sleeve for pilot burner Qty 1 pcs | | | | |
|  | GEV No. | 100916 | Ref. No. | — |
| compression spring for pilot burner Qty 1 pcs | | | | |
|  | GEV No. | 100917 | Ref. No. | — |
| gasket for pilot burner Qty 1 pcs aluminium ID ø 8.5mm ED ø 11mm thickness 1.2mm | | | | |
|  | GEV No. | 100918 | Ref. No. | — |
| screw for pilot burner | | | | |
|  | GEV No. | 107162 | Ref. No. | — |
| pilot burner cap SIT 3 flames Hmm Lmm Qty 1 pcs | | | | |
|  | GEV No. | 107702 | Ref. No. | 052686 0901404 11061232 |
| pilot burner bottom part SIT 100 series nozzle ø 0.35mm | | | | |
| accessories for 106908 | | | | |
|  | GEV No. | 100245 | Ref. No. | 003633 006188 056799 0977030 0G0082 0G2785 0G2786 0G5006 0K2946 0KD857 |
| pilot burner nozzle LPG code 20 bore ø 0.2mm Qty 1 pcs thread M8x0.75 | | | | |
|  | GEV No. | 100904 | Ref. No. | 052833 0K2497 100904 102504 |
| locking screw M10x1 for pipe ø 4mm Qty 1 pcs | | | | |

Table continues overleaf







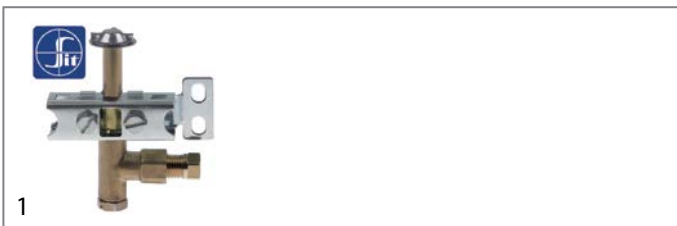



| accessories for | | 106908 | | |
|---|---------|--------|----------|---------------------------------------|
|  | GEV No. | 100905 | Ref. No. | 052834 0958031 |
| locking screw M10x1 for pipe ø 6mm Qty 1 pcs | | | | |
|  | GEV No. | 102111 | Ref. No. | — |
| pilot tube copper pipe ø 6mm thickness 1mm L 3000mm | | | | |
|  | GEV No. | 107171 | Ref. No. | 058330 058753 0977051 0G2234 |
| pilot burner nozzle SIT natural/liquid gas bore ø 0.25mm Qty 1 pcs | | | | |
|  | GEV No. | 107700 | Ref. No. | 052281 |
| pilot burner bottom part SIT 100 series nozzle ø 0.25mm | | | | |
|  | GEV No. | 107701 | Ref. No. | — |
| pilot burner bottom part SIT 100 series nozzle ø 0.2mm | | | | |











| GEV No. | 106907 | Ref. No. | 002572 0190083 0190085 02V35 050812 050813 051141 051976 057737 058329 058715 0C0494 0G0100 0G0302 0K2942 0K5618 0K5698 0K5737 0K7809 0KE453 0M0902 |
|---------|--------|----------|---|
|---------|--------|----------|---|











| description | pilot burner SIT type 100 series 3 flames nozzle ø 0.35mm gas connection 6mm | | |
|-------------|--|--|--|
| For models: | MCF/G705, MCF/G1055, MCF/G700, MCF/G1050, MCF/G705E, MCF/G1055E, MCF/G700, MCF/G705F, MCF/G1055F, MCF/G702, MCF/G1052, MCF/G700, MCF/G1050, MR/G351, MR/G701, MR/G721, MR/G1071, MR/G350, MR/G360, MR/G700, MR/G700NL, MR/G710, MR/G1070, MR/G720, MR/G715, MR/G725, MR/G1075, MR/G361, MR/G711, MR/G716, MR/G726, MR/G1076, MFR/G360, MPN/GD761, MPN/GI761, MPN/GI760D, MPN/GD760, MPN/GD760F, MPN/GI760, MPN/GI760F, MT/G700D, MTF/G700D, MTF/G1050D, MT/G700, MTF/G700, MTF/G1050, MTF/GE1050, MT/G700F, MTF/G700F, MTF/G1055F... (Other models you can see in the webshop) | | |

| spare parts for | | 106907 | | |
|---|---------|--------|----------|--|
|  | GEV No. | 100246 | Ref. No. | 02137 056656 056797 0977031 0G0150 0G2787 0K1318 0K2895 0K3558 0K5866 0KW952 0M0833 |
| pilot burner nozzle natural gas bore ø 0.35mm Qty 1 pcs thread M8x0.75 | | | | |

| spare parts for | | 106907 | | |
|---|---------|--------|----------|-------------------------------|
|  | GEV No. | 100855 | Ref. No. | 00411 005618 |
| pilot burner bracket triple | | | | |
|  | GEV No. | 100885 | Ref. No. | 057251 |
| air mixing sleeve for pilot burner Qty 1 pcs | | | | |
|  | GEV No. | 100916 | Ref. No. | — |
| compression spring for pilot burner Qty 1 pcs | | | | |
|  | GEV No. | 100917 | Ref. No. | — |
| gasket for pilot burner Qty 1 pcs aluminium ID ø 8.5mm ED ø 11mm thickness 1.2mm | | | | |
|  | GEV No. | 100918 | Ref. No. | — |
| screw for pilot burner | | | | |
|  | GEV No. | 107162 | Ref. No. | — |
| pilot burner cap SIT 3 flames Hmm Lmm Qty 1 pcs | | | | |
|  | GEV No. | 107702 | Ref. No. | 052686 0901404 11061232 |
| pilot burner bottom part SIT 100 series nozzle ø 0.35mm | | | | |

| accessories for | | 106907 | | |
|---|---------|--------|----------|---|
|  | GEV No. | 100245 | Ref. No. | 003633 006188 056799 0977030 0G0082 0G2785 0G2786 0G5006 0K2946 0KD857 |
| pilot burner nozzle LPG code 20 bore ø 0.2mm Qty 1 pcs thread M8x0.75 | | | | |
|  | GEV No. | 100904 | Ref. No. | 052833 0K2497 100904 102504 |
| locking screw M10x1 for pipe ø 4mm Qty 1 pcs | | | | |
|  | GEV No. | 100905 | Ref. No. | 052834 0958031 |
| locking screw M10x1 for pipe ø 6mm Qty 1 pcs | | | | |
|  | GEV No. | 102110 | Ref. No. | 006249 054810 0C0152 0C0153 0C0626 0C1547 |
| pilot tube copper pipe ø 4mm thickness 1mm L 3000mm | | | | |
|  | GEV No. | 102111 | Ref. No. | — |
| pilot tube copper pipe ø 6mm thickness 1mm L 3000mm | | | | |
|  | GEV No. | 107171 | Ref. No. | 058330 058753 0977051 0G2234 |
| pilot burner nozzle SIT natural/liquid gas bore ø 0.25mm Qty 1 pcs | | | | |
|  | GEV No. | 107700 | Ref. No. | 052281 |
| pilot burner bottom part SIT 100 series nozzle ø 0.25mm | | | | |
|  | GEV No. | 107701 | Ref. No. | — |
| pilot burner bottom part SIT 100 series nozzle ø 0.2mm | | | | |



| accessories | | | |
|---|---|-----------------|--|
| pilot burner bottom parts | | | |
|  | | | |
| 1 | | | |
| GEV No. | 107700 | Ref. No. | 052281 |
| description | pilot burner bottom part SIT 100 series nozzle ø 0.25mm | | |
| For models: | RFR/G301, RFR/G300, RFR/G301, RFR/G701, RFR/G701F, HFR/G420, HFR/G420, HFR/G840, HFR/G840, HFR/G840, HFR/G421, HFR/G420, ZHFRG421, HFR/G840, RFR/G301, RFR/G701 | | |
| spare parts for | 107700 | | |
|  | GEV No. | 100916 | Ref. No. — |
| | compression spring for pilot burner Qty 1 pcs | | |
|  | GEV No. | 100917 | Ref. No. — |
| | gasket for pilot burner Qty 1 pcs aluminium ID ø 8.5mm ED ø 11mm thickness 1.2mm | | |
|  | GEV No. | 100918 | Ref. No. — |
| | screw for pilot burner | | |
|  | GEV No. | 102742 | Ref. No. — |
| | pilot burner nozzle LPG code 25 bore ø 0.25mm Qty 1 pcs | | |
| accessories for | 107700 | | |
|  | GEV No. | 100245 | Ref. No. |
| | | | 003633 006188 056799 0977030 0G0082 0G2785 0G2786 0G5006 0K2946 0KD857 |
| | pilot burner nozzle LPG code 20 bore ø 0.2mm Qty 1 pcs thread M8x0.75 | | |
|  | GEV No. | 100246 | Ref. No. |
| | | | 02137 056656 056797 0977031 0G0150 0G2787 0K1318 0K2895 0K3558 0K5866 0KW952 0M0833 |
| | pilot burner nozzle natural gas bore ø 0.35mm Qty 1 pcs thread M8x0.75 | | |
|  | GEV No. | 100904 | Ref. No. |
| | | | 052833 0K2497 100904 102504 |
| | locking screw M10x1 for pipe ø 4mm Qty 1 pcs | | |
|  | GEV No. | 100905 | Ref. No. |
| | | | 052834 0958031 |
| | locking screw M10x1 for pipe ø 6mm Qty 1 pcs | | |
|  | GEV No. | 102110 | Ref. No. |
| | | | 006249 054810 0C0152 0C0153 0C0626 0C1547 |
| | pilot tube copper pipe ø 4mm thickness 1mm L 3000mm | | |

| accessories for 107700 | | | |
|---|--------|----------|---|
| GEV No. | 102111 | Ref. No. | — |
|  | | | |
| pilot tube copper pipe ø 6mm thickness 1mm L 3000mm | | | |

















| | | | |
|---|---|-----------------|--|
|  | | | |
| 1 | | | |
| GEV No. | 107702 | Ref. No. | 052686 0901404 11061232 |
| description | pilot burner bottom part SIT 100 series nozzle ø 0.35mm | | |
| For models: | MR/G700NL, MFR/G350, MFR/G700, MFR/G350D, MFR/G700D, MFR/G350F, MFR/G700F, MFR/G350E, MFR/G700E, MFR/G350NL, MFR/G700NL, MFR/G740, MFR/G380, MFR/G381, MFR/G350, MFR/G351, MFR/G700, MFR/G701, RF/G1S07, RF/G2D07, RFR/G1S07, RFR/G2D07, RFR/G1S12, RFR/G2D12, RFR/G2S40, RFR/G1S14, RFR/G2D14, RF/G1S07, RF/G2D07, RFR/G1S07, RFR/G2D07, XF/G1S07, XRF/G2D07, XFR/G1S07, XFR/G2D07, XFR/G1S12, XFR/G2D12, XFR/G2S40, XFR/G1S14, XFR/G2D14, XF/G1S07, XF/G2D07, XFR/G1S07, XFR/G2D07, JF/G1S07, JF/G2D07, JFR/G1S07, JFR/G2D07, JFR/G1S12, JFR/G2D12... (Other models you can see in the webshop) | | |
| spare parts for | 107702 | | |
|  | GEV No. | 100246 | Ref. No. |
| | | | 02137 056656 056797 0977031 0G0150 0G2787 0K1318 0K2895 0K3558 0K5866 0KW952 0M0833 |
| | pilot burner nozzle natural gas bore ø 0.35mm Qty 1 pcs thread M8x0.75 | | |
|  | GEV No. | 100916 | Ref. No. — |
| | compression spring for pilot burner Qty 1 pcs | | |
|  | GEV No. | 100917 | Ref. No. — |
| | gasket for pilot burner Qty 1 pcs aluminium ID ø 8.5mm ED ø 11mm thickness 1.2mm | | |
|  | GEV No. | 100918 | Ref. No. — |
| | screw for pilot burner | | |
| accessories for | 107702 | | |
|  | GEV No. | 100245 | Ref. No. |
| | | | 003633 006188 056799 0977030 0G0082 0G2785 0G2786 0G5006 0K2946 0KD857 |
| | pilot burner nozzle LPG code 20 bore ø 0.2mm Qty 1 pcs thread M8x0.75 | | |
|  | GEV No. | 100904 | Ref. No. |
| | | | 052833 0K2497 100904 102504 |
| | locking screw M10x1 for pipe ø 4mm Qty 1 pcs | | |
|  | GEV No. | 100905 | Ref. No. |
| | | | 052834 0958031 |
| | locking screw M10x1 for pipe ø 6mm Qty 1 pcs | | |

Table continues overleaf

2 gas components

| | | | | | |
|---|---|----------|--|----------|--|
| accessories for 107702 | | | | | |
|  | <table border="1"> <tr> <td>GEV No.</td> <td>102110</td> <td>Ref. No.</td> <td>006249 054810 0C0152 0C0153 0C0626 0C1547</td> </tr> </table> <p>pilot tube copper pipe ø 4mm thickness 1mm L 3000mm</p> | GEV No. | 102110 | Ref. No. | 006249 054810 0C0152 0C0153 0C0626 0C1547 |
| GEV No. | 102110 | Ref. No. | 006249 054810 0C0152 0C0153 0C0626 0C1547 | | |
|  | <table border="1"> <tr> <td>GEV No.</td> <td>102111</td> <td>Ref. No.</td> <td>—</td> </tr> </table> <p>pilot tube copper pipe ø 6mm thickness 1mm L 3000mm</p> | GEV No. | 102111 | Ref. No. | — |
| GEV No. | 102111 | Ref. No. | — | | |
|  | <table border="1"> <tr> <td>GEV No.</td> <td>102742</td> <td>Ref. No.</td> <td>—</td> </tr> </table> <p>pilot burner nozzle LPG code 25 bore ø 0.25mm Qty 1 pcs</p> | GEV No. | 102742 | Ref. No. | — |
| GEV No. | 102742 | Ref. No. | — | | |

| | | | |
|---|---|-----------------|-----------------------------|
|  | | | |
| 1 | | | |
| GEV No. | 100880 | Ref. No. | 003614 006725 0901405 |
| description | pilot burner bottom part SIT 100 series nozzle ø 0.4mm | | |
| For models: | BF/G1S07, BFR/G1S14, PF/G1S07, PF/G2D07, PFR/G1S07, PFR/G2D07, PFR/G1S14, PFR/G2D14, PFR/G2S40, PFRG2D14HV, PFRG1S14HV, OF/G1S07, OFR/G1S07, OFR/G2D07, OFR/G1S14, OFR/G2D14, TF/G1S07, TF/G2D07, TFR/G1S07, TFR/G2D07, TFR/G1S14, TFR/G2D14, TFR/G2S40, KFR/G1A, KFR/G2B, KFR/G1E, KFR/G2F, KFH/G1, KFH/G1ELH, KFH/G1EH, KFR/G1T, FC1G, FC2G, HFH/G430, QFR/G1A, QFR/G2B, QFR/G1E, QFR/G2F, QFH/G1, QFH/G1ELH, QFH/G1EH, QFR/G1T, RF/G1680, RF/G2480, ZFH/G430, WFR/G1A, WFR/G2B, WFR/G1E, WFR/G2F, WFH/G1...(Other models you can see in the webshop) | | |

| | | | | | |
|---|--|-----------------|-----------------|----------|-----------------|
| pilot burner brackets | | | | | |
| universal | | | | | |
|  | | | | | |
| 1 | | | | | |
| GEV No. | 100855 | Ref. No. | 00411 005618 | | |
| description | pilot burner bracket triple | | | | |
| For models: | SFRG350, SFRG700, SCPG350, SFRG350, SFRG700, SRG350, SRG360, SRG700, SRG710, SMG350, SMG700, SCPG350 | | | | |
| accessories for 100855 | | | | | |
|  | <table border="1"> <tr> <td>GEV No.</td> <td>100855</td> <td>Ref. No.</td> <td>00411 005618</td> </tr> </table> <p>pilot burner bracket triple</p> | GEV No. | 100855 | Ref. No. | 00411 005618 |
| GEV No. | 100855 | Ref. No. | 00411 005618 | | |
|  | <table border="1"> <tr> <td>GEV No.</td> <td>100886</td> <td>Ref. No.</td> <td>—</td> </tr> </table> <p>pilot burner bracket suitable for 100 series 3-piece</p> | GEV No. | 100886 | Ref. No. | — |
| GEV No. | 100886 | Ref. No. | — | | |
|  | <table border="1"> <tr> <td>GEV No.</td> <td>100888</td> <td>Ref. No.</td> <td>—</td> </tr> </table> <p>screw bolt for pilot burner</p> | GEV No. | 100888 | Ref. No. | — |
| GEV No. | 100888 | Ref. No. | — | | |

| | | | |
|---|---|-----------------|--------|
| pilot burner nozzles | | | |
|  | | | |
| 1 | | | |
| GEV No. | 100247 | Ref. No. | 056750 |
| description | pilot burner nozzle LPG bore ø 0.2mm Qty 1 pcs suitable for SIT 100 series thread M8x0.75 | | |
| For models: | HCSG410, HCS/G410D, HCS/G400, PHCS/G400, HCS/G400F, HCF/G800F, PHCF/G800, HCS/G400NL, HCS/G400DK, HCSG810, HCS/G810D, HCS/G800, HCS/G800F, HCS/G800, HCS/G800NL, HCS/G800DK, HCFG810, HCF/G810D, HCF/GE81, HCF/GE81, HCF/G800, HCF/G800NL, HCF/G800DK, HCF/GE80, HCF/GE80, HCFG1210, HCF/G1210D, HCF/G1200, HCF/G1200F, PHCF/G1200, HCF/G1200N, HCF/G1200D, HCFG1610, HCF/G1610D, HCF/G1600, HCF/G1600F, PHCF/G1600, HCF/G1600N, HCF/G1600D, HC/G410, HC/G810, HTF/G1210, HTF/G1210, HTF/G1200, HTF/G1200, HCA/G410, HCA/G810, HCA/G810, HCF/G1210, ZHCF/G161...(Other models you can see in the webshop) | | |

| | | | |
|---|---|-----------------|---|
|  | | | |
| 1 | | | |
| GEV No. | 100245 | Ref. No. | 003633 006188 056799 0977030 0G0082 0G2785 0G2786 0G5006 0K2946 0KD857 |
| description | pilot burner nozzle LPG code 20 bore ø 0.2mm Qty 1 pcs thread M8x0.75 | | |
| For models: | MBR/G710D, MBR/G700, MBR/G700F, MBR/G700UK, MBR/G701, MBR/G706, MBR/G701UK, MBR/G751, MBR/G756, MFG1500Z, MFG2200Z, FG250D, FG250S, FGC/250D, FGC/250S, RBR/G710D, RBR/G700, RBR/G700F, 7BRG60, 7BRG60X, RBR/G701UK, RBR/G751, RBR/G756, XBR/G710D, XBR/G700, XBR/G710, XBR/G700F, XBR/G700UK, XBR/G701, M70GBP, XBR/G701UK, XBR/G751, XBR/G756, CBR/G700, RBR/G700, RBR/E700, RBR/G700, BR80GZ, PCG810, PCG1210, PCG1610, PCG810F, PCG1210F, PCG1610F, PCG810D, PCG1210D, PCG1610D, PCG800NL, PCG1200NL, PCG1600NL...(Other models you can see in the webshop) | | |

| | | | |
|---|---|-----------------|--|
|  | | | |
| 1 | | | |
| GEV No. | 100246 | Ref. No. | 02137 056656 056797 0977031 0G0150 0G2787 0K1318 0K2895 0K3558 0K5866 0KW952 0M0833 |
| description | pilot burner nozzle natural gas bore ø 0.35mm Qty 1 pcs thread M8x0.75 | | |
| For models: | MCF/G705, MCF/G1055, MCF/G700, MCF/G1050, MCF/G705E, MCF/G1055E, MCF/G700D, MCF/G700, MCF/G705F, MCF/G1055F, MCF/G705NL, MCF/G1050D, MCFG1055NL, MCF/G702, MCF/G1052, MCF/G700, MCF/G1050, MR/G351, MR/G701, MR/G721, MR/G1071, MR/G350, MR/G350F, MR/G350NL, MR/G350E, MR/G360, MR/G360F, MR/G700, MR/G700F, MR/G700NL, MR/G700E, MR/G710, MR/G710F, MR/G1070, MR/G720, MR/G715, MR/G725, MR/G1075, MR/G361, MR/G711, MR/G716, MR/G726, MR/G1076, MBR/G710D, MBR/G700, MBR/G700F, MBR/G700UK, MBR/G701, MBR/G706, MBR/G701UK...(Other models you can see in the webshop) | | |



| | | | |
|---|---|-----------------|------------------|
|  | | | |
| GEV No. | 102972 | Ref. No. | 003327 OK1319 |
| description | pilot burner nozzle natural gas code 40 bore \varnothing 0.4mm Qty 1 pcs | | |
| For models: | MFR/G740, MFR/G380, MFR/G381, BF/G1S07, BFR/G1S14, RF/G1S07, RF/G2D07, RFR/G1S07, RFR/G2D07, RFR/G2S40, RFR/G1S14, RFR/G2D14, RF/G1S07, RF/G2D07, RFR/G1S07, RFR/G2D07, XFR/G1S07, XFR/G2D07, XFR/G1S07, XFR/G2D07, XFR/G2S40, XFR/G1S14, XFR/G2D14, XFR/G1S07, XFR/G2D07, XFR/G1S07, XFR/G2D07, JF/G1S07, JF/G2D07, JFR/G1S07, JFR/G2D07, JFR/G2S40, JFR/G1S14, JFR/G2D14, JF/G1S07, JF/G2D07, JFR/G2D07, JFR/G2D07, MF/G1S07, MF/G2D07, MFR/G1S07, MFR/G2D07, MFR/G2S40, MFR/G1S14, MFR/G2D14, MF/G1S07, MF/G2D07, MFR/G1S07, MFR/G2D07, RFR/G741...(Other models you can see in the webshop) | | |

| | | | |
|---|---|-----------------|---|
|  | | | |
| GEV No. | 100707 | Ref. No. | 003272 054336 058385 0915037 0A2856 300903 |
| description | ignition electrode D1 \varnothing 7mm D2 \varnothing 9mm connection \varnothing 2.4mm L1 14mm L2 6mm BL1 18mm BL2 3mm BL3 23mm to clip Qty 1 pcs | | |
| For models: | HCPA/G1219, HCPA/G1219, HCPA/G121, HCPA/G121, NC4/FV, NC6/FVL, NC6/FV, NC6/2FV, NC8/2FV, NCG1V, NCG2V, NFG/20, NFG20+20, NFT/2GL, NFT/2GR, NFT/2GLC, 1TPG18F, 110FTL/N, 1104F/G, 1106F/2G, 1102FTL/N, 110FTR/N, 1102FTR/N, 1108F/2G, 110CP1, 110FR2, NC4/FV, NC6/FV, NC6/2FV, NC8/2FV, NC6/FVL, NFT/2GL, NFT/4GL, NFT/2GR, NFT/4GR, NFT/4GLR, NFT/4GLRC, NFT/2GLC, NFT/4GLC, NCG1V, NCG2V, NFG/20, NFG20+20, NTP/A, 090213, 090214, PCF/GG840, PCF/GG1260, PCF/GG1680, PTF/GG1835...(Other models you can see in the webshop) | | |

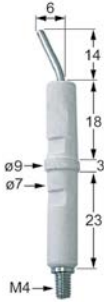





| | | | |
|--|--|-----------------|---|
| <p>ignition electrodes</p>  | | | |
| GEV No. | 100706 | Ref. No. | 02B06 02E10 051565 051977 056754 058135 0915036 0915055 0C0488 0G0083 0H6630 0K5703 0K9080 0KI377 0KQ943 0M0792 6010046 |
| description | ignition electrode connection M4 Qty 1 pcs | | |
| For models: | MCF/G705, MCF/G1055, MCF/G700, MCF/G1050, MCF/G705E, MCF/G1055E, MCF/G700D, MCF/G700, MCF/G705F, MCF/G1055F, MCF/G705NL, MCF/G1050D, MCF/G1055NL, MCF/G702, MCF/G1052, MCF/G700, MCF/G1050, MR/G351, MR/G701, MR/G721, MR/G1071, MR/G350, MR/G350F, MR/G350NL, MR/G350E, MR/G360, MR/G360F, MR/G700, MR/G700F, MR/G700NL, MR/G700E, MR/G710, MR/G710F, MR/G1070, MR/G720, MR/G715, MR/G725, MR/G1075, MR/G361, MR/G711, MR/G716, MR/G726, MR/G1076, MBR/G710D, MBR/G700, MBR/G700F, MBR/G700UK, MBR/G701, MBR/G706, MBR/G701UK...(Other models you can see in the webshop) | | |

| | | | |
|---|--|-----------------|--------|
| <p>miscellaneous</p>  | | | |
| GEV No. | 100885 | Ref. No. | 057251 |
| description | air mixing sleeve for pilot burner Qty 1 pcs | | |









gas components











140 - 145 -150 series







| | | | |
|---|---|-----------------|---|
|  | | | |
| GEV No. | 107114 ¹ | Ref. No. | 003527 003635 004124 004283 059379 0C3193 0G2266 0G2418 0H6312 21624 I07868 |
| description | pilot burner SIT type 140 series 2 flames nozzle ømm gas connecti-onmm | | |
| For models: | MT/G350, MT/G352, RCF/G9, RBR/G2FM, RBR/G2IM, RBK/G2FM, RR/G1FL, RR/G1FR, RR/G1CL, RR/G2FL, RR/G2FM, RR/G2CL, RRV/G1FL, RRV/G1FR, RRV/G1CL, RRV/G2FL, RRV/G2FM, RRV/G2CL, RR/G2CM, RTV/G2, RTF/G2, RSF/G2, RSV/G2, RSF/G3, RBV/G2, XCF/G9, XBR/G2FM, XBR/G2IM, XBK/G2FM, XR/G1FL, XR/G1FR, XR/G1CL, XR/G2FL, XR/G2FM, XR/G2CL, XRV/G1FL, XRV/G1FR, XRV/G1CL, XRV/G2FL, XRV/G2FM, XRV/G2CL, XR/G2CM, XTV/G2, XTF/G2, XSF/G2, XSV/G2, XSF/G3, XBV/G2, JBR/G2FM, JR/G1FL...(Other models you can see in the webshop) | | |
| spare parts for | 107114 | | |
|  | GEV No. | 100907 | Ref. No. 003609 0C0121 11061236 |
| | screw connection thread M10x1 Qty 1 pcs type SEF 1 ømm for thermocouple | | |
| accessories for | 107114 | | |
|  | GEV No. | 100204 | Ref. No. 003792 004127 059216 0977115 0C3214 0G2263 0G2415 0KT837 |
| | pilot burner nozzle SIT LPG code 14 bore ø 0.18/0.20mm Qty 1 pcs suitable for 140 series | | |
|  | GEV No. | 100205 | Ref. No. |
| | pilot burner nozzle SIT LPG code 19 bore ø 0.23/0.26mm Qty 1 pcs suitable for SIT 150 series | | |
|  | GEV No. | 100206 | Ref. No. 003626 |
| | pilot burner nozzle SIT natural gas code 36 bore ø 0.60/0.55mm Qty 1 pcs suitable for SIT 150 series | | |
|  | GEV No. | 100207 | Ref. No. 003784 003871 059215 0977113 0G2264 0G2416 |
| | pilot burner nozzle SIT natural gas code 27 bore ø 0.40/0.38mm suitable for SIT 140 series | | |
|  | GEV No. | 100216 | Ref. No. |
| | pilot burner nozzle SIT natural gas code 38 bore ø 0.45mm Qty 1 pcs suitable for SIT 150 series | | |

¹incl. thermocouple fitting

| | | | |
|---|--|--------|---|
| accessories for | 107114 | | |
|  | GEV No. | 100701 | Ref. No. 002564 004125 02B07 02E11 02I24 052610 056640 059380 059988 0915015 0915024 0A2473 0G2066 0G2265 0G2419 0H6628 0H6708 0H6802 0K4320 0KW911 0M0793 0M0823 1215009 |
| | ignition electrode connection M4 Qty 1 pcs | | |
|  | GEV No. | 100801 | Ref. No. |
| | gasket for pilot burner Qty 1 pcs | | |
|  | GEV No. | 100897 | Ref. No. 059161 0957009 0G2262 |
| | olive for pipe ø 4mm Qty 1 pcs for pilot burner | | |
|  | GEV No. | 100898 | Ref. No. 003863 |
| | olive for pipe ø 6mm Qty 1 pcs for pilot burner | | |
|  | GEV No. | 100906 | Ref. No. 003610 056641 057960 0974037 0G2227 0K5791 11061230 |
| | screw connection thread M10x1 for ignition electrode brass Qty 1 pcs WS 10 | | |
|  | GEV No. | 100908 | Ref. No. 046755 052125 0958013 0G2219 0K1348 0K5753 0KE882 0KL495 |
| | union screw thread M10x1 for pipe ø 4mm Qty 1 pcs | | |
|  | GEV No. | 100909 | Ref. No. 003859 057821 |
| | union screw thread M10x1 for pipe ø 6mm Qty 1 pcs | | |
|  | GEV No. | 102110 | Ref. No. 006249 054810 0C0152 0C0153 0C0626 0C1547 |
| | pilot tube copper pipe ø 4mm thickness 1mm L 3000mm | | |
|  | GEV No. | 102111 | Ref. No. |
| | pilot tube copper pipe ø 6mm thickness 1mm L 3000mm | | |



| 160 series | | | | |
|---|--|-----------------|------------------|--|
|  | | | | |
| GEV No. | 100056 | Ref. No. | 058146 058502 | |
| description | pilot burner SIT type 160 series 3 flames nozzle ømm gas connecti- onmm | | | |
| For models: | RF/G350D, RF/G700D, HCP/G800, HCP/G400 | | | |
| spare parts for | 100056 | | | |
|  | GEV No. | 100907 | Ref. No. | 003609 0C0121 11061236 |
| | screw connection thread M10x1 Qty 1 pcs type SEF 1 ømm for thermocouple | | | |
| accessories for | 100056 | | | |
|  | GEV No. | 100202 | Ref. No. | — |
| | pilot burner nozzle natural gas code 41 Qty 1 pcs nozzle ø 0.41mm | | | |
|  | GEV No. | 100203 | Ref. No. | — |
| | pilot burner nozzle LPG code 25 Qty 1 pcs nozzle ø 0.25mm | | | |
|  | GEV No. | 100701 | Ref. No. | 002564 004125 02B07 02E11 02I24 052610 056640 059380 059988 0915015 0915024 0A2473 0G2066 0G2265 0G2419 0H6628 0H6708 0H6802 0K4320 0KW911 0M0793 0M0823 1215009 |
| | ignition electrode connection M4 Qty 1 pcs | | | |
|  | GEV No. | 100801 | Ref. No. | — |
| | gasket for pilot burner Qty 1 pcs | | | |
|  | GEV No. | 100869 | Ref. No. | — |
| | pilot burner nozzle natural gas code 51 Qty 1 pcs suitable for 160 series nozzle ø 0.51mm | | | |
|  | GEV No. | 100870 | Ref. No. | 053665 0957014 0G2291 |
| | olive for pipe ø 4mm Qty 1 pcs suitable for 160 series for pilot burner | | | |
|  | GEV No. | 100906 | Ref. No. | 003610 056641 057960 0974037 0G2227 0K5791 11061230 |
| | screw connection thread M10x1 for ignition electrode brass Qty 1 pcs WS 10 | | | |

| accessories for 100056 | | | | |
|---|---|--------|-----------------|---|
|  | GEV No. | 100908 | Ref. No. | 046755 052125 0958013 0G2219 0K1348 0K5753 0KE882 0KL495 |
| | union screw thread M10x1 for pipe ø 4mm Qty 1 pcs | | | |
|  | GEV No. | 100909 | Ref. No. | 003859 057821 |
| | union screw thread M10x1 for pipe ø 6mm Qty 1 pcs | | | |
|  | GEV No. | 101287 | Ref. No. | — |
| | olive for pipe ø 6mm Qty 1 pcs | | | |
|  | GEV No. | 102110 | Ref. No. | 006249 054810 0C0152 0C0153 0C0626 0C1547 |
| | pilot tube copper pipe ø 4mm thickness 1mm L 3000mm | | | |
|  | GEV No. | 102111 | Ref. No. | — |
| | pilot tube copper pipe ø 6mm thickness 1mm L 3000mm | | | |
|  | GEV No. | 107650 | Ref. No. | 053667 057388 |
| | pilot burner nozzle SIT LPG code 30 Qty 1 pcs | | | |

| 1 | | | | |
|---|---|-----------------|------------------|------------------------------|
|  | | | | |
| GEV No. | 100105 | Ref. No. | 057411 0H6336 | |
| description | pilot burner SIT type 160 series 3 flames nozzle ømm gas connecti- onmm | | | |
| For models: | HBR/G820, HBR/G825, HBR/G821UK, ZBR/G821, ZBR/G826, ABR/G820, ABR/G825, FCFG6D, FCFG10, FCFG10D, FCFG10NL, FCFG6, FCFG6F, PCFG6, FCFG10J, FCFG10J, FCFG6J, FCFG6J, FCFG6J, FCFG6J, FCFG10J, FCFG10J, HBR/G803, HBR/G804, HBR/G803, HBR/G804, HBR/G803, HBR/G805, HBR/G1003, HBR/G1003, HBR/G1004, HBR/ G803, HBR/G804, HBR/G1013, FCF/G6, FCFG101, HBR/G803, HBR/ G804, HBR/G1003, HBR/G1013, FF/G6, FF/G10, COCO10G, COCO6G, COCVE423AF, HBR/G1004, ZOFCE/G10D, ZOFCE/G6D, 7502-2, 7504- 2...(Other models you can see in the webshop) | | | |
| spare parts for | 100105 | | | |
|  | GEV No. | 100907 | Ref. No. | 003609 0C0121 11061236 |
| | screw connection thread M10x1 Qty 1 pcs type SEF 1 ømm for thermocouple | | | |
| accessories for | 100105 | | | |
|  | GEV No. | 100202 | Ref. No. | — |
| | pilot burner nozzle natural gas code 41 Qty 1 pcs nozzle ø 0.41mm | | | |
|  | GEV No. | 100203 | Ref. No. | — |
| | pilot burner nozzle LPG code 25 Qty 1 pcs nozzle ø 0.25mm | | | |

Table continues overleaf



| accessories for | | 100105 | |
|-----------------|---|--------|--|
| | GEV No. | 100701 | Ref. No. |
| | | | 002564 004125 02B07 02E11 02I24 052610 056640 059380 059988 0915015 0915024 0A2473 0G2066 0G2265 0G2419 0H6628 0H6708 0H6802 0K4320 0KW911 0M0793 0M0823 1215009 |
| | ignition electrode connection M4 Qty 1 pcs | | |
| | GEV No. | 100801 | Ref. No. |
| | | | — |
| | gasket for pilot burner Qty 1 pcs | | |
| | GEV No. | 100869 | Ref. No. |
| | | | — |
| | pilot burner nozzle natural gas code 51 Qty 1 pcs suitable for 160 series nozzle ø 0.51mm | | |
| | GEV No. | 100906 | Ref. No. |
| | | | 003610 056641 057960 0974037 0G2227 0K5791 11061230 |
| | screw connection thread M10x1 for ignition electrode brass Qty 1 pcs WS 10 | | |
| | GEV No. | 100908 | Ref. No. |
| | | | 046755 052125 0958013 0G2219 0K1348 0K5753 0KE882 0KL495 |
| | union screw thread M10x1 for pipe ø 4mm Qty 1 pcs | | |
| | GEV No. | 100909 | Ref. No. |
| | | | 003859 057821 |
| | union screw thread M10x1 for pipe ø 6mm Qty 1 pcs | | |
| | GEV No. | 101282 | Ref. No. |
| | | | — |
| | olive for pipe ø 4mm L 7.4mm Qty 1 pcs | | |
| | GEV No. | 101287 | Ref. No. |
| | | | — |
| | olive for pipe ø 6mm Qty 1 pcs | | |
| | GEV No. | 102110 | Ref. No. |
| | | | 006249 054810 0C0152 0C0153 0C0626 0C1547 |
| | pilot tube copper pipe ø 4mm thickness 1mm L 3000mm | | |
| | GEV No. | 102111 | Ref. No. |
| | | | — |
| | pilot tube copper pipe ø 6mm thickness 1mm L 3000mm | | |
| | GEV No. | 107650 | Ref. No. |
| | | | 053667 057388 |
| | pilot burner nozzle SIT LPG code 30 Qty 1 pcs | | |

| 190 series | | | |
|--|--|----------|--|
| | 1 | | |
| GEV No. | 100110 | Ref. No. | 002783 0190603 |
| description pilot burner SIT type 190 series 3 flames nozzle ømm gas connectionmm | | | |
| For models: HBR/G800, HBR/G805, HBR/G810, HBR/G815, HBR/G811, HBR/G816, HBR/G800UK, ZBR/G800, ZBR/G805, ZBR/G810, ZBR/G815, ZBR/G811, ZBR/G816, ZBR/G800UK, ABR/G800, ABR/G805, ABR/G810, ABR/G815, ABR/G811, ABR/G816, OBR/G800UK | | | |
| accessories for | | 100110 | |
| | GEV No. | 100202 | Ref. No. |
| | | | — |
| | pilot burner nozzle natural gas code 41 Qty 1 pcs nozzle ø 0.41mm | | |
| | GEV No. | 100203 | Ref. No. |
| | | | — |
| | pilot burner nozzle LPG code 25 Qty 1 pcs nozzle ø 0.25mm | | |
| | GEV No. | 100701 | Ref. No. |
| | | | 002564 004125 02B07 02E11 02I24 052610 056640 059380 059988 0915015 0915024 0A2473 0G2066 0G2265 0G2419 0H6628 0H6708 0H6802 0K4320 0KW911 0M0793 0M0823 1215009 |
| | ignition electrode connection M4 Qty 1 pcs | | |
| | GEV No. | 100906 | Ref. No. |
| | | | 003610 056641 057960 0974037 0G2227 0K5791 11061230 |
| | screw connection thread M10x1 for ignition electrode brass Qty 1 pcs WS 10 | | |
| | GEV No. | 100908 | Ref. No. |
| | | | 046755 052125 0958013 0G2219 0K1348 0K5753 0KE882 0KL495 |
| | union screw thread M10x1 for pipe ø 4mm Qty 1 pcs | | |
| | GEV No. | 100909 | Ref. No. |
| | | | 003859 057821 |
| | union screw thread M10x1 for pipe ø 6mm Qty 1 pcs | | |
| | GEV No. | 100907 | Ref. No. |
| | | | 003609 0C0121 11061236 |
| | screw connection thread M10x1 for ignition electrode brass Qty 1 pcs WS 10 | | |
| | GEV No. | 100907 | Ref. No. |
| | | | 003609 0C0121 11061236 |
| | screw connection thread M10x1 Qty 1 pcs type SEF 1 ømm for thermocouple | | |
| | GEV No. | 100908 | Ref. No. |
| | | | 046755 052125 0958013 0G2219 0K1348 0K5753 0KE882 0KL495 |
| | union screw thread M10x1 for pipe ø 4mm Qty 1 pcs | | |
| | GEV No. | 100909 | Ref. No. |
| | | | 003859 057821 |
| | union screw thread M10x1 for pipe ø 6mm Qty 1 pcs | | |

Table continues overleaf



| accessories for | | 100110 | |
|---|---------|--------|---|
| | GEV No. | 101282 | Ref. No. — |
| olive for pipe ø 4mm L 7.4mm Qty 1 pcs | | | |
| | GEV No. | 101287 | Ref. No. — |
| olive for pipe ø 6mm Qty 1 pcs | | | |
| | GEV No. | 102110 | Ref. No. 006249 054810 0C0152 0C0153 0C0626 0C1547 |
| pilot tube copper pipe ø 4mm thickness 1mm L 3000mm | | | |
| | GEV No. | 102111 | Ref. No. — |
| pilot tube copper pipe ø 6mm thickness 1mm L 3000mm | | | |
| | GEV No. | 107650 | Ref. No. 053667 057388 |
| pilot burner nozzle SIT LPG code 30 Qty 1 pcs | | | |

JUNKERS

CB 502 series

pilot burners

| | | | |
|--|--|-----------------|---------------------------|
| | | | |
| 1 | | | |
| GEV No. | 100085 | Ref. No. | 0K1206 100085 |
| description | pilot burner JUNKERS type CB502031 natural gas nozzle no.6 gas connection 6mm with primary air | | |
| spare parts for | 100085 | | |
| | GEV No. | 100227 | Ref. No. — |
| pilot burner nozzle natural gas gas pressure 25mbar code 6 Qty 1 pcs suitable for JUNKERS CB50203_ | | | |
| | GEV No. | 100704 | Ref. No. — |
| ignition electrode D1 ø 9mm connection M4 D2 ø 11mm L1 17mm L2 17mm BL1 13mm BL2 4mm BL3 22mm | | | |
| | GEV No. | 100909 | Ref. No. 003859 057821 |
| union screw thread M10x1 for pipe ø 6mm Qty 1 pcs | | | |
| | GEV No. | 101287 | Ref. No. — |
| olive for pipe ø 6mm Qty 1 pcs | | | |
| | GEV No. | 101292 | Ref. No. — |
| union screw for igniter suitable for CB 502/505 Qty 1 pcs | | | |
| | GEV No. | 101295 | Ref. No. — |
| clamping collet for thermocouple suitable for CB 502/505 Qty 1 pcs | | | |

| accessories for | | 100085 | |
|---|---------|--------|---|
| | GEV No. | 100220 | Ref. No. 0G0060 0K1176 0K3754 0K5672 100220 102520 |
| pilot burner nozzle LPG gas pressure 50mbar code 2 Qty 1 pcs suitable for JUNKERS CB503_ | | | |
| | GEV No. | 100221 | Ref. No. — |
| pilot burner nozzle LPG gas pressure 30mbar code 29 Qty 1 pcs suitable for JUNKERS CB50203_ | | | |
| | GEV No. | 100222 | Ref. No. 0K1126 0K5348 100222 102522 |
| pilot burner nozzle LPG gas pressure 50mbar code 5 Qty 1 pcs suitable for JUNKERS CB50203_ | | | |
| | GEV No. | 100223 | Ref. No. — |
| pilot burner nozzle natural gas gas pressure 20mbar code 3 Qty 1 pcs suitable for JUNKERS CB503_ | | | |
| | GEV No. | 100224 | Ref. No. — |
| pilot burner nozzle natural gas gas pressure 25mbar code 26 Qty 1 pcs suitable for JUNKERS CB503_ | | | |
| | GEV No. | 100225 | Ref. No. — |
| pilot burner nozzle LPG gas pressure 30mbar code 39 Qty 1 pcs suitable for JUNKERS CB503_ | | | |
| | GEV No. | 100226 | Ref. No. — |
| pilot burner nozzle LPG gas pressure 50mbar code 15 suitable for JUNKERS | | | |
| | GEV No. | 100228 | Ref. No. — |
| pilot burner nozzle town gas gas pressure 8mbar code 4 Qty 1 pcs suitable for JUNKERS CB50203_ | | | |
| | GEV No. | 101281 | Ref. No. — |
| olive for pipe ø 4mm L 8.7mm Qty 1 pcs suitable for CB 502/503 | | | |
| | GEV No. | 101283 | Ref. No. — |
| union screw thread M10x1 for pipe ø 4mm Qty 1 pcs | | | |

POLIDORO











pilot burners







| | | | |
|---|--|-----------------|---------------------------------------|
| | | | |
| 1 | | | |
| GEV No. | 100051 | Ref. No. | 054032 |
| description | pilot burner POLIDORO 3 flames code gas connectionmm | | |
| For models: | BCP/G1, RMV/G1C, RMV/G2C, RCP/G1S, RCP/G2D, XMV/G1C, XMV/G2C, XCP/G1S, XCP/G2D, JCP/G1S, JCP/G2D, MMV/G1C, MMV/G2C, MCP/G1S, MCP/G2D, ACPG25, PCP/G1S, PCP/G2D, OCP/G1S, OCP/G2D, TCP/G1S, TCP/G2D, KP/G2, KMV/G2C, KCP/G1RU, KCP/G2RU, KCP/G1, KCP/G1R, KCP/G2, KCP/G2R, KCP/G1U, KCP/G2U, QP/G2, QMV/G2C, QCP/G1, QCP/G1R, QCP/G2, QCP/G2R, WCP/G1, WCP/G1R, WCP/G2, WCP/G2R, DCP/G400, FCF/G6-0, FCFG101/0, FCFG102-0, FCFG201-0, FCFG202-0, FCFG10160H, FCFG102-0T...(Other models you can see in the webshop) | | |
| spare parts for | 100051 | | |
| | GEV No. | 100907 | Ref. No. 003609 0C0121 11061236 |
| screw connection thread M10x1 Qty 1 pcs type SEF 1 ømm for thermocouple | | | |

Table continues overleaf

2 gas components



| accessories for | | 100051 | |
|--|---------|--------|------------|
|  | GEV No. | 100000 | Ref. No. — |
| pilot burner nozzle POLIDORO LPG code 22 bore ø 0.22mm Qty 1 pcs | | | |
|  | GEV No. | 100208 | Ref. No. — |
| pilot burner nozzle POLIDORO LPG code 20 bore ø 0.2mm Qty 1 pcs | | | |
|  | GEV No. | 100209 | Ref. No. — |
| pilot burner nozzle POLIDORO natural gas code 40 bore ø 0.4mm Qty 1 pcs | | | |
|  | GEV No. | 100701 | Ref. No. — |
| 002564 004125 02B07 02E11 02I24 052610 056640 059380 059988 0915015 0915024 0A2473 0G2066 0G2265 0G2419 0H6628 0H6708 0H6802 0K4320 0KW911 0M0793 0M0823 1215009 | | | |
| ignition electrode connection M4 Qty 1 pcs | | | |
|  | GEV No. | 100906 | Ref. No. — |
| 003610 056641 057960 0974037 0G2227 0K5791 11061230 | | | |
| screw connection thread M10x1 for ignition electrode brass Qty 1 pcs WS 10 | | | |
|  | GEV No. | 100907 | Ref. No. — |
| 003609 0C0121 11061236 | | | |
| screw connection thread M10x1 Qty 1 pcs type SEF 1 ømm for thermocouple | | | |
|  | GEV No. | 100908 | Ref. No. — |
| 046755 052125 0958013 0G2219 0K1348 0K5753 0KE882 0KL495 | | | |
| union screw thread M10x1 for pipe ø 4mm Qty 1 pcs | | | |
|  | GEV No. | 100909 | Ref. No. — |
| 003859 057821 | | | |
| union screw thread M10x1 for pipe ø 6mm Qty 1 pcs | | | |
|  | GEV No. | 102110 | Ref. No. — |
| 006249 054810 0C0152 0C0153 0C0626 0C1547 | | | |
| pilot tube copper pipe ø 4mm thickness 1mm L 3000mm | | | |
|  | GEV No. | 102111 | Ref. No. — |
| pilot tube copper pipe ø 6mm thickness 1mm L 3000mm | | | |
|  | GEV No. | 102508 | Ref. No. — |
| union screw thread M10x1 for pipe ø 4mm Qty 5 pcs | | | |

| accessories for | | 100051 | |
|--|---------|--------|---------------------------|
|  | GEV No. | 102509 | Ref. No. — |
| union screw thread M10x1 for pipe ø 6mm Qty 5 pcs | | | |
|  | GEV No. | 102699 | Ref. No. 054037 054038 |
| pilot burner nozzle POLIDORO natural gas code 25.2 bore ø 2x0.25mm Qty 1 pcs 2 bores | | | |
|  | GEV No. | 102795 | Ref. No. — |
| olive for pipe ø 4mm Qty 1 pcs | | | |
|  | GEV No. | 102797 | Ref. No. — |
| olive for pipe ø 6mm Qty 1 pcs | | | |
|  | GEV No. | 106703 | Ref. No. — |
| pilot burner nozzle POLIDORO natural gas code 27.2 bore ø 2x0.27mm Qty 1 pcs | | | |
|  | GEV No. | 106704 | Ref. No. — |
| pilot burner nozzle POLIDORO LPG code 16.2 bore ø 2x0.16mm Qty 1 pcs | | | |
|  | GEV No. | 106763 | Ref. No. — |
| pilot burner nozzle POLIDORO natural gas code 27.2A bore ø 2x 0.27mm Qty 1 pcs | | | |
|  | GEV No. | 106859 | Ref. No. 054286 |
| pilot burner nozzle POLIDORO LPG code 24 bore ø 0.24mm Qty 1 pcs | | | |

electrodes

| | | | |
|--|--|----------|--------|
|  | | | |
| 1 | | | |
| GEV No. | 505279 | Ref. No. | 0C4104 |
| description | gasket for ignition electrode L 65mm W 20mm | | |
| For models: | FCZ061GAG, FCZ101GAG, FCZ102GAG, FCZ201GAG, FCZ202GAG, FCZ061GAD, FCZ101GAD, FCZ102GAD, FCZ201GAD, FCZ202GAD, FCZ101GTG, FCZ102GTG, FCZ201GTG, FCZ202GTG, FCZ101GTD, FCZ102GTD, FCZ201GTD, FCZ202GTD, FCZ061GBG, FCZ101GBG, FCZ102GBG, FCZ201GBG, FCZ202GBG, FCZ061GBD, FCZ101GBD, FCZ102GBD, FCZ201GBD, FCZ202GBD, FCZ061GBI, FCZ101GBI, FCZ201GBI, FCZ101GBG2, FCZ102GBG2, FCZ201GBG2, FCZ202GBG2, FCZ101GBD2, FCZ102GBD2, FCZ201GBD2, FCZ202GBD2, FCZ101GBI2, FCZ102GBI2, FCZ201GBI2, FCZ061GCG, FCZ101GCG, FCZ102GCG, FCZ201GCG, FCZ202GCG, FCZ061GCD, FCZ101GCD, FCZ102GCD... (Other models you can see in the webshop) | | |



| | | | |
|--|---|-----------------|--|
| | | | |
| GEV No. | 100701 | Ref. No. | 002564 004125 02B07 02E11 02I24 052610 056640 059380 059988 0915015 0915024 0A2473 0G2066 0G2265 0G2419 0H6628 0H6708 0H6802 0K4320 0KW911 0M0793 0M0823 1215009 |
| description | ignition electrode connection M4 Qty 1 pcs | | |
| For models: | MCF/G1090, MCF/G1095, MCF/G995, MFR/G350, MFR/G700, MFR/G350D, MFR/G700D, MFR/G350F, MFR/G700F, MFR/G350E, MFR/G700E, MFR/G350NL, MFR/G700NL, MFR/G740, MFR/G380, MFR/G381, MFR/G350, MFR/G351, MFR/G700, MFR/G701, BCF/G2, BF/G1507, BFR/G1S14, BR/G1FL, BR/G1FR, BR/G2FL, BR/G2FR, BCP/G1, MT/G350, MT/G352, MCP/G700, MCP/G701, MCP/G710, MCP/G711, MCP/G705, MCP/G706, RCF/G2, RCF/G3, RCF/G9, RBR/G2FM, RBR/G2IM, RBK/G2FM, RMV/G1C, RMV/G2C, RF/G1S07, RF/G2D07, RFR/G1S07, RFR/G2D07, RFR/G1S12, RFR/G2D12...(Other models you can see in the webshop) | | |
| accessories for | 100701 | | |
| | | | |
| GEV No. | 100906 | Ref. No. | 003610 056641 057960 0974037 0G2227 0K5791 11061230 |
| screw connection thread M10x1 for ignition electrode brass Qty 1 pcs WS 10 | | | |

| | | | |
|--------------------|--|-----------------|---|
| | | | |
| GEV No. | 100706 | Ref. No. | 02B06 02E10 051565 051977 056754 058135 0915036 0915055 0C0488 0G0083 0H6630 0K5703 0K9080 0KI377 0KQ943 0M0792 6010046 |
| description | ignition electrode connection M4 Qty 1 pcs | | |
| For models: | MCF/G705, MCF/G1055, MCF/G700, MCF/G1050, MCF/G705E, MCF/G1055E, MCF/G700D, MCF/G700, MCF/G705F, MCF/G1055F, MCF/G705NL, MCF/G1050D, MCF/G1055NL, MCF/G702, MCF/G1052, MCF/G700, MCF/G1050, MR/G351, MR/G701, MR/G721, MR/G1071, MR/G350, MR/G350F, MR/G350NL, MR/G350E, MR/G360, MR/G360F, MR/G700, MR/G700F, MR/G700NL, MR/G700E, MR/G710, MR/G710F, MR/G1070, MR/G720, MR/G715, MR/G725, MR/G1075, MR/G361, MR/G711, MR/G716, MR/G726, MR/G1076, MBR/G710D, MBR/G700, MBR/G700F, MBR/G700UK, MBR/G701, MBR/G706, MBR/G701UK...(Other models you can see in the webshop) | | |

| | | | |
|--------------------|--|-----------------|--------|
| | | | |
| GEV No. | 102354 | Ref. No. | 003471 |
| description | ignition electrode D1 ø 32x13mm L1 57mm BL1 25mm connection F 4.8x0.8mm cable length 570mm | | |
| For models: | ZMMDG4, ZMBDG8, ZMMDG6, ZMBDG12 | | |

gas components

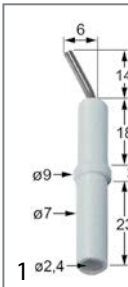
| | | | |
|--------------------|--|-----------------|---|
| GEV No. | 100707 | Ref. No. | 003272 054336 058385 0915037 0A2856 300903 |
| description | ignition electrode D1 ø 7mm D2 ø 9mm connection ø2.4mm L1 14mm L2 6mm BL1 18mm BL2 3mm BL3 23mm to clip Qty 1 pcs | | |
| For models: | HCPA/G1219, HCPA/G11219, HCPA/G121, HCPA/G121, NC4/FV, NC6/FVL, NC6/FV, NC6/2FV, NC8/2FV, NCG1V, NCG2V, NFG/20, NFG20+20, NFT/2GL, NFT/2GR, NFT/2GLC, 1TPG18F, 110FTL/N, 1104F/G, 1106F/2G, 1102FTL/N, 110FTR/N, 1102FTR/N, 1108F/2G, 110CP1, 110FR2, NC4/FV, NC6/FV, NC6/2FV, NC8/2FV, NC6/FVL, NFT/2GL, NFT/4GL, NFT/2GR, NFT/4GR, NFT/4GLR, NFT/4GLRC, NFT/2GLC, NFT/4GLC, NCG1V, NCG2V, NFG/20, NFG20+20, NTP/A, 090213, 090214, PCF/GG840, PCF/GG1260, PCF/GG1680, PTF/GG1835...(Other models you can see in the webshop) | | |

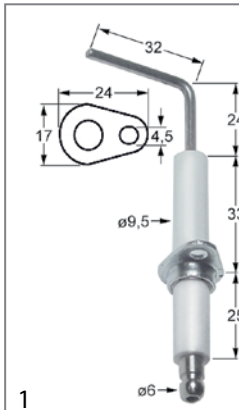

| | | | |
|--------------------|--|-----------------|-------------------|
| GEV No. | 102360 | Ref. No. | 002344 0829267 |
| description | ignition electrode flange length 24mm flange width 17mm D1 ø 9.5mm L1 24mm L2 32mm BL1 33mm BL2 25mm fixing dimensions ø4.5mm with flange connection ø 6mm | | |
| For models: | FCV/G6L4, FCVMG62, 5711-2-6, 5711-2-7, 5711-2-8, 5711-2-10, 5711-2-8CH, 5711-2-10CH, 5711-2-6L, 5711-2-7L, 5711-2-8L, 5711-2-10L, ECV/G6T4, ZCV/G6T4 | | |



| | | | |
|--------------------|--|-----------------|--------|
| GEV No. | 102355 | Ref. No. | 003472 |
| description | ignition electrode flange length 23mm flange width 15mm D1 ø 7mm D2 ø 8mm L1 19mm L2 10mm L3 37mm BL1 17mm BL2 17mm BL3 140mm BL4 60mm connection F 6.3 cable length 1650mm fixing dimensions ø5x4mm with flange | | |

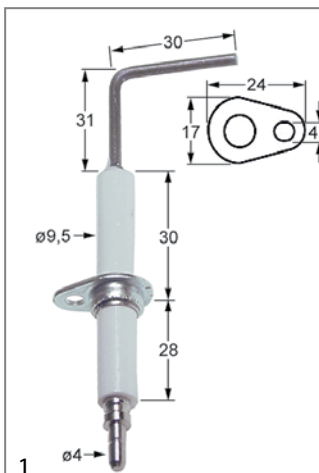

| | | | |
|--------------------|---|-----------------|--------|
| GEV No. | 102175 | Ref. No. | 002638 |
| description | ignition electrode flange length 24mm flange width 17mm D1 ø 9.5mm L1 31mm L2 30mm BL1 30mm BL2 28mm fixing dimensions ø4.5mm with flange connection ø 4mm | | |
| For models: | FDV40G, FDV40GZ, FDV40GA, FDV20G, FDV20GZ, FDV20GA, BRN70G, BRN70E, BRN/70GZ, BRN/70EZ, BR70GZ, BR70EZ, BRNG70A, BRNE70A, FCV/G10L3, FCVG10L3T, FCVG102L3, FCV/G20L3, FCVG202L3, FCVG10L3J, FCVG102L3J, FCV/G10L6JAP, FCV/G102/1L6JAP, FCV/G10L2, FCV/G10L6, FCV/G102/1L6, FCV/G20L6, FCVG202L6, FCV/G101/1, FCV/G102/1, FCV/G201/1, FCV/G202/1, FCS101G2, FCS101G4, FCS101G4DT, FCS101GP9J, FCS101G49J, FCS101GP, FCS102G4, FCS102GA9J, FCS102G49J, FCS102GP, FCS201G4, FCS201GP, FCS202G4, FCS202GP, FCS101GX9J, FCS101GX, FCS102GX9J, FCS102GX...(Other models you can see in the webshop) | | |

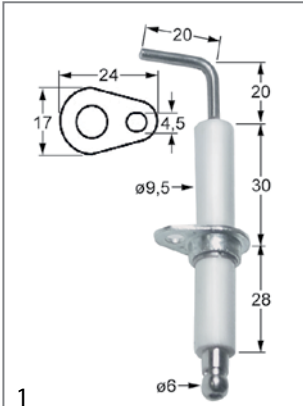

| | | | |
|--------------------|---|-----------------|-------------------|
| GEV No. | 102361 | Ref. No. | 002637 0826212 |
| description | ignition electrode flange length 24mm flange width 17mm D1 ø 9.5mm L1 20mm L2 20mm BL1 30mm BL2 28mm fixing dimensions ø4.5mm with flange connection ø 6mm | | |
| For models: | BRN70G, BRN/70GZ, BR70GZ, BRNG70A, FCV/G10L3, FCVG10L3T, FCVG102L3, FCVG10L3J, FCVG102L3J, FCV/G10L6JAP, FCV/G102/1L-6JAP, FCV/G10L2, FCV/G6L4, FCV/G10L6, FCV/G102/1L6, 5711-2-6, 5711-2-7, 5711-2-8, 5711-2-10, 5711-2-8CH, 5711-2-10CH, 5711-2-6L, 5711-2-7L, 5711-2-8L, 5711-2-10L, 5712-2-10F, 5712-2-10S, 5714-2-10F, 5714-2-10S, ECV/G6T4, ECV/G10T4, ECVG102T4, ECV/G10T4J, ECV/G10T6, ECV/G102/1T6, HCPA/G1219, CPD42G-Z, CPD40GZ, RCV101G2, RCV101G4, ACV/G10C2, ACV/G10C4, ACVG102C4, ACV/G10C6, ACV/G102/1C6, NCV/G10L2, NCV/G10L4, NCV/G102/1, ZCV/G6T4, ZCV/G10T4...(Other models you can see in the webshop) | | |



| | | | |
|--------------------|---|-----------------|--------|
| GEV No. | 102344 | Ref. No. | OC1068 |
| description | ignition electrode flange length 24mm flange width 17mm D1 ø 9.5mm L1 35mm L2 35mm BL2 58mm connection F 4.8x0.8mm cable length 850mm fixing dimensions ø4.5mm with flange | | |
| For models: | AOS101GAEU, AOS102GAEU, AOS201GAEU, AOS202GAEU, AOS-101GAAU, AOS102GAAU, AOS201GAAU, AOS202GAAU, AOS061GA, AOS061GB, AOS101GA, AOS101GB, AOS201GA, AOS201GB, AOS102GB, AOS102GA, AOS202GB, AOS202GA | | |

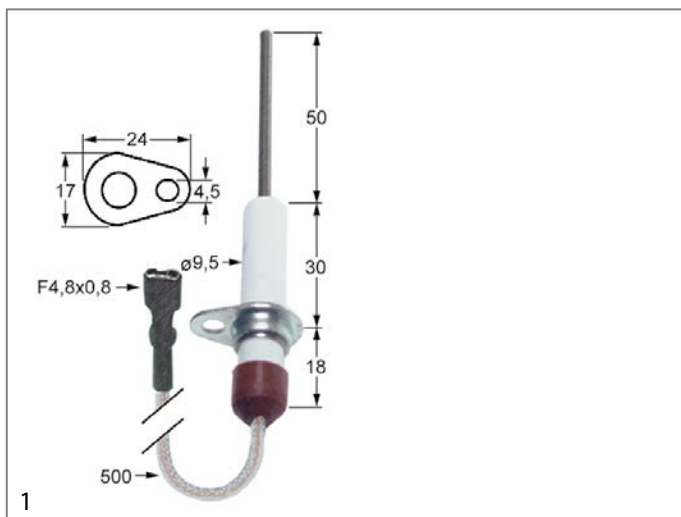

| | | | |
|--------------------|---|-----------------|--------|
| GEV No. | 102345 | Ref. No. | OC1049 |
| description | ignition electrode flange length 24mm flange width 17mm D1 ø 9.5mm L1 50mm BL1 30mm BL2 18mm connection F 4.8x0.8mm cable length 500mm fixing dimensions ø4.5mm with flange | | |
| For models: | AOS061GAEU, AOS101GAEU, AOS102GAEU, AOS201GAEU, AOS-202GAEU, AOS061GAAU, AOS101GAAU, AOS102GAAU, AOS201GAAU, AOS202GAAU, AOS061GA, AOS101GA, AOS101GB, AOS201GA, AOS201GB, AOS102GB, AOS102GA, AOS202GB, AOS202GA | | |

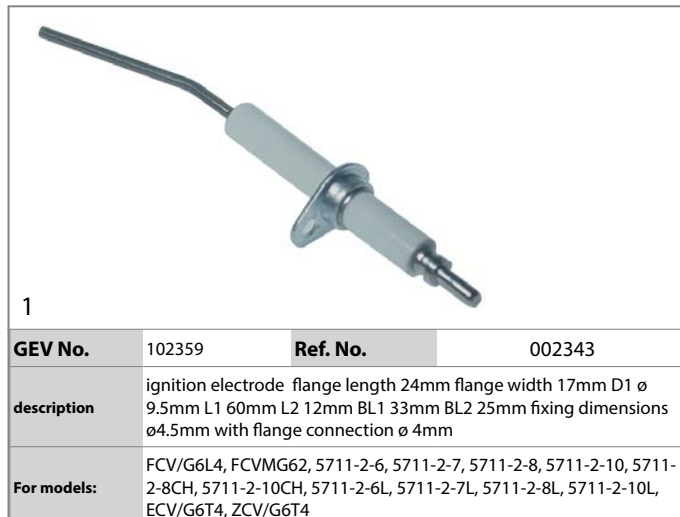

| | | | |
|--------------------|---|-----------------|--------|
| GEV No. | 102359 | Ref. No. | 002343 |
| description | ignition electrode flange length 24mm flange width 17mm D1 ø 9.5mm L1 60mm L2 12mm BL1 33mm BL2 25mm fixing dimensions ø4.5mm with flange connection ø4mm | | |
| For models: | FCV/G6L4, FCVMG62, 5711-2-6, 5711-2-7, 5711-2-8, 5711-2-10, 5711-2-8CH, 5711-2-10CH, 5711-2-6L, 5711-2-7L, 5711-2-8L, 5711-2-10L, ECV/G6T4, ZCV/G6T4 | | |



| | | | |
|--------------------|--|-----------------|--------|
| GEV No. | 106880 | Ref. No. | OC5273 |
| description | ignition electrode flange length 38mm flange width 17mm D1 ø 9.5mm D2 ø 8.5mm L1 10.5mm L2 42mm L3 9mm BL1 51mm BL2 40mm connection ø6 connection ø6mm | | |

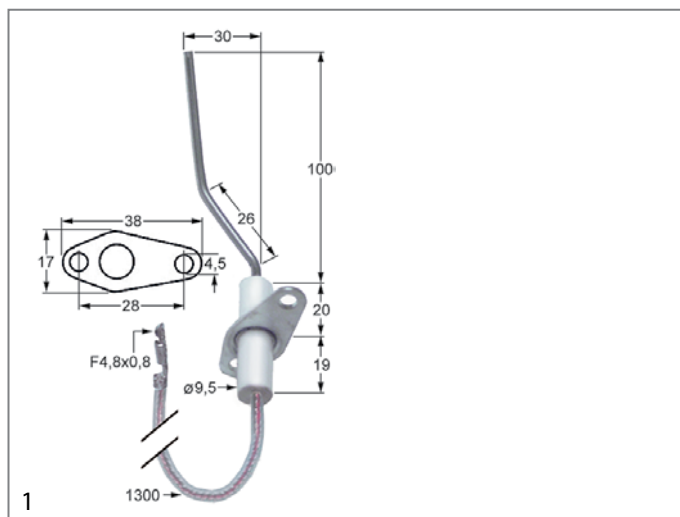

| | | | |
|--------------------|--|-----------------|------------------|
| GEV No. | 100780 | Ref. No. | 005886 OC5599 |
| description | ignition electrode flange length 38mm flange width 17mm D1 ø 9.5mm L1 100mm L2 30mm L3 26mm BL1 20mm BL2 19mm connection F 4.8x0.8mm cable length 1300mm fixing dimensions ø4.5mm mounting distance 28mm with flange | | |
| For models: | ZCBDG8, ZCBDG12, ZCBDG18 | | |

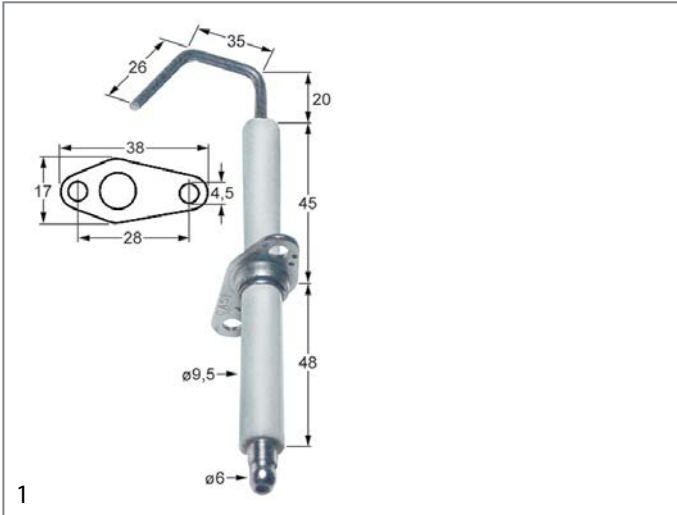

| | | | |
|--------------------|---|-----------------|--------|
| GEV No. | 102351 | Ref. No. | 0C1137 |
| description | ignition electrode flange length 38mm flange width 17mm D1 ø 9.5mm L1 20mm L2 35mm L3 26mm BL1 45mm BL2 48mm cable length 1180mm fixing dimensions ø4.5mm mounting distance 28mm with flange connection ø 6mm | | |
| For models: | AOS201GAEU, AOS201GAAU, AOS061GA, AOS101GA, AOS201GA, AOS201GB | | |

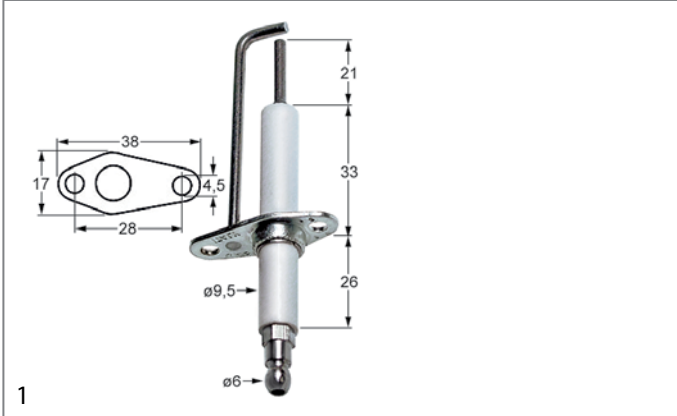

| | | | |
|--------------------|--|-----------------|------------------|
| GEV No. | 102362 | Ref. No. | 0H6803 0K2369 |
| description | ignition electrode flange length 38mm flange width 17mm D1 ø 9.5mm L1 21mm BL1 33mm BL2 26mm fixing dimensions ø4.5mm mounting distance 28mm with flange with earthing contact connection ø 6mm | | |
| For models: | FDV40G, FDV40GZ, FDV40GA, FDV20G, FDV20GZ, FDV20GA, FCV/G20L3, FCVG202L3, FCV/G20L6, FCVG202L6, FCV/G101/1, FCV/G102/1, FCV/G201/1, FCV/G202/1, FCS101G2, FCS101G4, FCS101G4DT, FCS101GP9J, FCS101G49J, FCS101GP, FCS102G4, FCS102GA9J, FCS102G49J, FCS102GP, FCS201G4, FCS201GP, FCS202G4, FCS202GP, FCS101GX9J, FCS101GX, FCS102GX9J, FCS102GX, FCS201GX, FCS202GX, 5712-2-6, 5712-2-7, 5712-2-8, 5712-2-10, 5714-2-6, 5714-2-7, 5714-2-8, 5714-2-10, 5717-2-6, 5714-2-7, 5714-2-8, 5714-2-10, 5712-2-6L, 5712-2-7L, 5712-2-8L, 5712-2-10L...(Other models you can see in the webshop) | | |



| | | | |
|--------------------|---|-----------------|--------|
| GEV No. | 104374 | Ref. No. | 0C1771 |
| description | ignition electrode flange length 38mm flange width 17mm D1 ø 9.5mm L1 35mm BL1 30mm BL2 18mm connection F 2.8x0.8mm cable length 450mm fixing dimensions 4.5mm mounting distance 28mm with flange with earthing contact | | |
| For models: | AOS061GAEU, AOS101GAEU, AOS102GAEU, AOS061GAAU, AOS101GAAU, AOS102GAAU, AOS061GA, AOS061GB, AOS101GA, AOS101GB | | |



| | | | |
|--------------------|--|-----------------|--------|
| GEV No. | 102352 | Ref. No. | 0C1134 |
| description | ignition electrode flange length 38mm flange width 17mm D1 ø 9.5mm L1 35mm BL1 30mm BL2 18mm connection F 2.8x0.8mm cable length 600mm fixing dimensions ø4.5mm mounting distance 28mm with flange with earthing contact | | |
| For models: | AOS201GAEU, AOS202GAEU, AOS201GAAU, AOS202GAAU, AOS061GA, AOS101GA, AOS201GA, AOS201GB, AOS202GB, AOS202GA | | |

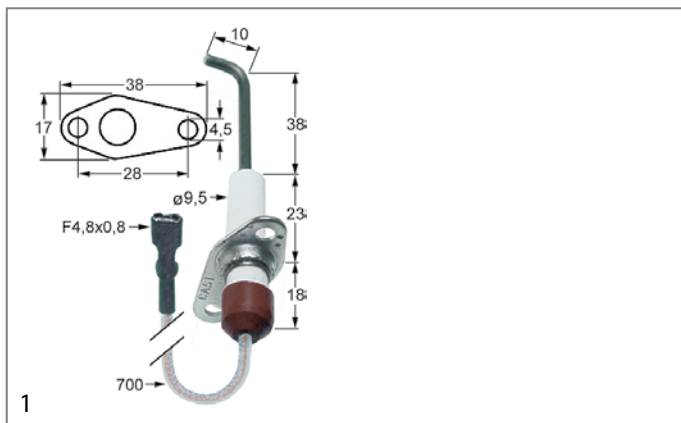

| | | | |
|--------------------|--|-----------------|--------|
| GEV No. | 102349 | Ref. No. | 005920 |
| description | ignition electrode flange length 38mm flange width 17mm D1 ϕ 9.5mm L1 38mm L2 10mm BL1 23mm BL2 18mm connection F 4.8x0.8mm cable length 700mm fixing dimensions ϕ 4.5mm mounting distance 28mm with flange | | |
| For models: | FCVG6L3CJ, FCV/G6L3C, FCV/G61/1, FCV/G61/1, FCV/G61/1, FCV/G61/1, FCV/G61/1, FCV/G6L3CT, FCV/G6L3CJ, FCS061G48J, FCS061GP, FCS061G3DI, FCS061G4, FCS061G4DT, FCS061G49J, 5721-2-7, 5721-2-10, ECV/G6T4C, ECV/G61/1, ECV/G61/1, RCV061G2, ACV/G6C3C, ZCV/G6T4C, ZCV/G61/1 | | |

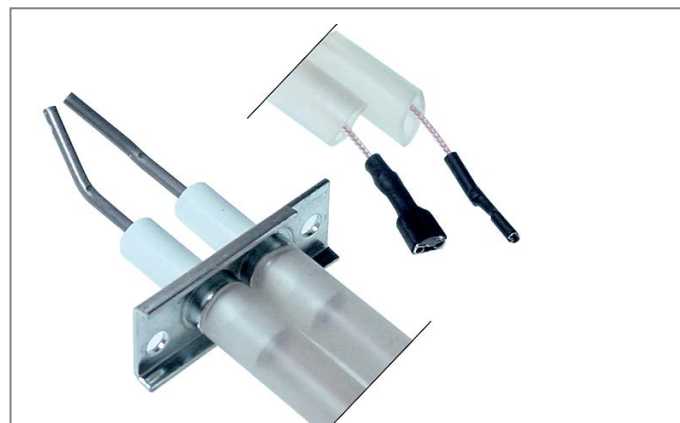

| | | | |
|--------------------|---|-----------------|--------|
| GEV No. | 102348 | Ref. No. | 005910 |
| description | ignition electrode flange length 51mm flange width 23mm D1 ϕ 9.5mm L1 33mm L2 11mm BL1 20mm BL2 15mm connection F 6.3x0.8/2.8x0.8mm cable length 650mm fixing dimensions ϕ 5.5mm with flange | | |
| For models: | FCVG6L3CJ, FCV/G6L3C, FCV/G61/1, FCV/G61/1, FCV/G61/1, FCV/G61/1, FCV/G6L3CT, FCV/G6L3CJ, FCS061G48J, FCS061GP, FCS061G3DI, FCS061G4, FCS061G4DT, FCS061G49J, 5721-2-7, 5721-2-10, ECV/G6T4C, ECV/G61/1, ECV/G61/1, RCV061G2, ACV/G6C3C, ZCV/G6T4C, ZCV/G61/1 | | |



| | | | |
|--------------------|---|-----------------|------------------|
| GEV No. | 104375 | Ref. No. | 005900 0C5598 |
| description | ignition electrode flange length 38mm flange width 17mm D1 ϕ 9.5mm L1 8.5mm L2 20mm BL1 19mm BL2 21mm cable length 800mm | | |
| For models: | ZCBDG8, ZCBDG12, ZCBDG18 | | |

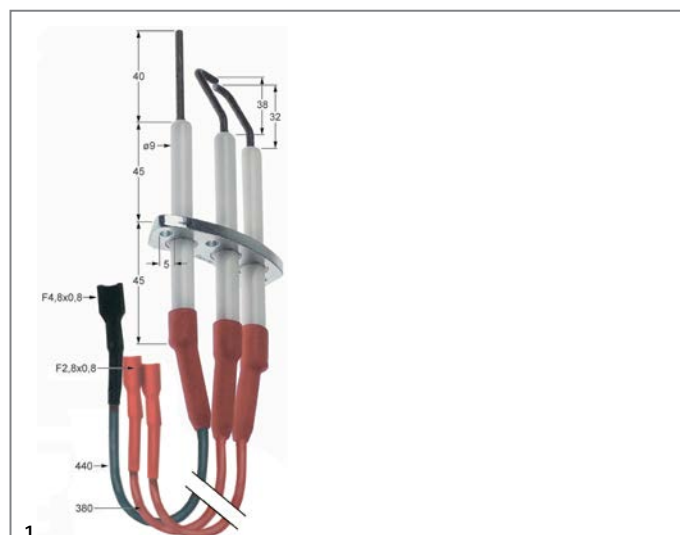

| | | | |
|--------------------|---|-----------------|------------------|
| GEV No. | 103225 | Ref. No. | 0C4259 0C4462 |
| description | monitoring and ignition electrodes flange length 62mm flange width 20mm D1 ϕ 9mm L1 40/38/32mm L2 -/15/13mm L4 -/28/22mm L3 -/13/9mm BL1 45mm BL2 45mm connection F4.8x0.8/F2.8x0.8 cable length 440/380mm fixing dimensions ϕ 5mm | | |
| For models: | FCZ102GAG, FCZ201GAG, FCZ202GAG, FCZ102GAD, FCZ201GAD, FCZ202GAD, FCZ101GTG, FCZ102GTG, FCZ201GTG, FCZ202GTG, FCZ101GTD, FCZ102GTD, FCZ201GTD, FCZ202GTD, FCZ102GBG, FCZ201GBG, FCZ202GBG, FCZ102GBD, FCZ201GBD, FCZ202GBD, FCZ201GBI, FCZ101GBG2, FCZ102GBG2, FCZ201GBG2, FCZ202GBG2, FCZ101GBD2, FCZ102GBD2, FCZ201GBD2, FCZ202GBD2, FCZ101GBI2, FCZ102GBI2, FCZ201GBI2, FCZ102GCG, FCZ201GCG, FCZ202GCG, FCZ102GCD, FCZ201GCD, FCZ202GCD, FCZ101GCG2, FCZ102GCG2, FCZ201GCG2, FCZ202GCG2, FCZ101GCD2, FCZ102GCD2, FCZ201GCD2, FCZ202GCD2, AOS061GAGQ, AOS061GBGQ, AOS101GAGQ, AOS101GBGQ...(Other models you can see in the webshop) | | |



| | | | |
|--------------------|--|-----------------|--------|
| GEV No. | 102350 | Ref. No. | 005911 |
| description | ignition electrode flange length 51mm flange width 23mm D1 ϕ 9.5mm L1 33mm L2 11mm BL1 20mm BL2 15mm connection F 6.3x0.8/2.8x0.8mm cable length 450mm fixing dimensions ϕ 5.5mm with flange | | |
| For models: | FCV/G61/1, FCV/G61/1, FCV/G61/1, FCS061GP, FCS061G4, 5721-2-7, 5721-2-10, ECV/G61/1, ECV/G61/1, ZCV/G61/1 | | |

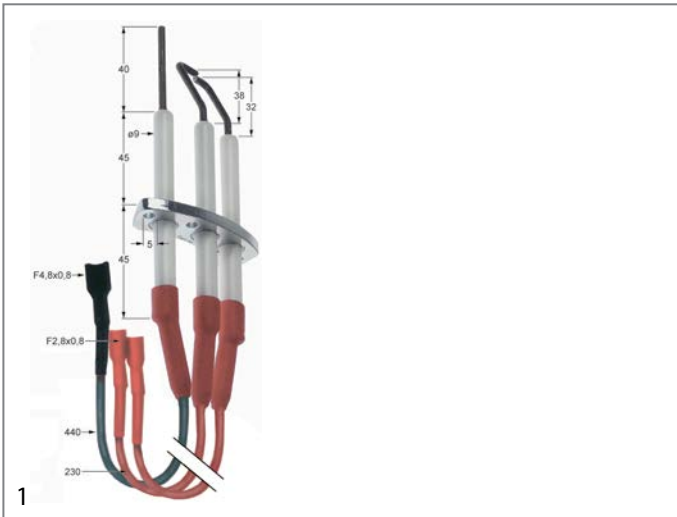

| | | | |
|--------------------|---|-----------------|--------|
| GEV No. | 104535 | Ref. No. | 0C4461 |
| description | monitoring and ignition electrodes group flange length 62mm flange width 20mm D1 ø 9mm L1 40/38/32mm BL1 45mm BL2 45mm connection F4.8x0.8/F2.8x0.8 cable length 440/230/230mm fixing dimensions ø5mm flange | | |
| For models: | FCZ061GAG, FCZ101GAG, FCZ061GAD, FCZ101GAD, FCZ061GBG, FCZ101GBG, FCZ061GBD, FCZ101GBD, FCZ061GBI, FCZ101GBI, FCZ061GCG, FCZ101GCG, FCZ061GCD, FCZ101GCD, AOS061GAG1, AOS101GAG1, AOS061GAD1, AOS101GAD1, AOS061GAI1, AOS101GAI1, AOS101GAQ1, AOS061GAP1, AOS062GAP1, AOS101GAP1, AOS061GAU1, AOS101GAU1, AOS061GBG1, AOS101GBG1, AOS061GBD1, AOS101GBD1, AOS061GBI1, AOS101GBI1, AOS061GCG1, AOS101GCG1, AOS061GCD1, AOS101GCD1, AOS061GCP1, AOS062GCP1, AOS101GCP1, EJN061GAG, EJN101GAG, EJN061GAD, EJN101GAD, RDR061GAG, RDR101GAG, EJN061GBG, EJN101GBG, EJN061GBD, EJN101GBD, RDR061GBG...(Other models you can see in the webshop) | | |

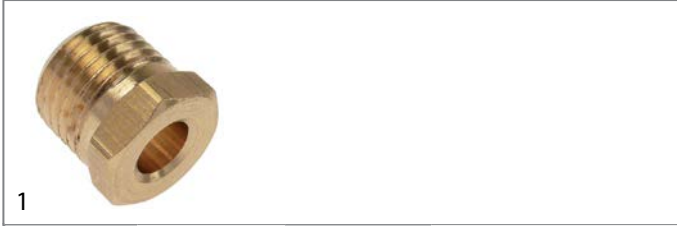

| | | | |
|--------------------|---|-----------------|---|
| GEV No. | 100906 | Ref. No. | 003610 056641 057960 0974037 0G2227 0K5791 11061230 |
| description | screw connection thread M10x1 for ignition electrode brass Qty 1 pcs WS 10 | | |
| For models: | MCF/G1090, MCF/G1095, MCF/G995, MFR/G350, MFR/G700, MFR/G350D, MFR/G700D, MFR/G350F, MFR/G700F, MFR/G350E, MFR/G700E, MFR/G350NL, MFR/G700NL, MFR/G740, MFR/G380, MFR/G381, MFR/G350, MFR/G351, MFR/G700, MFR/G701, BCF/G2, BF/G1S07, BFR/G1S14, BR/G1FL, BR/G1FR, BR/G2FL, BR/G2FR, BCP/G1, MT/G350, MT/G352, MCP/G700, MCP/G701, MCP/G710, MCP/G711, MCP/G705, MCP/G706, VO40G, RCF/G2, RCF/G3, RCF/G9, RBR/G2FM, RBR/G2IM, RBK/G2FM, RMV/G1C, RMV/G2C, RF/G1S07, RF/G2D07, RFR/G1S07, RFR/G2D07, RFR/G1S12...(Other models you can see in the webshop) | | |

ignition cables

pre-assembled cables



| | | | |
|--------------------|---|-----------------|----------------------------|
| GEV No. | 100176 | Ref. No. | 002544 059146 059842 |
| description | ignition cable cable length 1000mm connection ø2.4mm / ø4mm permanent temperature 200°C | | |
| For models: | MR/G351, MR/G701, MR/G721, MR/G1071, MR/G350, MR/G350F, MR/G350NL, MR/G350E, MR/G360, MR/G360F, MR/G700, MR/G700F, MR/G700NL, MR/G700E, MR/G710, MR/G710F, MR/G1070, MR/G720, MR/G715, MR/G725, MR/G1075, MR/G361, MR/G711, MR/G716, MR/G726, MR/G1076, MFR/G740, MFR/G380, MFR/G381, MFR/G350, MFR/G351, MFR/G700, MFR/G701, MPN/GD761, MPN/GI761, MPN/GI760D, MPN/GD760, MPN/GD760F, MPN/GI760, MPN/GI760F, MT/G700D, MT/G700, MT/G350, MT/G352, MM/G351, MM/G701, MM/G350, MM/G700, MM/G350F, MM/G700F...(Other models you can see in the webshop) | | |



| | | | |
|--------------------|---|-----------------|--------------------------------------|
| GEV No. | 100026 | Ref. No. | 002578 054273 0K5687 0K1359 |
| description | ignition cable cable length 1000mm connection ø4mm / F6.3mm | | |
| For models: | MBR/G710D, MBR/G700, MBR/G700F, MBR/G700UK, MBR/G701, MBR/G706, MBR/G701UK, MBR/G751, MBR/G756, MFR/G350NL, MFR/G700NL, RBR/G710D, RBR/G700, RBR/G700F, 7BRG60, 7BRG60X, RBR/G701UK, RBR/G751, RBR/G756, XFR/G350NL, XFR/G700NL, XBR/G710D, XBR/G700, XBR/G710, XBR/G700F, XBR/G700UK, XBR/G701, M70GBP, XBR/G701UK, XBR/G751, XBR/G756, CBR/G700, RBR/G700, RBR/E700, RBR/G700, PTFG810, HMA/G800, HMA/G800D, HMA/G800NL, ZPTF/G1000, ZHMA/G80, CG148-001.A1AB, CG148-003.A2AB, CG248-201.A1ABBB, CG248-203.A1ABBB, CK248-209.D1ABBB, CK248-211.D1ABBB, LG159-703.A1BC, LG159-703.A2BC, LG159-704.A1BC...(Other models you can see in the webshop) | | |



| | | | |
|--------------------|---|-----------------|--------|
| GEV No. | 106848 | Ref. No. | 0C5328 |
| description | ignition cable cable length 1040mm connection F2.8/ø6mm | | |





| | | | |
|--------------------|---|-----------------|--------|
| GEV No. | 102180 | Ref. No. | 005559 |
| description | ignition cable cable length 1200mm connection ø2.4mm / ø2.4mm | | |
| For models: | 1TPG18F, 110FTL/N, 1102FTL/N, 110FTR/N, 1102FTR/N, 110CP1, NC6/2FV, NFT/2GL, NFT/4GL, NFT/2GR, NFT/4GR, NFT/4GLR, NFT/4GLRC, NFT/2GLC, NFT/4GLC, NCG1V, NCG2V, NTP/A, 090213, 090214, PTF/GG1835, PRA/G420, PRA/G430, PRA/G440, PRA/G840, PRA/G850, PRA/G860, PCP/G840, 1TPG18F, 1FTGF4L, 1FTGF4R, 1FTGC4L, 1FTGF8L, 1FTGF8R, 1FTGC8L, 1CP/G08S | | |





| | | | |
|--------------------|---|-----------------|--------|
| GEV No. | 103335 | Ref. No. | 0A5295 |
| description | ignition cable cable length 1650mm connection ø2.4mm / ø4mm | | |
| For models: | MCF/G995, RCF/G9, XCF/G9, MCF/G9, CCF/G710, CCF/G995, CCF/G996, PCF/G9, OCF/G840, OTF/G840, FCV/G6L3TOWNGAS, FCV/G6L3, FCV/G6L3JAP, FCF/G6-0, FCF/G6-1-JAP, ECF/G6/0, ACF/G6-0, JCF/G6-1, JCF/G6-2, RCF061G, ACV/G6C3, NCF/G6-0, NCV/G6L2, ZCF/G6-0 | | |



| | | | |
|---|--|-----------------|--------|
|  | | | |
| GEV No. | 106850 | Ref. No. | 0C5327 |
| description | ignition cable cable length 580mm connection F2.8/ø6mm | | |

| | | | |
|---|---|-----------------|-------------------------------------|
|  | | | |
| GEV No. | 100018 | Ref. No. | 00123 004943 059578 0U3507 |
| description | ignition cable cable length 600mm connection ø2.4mm / ø4mm permanent temperature 200°C | | |
| For models: | MFR/G360, RFR/G360, T35GFR, HPN/GI815D, HPN/GI816, ZPN/GI816D, APN/GI816D, SFRG350, SFRG700, SCPG350, SFRG350, SFRG700, SRG350, SRG360, SRG700, SRG710, SMG350, SMG700, SCPG350 | | |

| | | | |
|---|--|-----------------|----------------------------|
|  | | | |
| GEV No. | 100025 | Ref. No. | 0K0997 0K0998 0K9965 |
| description | ignition cable cable length 600mm connection ø4mm / F6.3mm | | |
| For models: | 9030-2, 9031-2 | | |

| | | | |
|---|--|-----------------|--------|
|  | | | |
| GEV No. | 106849 | Ref. No. | 0C5329 |
| description | ignition cable cable length 850mm connection F2.8/ø6mm | | |

| | | | |
|---|---|-----------------|------------------|
|  | | | |
| GEV No. | 100019 | Ref. No. | 003755 006514 |
| description | ignition cable cable length 900mm connection ø2.4mm / ø4mm | | |
| For models: | BF/G1S07, BG/G1, BG/G2, BCP/G1, RBR/G2FM, RBR/G2IM, RBK/G2FM, RFR/G2S40, RR/G1FL, RR/G1FR, RR/G1CL, RR/G2FL, RR/G2FM, RR/G2CL, RRV/G1FL, RRV/G1FR, RRV/G1CL, RRV/G2FL, RRV/G2FM, RRV/G2CL, RR/G2CM, RG/G1, RG/G2, RGV/G1, RGV/G2, RTV/G2, RTF/G2, RCP/G1S, RCP/G2D, RBV/G2, XFR/G1S14, XFR/G2D14, XR/G1FL, XR/G1FR, XR/G1CL, XR/G2FL, XR/G2FM, XR/G2CL, XRV/G1FL, XRV/G1FR, XRV/G1CL, XRV/G2FL, XRV/G2FM, XRV/G2CL, XR/G2CM, XG/G1, XG/G2, XGV/G1, XGV/G2, XTV/G2...(Other models you can see in the webshop) | | |

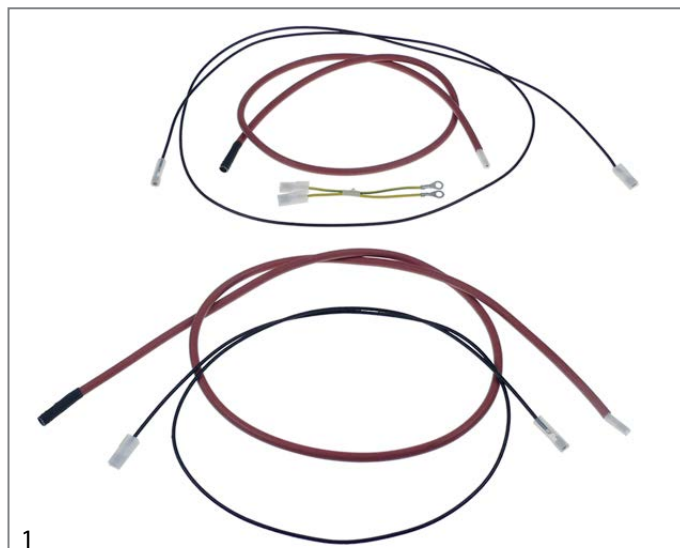

| | | | |
|--------------------|--|-----------------|-------------------------------|
| GEV No. | 106851 | Ref. No. | 003083 006024 638849400 |
| description | ignition cable set 1x6.3/ø4mm L:1100 1x6.3/ø4mm L:1500 1x2.8/ø6mm L:900 1x2.8/ø6mm L:1200 2x6.3/lug 5mm L:100 | | |
| For models: | FCV/G102/1L6JAP, FCV/G102/1L6, FCV/G102/1, FCS102G4, FCS102GP, FCS102GX, 5712-2-6, 5712-2-7, 5712-2-8, 5712-2-10, 5714-2-6, 5714-2-7, 5714-2-8, 5714-2-10, 5717-2-6, 5714-2-7, 5714-2-8, 5714-2-10, 5712-2-6L, 5712-2-7L, 5712-2-8L, 5712-2-10L, 5714-2-6L, 5714-2-7L, 5714-2-8L, 5714-2-10L, 5714-2-6L, 5714-2-7L, 5714-2-8L, 5714-2-10L, 5702-2-2, 5702-2-3, 5704-2-2, 5704-2-3, 5707-2-2, 57074-2-3, ECV/G102/1T6, ACV/G102/1C6, ZCV/G102/1T6 | | |

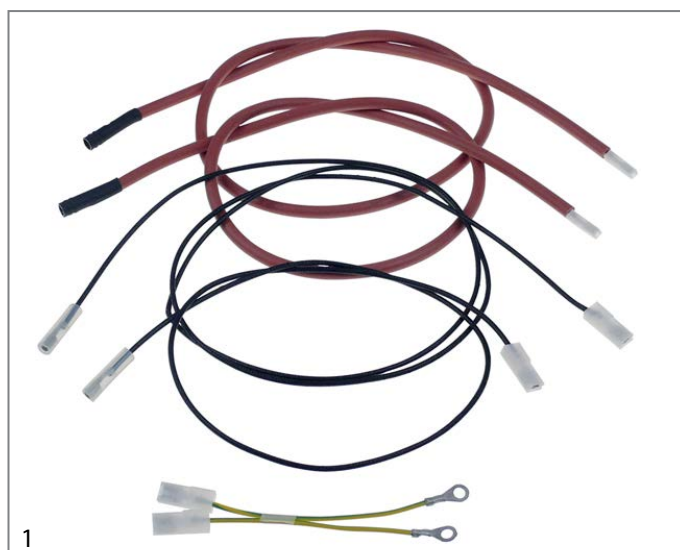

| | | | |
|--------------------|---|-----------------|--------|
| GEV No. | 106852 | Ref. No. | 006023 |
| description | ignition cable set 1x6.3/ø4mm L:660 1x6.3/ø4mm L:1250 1x2.8/ø6mm L:700 1x2.8/ø6mm L:800 2x6.3/lug 5mm L:100 | | |
| For models: | FCV/G101/1, FCS101G4, FCS101G4DT, FCS101GP, FCS101GX | | |

gas components

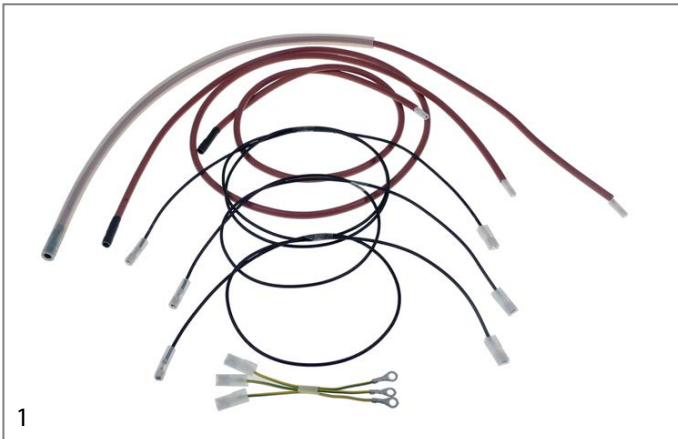

| | | | |
|--------------------|---|-----------------|---------------------|
| GEV No. | 106853 | Ref. No. | 006397 638875800 |
| description | ignition cable set 3x6.3/lug 5mm L:100 2x6.3/ø4mm L:800 1x6.3/ø4mm L:1350 2x2.8/ø6mm L:800 1x2.8/ø6mm L:1370 | | |
| For models: | FCV/G20L3, FCV/G20L6, 5714-2-7, 5714-2-8, 5714-2-10, 5714-2-7L, 5714-2-8L, 5714-2-10L, ECV/G20T4, ECV/G20T6, ACV/G20C4, ACV/G20C6, ZCV/G20T4, ZCV/G20T6 | | |

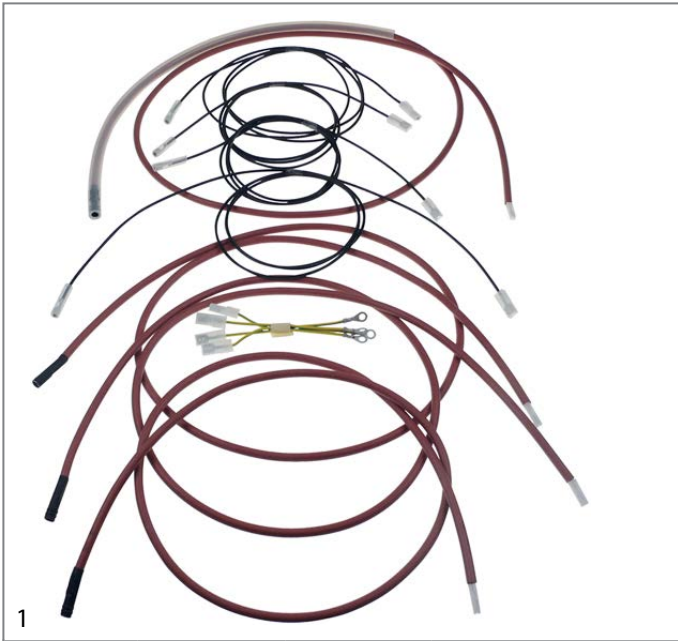

| | | | |
|--------------------|---|-----------------|---------------------|
| GEV No. | 106854 | Ref. No. | 003082 638875700 |
| description | ignition cable set 4x6.3/lug 5mm L:100 1x6.3/ø4mm L:1170 2x6.3/ø4mm L:1300 2x6.3/ø4mm L:1650 2x2.8/ø6mm L:1300 1x2.8/ø6mm L:1700 | | |
| For models: | FCVG202L3, FCVG202L6, 5714-2-7, 5714-2-8, 5714-2-10, 5714-2-7L, 5714-2-8L, 5714-2-10L, ECVG202T4, ECVG202T6, ACVG202C4, ACVG202C6, ZCV/G202/1, ZCV/G202/1 | | |

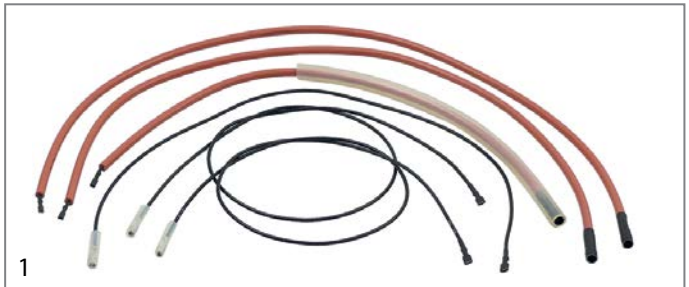

| | | | |
|--------------------|---|-----------------|--------|
| GEV No. | 107872 | Ref. No. | 0C0759 |
| description | ignition cable set 6-piece suitable for combi-steamer ELECTROLUX, ZANUSSI | | |
| For models: | FCV/G201/1, FCS201G4, FCS201GP, FCS201GX | | |

piezoelectric igniters

mounting diameter 22mm

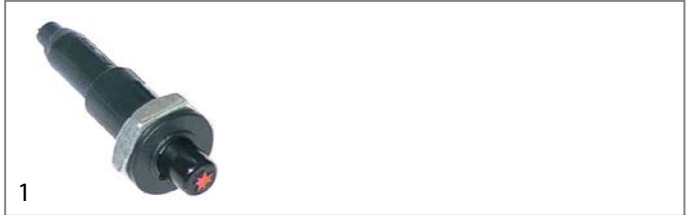



| | | | |
|---|--|-----------------|---------------------------|
| GEV No. | 100013 | Ref. No. | 00128 004944 0K3510 |
| description | piezoelectric igniter body plastic blowing mounting ø 22mm connection ø2.4mm cable lengthmm | | |
| For models: | SCG350, SCG700, SCG1050, SFRG350, SFRG700, SCPG350, SCG350, SCG700, SCG1050, SFRG350, SFRG700, SRG350, SRG360, SRG700, SRG710, SMG350, SMG700, SCPG350, SGG350, SGG700, PPL5GG, PPL5GG | | |
| accessories for | 100013 | | |
|  | GEV No. | 100023 | Ref. No. — |
| | female bullet size 2.3mm 0.5-1.5mm ² CuZn t.max. 125°C Qty 20 pcs | | |





ignition units

| | | | |
|--|---|-----------------|--|
|  <p>1</p> | | | |
| GEV No. | 102485 | Ref. No. | 002297 003376 004240 03200241 051884 052577 053248 053647 057109 066868 069347 0A2073 0K2885 0M0475 |
| description | ignition unit outputs 2 220-240VAC 0.6VA 50-60Hz | | |
| For models: | MCF/G705, MCF/G1055, MCF/G700, MCF/G1050, MCF/G705E, MCF/G1055E, MCF/G700D, MCF/G700, MCF/G705F, MCF/G1055F, MCF/G705NL, MCF/G1050D, MCFG1055NL, MC/G355, MC/G350, MC/G355E, MC/G355F, MCF/G1090, MCF/G1095, MCF/G702, MCF/G1052, MCF/G700, MCF/G1050, MFR/G350, MFR/G700, MFR/G350D, MFR/G700D, MFR/G350F, MFR/G700F, MFR/G350E, MFR/G700E, MTF/GE1050, MT/G700F, MTF/G700F, MTF/G1055F, MTFGE1055F, MCP/G700, VO40G, RC/G1, XC/G1, JC/G1, MC/G1, RCF/G720, RCF/G1020, RCFG730, RCFG1030, RCF/G720F, RCF/G1020, RC/G350, RCF/G700... (Other models you can see in the webshop) | | |

| | | | |
|--|--|-----------------|--------|
|  <p>2</p> | | | |
| GEV No. | 103334 | Ref. No. | 0C4105 |
| description | ignition unit outputs 2 220-240VAC dimensions 83x42x32mm mounting distance 34mm inlet F2.8 outlet F2.8 type TSM 17VA 50/60Hz | | |
| For models: | FCZ061GAG, FCZ101GAG, FCZ102GAG, FCZ201GAG, FCZ202GAG, FCZ061GAD, FCZ101GAD, FCZ102GAD, FCZ201GAD, FCZ202GAD, FCZ101GTG, FCZ102GTG, FCZ201GTG, FCZ202GTG, FCZ101GTD, FCZ102GTD, FCZ201GTD, FCZ202GTD, FCZ061GBG, FCZ101GBG, FCZ102GBG, FCZ201GBG, FCZ202GBG, FCZ061GBD, FCZ101GBD, FCZ102GBD, FCZ201GBD, FCZ202GBD, FCZ061GBI, FCZ101GBI, FCZ201GBI, FCZ101GBG2, FCZ102GBG2, FCZ201GBG2, FCZ202GBG2, FCZ101GBD2, FCZ102GBD2, FCZ201GBD2, FCZ202GBD2, FCZ101GBI2, FCZ102GBI2, FCZ201GBI2, FCZ061GCG, FCZ101GCG, FCZ102GCG, FCZ201GCG, FCZ202GCG, FCZ061GCD, FCZ101GCD, FCZ102GCD... (Other models you can see in the webshop) | | |

| | | | |
|--|--|-----------------|------------------|
|  <p>1</p> | | | |
| GEV No. | 101016 | Ref. No. | 0H6071 0K3019 |
| description | ignition unit outputs 2 230VAC inlet F6.3x0.8 outlet F2.8x0.8 1.7VA 50Hz mounting ø 42mm | | |
| For models: | 7507-2, 7508-2, 7550-2, 7551-2, 7552-2, 7553-2, 7707-2 | | |

| | | | |
|---|---|-----------------|--------|
|  <p>1</p> | | | |
| GEV No. | 102388 | Ref. No. | 003214 |
| description | ignition unit outputs 4 230VAC dimensions 111x23x34mm mounting distance 100mm inlet F6.3x0.8 outlet F2.8x0.8 type WAC-T4 0.6VA 50/60Hz | | |
| For models: | RC/G2, RCV/G2, RCF/G3, RCF/M2, RSF/G2, RSV/G2, RSF/G3, MCF/G3A, XC/G2, XCV/G2, XCF/G3, XCF/M2, XSF/G2, XSV/G2, XSF/G3, JC/G2, JCV/G2, JCF/G3, JCF/M2, MC/G2, MCV/G2, MCF/G3, MCF/M2, MSF/G2, MSV/G2, MSF/G3 | | |

| | | | |
|---|--|-----------------|--------|
|  <p>1</p> | | | |
| GEV No. | 102389 | Ref. No. | 004251 |
| description | ignition unit outputs 6 230VAC dimensions 135x23x34mm mounting distance 123mm inlet F6.3x0.8 outlet F2.8x0.8 0.6VA 50/60Hz | | |
| For models: | RCV/G3, RCF/G2, RCF/M3, MCF/G2A, XCV/G3, XCF/G2, XCFM3, JCV/G3, JCF/G2, JCFM3, MCV/G3, MCF/G2, MCF/M3 | | |

ignition switches

| | | | |
|--|--|-----------------|------------------|
|  <p>1</p> | | | |
| GEV No. | 345038 | Ref. No. | 053978 058274 |
| description | momentary push switch mounting ø 25mm black 2NO 250V 16A connection male faston 6.3mm ambient temperature max. 85°C protection IP40 | | |
| For models: | RC/G320, RC/G330, RC/G320F, RC/G720, RC/G730, MCF/G705, MCF/G1055, MCF/G700, MCF/G1050, MCF/G705E, MCF/G1055E, MCF/G700D, MCF/G700, MCF/G705F, MCF/G1055F, MCF/G705NL, MCF/GE705, MCF/GE1055, MCF/GE700, MCFGE1050, MCF/GE700D, MCFGE1050D, MCF/G1050D, MCFG1055NL, MC/G355, MC/G350, MC/G355E, MC/G350D, MC/G355F, MC/G355NL, MC/G705, MC/G700, MC/G705E, MC/G700D, MC/G705NL, MC/G1055, MC/G1050, MC/G1050D, MC/G1055NL, MC/G705F, MCF/GE1055UK, MCF/G1090, MCF/G1095, MC/G352, MC/G702, MC/G1052, MCF/G702, MCF/GE702, MCF/G1052, MCFGE1052...(Other models you can see in the webshop) | | |

thermocouples

thermocouple sets universal

| | | | |
|---|---------------------------------------|-----------------|--|
|  <p>1</p> | | | |
| GEV No. | 103355 | Ref. No. | 0KB732 0KB972 0KC366 0KC368 0KF226 0KG315 0KG409 0S0056 |
| description | thermocouple set SIT 7-piece L 1200mm | | |

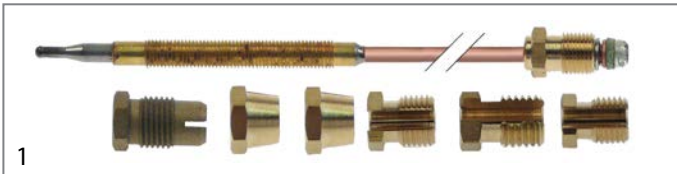

| | | | |
|--------------------|--------------------------------------|-----------------|----------------------------|
| GEV No. | 103354 | Ref. No. | OKB964 OKC254 OS0055 |
| description | thermocouple set SIT 7-piece L 900mm | | |

plug-in thermocouples
plug-in thermocouples standard
with barrel socket $\varnothing 5\text{mm}$ - type Junkers with aluminised tip

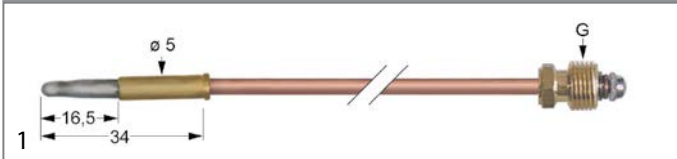

| | | | |
|--------------------|--|-----------------|--|
| GEV No. | 102202 | Ref. No. | OG2378 OKI386 OKJ690 102202 623568 726531 |
| description | thermocouple M8x1 L 320mm plug connection $\varnothing 5.0\text{mm}$ | | |

For models: BE1-TA.3, BE1-W.3, BE1-WS-M.3, BE2-A-C.3, BE2-A-M.3, BE2-WS-C.3, BE2-WS-M.3, BE3-C.3, BE3-M.3, CE128-106, CE158-133.3.HV, CE158-244.3, CE158-246.3, CK248-209.D1ABBB, CK248-211.D1ABBB, HCE128-100, HCE128-104, HCE158-252W.3, HCE158-253.3, HLE129-100, HLE129-103, HLE129-104W, HLE159-252W.3.6, HLE159-328.3.HV, HLE159-351W.3.HV, HLE249-200.3, HLE249-208.3, HLE259-088.3.HV, HLE259-089.3.HV, HLE259-384W.3, LE129-101, LE159-261.3, LE159-281.3.6, LE159-318.3.HV, LE159-322.3.HV, LE159-330.3.HV, LE159-337.3.HV, LE159-344.3.MS92, LE159-347.3.HV, LE249-199.3, LE249-203.3, LE249-207.3, LE249-211.3, LE249-215.3, LE249-219.3, LE249-223.3, LE249-232.3, LE249-238.3, LE259-081.3.HV, LE259-082.3.HV...(Other models you can see in the webshop)

accessories for 102202

| | | | | |
|--|----------------|--------|-----------------|---|
|  | GEV No. | 101260 | Ref. No. | — |
| thermocouple fitting thread M8x1 Qty 1 pcs | | | | |

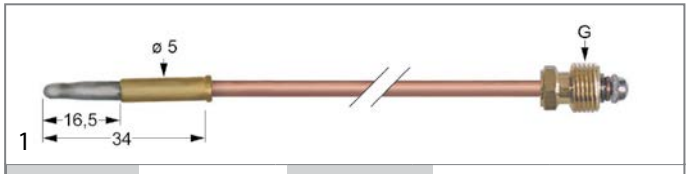

| | | | |
|----------------|--------|-----------------|---|
| GEV No. | 102205 | Ref. No. | 0260138 054102 054103 054104 058332 0G0790 0G2417 0K2870 0KT836 |
|----------------|--------|-----------------|---|

description thermocouple M8x1 L 750mm plug connection $\varnothing 5.0\text{mm}$

For models: RC/G320, RC/G330, RC/G320F, RC/G720, RC/G730, MCF/G700, MCF/G1050, MCF/G700D, MCF/G700, MCF/G705NL, MCF/GE700, MCF-GE1050, MCF/GE700D, MCFGE1050D, MCF/G1050D, MCFG1055NL, MC/G350, MC/G350D, MCFG355NL, MC/G700, MC/G700D, MC/G705NL, MC/G1050, MC/G1050D, MC/G1055NL, MCF/G1090, MCF/G1095, MCF/G995, MC/G352, MC/G702, MC/G1052, MCF/G702, MCF/GE702, MCF/G1052, MCFGE1052, MC/G350, MC/G700, MC/G1050, MCF/G700, MCF/GE700, MCF/G1050, MCFGE1050, BC/G1, BCF/G2, MTF/G700D, MTF/G1050D, MTF/G700, MTF/G1050, MTF/GE1050, RC/G1...(Other models you can see in the webshop)

accessories for 102205

| | | | | |
|---|----------------|--------|-----------------|---|
|  | GEV No. | 101260 | Ref. No. | — |
| thermocouple fitting thread M8x1 Qty 1 pcs | | | | |

with barrel socket $\varnothing 6\text{mm}$
type Junkers with aluminised tip

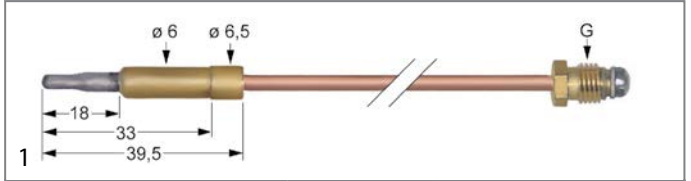

| | | | |
|--------------------|--|-----------------|--------------------------------------|
| GEV No. | 102229 | Ref. No. | 0H6174 0K9988 102032 102229 |
| description | thermocouple M10x1 L 1000mm plug connection $\varnothing 6.0\text{mm}$ | | |

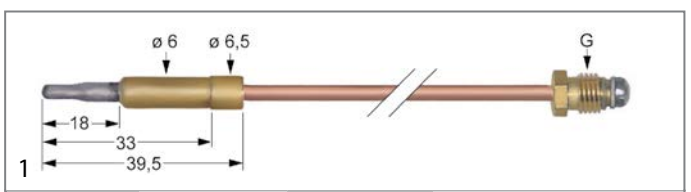

| | | | |
|--------------------|--|-----------------|--|
| GEV No. | 102218 | Ref. No. | 0K0682 0K0689 102019 102217 102218 |
| description | thermocouple M8x1 L 320mm plug connection $\varnothing 6.0\text{mm}$ | | |



with barrel socket $\varnothing 6(6.5)$ mm

thermocouples SIT

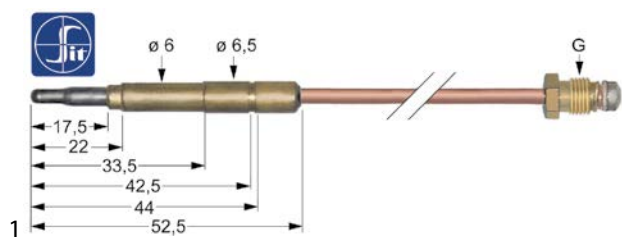

| | | | |
|--------------------|---|-----------------|--------|
| GEV No. | 107626 | Ref. No. | 056715 |
| description | thermocouple SIT ASA 11/32 L 1500mm plug connection $\varnothing 6.0(6.5)$ mm | | |
| For models: | FZG18, FZ/G18 | | |

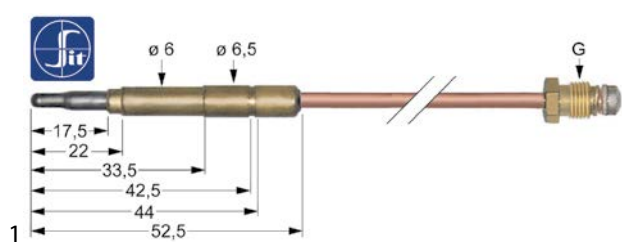

| | | | |
|--------------------|--|-----------------|--------|
| GEV No. | 107624 | Ref. No. | 057343 |
| description | thermocouple SIT ASA 11/32 L 850mm plug connection $\varnothing 6.0(6.5)$ mm | | |

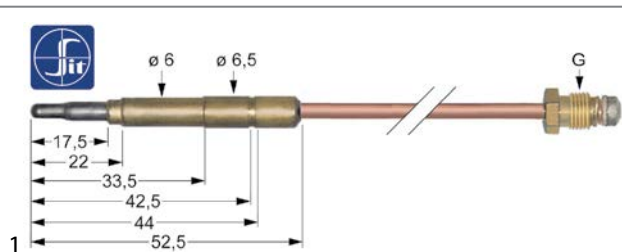

| | | | |
|--------------------|--|-----------------|--|
| GEV No. | 107619 | Ref. No. | 0290059 0290064 0A2161 0H6251 0H6253 0H6254 0KB968 215780 |
| description | thermocouple SIT M10x1 L 1000mm plug connection $\varnothing 6.0(6.5)$ mm | | |
| For models: | 7500-2, 7501-2, 7502-2, 7502-9, 7503-2, 7504-2, 7504-9, 7505-2-9, 7505-9-9, 7508-2, 7511-2, 7512-2, 7512-9, 7530-2, 7531-2, 7550-2, 7551-2, 7552-2, 7553-2, 7700-2, 7701-2, 7703-2, 7711-2, 7730-2, 7731-2, 9000-2, 9001-2, 9002-2, 9004-2, 9006-9, 9012-2, 9030-2, 9031-2, 9201-2, 9203-2, 9211-2-0 | | |

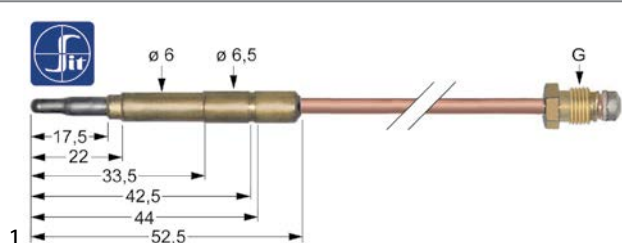

| | | | |
|--------------------|---|-----------------|---------------------------------------|
| GEV No. | 107621 | Ref. No. | 0290068 0H6248 0H6252 0KB970 |
| description | thermocouple SIT M10x1 L 1500mm plug connection $\varnothing 6.0(6.5)$ mm | | |
| For models: | 7542-2, 7544-2, 7742-2, 7744-2, 9042-2, 9044-2 | | |

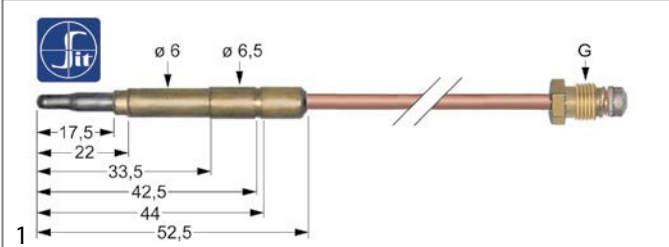

| | | | |
|--------------------|---|-----------------|-----------------------------|
| GEV No. | 107604 | Ref. No. | 002573 0200129 0K5730 |
| description | thermocouple SIT M8x1 L 1200mm plug connection $\varnothing 6.0(6.5)$ mm | | |
| For models: | CG148-001.A1AB, CG148-003.A2AB, CG248-201.A1ABBB, CG248-203.A1ABBB, CK248-209.D1ABBB, CK248-211.D1ABBB, LG159-703.A1BC, LG159-703.A2BC, LG159-704.A1BC, LG159-706.A1BC, LG259-711.A1A-CCB, LG259-712.A1ACCB, LK259-707.D1ACCB, LK259-708.D1ACCB, LG259-739.A1ACCB, LG259-740.A1ACCB, CK248-205.D1ABBB, CK248-207.D1ABBB, LK159-707.D1BC, LK159-708.D1BC, LK259-727.D1ACCB, LK259-728.D1ACCB, LG159-704.A2BC, LK159-707.D2BC, LK159-708.D2BC, LG259-711.A2ACCB, LG259-712.A2ACCB, LK259-727.D2ACCB, LK259-728.D2ACCB, LK259-707.D2ACCB, LK259-708.D2ACCB, CK248-205.D2ABBB, CK248-207.D2ABBB, CK248-209.D2ABBB, CK248-211.D2ABBB, CG148-004.A1AB, CG148-005.A1AB, CG148-006.A1AB, CG248-240.A1ABBB, CG248-243.A1ABBB, CG248-244.A1ABBB, CG248-212.A1ABBB, CG248-213.A1ABBB, LG159-705.A1BC, LG159-753.A1BC, LG259-758.A1ACCB, LG259-754.A1ACCB, LG259-757.A1ACCB, CG148-001.A3AB, CG148-003.A2AB...(Other models you can see in the webshop) | | |

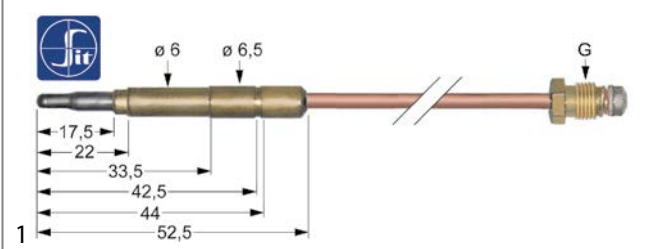

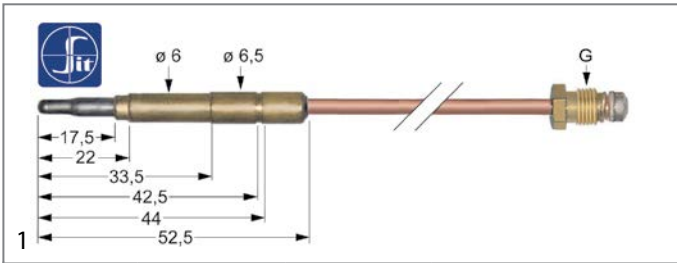

| | | | |
|--------------------|---|-----------------|---------------------------------------|
| GEV No. | 107605 | Ref. No. | 0290171 051119 0G2023 0K2872 |
| description | thermocouple SIT M8x1 L 1500mm plug connection $\varnothing 6.0(6.5)$ mm | | |
| For models: | MCF/G705, MCF/G1055, MCF/G700, MCF/G1050, MCF/G705E, MCF/G1055E, MCF/G700D, MCF/G700, MCF/G705F, MCF/G1055F, MCF/G705NL, MCF/G1050D, MCFG1055NL, MCF/G702, MCF/G1052, MCF/G700, MCF/G1050, BCP/G1, MTF/G700D, MTF/G1050D, MTF/G700, MTF/G1050, MTF/GE1050, MT/G700F, MTF/G700F, MTF/G1055F, MTF-GE1055F, MF/G700, RCF/G2, RCF/G3, RCF/G9, RR/G1FL, RR/G1FR, RR/G2FL, RR/G2FM, RRV/G1FL, RRV/G1FR, RRV/G2FL, RRV/G2FM, RG/G1, RG/G2, RGV/G1, RGV/G2, RTV/G2, RTF/G2, RSF/G2, RSV/G2, RSF/G3, RBV/G2, MCF/G2A...(Other models you can see in the webshop) | | |

gas components

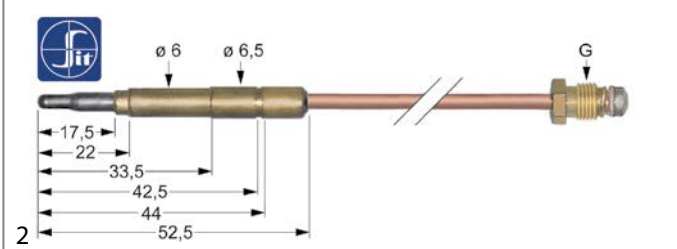

| | | | |
|--------------------|--|-----------------|----------------------------|
| GEV No. | 107601 | Ref. No. | OG1120 OK5729 OKI368 |
| description | thermocouple SIT M8x1 L 600mm plug connection ø6.0(6.5)mm | | |
| For models: | CG148-001.A1AB, CG148-003.A2AB, CG248-201.A1ABBB, CG248-203.A1ABBB, CK248-209.D1ABBB, CK248-211.D1ABBB, LG159-703.A1BC, LG159-703.A2BC, LG159-704.A1BC, LG159-706.A1BC, LG259-711.A1ACCB, LG259-712.A1ACCB, LK259-707.D1ACCB, LK259-708.D1ACCB, LG259-739.A1ACCB, LG259-740.A1ACCB, CK248-205.D1ABBB, CK248-207.D1ABBB, LK159-707.D1BC, LK159-708.D1BC, LK259-727.D1ACCB, LK259-728.D1ACCB, LG159-704.A2BC, LK159-707.D2BC, LK159-708.D2BC, LG259-711.A2ACCB, LG259-712.A2ACCB, LK259-727.D2ACCB, LK259-728.D2ACCB, LK259-707.D2ACCB, LK259-708.D2ACCB, CK248-205.D2ABBB, CK248-207.D2ABBB, CK248-209.D2ABBB, CK248-211.D2ABBB, CG148-004.A1AB, CG148-005.A1AB, CG148-006.A1AB, CG248-240.A1ABBB, CG248-243.A1ABBB, CG248-244.A1ABBB, CG248-212.A1ABBB, CG248-213.A1ABBB, LG159-705.A1BC, LG159-753.A1BC, LG259-758.A1ACCB, LG259-754.A1ACCB, LG259-757.A1ACCB, CG148-001.A3AB, CG148-003.A2AB...(Other models you can see in the webshop) | | |



| | | | |
|---|--|-----------------|---------------------------------------|
| GEV No. | 107602 | Ref. No. | 0290209 0C0202 0G2906 0G4070 |
| description | thermocouple SIT M8x1 L 850mm plug connection ø6.0(6.5)mm | | |
| For models: | ASG36, PC/G1, PC/G2, PCV/G2, PCV/G3, PCF/G2, PCF/G3, PCF/G9, PCF/M2, PCF/M3, PCF/M2E5, PTV/G2, PTF/G2, PSF/G2, PSV/G2, PSF/G3, PCV/G2N, PCF/G3N, PC/G2HV, PCV/G3N, PCF/G2N, PC/G1HV, PTV/G2N, PC/G1A, PC/G2A, PCV/G2A, PCV/G3A, PCF/G2A, PCF/G3A, PCF/M2A, PCF/M3A, OC/G1, OC/G2, OCV/G2, OCF/G2, OCF/G3, OCF/M2, OTV/G2, OTF/G2, OSF/G2, OSV/G2, TC/G1, TC/G2, TCV/G2, TCV/G3, TCF/G2, TCF/G3, TCF/M2, TCF/M3, TCF/M2E5...(Other models you can see in the webshop) | | |
| accessories for | 107602 | | |
|  | GEV No. | 100920 | Ref. No. — |
| | thermocouple fitting thread M8x1 / M9x1 Qty 1 pcs | | |
|  | GEV No. | 100922 | Ref. No. — |
| | thermocouple fitting thread M10x1 / ASA 11/32 Qty 1 pcs | | |

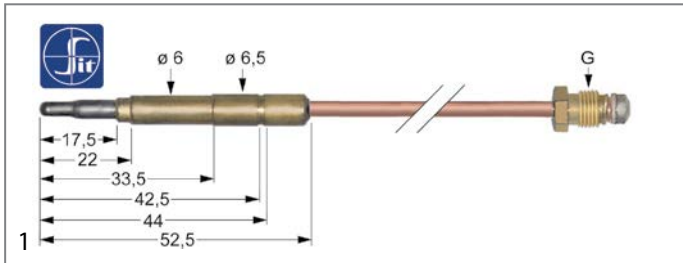

| | | | |
|--------------------|--|-----------------|-----------------------------|
| GEV No. | 107612 | Ref. No. | 027350 0290089 0H6255 |
| description | thermocouple SIT M9x1 L 1000mm plug connection ø6.0(6.5)mm | | |
| For models: | CRN22G, CRN/20G, CRN30G, CRN15G, HCPA/G1219, HCPA/GI 1219, CR22G, CRN/22GZ, CRN20GZ, CRN30GZ, CRN15GZ, ZCPAG1219, ZCPA/GI 1219, CR22G, CRN20GA, CRN30GA, CRN15GA, CR42G, CR/40G, CR15G, CR/41G, CR42G, CR40G, ROCF/G1000, ROTA/G500, ROTA/G1000, ROTF/G1000, ROSD/G1000, ROSD/G1000, ROSS/G1000, ROSF/G1000, ROTF/E1000, RORA/G500, RORA/G1000, ROPN/G1000, ROPN/G1015, ROPN/G1020, ROT/G500, ROT/G1000, ROR/G500, ROR/G1000 | | |

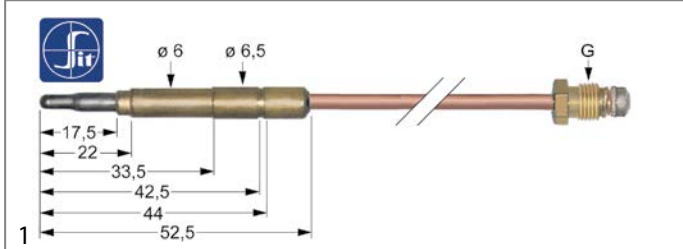

| | | | |
|--------------------|---|-----------------|--|
| GEV No. | 107613 | Ref. No. | 002579 003281 004123 020094 0290125 059816 0G2065 0G2382 0H6224 0K2943 0K3464 0K5728 10070 |
| description | thermocouple SIT M9x1 L 1200mm plug connection ø6.0(6.5)mm | | |
| For models: | MCF/G1090, MCF/G1095, MCF/G995, MPN/GD761, MPN/GI761, MPN/GI760D, MPN/GD760, MPN/GD760F, MPN/GI760, MPN/GI760F, BCF/G2, RPD/G240, RPD/G260, XPD/G240, XPD/G260, JPD/G240, JPD/G260, MPD/G240, MPD/G260, RCF/G1095, 7PDG06, 7PIG06, RPN/GD760F, RPN/GI760F, CCF/G995, CCF/G996, XFR/G350NL, XFR/G700NL, XPN/GI760D, M70GDKE, M70GIKE, XPN/GD760F, XPN/GI760F, PCV/G2, PCV/G3, PCF/G2, PCF/G3, PCF/G9, PTF/G2, PSF/G2, PSF/G3, PCV/G2N, PCF/G3N, PCV/G3N, PCF/G2N, PCV/G2A, PCV/G3A, PCF/G2A, PCF/G3A, OCV/G2...(Other models you can see in the webshop) | | |



| | | | |
|--------------------|---|-----------------|--|
| GEV No. | 107614 | Ref. No. | 002125100 003280 006588 027036 0290022 02R19 02T01 053043 056631 056840 059064 059390 0C5899 0H6250 0K1129 0KL502 0KR014 0M0893 310401 |
| description | thermocouple SIT M9x1 L 1500mm plug connection ø6.0(6.5)mm | | |
| For models: | MBR/G710D, MBR/G700, MBR/G700F, MBR/G700UK, RBR/G710D, RBR/G700, RBR/G700F, XBR/G710D, XBR/G700, XBR/G710, XBR/G700F, XBR/G700UK, CBR/G700, RBR/G700, RBR/E700, RBR/G700, BR80GZ, BR100GZ, CR/41G, CR42G, CR40G, BR100G, BR80G, HCP/G800, HCP/G400, ZRBR/G700, ZRBR/G700D, RBR/G700, TSG 0600, ROG 640 A 1 FD, ROG 640 A 1FD + 1 FS, ROG 640 A 2 FD, ROG 640 A 2 FD +1 FS, ROG 640 B 1 FD, ROG 640 A 1FD + 1 FS, ROG 640 B 2 FD, ROG 640 B 2 FD +1 FS, TFV 1300, TFV 1301, TFV 1302, TFV 1303, TFV 1304, TFV 1305, TFV 1308, TFI 1401, TFI 1402, TFI 1403, TFI 1404, TFI 1407, TFI 1408...(Other models you can see in the webshop) | | |

| | | | |
|--------------------|---|-----------------|---|
| GEV No. | 107609 | Ref. No. | 00118 004942 0200185 025031 0290015 0290016 053002 056639 057781 058133 059283 0K2918 0K3506 6010055 |
| description | thermocouple SIT M9x1 L 600mm plug connection ø6.0(6.5)mm | | |
| For models: | MFG1500Z, MFG2200Z, BR/G1FL, BR/G1FR, BR/G2FL, BR/G2FR, MM/G351, MM/G701, MM/G350, MM/G700, MM/G350F, MM/G700F, MM/G700E, MCP/G700, MCP/G701, MCP/G710, MCP/G711, MCP/G705, MCP/G706, VO40G, RCP/G1S, RCP/G2D, XCP/G1S, XCP/G2D, JCP/G1S, JCP/G2D, MCP/G1S, MCP/G2D, ARG12FL, ARG24FL, ARG36FL, ARG48FL, ARG12FR, ARG24FR, ARG36FR, ARG48FR, AGG12, AGG24, AGG36, AGG48, ARG12FLCE, ARG24FLCE, ARG36FLCE, ARG48FLCE, ARG12FRCE, ARG24FRCE, ARG36FRCE, ARG48FRCE, AGG12CE, AGG24CE...(Other models you can see in the webshop) | | |

| | | | |
|--------------------|---|-----------------|--------------------------------------|
| GEV No. | 107608 | Ref. No. | 025204 027317 059282 059738 |
| description | thermocouple SIT M9x1 L 500mm plug connection ø6.0(6.5)mm | | |
| For models: | RF/G300, HM/G800T, RF/G300 | | |

| | | | |
|--------------------|---|-----------------|--------|
| GEV No. | 107611 | Ref. No. | 058386 |
| description | thermocouple SIT M9x1 L 850mm plug connection ø6.0(6.5)mm | | |

plug-in thermocouples with aluminised tip

| | | | |
|--------------------|--|-----------------|--------|
| GEV No. | 102681 | Ref. No. | 052814 |
| description | thermocouple fast closing M9x1 L 850mm plug connection ø6.5mm | | |
| For models: | MR/G351, MR/G701, MR/G350, MR/G350F, MR/G350NL, MR/G350E, MR/G360, MR/G360F, MR/G700, MR/G700F, MR/G700NL, MR/G700E, MR/G710, MR/G710F, MR/G715, MR/G361, MR/G711, MR/G716, MT/G700D, MTF/G700D, MTF/G1050D, MT/G700, MTF/G700, MTF/G1050, MTF/GE1050, MT/G700F, MTF/G700F, MTF/G1055F, MTFGE1055F, MT/G350, MT/G352, MG/G350D, MG/G700D, MG/G350, MG/G350E, MG/G350F, MG/G350NL, MG/G700, MG/G700E, MG/G700F, MG/G700NL, MG/G1050, MG/G1050F, MG/G1051, RR/G350D, RR/G700D, 7FTGF3L, 7FTGF3R, RR/G360F, 7FTGF7L...(Other models you can see in the webshop) | | |

plug-in thermocouples with interruption

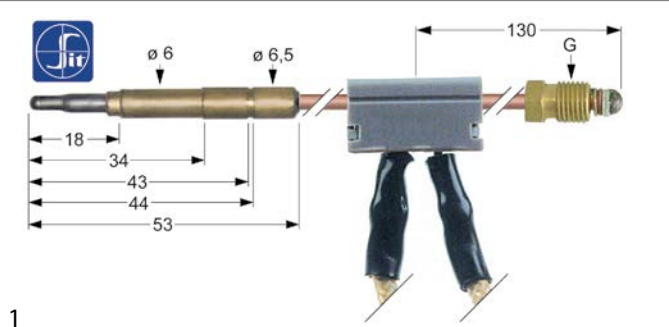

| | | | |
|--------------------|--|-----------------|--|
| GEV No. | 107863 | Ref. No. | 003528 0270426 051932 054055 056573 056914 058387 0C3162 0C3197 0K2898 0K2954 0K5790 0KG229 21635 107869 |
| description | thermocouple SIT with interrupter M9x1 L 1000mm plug connection ø6.0(6.5)mm cable 820mm | | |
| For models: | MR/G721, MR/G1071, MR/G1070, MR/G720, MR/G725, MR/G1075, MR/G726, MR/G1076, MBR/G700UK, MBR/G701, MBR/G706, MBR/G701UK, MBR/G751, MBR/G756, MFR/G350, MFR/G700, MFR/G350D, MFR/G700D, MFR/G360, MFR/G350F, MFR/G700F, MFR/G350E, MFR/G700E, MFR/G740, MFR/G380, MFR/G381, MFR/G350, MFR/G351, MFR/G700, MFR/G701, BF/G1507, BFR/G1514, FG250D, FG250S, FGC/250D, FGC/250S, RBR/G2FM, RBR/G2IM, RBK/G2FM, RMV/G1C, RMV/G2C, RF/G1507, RF/G2D07, RFR/G1507, RFR/G2D07, RFR/G1512, RFR/G2D12, RFR/G2540, RFR/G1514, RFR/G2D14...(Other models you can see in the webshop) | | |

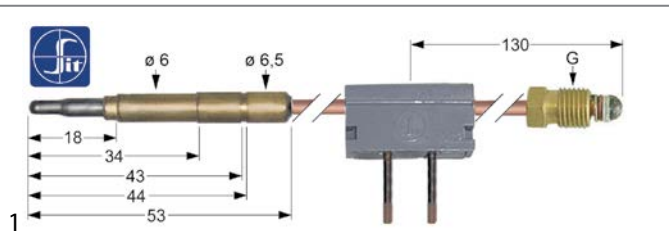

| | | | |
|--------------------|--|-----------------|--------|
| GEV No. | 107164 | Ref. No. | 056574 |
| description | thermocouple SIT with interrupter M9x1 L 1000mm plug connection ø6.0(6.5)mm soldering connection | | |

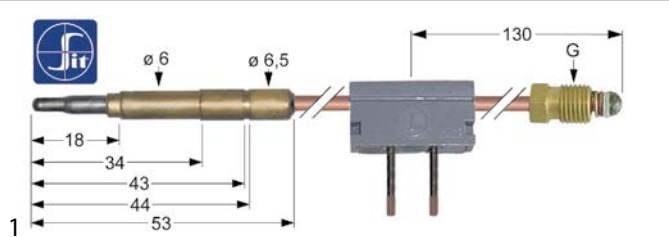

| | | | |
|--------------------|--|-----------------|--------|
| GEV No. | 102068 | Ref. No. | 058503 |
| description | thermocouple SIT with interrupter M9x1 L 320mm plug connection ø6.0mm soldering connection | | |
| For models: | RF/G350D, RF/G700D | | |

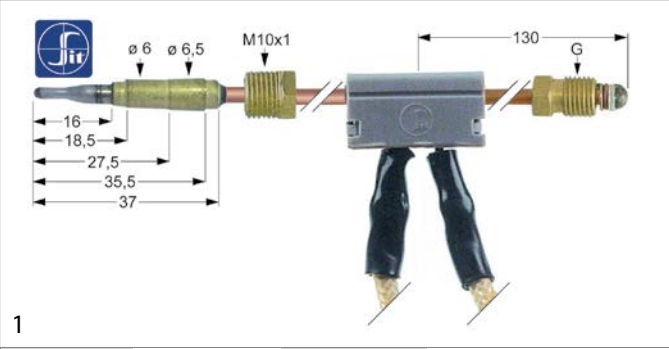

| | | | |
|--------------------|--|-----------------|--------|
| GEV No. | 107148 | Ref. No. | 002784 |
| description | thermocouple SIT with interrupter M9x1 L 600mm M10x1 F 6.3mm | | |
| For models: | HBR/G800, HBR/G805, HBR/G810, HBR/G815, HBR/G811, HBR/G816, HBR/G800UK, ZBR/G800, ZBR/G805, ZBR/G810, ZBR/G815, ZBR/G811, ZBR/G816, ZBR/G800UK, ABR/G800, ABR/G805, ABR/G810, ABR/G815, ABR/G811, ABR/G816, OBR/G800UK | | |

threaded thermocouples

threaded thermocouples standard

with socket with thread M8x1

SIT

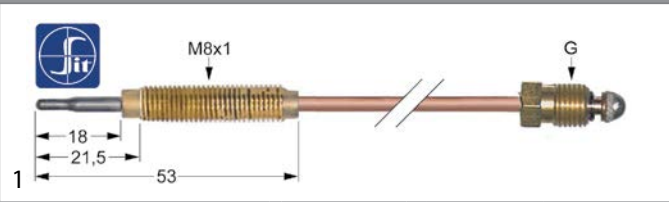

| | | | |
|------------------------|-------------------------------------|-----------------|--------|
| GEV No. | 107634 | Ref. No. | 050235 |
| description | thermocouple SIT M8x1 L 1500mm M8x1 | | |
| accessories for | 107634 | | |

| | | | | |
|---|--|--------|-----------------|-------------------|
|  | GEV No. | 102067 | Ref. No. | 055033 0992014 |
| | nut thread M8x1 H 3mm brass Qty 1 pcs type SEF 1 | | | |

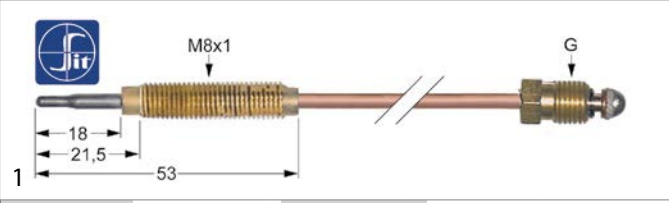

| | | | |
|--------------------|------------------------------------|-----------------|--------|
| GEV No. | 107630 | Ref. No. | 0K5688 |
| description | thermocouple SIT M8x1 L 600mm M8x1 | | |

| | | | |
|------------------------|--|--|--|
| For models: | CG148-001.A1AB, CG148-003.A2AB, CG248-201.A1ABBB, CG248-203.A1ABBB, CK248-209.D1ABBB, CK248-211.D1ABBB, LG159-703.A1BC, LG159-703.A2BC, LG159-704.A1BC, LG159-706.A1BC, LG259-711.A1ACCB, LG259-712.A1ACCB, LK259-707.D1ACCB, LK259-708.D1ACCB, LG259-739.A1ACCB, LG259-740.A1ACCB, CK248-205.D1ABBB, CK248-207.D1ABBB, LK159-707.D1BC, LK159-708.D1BC, LK259-727.D1ACCB, LK259-728.D1ACCB, LG159-704.A2BC, LK159-707.D2BC, LK159-708.D2BC, LG259-711.A2ACCB, LG259-712.A2ACCB, LK259-727.D2ACCB, LK259-728.D2ACCB, LK259-707.D2ACCB, LK259-708.D2ACCB, CK248-205.D2ABBB, CK248-207.D2ABBB, CK248-209.D2ABBB, CK248-211.D2ABBB, CG148-004.A1AB, CG148-005.A1AB, CG148-006.A1AB, CG248-240.A1ABBB, CG248-243.A1ABBB, CG248-244.A1ABBB, CG248-212.A1ABBB, CG248-213.A1ABBB, LG159-705.A1BC, LG159-753.A1BC, LG259-758.A1ACCB, LG259-754.A1ACCB, LG259-757.A1ACCB, CG148-001.A3AB, CG148-003.A2AB...(Other models you can see in the webshop) | | |
| accessories for | 107630 | | |

| | | | | |
|---|--|--------|-----------------|-------------------|
|  | GEV No. | 102067 | Ref. No. | 055033 0992014 |
| | nut thread M8x1 H 3mm brass Qty 1 pcs type SEF 1 | | | |



| | | | |
|------------------------|--|-----------------|-------------------|
| GEV No. | 107631 | Ref. No. | OK0652 OU2960 |
| description | thermocouple SIT M8x1 L 850mm M8x1 | | |
| accessories for | 107631 | | |
| | GEV No. | 102067 | Ref. No. |
| | | | 055033 0992014 |
| | nut thread M8x1 H 3mm brass Qty 1 pcs type SEF 1 | | |

| | | | |
|--------------------|-------------------------------------|-----------------|--------|
| GEV No. | 107640 | Ref. No. | 020756 |
| description | thermocouple SIT M9x1 L 1500mm M8x1 | | |

| | | | |
|------------------------|--|-----------------|-------------------|
| GEV No. | 107636 | Ref. No. | 025677 |
| description | thermocouple SIT M9x1 L 600mm M8x1 | | |
| accessories for | 107636 | | |
| | GEV No. | 102067 | Ref. No. |
| | | | 055033 0992014 |
| | nut thread M8x1 H 3mm brass Qty 1 pcs type SEF 1 | | |

| | | | |
|------------------------|--|-----------------|-------------------|
| GEV No. | 107637 | Ref. No. | 028982 |
| description | thermocouple SIT M9x1 L 850mm M8x1 | | |
| accessories for | 107637 | | |
| | GEV No. | 102067 | Ref. No. |
| | | | 055033 0992014 |
| | nut thread M8x1 H 3mm brass Qty 1 pcs type SEF 1 | | |

threaded thermocouples (miscellaneous)

| | | | |
|--------------------|---------------------------------|-----------------|-----------------------------|
| GEV No. | 107646 | Ref. No. | 0200211 052163 059952 |
| description | thermocouple M9x1 L 1000mm M8x1 | | |

PCG810, PCG1210, PCG1610, PCG810F, PCG1210F, PCG1610F, PCG810D, PCG1210D, PCG1610D, PCG800NL, PCG1200NL, PCG1600NL, PCSG810, PCSG1210, PCSG1610, HCF/GE81, HCF/GE81, HCF/GE81, HCF/G1210, HCF/G1210D, HCF/G1210D, HCF/G1200F, PHCF/G1200, HCF/G1200N, HCF/G1200D, HCF/G1610, HCF/G1610D, HCF/G1600, HCF/G1600F, PHCF/G1600, HCF/G1600N, HCF/G1600D, HTF/G1210, ZPC/G810, ZPC/G1210, ZPC/G1610, HCA/G410, HCA/G810, HCA/G810, HCF/G1210, ZHCF/G161, HCF/GE81, HCF/GE81, HCA/G410D, HCA/G810, HCA/G810, HCF/G1210, HCF/G1610, HC/G400, HC/G800...(Other models you can see in the webshop)

For models:

thermopiles

| | | | |
|--------------------|---|-----------------|--|
| GEV No. | 102116 | Ref. No. | 002607 0240002 0940002 0K4319 11061247 |
| description | thermopile ROBERTSHAW L 900mm probe ø 9mm probe L 57mm 250-750mV screw connection 7/16" | | |

MFR/G740, RFR/G2S40, XFR/G2S40, JFR/G2S40, MFR/G2S40, ACFG24, ACFG36, ACFG24T, ACFG36T, RFR/G741, XFR/G351, CFR/G741, CFR/G351, PFR/G2S40, TFR/G2S40, FC1G, FC2G, HBR/G800, HBR/G805, HBR/G810, HBR/G815, HBR/G811, HBR/G816, HBR/G800UK, HBR/G821UK, RF/G1680, RF/G2480, ZBR/G821, ZBR/G826, ZBR/G800, ZBR/G805, ZBR/G810, ZBR/G815, ZBR/G811, ZBR/G816, ZBR/G800UK, ABR/G800, ABR/G805, ABR/G810, ABR/G815, ABR/G811, ABR/G816, OBR/G800UK

For models:

extensions

| | | | |
|--------------------|---|-----------------|--------|
| GEV No. | 102811 | Ref. No. | 055032 |
| description | thermocouple extension thread M9x1 - M9x1 L 600mm | | |

gas components



accessories

nuts



| | | | |
|--------------------|--|-----------------|-------------------|
| GEV No. | 102067 | Ref. No. | 055033 0992014 |
| description | nut thread M8x1 H 3mm brass Qty 1 pcs type SEF 1 | | |
| For models: | MBR/E710D, MBR/E700, MBR/E700UK, MBR/G701, MBR/G706, MBR/G701UK, MBR/G751, MBR/G756, MBR/E716, MBR/E706, 7BRE60XN, 7BRE60X, RBR/E700UK, 7BRG60, 7BRG60X, RBR/G701UK, RBR/G751, RBR/G756, RBR/E716, RBR/E706, XBR/E710D, M70EBP, XBR/E710, XBR/G701, M70GBP, XBR/G701UK, XBR/G751, XBR/G756, CBR/G700, CBR/E700, XBR/E716, XBR/E706, HR/G420D, HR/G820D, HR/G420, HR/G820, HR/G821, HBR/G800, HBR/G805, HBR/G801, HBR/G806, HBR/G810, HBR/G815, HBR/G811, HBR/G816, HBR/G800D, HBR/G805D, HBR/G801D, HBR/G806D, HBR/G810D...(Other models you can see in the webshop) | | |

interrupters



| | | | |
|--------------------|--------------------------------|-----------------|-----------------------------|
| GEV No. | 101258 | Ref. No. | 0974404 0H6263 0K3024 |
| description | interrupter thread M10x1 | | |
| For models: | 7550-2, 7551-2, 7552-2, 7553-2 | | |



| | | | |
|--------------------|-------------------------|-----------------|-----------------|
| GEV No. | 101264 | Ref. No. | 00426 004982 |
| description | interrupter thread M8x1 | | |
| For models: | SMG350, SMG700 | | |



| | | | |
|--------------------|------------------------------------|-----------------|--|
| GEV No. | 101265 | Ref. No. | 00460 005687 0974402 0C0363 0K3564 301000 |
| description | interrupter thread M9x1 | | |
| For models: | SFRG350, SFRG700, SFRG350, SFRG700 | | |

gas burners

bar burners

bar burners



| | | | |
|--------------------|--|-----------------|--------|
| GEV No. | 105769 | Ref. No. | 003709 |
| description | bar burner 1-row ø 50mm Wmm Hmm L 340mm flange width 57mm flange length 57mm convection oven | | |
| For models: | FCFG101/0, FCFG102-0, FCFG201-0, FCFG10160H, FCFG102-0T, FCF/G101/1-1-JAP, FCF/G102/1-1-JAP, FCF/G101/1, ECFG101-0, ECFG102-0, ECFG201-0, ACFG101-0, ACFG102-0, ACFG201-0, ACFG10160H, JCF/G101/1-1, JCF/G102/1-1, JCF/G101/1-2, JCF/G102/1-2, RCF101G, NCF/G101/1, NCF/G102/1, ZCF/G101/1, ZCF/G102/1, ZCF/G201/1 | | |



| | | | |
|--------------------|---|-----------------|--------|
| GEV No. | 105768 | Ref. No. | 003677 |
| description | bar burner ø 50mm Wmm Hmm L 267mm flange width 57mm flange length 57mm convection oven | | |
| For models: | FCF/G6-0, FCF/G6-1-JAP, ECF/G6/0, ACF/G6-0, JCF/G6-1, JCF/G6-2, RCF061G, NCF/G6-0, ZCF/G6-0 | | |



| | | | |
|--------------------|---|-----------------|--------|
| GEV No. | 105784 | Ref. No. | 056451 |
| description | bar burner ø 50mm Wmm Hmm L 300mm flange width 57mm flange length 57mm convection oven | | |
| For models: | FCV/G6L4, FCVG6-1, FCVG6-3, FCVG6-1UK, FCVG6-3UK, 5711-2-6, 5711-2-7, 5711-2-8, 5711-2-10, 5711-2-8CH, 5711-2-10CH, 5711-2-6L, 5711-2-7L, 5711-2-8L, 5711-2-10L, ECV/G6T4, FCV/G6-1, ZOFCV/G6-3, AFCV/G6-1, AFCV/G6-3, SCO/G6-3, ZCV/G6T4 | | |



| | | | |
|--------------------|---|-----------------|--------|
| GEV No. | 105766 | Ref. No. | 054028 |
| description | bar burner ø 50mm Wmm Hmm L 525mm flange width 57mm flange length 57mm convection oven | | |
| For models: | FCFG20, FCFG20D, FCFG20F, PFCFG20, FCFG20J, FCFG20J, FCFG20J, FCFG20J, FCFG201, FF/G20, COCO20G, ZOFCF/G20D | | |

gas components



| | | | |
|---|---|-----------------|------------------|
|  | | | |
| 1 | | | |
| GEV No. | 105770 | Ref. No. | 003992 004831 |
| description | bar burner ø 60mm Wmm Hmm L 570mm flange width 61mm convection oven flange ø 79mm | | |
| For models: | FCFG202-0, ECFG202-0, ACFG202-0, ZCF/G202/1 | | |

| | | | |
|---|---|-----------------|--------|
|  | | | |
| 1 | | | |
| GEV No. | 105813 | Ref. No. | 002857 |
| description | burner ømm W 185mm H 110mm L 560mm combi-steamer | | |
| For models: | FCV/G6L4, 5711-2-6, 5711-2-7, 5711-2-8, 5711-2-10, 5711-2-8CH, 5711-2-10CH, 5711-2-6L, 5711-2-7L, 5711-2-8L, 5711-2-10L, ECV/G6T4, ZCV/G6T4 | | |

forced air burners

| | | | |
|--|--|-----------------|--------|
|  | | | |
| 1 | | | |
| GEV No. | 104692 | Ref. No. | 0C4125 |
| description | mounting flange L 108mm W 83mm hole distance 21mm M4 thread L 15mm mounting distance 50mm | | |
| For models: | FCZ101GAG, FCZ102GAG, FCZ201GAG, FCZ202GAG, FCZ101GAD, FCZ102GAD, FCZ201GAD, FCZ202GAD, FCZ101GTG, FCZ102GTG, FCZ201GTG, FCZ202GTG, FCZ101GTD, FCZ102GTD, FCZ201GTD, FCZ202GTD, FCZ101GBG, FCZ102GBG, FCZ201GBG, FCZ202GBG, FCZ101GBD, FCZ102GBD, FCZ201GBD, FCZ202GBD, FCZ101GBI, FCZ201GBI, FCZ101GBG2, FCZ102GBG2, FCZ201GBG2, FCZ202GBG2, FCZ101GBD2, FCZ102GBD2, FCZ201GBD2, FCZ202GBD2, FCZ101GBI2, FCZ102GBI2, FCZ201GBI2, FCZ101GCG, FCZ102GCG, FCZ201GCG, FCZ202GCG, FCZ101GCD, FCZ102GCD, FCZ201GCD, FCZ202GCD, FCZ101GCG2, FCZ102GCG2, FCZ201GCG2, FCZ202GCG2, FCZ101GCD2...(Other models you can see in the webshop) | | |

burners for convection ovens

| | | | |
|---|--|-----------------|------------------|
|  | | | |
| 1 | | | |
| GEV No. | 104622 | Ref. No. | 002636 0K1149 |
| description | burner for convection oven ø 60mm L 220mm | | |
| For models: | FDV40G, FDV40GZ, FDV40GA, FDV20G, FDV20GZ, FDV20GA, FCV/G10L3, FCVG10L3T, FCVG102L3, FCV/G20L3, FCVG202L3, FCVG10L3J, FCVG102L3J, FCV/G10L6JAP, FCV/G102/1L6JAP, FCV/G10L2, FCV/G10L6, FCV/G102/1L6, FCV/G20L6, FCVG202L6, FCV/G101/1, FCV/G102/1, FCV/G201/1, FCV/G202/1, FCS101G2, FCS101G4, FCS101G4DT, FCS101GP9J, FCS101G49J, FCS101GP, FCS102G4, FCS102GA9J, FCS102G49J, FCS102GP, FCS201G4, FCS201GP, FCS202G4, FCS202GP, FCS101GX9J, FCS101GX, FCS102GX9J, FCS102GX, FCS201GX, FCS202GX, 5712-2-6, 5712-2-7, 5712-2-8, 5712-2-10, 5714-2-6, 5714-2-7...(Other models you can see in the webshop) | | |

accessories

nozzle holders

| | | | |
|--|---|-----------------|----------------------------|
|  | | | |
| 1 | | | |
| GEV No. | 101347 | Ref. No. | 020988 051948 310056 |
| description | nozzle holder angled | | |
| For models: | MR/G351, MR/G701, MR/G721, MR/G1071, MR/G350, MR/G350F, MR/G350NL, MR/G350E, MR/G360, MR/G360F, MR/G700, MR/G700F, MR/G700NL, MR/G700E, MR/G710, MR/G710F, MR/G1070, MR/G720, MR/G715, MR/G725, MR/G1075, MR/G361, MR/G711, MR/G716, MR/G726, MR/G1076, MFR/G360, MPN/GD761, MPN/GI761, MPN/GI760D, MPN/GD760, MPN/GD760F, MPN/GI760, MPN/GI760F, MM/G700F, MM/G700E, MCP/G700, MG/G350D, MG/G700D, MG/G350, MG/G350E, MG/G350F, MG/G350NL, MG/G700, MG/G700E, MG/G700F, MG/G700NL, MG/G1050, MG/G1050F, MG/G1051...(Other models you can see in the webshop) | | |

| | | | |
|--|--|-----------------|--------|
|  | | | |
| 1 | | | |
| GEV No. | 104537 | Ref. No. | 059375 |
| description | nozzle holder L 39mm screw pipe fitting M16x1.5 ET M15x1 M10x1 tube ø 10mm | | |
| For models: | BR/G1FL, BR/G1FR, BR/G2FL, BR/G2FR, BG/G1, BG/G2, MT/G350, MT/G352, MCP/G700, MCP/G701, MCP/G710, MCP/G711, MCP/G705, MCP/G706, RR/G1FL, RR/G1FR, RR/G1CL, RR/G2FL, RR/G2FM, RR/G2CL, RRV/G1FL, RRV/G1FR, RRV/G1CL, RRV/G2FL, RRV/G2FM, RRV/G2CL, RR/G2CM, RG/G1, RG/G2, RGV/G1, RGV/G2, RSF/G2, RSV/G2, XR/G1FL, XR/G1FR, XR/G1CL, XR/G2FL, XR/G2FM, XR/G2CL, XRV/G1FL, XRV/G1FR, XRV/G1CL, XRV/G2FL, XRV/G2FM, XRV/G2CL, XR/G2CM, XG/G1, XG/G2, XGV/G1, XGV/G2...(Other models you can see in the webshop) | | |

| | | | |
|--|---|-----------------|--------|
|  | | | |
| 1 | | | |
| GEV No. | 106866 | Ref. No. | 059250 |
| description | nozzle holder L 40mm M10x1 | | |
| For models: | MCF/G1095, MCF/G995, MFR/G380, MFR/G381, BCF/G2, BF/G1S07, BFR/G1S14, BCP/G1, RCF/G9, RF/G1S07, RF/G2D07, RFR/G1S07, RFR/G2D07, RPD/G240, RPD/G260, RPI/G260, RPI/G260P, RCP/G1S, RCP/G2D, RBV/G2, RF/G1S07, RF/G2D07, RFR/G1S07, RFR/G2D07, XCF/G9, XF/G1S07, XRF/G2D07, XFR/G1S07, XFR/G2D07, XPD/G240, XPD/G260, XPI/G260, XPI/G260P, XCP/G1S, XCP/G2D, XBV/G2, XF/G1S07, XF/G2D07, XFR/G1S07, XFR/G2D07, JF/G1S07, JF/G2D07, JFR/G1S07, JFR/G2D07, JPD/G240, JPD/G260, JPI/G260, JCP/G1S, JCP/G2D, JBV/G2...(Other models you can see in the webshop) | | |

gas nozzles

main nozzles

gas nozzles M10x1



| | | | |
|--------------------|--|-----------------|--------|
| GEV No. | 106291 | Ref. No. | 003514 |
| description | gas injector thread M10x1 WS 11 bore ø 1.95mm inner peaked | | |
| For models: | RFR/G1S14, RFR/G2D14, XFR/G1S14, XFR/G2D14, JFR/G1S14, JFR/G2D14, MFR/G1S14, MFR/G2D14, ACFG24, ACFG36, ACFG24T, ACFG36T, KB/G1, KB/G2, QB/G1, QB/G2, QB/E1, QB/E2, WB/G1, WB/G2, WB/E1, WB/E2 | | |



| | | | |
|--------------------|--|-----------------|--------|
| GEV No. | 100156 | Ref. No. | 059364 |
| description | gas injector thread M10x1 bore ø 1.3mm L 30mm WS 12 | | |
| For models: | MCF/G1095, MCF/G995, BF/G1S07, RCF/G9, RFR/G1S14, RFR/G2D14, XCF/G9, XFR/G1S14, XFR/G2D14, JFR/G1S14, JFR/G2D14, MCF/G9, MFR/G1S14, MFR/G2D14, CCF/G995, PF/G1S07, PF/G2D07, PFR/G1S07, PFR/G2D07, OF/G1S07, OFR/G1S07, OFR/G2D07, TF/G1S07, TF/G2D07, TFR/G1S07, TFR/G2D07, HCF/G810, HCF/G810D, HCF/G1210D, HCF/G1610D, HCF/G810NL, HCF/G1210, HCF/G1610, HCF/G810, HCF/G1210, HCF/G1610, HCF/G811, HC/G411, HC/G811, HC/G1211, KCF/G2, KCF/G3, KCF/G4, KCF/T2, KCF/T3, KCF/T4, KCF/G2H, KCF/G3H, KCF/G2L, KCF/G2G...(Other models you can see in the webshop) | | |



| | | | |
|--------------------|---|-----------------|----------------------------|
| GEV No. | 100155 | Ref. No. | 056470 0G2229 0G2814 |
| description | gas injector thread M10x1 bore ø 1.45mm L 30mm WS 12 | | |
| For models: | MCF/G1095, MCF/G995, MFR/G380, MFR/G381, BF/G1S07, RCF/G9, RF/G1S07, RF/G2D07, RFR/G1S07, RFR/G2D07, RF/G1S07, RF/G2D07, RFR/G1S07, RFR/G2D07, XCF/G9, XFR/G1S07, XFR/G2D07, XFR/G1S07, XFR/G2D07, XFR/G1S07, XFR/G2D07, JF/G1S07, JF/G2D07, JFR/G1S07, JFR/G2D07, JF/G1S07, JF/G2D07, JFR/G2D07, JFR/G2D07, MCF/G9, MF/G1S07, MF/G2D07, MFR/G1S07, MFR/G2D07, MF/G1S07, MF/G2D07, MFR/G1S07, MFR/G2D07, RCF/G1095, 7FRG03T, CCF/G995, CFR/G381, T35GFR, PCF/G9, PF/G1S07, PF/G2D07, PFR/G1S07, PFR/G2D07...(Other models you can see in the webshop) | | |



| | | | |
|--------------------|--|-----------------|----------------------------|
| GEV No. | 101975 | Ref. No. | 003722 0G2230 0G2778 |
| description | gas injector thread M10x1 bore ø 1.55mm L 30mm WS 12 | | |
| For models: | BF/G1S07, BCP/G1, RF/G1S07, RF/G2D07, RFR/G1S07, RFR/G2D07, RCP/G1S, RCP/G2D, XFR/G1S07, XFR/G2D07, XFR/G1S07, XFR/G2D07, XCP/G1S, XCP/G2D, JF/G1S07, JF/G2D07, JFR/G1S07, JFR/G2D07, JCP/G1S, JCP/G2D, MF/G1S07, MF/G2D07, MFR/G1S07, MFR/G2D07, MCP/G1S, MCP/G2D, PF/G1S07, PF/G2D07, PFR/G1S07, PFR/G2D07, PCP/G1S, PCP/G2D, PBV/G2, OF/G1S07, OFR/G1S07, OFR/G2D07, OCP/G1S, OCP/G2D, TF/G1S07, TF/G2D07, TFR/G1S07, TFR/G2D07, TCP/G1S, TCP/G2D, TBV/G2, KPI/G10, KPI/G15, KPD/G10, KPD/G15, KPD/G15A...(Other models you can see in the webshop) | | |



| | | | |
|--------------------|---|-----------------|--------|
| GEV No. | 100816 | Ref. No. | 002862 |
| description | gas injector thread M10x1 bore ø 1.5mm WS 12 | | |
| For models: | BF/G1S07, RPD/G240, RF/G1S07, RF/G2D07, RFR/G1S07, RFR/G2D07, XPD/G240, XF/G1S07, XF/G2D07, XFR/G1S07, XFR/G2D07, JPD/G240, JF/G1S07, JF/G2D07, JFR/G2D07, JFR/G2D07, MPD/G240, MF/G1S07, MF/G2D07, MFR/G1S07, MFR/G2D07, PCF/G9, PF/G1S07, PF/G2D07, PFR/G1S07, PFR/G2D07, OCF/G9UK, OF/G1S07, OFR/G1S07, OFR/G2D07, TCF/G9, TCF/G9UK, TF/G1S07, TF/G2D07, TFR/G1S07, TFR/G2D07, KCF/G2, KCF/G3, KCF/G4, KCF/T2, KCF/T3, KCF/T4, KCF/G2H, KCF/G3A, KCF/G3H, KCF/G2L, KCF/G3HA, KCF/G2G, KCF/G3G, KCF/G4G...(Other models you can see in the webshop) | | |



| | | | |
|--------------------|---|-----------------|------------------|
| GEV No. | 100151 | Ref. No. | 054127 0K2882 |
| description | gas injector thread M10x1 bore ø 1.65mm L 30mm WS 12 | | |
| For models: | MCF/G705, MCF/G1055, MCF/G700, MCF/G1050, MCF/G705E, MCF/G1055E, MCF/G705F, MCF/G1055F, MCF/G1050D, BF/G1S07, MTF/G1050, MTF/GE1050, MT/G700F, MTF/G700F, MTF/G1055F, MTF-GE1055F, RCF/G720, RCF/G1020, RCF/G730, RCF/G1030, RCF/G720F, RCF/G1020, RCF/G700, RCF/G1050, RCF/G700, MCF/G1050, 7TPG10F, RT/G700F, RTF/G700, RTF/G1050, M70GCK/G, M105GCK/E, XCF/G700D, XCF/G1050D, XCF/G700F, XCF/G1050F, CCF/G710, RTFG720, RTF/G720F, RTF/G1020, RTF/G1030, RTF/G1020F, PF/G1S07, PF/G2D07, PFR/G1S07, PFR/G2D07, PPD/G260, PPI/G260P, PBV/G2, OF/G1S07...(Other models you can see in the webshop) | | |



| | | | |
|--------------------|---|-----------------|--------|
| GEV No. | 106402 | Ref. No. | 003723 |
| description | gas injector thread M10x1 bore ø 1.75mm L 30mm WS 12 | | |
| For models: | BCF/G2, RBV/G2, XBV/G2, JBV/G2, MBV/G2, PCV/G2, PCV/G3, PCF/G2, PCF/G3, PTV/G2, PTF/G2, PSF/G2, PSV/G2, PSF/G3, PPD/G260, PPI/G260P, PBV/G2, PCV/G2N, PCF/G3N, PCV/G3N, PCF/G2N, PTV/G2N, OCV/G2, OCF/G2, OCF/G3, OTV/G2, OTF/G2, OSF/G2, OSV/G2, OPD/G260, OPI/G260P, TCV/G2, TCV/G3, TCF/G2, TCF/G3, TTV/G2, TTF/G2, TSF/G2, TSV/G2, TSF/G3, TPD/G260, TPI/G260P, TBV/G2, KCF/G3A, KCF/G3HA, KCF/G3AG, KB/G1, KB/G2, KPI/G10, KPI/G15...(Other models you can see in the webshop) | | |



| | | | |
|--------------------|---|-----------------|--------|
| GEV No. | 100672 | Ref. No. | 054083 |
| description | gas injector thread M10x1 bore ø 1.7mm L 30mm WS 12 | | |
| For models: | RPD/G240, XPD/G240, JPD/G240, MPD/G240, XCF/G705NL, XCF-G1055NL, FCFG20D, FCVG20-2, FCVG20-4D, FCVG20-4D, FCVG20-4D, PMG600, JFC/GG800, JCF/GG1600, JPF/GG800, ZPM/G600, ZOFCF/G20D, PSZ/GG800, PFZ/GG800, PCF/GG1600 | | |



| | | | |
|--------------------|--|-----------------|--------|
| GEV No. | 100152 | Ref. No. | 054631 |
| description | gas injector thread M10x1 bore ø 1.8mm L 30mm WS 12 | | |
| For models: | MCF/G1050D, MCF/G702, MCF/G1052, MCF/G700, MCF/G1050, MTF/G700D, MTF/G1050D, MTF/G700, MTF/G1050, MTF/GE1050, MF/G700, RCF/G2, RCF/G3, RTV/G2, RTF/G2, RSF/G2, RSV/G2, RSF/G3, RPD/G260, RPI/G260, RPI/G260P, MCF/G2A, MCF/G3A, XCF/G2, XCF/G3, XTV/G2, XTF/G2, XSF/G2, XSV/G2, XSF/G3, XPD/G260, XPI/G260, XPI/G260P, JCF/G2, JCF/G3, JTV/G2, JTF/G2, JPD/G260, JPI/G260, MCF/G2, MCF/G3, MTV/G2, MTF/G2, MSF/G2, MSV/G2, MSF/G3, MPD/G260, MPI/G260, MPI/G260P, RCF/G702...(Other models you can see in the webshop) | | |

gas components



| | | | |
|---|--|-----------------|------------------|
|  | | | |
| 1 | | | |
| GEV No. | 106403 | Ref. No. | 054033 0G2806 |
| description | gas injector thread M10x1 bore ø 1.9mm L 30mm WS 12 | | |
| For models: | KCP/G1, KCP/G1R, KCP/G2, KCP/G2R, HM/G800, QCP/G1, QCP/G1R, QCP/G2, QCP/G2R, ZM/G800, WCP/G1, WCP/G1R, WCP/G2, WCP/G2R, AM/G800, AM/G800D, OM/G800, DCP/G400, FCFG101/0, FCFG102-0, FCFG10160H, FCFG102-0T, FCF/G101/1-1-JAP, FCF/G101/1, FCFG20, FCFG20F, PFCFG20, FCFG40D, FCFG20J, FCFG20J, FCFG20J, FCFG20J, FCFG10-2, FCFG10-4D, FCFG10-2, FCFG10-4, FCFG20-2, FCFG20-4, FCFG20-2UK, FCFG20-4UK, FCFG20-P, ECFG101-0, ECFG102-0, FCFG20PUK, FCFG201, ZOFV/G202, ZOFV/G204, AFGROAOOOO, AFGROFOOOO, AFGUOAOOOO...(Other models you can see in the webshop) | | |

| | | | |
|--|---|-----------------|--------|
|  | | | |
| 1 | | | |
| GEV No. | 107935 | Ref. No. | 055388 |
| description | gas injector thread M10x1 bore ø 3.3mm L 30mm WS 12 | | |

| | | | |
|---|---|-----------------|--------|
|  | | | |
| 1 | | | |
| GEV No. | 103300 | Ref. No. | 055459 |
| description | gas injector thread M10x1 bore ø 2.15mm L 30mm WS 12 | | |
| For models: | ACPG25, FCFG101/0, FCFG102-0, FCFG10160H, FCFG102-0T, FCF/G101/1-1-JAP, FCF/G101/1, FCFG10-2, FCFG10-4, FCFG10-ISG, FCFG10-2UK, FCFG10-4UK, FCFG10-P, FCFG10PUK, ECFG101-0, ECFG102-0, ZOFV/G102, ZOFV/G104, ACFG101-0, ACFG102-0, ACFG10160H, JCF/G101/1-1, JCF/G101/1-2, RCF101G, AFCV/G101, AFCV/G103, SCO/G10-3, NCF/G101/1, NCF/G102/1, FCFG10-ISG, ZCF/G101/1, ZCF/G102/1 | | |

| | | | |
|--|---|-----------------|--------|
|  | | | |
| 1 | | | |
| GEV No. | 103336 | Ref. No. | 054128 |
| description | gas injector thread M10x1 bore ø 3.4mm L 30mm WS 12 | | |
| For models: | MCF/G705, MCF/G1055, MCF/G700, MCF/G1050, MCF/G705F, MCF/G1055F, MCF/G1050D, BCF/G2, MTF/G1050, MTF/GE1050, MT/G700F, MTF/G700F, MTF/G1055F, MTFGE1055F, RCF/G720, RCF/G1020, RCF/G730, RCF/G1030, RCF/G720F, RCF/G1020, RCF/G700, RCF/G1050, RCF/G700, MCF/G1050, 7TPG10F, RT/G700F, RTF/G700, RTF/G1050, M70GCK/G, M105GCK/E, XCF/G700D, XCF/G1050D, XCF/G700F, XCF/G1050F, CCF/G710, RTFG720, RTF/G720F, RTF/G1020, RTF/G1030, RTF/G1020F, PCV/G2, PCV/G3, PCF/G2, PCF/G3, PTV/G2, PTF/G2, PSF/G2, PSV/G2, PSF/G3, PCV/G2N...(Other models you can see in the webshop) | | |

| | | | |
|--|---|-----------------|--------|
|  | | | |
| 1 | | | |
| GEV No. | 106762 | Ref. No. | 056147 |
| description | gas injector thread M10x1 bore ø 2.1mm L 30mm WS 12 | | |

| | | | |
|--|---|-----------------|--------|
|  | | | |
| 1 | | | |
| GEV No. | 106408 | Ref. No. | 054034 |
| description | gas injector thread M10x1 bore ø 3mm L 30mm WS 12 | | |
| For models: | RC/T1, RC/T2, RCV/T2, RCV/T3, RCF/T2, RCF/T3, RCF/W2, RCF/W3, MC/T1, MC/T2, MCV/T2, MCV/T3, MCF/T2, MCF/T3, MCF/W2, MCF/W3, KPI/G10, KPI/G15, KPD/G10, KPD/G15, KPD/G15A, KPI/G15A, KPI/G06, KPI/G15H, KPI/G10H, QPI/G10, QPI/G15, QPD/G10, QPD/G15, QPI/G06, QPI/G15H, QPI/G10H, WPI/G10, WPI/G15, WPD/G10, WPD/G15, WPD/G15A, WPI/G15A, WPI/G06, WPI/G15H, WPI/G10H, FCFG101/0, FCFG102-0, FCFG102-0T, FCF/G102/1-1-JAP, FCFG20, FCFG20F, PFCFG20, FCFG20-2, FCFG20-4...(Other models you can see in the webshop) | | |

| | | | |
|---|--|-----------------|------------------|
|  | | | |
| 1 | | | |
| GEV No. | 102499 | Ref. No. | 056471 OKW910 |
| description | gas injector thread M10x1 bore ø 2.25mm L 30mm WS 12 | | |
| For models: | MCF/G1095, MCF/G995, RCF/G1095, CCF/G995, HCF/G810, HCF/G810D, HCF/G1210D, HCF/G1610D, HCF/G810NL, HCF/G1210, HCF/G1610, HCF/G810, HCF/G1210, HCF/G1610, HCF/G811, HC/G411, HC/G811, HC/G1211, KCF/G2, KCF/G3, KCF/G4, KCF/T2, KCF/T3, KCF/T4, KCF/G2H, KCF/G3H, KCF/G2L, KCF/G2G, KCF/G3G, KCF/G4G, KCF/G2HG, KCF/G3HG, KCF/G2LG, KRF/GT2R, KRF/GT2RP, KS/G2, KSF/G2, KSCF/G3, HTF/G810, HTF/G800D, HTF/G1210, HTF/G1210D, HTF/G800NL, HTFG1210NL, HFS/G800, ZCF/G810, ZCF/G810D, ZCF/G1210D, ZHCFG1610D, ZCF/G1210...(Other models you can see in the webshop) | | |

| | | | |
|--|---|-----------------|--------|
|  | | | |
| 1 | | | |
| GEV No. | 106452 | Ref. No. | 0A2533 |
| description | gas injector thread M10x1 WS 12 bore ø 1.35mm | | |
| For models: | BR/G1FL, BR/G1FR, BR/G2FL, BR/G2FR, BG/G1, BG/G2, RR/G1CL, RR/G2CL, RRV/G1CL, RRV/G2CL, RR/G2CM, RG/G1, RG/G2, RGV/G1, RGV/G2, RTV/G2, RTF/G2, RSF/G3, XR/G1CL, XR/G2CL, XRV/G1CL, XRV/G2CL, XR/G2CM, XG/G1, XG/G2, XGV/G1, XGV/G2, XTV/G2, XTF/G2, XSF/G3, JR/G1CL, JR/G2CL, JRV/G1CL, JRV/G2CL, JG/G1, JG/G2, JGV/G1, JGV/G2, JTV/G2, JTF/G2, MR/G1CL, MR/G2CL, MRV/G1CL, MRV/G2CL, MR/G2CM, MG/G1, MG/G2, MG/G1, MG/G2, MTV/G2...(Other models you can see in the webshop) | | |

| | | | |
|---|---|-----------------|--------|
|  | | | |
| 1 | | | |
| GEV No. | 103337 | Ref. No. | 002267 |
| description | gas injector thread M10x1 bore ø 2.45mm L 30mm WS 12 | | |
| For models: | MCF/G1095, MCF/G995, BCP/G1, CCF/G995, PCP/G1S, PCP/G2D, OCP/G9UK, OCP/G1S, OCP/G2D, TCF/G9, TCF/G9UK, TCP/G1S, TCP/G2D, HCF/G810, HCF/G1210, HCF/G1610, HCF/G810, HCF/G1210, HCF/G1610, HCF/G811, HC/G411, HC/G811, HC/G1211, KCF/G2, KCF/G3, KCF/G4, KCF/T2, KCF/T3, KCF/T4, KCF/G2H, KCF/G3H, KCF/G2L, KCF/G2G, KCF/G3G, KCF/G4G, KCF/G2HG, KCF/G3HG, KCF/G2LG, KRF/GT2R, KRF/GT2RP, KS/G2, KSF/G2, KSCF/G3, HTF/G810, HTF/G1210, HTF/G1210D, HFS/G800, ZCF/G810, ZCF/G1210, ZCF/G1610, ZCF/G810...(Other models you can see in the webshop) | | |

2 gas components



1

| | | | |
|--------------------|--|-----------------|--------|
| GEV No. | 101961 | Ref. No. | 0A2103 |
| description | gas injector thread M10x1 WS 12 bore ø 1.55mm | | |
| For models: | MCF/G1090, MBR/G710D, MBR/G701, MBR/G706, MBR/G701UK, MBR/G751, MBR/G756, RFR/G1S12, RFR/G2D12, RFR/G2S40, XFR/G1S12, XFR/G2D12, XFR/G2S40, JFR/G1S12, JFR/G2D12, JFR/G2S40, MFR/G1S12, MFR/G2D12, MFR/G2S40, ARG12FL, ARG24FL, ARG36FL, ARG48FL, ARG12FR, ARG24FR, ARG36FR, ARG48FR, ARG12FLCE, ARG24FLCE, ARG36FLCE, ARG48FLCE, ARG12FRCE, ARG24FRCE, ARG36FRCE, ARG48FRCE, RBR/G710D, 7BRG60, 7BRG60X, RBR/G701UK, RBR/G751, RBR/G756, XBR/G701, M70GBP, XBR/G701UK, XBR/G751, XBR/G756, CBR/G700, PTV/G2, PTF/G2, PSF/G2...(Other models you can see in the webshop) | | |



1

| | | | |
|--------------------|---|-----------------|------------------|
| GEV No. | 106469 | Ref. No. | 059382 0G2246 |
| description | gas injector thread M10x1 WS 12 bore ø 2.5mm | | |
| For models: | FDV40G, FDV40GZ, FDV40GA, FDV20G, FDV20GZ, FDV20GA, RC/T1, RC/T2, RCV/T2, RCV/T3, RCF/T2, RCF/T3, RCF/W2, RCF/W3, MC/T1, MC/T2, MCV/T2, MCV/T3, MCF/T2, MCF/T3, MCF/W2, MCF/W3, ARG12FL, ARG24FL, ARG36FL, ARG48FL, ARG12FR, ARG24FR, ARG36FR, ARG48FR, ARG12FLCE, ARG24FLCE, ARG36FLCE, ARG48FLCE, ARG12FRCE, ARG24FRCE, ARG36FRCE, ARG48FRCE, CCF/G996, HC/G410, HC/G810, HC/G1210, HCF/G810, HCF/G1210, HCF/G1610, KR/GT1, KR/GT2, KR/GT1R, KR/GT2R, KR/GT1C...(Other models you can see in the webshop) | | |



2

| | | | |
|--------------------|--|-----------------|--------------------|
| GEV No. | 109115 | Ref. No. | 0C0141 62606003 |
| description | gas injector thread M10x1 WS 12 bore ø 1.95mm | | |
| For models: | KC/G1, KC/G2, KCF/G2, KC/G3, KCF/G3, KCF/G4, KCF/M2, KC/T1, KC/T2, KC/T3, KCF/T2, KCF/T3, KCF/T4, KCF/G2H, KC/G1H, KC/G2H, KC/G3H, KC/T1H, KC/T2H, KC/T3H, KCF/G3A, KCF/W2, KCF/G3H, KCF/G2L, KCF/G3HA, KC/G1G, KC/G2G, KCF/G2G, KC/G3G, KCF/G3G, KCF/G4G, KCF/M2G, KCF/G2HG, KC/G1H1G, KC/G2HG, KC/G3HG, KCF/G3AG, KCF/G3HG, KCF/M2E5G, KCF/G2LG, KS/G2, KSF/G2, KSCF/G3, QC/G1, QC/G2, QCF/G2, QC/G3, QCF/G3, QCF/G4, QCF/M2...(Other models you can see in the webshop) | | |



1

| | | | |
|--------------------|--|-----------------|--------|
| GEV No. | 107866 | Ref. No. | 059358 |
| description | gas injector thread M10x1 WS 12 bore ø 2.85mm | | |
| For models: | MCP/G700, MCP/G701, MCP/G710, MCP/G711, MCP/G705, MCP/G706, 7CPG07P, RCP/G701, RCP/G706, M70GPC, M70GPC, XCP/G706, CCP/G700, PMV/G1C, PMV/G2C, OMV/G1C, OMV/G2C, TMV/G1C, TMV/G2C, HC/G410D, HC/G810D, HCF/G810D, HCF/G1210D, HCF/G1610D, HC/G410NL, HC/G810NL, HCF/G810NL, KR/GT1, KR/GT2, KR/GT1R, KR/GT2R, KR/GT1C, KR/GT2C, KR/GT2CR, KR/GT1P, KR/GT2P, KR/GT1RP, KR/GT2RP, KR/GT1CP, KR/GT2CP, KR/GT2CRP, KGR/G1, KGR/G2, KGR/E1, KGR/E2, KGR/T1, KGR/T2, HT/G800D, HTF/G800D, HTF/G1210D...(Other models you can see in the webshop) | | |



1

| | | | |
|--------------------|--|-----------------|--------|
| GEV No. | 104627 | Ref. No. | 0A2475 |
| description | gas injector thread M10x1 WS 12 bore ø 2.25mm | | |
| For models: | BG/G1, BG/G2, RR/G1CL, RR/G2CL, RRV/G1CL, RRV/G2CL, RR/G2CM, XR/G1CL, XR/G2CL, XRV/G1CL, XRV/G2CL, XR/G2CM, JR/G1CL, JR/G2CL, JRV/G1CL, JRV/G2CL, MR/G1CL, MR/G2CL, MRV/G1CL, MRV/G2CL, MR/G2CM, PC/G1, PC/G2, PCV/G2, PCV/G3, PCF/G2, PCF/G3, PCF/G9, PCF/M2, PCF/M3, PCF/M2E5, PTV/G2, PTF/G2, PSF/G2, PSV/G2, PSF/G3, PGV/G1, PGV/G2, PG/G1, PG/G2, PMV/G1C, PMV/G2C, PCV/G2N, PCF/G3N, PC/G2HV, PCV/G3N, PCF/G2N, PG/G1HV, PC/G1HV, PGV/G1HV...(Other models you can see in the webshop) | | |



1

| | | | |
|--------------------|---|-----------------|----------------------------|
| GEV No. | 106474 | Ref. No. | 0A2102 0G2886 0K0281 |
| description | gas injector thread M10x1 WS 12 bore ø 2mm | | |
| For models: | BC/G1, BCF/G2, BR/G1FL, BR/G1FR, BR/G2FL, BR/G2FR, BG/G1, BG/G2, RMV/G1C, RR/G1FL, RR/G1FR, RR/G2FL, RR/G2FM, RRV/G1FL, RRV/G1FR, RRV/G2FL, RRV/G2FM, RG/G1, RG/G2, RGV/G1, RGV/G2, RTV/G2, RTF/G2, RSF/G3, XMV/G1C, XR/G1FL, XR/G1FR, XR/G2FL, XR/G2FM, XRV/G1FL, XRV/G1FR, XRV/G2FL, XRV/G2FM, XG/G1, XG/G2, XGV/G1, XGV/G2, XTV/G2, XTF/G2, XSF/G3, JR/G1FL, JR/G1FR, JR/G2FL, JR/G2FM, JRV/G1FL, JRV/G1FR, JRV/G2FL, JRV/G2FM, JG/G1, JG/G2...(Other models you can see in the webshop) | | |



1

| | | | |
|--------------------|--|-----------------|--|
| GEV No. | 106475 | Ref. No. | 0A2083 0C0143 0G2252 0G2887 0K0253 |
| description | gas injector thread M10x1 WS 12 bore ø 2.2mm | | |
| For models: | BR/G1FL, BR/G1FR, BR/G2FL, BR/G2FR, BG/G1, BG/G2, FDV40G, FDV40GZ, FDV40GA, FDV20G, FDV20GZ, FDV20GA, RR/G1FL, RR/G1FR, RR/G2FL, RR/G2FM, RRV/G1FL, RRV/G1FR, RRV/G2FL, RRV/G2FM, RG/G1, RG/G2, RGV/G1, RGV/G2, RTV/G2, RTF/G2, RSF/G3, XR/G1FL, XR/G1FR, XR/G2FL, XR/G2FM, XRV/G1FL, XRV/G1FR, XRV/G2FL, XRV/G2FM, XG/G1, XG/G2, XGV/G1, XGV/G2, XTV/G2, XTF/G2, XSF/G3, JR/G1FL, JR/G1FR, JR/G2FL, JR/G2FM, JRV/G1FL, JRV/G1FR, JRV/G2FL, JRV/G2FM...(Other models you can see in the webshop) | | |





1

| | | | |
|--------------------|--|-----------------|--------|
| GEV No. | 107867 | Ref. No. | 002979 |
| description | gas injector thread M10x1 WS 12 bore ø 3.8mm | | |
| For models: | BR/G1FL, BR/G1FR, BR/G2FL, BR/G2FR, TR/G1FL, TR/G1FR, TR/G1CL, TR/G2FL, TR/G2FM, TR/G2CL, TRV/G1FL, TRV/G1FR, TRV/G1CL, TRV/G2FL, TRV/G2FM, TRV/G2CL, TR/G2CM, KBR/G2F, KBR/G2C, KBR/G3F, KBR/G3FH, KBR/G3C, KBR/G3CH, KBR/G2FH, KBR/G2CH, HPN/G1815, HPN/G1816, HPN/GD816, HPA/GD825, HPA/G1825, HPNS/G1816, QBR/G2F, QBR/G2C, QBR/G3F, QBR/G3FH, QBR/G3C, QBR/G3CH, QBR/G2FH, QBR/G2CH, 2PIG15, ZPN/G1816, ZPN/GD816, 2PDAG15, 2PIAG15, ZPNS/G1816, WBR/G2F, WBR/G2C, WBR/G3F, WBR/G3FH, WBR/G3C...(Other models you can see in the webshop) | | |



| | | | |
|---|---|-----------------|--------|
|  | | | |
| 1 | | | |
| GEV No. | 106675 | Ref. No. | 002864 |
| description | gas injector thread M10x1 WS 12 bore ø 4.5mm | | |
| For models: | FDV40G, FDV40GZ, FDV40GA, FDV20G, FDV20GZ, FDV20GA, FCV/G10L3, FCVG10L3T, FCVG10L3, FCVG20L3, FCVG10L3J, FCVG10L3J, FCV/G102/1L6JAP, FCV/G102/1L6, FCVG20L6, FCV/G102/1, FCV/G202/1, FCS101GP9J, FCS101GP, FCS102G4, FCS-102GA9J, FCS102G49J, FCS102GP, FCS201G4, FCS201GP, FCS202G4, FCS202GP, FCS202GX, 5714-2-6, 5714-2-7, 5714-2-8, 5714-2-10, 5714-2-6L, 5714-2-7L, 5714-2-8L, 5714-2-10L, 5707-2-2, 57074-2-3, ECVG102T4, ECVG202T4, ECV/G102/1T6, ECVG202T6, ACVG102C4, ACVG202C4, ACV/G102/1C6, ACVG202C6, NCV/G102/1, ZCV/G102/1, ZCV/G202/1, ZCV/G102/1T6...(Other models you can see in the webshop) | | |

| | | | |
|--|---|-----------------|--------|
|  | | | |
| 1 | | | |
| GEV No. | 100477 | Ref. No. | 0A2141 |
| description | gas injector thread M10x1 WS 12 bore ø 1.65mm | | |
| For models: | MCP/G700, MCP/G701, MCP/G710, MCP/G711, MCP/G705, MCP/G706, RBR/G2FM, RBR/G2IM, RBK/G2FM, RMV/G1C, RMV/G2C, XBR/G2FM, XBR/G2IM, XBK/G2FM, XMV/G1C, XMV/G2C, JBR/G2FM, MBR/G2FM, MBR/G2IM, MBK/G2FM, MMV/G1C, MMV/G2C, ASG36, ARG-12FL, ARG24FL, ARG36FL, ARG48FL, ARG12FR, ARG24FR, ARG36FR, ARG48FR, AGG12, AGG24, AGG36, AGG48, ARG12FLCE, ARG24FLCE, ARG36FLCE, ARG48FLCE, ARG12FRCE, ARG24FRCE, ARG36FRCE, ARG48FRCE, AGG12CE, AGG24CE, AGG36CE, AGG48CE, 7CPG07P, RCP/G701, RCP/G706...(Other models you can see in the webshop) | | |

| | | | |
|---|---|-----------------|--------|
|  | | | |
| 1 | | | |
| GEV No. | 107871 | Ref. No. | 0A2306 |
| description | gas injector thread M10x1 WS 12 bore ø 4mm | | |
| For models: | BG/G1, BG/G2, RG/T1, RG/T2, RGV/T1, RGV/T2, MG/T1, MG/T2, MG/T1, MG/T2, PG/G1, PG/G2, PG/G1HV, PG/G2HV, OG/G1, OG/G2, TR/G1FL, TR/G1FR, TR/G1CL, TR/G2FL, TR/G2FM, TR/G2CL, TRV/G1FL, TRV/G1FR, TRV/G1CL, TRV/G2FL, TRV/G2FM, TRV/G2CL, TR/G2CM, TG/G1, TG/G2, KRF/GT2R, KRF/GT2RP, KBR/G3F, KBR/G3FH, KBR/G3C, KBR/G3CH, HFR/G410, HFR/G810, HFR/G410D, HFR/G810D, HFR/G410NL, HFR/G810NL, HFR/G411, HFR/G412, HPN/GI815, HPN/GI816, HPN/GD816, HPA/GD825, HPA/GI825...(Other models you can see in the webshop) | | |

| | | | |
|--|---|-----------------|------------------|
|  | | | |
| 1 | | | |
| GEV No. | 100447 | Ref. No. | 0A2081 0A2104 |
| description | gas injector thread M10x1 WS 12 bore ø 2.3mm | | |
| For models: | ARG12FL, ARG24FL, ARG36FL, ARG48FL, ARG12FR, ARG24FR, ARG-36FR, ARG48FR, ARG12FLCE, ARG24FLCE, ARG36FLCE, ARG48FLCE, ARG12FRCE, ARG24FRCE, ARG36FRCE, ARG48FRCE, CCF/G996, PR/G1FL, PR/G1FR, PR/G1CL, PR/G2FL, PR/G2FM, PR/G2CL, PRV/G1FL, PRV/G1FR, PRV/G1CL, PRV/G2FL, PRV/G2FM, PRV/G2CL, PR/G2CM, PR/G1FLHV, PRV/G2FLHV, OR/G1FL, OR/G1FR, OR/G1CL, OR/G2FL, OR/G2CL, ORV/G1FL, ORV/G1FR, ORV/G2FL, OR/G2CM, TR/G1FL, TR/G1FR, TR/G1CL, TR/G2FL, TR/G2FM, TR/G2CL, TRV/G1FL, TRV/G1FR, TRV/G1CL...(Other models you can see in the webshop) | | |

| | | | |
|---|---|-----------------|------------------|
|  | | | |
| 1 | | | |
| GEV No. | 100387 | Ref. No. | 0A2091 0G2249 |
| description | gas injector thread M10x1 WS 12 bore ø 1.45mm | | |
| For models: | MT/G350, MT/G352, RC/G1, RC/G2, RCV/G2, RCV/G3, RCF/G2, RCF/G3, RCF/M2, RCF/M3, RSF/G2, RSV/G2, RSF/G3, MCF/G2A, MCF/G3A, XC/G1, XC/G2, XCV/G2, XCV/G3, XCF/G2, XCF/G3, XCF/M2, XCFM3, XSF/G2, XSV/G2, XSF/G3, JC/G1, JC/G2, JCV/G2, JCV/G3, JCF/G2, JCF/G3, JCF/M2, JCFM3, MC/G1, MC/G2, MCV/G2, MCV/G3, MCF/G2, MCF/G3, MCF/M2, MCF/M3, MSF/G2, MSV/G2, MSF/G3, RT/G352, RT/G351, XT/G352, PTV/G2, PTF/G2...(Other models you can see in the webshop) | | |

| | | | |
|--|---|-----------------|--------|
|  | | | |
| 1 | | | |
| GEV No. | 100490 | Ref. No. | 056795 |
| description | gas injector thread M10x1 WS 12 bore ø 2.7mm | | |
| For models: | MBR/G710D, MBR/G700, MBR/G700F, MBR/G700UK, RBR/G710D, RBR/G700, RBR/G700F, XBR/G710D, XBR/G700, XBR/G710, XBR/G700F, XBR/G700UK, CBR/G700, RBR/G700, RBR/E700, RBR/G700, HC/G410D, HC/G810D, HCF/G810D, HCF/G1210D, HCF/G1610D, HC/G410NL, HC/G810NL, HCF/G810NL, KS/G2, KSF/G2, KSCF/G3, KMMV/G2C, HT/G800, HT/G800D, HTF/G810, HTF/G800D, HTF/G1210, HTF/G1210D, HT/G800NL, HTF/G800NL, HTFG1210NL, ZC/G410D, ZC/G810D, ZCF/G810D, ZCF/G1210D, ZHCFG1610D, QS/G2, QSF/G2, QSCF/G3, QMV/G2C, ZT/G800, ZT/G800D, ZTF/G810, ZTF/G800D...(Other models you can see in the webshop) | | |

| | | | |
|---|--|-----------------|--------|
|  | | | |
| 1 | | | |
| GEV No. | 100384 | Ref. No. | 056793 |
| description | gas injector thread M10x1 WS 12 bore ø 1.8mm | | |
| For models: | MBR/G710D, MBR/G700, MBR/G700F, MBR/G700UK, RC/G1, RC/G2, RCV/G2, RCV/G3, RCF/G2, RCF/G3, RCF/G9, RCF/M2, RCF/M3, RSF/G2, RSV/G2, RSF/G3, MCF/G2A, MCF/G3A, XC/G1, XC/G2, XCV/G2, XCV/G3, XCF/G2, XCF/G3, XCF/G9, XCF/M2, XCFM3, XSF/G2, XSV/G2, XSF/G3, JC/G1, JC/G2, JCV/G2, JCV/G3, JCF/G2, JCF/G3, JCF/M2, JCFM3, MC/G1, MC/G2, MCV/G2, MCV/G3, MCF/G2, MCF/G3, MCF/G9, MCF/M2, MCF/M3, MSF/G2, MSV/G2, MSF/G3...(Other models you can see in the webshop) | | |



gas components

gas nozzles (other)



1

| | | | |
|--------------------|--|-----------------|--------|
| GEV No. | 100564 | Ref. No. | 025954 |
| description | gas injector bore ø 1.5mm | | |
| For models: | RC/G320, RC/G330, RC/G320F, RC/G720, RC/G730, MCF/G705, MCF/G1055, MCF/G700, MCF/G1050, MCF/G705E, MCF/G1055E, MCF/G705F, MCF/G1055F, MCF/GE705, MCF/GE1055, MCF/GE700, MCF-GE1050, MC/G355, MC/G350, MC/G355E, MC/G355F, MC/G705, MC/G700, MC/G705E, MC/G1055, MC/G1050, MC/G705F, MCF/GE1055UK, MCF/G1090, RCV/G320, RCV/G330, RCV/G320, RCV/G720, RCV/G730, RCV/G720, RCF/G720, RCF/G1020, RCFG730, RCFG1030, RCF/G720F, RCF/G1020, RCF/GE720, RCF/GE730, RCF/GE720, RCF/GE720, RC/G350, RC/G700, RCF/G700, RCF/G1050, RC/G350F...(Other models you can see in the webshop) | | |



2

| | | | |
|--------------------|--|-----------------|--------|
| GEV No. | 100572 | Ref. No. | 025868 |
| description | gas injector bore ø 1.85mm | | |
| For models: | RC/G320, RC/G330, RC/G320F, RC/G720, RC/G730, MCF/G705, MCF/G1055, MCF/G700, MCF/G1050, MCF/G705E, MCF/G1055F, MCF/GE705, MCF/GE1055, MCF/GE700, MCFGE1050, MC/G355, MC/G350, MC/G355F, MC/G705, MC/G700, MC/G1055, MC/G1050, MC/G705F, MCF/GE1055UK, MCF/G1090, MT/G700D, MTF/G700D, MTF/G1050D, MT/G700, MTF/G700, MTF/G1050, MTF/GE1050, MT/G700F, MTF/G700F, MTF/G1055F, MTFGE1055F, MCP/G700, RCV/G320, RCV/G330, RCV/G320, RCV/G720, RCV/G730, RCV/G720, RCF/G720, RCF/G1020, RCFG730, RCFG1030, RCF/G720F, RCF/G1020, RCF/GE720...(Other models you can see in the webshop) | | |



1

| | | | |
|--------------------|--|-----------------|--------|
| GEV No. | 102865 | Ref. No. | 0A2301 |
| description | gas injector bore ø 1.95mm | | |
| For models: | RC/G1, RC/G2, RCV/G2, RCV/G3, RCF/G2, RCF/G3, RCF/G9, RCF/M2, RCF/M3, RSF/G2, RSV/G2, RSF/G3, MCF/G2A, MCF/G3A, XC/G1, XC/G2, XCV/G2, XCV/G3, XCF/G2, XCF/G3, XCF/G9, XCF/M2, XCFM3, XSF/G2, XSV/G2, XSF/G3, JC/G1, JC/G2, JCV/G2, JCV/G3, JCF/G2, JCF/G3, JCF/M2, JCFM3, MC/G1, MC/G2, MCV/G2, MCV/G3, MCF/G2, MCF/G3, MCF/G9, MCF/M2, MCF/M3, MSF/G2, MSV/G2, MSF/G3, PTV/G2, PTF/G2, PSF/G2, PSV/G2...(Other models you can see in the webshop) | | |

pilot burner nozzles

pilot burner nozzles JUNKERS

CB 50203_/503_ series



1

| | | | |
|--------------------|--|-----------------|--------------------------------------|
| GEV No. | 100222 | Ref. No. | OK1126 OK5348 100222 102522 |
| description | pilot burner nozzle LPG gas pressure 50mbar code 5 Qty 1 pcs suitable for JUNKERS CB50203_ | | |

pilot burner nozzles POLIDORO



1

| | | | |
|--------------------|---|-----------------|--------|
| GEV No. | 106859 | Ref. No. | 054286 |
| description | pilot burner nozzle POLIDORO LPG code 24 bore ø 0.24mm Qty 1 pcs | | |
| For models: | BCP/G1, RCP/G1S, RCP/G2D, XCP/G1S, XCP/G2D, JCP/G1S, JCP/G2D, MCP/G1S, MCP/G2D, ACPG25, PCP/G1S, PCP/G2D, OCP/G1S, OCP/G2D, TCP/G1S, TCP/G2D, KP/G2, KMV/G2C, KCP/G1RU, KCP/G2RU, KCP/G1, KCP/G1R, KCP/G2, KCP/G2R, KCP/G1U, KCP/G2U, QP/G2, QMV/G2C, QCP/G1, QCP/G1R, QCP/G2, QCP/G2R, WCP/G1, WCP/G1R, WCP/G2, WCP/G2R, DCP/G400, FCF/G6-0, FCFG101/0, FCFG102-0, FCFG201-0, FCFG202-0, FCFG10160H, FCFG102-0T, FCF/G6-1-JAP, FCF/G101/1-1-JAP, FCF/G102/1-1-JAP, FCF/G101/1, FCFG20, FCFG20D...(Other models you can see in the webshop) | | |





1

| | | | |
|--------------------|--|-----------------|------------------|
| GEV No. | 102699 | Ref. No. | 054037 054038 |
| description | pilot burner nozzle POLIDORO natural gas code 25.2 bore ø 2x0.25mm Qty 1 pcs 2 bores | | |
| For models: | BCP/G1, RMV/G1C, RMV/G2C, RCP/G1S, RCP/G2D, XMV/G1C, XMV/G2C, XCP/G1S, XCP/G2D, JCP/G1S, JCP/G2D, MMV/G1C, MMV/G2C, MCP/G1S, MCP/G2D, ARG12FL, ARG24FL, ARG36FL, ARG48FL, ARG12FR, ARG24FR, ARG36FR, ARG48FR, ACPG25, ARG12FLCE, ARG24FLCE, ARG36FLCE, ARG48FLCE, ARG12FRCE, ARG24FRCE, ARG36FRCE, ARG48FRCE, PCP/G1S, PCP/G2D, OCP/G1S, OCP/G2D, TCP/G1S, TCP/G2D, KP/G2, KMV/G2C, KCP/G1RU, KCP/G2RU, KCP/G1, KCP/G1R, KCP/G2, KCP/G2R, KCP/G1U, KCP/G2U, QP/G2, QMV/G2C...(Other models you can see in the webshop) | | |





| pilot burner nozzles SIT | | | |
|---|--|-----------------|--------|
| 100 series | | | |
|  | | | |
| GEV No. | 100247 | Ref. No. | 056750 |
| description | pilot burner nozzle LPG bore ϕ 0.2mm Qty 1 pcs suitable for SIT 100 series thread M8x0.75 | | |
| For models: | HCSG410, HCS/G410D, HCS/G400, PHCS/G400, HCS/G400F, HCF/G800F, PHCF/G800, HCS/G400NL, HCS/G400DK, HCSG810, HCS/G810D, HCS/G800, HCS/G800F, HCS/G800, HCS/G800NL, HCS/G800DK, HCFG810, HCF/G810D, HCF/GE81, HCF/GE81, HCF/G800, HCF/G800NL, HCF/G800DK, HCF/GE80, HCF/GE80, HCFG1210, HCF/G1210D, HCF/G1200, HCF/G1200F, PHCF/G1200, HCF/G1200NL, HCF/G1200D, HCFG1610, HCF/G1610D, HCF/G1600, HCF/G1600F, PHCF/G1600, HCF/G1600NL, HCF/G1600D, HC/G410, HC/G810, HTF/G1210, HTF/G1210, HTF/G1200, HTF/G1200, HCA/G410, HCA/G810, HCA/G810, HCF/G1210, ZHCF/G161... (Other models you can see in the webshop) | | |

| | | | |
|--|---|-----------------|------------------|
|  | | | |
| GEV No. | 102972 | Ref. No. | 003327 OK1319 |
| description | pilot burner nozzle natural gas code 40 bore ϕ 0.4mm Qty 1 pcs | | |
| For models: | MFR/G740, MFR/G380, MFR/G381, BF/G1S07, BFR/G1S14, RF/G1S07, RF/G2D07, RFR/G1S07, RFR/G2D07, RFR/G2S40, RFR/G1S14, RFR/G2D14, RF/G1S07, RF/G2D07, RFR/G1S07, RFR/G2D07, XF/G1S07, XRF/G2D07, XFR/G1S07, XFR/G2D07, XFR/G2S40, XFR/G1S14, XFR/G2D14, XF/G1S07, XF/G2D07, XFR/G1S07, XFR/G2D07, JF/G1S07, JF/G2D07, JFR/G1S07, JFR/G2D07, JFR/G2S40, JFR/G1S14, JFR/G2D14, JF/G1S07, JF/G2D07, JFR/G2D07, JFR/G2D07, MF/G1S07, MF/G2D07, MFR/G1S07, MFR/G2D07, MFR/G2S40, MFR/G1S14, MFR/G2D14, MF/G1S07, MF/G2D07, MFR/G1S07, MFR/G2D07, RFR/G741... (Other models you can see in the webshop) | | |

| | | | |
|---|--|-----------------|---|
|  | | | |
| GEV No. | 100245 | Ref. No. | 003633 006188 056799 0977030 0G0082 0G2785 0G2786 0G5006 0K2946 0KD857 |
| description | pilot burner nozzle LPG code 20 bore ϕ 0.2mm Qty 1 pcs thread M8x0.75 | | |
| For models: | MBR/G710D, MBR/G700, MBR/G700F, MBR/G700UK, MBR/G701, MBR/G706, MBR/G701UK, MBR/G751, MBR/G756, MFG1500Z, MFG2200Z, FG250D, FG250S, FGC/250D, FGC/250S, RBR/G710D, RBR/G700, RBR/G700F, 7BRG60, 7BRG60X, RBR/G701UK, RBR/G751, RBR/G756, XBR/G710D, XBR/G700, XBR/G710, XBR/G700F, XBR/G700UK, XBR/G701, M70GBP, XBR/G701UK, XBR/G751, XBR/G756, CBR/G700, RBR/G700, RBR/E700, RBR/G700, BR80GZ, PCG810, PCG1210, PCG1610, PCG810F, PCG1210F, PCG1610F, PCG810D, PCG1210D, PCG1610D, PCG800NL, PCG1200NL, PCG1600NL... (Other models you can see in the webshop) | | |

| | | | |
|--|--|-----------------|---------------------------------------|
|  | | | |
| GEV No. | 107171 | Ref. No. | 058330 058753 0977051 0G2234 |
| description | pilot burner nozzle SIT natural/liquid gas bore ϕ 0.25mm Qty 1 pcs | | |
| For models: | MCF/G705, MCF/G1055, MCF/G700, MCF/G1050, MCF/G705E, MCF/G1055E, MCF/G700D, MCF/G700, MCF/G705F, MCF/G1055F, MCF/G705NL, MCF/G1050D, MCFG1055NL, MCF/G702, MCF/G1052, MCF/G700, MCF/G1050, MR/G351, MR/G701, MR/G721, MR/G1071, MR/G350, MR/G350F, MR/G350NL, MR/G350E, MR/G360, MR/G360F, MR/G700, MR/G700F, MR/G700NL, MR/G700E, MR/G710, MR/G710F, MR/G1070, MR/G720, MR/G715, MR/G725, MR/G1075, MR/G361, MR/G711, MR/G716, MR/G726, MR/G1076, MFR/G360, MPN/GD761, MPN/GI761, MPN/GI760D, MPN/GD760, MPN/GD760F, MPN/GI760... (Other models you can see in the webshop) | | |

| | | | |
|---|--|-----------------|--|
|  | | | |
| GEV No. | 100246 | Ref. No. | 02137 056656 056797 0977031 0G0150 0G2787 0K1318 0K2895 0K3558 0K5866 0KW952 0M0833 |
| description | pilot burner nozzle natural gas bore ϕ 0.35mm Qty 1 pcs thread M8x0.75 | | |
| For models: | MCF/G705, MCF/G1055, MCF/G700, MCF/G1050, MCF/G705E, MCF/G1055E, MCF/G700D, MCF/G700, MCF/G705F, MCF/G1055F, MCF/G705NL, MCF/G1050D, MCFG1055NL, MCF/G702, MCF/G1052, MCF/G700, MCF/G1050, MR/G351, MR/G701, MR/G721, MR/G1071, MR/G350, MR/G350F, MR/G350NL, MR/G350E, MR/G360, MR/G360F, MR/G700, MR/G700F, MR/G700NL, MR/G700E, MR/G710, MR/G710F, MR/G1070, MR/G720, MR/G715, MR/G725, MR/G1075, MR/G361, MR/G711, MR/G716, MR/G726, MR/G1076, MBR/G710D, MBR/G700, MBR/G700F, MBR/G700UK, MBR/G701, MBR/G706, MBR/G701UK... (Other models you can see in the webshop) | | |

| 140/150 series | | | |
|--|---|-----------------|---|
|  | | | |
| GEV No. | 100204 | Ref. No. | 003792 004127 059216 0977115 0C3214 0G2263 0G2415 0KT837 |
| description | pilot burner nozzle SIT LPG code 14 bore ϕ 0.18/0.20mm Qty 1 pcs suitable for 140 series | | |
| For models: | BR/G1FL, BR/G1FR, BR/G2FL, BR/G2FR, MT/G350, MT/G352, VO40G, RCF/G9, RBR/G2FM, RBR/G2IM, RBK/G2FM, RMV/G1C, RMV/G2C, RR/G1FL, RR/G1FR, RR/G1CL, RR/G2FL, RR/G2FM, RR/G2CL, RRV/G1FL, RRV/G1FR, RRV/G1CL, RRV/G2FL, RRV/G2FM, RRV/G2CL, RR/G2CM, RTV/G2, RTF/G2, RSF/G2, RSV/G2, RSF/G3, RBV/G2, XCF/G9, XBR/G2FM, XBR/G2IM, XBK/G2FM, XMV/G1C, XMV/G2C, XR/G1FL, XR/G1FR, XR/G1CL, XR/G2FL, XR/G2FM, XR/G2CL, XRV/G1FL, XRV/G1FR, XRV/G1CL, XRV/G2FL, XRV/G2FM, XRV/G2CL... (Other models you can see in the webshop) | | |

| | | | |
|---|---|-----------------|---|
|  | | | |
| GEV No. | 100207 | Ref. No. | 003784 003871 059215 0977113 0G2264 0G2416 |
| description | pilot burner nozzle SIT natural gas code 27 bore ø 0.40/0.38mm suitable for SIT 140 series | | |
| For models: | BR/G1FL, BR/G1FR, BR/G2FL, BR/G2FR, MT/G350, MT/G352, VO40G, RCF/G9, RBR/G2FM, RBR/G2IM, RBK/G2FM, RR/G1FL, RR/G1FR, RR/G1CL, RR/G2FL, RR/G2FM, RR/G2CL, RRV/G1FL, RRV/G1FR, RRV/G1CL, RRV/G2FL, RRV/G2FM, RRV/G2CL, RR/G2CM, RTV/G2, RTF/G2, RSF/G2, RSV/G2, RSF/G3, RBV/G2, XCF/G9, XBR/G2FM, XBR/G2IM, XBK/G2FM, XR/G1FL, XR/G1FR, XR/G1CL, XR/G2FL, XR/G2FM, XR/G2CL, XRV/G1FL, XRV/G1FR, XRV/G1CL, XRV/G2FL, XRV/G2FM, XRV/G2CL, XR/G2CM, XTV/G2, XTF/G2, XSF/G2...(Other models you can see in the webshop) | | |

| | | | |
|---|--|-----------------|--------|
|  | | | |
| GEV No. | 100206 | Ref. No. | 003626 |
| description | pilot burner nozzle SIT natural gas code 36 bore ø 0.60/0.55mm Qty 1 pcs suitable for SIT 150 series | | |
| For models: | FG250D, FG250S, FGC/250D, FGC/250S, CRN22G, CRN/20G, CRN30G, CRN15G, CRN/22GZ, CRN20GZ, CRN30GZ, CRN15GZ, BR80GZ, CRN20GA, CRN30GA, CRN15GA, BR180GZ, BR100GZ, CR42G, CR/40G, CR15G, BR100G, BR80G, BR180G | | |

| | | | |
|---|--|-----------------|--|
| 160 series | | | |
|  | | | |
| GEV No. | 107172 | Ref. No. | 02136 054593 0977123 0A2540 0G2081 0KD989 0M0832 |
| description | pilot burner nozzle SIT LPG code 25 Qty 1 pcs | | |
| For models: | MCP/G1090, MCP/G1095, MCP/G995, BCF/G2, MCP/G700, MCP/G701, MCP/G710, MCP/G711, MCP/G705, MCP/G706, RCF/G2, RCF/G3, RG/G1, RG/G2, RGV/G1, RGV/G2, RTV/G2, RTF/G2, RSF/G2, RSV/G2, RSF/G3, RPD/G240, RPD/G260, RPI/G260, RPI/G260P, MCF/G2A, MCF/G3A, XCF/G2, XCF/G3, XG/G1, XG/G2, XGV/G1, XGV/G2, XTV/G2, XTF/G2, XSF/G2, XSV/G2, XSF/G3, XPD/G240, XPD/G260, XPI/G260, XPI/G260P, JCF/G2, JCF/G3, JG/G1, JG/G2, JGV/G1, JGV/G2, JTV/G2, JTF/G2...(Other models you can see in the webshop) | | |

| | | | |
|---|---|-----------------|------------------|
|  | | | |
| GEV No. | 107650 | Ref. No. | 053667 057388 |
| description | pilot burner nozzle SIT LPG code 30 Qty 1 pcs | | |
| For models: | ACFG24, ACFG36, ACFG24T, ACFG36T, CCF/G996, PPD/G260, PPI/G260P, OPD/G260, OPI/G260P, TPD/G260, TPI/G260P, RF/G350D, RF/G700D, KPI/G10, KPI/G15, KPD/G10, KPD/G15, KPD/G15A, KPI/G15A, KPI/G15H, KPI/G10H, HBR/G800, HBR/G805, HBR/G810, HBR/G815, HBR/G811, HBR/G816, HBR/G800UK, QPI/G10, QPI/G15, QPD/G10, QPD/G15, QPI/G15H, QPI/G10H, ZBR/G800, ZBR/G805, ZBR/G810, ZBR/G815, ZBR/G811, ZBR/G816, ZBR/G800UK, WPI/G10, WPI/G15, WPD/G10, WPD/G15, WPD/G15A, WPI/G15A, WPI/G15H, WPI/G10H, ABR/G800...(Other models you can see in the webshop) | | |

| | | | |
|---|--|-----------------|--|
|  | | | |
| GEV No. | 107174 | Ref. No. | 02135 053670 056635 057389 0977118 0A2409 0G2062 0KT740 0M0831 |
| description | pilot burner nozzle SIT natural gas code 41 Qty 1 pcs | | |
| For models: | MCF/G1090, MCP/G1095, MCP/G995, BCF/G2, MCP/G700, MCP/G701, MCP/G710, MCP/G711, MCP/G705, MCP/G706, RCF/G2, RCF/G3, RG/G1, RG/G2, RGV/G1, RGV/G2, RTV/G2, RTF/G2, RSF/G2, RSV/G2, RSF/G3, RPD/G240, RPD/G260, RPI/G260, RPI/G260P, MCF/G2A, MCF/G3A, XCF/G2, XCF/G3, XG/G1, XG/G2, XGV/G1, XGV/G2, XTV/G2, XTF/G2, XSF/G2, XSV/G2, XSF/G3, XPD/G240, XPD/G260, XPI/G260, XPI/G260P, JCF/G2, JCF/G3, JG/G1, JG/G2, JGV/G1, JGV/G2, JTV/G2, JTF/G2...(Other models you can see in the webshop) | | |

| | | | |
|---|---|-----------------|---|
|  | | | |
| GEV No. | 107175 | Ref. No. | 053668 057521 0977119 0H6361 11061249 |
| description | pilot burner nozzle SIT natural gas code 51 Qty 1 pcs suitable for 160 series | | |
| For models: | RF/G350D, RF/G700D, HBR/G800, HBR/G805, HBR/G810, HBR/G815, HBR/G811, HBR/G816, HBR/G800UK, ZBR/G800, ZBR/G805, ZBR/G810, ZBR/G815, ZBR/G811, ZBR/G816, ZBR/G800UK, ABR/G800, ABR/G805, ABR/G810, ABR/G815, ABR/G811, ABR/G816, OBR/G800UK, FCFG6D, FCFG10, FCFG10D, FCFG6, FCFG6F, PFCFG6, FCFG10J, FCFG10J, FCFG6J, FCFG6J, FCFG6J, FCFG10J, FCFG10J, HBR/G803, HBR/G804, HBR/G803, HBR/G804, HBR/G803, HBR/G1003, HBR/G1003, HBR/G1004, HBR/G1013, FCF/G6, FCFG101, HBR/G803, HBR/G804...(Other models you can see in the webshop) | | |



burner nozzles

| | | | |
|---|---|-----------------|--------|
|  | | | |
| 1 | | | |
| GEV No. | 107935 | Ref. No. | 055388 |
| description | gas injector thread M10x1 bore ø 3.3mm L 30mm WS 12 | | |

chokes

throttle discs

| | | | |
|---|--|-----------------|--------|
|  | | | |
| 1 | | | |
| GEV No. | 107869 | Ref. No. | 0C2444 |
| description | throttle disc for solenoid valve ED ø 18mm ID ø 7.5mm thickness 1mm SS for combi-steamer | | |
| For models: | FCZ101GAG, FCZ102GAG, FCZ201GAG, FCZ202GAG, FCZ101GAD, FCZ102GAD, FCZ201GAD, FCZ202GAD, FCZ101GTG, FCZ102GTG, FCZ201GTG, FCZ202GTG, FCZ101GTD, FCZ102GTD, FCZ201GTD, FCZ202GTD, FCZ101GBG, FCZ102GBG, FCZ201GBG, FCZ202GBG, FCZ101GBD, FCZ102GBD, FCZ201GBD, FCZ202GBD, FCZ101GBI, FCZ201GBI, FCZ101GBG2, FCZ102GBG2, FCZ201GBG2, FCZ202GBG2, FCZ101GBD2, FCZ102GBD2, FCZ201GBD2, FCZ202GBD2, FCZ101GBI2, FCZ102GBI2, FCZ201GBI2, FCZ101GCG, FCZ102GCG, FCZ201GCG, FCZ202GCG, FCZ101GCD, FCZ102GCD, FCZ201GCD, FCZ202GCD, FCZ101GCG2, FCZ102GCG2, FCZ201GCG2, FCZ202GCG2, FCZ101GCD2...(Other models you can see in the webshop) | | |





| | | | |
|---|--|-----------------|--------|
|  | | | |
| 1 | | | |
| GEV No. | 107868 | Ref. No. | 0C1139 |
| description | throttle disc for solenoid valve ED ø 18mm ID ø 7mm thickness 1mm for combi-steamer brass | | |
| For models: | FCZ101GAG, FCZ201GAG, FCZ101GAD, FCZ201GAD, FCZ101GTG, FCZ201GTG, FCZ101GTD, FCZ201GTD, FCZ101GBG, FCZ201GBG, FCZ101GBD, FCZ201GBD, FCZ101GBI, FCZ201GBI, FCZ101GBG2, FCZ201GBG2, FCZ101GBD2, FCZ201GBD2, FCZ101GBI2, FCZ201GBI2, FCZ101GCG, FCZ201GCG, FCZ101GCD, FCZ201GCD, FCZ101GCG2, FCZ201GCG2, FCZ101GCD2, FCZ201GCD2, AOS101GAEU, AOS102GAEU, AOS201GAEU, AOS202GAEU, AOS101GAAU, AOS102GAAU, AOS201GAAU, AOS202GAAU, AOS101GA, AOS101GB, AOS201GA, AOS201GB, AOS102GB, AOS102GA, AOS202GB, AOS202GA, AOS101GAGQ, AOS101GBGQ, AOS201GAGQ, AOS201GBGQ, AOS101GADQ, AOS101GBDQ...(Other models you can see in the webshop) | | |



screw connections



double nipples



| | | | |
|--|--|-----------------|--------|
|  | | | |
| 1 | | | |
| GEV No. | 106518 | Ref. No. | 002716 |
| description | double nipple T1: 1/2" T2: M24x1.5 tube ø 16mm | | |
| For models: | FDV40G, FDV40GZ, FDV40GA, FDV20G, FDV20GZ, FDV20GA, HPN/GI810, HPN/GI815, HPN/GI816, HPN/GD811, HPN/GD816, HPA/GD825, HPA/GI825, HPNS/GI816, HPN/GI806, HPN/GI805, ZPN/GI810, 2PIG15, ZPN/GI816, ZPN/GD811, ZPN/GD816, 2PDAG15, 2PIAG15, ZPNS/GI816, ZPN/GI805, APN/GI810, APN/GI815, APN/GI816, APN/GD811, APN/GD816, APNS/GI816, OPN/GI815, APN/GI805, FCV/G10L3, FCVG10L3T, FCVG102L3, FCV/G20L3, FCVG202L3, FCVG10L3J, FCVG102L3J, FCV/G10L6JAP, FCV/G102/1L6JAP, FCV/G10L2, FCV/G10L6, FCV/G102/1L6, FCV/G20L6, FCVG202L6, FCV/G101/1, FCV/G102/1, FCS101G2...(Other models you can see in the webshop) | | |



olives

| | | | |
|---|---|-----------------|--|
|  | | | |
| 1 | | | |
| GEV No. | 101278 | Ref. No. | 060325 0C0150 0G0794 0G1111 0G2610 0K1976 0KW924 0T1946 101278 |
| description | olive for pipe ø 10mm Qty 1 pcs | | |
| For models: | RC/G320, RC/G330, RC/G320F, RC/G720, RC/G730, MCF/G705, MCF/G1055, MCF/G700, MCF/G1050, MCF/G705E, MCF/G1055E, MCF/G700D, MCF/G700, MCF/G705F, MCF/G1055F, MCF/G705NL, MCF/GE705, MCF/GE1055, MCF/GE700, MCFGE1050, MCF/GE700D, MCFGE1050D, MCF/G1050D, MCFG1055NL, MC/G355, MC/G350, MC/G355E, MC/G350D, MC/G355F, MC/G355NL, MC/G705, MC/G700, MC/G705E, MC/G700D, MC/G705NL, MC/G1055, MC/G1050, MC/G1050D, MC/G1055NL, MC/G705F, MCF/GE1055UK, MCF/G1090, MCF/G1095, MCF/G995, MC/G352, MC/G702, MC/G1052, MCF/G702, MCF/GE702, MCF/G1052...(Other models you can see in the webshop) | | |
| accessories for | 101278 | | |
|  | GEV No. | 100943 | Ref. No. OKL494 100943 |
| union nut thread M17x1 tube ø 10mm | | | |
|  | GEV No. | 101300 | Ref. No. 0A2125 0G2957 |
| union nut thread M16x1.5 tube ø 10mm | | | |
|  | GEV No. | 101478 | Ref. No. — |
| union nut thread 3/8" for pipe ø 10mm | | | |

| | | | |
|--|--|-----------------|---|
|  | | | |
| 1 | | | |
| GEV No. | 101273 | Ref. No. | 027478 050682 058370 0957007 0G2222 0K4315 |
| description | olive for pipe ø 12mm L 9.5mm brass Qty 1 pcs suitable for universal | | |
| accessories for | 101273 | | |
|  | GEV No. | 100944 | Ref. No. — |
| union nut thread M18x1.5 for pipe ø 12mm | | | |
|  | GEV No. | 101276 | Ref. No. — |
| union screw thread 3/8" tube ø 12mm Qty 1 pcs | | | |

| | | | |
|---|--|-----------------|--|
|  | | | |
| 1 | | | |
| GEV No. | 101256 | Ref. No. | 052671 054817 059063 0960 0A2399 |
| description | olive for pipe ø 16mm Qty 1 pcs | | |
| For models: | MFR/G350, MFR/G700, MFR/G350D, MFR/G700D, MFR/G350F, MFR/G700F, MFR/G350E, MFR/G700E, MFR/G350NL, MFR/G700NL, MFR/G740, MFR/G350, MFR/G351, MPN/GD761, MPN/GI761, MPN/GI760D, MPN/GD760, MPN/GD760F, MPN/GI760, MPN/GI760F, FDV40G, FDV40GZ, FDV40GA, FDV20G, FDV20GZ, FDV20GA, RFR/G1S12, RFR/G2D12, RFR/G2S40, XFR/G1S12, XFR/G2D12, XFR/G2S40, JFR/G1S12, JFR/G2D12, JFR/G2S40, MFR/G1S12, MFR/G2D12, MFR/G2S40, RFR/G350, RFR/G700, RFR/G350D, RFR/G700D, RFR/G350F, RFR/G700F, RFR/G741, 7FRG03S, 7PDG06, 7PIG06, RPN/GD760F, RPN/GI760F... (Other models you can see in the webshop) | | |
| accessories for | 101256 | | |
|  | GEV No. | 101253 | Ref. No. 054816 |
| union nut thread M24x1.5 PEL for pipe ø 16mm | | | |



| | | | |
|---|--|-----------------|---------------------------------|
|  | | | |
| 1 | | | |
| GEV No. | 101257 | Ref. No. | 052007 054815 |
| description | olive for pipe ø 20mm Qty 1 pcs | | |
| For models: | MPN/GD761, MPN/GI761, MPN/GI760D, MPN/GD760, MPN/GD760F, MPN/GI760, MPN/GI760F, 7PDG06, 7PIG06, RPN/GD760F, RPN/GI760F, XPN/GI760D, M70GDKE, M70GIKE, XPN/GD760F, XPN/GI760F, RPN/G760, RPN/G760, PRPN/G760, RPN/GI760, RPN/GI760, RPN/GI760, PRPN/GI76, HCF/G810, HC/G410D, HC/G810D, HCF/G810D, HCF/G1210D, HCF/G1610D, HC/G410NL, HC/G810NL, HCF/G810NL, HCF/G1210, HCF/G1610, HCF/GE810, HCF/G810, HCF/G1210, HCF/G1610, HCF/G811, HCF/G800U, HCF/G1200U, HCF/G1600U, HPN/GI810, HPN/GI815, HPN/GI815D, HPN/GI816, HPN/GI816, HPN/GD811, HPN/GD816, HPA/GD825... (Other models you can see in the webshop) | | |
| accessories for | 101257 | | |
|  | GEV No. | 101254 | Ref. No. 054814 09074 |
| union nut thread M28x1.5 tube ø 20mm | | | |

| | | | |
|---|---|-----------------|---|
|  | | | |
| 1 | | | |
| GEV No. | 101246 | Ref. No. | 052127 |
| description | olive for pipe ø 4mm Qty 1 pcs | | |
| For models: | MR/G351, MR/G701, MR/G350, MR/G350F, MR/G350NL, MR/G350E, MR/G360, MR/G360F, MR/G700, MR/G700F, MR/G700NL, MR/G700E, MR/G710, MR/G710F, MR/G715, MR/G361, MR/G711, MR/G716, MPN/GD761, MPN/GI761, MPN/GI760D, MPN/GD760, MPN/GD760F, MPN/GI760, MPN/GI760F, BCF/G2, BF/G1S07, BR/G1FL, BR/G1FR, BR/G2FL, BR/G2FR, BCP/G1, MT/G700D, MTF/G700D, MTF/G1050D, MT/G700, MTF/G700, MTF/G1050, MTF/GE1050, MT/G700F, MTF/G700F, MTF/G1055F, MTFGE1055F, MT/G350, MT/G352, MCP/G700, MCP/G701, MCP/G710, MCP/G711, MCP/G705... (Other models you can see in the webshop) | | |
| accessories for | 101246 | | |
|  | GEV No. | 100908 | Ref. No. 046755 052125 0958013 0G2219 0K1348 0K5753 0KE882 0KL495 |
| union screw thread M10x1 for pipe ø 4mm Qty 1 pcs | | | |

| | | | |
|---|---|-----------------|-----------------------------|
|  | | | |
| 1 | | | |
| GEV No. | 100897 | Ref. No. | 059161 0957009 0G2262 |
| description | olive for pipe ø 4mm Qty 1 pcs for pilot burner | | |
| For models: | BCF/G2, BR/G1FL, BR/G1FR, BR/G2FL, BR/G2FR, MT/G350, MT/G352, RCF/G9, RBR/G2FM, RBR/G2IM, RBK/G2FM, RR/G1FL, RR/G1FR, RR/G1CL, RR/G2FL, RR/G2FM, RR/G2CL, RRV/G1FL, RRV/G1FR, RRV/G1CL, RRV/G2FL, RRV/G2FM, RRV/G2CL, RR/G2CM, RTV/G2, RTF/G2, RSF/G2, RSV/G2, RSF/G3, RBV/G2, XCF/G9, XBR/G2FM, XBR/G2IM, XBK/G2FM, XR/G1FL, XR/G1FR, XR/G1CL, XR/G2FL, XR/G2FM, XR/G2CL, XRV/G1FL, XRV/G1FR, XRV/G1CL, XRV/G2FL, XRV/G2FM, XRV/G2CL, XR/G2CM, XTV/G2, XTF/G2, XSF/G2... (Other models you can see in the webshop) | | |



| | | | |
|---|---|-----------------|-----------------------------|
|  | | | |
| 1 | | | |
| GEV No. | 100870 | Ref. No. | 053665 0957014 0G2291 |
| description | olive for pipe ø 4mm Qty 1 pcs suitable for 160 series for pilot burner | | |
| For models: | MCF/G1090, MCF/G1095, MCF/G995, BCP/G1, MCP/G700, MCP/G701, MCP/G710, MCP/G711, MCP/G705, MCP/G706, RCF/G2, RCF/G3, RMV/G1C, RMV/G2C, RG/G1, RG/G2, RGV/G1, RGV/G2, RTF/G2, RSF/G2, RSV/G2, RSF/G3, RPD/G240, RPD/G260, RPI/G260, RPI/G260P, RCP/G1S, RCP/G2D, MCF/G2A, MCF/G3A, XCF/G2, XCF/G3, XG/G1, XG/G2, XGV/G1, XGV/G2, XTF/G2, XSF/G2, XSV/G2, XSF/G3, XPD/G240, XPD/G260, XPI/G260, XPI/G260P, XCP/G1S, XCP/G2D, JCF/G2, JCF/G3, JG/G1, JG/G2... (Other models you can see in the webshop) | | |



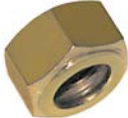

| | | | |
|---|--|-----------------|--------|
|  <p>1</p> | | | |
| GEV No. | 100898 | Ref. No. | 003863 |
| description | olive for pipe ø 6mm Qty 1 pcs for pilot burner | | |
| For models: | CRN22G, CRN/20G, CRN30G, CRN15G, HCPA/G1219, HCPA/GI 1219, CR22G, CRN/22GZ, CRN20GZ, CRN30GZ, CRN15GZ, ZCPAG1219, ZCPA/GI 1219, CR22G, CRN20GA, CRN30GA, CRN15GA, CR42G, CR/40G, CR15G, CR/41G, CR42G, CR40G | | |
| accessories for | 100898 | | |
|  <p>GEV No. 100909 Ref. No. 003859 057821</p> <p>union screw thread M10x1 for pipe ø 6mm Qty 1 pcs</p> | | | |

union nuts

| | | | |
|--|---|-----------------|----------------------------|
|  <p>1</p> | | | |
| GEV No. | 101346 | Ref. No. | 025001 025902 0G0838 |
| description | union nut nozzle holder | | |
| For models: | RC/G320, RC/G330, RC/G320F, RC/G720, RC/G730, MCF/G705, MCF/G1055, MCF/G700, MCF/G1050, MCF/G705E, MCF/G1055E, MCF/G700D, MCF/G700, MCF/G705F, MCF/G1055F, MCF/G705NL, MCF/GE705, MCF/GE1055, MCF/GE700, MCFGE1050, MCF/GE700D, MCFGE1050D, MCF/G1050D, MCFG1055NL, MC/G355, MC/G350, MC/G355E, MC/G350D, MC/G355F, MC/G355NL, MC/G705, MC/G700, MC/G705E, MC/G700D, MC/G705NL, MC/G1055, MC/G1050, MC/G1050D, MC/G1055NL, MC/G705F, MCF/GE1055UK, MCF/G1090, MCF/G1095, MCF/G995, MC/G352, MC/G702, MC/G1052, MCF/G702, MCF/GE702, MCF/G1052...(Other models you can see in the webshop) | | |

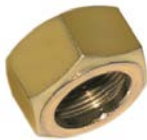
| | | | |
|--|---|-----------------|--------|
|  <p>1</p> | | | |
| GEV No. | 101253 | Ref. No. | 054816 |
| description | union nut thread M24x1.5 PEL for pipe ø 16mm | | |
| For models: | MPN/GD761, MPN/GI761, MPN/GI760D, MPN/GD760, MPN/GD760F, MPN/GI760, MPN/GI760F, FDV40G, FDV40GZ, FDV40GA, FDV20G, FDV20GZ, FDV20GA, 7PDG06, 7PIG06, RPN/GD760F, RPN/GI760F, XPN/GI760D, M70GDKE, M70GIKE, XPN/GD760F, XPN/GI760F, RPN/G760, RPN/G760, PRPN/G760, RPN/GI760, RPN/GI760, RPN/GI760, PRPN/GI76, HPN/GI810, HPN/GI815, HPN/GI815D, HPN/GI816, HPN/GI816, HPN/GD811, HPN/GD816, HPA/GD825, HPA/GI825, HPNS/GI816, HPN/GI806, HPN/GI805, ZPN/GI810, 2PIG15, ZPN/GI816, ZPN/GI816D, ZPN/GD811, ZPN/GD816, 2PDAG15, 2PIAG15, ZPNS/GI816...(Other models you can see in the webshop) | | |
| accessories for | 101253 | | |
|  <p>GEV No. 101256 Ref. No. 052671 054817 059063 0960 0A2399</p> <p>olive for pipe ø 16mm Qty 1 pcs</p> | | | |

| | | | |
|---|--|-----------------|-----------------|
|  <p>1</p> | | | |
| GEV No. | 101254 | Ref. No. | 054814 09074 |
| description | union nut thread M28x1.5 tube ø 20mm | | |
| For models: | MPN/GD761, MPN/GI761, MPN/GI760D, MPN/GD760, MPN/GD760F, MPN/GI760, MPN/GI760F, 7PDG06, 7PIG06, RPN/GD760F, RPN/GI760F, XPN/GI760D, M70GDKE, M70GIKE, XPN/GD760F, XPN/GI760F, RPN/G760, RPN/G760, PRPN/G760, RPN/GI760, RPN/GI760, RPN/GI760, PRPN/GI76, HPN/GI810, HPN/GI815, HPN/GI815D, HPN/GI816, HPN/GI816, HPN/GD811, HPN/GD816, HPA/GD825, HPA/GI825, HPNS/GI816, HPN/GI806, HPN/GI805, HCPA/G1219, HCPA/GI 1219, ZPN/GI810, 2PIG15, ZPN/GI816, ZPN/GI816D, ZPN/GD811, ZPN/GD816, 2PDAG15, 2PIAG15, ZPNS/GI816, ZPN/GI805, ZCPAG1219, ZCPA/GI 1219, APN/GI810...(Other models you can see in the webshop) | | |
| accessories for | 101254 | | |
|  <p>GEV No. 101257 Ref. No. 052007 054815</p> <p>olive for pipe ø 20mm Qty 1 pcs</p> | | | |

union screws

| | | | |
|--|---|-----------------|--------------------------------------|
|  <p>1</p> | | | |
| GEV No. | 100904 | Ref. No. | 052833 0K2497 100904 102504 |
| description | locking screw M10x1 for pipe ø 4mm Qty 1 pcs | | |
| For models: | MCF/G705, MCF/G1055, MCF/G700, MCF/G1050, MCF/G705E, MCF/G1055E, MCF/G700D, MCF/G700, MCF/G705F, MCF/G1055F, MCF/G705NL, MCF/G1050D, MCFG1055NL, MCF/G1090, MCF/G1095, MCF/G995, MCF/G702, MCF/G1052, MCF/G700, MCF/G1050, MFR/G350, MFR/G700, MFR/G350D, MFR/G700D, MFR/G360, MFR/G350F, MFR/G700F, MFR/G350E, MFR/G700E, MFR/G350NL, MFR/G700NL, MTF/G700D, MTF/G1050D, MTF/G700, MTF/G1050, MTF/GE1050, MF/G700, MG/G350D, MG/G700D, MG/G350, MG/G350E, MG/G350F, MG/G350NL, MG/G700, MG/G700E, MG/G700F, MG/G700NL, MG/G1050, MG/G1050F, MG/G1051...(Other models you can see in the webshop) | | |





| | | | |
|--|--|-----------------|-------------------|
|  <p>1</p> | | | |
| GEV No. | 100905 | Ref. No. | 052834 0958031 |
| description | locking screw M10x1 for pipe ø 6mm Qty 1 pcs | | |
| For models: | MBR/G710D, MBR/G700, MBR/G700F, MBR/G700UK, MBR/G701, MBR/G706, MBR/G701UK, MBR/G751, MBR/G756, MM/G351, MM/G701, MM/G350, MM/G700, MM/G350F, MM/G700F, MM/G700E, RBR/G710D, RBR/G700, RBR/G700F, 7BRG60, 7BRG60X, RBR/G701UK, RBR/G751, RBR/G756, RM/G350D, RM/G700D, 7BMG03T, 7BMG07T, RM/G350F, RM/G700F, XBR/G710D, XBR/G700, XBR/G710, XBR/G700F, XBR/G700UK, XBR/G701, M70GBP, XBR/G701UK, XBR/G751, XBR/G756, CBR/G700, XM/G350D, XM/G700D, T35GBM, T70GBM, XM/G350F, XM/G700F, CM/G700, RMG300, RM/G300D...(Other models you can see in the webshop) | | |



gas components

| | | | |
|---|---|-----------------|---|
|  | | | |
| 1 | | | |
| GEV No. | 100906 | Ref. No. | 003610 056641 057960 0974037 0G2227 0K5791 11061230 |
| description | screw connection thread M10x1 for ignition electrode brass Qty 1 pcs WS 10 | | |
| For models: | MCF/G1090, MCF/G1095, MCF/G995, MFR/G350, MFR/G700, MFR/G350D, MFR/G700D, MFR/G350F, MFR/G700F, MFR/G350E, MFR/G700E, MFR/G350NL, MFR/G700NL, MFR/G740, MFR/G380, MFR/G381, MFR/G350, MFR/G351, MFR/G700, MFR/G701, BCF/G2, BF/G1S07, BFR/G1S14, BR/G1FL, BR/G1FR, BR/G2FL, BR/G2FR, BCP/G1, MT/G350, MT/G352, MCP/G700, MCP/G701, MCP/G710, MCP/G711, MCP/G705, MCP/G706, VO40G, RCF/G2, RCF/G3, RCF/G9, RBR/G2FM, RBR/G2IM, RBK/G2FM, RMV/G1C, RMV/G2C, RF/G1S07, RF/G2D07, RFR/G1S07, RFR/G2D07, RFR/G1S12...(Other models you can see in the webshop) | | |

| | | | |
|---|---|-----------------|---|
|  | | | |
| 1 | | | |
| GEV No. | 100908 | Ref. No. | 046755 052125 0958013 0G2219 0K1348 0K5753 0KE882 0KL495 |
| description | union screw thread M10x1 for pipe ø 4mm Qty 1 pcs | | |
| For models: | MCF/G1090, MCF/G1095, MCF/G995, MR/G351, MR/G701, MR/G350, MR/G350F, MR/G350NL, MR/G350E, MR/G360, MR/G360F, MR/G700, MR/G700F, MR/G700NL, MR/G700E, MR/G710, MR/G710F, MR/G715, MR/G361, MR/G711, MR/G716, MPN/GD761, MPN/GI761, MPN/GI760D, MPN/GD760, MPN/GD760F, MPN/GI760, MPN/GI760F, BCF/G2, BF/G1S07, BR/G1FL, BR/G1FR, BR/G2FL, BR/G2FR, BCP/G1, MT/G700D, MTF/G700D, MTF/G1050D, MT/G700, MTF/G700, MTF/G1050, MTF/GE1050, MT/G700F, MTF/G700F, MTF/G1055F, MTF/GE1055F, MT/G350, MT/G352, MCP/G700, MCP/G701...(Other models you can see in the webshop) | | |

| | | | |
|---|---|-----------------|------------------------------|
|  | | | |
| 1 | | | |
| GEV No. | 100907 | Ref. No. | 003609 0C0121 11061236 |
| description | screw connection thread M10x1 Qty 1 pcs type SEF 1 ømm for thermocouple | | |
| For models: | BCF/G2, VO40G, ACFG24, ACFG36, ASG36, ACFG24T, ACFG36T, PC/G1, PC/G2, PCV/G2, PCV/G3, PCF/G2, PCF/G3, PCF/G9, PCF/M2, PCF/M3, PCF/M2E5, PTV/G2, PTF/G2, PSF/G2, PSV/G2, PSF/G3, PGV/G1, PGV/G2, PCV/G2N, PCF/G3N, PC/G2HV, PCV/G3N, PCF/G2N, PC/G1HV, PGV/G1HV, PTV/G2N, PGV/G2HV, PC/G1A, PC/G2A, PCV/G2A, PCV/G3A, PCF/G2A, PCF/G3A, PCF/M2A, PCF/M3A, OC/G1, OC/G2, OCV/G2, OCF/G2, OCF/G3, OCF/M2, OCF/G9UK, OTV/G2, OTF/G2...(Other models you can see in the webshop) | | |

| | | | | |
|---|---|--------|-----------------|-----------------------------|
| accessories for | 100908 | | | |
|  | GEV No. | 100897 | Ref. No. | 059161 0957009 0G2262 |
| | olive for pipe ø 4mm Qty 1 pcs for pilot burner | | | |
|  | GEV No. | 101246 | Ref. No. | 052127 |
| | olive for pipe ø 4mm Qty 1 pcs | | | |
|  | GEV No. | 101280 | Ref. No. | — |
| | olive for pipe ø 4mm Qty 1 pcs | | | |
|  | GEV No. | 101282 | Ref. No. | — |
| | olive for pipe ø 4mm L 7.4mm Qty 1 pcs | | | |

| | | | | |
|---|---|-----------------|-----------------|---|
|  | | | | |
| 1 | | | | |
| GEV No. | 101275 | Ref. No. | 052668 | |
| description | union screw thread 1/2" for pipe ø 16mm Qty 1 pcs | | | |
| For models: | MFR/G350, MFR/G700, MFR/G350D, MFR/G700D, MFR/G350F, MFR/G700F, MFR/G350E, MFR/G700E, MFR/G350NL, MFR/G700NL, MFR/G740, MFR/G350, MFR/G351, RFR/G1S12, RFR/G2D12, RFR/G2S40, XFR/G1S12, XFR/G2D12, XFR/G2S40, JFR/G1S12, JFR/G2D12, JFR/G2S40, MFR/G1S12, MFR/G2D12, MFR/G2S40, RFR/G350, RFR/G700, RFR/G350D, RFR/G700D, RFR/G350F, RFR/G700F, RFR/G741, 7FRG03S, M35GFR, M70GFR, XFR/G350D, XFR/G700D, XFR/G350F, XFR/G700F, XFR/G350NL, XFR/G700NL, XFR/G351, CFR/G741, M35GFR, M70GFR, CFR/G351, CFR/G700, CFR/G351, CFR/G701, RFR/G300...(Other models you can see in the webshop) | | | |
| accessories for | 101275 | | | |
|  | GEV No. | 101274 | Ref. No. | — |
| | olive for pipe ø 16mm Qty 1 pcs | | | |





| | | | | |
|---|---|-----------------|------------------|------------------|
|  | | | | |
| 1 | | | | |
| GEV No. | 100909 | Ref. No. | 003859 057821 | |
| description | union screw thread M10x1 for pipe ø 6mm Qty 1 pcs | | | |
| For models: | CRN22G, CRN/20G, CRN30G, CRN15G, HCPA/G1219, HCPA/GI 1219, CR22G, CRN/22GZ, CRN20GZ, CRN30GZ, CRN15GZ, ZCPAG1219, ZCPA/GI 1219, CR22G, BR80GZ, CRN20GA, CRN30GA, CRN15GA, BR180GZ, BR100GZ, CR42G, CR/40G, CR15G, CR/41G, CR42G, CR40G, BR100G, BR80G, BR180G, ROCF/G1000, ROTF/G1000, ROSD/G1000, ROSF/G1000, RORA/G500, RORA/G1000, ROR/G500, ROR/G1000 | | | |
| accessories for | 100909 | | | |
|  | GEV No. | 100898 | Ref. No. | 003863 |
| | olive for pipe ø 6mm Qty 1 pcs for pilot burner | | | |
|  | GEV No. | 101286 | Ref. No. | 020992 053666 |
| | olive ID ø 6mm Qty 1 pcs | | | |
|  | GEV No. | 101287 | Ref. No. | — |
| | olive for pipe ø 6mm Qty 1 pcs | | | |

Table continues overleaf



| | | | |
|---|---------|--------|------------|
| accessories for | | 100909 | |
|  | GEV No. | 101288 | Ref. No. — |
| olive for pipe ø 6mm L 6mm aluminium Qty 1 pcs ED ø 8.5mm | | | |

gas lines

pilot tubes

universal



| | | | |
|----------------|--------|-----------------|--|
| GEV No. | 102110 | Ref. No. | 006249 054810 0C0152 0C0153 0C0626 0C1547 |
|----------------|--------|-----------------|--|

description pilot tube copper pipe ø 4mm thickness 1mm L 3000mm

For models: PC/G1, PC/G2, PCV/G2, PCV/G3, PCF/G2, PCF/G3, PCF/M2, PCF/M3, PCF/M2E5, PTV/G2, PTF/G2, PSF/G2, PSV/G2, PSF/G3, PCV/G2N, PCF/G3N, PC/G2HV, PCV/G3N, PCF/G2N, PC/G1HV, PTV/G2N, PCV/G2A, PCV/G3A, PCF/G2A, PCF/G3A, OC/G1, OC/G2, OCV/G2, OCF/G2, OCF/G3, OCF/M2, OTV/G2, OTF/G2, OSF/G2, OSV/G2, TCV/G2, TCV/G3, TCF/G2, TCF/G3, TTF/G2, TSF/G2, TSF/G3, TCV/G2A, TCV/G3A, TCF/G2A, TCF/G3A, RPN/G760, RPN/G760, PRPN/G760, KC/G1...(Other models you can see in the webshop)

| | | | |
|---|---------|--------|--|
| accessories for | | 102110 | |
|  | GEV No. | 100908 | Ref. No. 046755 052125 0958013 0G2219 0K1348 0K5753 0KE882 0KL495 |
| union screw thread M10x1 for pipe ø 4mm Qty 1 pcs | | | |

| | | | |
|---|---------|--------|-----------------|
|  | GEV No. | 101246 | Ref. No. 052127 |
| olive for pipe ø 4mm Qty 1 pcs | | | |

gas hoses

CE approval to DIN 3383-1 EN 14800



| | | | |
|--|--------|-----------------|--------|
| GEV No. | 250065 | Ref. No. | 0S1006 |
| description gas hose L 1000mm 1/2" IT - 1/2" ET braided EN 14800 DN12 | | | |



| | | | |
|--|--------|-----------------|--------|
| GEV No. | 250067 | Ref. No. | 0S1007 |
| description gas hose L 1500mm 1/2" IT - 1/2" ET braided EN 14800 DN12 | | | |



| | | | |
|--|--------|-----------------|--------|
| GEV No. | 250069 | Ref. No. | 0S1015 |
| description gas hose L 2000mm 1/2" IT - 1/2" ET braided EN 14800 DN12 | | | |

| | | | | |
|---|----------------|--------|-----------------|--------|
| 1 | GEV No. | 250063 | Ref. No. | 0S1025 |
| description gas hose L 500mm 1/2" IT - 1/2" ET braided EN 14800 DN12 | | | | |

| | | | | |
|--|----------------|--------|-----------------|--------|
| 1 | GEV No. | 250056 | Ref. No. | 0S1005 |
| description gas hose L 1000mm 1/2" IT - 1/2" IT braided EN 14800 DN12 | | | | |

| | | | | |
|--|----------------|--------|-----------------|--------|
| 1 | GEV No. | 250057 | Ref. No. | 0S1008 |
| description gas hose L 1500mm 1/2" IT - 1/2" IT braided EN 14800 DN12 | | | | |

| | | | | |
|--|----------------|--------|-----------------|--------|
| 1 | GEV No. | 250058 | Ref. No. | 0S1003 |
| description gas hose L 2000mm 1/2" IT - 1/2" IT braided EN 14800 DN12 | | | | |

| | | | | |
|---|----------------|--------|-----------------|--------|
| 1 | GEV No. | 250059 | Ref. No. | 0S1026 |
| description gas hose L 500mm 1/2" IT - 1/2" IT braided EN 14800 DN12 | | | | |

pressure switches



| | | | |
|----------------|--------|-----------------|-----------------------------|
| GEV No. | 541073 | Ref. No. | 002635 0360001 0K2021 |
|----------------|--------|-----------------|-----------------------------|

description pressure control ø 45mm pressure range adjustable 5-20mbar pressure connection vertical gas technology connection 1/4" pressure connection ø 1/4"mm

For models: FCV/G10L3, FCVG10L3T, FCVG102L3, FCVG10L3J, FCVG102L3J, FCV/G10L6JAP, FCV/G102/1L6JAP, FCVG6L3CJ, FCV/G10L2, FCV/G6L3C, FCV/G61/1, FCV/G61/1, FCV/G61/1, FCV/G61/1, FCVG6L3CT, FCVG6L3CJ, FCV/G6L4, FCV/G10L6, FCV/G102/1L6, FCV/G101/1, FCV/G102/1, FCS061G48J, FCS061GP, FCS061G3DI, FCS061G4, FCS061G4DT, FCS061G49J, FCS101G2, FCS101G4, FCS101G4DT, FCS101GP9J, FCS101G49J, FCS101GP, FCS102G4, FCS102G49J, FCS102G49J, FCS102GP, FCS101GX9J, FCS101GX, FCS102GX9J, FCS102GX, 5721-2-7, 5721-2-10, ECV/G6T4, ECV/G10T4, ECVG102T4, ECV/G6T4C, ECV/G10T4J, ECV/G61/1, ECV/G61/1...(Other models you can see in the webshop)

2 gas components



| | | | |
|---|--|-----------------|-----------------------|
|  | | | |
| 1 | | | |
| GEV No. | 541867 | Ref. No. | 003772 C6065A1275B |
| description | pressure control ø 80mm reset pressure 0.42bar triggering pressure 0.78mbar connection 7.5/10.5mm 250V voltage AC 1CO pressure connection ø 7.5-10.5mm | | |
| For models: | FDV40G, FDV40GZ, FDV40GA, FDV20G, FDV20GZ, FDV20GA, FCV/G10L3, FCVG10L3T, FCVG102L3, FCV/G20L3, FCVG202L3, FCVG10L3J, FCVG102L3J, FCV/G10L6JAP, FCV/G102/1L6JAP, FCV/G10L2, FCV/G10L6, FCV/G102/1L6, FCV/G20L6, FCVG202L6, FCV/G101/1, FCV/G102/1, FCS101G2, FCS101G4, FCS101G4DT, FCS101GP9J, FCS101G49J, FCS101GP, FCS102G4, FCS102GA9J, FCS102G49J, FCS102GP, FCS101GX9J, FCS101GX, FCS102GX9J, FCS102GX, 5712-2-6, 5712-2-7, 5712-2-8, 5712-2-10, 5714-2-6, 5714-2-7, 5714-2-8, 5714-2-10, 5717-2-6, 5714-2-7, 5714-2-8, 5714-2-10, 5712-2-6L, 5712-2-7L...(Other models you can see in the webshop) | | |

| | | | |
|---|---|-----------------|-------------------|
|  | | | |
| 1 | | | |
| GEV No. | 541446 | Ref. No. | 005029 0360002 |
| description | pressure control pressure range 10-50mbar connection 1/4" | | |
| For models: | FDV40G, FDV40GZ, FDV40GA, FDV20G, FDV20GZ, FDV20GA, FCV/G20L3, FCVG202L3, FCV/G20L6, FCVG202L6, FCV/G201/1, FCV/G202/1, FCS201G4, FCS201GP, FCS202G4, FCS201GX, 5711-2-6, 5711-2-7, 5711-2-8, 5711-2-10, 5711-2-8CH, 5711-2-10CH, 5712-2-6, 5712-2-7, 5712-2-8, 5712-2-10, 5714-2-6, 5714-2-7, 5714-2-8, 5714-2-10, 5717-2-6, 5714-2-7, 5714-2-8, 5714-2-10, 5711-2-6L, 5711-2-7L, 5711-2-8L, 5711-2-10L, 5712-2-6L, 5712-2-7L, 5712-2-8L, 5712-2-10L, 5714-2-6L, 5714-2-7L, 5714-2-8L, 5714-2-10L, 5714-2-6L, 5714-2-7L, 5714-2-8L, 5714-2-10L...(Other models you can see in the webshop) | | |

| | | | |
|---|---|-----------------|--------|
|  | | | |
| 1 | | | |
| GEV No. | 541797 | Ref. No. | 006536 |
| description | pressure control triggering pressure 0.5mbar pressure range 0.8/0.6mbar pressure connection horizontal gas technology connection 6mm 250V | | |
| For models: | FCV/G20L3, FCVG202L3, FCV/G20L6, FCVG202L6, FCV/G201/1, FCV/G202/1, FCS201G4, FCS201GP, FCS202G4, FCS202GP, FCS201GX, FCS202GX, ECV/G20T4, ECVG202T4, ECV/G20T4J, ECV/G20T6, ECVG202T6, ACV/G20C4, ACVG202C4, ACVG202C6 | | |

| | | | |
|---|---|-----------------|-------------------|
|  | | | |
| 1 | | | |
| GEV No. | 541352 | Ref. No. | 005746 0380072 |
| description | pressure control triggering pressure 1.5mbar reset pressure 1.2mbar pressure range 1.5/1.2mbar pressure connection horizontal gas technology connection 6mm suitable for ZANUSSI | | |
| For models: | FCVG6L3CJ, FCV/G6L3C, FCV/G61/1, FCV/G61/1, FCV/G61/1, FCV/G61/1, FCVG6L3CT, FCVG6L3CJ, FCS061G48J, FCS061GP, FCS061G3DI, FCS061G4, FCS061G4DT, FCS061G49J, 5721-2-7, 5721-2-10, ECV/G6T4C, ECV/G61/1, ECV/G61/1, RCV061G2, ACV/G6C3C, ZCV/G6T4C, ZCV/G61/1 | | |

equipmentspecific units for convection ovens/combi-steamers

drain valves

| | | | |
|--|--|-----------------|--------|
|  | | | |
| 1 | | | |
| GEV No. | 698499 | Ref. No. | 006309 |
| description | drain fitting ø 24.5mm H 60mm ED ø 59mm for pot | | |
| For models: | FCZ201EAA, FCZ202EAA, FCZ201EAH, FCZ201EAN, FCZ201ETA, FCZ202ETA, FCZ201ETH, FCZ201ETN, FCZ201GAG, FCZ202GAG, FCZ201GAD, FCZ202GAD, FCZ201GTG, FCZ202GTG, FCZ201GTD, FCZ202GTD, FCZ201EBA, FCZ202EBA, FCZ201EBH, FCZ201EBN, FCZ201EBC, FCZ201EBA2, FCZ202EBA2, FCZ201EBH2, FCZ201EBN2, FCZ201EBC2, FCZ201GBG, FCZ202GBG, FCZ201GBD, FCZ202GBD, FCZ201GBI, FCZ201GBG2, FCZ202GBG2, FCZ201GBD2, FCZ202GBD2, FCZ201GBI2, FCZ201ECA, FCZ202ECA, FCZ201ECH, FCZ201ECN, FCZ201ECA2, FCZ202ECA2, FCZ201ECH2, FCZ201ECN2, FCZ201GCG, FCZ202GCG, FCZ201GCD, FCZ202GCD, FCZ201GCG2, FCZ202GCG2...(Other models you can see in the webshop) | | |

bushes

| | | | |
|---|--|-----------------|--------|
|  | | | |
| 1 | | | |
| GEV No. | 699446 | Ref. No. | 0C4467 |
| description | bushing ID ø 10mm ED ø 15mm L 14mm | | |
| For models: | FCZ061EAA, FCZ101EAA, FCZ102EAA, FCZ061EAH, FCZ101EAH, FCZ061EAN, FCZ101EAN, FCZ061ETA, FCZ101ETA, FCZ102ETA, FCZ201ETA, FCZ202ETA, FCZ061ETH, FCZ101ETH, FCZ201ETH, FCZ061ETN, FCZ101ETN, FCZ201ETN, FCZ061GAG, FCZ061GAD, FCZ101GTG, FCZ102GTG, FCZ201GTG, FCZ202GTG, FCZ101GTD, FCZ102GTD, FCZ201GTD, FCZ202GTD, FCZ061EBA, FCZ101EBA, FCZ102EBA, FCZ061EBH, FCZ101EBH, FCZ061EBN, FCZ101EBN, FCZ061EBC, FCZ101EBC, FCZ201EBC, FCZ061EBA2, FCZ101EBA2, FCZ102EBA2, FCZ201EBA2, FCZ202EBA2, FCZ061EBH2, FCZ101EBH2, FCZ201EBH2, FCZ061EBN2, FCZ101EBN2, FCZ201EBN2, FCZ061EBC2...(Other models you can see in the webshop) | | |

| | | | |
|---|--|-----------------|--------|
|  | | | |
| 1 | | | |
| GEV No. | 699447 | Ref. No. | 0C1560 |
| description | guide bushing ID ø 15.5mm L 17.5mm WS 27 | | |
| For models: | FCS061GP, FCS061EP, FCS101EP4J, FCS101EP, FCS101GP9J, FCS102EP4J, FCS101GP, FCS102EP, FCS102GA9J, FCS201EP, FCS102GP, FCS202EP, FCS202GP, FCS061EXLN, FCS061EX, FCS101EX4J, FCS101EXLN, FCS101EX, FCS102EX4J, FCS102EX, FCS201EX, FCS201EXLN, FCS202EX, FCS101GX9J, FCS101GX, FCS102GX9J, FCS102GX, FCS201GX, FCS202GX | | |



steam generators

steam generators



| | | | |
|--------------------|--|-----------------|------------------|
| GEV No. | 694312 | Ref. No. | 005234 OK0680 |
| description | steam generator L 615mm W 100mm H 425mm | | |
| For models: | FDV40E, FDV40EL, FCV/E20L3, FCVE202L3, FCV/E20L6, FCVE202L6, FVC/E201/1, FVC/E202/1, FCS201E4, FCS201EP, FCS202E4, FCS202EP, FCS201EX, FCS201EXLN, FCS202EX, 5714-3-7, 5714-3-8, 5714-3-8E, 5714-3-10, 5717-3-7, 5717-3-8, 5717-3-8E, 5717-3-10, 5717-3-8M, 5717-3-8C, 5717-3-8M, 5714-3-10F, 5714-3-10S, ECV/E20T4, ECVE202T4, ECV/E20T6, ECVE202T6, ACV/E20C4, ACVE202C4, ACVE20C6, ACV/E202/1, ZCV/E20T4, ZCV/E202/1, ZCV/E20T6, ZCV/E202/1 | | |



| | | | |
|--------------------|--|-----------------|--------|
| GEV No. | 692775 | Ref. No. | OKB717 |
| description | steam generator with gasket L 250mm W 25mm H 25mm 230V connection F6.3x0.8 | | |

injection nozzles



| | | | |
|--------------------|--|-----------------|--------|
| GEV No. | 692181 | Ref. No. | 053800 |
| description | injection nozzle D1 ø 12.5mm D2 ø 15mm L 10mm brass | | |
| For models: | FCFG6D, FCFE6D, FCFE6D, FCFG10, FCFG10D, FCFG10NL, FCFE10, FCFE10UK, FCFG20, FCFG20D, FCFG20F, PFCFG20, FCFE20, FCFE20UK, FCFG6, FCFG6F, PFCFG6, FCFE6, FCFE6UK, PFCFE6, FCF/G6, FCFG101, FCFG201, FCF/E6, FCF/E10, FCF/E20, FF/G6, FF/E10, FF/G10, FF/E20, FF/G20, COCO10G, COCO10E, COCO20G, COCO20E, COCO6G, COCO6E, COCVE423AF, FCFE061, FCFE101, FCFE201, ZOFCE/G10D, ZOFCE/G6D, ZOFCE/G20D | | |

injection pipes



| | | | |
|--------------------|---|-----------------|--------|
| GEV No. | 692772 | Ref. No. | OC0443 |
| description | injection pipe for combi-steamer curved ED ø 10mm ID ø 7mm L 375mm W 85mm copper suitable for ELECTROLUX, ZANUSSI | | |
| For models: | FCF/G6-1-JAP, FCFE6-1J | | |

spare parts and accessories



| | | | |
|--------------------|---|-----------------|--------|
| GEV No. | 690869 | Ref. No. | 003825 |
| description | bar L 440mm | | |
| For models: | FDV40G, FDV40E, FDV40GZ, FDV40EL, FDV40GA, FDV20G, FDV20E, FDV20GZ, FDV20EL, FDV20GA, FCFG201-0, FCFG202-0, FCFE201-0, FCFE202-0, FCF201ENS, ECFG201-0, ECFG202-0, ECFE201-0, ECFE202-0, ECF201ENS, ACFG201-0, ACFG202-0, ACFE201-0, ACFE202-0, RCF201E, ZCF/G201/1, ZCF/G202/1, ZCF/E201/1-0, ZCF/E202/1-0 | | |



| | | | |
|--------------------|--|-----------------|--------|
| GEV No. | 698497 | Ref. No. | 006976 |
| description | bumper H 16mm ext. ø 25 suitable for ELECTROLUX | | |
| For models: | FCZ061EAA, FCZ101EAA, FCZ102EAA, FCZ201EAA, FCZ202EAA, FCZ061EAH, FCZ101EAH, FCZ201EAH, FCZ061EAN, FCZ101EAN, FCZ201EAN, FCZ061ETA, FCZ101ETA, FCZ102ETA, FCZ201ETA, FCZ202ETA, FCZ061ETH, FCZ101ETH, FCZ201ETH, FCZ061ETN, FCZ101ETN, FCZ201ETN, FCZ061GAG, FCZ101GAG, FCZ102GAG, FCZ201GAG, FCZ202GAG, FCZ061GAD, FCZ101GAD, FCZ102GAD, FCZ201GAD, FCZ202GAD, FCZ101GTG, FCZ102GTG, FCZ201GTG, FCZ202GTG, FCZ101GTD, FCZ102GTD, FCZ201GTD, FCZ202GTD, FCZ061EBA, FCZ101EBA, FCZ102EBA, FCZ201EBA, FCZ202EBA, FCZ061EBH, FCZ101EBH, FCZ201EBH, FCZ061EBN, FCZ101EBN...(Other models you can see in the webshop) | | |



| | | | |
|--------------------|--|-----------------|--------|
| GEV No. | 700497 | Ref. No. | 054561 |
| description | bush for door mechanism | | |
| For models: | FCF02EV, FCF02EOEM, FCF/E3, FCF/E2, FCF/E2D, FCF/E2UK, FCF/E2, FCF/E2, COCO6G, COCO6E, FCF/E2D | | |

mechanical components, equipment accessories

| |
|--|
| 1 |
| GEV No. 551439 Ref. No. OC1151 |
| description cap for water container 45 blue suitable for combi-steamer |
| For models: FCZ061EAA, FCZ101EAA, FCZ102EAA, FCZ061EAH, FCZ101EAH, FCZ061EAN, FCZ101EAN, FCZ061ETA, FCZ101ETA, FCZ102ETA, FCZ061ETH, FCZ101ETH, FCZ061ETN, FCZ101ETN, FCZ061GAG, FCZ101GAG, FCZ102GAG, FCZ061GAD, FCZ101GAD, FCZ102GAD, FCZ101GTG, FCZ102GTG, FCZ101GTD, FCZ102GTD, FCZ061EBA, FCZ101EBA, FCZ102EBA, FCZ061EBH, FCZ101EBH, FCZ061EBN, FCZ101EBN, FCZ061EBC, FCZ101EBC, FCZ061EBA2, FCZ101EBA2, FCZ102EBA2, FCZ061EBH2, FCZ101EBH2, FCZ061EBN2, FCZ101EBN2, FCZ061EBC2, FCZ101EBC2, FCZ061GBI, FCZ101GBI, FCZ101GBG2, FCZ102GBG2, FCZ101GBD2, FCZ102GBD2, FCZ101GBI2, FCZ102GBI2...(Other models you can see in the webshop) |



| |
|--|
| 1 |
| GEV No. 551438 Ref. No. OC1152 |
| description cap for water container 45 red suitable for combi-steamer |
| For models: FCZ061EAA, FCZ101EAA, FCZ102EAA, FCZ061EAH, FCZ101EAH, FCZ061EAN, FCZ101EAN, FCZ061ETA, FCZ101ETA, FCZ102ETA, FCZ061ETH, FCZ101ETH, FCZ061ETN, FCZ101ETN, FCZ061GAG, FCZ101GAG, FCZ102GAG, FCZ061GAD, FCZ101GAD, FCZ102GAD, FCZ101GTG, FCZ102GTG, FCZ101GTD, FCZ102GTD, FCZ061EBA, FCZ101EBA, FCZ102EBA, FCZ061EBH, FCZ101EBH, FCZ061EBN, FCZ101EBN, FCZ061EBC, FCZ101EBC, FCZ061EBA2, FCZ101EBA2, FCZ102EBA2, FCZ061EBH2, FCZ101EBH2, FCZ061EBN2, FCZ101EBN2, FCZ061EBC2, FCZ101EBC2, FCZ061GBI, FCZ101GBI, FCZ101GBG2, FCZ102GBG2, FCZ101GBD2, FCZ102GBD2, FCZ101GBI2, FCZ102GBI2...(Other models you can see in the webshop) |



| |
|---|
| 1 |
| GEV No. 551440 Ref. No. OC3443 |
| description casing cover for combi-steamer ø 110mm |
| For models: FCZ061EAA, FCZ101EAA, FCZ102EAA, FCZ201EAA, FCZ202EAA, FCZ061EAH, FCZ101EAH, FCZ201EAH, FCZ061EAN, FCZ101EAN, FCZ201EAN, FCZ061ETA, FCZ101ETA, FCZ102ETA, FCZ201ETA, FCZ202ETA, FCZ061ETH, FCZ101ETH, FCZ201ETH, FCZ061ETN, FCZ101ETN, FCZ201ETN, FCZ061GAG, FCZ101GAG, FCZ102GAG, FCZ201GAG, FCZ202GAG, FCZ061GAD, FCZ101GAD, FCZ102GAD, FCZ201GAD, FCZ202GAD, FCZ101GTG, FCZ102GTG, FCZ201GTG, FCZ202GTG, FCZ101GTD, FCZ102GTD, FCZ201GTD, FCZ202GTD, FCZ061EBA, FCZ101EBA, FCZ102EBA, FCZ061EBH, FCZ101EBH, FCZ061EBN, FCZ101EBN, FCZ061EBC, FCZ101EBC, FCZ201EBC...(Other models you can see in the webshop) |



| |
|---|
| 1 |
| GEV No. 551436 Ref. No. OC2436 |
| description connecting piece for T-piece L 69mm ø 22/15mm brass |
| For models: FCZ201EAA, FCZ202EAA, FCZ201EAH, FCZ201EAN, FCZ201GAG, FCZ202GAG, FCZ201GAD, FCZ202GAD, FCZ201EBC, FCZ201GBI, FCZ201ECA, FCZ202ECA, FCZ201ECH, FCZ201ECN, FCZ201GCG, FCZ202GCG, FCZ201GCD, FCZ202GCD, AOS201GAEU, AOS202GAEU, AOS201GAAU, AOS202GAAU, AOS201EABU, AOS201EAFU, AOS202EA2N, AOS202EA, AOS201GA, AOS202GA, AOS201EAAQ, AOS202EAAQ, AOS201EANQ, AOS202EANQ, AOS201EACQ, AOS201EAHQ, AOS201GAGQ, AOS202GAGQ, AOS201GADQ, AOS202GADQ, AOS201GAIQ, AOS201GALQ, AOS201EAMQ, AOS201EABQ, AOS201GAPQ, AOS202GAPQ, AOS201EAA1, AOS202EAA1, AOS201EAH1, AOS201EAN1, AOS201EAC1, AOS201EAE1...(Other models you can see in the webshop) |



| |
|--|
| 1 |
| GEV No. 551399 Ref. No. OKB684 |
| description cover for water tank L 353mm W 233mm H 7mm suitable for combi-steamer ELECTROLUX, ZANUSSI |
| For models: FCV31E3, 7CO30, CCO30G, ECO312CF, OTS100 |



| |
|--|
| 1 |
| GEV No. 551398 Ref. No. OKB704 |
| description cover cap for water tank ø 34/51mm suitable for combi-steamer ELECTROLUX, ZANUSSI |
| For models: FCV31E3, 7CO30, CCO30G, ECO312CF, OTS100 |





| |
|---|
| 1 |
| GEV No. 550541 Ref. No. 002843 |
| description duct suitable for chip scuttle |
| For models: FCV/G6L3TOWNGAS, FCV/G6L3, FCV/G6L3JAP, ACV/G6C3, NCV/G6L2 |





| |
|--|
| 1 |
| GEV No. 550917 Ref. No. OK2769 |
| description flange |
| For models: 5611-3-10, 5611-3-8, 5612-3-10, 5612-3-8, 5614-3-10, 5614-3-8 |





| | | | |
|---|---|-----------------|--------|
|  | | | |
| GEV No. | 550900 | Ref. No. | OKD350 |
| description | flange L 60mm W 40mm H 1mm | | |
| For models: | 5611-3-10, 5611-3-6, 5611-3-8, 5612-3-10, 5612-3-6, 5612-3-8, 5614-3-10, 5614-3-6, 5614-3-8 | | |

| | | | |
|---|---|-----------------|--------|
|  | | | |
| GEV No. | 550899 | Ref. No. | OKD286 |
| description | flange L 60mm W 40mm H 2mm | | |
| For models: | 5611-3-10, 5611-3-6, 5611-3-8, 5612-3-10, 5612-3-6, 5612-3-8, 5614-3-10, 5614-3-6, 5614-3-8 | | |

| | | | |
|---|--|-----------------|--------|
|  | | | |
| GEV No. | 551397 | Ref. No. | OC4244 |
| description | mounting flange for lambda sensor L 70mm W 70mm H 40mm M12 ET | | |
| For models: | FCZ061EAA, FCZ101EAA, FCZ102EAA, FCZ201EAA, FCZ202EAA, FCZ061EAH, FCZ101EAH, FCZ201EAH, FCZ061EAN, FCZ101EAN, FCZ201EAN, FCZ061ETA, FCZ101ETA, FCZ102ETA, FCZ201ETA, FCZ202ETA, FCZ061ETH, FCZ101ETH, FCZ201ETH, FCZ061ETN, FCZ101ETN, FCZ201ETN, FCZ061GAG, FCZ101GAG, FCZ102GAG, FCZ201GAG, FCZ202GAG, FCZ061GAD, FCZ101GAD, FCZ102GAD, FCZ201GAD, FCZ202GAD, FCZ101GTG, FCZ102GTG, FCZ201GTG, FCZ202GTG, FCZ101GTD, FCZ102GTD, FCZ201GTD, FCZ202GTD, FCZ061EBA, FCZ101EBA, FCZ102EBA, FCZ202EBA, FCZ061EBH, FCZ101EBH, FCZ201EBH, FCZ101EBN, FCZ061EBC, FCZ101EBC...(Other models you can see in the webshop) | | |

| | | | |
|---|--|-----------------|------------------|
|  | | | |
| GEV No. | 699448 | Ref. No. | OC4238 OCA756 |
| description | nut L 22mm W 22mm H 6.5mm WS 22 M8 | | |
| For models: | FCZ061EAA, FCZ101EAA, FCZ102EAA, FCZ061EAH, FCZ101EAH, FCZ061EAN, FCZ101EAN, FCZ061ETA, FCZ101ETA, FCZ102ETA, FCZ061ETH, FCZ101ETH, FCZ061ETN, FCZ101ETN, FCZ061GAG, FCZ101GAG, FCZ102GAG, FCZ061GAD, FCZ101GAD, FCZ102GAD, FCZ201GAD, FCZ101GTG, FCZ102GTG, FCZ101GTD, FCZ102GTD, FCZ061EBA, FCZ101EBA, FCZ102EBA, FCZ061EBH, FCZ101EBH, FCZ061EBN, FCZ101EBN, FCZ061EBC, FCZ101EBC, FCZ061EBA2, FCZ101EBA2, FCZ102EBA2, FCZ061EBH2, FCZ101EBH2, FCZ061EBN2, FCZ101EBN2, FCZ061EBC2, FCZ101EBC2, FCZ061GBG, FCZ101GBG, FCZ102GBG, FCZ061GBD, FCZ101GBD, FCZ102GBD, FCZ061GBI, FCZ101GBI...(Other models you can see in the webshop) | | |

| | | | |
|--|---|-----------------|--------|
|  | | | |
| GEV No. | 545179 | Ref. No. | 003701 |
| description | spring for hose reel thickness 1mm for hose 6x12mm spring steel combi-steamer | | |
| For models: | DCS | | |

| | | | |
|---|-----------|-----------------|--------------------------------------|
|  | | | |
| GEV No. | 690878 | Ref. No. | OK2793 OKC201 114114 754741 |
| description | taper nut | | |

| filters | | | |
|---|---|-----------------|--------|
|  | | | |
| GEV No. | 362014 | Ref. No. | OC1155 |
| description | container filter for combi-steamer SS hose ø 6mm | | |
| For models: | FCZ061EAA, FCZ101EAA, FCZ102EAA, FCZ201EAA, FCZ202EAA, FCZ061EAH, FCZ101EAH, FCZ201EAH, FCZ061EAN, FCZ101EAN, FCZ201EAN, FCZ061ETA, FCZ101ETA, FCZ102ETA, FCZ061ETH, FCZ101ETH, FCZ201ETH, FCZ061ETN, FCZ101ETN, FCZ201ETN, FCZ061GAG, FCZ101GAG, FCZ102GAG, FCZ201GAG, FCZ202GAG, FCZ061GAD, FCZ101GAD, FCZ102GAD, FCZ201GAD, FCZ202GAD, FCZ101GTG, FCZ102GTG, FCZ201GTG, FCZ202GTG, FCZ101GTD, FCZ102GTD, FCZ201GTD, FCZ202GTD, FCZ061EBA, FCZ101EBA, FCZ102EBA, FCZ202EBA, FCZ061EBH, FCZ101EBH, FCZ201EBH, FCZ101EBN, FCZ061EBC, FCZ101EBC, FCZ201EBC, FCZ061EBA2, FCZ101EBA2, FCZ102EBA2, FCZ061EBH2, FCZ101EBH2, FCZ061EBN2, FCZ101EBN2...(Other models you can see in the webshop) | | |

| | | | |
|--|---|-----------------|------------------|
|  | | | |
| GEV No. | 514377 | Ref. No. | OH6299 OK1043 |
| description | drain filter | | |
| For models: | FDV40G, FDV40E, FDV40GZ, FDV40EL, FDV40GA, FDV20G, FDV20E, FDV20GZ, FDV20EL, FDV20GA, FCVG202L3, FCVE202L3, FCVG202L6, FCVE202L6, FCV/G202/1, FVC/E202/1, FCS202E4, FCS202G4, FCS202GP, FCS202GX, 5717-2-6, 5714-2-7, 5714-2-8, 5714-2-10, 5714-2-6L, 5714-2-7L, 5714-2-8L, 5714-2-10L, 5717-3-7, 5717-3-8, 5717-3-8E, 5717-3-10, 5717-3-8M, 5717-3-8C, 5717-3-8M, 5707-2-2, 57074-2-3, 5707-3-2, 5707-3-3, ECVG202T4, ECVE202T4, ECVG202T6, ECVE202T6, ACVG202C4, ACVE202C4, ACVG202C6, ACV/E202/1, ZCV/G202/1, ZCV/E202/1, ZCV/G202/1...(Other models you can see in the webshop) | | |

mechanical components, equipment accessories



1

| | | | |
|--------------------|---|-----------------|--|
| GEV No. | 514425 | Ref. No. | 005133 056444 0C1740 0F0073 0K8367 30001886 |
| description | drain filter ø 102mm | | |
| For models: | FCZ061EAA, FCZ101EAA, FCZ201EAA, FCZ061EAH, FCZ101EAH, FCZ201EAH, FCZ061EAN, FCZ101EAN, FCZ201EAN, FCZ061ETA, FCZ101ETA, FCZ201ETA, FCZ061ETH, FCZ101ETH, FCZ201ETH, FCZ061ETN, FCZ101ETN, FCZ201ETN, FCZ061GAG, FCZ101GAG, FCZ201GAG, FCZ061GAD, FCZ101GAD, FCZ201GAD, FCZ101GTG, FCZ102GTG, FCZ201GTG, FCZ101GTD, FCZ102GTD, FCZ201GTD, FCZ061EBA, FCZ101EBA, FCZ201EBA, FCZ061EBH, FCZ101EBH, FCZ201EBH, FCZ061EBN, FCZ101EBN, FCZ201EBN, FCZ061EBC, FCZ101EBC, FCZ201EBC, FCZ061EBA2, FCZ101EBA2, FCZ201EBA2, FCZ061EBH2, FCZ101EBH2, FCZ201EBH2, FCZ061EBN2, FCZ101EBN2... (Other models you can see in the webshop) | | |

housing and bezels



1

| | | | |
|--------------------|--|-----------------|--------|
| GEV No. | 699198 | Ref. No. | 0C4138 |
| description | flange bore ø 9mm ø 74mm H 5mm | | |
| For models: | FCZ061EAA, FCZ101EAA, FCZ102EAA, FCZ201EAA, FCZ202EAA, FCZ061EAH, FCZ101EAH, FCZ201EAH, FCZ061EAN, FCZ101EAN, FCZ201EAN, FCZ061ETA, FCZ101ETA, FCZ201ETA, FCZ202ETA, FCZ061ETH, FCZ101ETH, FCZ201ETH, FCZ061ETN, FCZ101ETN, FCZ201ETN, FCZ061GAG, FCZ101GAG, FCZ102GAG, FCZ201GAG, FCZ202GAG, FCZ061GAD, FCZ101GAD, FCZ102GAD, FCZ201GAD, FCZ202GAD, FCZ101GTG, FCZ102GTG, FCZ201GTG, FCZ202GTG, FCZ101GTD, FCZ102GTD, FCZ201GTD, FCZ202GTD, FCZ061EBA, FCZ101EBA, FCZ102EBA, FCZ201EBA, FCZ202EBA, FCZ061EBH, FCZ101EBH, FCZ201EBH, FCZ061EBN, FCZ101EBN... (Other models you can see in the webshop) | | |



1

| | | | |
|--------------------|--|-----------------|------------------|
| GEV No. | 850115 | Ref. No. | 0C1590 0C4109 |
| description | insulation set for boiler thickness 6mm plastic | | |
| For models: | FCZ061EAA, FCZ101EAA, FCZ061EAH, FCZ101EAH, FCZ061EAN, FCZ101EAN, FCZ061EBA, FCZ101EBA, FCZ061EBH, FCZ101EBH, FCZ101EBN, AOW101EA, AOS061EABU, AOS101EABU, AOS061EAFU, AOS101EAFU, AOS101EA, AOS101EB, AOS101EA3J, AOS101EB3J, AOS101EA2N, AOS101EB2N, AOS101EA0H, AOS101EB0H, AOW101EABU, AOS061EAAQ, AOS061EBAQ, AOS101EAAQ, AOS101EBAQ, AOS061EANQ, AOS061EBNQ, AOS101EANQ, AOS101EBNQ, AOS061EACQ, AOS061EBCQ, AOS101EACQ, AOS101EBCQ, AOS061EAHQ, AOS061EBHQ, AOS101EAHQ, AOS101EBHQ, AOS101EBEQ, AOS061EAMQ, AOS101EAMQ, AOS061EABQ, AOS101EABQ, EJN061EAA, EJN101EAA, RDR061EAA, RDR101EAA... (Other models you can see in the webshop) | | |

air filters



1

| | | | |
|--------------------|---|-----------------|--------|
| GEV No. | 970959 | Ref. No. | 0C4937 |
| description | air filter L 415mm W 73mm H 15mm SS for combi-steamer ELECTROLUX, ZANUSSI | | |

frame



1

| | | | |
|--------------------|---|-----------------|--------------------------------------|
| GEV No. | 693398 | Ref. No. | 057382 0H6890 0K3035 0KC541 |
| description | frame for level glass | | |
| For models: | MFR/G360, MPN/GD761, MPN/GI761, MPN/GI760D, MPN/GD760, MPN/GD760F, MPN/GI760, MPN/GI760F, MM/G351, MM/G701, MM/G350, MM/G700, MM/G350F, MM/G700F, MM/G700E, MCP/G700, MCP/G701, MCP/G710, MCP/G711, MCP/G705, MCP/G706, FDV40G, FDV40GZ, FDV40GA, FDV20G, FDV20GZ, FDV20GA, RBR/G2FM, RBR/G2IM, RBK/G2FM, RMV/G1C, RMV/G2C, RF/G1S07, RF/G2D07, RFR/G1S07, RFR/G2D07, XBR/G2FM, XBR/G2IM, XBR/G2FM, XMV/G1C, XMV/G2C, XF/G1S07, XRF/G2D07, XRF/G1S07... (Other models you can see in the webshop) | | |

cleaning system

nozzles



1

| | | | |
|--------------------|--------------------------|-----------------|--------|
| GEV No. | 510239 | Ref. No. | 0H6675 |
| description | rinse jet for humidifier | | |



coupling bushings





1

| | | | |
|--------------------|--|-----------------|--------------------------------------|
| GEV No. | 694644 | Ref. No. | 0C4342 0C4680 0C6166 0C6167 |
| description | guide for washing arms | | |
| For models: | FCS101EX4J, FCS101EXLN, FCS101EX, FCS102EX4J, FCS102EX, FCS201EX, FCS201EXLN, FCS202EX, FCS101GX9J, FCS101GX, FCS102GX9J, FCS102GX, FCS201GX, FCS202GX | | |





| cleaning arms | | | |
|---|---|-----------------|----------------------------|
|  | | | |
| GEV No. | 693408 | Ref. No. | 007010 0C5503 0C8317 |
| description | cleaning arm | | |
| For models: | FCZ061EAA, FCZ101EAA, FCZ102EAA, FCZ201EAA, FCZ202EAA, FCZ061EAH, FCZ101EAH, FCZ201EAH, FCZ061EAN, FCZ101EAN, FCZ201EAN, FCZ061ETA, FCZ101ETA, FCZ102ETA, FCZ201ETA, FCZ202ETA, FCZ061ETH, FCZ101ETH, FCZ201ETH, FCZ061ETN, FCZ101ETN, FCZ201ETN, FCZ061GAG, FCZ101GAG, FCZ102GAG, FCZ201GAG, FCZ202GAG, FCZ061GAD, FCZ101GAD, FCZ102GAD, FCZ201GAD, FCZ202GAD, FCZ101GTG, FCZ102GTG, FCZ201GTG, FCZ202GTG, FCZ101GTD, FCZ102GTD, FCZ201GTD, FCZ202GTD, FCZ061EBA, FCZ101EBA, FCZ102EBA, FCZ061EBH, FCZ101EBH, FCZ061EBN, FCZ101EBN, FCZ061EBC, FCZ101EBC, FCZ201EBC, FCZ202EBC...(Other models you can see in the webshop) | | |
| spare parts for | 693408 | | |
|  | | | |
| GEV No. | 693409 | Ref. No. | 007026 |
| description | retainer clip for wash arm | | |

| hoses | | | |
|---|--|-----------------|--------|
|  | | | |
| GEV No. | 699394 | Ref. No. | 0C4294 |
| description | collector ED ø 15mm ID ø 11mm for hose for cleaning system combi-steamer | | |
| For models: | FCZ102EAA, FCZ102GAG, FCZ102GAD, FCZ102ECA, FCZ102GCG, FCZ102GCD, AOS102EAAQ, AOS102EANQ, AOS102GAGQ, AOS102GADQ, AOS102EAMQ, AOS102EABQ, AOS102GAPQ, AOS102EAC1, AOS102EAT1, AOS102GAG1, AOS102GAD1, AOS062GAP1, AOS102GAP1, AOS102GAU1, AOS102GCG1, AOS102GCD1, AOS062GCP1, AOS102GCP1, EJN102EAA, EJN102GAG, EJN102GAD, EJN102ECA, EJN102GCG, EJN102GCD | | |

| pipes | | | |
|---|--|-----------------|--------|
|  | | | |
| GEV No. | 699249 | Ref. No. | 0C0850 |
| description | by-pass L 135mm W 40mm H 60mm ø 20mm flange 40x60mm | | |
| For models: | FCV/G6L3TOWNGAS, FCV/G6L3, FCV/E101/1, FCV/E10L3JAP, FCV/E102/1L3JAP, FCV/E10L6JAP, FCV/E102/1L6JAP, FCV/G6L3JAP, FCV/G10L6JAP, FCV/G102/1L6JAP, FCV/E61/1, FCV/E61/1, FCV/E101/1, FCV/E101/1, FCV/E102/1, FCV/E61/1, FCV/E61/1, FCV/E101/1, FCV/E101/2, FCV/G61/1, FCV/G61/1, FCV/G61/1, FCV/E10L3, FCV/E102/1, FCV/E102/1L3, FCV/G6L4, FCV/E101/1, FCV/G10L6, FCV/E10L6, FCV/G102/1L6, FCV/E102/1L6, FCV/G20L6, FCV/G202L6, FCV/G101/1, FCV/E101/1, FCV/G102/1, FCV/E102/1, FCV/G201/1, FCV/E201/1, FCV/G202/1, FCV/E202/1, FCS061E44J, FCS061G48J, FCS061GP, FCS061EP, FCS061G3DI, FCS061E3CI, FCS061G4, FCS101E2, FCS061G4DT...(Other models you can see in the webshop) | | |

| | | | |
|--|--|-----------------|--------|
|  | | | |
| GEV No. | 521191 | Ref. No. | 0C4243 |
| description | drain pipe ø 19mm for combi-steamer stainless steel | | |
| For models: | FCZ061EAA, FCZ101EAA, FCZ061EAH, FCZ101EAH, FCZ061EAN, FCZ101EAN, FCZ061ETA, FCZ101ETA, FCZ061ETH, FCZ101ETH, FCZ061ETN, FCZ101ETN, FCZ061GAG, FCZ101GAG, FCZ061GAD, FCZ101GAD, FCZ101GTG, FCZ101GTD, FCZ061EBA, FCZ101EBA, FCZ061EBH, FCZ101EBH, FCZ061EBN, FCZ101EBN, FCZ061EBC, FCZ101EBC, FCZ061EBA2, FCZ101EBA2, FCZ061EBH2, FCZ101EBH2, FCZ061EBN2, FCZ101EBN2, FCZ061EBC2, FCZ101EBC2, FCZ061GBG, FCZ101GBG, FCZ061GBD, FCZ101GBD, FCZ061GBI, FCZ101GBI, FCZ101GBG2, FCZ101GBD2, FCZ101GBI2, FCZ061ECA, FCZ101ECA, FCZ061ECH, FCZ101ECH, FCZ061ECN, FCZ101ECN, FCZ061ECA2...(Other models you can see in the webshop) | | |

| | | | |
|--|--|-----------------|--------|
|  | | | |
| GEV No. | 521190 | Ref. No. | 007012 |
| description | water pipe L 205mm W 170mm ø 10mm for combi-steamer | | |
| For models: | FCZ061EAA, FCZ101EAA, FCZ102EAA, FCZ061EAH, FCZ101EAH, FCZ061EAN, FCZ101EAN, FCZ061ETA, FCZ101ETA, FCZ061ETH, FCZ101ETH, FCZ061ETN, FCZ101ETN, FCZ061GAG, FCZ101GAG, FCZ061GAD, FCZ101GAD, FCZ061EBA, FCZ101EBA, FCZ102EBA, FCZ061EBH, FCZ101EBH, FCZ061EBN, FCZ101EBN, FCZ061EBC, FCZ101EBC, FCZ061EBA2, FCZ101EBA2, FCZ061EBH2, FCZ101EBH2, FCZ061EBN2, FCZ101EBN2, FCZ061EBC2, FCZ101EBC2, FCZ061GBG, FCZ101GBG, FCZ061GBD, FCZ101GBD, FCZ061GBI, FCZ101GBI, FCZ061ECA, FCZ101ECA, FCZ061ECH, FCZ101ECH, FCZ061ECN, FCZ101ECN, FCZ061ECA2, FCZ101ECA2, FCZ061ECH2, FCZ101ECH2...(Other models you can see in the webshop) | | |

| level glasses | | | |
|--|---|-----------------|--------|
|  | | | |
| GEV No. | 697987 | Ref. No. | 055343 |
| description | level glass ø 54mm L 83mm thickness 3.5mm | | |
| For models: | FCV/G6L4, FCVE6-1U, FCVE6-3U, FCVE6-1, FCVE6-3, FCVE6-1UK, FCVE6-3UK, FCVG6-1, FCVG6-3, FCVG6-1UK, FCVG6-3UK, FCVE10-2, FCVE10-4, FCVE10-2UK, FCVE10-4UK, FCVG10-2, FCVG10-4, FCVG10-2UK, FCVG10-4UK, FCVE20-2, FCVE20-4, FCVE20-2UK, FCVE20-4UK, FCVG20-2, FCVG20-4, FCVG20-2UK, FCVG20-4UK, ECV/G6T4, FCV/E6-1, FCV/E6-1, FCV/G6-1, ZOFV/G6-3, ZOFV/E102, ZOFV/E104, ZOFV/G102, ZOFV/G104, ZOFV/E202, ZOFV/E204, ZOFV/G202, ZOFV/G204, AFCV/G6-1, AFCV/G6-3, SCO/G6-3, ZCV/G6T4 | | |

mechanical components, equipment accessories



hoses



1

| | | | |
|--------------------|--|-----------------|--|
| GEV No. | 697979 | Ref. No. | OC0874 OC0943 OC3307 OC3943 OC5122 |
| description | hose ID ø 29mm ED ø 39mm L 340mm | | |
| For models: | FCZ061EAA, FCZ061EAH, FCZ061EAN, FCZ061ETA, FCZ061ETH, FCZ061ETN, FCZ061EBA, FCZ061EBH, FCZ061EBN, FCZ061EBC, FCZ061EBA2, FCZ061EBH2, FCZ061EBN2, FCZ061EBC2, FCZ061ECA, FCZ061ECH, FCZ061ECN, FCZ061ECA2, FCZ061ECH2, FCZ061ECN2, FCV/G61/1, FCV/G61/1, FCV/G61/1, FCV/G202/1, FCS061GP, FCS061G4, 5714-2-7, 5714-2-8, 5714-2-10, 5721-2-7, 5721-2-10, 5714-2-7L, 5714-2-8L, 5714-2-10L, ECV/G61/1, ECV/G61/1, AOS061EAA1, AOS061EAH1, AOS061EAN1, AOS061EAC1, AOS061EAE1, AOS061EAF1, AOS061EAM1, AOS061EAB1, AOS061EAK1, AOS061EAT1, AOS061ETA1, AOS061ETH1, AOS061ETN1, AOS061ETC1...(Other models you can see in the webshop) | | |



2

| | | | |
|--------------------|---|-----------------|--------------------------------------|
| GEV No. | 697981 | Ref. No. | 006113 006252 OC3322 OC5006 |
| description | hose ID ø 29mm ED ø 39mm L 860mm | | |
| For models: | FDV40G, FDV40E, FDV40GZ, FDV40EL, FDV40GA, FCV/E101/1, FCV/E101/1, FCV/E102/1, FCV/E101/1, FCV/E101/2, FCV/E102/1, FCV/E20L3, FCV/E20L6, FCV/G101/1, FVC/E101/1, FCV/G102/1, FVC/E102/1, FVC/E201/1, FVC/E202/1, FCS101E44J, FCS101EP4J, FCS101E4, FCS101G4, FCS101EP, FCS101G4DT, FCS102E44J, FCS101GP9J, FCS102EP4J, FCS101G49J, FCS102E4, FCS101GP, FCS102EP, FCS102G4, FCS102GA9J, FCS201EP, FCS102G49J, FCS202E4, FCS102GP, FCS202EP, FCS101EX4J, FCS101EXLN, FCS101EX, FCS102EX4J, FCS102EX, FCS201EX, FCS201EXLN, FCS202EX, FCS101GX9J, FCS101GX, FCS102GX9J...(Other models you can see in the webshop) | | |



1

| | | | |
|--------------------|--|-----------------|--------|
| GEV No. | 697982 | Ref. No. | OC0869 |
| description | hose ID ø 30mm ED ø 40mm L 1030mm | | |
| For models: | FDV20G, FDV20E, FDV20GZ, FDV20EL, FDV20GA, FCV/G201/1, FCS201G4, FCS201GP, FCS202G4, FCS202GP, FCS201GX, FCS202GX, 5714-2-7, 5714-2-8, 5714-2-10, 5714-2-7L, 5714-2-8L, 5714-2-10L, 5714-2-10F, 5714-2-10S | | |



1

| | | | |
|--------------------|---|-----------------|--------|
| GEV No. | 697980 | Ref. No. | OC1223 |
| description | hose ID ø 40mm ED ø 50mm L 450mm for combi-steamer | | |
| For models: | FDV40G, FDV40GZ, FDV40GA, FCV/G202/1, FCS201EP, FCS202EP, FCS201GP, FCS202G4, FCS202GP, FCS201EX, FCS201EXLN, FCS202EX, 5714-2-7, 5714-2-8, 5714-2-10, 5714-2-7L, 5714-2-8L, 5714-2-10L | | |



1

| | | | |
|--------------------|--|-----------------|--------|
| GEV No. | 697978 | Ref. No. | OC1344 |
| description | hose ID ø 40mm ED ø 50mm L 52mm | | |
| For models: | FDV20G, FDV20GZ, FDV20GA, FCV/G61/1, FCV/G61/1, FCV/G61/1, FCV/G201/1, FVC/E201/1, FCS061G48J, FCS061GP, FCS061G3DI, FCS061G4, FCS061G4DT, FCS061G49J, FCS201E4, FCS201EP, FCS202E4, FCS201G4, FCS201GP, FCS202G4, FCS202GP, FCS201EX, FCS201GX, FCS202GX, 5714-2-7, 5714-2-8, 5714-2-10, 5721-2-7, 5721-2-10, 5714-2-7L, 5714-2-8L, 5714-2-10L, 5714-2-10F, 5714-2-10S, 5714-3-10F, 5714-3-10S, ECV/G61/1, ECV/G61/1, ZCV/G61/1 | | |

service kits



1

| | | | |
|---|---|-----------------|------------------------|
| GEV No. | 542417 | Ref. No. | OC9988 |
| description | lever handle set for door combi-steamer bolt ø 19mm | | |
| accessories for | 542417 | | |
|  | GEV No. | 900272 | Ref. No. 003680 |
| | window gasket profile 1830 L 1500mm Qty 1 | | |



drip water trays



1

| | | | |
|--------------------|---|-----------------|--------|
| GEV No. | 699201 | Ref. No. | 0C4242 |
| description | drain tray to clip L 600mm W 77mm H 22mm | | |
| For models: | FCZ061EAA, FCZ101EAA, FCZ061EAH, FCZ101EAH, FCZ061EAN, FCZ101EAN, FCZ061ETA, FCZ101ETA, FCZ061ETH, FCZ101ETH, FCZ061ETN, FCZ101ETN, FCZ061GAG, FCZ101GAG, FCZ061GAD, FCZ101GAD, FCZ101GTG, FCZ101GTD, FCZ061EBA, FCZ101EBA, FCZ061EBH, FCZ101EBH, FCZ061EBN, FCZ101EBN, FCZ061EBC, FCZ101EBC, FCZ061EBA2, FCZ101EBA2, FCZ061EBH2, FCZ101EBH2, FCZ061EBN2, FCZ101EBN2, FCZ061EBC2, FCZ101EBC2, FCZ061GBG, FCZ101GBG, FCZ061GBD, FCZ101GBD, FCZ061GBI, FCZ101GBI, FCZ101GBG2, FCZ101GBD2, FCZ101GBI2, FCZ061ECA, FCZ101ECA, FCZ061ECH, FCZ101ECH, FCZ061ECN, FCZ101ECN, FCZ061ECA2... (Other models you can see in the webshop) | | |

doors



1

| | | | |
|--------------------|---|-----------------|--------|
| GEV No. | 690870 | Ref. No. | 004838 |
| description | catch for glass door | | |
| For models: | FCV/G10L3, FCV/G6L3TOWNGAS, FCV/G6L3, FCVG10L3T, FCVG102L3, FCV/E101/1, FCV/G20L3, FCVG202L3, FCVE6L3J, FCV/E10L3JAP, FCV/E102/1L3JAP, FCV/E10L6JAP, FCV/E102/1L6JAP, FCV/G6L3JAP, FCVG10L3J, FCVG102L3J, FCV/G10L6JAP, FCV/G102/1L6JAP, FCVG6L3CJ, FCV/E61/1, FCV/G10L2, FCV/E61/1, FCV/E101/1, FCV/E101/1, FCV/E10L2, FCV/E102/1, FCV/E61/1, FCV/E61/1, FCV/E101/1, FCV/E101/2, FCV/G6L3C, FCV/G61/1, FCV/G61/1, FCV/G61/1, FCV/G61/1, FCV/G61/1, FCV/G6L3CT, FCVG6L3CJ, FCV/E10L3, FCV/E102/1, FCV/E6L3, FCV/E102/1L3, FCV/E20L3, FCVE202L3, FCV/G6L4, FCV/E6L4, FCV/E101/1, FCV/G10L6, FCV/E10L6, FCV/G102/1L6, FCV/E102/1L6... (Other models you can see in the webshop) | | |

door mechanics

holders



1

| | | | |
|--------------------|--|-----------------|--------|
| GEV No. | 692844 | Ref. No. | 006939 |
| description | bracket for door mechanism combi-steamer L 264mm W 39mm H 34mm zinc-plated sheet steel | | |
| For models: | FCF/E6-0, FCFE101-0, FCFE102-0, FCF061ELN, FCF101ELN, FCF6EHOR, FCFG10160H, FCF061ENS, FCF101ENS, FCF102ENS, FCFE6-1J, FCFE101-1J, FCFE102-1J, ECF/E6-0, ECFE101-0, ECFE102-0, ECF061ENS, ECF101ENS, ECF102ENS, ECF061E5M, ECF061ECV, ACF/E6-0, ACFE101-0, ACFE102-0, ACFG10160H, RCF061E, RCF101E | | |

door handles



1

| | | | |
|--------------------|---|-----------------|----------------------------|
| GEV No. | 696835 | Ref. No. | 0C4308 0C8719 0C9149 |
| description | door handle L 180mm ø 46.5mm shaft L 40mm shaft diameter 8x8mm with bush | | |
| For models: | FCZ201EAA, FCZ202EAA, FCZ201EAH, FCZ201EAN, FCZ201GAG, FCZ202GAG, FCZ201GAD, FCZ202GAD, FCZ201EBA, FCZ202EBA, FCZ201EBH, FCZ201EBN, FCZ201EBC, FCZ201GBG, FCZ202GBG, FCZ201GBD, FCZ202GBD, FCZ201GBI, FCZ201ECA, FCZ202ECA, FCZ201ECH, FCZ201ECN, FCZ201GCG, FCZ202GCG, FCZ201GCD, FCZ202GCD, AOS201EAAQ, AOS201EBAQ, AOS202EAAQ, AOS202EBAQ, AOS201EANQ, AOS201EBNQ, AOS202EANQ, AOS202EBNQ, AOS201EACQ, AOS201EBCQ, AOS201EAHQ, AOS201EBHQ, AOS201EBFQ, AOS201GAGQ, AOS201GBGQ, AOS202GAGQ, AOS202GBGQ, AOS201GADQ, AOS201GBDQ, AOS202GADQ, AOS202GBDQ, AOS201GAIQ, AOS201GALQ, AOS201EAMQ... (Other models you can see in the webshop) | | |



1

| | | | |
|--------------------|--|-----------------|--------|
| GEV No. | 542415 | Ref. No. | 0C6569 |
| description | lever handle plastic/SS shaft ø 11mm suitable for combi-steamer | | |
| For models: | FCZ061ETA, FCZ101ETA, FCZ102ETA, FCZ061ETH, FCZ101ETH, FCZ061ETN, FCZ101ETN, FCZ102GTG, FCZ102GTD, FCZ061EBA2, FCZ101EBA2, FCZ102EBA2, FCZ061EBH2, FCZ101EBH2, FCZ061EBN2, FCZ101EBN2, FCZ061EBC2, FCZ101EBC2, FCZ102GBG2, FCZ102GBD2, FCZ102GBI2, FCZ061ECA2, FCZ101ECA2, FCZ102ECA2, FCZ061ECH2, FCZ101ECH2, FCZ061ECN2, FCZ101ECN2, FCZ102GCG2, FCZ102GCD2, AOS061ETA1, AOS101ETA1, AOS102ETA1, AOS061ETH1, AOS101ETH1, AOS061ETN1, AOS101ETN1, AOS061ETC1, AOS101ETC1, AOS061ETE1, AOS101ETE1, AOS061ETF1, AOS101ETF1, AOS061ETM1, AOS062ETM1, AOS101ETM1, AOS102ETM1, AOS061ETK1, AOS101ETK1, AOS102ETK1... (Other models you can see in the webshop) | | |

mechanical components, equipment accessories







1

| | | | |
|---|---|-----------------|------------------------|
| GEV No. | 542417 | Ref. No. | 0C9988 |
| description | lever handle set for door combi-steamer bolt ø 19mm | | |
| accessories for | 542417 | | |
|  | GEV No. | 900272 | Ref. No. 003680 |
| | window gasket profile 1830 L 1500mm Qty 1 | | |

locking mechanism



1

| | | | |
|---|--|-----------------|---|
| GEV No. | 692846 | Ref. No. | 0C4119 |
| description | espagnolette lock L 1250mm complete ø 10mm for combi-steamer | | |
| For models: | FCZ201EAA, FCZ202EAA, FCZ201EAH, FCZ201EAN, FCZ201GAG, FCZ202GAG, FCZ201GAD, FCZ202GAD, FCZ201EBA, FCZ202EBA, FCZ201EBH, FCZ201EBN, FCZ201GBG, FCZ202GBG, FCZ201GBD, FCZ202GBD, FCZ201ECA, FCZ202ECA, FCZ201ECH, FCZ201ECN, FCZ201GCG, FCZ202GCG, FCZ201GCD, FCZ202GCD, AOS201EAAQ, AOS201EBAQ, AOS202EAAQ, AOS202EBAQ, AOS201EANQ, AOS201EBNQ, AOS202EANQ, AOS202EBNQ, AOS201EACQ, AOS201EBCQ, AOS201EAHQ, AOS201EBHQ, AOS201GAGQ, AOS201GBGQ, AOS202GAGQ, AOS202GBGQ, AOS201GADQ, AOS201GBDQ, AOS202GADQ, AOS202GBDQ, AOS201GAIQ, AOS201GALQ, AOS201EAMQ, AOS201EABQ, AOS201GAPQ, AOS202GAPQ...(Other models you can see in the webshop) | | |
| spare parts for | 692846 | | |
|  | GEV No. | 690041 | Ref. No. 003822 0H6727 0K2246 251425 751020943 |
| | cam L 148mm mounting distance 32mm | | |
|  | GEV No. | 692013 | Ref. No. 052061 060920 0H6043 0K8575 |
| | roll pin ø 3mm L 16mm | | |
| | GEV No. | 694645 | Ref. No. 0C4309 |
| | bar for espagnolette lock ø 10mm L 345mm | | |
| | GEV No. | 698500 | Ref. No. 0C4310 |
| | bar L 435mm ø 9mm | | |
|  | GEV No. | 700488 | Ref. No. 003824 0K2718 0K8570 0K9189 751020941 |
| | latch gear | | |

accessories



1

| | | | |
|--------------------|---|-----------------|--------|
| GEV No. | 692851 | Ref. No. | 056552 |
| description | connecting piece for door latch ø 10mm L 112mm | | |
| For models: | FCVE10-2, FCVE10-4, FCVE103CE, FCVE10-2UK, FCVE10-4UK, FCVG10-2, FCVG10-4, FCVG10-5G, FCVG10-2, FCVG10-4D, FCVG10-2UK, FCVG10-4UK, FCVG10-2, FCVG10-4, FCVE20-2, FCVE20-4, FCVE203CE, FCVE20/P-V, FCVE20-2UK, FCVE20-4UK, FCVG20-2, FCVG20-4, FCVG20-2, FCVG20-4D, FCVG20-2UK, FCVG20-4UK, FCVG20-4, FCVG20-4D, FCVE20-V, FCVE20VUK, FCVE10-P, FCVE10PUK, FCVG10-P, FCVG10PUK, FCVE20-P, FCVE20PUK, FCVG20-P, FCVG20PUK, HCF/G1210, ZHCF/G161, AFCV/G101, AFCV/G103, SCO/G10-3, AFCV/G201, AFCV/G203, SCO/G20-3, FCVG10-5G, FCV/E20-V | | |



1

| | | | |
|--------------------|---|-----------------|--------|
| GEV No. | 519624 | Ref. No. | 003991 |
| description | door hinge for combi-steamer mounting pos. right bottom L 125mm W 50mm | | |
| For models: | FCFG201-0, FCFG202-0, FCFE201-0, FCFE202-0, FCF201ENS, ECFG201-0, ECFG202-0, ECFE201-0, ECFE202-0, ECF201ENS, ACFG201-0, ACFG202-0, ACFE201-0, ACFE202-0, RCF201E, ZCF/G201/1, ZCF/G202/1, ZCF/E201/1-0, ZCF/E202/1-0 | | |

heat exchangers



1

| | | | |
|--------------------|--|-----------------|------------------|
| GEV No. | 692323 | Ref. No. | 003881 215711 |
| description | heat exchanger for convection oven | | |
| For models: | FCV/G10L3, FCVG10L3T, FCV/G20L3, FCVG10L3J, FCV/G10L6JAP, FCV/G10L2, FCV/G10L6, FCV/G20L6, FCV/G101/1, FCV/G201/1, FCS101G2, FCS101G4, FCS101G4DT, FCS101GP9J, FCS101G49J, FCS101GP, FCS201G4, FCS201GP, FCS101GX9J, FCS101GX, FCS201GX, 5712-2-6, 5712-2-7, 5712-2-8, 5712-2-10, 5714-2-6, 5714-2-7, 5714-2-8, 5714-2-10, 5712-2-6L, 5712-2-7L, 5712-2-8L, 5712-2-10L, 5714-2-6L, 5714-2-7L, 5714-2-8L, 5714-2-10L, 5712-2-10F, 5712-2-10S, 5714-2-10F, 5714-2-10S, 5702-2-2, 5702-2-3, 5704-2-2, 5704-2-3, ECV/G10T4, ECV/G20T4, ECV/G10T4J, ECV/G20T4J, ECV/G10T6...(Other models you can see in the webshop) | | |



miscellaneous



1

| | | | |
|--------------------|---|-----------------|--------|
| GEV No. | 698500 | Ref. No. | 0C4310 |
| description | bar L 435mm ø 9mm | | |
| For models: | FCZ201EAA, FCZ202EAA, FCZ201EAH, FCZ201EAN, FCZ201ETA, FCZ202ETA, FCZ201ETH, FCZ201ETN, FCZ201GAG, FCZ202GAG, FCZ201GAD, FCZ202GAD, FCZ201GTG, FCZ202GTG, FCZ201GTD, FCZ202GTD, FCZ201EBA, FCZ202EBA, FCZ201EBH, FCZ201EBN, FCZ201EBC, FCZ201EBA2, FCZ202EBA2, FCZ201EBH2, FCZ201EBN2, FCZ201EBC2, FCZ201GBG, FCZ202GBG, FCZ201GBD, FCZ202GBD, FCZ201GBI, FCZ201GBG2, FCZ202GBG2, FCZ201GBD2, FCZ202GBD2, FCZ201GBI2, FCZ201ECA, FCZ202ECA, FCZ201ECH, FCZ201ECN, FCZ201ECA2, FCZ202ECA2, FCZ201ECH2, FCZ201ECN2, FCZ201GCG, FCZ202GCG, FCZ201GCD, FCZ202GCD, FCZ201GCG2, FCZ202GCG2... (Other models you can see in the webshop) | | |



1

| | | | |
|--------------------|--|-----------------|--------|
| GEV No. | 693429 | Ref. No. | 002662 |
| description | bush | | |
| For models: | FCZ061EAA, FCZ101EAA, FCZ102EAA, FCZ201EAA, FCZ202EAA, FCZ061EAH, FCZ101EAH, FCZ201EAH, FCZ061EAN, FCZ101EAN, FCZ201EAN, FCZ061ETA, FCZ101ETA, FCZ201ETA, FCZ202ETA, FCZ061ETH, FCZ101ETH, FCZ201ETH, FCZ061ETN, FCZ101ETN, FCZ201ETN, FCZ061GAG, FCZ101GAG, FCZ201GAG, FCZ202GAG, FCZ061GAD, FCZ101GAD, FCZ201GAD, FCZ202GAD, FCZ101GTG, FCZ201GTG, FCZ202GTG, FCZ101GTD, FCZ201GTD, FCZ202GTD, FCZ061EBA, FCZ101EBA, FCZ201EBA, FCZ202EBA, FCZ061EBH, FCZ101EBH, FCZ201EBH, FCZ202EBH... (Other models you can see in the webshop) | | |



1

| | | | |
|--------------------|---|-----------------|--------|
| GEV No. | 696445 | Ref. No. | 0C6228 |
| description | connecting fitting D1 ø 25mm D2 ø 11.5mm L 20mm WS 27 thread M18x1 | | |
| For models: | FCZ061EAA, FCZ101EAA, FCZ102EAA, FCZ061EAH, FCZ101EAH, FCZ061EAN, FCZ101EAN, FCZ061ETA, FCZ101ETA, FCZ201ETA, FCZ202ETA, FCZ061ETH, FCZ101ETH, FCZ201ETH, FCZ061ETN, FCZ101ETN, FCZ201ETN, FCZ101GTG, FCZ201GTG, FCZ202GTG, FCZ201GTD, FCZ202GTD, FCZ061EBA, FCZ101EBA, FCZ201EBA, FCZ202EBA, FCZ061EBH, FCZ101EBH, FCZ201EBH, FCZ202EBH, FCZ061EBN, FCZ101EBN, FCZ201EBN, FCZ202EBN, FCZ061EBA2, FCZ101EBA2, FCZ201EBA2, FCZ202EBA2, FCZ061EBH2, FCZ101EBH2, FCZ201EBH2, FCZ061EBN2, FCZ101EBN2, FCZ201EBN2, FCZ061EBC2, FCZ101EBC2, FCZ201EBC2, FCZ101GBG2... (Other models you can see in the webshop) | | |



1

| | | | |
|--------------------|---|-----------------|--------|
| GEV No. | 650218 | Ref. No. | 0C4292 |
| description | drip tray horizontal L 755mm stainless steel W 20mm hole ø 9.6mm H 40mm | | |
| For models: | FCZ102EAA, FCZ102ETA, FCZ102GAG, FCZ102GAD, FCZ102GTG, FCZ102GTD, FCZ102EBA, FCZ102EBA2, FCZ102GBG, FCZ102GBD, FCZ102GBG2, FCZ102GBD2, FCZ102GBI2, FCZ102ECA, FCZ102ECA2, FCZ102GCG, FCZ102GCD, FCZ102GCG2, FCZ102GCD2, AOS102EAAQ, AOS102EBAQ, AOS102EANQ, AOS102EBNQ, AOS102GAGQ, AOS102GBGQ, AOS102GADQ, AOS102GBDQ, AOS102EAMQ, AOS102EABQ, AOS102GAPQ, AOS102EAA1, AOS102EAC1, AOS102EAS1, AOS062EAM1, AOS102EAM1, AOS062EAB1, AOS102EAB1, AOS102EAK1, AOS102EAT1, AOS102ETA1, AOS062ETM1, AOS102ETM1, AOS102ETK1, AOS102GAG1, AOS102GAD1, AOS062GAP1, AOS102GAP1, AOS102GAU1, AOS102GTG1, AOS102GTD1... (Other models you can see in the webshop) | | |



1

| | | | |
|--------------------|---|-----------------|--------|
| GEV No. | 650217 | Ref. No. | 0C4298 |
| description | drip tray horizontal L 785mm plastic W 78mm H 12mm | | |
| For models: | FCZ102EAA, FCZ102ETA, FCZ102GAG, FCZ102GAD, FCZ102GTG, FCZ102GTD, FCZ102EBA, FCZ102EBA2, FCZ102GBG, FCZ102GBD, FCZ102GBG2, FCZ102GBD2, FCZ102GBI2, FCZ102ECA, FCZ102ECA2, FCZ102GCG, FCZ102GCD, FCZ102GCG2, FCZ102GCD2, AOS102EAAQ, AOS102EBAQ, AOS102EANQ, AOS102EBNQ, AOS102GAGQ, AOS102GBGQ, AOS102GADQ, AOS102GBDQ, AOS102EAMQ, AOS102EABQ, AOS102GAPQ, AOS102EAA1, AOS102EAC1, AOS102EAS1, AOS062EAM1, AOS102EAM1, AOS062EAB1, AOS102EAB1, AOS102EAK1, AOS102EAT1, AOS102ETA1, AOS062ETM1, AOS102ETM1, AOS102ETK1, AOS102GAG1, AOS102GAD1, AOS062GAP1, AOS102GAP1, AOS102GAU1, AOS102GTG1, AOS102GTD1... (Other models you can see in the webshop) | | |



1

| | | | |
|--------------------|--|-----------------|--------|
| GEV No. | 697983 | Ref. No. | 006670 |
| description | flange bore ø 9mm D1 ø 74mm D2 ø 22mm L 68mm thickness 1mm | | |
| For models: | FCV/G6L3TOWNGAS, FCV/G6L3, FCV/E101/1, FCV/E10L3JAP, FCV/E102/1L3JAP, FCV/E10L6JAP, FCV/E102/1L6JAP, FCV/G6L3JAP, FCV/G10L6JAP, FCV/G102/1L6JAP, FCV/E61/1, FCV/E61/1, FCV/E101/1, FCV/E101/1, FCV/E102/1, FCV/E61/1, FCV/E61/1, FCV/E101/1, FCV/E101/2, FCV/G61/1, FCV/G61/1, FCV/G61/1, FCV/E10L3, FCV/E102/1, FCV/E102/1L3, FCV/G6L4, FCV/E101/1, FCV/G10L6, FCV/E10L6, FCV/G102/1L6, FCV/E102/1L6, FCV/G20L6, FCV/G20L6, FCV/G101/1, FCV/E101/1, FCV/G102/1, FCV/E102/1, FCV/G201/1, FCV/E201/1, FCV/G202/1, FCV/E202/1, FCV/G201-0, FCV/G202-0, FCS061E44J, FCS061G48J, FCS061GP, FCS061EP, FCS061G3DI, FCS061E3CI, FCS061G4... (Other models you can see in the webshop) | | |

mechanical components, equipment accessories



1

| | | | |
|--------------------|--|-----------------|--------|
| GEV No. | 697985 | Ref. No. | 058730 |
| description | flange for fan motor bore ϕ 6.6mm ϕ 230mm thickness 2.5mm | | |
| For models: | FCFG20, FCFG20D, FCFG20F, PFCFG20, FCFE20, FCFE20UK, FCFG40, FCFG41, FCFG40D, FCFG40F, PFCFG40F, FCFE40, FCFE40D, FCFE40UK, PFCFE40F, FCFG20J, FCFG20J, FCFE20J, FCFE20J, FCFG40J, FCFG40J, FCFE40J, FCFE40J, FCFG20J, FCFG20J, FCFG41J, FCFG40J, FCVE20-2, FCVE20-4, FCVE203CE, FCVE20-2UK, FCVE20-4UK, FCVE20-P, FCVE20PUK, FCVG20-P, FCVG20PUK, FCFG201, FCFG202, FCFC202, FCFE202, ZOFCV/E202, ZOFCV/E204, FF/E40, AFCV/G201, AFCV/G203, SCO/G20-3, FF/E20, FF/G20, FF/G40, AFCF/E40...(Other models you can see in the webshop) | | |



1

| | | | |
|--------------------|--|-----------------|--------|
| GEV No. | 697984 | Ref. No. | 002872 |
| description | flange for fan motor L 152mm W 152mm ϕ 65mm thickness 1mm | | |
| For models: | FCV/G10L3, FCVG10L3T, FCVG102L3, FCV/G20L3, FCVG202L3, FCVG10L3J, FCVG102L3J, FCV/G10L6JAP, FCV/G102/1L6JAP, FCV/G10L2, FCV/G10L6, FCV/G102/1L6, FCV/G20L6, FCVG202L6, FCV/G101/1, FCV/G102/1, FCV/G201/1, FCV/G202/1, FCS101G2, FCS101G4, FCS101G4DT, FCS101GP9J, FCS101G49J, FCS101GP, FCS102G4, FCS102GA9J, FCS102G49J, FCS102GP, FCS201G4, FCS201GP, FCS202G4, FCS202GP, FCS101GX9J, FCS101GX, FCS102GX9J, FCS102GX, FCS201GX, FCS202GX, 5712-2-6, 5712-2-7, 5712-2-8, 5712-2-10, 5714-2-6, 5714-2-7, 5714-2-8, 5714-2-10, 5717-2-6, 5714-2-7, 5714-2-8, 5714-2-10...(Other models you can see in the webshop) | | |



1

| | | | |
|--------------------|--|-----------------|--------|
| GEV No. | 697986 | Ref. No. | 058958 |
| description | flange ϕ 269mm | | |
| For models: | FCVE20-2, FCVE20-4, FCVE203CE, FCVE20-2UK, FCVE20-4UK, FCVE20-P, FCVE20PUK, FCVG20-P, FCVG20PUK, ZOFCV/E202, ZOFCV/E204, AFCV/G201, AFCV/G203, SCO/G20-3 | | |



1

| | | | |
|--------------------|--|-----------------|------------------|
| GEV No. | 698582 | Ref. No. | 002634 0C7016 |
| description | gasket conical D1 ϕ 74mm D2 ϕ 17mm thickness 11mm | | |
| For models: | FCZ061EAA, FCZ101EAA, FCZ102EAA, FCZ201EAA, FCZ202EAA, FCZ061EAH, FCZ101EAH, FCZ201EAH, FCZ061EAN, FCZ101EAN, FCZ201EAN, FCZ061ETA, FCZ201ETA, FCZ202ETA, FCZ061ETH, FCZ201ETH, FCZ061ETN, FCZ201ETN, FCZ061GAG, FCZ101GAG, FCZ102GAG, FCZ201GAG, FCZ202GAG, FCZ061GAD, FCZ101GAD, FCZ102GAD, FCZ201GAD, FCZ202GAD, FCZ101GTG, FCZ102GTG, FCZ201GTG, FCZ202GTG, FCZ101GTD, FCZ102GTD, FCZ201GTD, FCZ202GTD, FCZ061EBA, FCZ101EBA, FCZ102EBA, FCZ201EBA, FCZ202EBA, FCZ061EBH, FCZ101EBH, FCZ201EBH, FCZ061EBN, FCZ101EBN, FCZ201EBN, FCZ061EBC, FCZ101EBC, FCZ201EBC...(Other models you can see in the webshop) | | |



1

| | | | |
|--------------------|--|-----------------|------------------|
| GEV No. | 694372 | Ref. No. | 0G3351 0KB679 |
| description | gasket for hose for water inlet bore ϕ 14mm L 33mm for hose 6mm hose length 260mm | | |
| For models: | 7CO30, CCO30G, ECO312CF, OTS100 | | |



1

| | | | |
|--------------------|---|-----------------|------------------|
| GEV No. | 693432 | Ref. No. | 002663 0F0082 |
| description | gasket for knob | | |
| For models: | EBS50, EBS50, EBS50, EBS50, EBV50, EBV50, EBV50, EBV50, EBV50, EBS100, EBS100, EBS100, EBS100, EBV100, EBV100, EBV100, EBV100, EBV100, EBV-C100, EBV-C100, EBV-C100, EBV-C100, EBV-C100, EBV-C100, EBV200, EBV200, EBV200, EBV200, EBV200, EBV-C200, EBV-C200, EBV-C200, EBV-C200, EBV300, EBV300, EBV300, EBV300, EBV300, EBV-C300, EBV-C300, EBV-C300, EBV-C300, EBV-C300, FCV/G10L3, FCV/G6L3TOWNGAS, FCV/G6L3, FCVG10L3T, FCVG102L3, FCV/G20L3, FCVG202L3...(Other models you can see in the webshop) | | |



| | | | |
|--------------------|---|-----------------|--------|
| | | | |
| 1 | | | |
| GEV No. | 520938 | Ref. No. | OC1168 |
| description | gasket L 115mm rubber W 100mm thickness 3.5mm hole ø 7mm | | |
| For models: | FCZ102EAA, FCZ201EAA, FCZ202EAA, FCZ201EAH, FCZ201EAN, FCZ102ETA, FCZ201ETA, FCZ202ETA, FCZ201ETH, FCZ201ETN, FCZ102GAG, FCZ201GAG, FCZ202GAG, FCZ102GAD, FCZ201GAD, FCZ202GAD, FCZ102GTG, FCZ201GTG, FCZ202GTG, FCZ102GTD, FCZ201GTD, FCZ202GTD, FCZ102EBA, FCZ201EBA, FCZ202EBA, FCZ201EBH, FCZ201EBN, FCZ201EBC, FCZ102EBA2, FCZ201EBA2, FCZ202EBA2, FCZ201EBH2, FCZ201EBN2, FCZ201EBC2, FCZ102GBG, FCZ201GBG, FCZ202GBG, FCZ102GBD, FCZ201GBD, FCZ202GBD, FCZ201GBI, FCZ102GBG2, FCZ201GBG2, FCZ202GBG2, FCZ102GBD2, FCZ201GBD2, FCZ202GBD2, FCZ102GBI2, FCZ201GBI2, FCZ102ECA... (Other models you can see in the webshop) | | |

| | | | |
|--------------------|---|-----------------|--------|
| | | | |
| 2 | | | |
| GEV No. | 520866 | Ref. No. | 007117 |
| description | hose connector brass straight thread 3/4" hose ø 30mm Qty 1 pcs | | |
| For models: | FDV40G, FDV40GZ, FDV40GA, FDV20G, FDV20GZ, FDV20GA, FCZ061EAA, FCZ101EAA, FCZ102EAA, FCZ201EAA, FCZ202EAA, FCZ061EAH, FCZ101EAH, FCZ201EAH, FCZ061EAN, FCZ101EAN, FCZ201EAN, FCZ061ETA, FCZ101ETA, FCZ102ETA, FCZ201ETA, FCZ202ETA, FCZ061ETH, FCZ101ETH, FCZ201ETH, FCZ061ETN, FCZ101ETN, FCZ201ETN, FCZ201GAG, FCZ201GAD, FCZ201GTG, FCZ201GTD, FCZ061EBA, FCZ101EBA, FCZ102EBA, FCZ201EBA, FCZ202EBA, FCZ061EBH, FCZ101EBH, FCZ201EBH, FCZ061EBN, FCZ101EBN, FCZ201EBN, FCZ061EBC, FCZ101EBC, FCZ201EBC, FCZ061EBA2, FCZ101EBA2, FCZ102EBA2, FCZ201EBA2... (Other models you can see in the webshop) | | |

| | | | |
|--------------------|---|-----------------|--------|
| | | | |
| 1 | | | |
| GEV No. | 696444 | Ref. No. | OC4975 |
| description | injection pipe L-shape for combi-steamer L 555mm WS 27 thread M18 ø 8mm | | |
| For models: | FCZ101EAA, FCZ101EAH, FCZ101EAN, FCZ101ETA, FCZ201ETA, FCZ101ETH, FCZ201ETH, FCZ101ETN, FCZ201ETN, FCZ101GTG, FCZ201GTG, FCZ101GTD, FCZ201GTD, FCZ101EBA, FCZ101EBH, FCZ101EBN, FCZ101EBC, FCZ201EBC, FCZ101EBA2, FCZ201EBA2, FCZ101EBH2, FCZ201EBH2, FCZ101EBN2, FCZ201EBN2, FCZ101EBC2, FCZ201EBC2, FCZ101GBI, FCZ201GBI, FCZ101GBG2, FCZ201GBG2, FCZ101GBD2, FCZ201GBD2, FCZ101GBI2, FCZ201GBI2, FCZ101ECA, FCZ201ECA, FCZ101ECH, FCZ201ECH, FCZ101ECN, FCZ201ECN, FCZ101ECA2, FCZ201ECA2, FCZ101ECH2, FCZ201ECH2, FCZ101ECN2, FCZ201ECN2, FCZ201GCG, FCZ201GCD, FCZ101GCG2, FCZ201GCG2... (Other models you can see in the webshop) | | |

| | | | |
|--------------------|---|-----------------|--------|
| | | | |
| 1 | | | |
| GEV No. | 601725 | Ref. No. | OC3423 |
| description | mounting clip | | |
| For models: | FCZ061EAA, FCZ101EAA, FCZ102EAA, FCZ201EAA, FCZ202EAA, FCZ061EAH, FCZ101EAH, FCZ201EAH, FCZ061EAN, FCZ101EAN, FCZ201EAN, FCZ061ETA, FCZ101ETA, FCZ102ETA, FCZ061ETH, FCZ101ETH, FCZ061ETN, FCZ101ETN, FCZ061GAG, FCZ101GAG, FCZ102GAG, FCZ201GAG, FCZ202GAG, FCZ061GAD, FCZ101GAD, FCZ102GAD, FCZ201GAD, FCZ202GAD, FCZ061EBA, FCZ101EBA, FCZ102EBA, FCZ201EBA, FCZ202EBA, FCZ061EBH, FCZ101EBH, FCZ201EBH, FCZ061EBN, FCZ101EBN, FCZ201EBN, FCZ061EBC, FCZ101EBC, FCZ201EBC, FCZ061EBA2, FCZ101EBA2, FCZ102EBA2, FCZ061EBH2, FCZ101EBH2, FCZ061EBN2, FCZ101EBN2, FCZ061EBC2... (Other models you can see in the webshop) | | |

| | | | |
|--------------------|---|-----------------|--------|
| | | | |
| 1 | | | |
| GEV No. | 543008 | Ref. No. | OC1117 |
| description | non-return valve plastic ø 10mm Qty 1 pcs total length 10mm | | |
| For models: | FCZ061EAA, FCZ101EAA, FCZ102EAA, FCZ201EAA, FCZ202EAA, FCZ061EAH, FCZ101EAH, FCZ201EAH, FCZ061EAN, FCZ101EAN, FCZ201EAN, FCZ061ETA, FCZ101ETA, FCZ102ETA, FCZ201ETA, FCZ202ETA, FCZ061ETH, FCZ101ETH, FCZ201ETH, FCZ061ETN, FCZ101ETN, FCZ201ETN, FCZ061GAG, FCZ101GAG, FCZ102GAG, FCZ201GAG, FCZ202GAG, FCZ061GAD, FCZ101GAD, FCZ102GAD, FCZ201GAD, FCZ202GAD, FCZ101GTG, FCZ102GTG, FCZ201GTG, FCZ202GTG, FCZ101GTD, FCZ102GTD, FCZ201GTD, FCZ202GTD, FCZ061EBA, FCZ101EBA, FCZ102EBA, FCZ061EBH, FCZ101EBH, FCZ061EBN, FCZ101EBN, FCZ061EBC, FCZ101EBC, FCZ201EBC... (Other models you can see in the webshop) | | |

| | | | |
|--------------------|---|-----------------|------------------|
| | | | |
| 1 | | | |
| GEV No. | 693430 | Ref. No. | 051263 0F0147 |
| description | nut thread M22x1.5 H 5mm WS 26 zinc-coated steel Qty 1 pcs | | |
| For models: | FCZ061EAA, FCZ101EAA, FCZ102EAA, FCZ201EAA, FCZ202EAA, FCZ061EAH, FCZ101EAH, FCZ201EAH, FCZ061EAN, FCZ101EAN, FCZ201EAN, FCZ061ETA, FCZ101ETA, FCZ102ETA, FCZ201ETA, FCZ202ETA, FCZ061ETH, FCZ101ETH, FCZ201ETH, FCZ061ETN, FCZ101ETN, FCZ201ETN, FCZ061GAG, FCZ101GAG, FCZ102GAG, FCZ201GAG, FCZ202GAG, FCZ061GAD, FCZ101GAD, FCZ102GAD, FCZ201GAD, FCZ202GAD, FCZ101GTG, FCZ102GTG, FCZ201GTG, FCZ202GTG, FCZ101GTD, FCZ102GTD, FCZ201GTD, FCZ202GTD, FCZ061EBA, FCZ101EBA, FCZ102EBA, FCZ201EBA, FCZ202EBA, FCZ061EBH, FCZ101EBH, FCZ201EBH, FCZ061EBN, FCZ101EBN... (Other models you can see in the webshop) | | |

mechanical components, equipment accessories



1

| | | | |
|--------------------|--|-----------------|--------|
| GEV No. | 693431 | Ref. No. | 002727 |
| description | plain washer | | |
| For models: | FCZ061EAA, FCZ101EAA, FCZ102EAA, FCZ201EAA, FCZ202EAA, FCZ061EAH, FCZ101EAH, FCZ201EAH, FCZ061EAN, FCZ101EAN, FCZ201EAN, FCZ061ETA, FCZ101ETA, FCZ102ETA, FCZ201ETA, FCZ202ETA, FCZ061ETH, FCZ101ETH, FCZ201ETH, FCZ061ETN, FCZ101ETN, FCZ201ETN, FCZ061GAG, FCZ101GAG, FCZ102GAG, FCZ201GAG, FCZ202GAG, FCZ061GAD, FCZ101GAD, FCZ102GAD, FCZ201GAD, FCZ202GAD, FCZ101GTG, FCZ102GTG, FCZ201GTG, FCZ202GTG, FCZ101GTD, FCZ102GTD, FCZ201GTD, FCZ202GTD, FCZ061EBA, FCZ101EBA, FCZ102EBA, FCZ201EBA, FCZ202EBA, FCZ061EBH, FCZ101EBH, FCZ201EBH, FCZ061EBN, FCZ101EBN...(Other models you can see in the webshop) | | |



2

| | | | |
|--------------------|---|-----------------|--------|
| GEV No. | 692446 | Ref. No. | 002091 |
| description | reducer bore \varnothing 0.6mm brass \varnothing 12mm thickness 9mm code 6 | | |
| For models: | FCV/G6L3TOWNGAS, FCV/G6L3, FCV/E101/1, FCVE6L3J, FCV/G6L3JAP, FCVG6L3CJ, FCV/E61/1, FCV/G10L2, FCV/E10L2, FCV/E61/1, FCV/G6L3C, FCV/G61/1, FCVG6L3CT, FCVG6L3CJ, FCV/E6L3, FCV/E101/1, FCF/G6-0, FCFG101/0, FCFG102-0, FCFG201-0, FCFG202-0, FCF/E6-0, FCFE101-0, FCFE102-0, FCFE201-0, FCFE202-0, FCF061ELN, FCF101ELN, FCFG102-0T, FCF/G6-1-JAP, FCF/G101/1-1-JAP, FCF/G102/1-1-JAP, FCFE6-1J, FCFE101-1J, FCFE102-1J, FCF/G101/1, FCS061E44J, FCS061G48J, FCS061G3DI, FCS061E3CI, FCS101E2, FCS061G4DT, FCS061G49J, FCS101G2, FCVG10-1SG, 5702-2-2, 5702-2-3, 5702-3-2, 5702-3-3, ECF/G6/0...(Other models you can see in the webshop) | | |



1

| | | | |
|--------------------|---|-----------------|--------|
| GEV No. | 520512 | Ref. No. | 0C1116 |
| description | reducer WS 17 IT 1/4" ET 1/8" total length 28mm | | |
| For models: | FCZ061EAA, FCZ101EAA, FCZ102EAA, FCZ201EAA, FCZ202EAA, FCZ061EAH, FCZ101EAH, FCZ201EAH, FCZ061EAN, FCZ101EAN, FCZ201EAN, FCZ061ETA, FCZ101ETA, FCZ102ETA, FCZ201ETA, FCZ202ETA, FCZ061ETH, FCZ101ETH, FCZ201ETH, FCZ061ETN, FCZ101ETN, FCZ201ETN, FCZ061GAG, FCZ101GAG, FCZ102GAG, FCZ201GAG, FCZ202GAG, FCZ061GAD, FCZ101GAD, FCZ102GAD, FCZ201GAD, FCZ202GAD, FCZ101GTG, FCZ102GTG, FCZ201GTG, FCZ202GTG, FCZ101GTD, FCZ102GTD, FCZ201GTD, FCZ202GTD, FCZ061EBA, FCZ101EBA, FCZ102EBA, FCZ061EBH, FCZ101EBH, FCZ061EBN, FCZ101EBN, FCZ061EBC, FCZ101EBC, FCZ061EBA2...(Other models you can see in the webshop) | | |

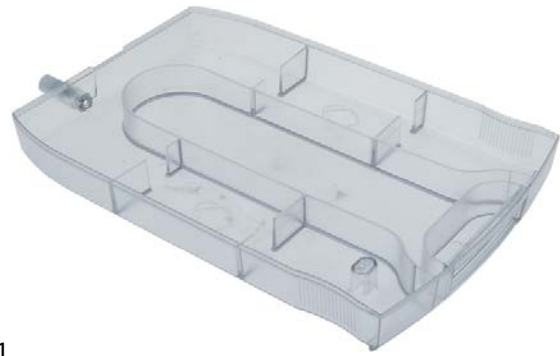

1

| | | | |
|--------------------|---|-----------------|------------------|
| GEV No. | 696399 | Ref. No. | 0CB394 0KB722 |
| description | water container for combi-steamer L 400mm plastic W 238mm | | |
| For models: | FCV31E3, 7CO30, CCO30G, ECO312CF, OTS100 | | |

for tilting bratt pans

miscellaneous





1

| | | | |
|--------------------|---|-----------------|---|
| GEV No. | 523510 | Ref. No. | 045312 045726 056820 065048 072702 072751 0D0035 0H2689 0KT988 62022Z 6202Z 63646403 |
| description | deep-groove ball bearing type 6202-2RS shaft \varnothing 15mm ED \varnothing 35mm W 11mm with sealing discs deep-groove ball bearing DIN 625-1 | | |
| For models: | MBR/G710D, MBR/E710D, MBR/G700, MBR/G700F, MBR/E700, MBR/E700UK, MBR/G700UK, MBR/G701, MBR/G706, MBR/G701UK, MBR/G751, MBR/G756, MBR/E716, MBR/E706, RBR/G2FM, RBR/G2IM, RBK/G2FM, RBR/E2FM, RBR/E2IM, RBK/E2FM, XBR/G2FM, XBR/G2IM, XBK/G2FM, XBR/E2FM, XBR/E2IM, XBK/E2FM, JBR/G2FM, JBR/E2FM, MBR/G2FM, MBR/G2IM, MBK/G2FM, MBR/E2FM, MBR/E2IM, MBK/E2FM, RBR/G710D, 7BRE60XN, RBR/G700, RBR/G700F, 7BRE60X, RBR/E700UK, 7BRG60, 7BRG60X, RBR/G701UK, RBR/G751, RBR/G756, RBR/E716, RBR/E706, XBR/G710D, XBR/E710D, XBR/G700...(Other models you can see in the webshop) | | |



knobs

universal knobs

| | | | |
|---|--|-----------------|------------------|
|  | | | |
| 1 | | | |
| GEV No. | 110253 | Ref. No. | 0A2207 0A2269 |
| description | knob switch zero mark t.max.°C ø 50mm shaft ø 6x4.6mm shaft flat upper black | | |
| For models: | HGRV, 710-00-115, 710-00-115, 711-00-115, 711-00-115, 710-00-122, 710-00-122, 711-00-122, 711-00-122, 0WC142, 655-00-106, 655-00-107, 655-00-110, 656-00-106, KITCALDO | | |
| accessories for | 110253 | | |
|  | | | |
| GEV No. | 550965 | Ref. No. | — |
| knob spring ø 6x4.6mm Qty 1 pcs | | | |

| | | | |
|---|---|-----------------|---------|
|  | | | |
| 1 | | | |
| GEV No. | 110245 | Ref. No. | 0112024 |
| description | knob thermostat t.max. 300°C ø 50mm shaft ø 6x4.6mm shaft flat upper black temperature range 50-300°C | | |

| | | | |
|---|--|-----------------|--------|
|  | | | |
| 1 | | | |
| GEV No. | 110932 | Ref. No. | 0E3019 |
| description | knob switch zero mark t.max.°C ø 42mm shaft ø 6x4.6mm shaft flat upper black | | |
| For models: | TW1ERECO, TW1ELECO, TW1SRECO, TW1SLECO, RT10ED, RT10ES, RT10SR, RT10SL, RT10ED/230, RT10ES/230, RT10ERF60, RT10ELF60, RT10ERF, RT10ELF, RT10ERBF60, RT10ELBF60, RT10ERG, RT10ELG, RT10EDH, RT10ESH, RT10SRB, RT10SLB, RT10ED/230H, RT10ES/230H, RT10ERBF, RT10ELBF, RT10ERBG, RT10ELBG, RT10EDECO, RT10ESECO, RT10SRC, RT10SLC, RT10ED/230E, RT10ES/230E, RT10ERCF, RT10ELCF, RT10ERCG, RT10ELCG, RT10EDHE, RT10ESHE, RT10SRCB, RT10SLCB, RT10ED/230HE, RT10ES/230HE, RT10ERCBF, RT10ELCBF, RT10ERCBG, RT10ELCBG, RT10ERASIA, RT10ELASIA...(Other models you can see in the webshop) | | |

accessories

button springs

| | | | |
|---|---|-----------------|--|
|  | | | |
| 1 | | | |
| GEV No. | 550132 | Ref. No. | 025245 058445 0M2312 0U0825 0U1421 |
| description | knob spring ø 6x4.6mm Qty 10 pcs | | |
| For models: | TC1000, TC1000, TC1010, 134TCA0, TCD1000, TCD1000, TC1400, TC1400, TCD1410, TCD1400, TC1410, 4061410, TC1600, TC1600, TC1610, TC1610, TCD1600, TCD1600, TC2000, TC2000, TCD2000, TCD2000, TC2010, TC2010, LPS/75, LPS/75, RC/E320, RC/E320U, RC/E720, RC/E720, MCF/GE705, MCF/GE1055, MCF/GE700, MCFGE1050, MCF/GE700D, MCFGE1050D, MCF/E700D, MCF/E700, MCF/E700UK, MCF/E1050D, MCF/E1050, MC/E350D, MC/E350UK, MC/E700D, MC/E700UK, MC/E1050D, MCF/GE1055UK, MC/E350, MC/E700, MC/E1050...(Other models you can see in the webshop) | | |

covers

| | | | |
|---|--|-----------------|----------------------------|
|  | | | |
| 1 | | | |
| GEV No. | 110288 | Ref. No. | 025255 025256 054367 |
| description | cover cap knob white | | |
| For models: | MFR/G350, MFR/G351, RCV/G2, RCV/G3, RCV/E2, RCV/E3, RRV/G1FL, RRV/G1FR, RRV/G2FL, RRV/G2FM, RRV/E1FL, RRV/E1FR, RRV/E2FL, RRV/E2FM, RG/G1, RG/G2, RGV/G1, RGV/G2, RGV/E1, RGV/E2, RTV/G2, RSV/G2, RIV/E2, RBV/G2, RBV/E2, XCV/G2, XCV/G3, XCV/E2, XCV/E3, XRV/G1FL, XRV/G1FR, XRV/G2FL, XRV/G2FM, XRV/E1FL, XRV/E1FR, XRV/E1CL, XRV/E2FL, XRV/E2FM, XRV/E2CL, XGV/G1, XGV/G2, XGV/E1, XGV/E2, XTV/G2, XSV/G2, XIV/E2, XBV/G2, XBV/E2, JCV/G2, JCV/G3...(Other models you can see in the webshop) | | |

fascias

| | | | |
|---|--|-----------------|--------|
|  | | | |
| 1 | | | |
| GEV No. | 111766 | Ref. No. | 055454 |
| description | bezel | | |
| For models: | FCVG6-1, FCGV6-3, FCGV6-1UK, FCGV6-3UK, FCGV10-2, FCGV10-4, FCGV10-5G, FCGV10-2, FCGV10-4D, FCGV10-2UK, FCGV10-4UK, FCGV10-2, FCGV10-4, FCGV20-2, FCGV20-4, FCGV20-2, FCGV20-4D, FCGV20-2UK, FCGV20-4UK, FCGV20-4, FCGV20-4D | | |

gaskets

| | | | |
|---|--|-----------------|--------|
|  | | | |
| 1 | | | |
| GEV No. | 110300 | Ref. No. | 059326 |
| description | gasket | | |
| For models: | HBR/G800, HBR/G805, HBR/G810, HBR/G815, HBR/G811, HBR/G816, HBR/G800UK, ZBR/G800, ZBR/G805, ZBR/G810, ZBR/G815, ZBR/G811, ZBR/G816, ZBR/G800UK, ABR/G800, ABR/G805, ABR/G810, ABR/G815, ABR/G811, ABR/G816, OBR/G800UK | | |

| | | | |
|---|---|-----------------|------------------|
|  | | | |
| 1 | | | |
| GEV No. | 693432 | Ref. No. | 002663 0F0082 |
| description | gasket for knob | | |
| For models: | EBS50, EBS50, EBS50, EBS50, EBV50, EBV50, EBV50, EBV50, EBV50, EBS100, EBS100, EBS100, EBS100, EBV100, EBV100, EBV100, EBV100, EBV100, EBV-C100, EBV-C100, EBV-C100, EBV-C100, EBV-C100, EBV-C100, EBV200, EBV200, EBV200, EBV200, EBV200, EBV-C200, EBV-C200, EBV-C200, EBV-C200, EBV-C200, EBV300, EBV300, EBV300, EBV300, EBV300, EBV300, EBV-C300, EBV-C300, EBV-C300, EBV-C300, EBV-C300, FCV/G10L3, FCV/G6L3TOWNGAS, FCV/G6L3, FCV/G10L3T, FCV/G102L3, FCV/G20L3, FCV/G20L3...(Other models you can see in the webshop) | | |

| | | | |
|---|--|-----------------|------------------|
|  | | | |
| 1 | | | |
| GEV No. | 697975 | Ref. No. | 003955 0C3796 |
| description | gasket for knob ED ø 16mm Qty 50 pcs | | |
| For models: | FDV40G, FDV40E, FDV40GZ, FDV40EL, FDV40GA, FDV20G, FDV20E, FDV20GZ, FDV20EL, FDV20GA, FCF02EV, FCF02EOEM, FCV/G10L3, FCV/G6L3TOWNGAS, FCV/G6L3, FCV/G10L3T, FCV/G102L3, FCV/G20L3, FCV/G20L3, FCVE6L3J, FCV/E10L3JAP, FCV/E102/1L3JAP, FCV/G6L3JAP, FCV/G10L3J, FCV/G102L3J, FCV/G6L3CJ, FCV/E61/1, FCV/G10L2, FCV/E101/1, FCV/E10L2, FCV/E61/1, FCV/E101/2, FCV/G6L3C, FCV/G61/1, FCV/G6L3CT, FCV/G6L3CJ, FCV/E10L3, FCV/E102/1, FCV/E6L3, FCV/E102/1L3, FCV/E20L3, FCVE202L3, FCV/G6L4, FCV/E6L4, FCV/E101/1, FCV/G101/1, FCV/E101/1, FCV/G102/1, FCV/E102/1, FCV/G201/1...(Other models you can see in the webshop) | | |

| | | | |
|---|--|-----------------|------------------|
|  | | | |
| 1 | | | |
| GEV No. | 111607 | Ref. No. | 053816 0KE998 |
| description | gasket knob D1 ø 14mm D2 ø 4mm thickness 3mm equiv. no. 53816 suitable for JUNO, ZANUSSI | | |
| For models: | RC/E320, RC/E320U, RC/E720, RC/E720, MCF/GE705, MCF/GE1055, MCF/GE700, MCFGE1050, MCF/GE700D, MCFGE1050D, MCF/E700D, MCF/E700UK, MCF/E1050D, MCF/E1050, MC/E350D, MC/E350UK, MC/E700D, MC/E700UK, MC/E1050D, MCF/GE1055UK, MC/E350, MC/E700, MC/E1050, MI/E350, MI/E700, MIF/E700, MI/E350D, MI/E700D, MIF/E700D, MI/E360, MI/E710, MIF/E710, MI/E360D, MI/E710D, MIF/E710D, MCF/GE702, MCFGE1052, MCF/GE700, MCF-GE1050, MBR/G710D, MBR/E710D, MBR/E700, MBR/E700UK, MBR/E716, MBR/E706, MFR/G350, MFR/G700, MFR/E350, MFR/E700...(Other models you can see in the webshop) | | |

| | | | |
|---|--|-----------------|--------|
|  | | | |
| 1 | | | |
| GEV No. | 111762 | Ref. No. | 056500 |
| description | gasket knob hole distance 24mm D1 ø 40mm D2 ø 14mm equiv. no. 56500 suitable for ZANUSSI | | |
| For models: | FCVE6-3CE, FCVE103CE, FCVE203CE | | |

| | | | |
|---|--|-----------------|--------|
| miscellaneous | | | |
|  | | | |
| 1 | | | |
| GEV No. | 693429 | Ref. No. | 002662 |
| description | bush | | |
| For models: | FCZ061EAA, FCZ101EAA, FCZ102EAA, FCZ201EAA, FCZ202EAA, FCZ061EAH, FCZ101EAH, FCZ201EAH, FCZ061EAN, FCZ101EAN, FCZ201EAN, FCZ061ETA, FCZ101ETA, FCZ102ETA, FCZ201ETA, FCZ202ETA, FCZ061ETH, FCZ101ETH, FCZ201ETH, FCZ061ETN, FCZ101ETN, FCZ201ETN, FCZ061GAG, FCZ101GAG, FCZ102GAG, FCZ201GAG, FCZ202GAG, FCZ061GAD, FCZ101GAD, FCZ102GAD, FCZ201GAD, FCZ202GAD, FCZ101GTG, FCZ102GTG, FCZ201GTG, FCZ202GTG, FCZ101GTD, FCZ102GTD, FCZ201GTD, FCZ202GTD, FCZ061EBA, FCZ101EBA, FCZ102EBA, FCZ201EBA, FCZ202EBA, FCZ061EBH, FCZ101EBH, FCZ201EBH, FCZ061EBN, FCZ101EBN...(Other models you can see in the webshop) | | |

| | | | |
|---|--|-----------------|------------------|
|  | | | |
| 1 | | | |
| GEV No. | 693430 | Ref. No. | 051263 0F0147 |
| description | nut thread M22x1.5 H 5mm WS 26 zinc-coated steel Qty 1 pcs | | |
| For models: | FCZ061EAA, FCZ101EAA, FCZ102EAA, FCZ201EAA, FCZ202EAA, FCZ061EAH, FCZ101EAH, FCZ201EAH, FCZ061EAN, FCZ101EAN, FCZ201EAN, FCZ061ETA, FCZ101ETA, FCZ102ETA, FCZ201ETA, FCZ202ETA, FCZ061ETH, FCZ101ETH, FCZ201ETH, FCZ061ETN, FCZ101ETN, FCZ201ETN, FCZ061GAG, FCZ101GAG, FCZ102GAG, FCZ201GAG, FCZ202GAG, FCZ061GAD, FCZ101GAD, FCZ102GAD, FCZ201GAD, FCZ202GAD, FCZ101GTG, FCZ102GTG, FCZ201GTG, FCZ202GTG, FCZ101GTD, FCZ102GTD, FCZ201GTD, FCZ202GTD, FCZ061EBA, FCZ101EBA, FCZ102EBA, FCZ201EBA, FCZ202EBA, FCZ061EBH, FCZ101EBH, FCZ201EBH, FCZ061EBN, FCZ101EBN...(Other models you can see in the webshop) | | |

| | | | |
|---|--|-----------------|--------|
|  | | | |
| 1 | | | |
| GEV No. | 693431 | Ref. No. | 002727 |
| description | plain washer | | |
| For models: | FCZ061EAA, FCZ101EAA, FCZ102EAA, FCZ201EAA, FCZ202EAA, FCZ061EAH, FCZ101EAH, FCZ201EAH, FCZ061EAN, FCZ101EAN, FCZ201EAN, FCZ061ETA, FCZ101ETA, FCZ102ETA, FCZ201ETA, FCZ202ETA, FCZ061ETH, FCZ101ETH, FCZ201ETH, FCZ061ETN, FCZ101ETN, FCZ201ETN, FCZ061GAG, FCZ101GAG, FCZ102GAG, FCZ201GAG, FCZ202GAG, FCZ061GAD, FCZ101GAD, FCZ102GAD, FCZ201GAD, FCZ202GAD, FCZ101GTG, FCZ102GTG, FCZ201GTG, FCZ202GTG, FCZ101GTD, FCZ102GTD, FCZ201GTD, FCZ202GTD, FCZ061EBA, FCZ101EBA, FCZ102EBA, FCZ201EBA, FCZ202EBA, FCZ061EBH, FCZ101EBH, FCZ201EBH, FCZ061EBN, FCZ101EBN...(Other models you can see in the webshop) | | |



handles and hand wheels

cylindrical handles

fixed



1

| | | | |
|--------------------|---|-----------------|--------|
| GEV No. | 110703 | Ref. No. | 004148 |
| description | cylindrical handle thread M10 ø 28mm L 87mm | | |
| For models: | ZCMM6, ZCBME12, ZCMM4, ZCBME8, ZCMM9, ZCBME18 | | |

cone handles



1

| | | | |
|--------------------|---|-----------------|---------------------------|
| GEV No. | 110704 | Ref. No. | 00329 004906 0K3527 |
| description | cone handle thread M6 ø 16mm L 25mm plastic black | | |
| For models: | SFRE700, SME350, SME700, SGE350, SFRG350, SFRG700, SFRE350, SFRE700, SME350, SME700, SGE350, SFRG350, SFRG700, SMG350, SMG700, BM35E6U, SFRE350, SFRE351, SFRE700, SFRE701, GR35E6U | | |



1

| | | | |
|--------------------|---|-----------------|------------------|
| GEV No. | 514322 | Ref. No. | 026822 029898 |
| description | cone handle thread M6 ø 20mm L 26mm plastic black | | |
| For models: | HFH/G430, HFH/E430, HFH/G401U, HFH/G435, HFH/G435, ZFH/G430, ZFH/E430, ZFH/G435, ZFH/G435, AFH/G435, AFH/E435, FCV/G10L3, FCV/G6L3TOWNGAS, FCV/G6L3, FCVG10L3T, FCVG102L3, FCV/G20L3, FCVG202L3, FCVE6L3J, FCV/E10L3JAP, FCV/E102/1L3JAP, FCV/G6L-3JAP, FCVG10L3J, FCVG102L3J, FCVG6L3CJ, FCV/E61/1, FCV/G10L2, FCV/E101/1, FCV/E10L2, FCV/E61/1, FCV/E101/2, FCV/G6L3C, FCV/G61/1, FCV/G61/1, FCV/G61/1, FCVG6L3CT, FCVG6L3CJ, FCV/E10L3, FCV/E102/1, FCV/E6L3, FCV/E102/1L3, FCV/E20L3, FCVE202L3, FCV/G6L4, FCV/E6L4, FCV/E101/1, FCV/G101/1, FVC/E101/1, FCV/G102/1, FVC/E102/1...(Other models you can see in the webshop) | | |

bracket handles



1

| | | | |
|--------------------|--|-----------------|--------|
| GEV No. | 700551 | Ref. No. | 053990 |
| description | pull handle L 200mm H 62mm mounting distance 179mm handle M8 | | |

lever handles



1

| | | | |
|--------------------|---|-----------------|--------|
| GEV No. | 542415 | Ref. No. | 0C6569 |
| description | lever handle plastic/SS shaft ø 11mm suitable for combi-steamer | | |
| For models: | FCZ061ETA, FCZ101ETA, FCZ102ETA, FCZ061ETH, FCZ101ETH, FCZ061ETN, FCZ101ETN, FCZ102GTG, FCZ102GTD, FCZ061EBA2, FCZ101EBA2, FCZ102EBA2, FCZ061EBH2, FCZ101EBH2, FCZ061EBN2, FCZ101EBN2, FCZ061EBC2, FCZ101EBC2, FCZ102GBG2, FCZ102GBD2, FCZ102GBI2, FCZ061ECA2, FCZ101ECA2, FCZ102ECA2, FCZ061ECH2, FCZ101ECH2, FCZ061ECN2, FCZ101ECN2, FCZ102GCG2, FCZ102GCD2, AOS061ETA1, AOS101ETA1, AOS102ETA1, AOS061ETH1, AOS101ETH1, AOS061ETN1, AOS101ETN1, AOS061ETC1, AOS101ETC1, AOS061ETE1, AOS101ETE1, AOS061ETF1, AOS101ETF1, AOS061ETM1, AOS062ETM1, AOS101ETM1, AOS102ETM1, AOS061ETK1, AOS101ETK1, AOS102ETK1...(Other models you can see in the webshop) | | |



1

| | | | |
|------------------------|---|-----------------|--------|
| GEV No. | 542417 | Ref. No. | 0C9988 |
| description | lever handle set for door combi-steamer bolt ø 19mm | | |
| accessories for | 542417 | | |
| GEV No. | 900272 | Ref. No. | 003680 |
| description | window gasket profile 1830 L 1500mm Qty 1 | | |



door handles

door handles



1

| | | | |
|--------------------|---|-----------------|------------------|
| GEV No. | 694378 | Ref. No. | 0E3709 OKB730 |
| description | door handle L 54mm W 25mm H 40mm black hole ø 4mm | | |
| For models: | FCV31E3, 7CO30, CCO30G, ECO312CF, OTS100 | | |

miscellaneous



1

| | | | |
|---|-----------------------------------|-----------------|------------------------|
| GEV No. | 700443 | Ref. No. | 025083 |
| description | handle | | |
| For models: | FCF/E3, FCF/E2, FCF/E2D, FCF/E2UK | | |
| accessories for | 700443 | | |
|  | GEV No. | 700452 | Ref. No. 054854 |
| | door catch with spigot | | |

accessories

covers



1

| | | | |
|--------------------|--|-----------------|--------|
| GEV No. | 530894 | Ref. No. | 003749 |
| description | cover for door handle L 148mm rubber black | | |
| For models: | FCFG101/0, FCFG102-0, FCFG102-0T, ECFG101-0, ECFG102-0, ACF/G6-0, ACFG101-0, ACFG102-0, ACF/E6-0, ACFE101-0, ACFE102-0, RCF061G, RCF061E, RCF101G, RCF101E, NCF/G6-0, NCF/G101/1, NCF/G102/1, NCF/E6-0, NCF/E101/1, NCF/E102/1, ZCF/G101/1, ZCF/G102/1 | | |

end caps



1

| | | | |
|--------------------|--|-----------------|--------|
| GEV No. | 518664 | Ref. No. | 0C4091 |
| description | end cap for handle ø 32.5mm | | |
| For models: | FCZ061EAA, FCZ101EAA, FCZ102EAA, FCZ061EAH, FCZ101EAH, FCZ061EAN, FCZ101EAN, FCZ061ETA, FCZ101ETA, FCZ102ETA, FCZ061ETH, FCZ101ETH, FCZ061ETN, FCZ101ETN, FCZ061GAG, FCZ101GAG, FCZ102GAG, FCZ061GAD, FCZ101GAD, FCZ102GAD, FCZ101GTG, FCZ102GTG, FCZ101GTD, FCZ102GTD, FCZ061EBA, FCZ101EBA, FCZ102EBA, FCZ061EBH, FCZ101EBH, FCZ061EBN, FCZ101EBN, FCZ061EBC, FCZ101EBC, FCZ061EBA2, FCZ101EBA2, FCZ102EBA2, FCZ061EBH2, FCZ101EBH2, FCZ061EBN2, FCZ101EBN2, FCZ061EBC2, FCZ101EBC2, FCZ061GBG, FCZ101GBG, FCZ102GBG, FCZ061GBD, FCZ101GBD, FCZ102GBD, FCZ061GBI, FCZ101GBI... (Other models you can see in the webshop) | | |

miscellaneous



1

| | | | |
|--------------------|--|-----------------|--------|
| GEV No. | 690026 | Ref. No. | 004195 |
| description | hand protection for door handle ED ø 36mm ID ø 12.3mm D1 ø 22.6-23.5mm | | |
| For models: | ZCMDE6, ZCBDE12, ZCMDE4, ZCBDE8, ZCMDE9, ZCBDE18, ZCBDG8, ZCBDG12, ZCBDG18, FFPS16, FFPS32 | | |



locks

face mounted latches

RAHRBACH





| | | | |
|---|--|-----------------|-------------------|
| GEV No. | 694369 | Ref. No. | 0H2207 OK7348 |
| description | catch series 6183 hinging left/right non lockable H 40mm W 35mm total length 190mm with door catch overall height 43mm | | |
| spare parts for | 694369 | | |
|  | GEV No. | 700773 | Ref. No. — |
| | door catch H 19mm adjustable L 38mm W 26mm mounting distance 20mm | | |

turning lever locks

universal

RAHRBACH



| | | | |
|---|---|-----------------|-------------------|
| GEV No. | 690044 | Ref. No. | OK8322 OT4381 |
| description | handle latch right L 185mm H 59mm handle material plastic type 6300 series | | |
| accessories for | 690044 | | |
|  | GEV No. | 690136 | Ref. No. — |
| | sliding plate mounting pos. right L 28mm H 3mm W 21mm H2 12.5mm | | |
|  | GEV No. | 700091 | Ref. No. — |
| | door catch mounting pos. right off-set 20mm L 110mm H 56mm W 33mm mounting distance 68/68mm zinc die cast series 6300 | | |
|  | GEV No. | 700098 | Ref. No. — |
| | door catch mounting pos. right off-set 38mm L 110mm H 74mm W 33mm mounting distance 68/68mm series 1750 | | |

edgmount latches

handle latches

CAFF/FERMOD

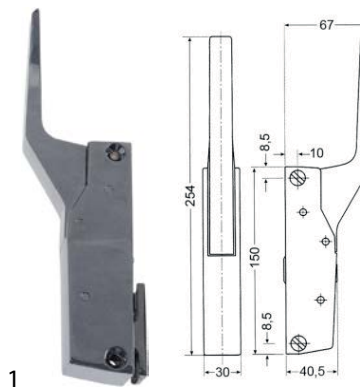

| | | | |
|--------------------|--|-----------------|---------------------|
| GEV No. | 694365 | Ref. No. | 0079101BR OK7679 |
| description | handle latch L 150mm mounting distance 133mm complete with door catch for headed units H 40.5mm W 30mm type 791 total length 254mm overall height 67mm | | |
| For models: | AR170, AR170, AR170, AR170, AR170, AR170, AR170, AR170, AR170, AR170, AR170S, AR170S, AR170S, AR170S, AR170S, AR170S, AR340, AR340, AR340, AR340, AR340, AR340, AR340, AR340, AR340S, AR340S, AR340S, AR340S, AR340S, AR340S, AR340S, AR340S | | |

producer-specific

INOXTREND





| | | | |
|---|--|-----------------|--------------------------------------|
| GEV No. | 690146 | Ref. No. | 005107 0H6459 OK1669 234663 |
| description | handle latch L 172mm mounting distance 134mm non lockable heated units 6200 H 65mm type DUPLO total length 248mm | | |
| For models: | 5711-2-6, 5711-2-7, 5711-2-8, 5711-2-10, 5711-2-8CH, 5711-2-10CH, 5712-2-6, 5712-2-7, 5712-2-8, 5712-2-10, 5711-2-6L, 5711-2-7L, 5711-2-8L, 5711-2-10L, 5721-2-7, 5721-2-10, 5712-2-6L, 5712-2-7L, 5712-2-8L, 5712-2-10L, 5711-3-6, 5711-3-7, 5711-3-8, 5711-3-10, 5711-3-8CH, 5711-3-10CH, 5712-3-6, 5712-3-7, 5712-3-8, 5712-3-8E, 5712-3-10, 5712-3-8CH, 5712-3-10C, 5712-2-10F, 5712-2-10S, 5711-3-10F, 5711-3-10S, 5712-3-10F, 5712-3-10S, 5702-2-2, 5702-2-3, 5701-3-2, 5701-3-3, 5702-3-2, 5702-3-3, 5611-3-10, 5611-3-6, 5611-3-8, 5612-3-10, 5612-3-6...(Other models you can see in the webshop) | | |
| accessories for | 690146 | | |
|  | GEV No. | 690123 | Ref. No. OK8039 OK8574 |
| | door catch H 69mm D 37mm W 20mm mounting distance 43mm with roller | | |

Table continues overleaf



| | | | | |
|---|---------|--------|----------|--------------------------------------|
| accessories for 690146 | | | | |
|  | GEV No. | 693777 | Ref. No. | 0H6797 OK2347 |
| gasket H 6.6mm L 105mm W 45mm L1 78mm W1 25mm for handle | | | | |
|  | GEV No. | 693778 | Ref. No. | 005176 0H6568 OK1952 242818 |
| door catch | | | | |



MODULAR



| | | | |
|----------------|--------|-----------------|--------------------------------------|
| GEV No. | 690146 | Ref. No. | 005107 0H6459 OK1669 234663 |
|----------------|--------|-----------------|--------------------------------------|

description handle latch L 172mm mounting distance 134mm non lockable heated units 6200 H 65mm type DUPLO total length 248mm

For models: 5711-2-6, 5711-2-7, 5711-2-8, 5711-2-10, 5711-2-8CH, 5711-2-10CH, 5712-2-6, 5712-2-7, 5712-2-8, 5712-2-10, 5711-2-6L, 5711-2-7L, 5711-2-8L, 5711-2-10L, 5721-2-7, 5721-2-10, 5712-2-6L, 5712-2-7L, 5712-2-8L, 5712-2-10L, 5711-3-6, 5711-3-7, 5711-3-8, 5711-3-10, 5711-3-8CH, 5711-3-10CH, 5712-3-6, 5712-3-7, 5712-3-8, 5712-3-8E, 5712-3-10, 5712-3-8CH, 5712-3-10C, 5712-2-10F, 5712-2-10S, 5711-3-10F, 5711-3-10S, 5712-3-10F, 5712-3-10S, 5702-2-2, 5702-2-3, 5701-3-2, 5701-3-3, 5702-3-2, 5702-3-3, 5611-3-10, 5611-3-6, 5611-3-8, 5612-3-10, 5612-3-6...(Other models you can see in the webshop)

| | | | | |
|---|---------|--------|----------|--------------------------------------|
| accessories for 690146 | | | | |
|  | GEV No. | 690123 | Ref. No. | OK8039 OK8574 |
| door catch H 69mm D 37mm W 20mm mounting distance 43mm with roller | | | | |
|  | GEV No. | 693777 | Ref. No. | 0H6797 OK2347 |
| gasket H 6.6mm L 105mm W 45mm L1 78mm W1 25mm for handle | | | | |
|  | GEV No. | 693778 | Ref. No. | 005176 0H6568 OK1952 242818 |
| door catch | | | | |

ZANUSSI

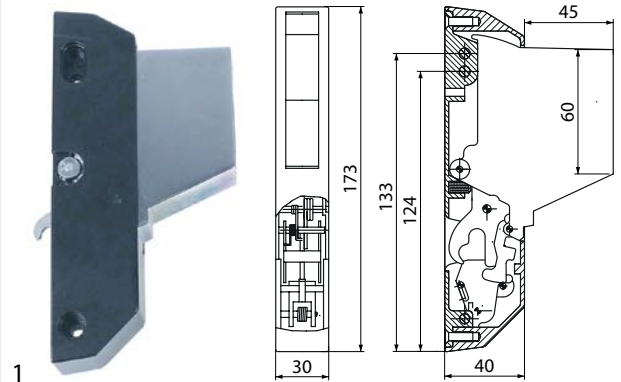

| | | | |
|----------------|--------|-----------------|---|
| GEV No. | 700467 | Ref. No. | 002647 0F0175 OK1663 OK8474 OKC474 OKZ752 1520148 |
|----------------|--------|-----------------|---|

description catch L 173mm H 40mm mounting distance 133/124mm W 30mm non lockable 6200 total length 170mm overall height 85mm

For models: FCV/G10L3, FCV/G6L3TOWNGAS, FCV/G6L3, FCV/G10L3T, FCV/G10L3, FCV/E101/1, FCVE6L3J, FCV/E10L3JAP, FCV/E102/1L3JAP, FCV/E10L-6JAP, FCV/E102/1L6JAP, FCV/G6L3JAP, FCV/G10L3J, FCV/G10L3, FCV/G10L6JAP, FCV/G102/1L6JAP, FCV/G6L3CJ, FCV/E61/1, FCV/G10L2, FCV/E61/1, FCV/E101/1, FCV/E101/1, FCV/E101/1, FCV/E10L2, FCV/E102/1, FCV/E61/1, FCV/E61/1, FCV/E101/1, FCV/E101/2, FCV/G6L3C, FCV/G61/1, FCV/G61/1, FCV/G61/1, FCV/G61/1, FCV/G6L3CT, FCV/G6L3CJ, FCV/E10L3, FCV/E102/1, FCV/E6L3, FCV/E102/1L3, FCV/G6L4, FCV/E6L4, FCV/E101/1, FCV/G10L6, FCV/E10L6, FCV/G102/1L6, FCV/E102/1L6, FCV/E101/1, FCV/G101/1, FCV/E101/1, FCV/G102/1...(Other models you can see in the webshop)

| | | | | |
|---|---------|--------|----------|--|
| accessories for 700467 | | | | |
|  | GEV No. | 693937 | Ref. No. | 002717 002722 003090 003091 03303203 03304194 0A5320 0A5365 0F0029 OK1684 OK1685 OK8473 OK9180 OK9181 OK9340 0KE759 234705 |

door handle H 44mm L 220mm W 50mm plastic black

| | | | | |
|---|---------|--------|----------|--|
|  | GEV No. | 700468 | Ref. No. | 002650 0F0173 OKL740 1520893 1550001520893 51520893 |
|---|---------|--------|----------|--|

door catch H 39mm L 69mm W 20mm mounting distance 40mm with roller

| | | | | |
|---|---------|--------|----------|---|
|  | GEV No. | 701412 | Ref. No. | — |
|---|---------|--------|----------|---|





cover cap plastic round ø 11mm black for catch thickness 8mm

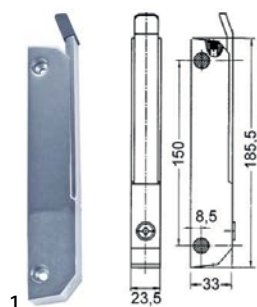

RAHRBACH

6188 ERGO series



| | | | |
|--|---|-----------------|----------------------------------|
| GEV No. | 690808 | Ref. No. | 002278 |
| description | handle latch L 185mm mounting distance 150mm chrome-plated non lockable for headed units 6188 type ERGO | | |
| For models: | FVE3, FVE3, VAPE3 | | |
| accessories for | 690808 | | |
|  | GEV No. | 690110 | Ref. No. — |
| | base plate H 1mm L 38mm W 11mm mounting distance 26mm plastic | | |
|  | GEV No. | 690111 | Ref. No. — |
| | base plate H 2mm L 38mm W 11mm mounting distance 26mm plastic | | |
|  | GEV No. | 690114 | Ref. No. — |
| | base plate H 3.5mm L 185mm W 30mm mounting distance 150mm with inclination thread M5 | | |
|  | GEV No. | 700082 | Ref. No. 056464 056581 |
| | door catch L 38mm W 18mm mounting distance 26mm | | |

STUV

3.30.05xx.x series

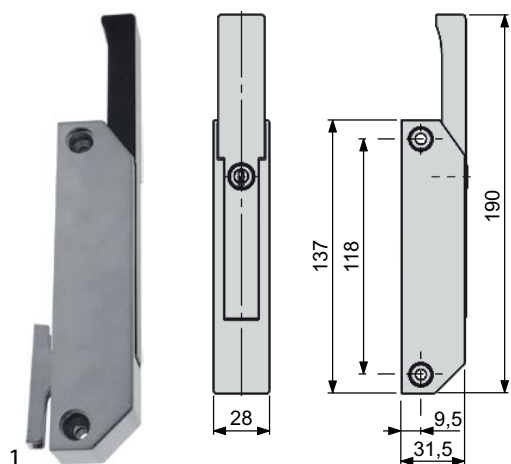

| | | | |
|---|--|-----------------|-------------------|
| GEV No. | 694368 | Ref. No. | OK7566 OKB600 |
| description | handle latch L 137mm mounting distance 118mm refrigeration units 3.30.500.0.003.3 | | |
| For models: | HC-AR, AR85, AR85, AR85, AR85, AR85, AR85, AR85, HC-CS | | |
| spare parts for | 694368 | | |
|  | GEV No. | 700078 | Ref. No. — |
| | door catch L 47mm W 14mm H 29mm mounting distance 21-33mm zinc die cast adjustable | | |

door catches



| | | | |
|--------------------|--|-----------------|--------------------------------------|
| GEV No. | 693778 | Ref. No. | 005176 0H6568 OK1952 242818 |
| description | door catch | | |
| For models: | 5711-2-6, 5711-2-7, 5711-2-8, 5711-2-10, 5711-2-8CH, 5711-2-10CH, 5712-2-6, 5712-2-7, 5712-2-8, 5712-2-10, 5711-2-6L, 5711-2-7L, 5711-2-8L, 5711-2-10L, 5721-2-7, 5721-2-10, 5712-2-6L, 5712-2-7L, 5712-2-8L, 5712-2-10L, 5711-3-6, 5711-3-7, 5711-3-8, 5711-3-10, 5711-3-8CH, 5711-3-10CH, 5712-3-6, 5712-3-7, 5712-3-8, 5712-3-8E, 5712-3-10, 5712-3-8CH, 5712-3-10C, 5712-2-10F, 5712-2-10S, 5711-3-10F, 5711-3-10S, 5712-3-10F, 5712-3-10S, 5702-2-2, 5702-2-3, 5701-3-2, 5701-3-3, 5702-3-2, 5702-3-3, 5611-3-10, 5611-3-6, 5611-3-8, 5612-3-10, 5612-3-6...(Other models you can see in the webshop) | | |





| | | | |
|--------------------|---|-----------------|--|
| GEV No. | 700468 | Ref. No. | 002650 0F0173 OKL740 1520893 1550001520893 51520893 |
| description | door catch H 39mm L 69mm W 20mm mounting distance 40mm with roller | | |
| For models: | FCV/G10L3, FCV/G6L3TOWNGAS, FCV/G6L3, FCVG10L3T, FCVG102L3, FCV/E101/1, FCVE6L3J, FCV/E10L3JAP, FCV/E102/1L3JAP, FCV/E10L-6JAP, FCV/E102/1L6JAP, FCV/G6L3JAP, FCVG10L3J, FCVG102L3J, FCV/G10L6JAP, FCV/G102/1L6JAP, FCVG6L3CJ, FCV/E61/1, FCV/G10L2, FCV/E61/1, FCV/E101/1, FCV/E101/1, FCV/E10L2, FCV/E102/1, FCV/E61/1, FCV/E61/1, FCV/E101/1, FCV/E101/2, FCV/G6L3C, FCV/G61/1, FCV/G61/1, FCV/G61/1, FCV/G61/1, FCVG6L3CT, FCVG6L3CJ, FCV/E10L3, FCV/E102/1, FCV/E6L3, FCV/E102/1L3, FCV/G6L4, FCV/E6L4, FCV/E101/1, FCV/G10L6, FCV/E10L6, FCV/G102/1L6, FCV/E102/1L6, FCV/E101/1, FCV/G101/1, FVC/E101/1, FCV/G102/1...(Other models you can see in the webshop) | | |



| | | | |
|--------------------|--|-----------------|------------------|
| GEV No. | 690123 | Ref. No. | OK8039 OK8574 |
| description | door catch H 69mm D 37mm W 20mm mounting distance 43mm with roller | | |

mechanical components, equipment accessories

| | | | |
|---|---|-----------------|------------------|
|  | | | |
| 1 | | | |
| GEV No. | 700461 | Ref. No. | 002086 0KE741 |
| description | door catch L 22mm thread M5 ø 9mm with spigot total length 45mm thread L 23mm | | |
| For models: | FCFG6D, FCFE6D, FCFE6D, FCFG6, FCFG6F, PFCFG6, FCFE6, FCFE6UK, PFCFE6, FCFE6J50, FCFE6J60, FCFG6J, FCFG6J, FCFG6J, FCFG6J, FCFE6-1U, FCFE6-3U, FCFE6-1, FCFE6-3, FCFE6-1UK, FCFE6-3UK, FCVG6-1, FCVG6-3, FCVG6-1UK, FCVG6-3UK, FCF/G6, FCF/E6, FCV/E6-1, FCV/E6-1, FCV/G6-1, ZOFCV/G6-3, AFCV/G6-1, AFCV/G6-3, SCO/G6-3, AFCF/E6, FF/G6, COCVE423AF, FCFE061, ZOFCF/G6D | | |

| | | | |
|---|--|-----------------|------------------|
|  | | | |
| 2 | | | |
| GEV No. | 700082 | Ref. No. | 056464 056581 |
| description | door catch L 38mm W 18mm mounting distance 26mm | | |
| For models: | FCFG6D, FCFE6D, FCFE6D, FCFG6, FCFG6F, PFCFG6, FCFE6, FCFE6UK, PFCFE6, FCFE6-1U, FCFE6-3U, FCFE6-1, FCFE6-3, FCFE6-3CE, FCFE6-1UK, FCFE6-3UK, FCVG6-1, FCVG6-3, FCVG6-1UK, FCVG6-3UK, FCF/G6, FCF/E6, FCV/E6-1, FCV/E6-1, FCV/G6-1, ZOFCV/G6-3, AFCV/G6-1, AFCV/G6-3, AFCF/E6, FF/G6, COCVE423AF, FCFE061, ZOFCF/G6D | | |

| | | | |
|--|-------------------------|-----------------|--------|
|  | | | |
| 1 | | | |
| GEV No. | 700451 | Ref. No. | 054562 |
| description | door catch with spigot | | |
| For models: | FCFE6UK, COCO6G, COCO6E | | |

snap locks

universal

| | | | |
|---|--|-----------------|------------------|
|  | | | |
| 1 | | | |
| GEV No. | 690596 | Ref. No. | 057414 100906 |
| description | snap lock L 60mm W 15mm H 36mm mounting distance 48/28mm spring thickness 1.5mm complete with door catch zamak | | |
| For models: | BCFCV101/1, BCFCV102/1, BCFCV101/1, BCFCV102/1 | | |

espagnolette locks

universal

| | | | |
|--|---|-----------------|--|
|  | | | |
| 1 | | | |
| GEV No. | 690837 | Ref. No. | 056551 0K2871 0KJ908 5401030 753020379 |
| description | bolt piece L 75mm W 29mm H 28mm cam length 17.5mm cam width 10mm mounting distance 20/40mm | | |
| For models: | FCVE10-2, FCVE10-4, FCVE103CE, FCVE10-2UK, FCVE10-4UK, FCVG10-2, FCVG10-4, FCVG10-ISG, FCVG10-2, FCVG10-4D, FCVG10-2UK, FCVG10-4UK, FCVG10-2, FCVG10-4, FCVE20-2, FCVE20-4, FCVE203CE, FCVE20/P-V, FCVE20-2UK, FCVE20-4UK, FCVG20-2, FCVG20-4, FCVG20-2, FCVG20-4D, FCVG20-2UK, FCVG20-4UK, FCVG20-4, FCVG20-4D, FCVE20-V, FCVE20VUK, FCVE10-P, FCVE10PUK, FCVG10-P, FCVG10PUK, FCVE20-P, FCVE20PUK, C204200-3, C20230-3, C204400-3N, C206400-3N, C20T4/400-, C20P4200-3, C20P4230-3, C20P44003N, C20P64003N, C20PT4/400, FCVG20-P, FCVG20PUK, AFCV/G101, AFCV/G103...(Other models you can see in the webshop) | | |

| | | | |
|--|---|-----------------|---|
|  | | | |
| 1 | | | |
| GEV No. | 690041 | Ref. No. | 003822 0H6727 0K2246 251425 751020943 |
| description | cam L 148mm mounting distance 32mm | | |
| For models: | FDV40G, FDV40E, FDV40GZ, FDV40EL, FDV40GA, FDV20G, FDV20E, FDV20GZ, FDV20EL, FDV20GA, FCZ201EAA, FCZ202EAA, FCZ201E-AH, FCZ201EAN, FCZ201ETA, FCZ202ETA, FCZ201ETH, FCZ201ETN, FCZ201GAG, FCZ202GAG, FCZ201GAD, FCZ202GAD, FCZ201GTG, FCZ202GTG, FCZ201GTD, FCZ202GTD, FCZ201EBA, FCZ202EBA, FCZ201EBH, FCZ201EBN, FCZ201EBC, FCZ201EBA2, FCZ202EBA2, FCZ201EBH2, FCZ201EBN2, FCZ201EBC2, FCZ201GBG, FCZ202GBG, FCZ201GBD, FCZ202GBD, FCZ201GBI, FCZ201GBG2, FCZ202GBG2, FCZ201GBD2, FCZ202GBD2, FCZ201GBI2, FCZ201ECA, FCZ202ECA, FCZ201ECH, FCZ201ECN...(Other models you can see in the webshop) | | |

| | | | |
|---|---|-----------------|----------------------------|
|  | | | |
| 1 | | | |
| GEV No. | 693797 | Ref. No. | 004104 0G1982 234701 |
| description | console upper/lower for cam | | |
| For models: | FDV40G, FDV40E, FDV40GZ, FDV40EL, FDV40GA, FDV20G, FDV20E, FDV20GZ, FDV20EL, FDV20GA, FCV/G20L3, FCVG202L3, FCV/E20L3, FCFE202L3, FCV/G20L6, FCV/E20L6, FCVG202L6, FCFE202L6, FCV/G201/1, FVC/E201/1, FCV/G202/1, FVC/E202/1, FCFG201-0, FCFG202-0, FCFE201-0, FCFE202-0, FCF201ENS, FCS201E4, FCS201EP, FCS202E4, FCS202EP, FCS201G4, FCS201GP, FCS202G4, FCS202GP, FCS201EX, FCS201EXLN, FCS202EX, FCS201GX, FCS202GX, 5714-2-6, 5714-2-7, 5714-2-8, 5714-2-10, 5717-2-6, 5714-2-7, 5714-2-8, 5714-2-10, 5714-2-6L, 5714-2-7L...(Other models you can see in the webshop) | | |



| | | | |
|---|---|-----------------|--------|
|  | | | |
| 1 | | | |
| GEV No. | 690040 | Ref. No. | OKS854 |
| description | door catch with roller H 42mm L 40mm W 40mm zinc die cast mounting distance 26mm type 0751 series | | |

| | | | |
|---|---|-----------------|-----------------------------|
|  | | | |
| 1 | | | |
| GEV No. | 690838 | Ref. No. | 056571 OK2873 5401029 |
| description | door catch with roller H 48mm L 50mm W 26mm mounting distance 28mm rollerø 10mm | | |
| For models: | FCVE10-2, FCVE10-4, FCVE103CE, FCVE10-2UK, FCVE10-4UK, FCVG10-2, FCVG10-4, FCVG10-4SG, FCVG10-2, FCVG10-4D, FCVG10-2UK, FCVG10-4UK, FCVG10-2, FCVG10-4, FCVE20-2, FCVE20-4, FCVE203CE, FCVE20/P-V, FCVE20-2UK, FCVE20-4UK, FCVG20-2, FCVG20-4, FCVG20-2, FCVG20-4D, FCVG20-2UK, FCVG20-4UK, FCVG20-4, FCVG20-4D, FCVE20-V, FCVE20VUK, FCVE10-P, FCVE10PUK, FCVG10-P, FCVG10PUK, FCVE20-P, FCVE20PUK, FCVG20-P, FCVG20PUK, AFCV/G101, AFCV/G103, SCO/G10-3, AFCV/G201, AFCV/G203, SCO/G20-3, FCVG10-4SG, FCV/E20-V | | |





| | | | |
|---|---|-----------------|-----------------------------|
|  | | | |
| 1 | | | |
| GEV No. | 690836 | Ref. No. | 056550 OK3031 5401028 |
| description | latch gear L 17mm W 26mm H 1.5mm mounting distance 42mm shaft diameter 7x7mm | | |
| For models: | FCVE10-2, FCVE10-4, FCVE103CE, FCVE10-2UK, FCVE10-4UK, FCVG10-2, FCVG10-4, FCVG10-4SG, FCVG10-2, FCVG10-4D, FCVG10-2UK, FCVG10-4UK, FCVG10-2, FCVG10-4, FCVE20-2, FCVE20-4, FCVE203CE, FCVE20/P-V, FCVE20-2UK, FCVE20-4UK, FCVG20-2, FCVG20-4, FCVG20-2, FCVG20-4D, FCVG20-2UK, FCVG20-4UK, FCVG20-4, FCVG20-4D, FCVE20-V, FCVE20VUK, FCVE10-P, FCVE10PUK, FCVG10-P, FCVG10PUK, FCVE20-P, FCVE20PUK, FCVG20-P, FCVG20PUK, AFCV/G101, AFCV/G103, SCO/G10-3, AFCV/G201, AFCV/G203, SCO/G20-3, FCVG10-4SG, FCV/E20-V | | |

producer-specific

ELECTROLUX

| | | | |
|---|--|-----------------|--|
|  | | | |
| 1 | | | |
| GEV No. | 700490 | Ref. No. | 005519 OH6728 OK1951 OK2247 OKE636 242817 |
| description | door catch with roller | | |
| For models: | FDV40G, FDV40E, FDV40GZ, FDV40EL, FDV40GA, FDV20G, FDV20E, FDV20GZ, FDV20EL, FDV20GA, FCV/G20L3, FCVG202L3, FCV/E20L3, FCVE202L3, FCV/G20L6, FCV/E20L6, FCVG202L6, FCVE202L6, FCV/G201/1, FVC/E201/1, FCV/G202/1, FVC/E202/1, FCFG201-0, FCFG202-0, FCFE201-0, FCFE202-0, FCF201ENS, 5714-2-6, 5714-2-7, 5714-2-8, 5714-2-10, 5717-2-6, 5714-2-7, 5714-2-8, 5714-2-10, 5714-2-6L, 5714-2-7L, 5714-2-8L, 5714-2-10L, 5714-3-6, 5714-3-7, 5714-3-8, 5714-3-8E, 5714-3-10, 5717-3-6, 5717-3-7...(Other models you can see in the webshop) | | |

| | | | |
|--|---------------------------|-----------------|-------------------------------|
|  | | | |
| 1 | | | |
| GEV No. | 693752 | Ref. No. | OH6729 251427 750010188 |
| description | door handle black plastic | | |

| | | | |
|---|---|-----------------|---|
|  | | | |
| 1 | | | |
| GEV No. | 690042 | Ref. No. | OH6928 OK2719 OKS851 280156 5401006 751020942 |
| description | latch gear opening to the right shaft intake ø 8x8mm L 170mm W 40mm H 40mm | | |
| For models: | 5714-2-6, 5714-2-7, 5714-2-8, 5714-2-10, 5717-2-6, 5714-2-7, 5714-2-8, 5714-2-10, 5714-2-6L, 5714-2-7L, 5714-2-8L, 5714-2-10L, 5714-2-6L, 5714-2-7L, 5714-2-8L, 5714-2-10L, 5714-3-6, 5714-3-7, 5714-3-8, 5714-3-8E, 5714-3-10, 5717-3-6, 5717-3-7, 5717-3-8, 5717-3-8E, 5717-3-10, 5717-3-8M, 5717-3-8C, 5717-3-8M, 5714-2-10F, 5714-2-10S, 5714-3-10F, 5714-3-10S, 5704-2-2, 5704-2-3, 5707-2-2, 57074-2-3, 5704-3-2, 5704-3-3, 5707-3-2, 5707-3-3, 5614-3-10, 5614-3-6, 5614-3-8 | | |
| accessories for | 690042 | | |
|  | GEV No. | 690040 | Ref. No. OKS854 |
| | door catch with roller H 42mm L 40mm W 40mm zinc die cast mounting distance 26mm type 0751 series | | |
|  | GEV No. | 690041 | Ref. No. 003822 OH6727 OK2246 251425 751020943 |
| | cam L 148mm mounting distance 32mm | | |
|  | GEV No. | 691050 | Ref. No. — |
| | bar ø 10mm for door latch L 113.5mm | | |

| | | | |
|---|--|-----------------|----------------------------|
|  | | | |
| 1 | | | |
| GEV No. | 700471 | Ref. No. | 003994 OG2001 OH6996 |
| description | bushing for door handle | | |
| For models: | FDV40G, FDV40E, FDV40GZ, FDV40EL, FDV40GA, FDV20G, FDV20E, FDV20GZ, FDV20EL, FDV20GA, FCV/G20L3, FCVG202L3, FCV/E20L3, FCVE202L3, FCV/G20L6, FCV/E20L6, FCVG202L6, FCVE202L6, FCV/G201/1, FVC/E201/1, FCV/G202/1, FVC/E202/1, FCFG201-0, FCFG202-0, FCFE201-0, FCFE202-0, FCF201ENS, 5714-2-6, 5714-2-7, 5714-2-8, 5714-2-10, 5717-2-6, 5714-2-7, 5714-2-8, 5714-2-10, 5714-2-6L, 5714-2-7L, 5714-2-8L, 5714-2-10L, 5714-3-6, 5714-3-7, 5714-3-8, 5714-3-8E, 5714-3-10, 5717-3-6, 5717-3-7...(Other models you can see in the webshop) | | |

mechanical components, equipment accessories



| | | | |
|--------------------|---|-----------------|----------------------------|
| GEV No. | 693797 | Ref. No. | 004104 OG1982 234701 |
| description | console upper/lower for cam | | |
| For models: | FDV40G, FDV40E, FDV40GZ, FDV40EL, FDV40GA, FDV20G, FDV20E, FDV20GZ, FDV20EL, FDV20GA, FCV/G20L3, FCVG202L3, FCV/E20L3, FCVE202L3, FCV/G20L6, FCV/E20L6, FCVG202L6, FCVE202L6, FCV/G201/1, FVC/E201/1, FCV/G202/1, FVC/E202/1, FCFG201-0, FCFG202-0, FCVE201-0, FCVE202-0, FCF201ENS, FCS201E4, FCS201EP, FCS202E4, FCS202EP, FCS201G4, FCS201GP, FCS202G4, FCS202GP, FCS201EX, FCS201EXLN, FCS202EX, FCS201GX, FCS202GX, 5714-2-6, 5714-2-7, 5714-2-8, 5714-2-10, 5717-2-6, 5714-2-7, 5714-2-8, 5714-2-10, 5714-2-6L, 5714-2-7L...(Other models you can see in the webshop) | | |



| | | | |
|--------------------|--|-----------------|--|
| GEV No. | 700490 | Ref. No. | 005519 0H6728 OK1951 OK2247 0KE636 242817 |
| description | door catch with roller | | |
| For models: | FDV40G, FDV40E, FDV40GZ, FDV40EL, FDV40GA, FDV20G, FDV20E, FDV20GZ, FDV20EL, FDV20GA, FCV/G20L3, FCVG202L3, FCV/E20L3, FCVE202L3, FCV/G20L6, FCV/E20L6, FCVG202L6, FCVE202L6, FCV/G201/1, FVC/E201/1, FCV/G202/1, FVC/E202/1, FCFG201-0, FCFG202-0, FCVE201-0, FCVE202-0, FCF201ENS, 5714-2-6, 5714-2-7, 5714-2-8, 5714-2-10, 5717-2-6, 5714-2-7, 5714-2-8, 5714-2-10, 5717-2-6, 5714-2-7, 5714-2-8, 5714-2-10, 5714-2-6L, 5714-2-7L, 5714-2-8L, 5714-2-10L, 5714-2-6L, 5714-2-7L, 5714-2-8L, 5714-2-10L, 5714-2-6L, 5714-2-7L, 5714-2-8L, 5714-2-10L, 5714-2-6L, 5714-2-7L, 5714-2-8L, 5714-2-10L, 5717-3-6, 5717-3-7...(Other models you can see in the webshop) | | |



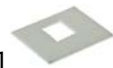

| | | | |
|--------------------|---|-----------------|----------------------------|
| GEV No. | 694366 | Ref. No. | 0J0006 OK1618 OK1619 |
| description | flange for door handle brass L 95mm W 40mm H 28.5mm hole ø 14mm | | |
| For models: | 5714-2-6, 5714-2-7, 5714-2-8, 5714-2-10, 5717-2-6, 5714-2-7, 5714-2-8, 5714-2-10, 5714-2-6L, 5714-2-7L, 5714-2-8L, 5714-2-10L, 5714-2-6L, 5714-2-7L, 5714-2-8L, 5714-2-10L, 5714-3-6, 5714-3-7, 5714-3-8, 5714-3-8E, 5714-3-10, 5717-3-6, 5717-3-7, 5717-3-8, 5717-3-8E, 5717-3-10, 5717-3-8M, 5717-3-8C, 5717-3-8M, 5714-2-10F, 5714-2-10S, 5714-3-10F, 5714-3-10S, 5704-2-2, 5704-2-3, 5707-2-2, 57074-2-3, 5704-3-2, 5704-3-3, 5707-3-2, 5707-3-3, 5614-3-10, 5614-3-6, 5614-3-8 | | |





| | | | |
|--------------------|---|-----------------|--------|
| GEV No. | 700491 | Ref. No. | 003990 |
| description | gasket suitable for JUNO equiv. no. 03990 L 40mm W 35mm door catch thickness 1mm | | |
| For models: | FDV40G, FDV40E, FDV40GZ, FDV40EL, FDV40GA, FDV20G, FDV20E, FDV20GZ, FDV20EL, FDV20GA, FCFG201-0, FCFG202-0, FCVE201-0, FCVE202-0, FCF201ENS, 5714-2-6, 5714-2-7, 5714-2-8, 5714-2-10, 5717-2-6, 5714-2-7, 5714-2-8, 5714-2-10, 5714-2-6L, 5714-2-7L, 5714-2-8L, 5714-2-10L, 5714-2-6L, 5714-2-7L, 5714-2-8L, 5714-2-10L, 5714-3-6, 5714-3-7, 5714-3-8, 5714-3-8E, 5714-3-10, 5717-3-6, 5717-3-7, 5717-3-8, 5717-3-8E, 5717-3-10, 5717-3-8M, 5717-3-8C, 5717-3-8M, 5704-2-2, 5704-2-3, 5707-2-2, 57074-2-3, 5704-3-2, 5704-3-3...(Other models you can see in the webshop) | | |













| | | | |
|------------------------|---|-----------------|--|
| GEV No. | 690042 | Ref. No. | 0H6928 OK2719 OKS851 280156 5401006 751020942 |
| description | latch gear opening to the right shaft intake ø 8x8mm L 170mm W 40mm H 40mm | | |
| For models: | 5714-2-6, 5714-2-7, 5714-2-8, 5714-2-10, 5717-2-6, 5714-2-7, 5714-2-8, 5714-2-10, 5714-2-6L, 5714-2-7L, 5714-2-8L, 5714-2-10L, 5714-2-6L, 5714-2-7L, 5714-2-8L, 5714-2-10L, 5714-3-6, 5714-3-7, 5714-3-8, 5714-3-8E, 5714-3-10, 5717-3-6, 5717-3-7, 5717-3-8, 5717-3-8E, 5717-3-10, 5717-3-8M, 5717-3-8C, 5717-3-8M, 5714-2-10F, 5714-2-10S, 5714-3-10F, 5714-3-10S, 5704-2-2, 5704-2-3, 5707-2-2, 57074-2-3, 5704-3-2, 5704-3-3, 5707-3-2, 5707-3-3, 5614-3-10, 5614-3-6, 5614-3-8 | | |
| accessories for | 690042 | | |
| |  | GEV No. | 690040 |
| | | Ref. No. | OKS854 |
| | door catch with roller H 42mm L 40mm W 40mm zinc die cast mounting distance 26mm type 0751 series | | |
| |  | GEV No. | 690041 |
| | | Ref. No. | 003822 0H6727 OK2246 251425 751020943 |
| | cam L 148mm mounting distance 32mm | | |
| |  | GEV No. | 691050 |
| | | Ref. No. | — |
| | bar ø 10mm for door latch L 113.5mm | | |



| | | | |
|---|---|-----------------|---|
|  | | | |
| 1 | | | |
| GEV No. | 690041 | Ref. No. | 003822 0H6727 0K2246 251425 751020943 |
| description | cam L 148mm mounting distance 32mm | | |
| For models: | FDV40G, FDV40E, FDV40GZ, FDV40EL, FDV40GA, FDV20G, FDV20E, FDV20GZ, FDV20EL, FDV20GA, FCZ201EAA, FCZ202EAA, FCZ201E-AH, FCZ201EAN, FCZ201ETA, FCZ202ETA, FCZ201ETH, FCZ201ETN, FCZ201GAG, FCZ202GAG, FCZ201GAD, FCZ202GAD, FCZ201GTG, FCZ202GTG, FCZ201GTD, FCZ202GTD, FCZ201EBA, FCZ202EBA, FCZ201EBH, FCZ201EBN, FCZ201EBC, FCZ201EBA2, FCZ202EBA2, FCZ201EBH2, FCZ201EBN2, FCZ201EBC2, FCZ201GBG, FCZ202GBG, FCZ201GBD, FCZ202GBD, FCZ201GBI, FCZ201GBG2, FCZ202GBG2, FCZ201GBD2, FCZ202GBD2, FCZ201GBI2, FCZ201ECA, FCZ202ECA, FCZ201ECH, FCZ201ECN...(Other models you can see in the webshop) | | |





| | | | |
|---|---|-----------------|----------------------------|
|  | | | |
| 2 | | | |
| GEV No. | 693797 | Ref. No. | 004104 0G1982 234701 |
| description | console upper/lower for cam | | |
| For models: | FDV40G, FDV40E, FDV40GZ, FDV40EL, FDV40GA, FDV20G, FDV20E, FDV20GZ, FDV20EL, FDV20GA, FCV/G20L3, FCVG202L3, FCV/E20L3, FCVE202L3, FCV/G20L6, FCV/E20L6, FCVG202L6, FCVE202L6, FCV/G201/1, FVC/E201/1, FCV/G202/1, FVC/E202/1, FCFG201-0, FCFG202-0, FCFE201-0, FCFE202-0, FCF201ENS, FCS201E4, FCS201EP, FCS202E4, FCS202EP, FCS201G4, FCS201GP, FCS202G4, FCS202GP, FCS201EX, FCS201EXLN, FCS202EX, FCS201GX, FCS202GX, 5714-2-6, 5714-2-7, 5714-2-8, 5714-2-10, 5717-2-6, 5714-2-7, 5714-2-8, 5714-2-10, 5714-2-6L, 5714-2-7L...(Other models you can see in the webshop) | | |

| | | | |
|---|---|-----------------|---|
|  | | | |
| 1 | | | |
| GEV No. | 694382 | Ref. No. | 004099 |
| description | espagnolette lock complete with flange L 1265mm | | |
| For models: | FDV40G, FDV40E, FDV40GZ, FDV40EL, FDV40GA, FDV20G, FDV20E, FDV20GZ, FDV20EL, FDV20GA, FCFG201-0, FCFG202-0, FCFE201-0, FCFE202-0, FCF201ENS, ECFG201-0, ECFG202-0, ECFE201-0, ECFE202-0, ECF201ENS, ACFG201-0, ACFG202-0, ACFE201-0, ACFE202-0, RCF201E, ZCF/G201/1, ZCF/G202/1, ZCF/E201/1-0, ZCF/E202/1-0 | | |
| spare parts for | 694382 | | |
|  | GEV No. | 690041 | Ref. No. 003822 0H6727 0K2246 251425 751020943 |
| cam L 148mm mounting distance 32mm | | | |
|  | GEV No. | 690042 | Ref. No. 0H6928 0K2719 0K5851 280156 5401006 751020942 |
| latch gear opening to the right shaft intake ø 8x8mm L 170mm W 40mm H 40mm | | | |
|  | GEV No. | 693797 | Ref. No. 004104 0G1982 234701 |
| console upper/lower for cam | | | |
|  | GEV No. | 700472 | Ref. No. 004098 |
| flange for door handle brass L 95mm W 40mm H 15mm hole ø 14mm | | | |

| | | | |
|---|--|-----------------|--|
|  | | | |
| 1 | | | |
| GEV No. | 692846 | Ref. No. | 0C4119 |
| description | espagnolette lock L 1250mm complete ø 10mm for combi-steamer | | |
| For models: | FCZ201EAA, FCZ202EAA, FCZ201EAH, FCZ201EAN, FCZ201GAG, FCZ202GAG, FCZ201GAD, FCZ202GAD, FCZ201EBA, FCZ202EBA, FCZ201EBH, FCZ201EBN, FCZ201GBG, FCZ202GBG, FCZ201GBD, FCZ202GBD, FCZ201ECA, FCZ202ECA, FCZ201ECH, FCZ201ECN, FCZ201GCG, FCZ202GCG, FCZ201GCD, FCZ202GCD, AOS201EAAQ, AOS201EBAQ, AOS202EAAQ, AOS202EBAQ, AOS201EANQ, AOS201EB-NQ, AOS202EANQ, AOS202EBNQ, AOS201EACQ, AOS201EBCQ, AOS201EAHQ, AOS201EBHQ, AOS201GAGQ, AOS201GBGQ, AOS202GAGQ, AOS202GBGQ, AOS201GADQ, AOS201GBDQ, AOS-202GADQ, AOS202GBDQ, AOS201GAIQ, AOS201GALQ, AOS201EAMQ, AOS201EABQ, AOS201GAPQ, AOS202GAPQ...(Other models you can see in the webshop) | | |
| spare parts for | 692846 | | |
|  | GEV No. | 690041 | Ref. No. 003822 0H6727 0K2246 251425 751020943 |
| cam L 148mm mounting distance 32mm | | | |
|  | GEV No. | 692013 | Ref. No. 052061 060920 0H6043 0K8575 |
| roll pin ø 3mm L 16mm | | | |
|  | GEV No. | 694645 | Ref. No. 0C4309 |
| bar for espagnolette lock ø 10mm L 345mm | | | |
|  | GEV No. | 698500 | Ref. No. 0C4310 |
| bar L 435mm ø 9mm | | | |
|  | GEV No. | 700488 | Ref. No. 003824 0K2718 0K8570 0K9189 751020941 |
| latch gear | | | |

| | | | |
|--|---|-----------------|--------|
|  | | | |
| 1 | | | |
| GEV No. | 700472 | Ref. No. | 004098 |
| description | flange for door handle brass L 95mm W 40mm H 15mm hole ø 14mm | | |
| For models: | FDV40G, FDV40E, FDV40GZ, FDV40EL, FDV40GA, FDV20G, FDV20E, FDV20GZ, FDV20EL, FDV20GA, FCV/G20L3, FCVG202L3, FCV/E20L3, FCVE202L3, FCV/G20L6, FCV/E20L6, FCVG202L6, FCVE202L6, FCV/G201/1, FVC/E201/1, FCV/G202/1, FVC/E202/1, FCFG201-0, FCFG202-0, FCFE201-0, FCFE202-0, FCF201ENS, ECFG201-0, ECFG202-0, ECFE201-0, ECFE202-0, ECF201ENS, ECV/G20T4, ECV/E20T4, ECVG202T4, ECFE202T4, ECV/G20T4J, ECV/G20T6, ECV/E20T6, ECVG202T6, ECFE202T6, ACFG201-0, ACFG202-0, ACFE201-0, ACFE202-0, RCF201E, ACV/G20C4, ACVG202C4, ACV/E20C4, ACVE202C4...(Other models you can see in the webshop) | | |

mechanical components, equipment accessories

| | | | |
|---|---|-----------------|--|
|  | | | |
| 1 | | | |
| GEV No. | 690042 | Ref. No. | 0H6928 0K2719 0KS851 280156 5401006 751020942 |
| description | latch gear opening to the right shaft intake ø 8x8mm L 170mm W 40mm H 40mm | | |
| For models: | 5714-2-6, 5714-2-7, 5714-2-8, 5714-2-10, 5717-2-6, 5714-2-7, 5714-2-8, 5714-2-10, 5714-2-6L, 5714-2-7L, 5714-2-8L, 5714-2-10L, 5714-2-6L, 5714-2-7L, 5714-2-8L, 5714-2-10L, 5714-3-6, 5714-3-7, 5714-3-8, 5714-3-8E, 5714-3-10, 5717-3-6, 5717-3-7, 5717-3-8, 5717-3-8E, 5717-3-10, 5717-3-8M, 5717-3-8C, 5717-3-8M, 5714-2-10F, 5714-2-10S, 5714-3-10F, 5714-3-10S, 5704-2-2, 5704-2-3, 5707-2-2, 57074-2-3, 5704-3-2, 5704-3-3, 5707-3-2, 5707-3-3, 5614-3-10, 5614-3-6, 5614-3-8 | | |
| accessories for | 690042 | | |
|  | | | |
| GEV No. | 690040 | Ref. No. | OKS854 |
| description | door catch with roller H 42mm L 40mm W 40mm zinc die cast mounting distance 26mm type 0751 series | | |
|  | | | |
| GEV No. | 690041 | Ref. No. | 003822 0H6727 OK2246 251425 751020943 |
| description | cam L 148mm mounting distance 32mm | | |
|  | | | |
| GEV No. | 691050 | Ref. No. | — |
| description | bar ø 10mm for door latch L 113.5mm | | |

| | | | |
|---|---|-----------------|--------------------------------------|
|  | | | |
| 1 | | | |
| GEV No. | 692013 | Ref. No. | 052061 060920 0H6043 0K8575 |
| description | roll pin ø 3mm L 16mm | | |
| For models: | MCF/G1090, MCF/G1095, MCF/G995, MR/G721, MR/G1071, MR/G1070, MR/G720, MR/G725, MR/G1075, MR/G726, MR/G1076, MFR/G350, MFR/G700, MFR/G350D, MFR/G700D, MFR/G350F, MFR/G700F, MFR/G350E, MFR/G700E, MFR/E355, MFR/E355UK, MFR/E355D, MFR/E705, MFR/E705UK, MFR/E705D, MFR/G740, MFR/E740, MFR/G350, MFR/G351, MFR/G700, MFR/G701, FDV40G, FDV40E, FDV40GZ, FDV40EL, FDV40GA, FDV20G, FDV20E, FDV20GZ, FDV20EL, FDV20GA, RCF/G1095, RR/G720D, 7FTGC7L, 7FTGC1L, RR/G1070D, 7FTGC7M, RR/G1076, RFR/G350, RFR/G700...(Other models you can see in the webshop) | | |

| | | | |
|---|---|-----------------|--------|
|  | | | |
| 1 | | | |
| GEV No. | 694407 | Ref. No. | 0K8572 |
| description | bar for catch straight ø 10mm L 65mm | | |
| For models: | C204200-3, C20230-3, C204400-3N, C206400-3N, C20T4/400-, C20P4200-3, C20P4230-3, C20P44003N, C20P64003N, C20PT4/400 | | |

| | | | |
|--|---|-----------------|--------|
|  | | | |
| 1 | | | |
| GEV No. | 700489 | Ref. No. | 005037 |
| description | bar for door latch ø 10mm L 465mm | | |
| For models: | FCV/G20L3, FCVG20L3, FCV/E20L3, FCVE20L3, FCV/G20L6, FCV/E20L6, FCVG20L6, FCVE20L6, FCV/G201/1, FVC/E201/1, FCV/G202/1, FVC/E202/1, FCS201E4, FCS201EP, FCS202E4, FCS202EP, FCS201G4, FCS201GP, FCS202G4, FCS202GP, FCS201EX, FCS201EXLN, FCS202EX, FCS201GX, FCS202GX, ECV/G20T4, ECV/E20T4, ECVG20T4, ECVE20T4, ECV/G20T4J, ECV/G20T6, ECV/E20T6, ECVG20T6, ECVE20T6, ACV/G20C4, ACVG20C4, ACV/E20C4, ACVE20C4, ACV/G20C6, ACVG20C6, ACVE20C6, ACV/E202/1, ZCV/G20T4, ZCV/E20T4, ZCV/G202/1, ZCV/E202/1, ZCV/G20T6, ZCV/E20T6, ZCV/G202/1, ZCV/E202/1 | | |

| | | | |
|--|--|-----------------|--|
|  | | | |
| 1 | | | |
| GEV No. | 690837 | Ref. No. | 056551 0K2871 OKJ908 5401030 753020379 |
| description | bolt piece L 75mm W 29mm H 28mm cam length 17.5mm cam width 10mm mounting distance 20/40mm | | |
| For models: | FCVE10-2, FCVE10-4, FCVE103CE, FCVE10-2UK, FCVE10-4UK, FCVG10-2, FCVG10-4, FCVG10-1SG, FCVG10-2, FCVG10-4D, FCVG10-2UK, FCVG10-4UK, FCVG10-2, FCVG10-4, FCVE20-2, FCVE20-4, FCVE20/P-V, FCVE20-2UK, FCVE20-4UK, FCVG20-2, FCVG20-4, FCVG20-2, FCVG20-4D, FCVG20-2UK, FCVG20-4UK, FCVG20-4, FCVG20-4D, FCVE20-V, FCVE20VUK, FCVE10-P, FCVE10PUK, FCVG10-P, FCVG10PUK, FCVE20-P, FCVE20PUK, C204200-3, C20230-3, C204400-3N, C206400-3N, C20T4/400-, C20P4200-3, C20P4230-3, C20P44003N, C20P64003N, C20PT4/400, FCVG20-P, FCVG20PUK, AFCV/G101, AFCV/G103...(Other models you can see in the webshop) | | |

| | | | |
|--|--|-----------------|--------|
|  | | | |
| 1 | | | |
| GEV No. | 694413 | Ref. No. | 0F0145 |
| description | espagnolette lock complete L 1010mm | | |
| For models: | CS20ME4/200-3, CS20ME4/230-3, CS20ME6/230-3, CS20ME4/400-3N, CS20ME6/400-3N, CS20ME4/400-3NE, CS20ME4/400-3, CS-20ME4/440-3, CS20MT4/400-3N, CS20MT6/400-3N, CS20GE4/200-3, CS20GE4/230-3, CS20GE6/230-3, CS20GE4/400-3N, CS20GE6/400-3N, CS20GE4/400-3NE, CS20GE4/400-3, CS20GE4/440-3, CS-20GT4/400-3N, CS20GT6/400-3N, CS20LCE4/200-3, CS20LCE4/230-3, CS20LCE6/230-3, CS20LCE4/400-3N, CS20LCE6/400-3N, CS20LCE4/400-3N, CS20LCE4/440-3, CS20LCT4/400-3N, CS20LCT6/400-3N, C204200-3, C20230-3, C204400-3N, C206400-3N, C20T4/400-, C20P4200-3, C20P4230-3, C20P44003N, C20P64003N, C20PT4/400 | | |

| | | | |
|---|---|-----------------|--------------------------------------|
|  | | | |
| 1 | | | |
| GEV No. | 692013 | Ref. No. | 052061 060920 0H6043 0K8575 |
| description | roll pin ø 3mm L 16mm | | |
| For models: | MCF/G1090, MCF/G1095, MCF/G995, MR/G721, MR/G1071, MR/G1070, MR/G720, MR/G725, MR/G1075, MR/G726, MR/G1076, MFR/G350, MFR/G700, MFR/G350D, MFR/G700D, MFR/G350F, MFR/G700F, MFR/G350E, MFR/G700E, MFR/E355, MFR/E355UK, MFR/E355D, MFR/E705, MFR/E705UK, MFR/E705D, MFR/G740, MFR/E740, MFR/G350, MFR/G351, MFR/G700, MFR/G701, FDV40G, FDV40E, FDV40GZ, FDV40EL, FDV40GA, FDV20G, FDV20E, FDV20GZ, FDV20EL, FDV20GA, RCF/G1095, RR/G720D, 7FTGC7L, 7FTGC1L, RR/G1070D, 7FTGC7M, RR/G1076, RFR/G350, RFR/G700...(Other models you can see in the webshop) | | |









| | | | |
|---|---|-----------------|---|
|  | | | |
| 1 | | | |
| GEV No. | 690041 | Ref. No. | 003822 0H6727 0K2246 251425 751020943 |
| description | cam L 148mm mounting distance 32mm | | |
| For models: | FDV40G, FDV40E, FDV40GZ, FDV40EL, FDV40GA, FDV20G, FDV20E, FDV20GZ, FDV20EL, FDV20GA, FCZ201EAA, FCZ202EAA, FCZ201E-AH, FCZ201EAN, FCZ201ETA, FCZ202ETA, FCZ201ETH, FCZ201ETN, FCZ201GAG, FCZ202GAG, FCZ201GAD, FCZ202GAD, FCZ201GTG, FCZ202GTG, FCZ201GTD, FCZ202GTD, FCZ201EBA, FCZ202EBA, FCZ201EBH, FCZ201EBN, FCZ201EBC, FCZ201EBA2, FCZ202EBA2, FCZ201EBH2, FCZ201EBN2, FCZ201EBC2, FCZ201GBG, FCZ202GBG, FCZ201GBD, FCZ202GBD, FCZ201GBI, FCZ201GBG2, FCZ202GBG2, FCZ201GBD2, FCZ202GBD2, FCZ201GBI2, FCZ201ECA, FCZ202ECA, FCZ201ECH, FCZ201ECN...(Other models you can see in the webshop) | | |

| | | | |
|--|---|-----------------|----------------------------|
|  | | | |
| 1 | | | |
| GEV No. | 694366 | Ref. No. | 0J0006 0K1618 0K1619 |
| description | flange for door handle brass L 95mm W 40mm H 28.5mm hole ø 14mm | | |
| For models: | 5714-2-6, 5714-2-7, 5714-2-8, 5714-2-10, 5717-2-6, 5714-2-7, 5714-2-8, 5714-2-10, 5714-2-6L, 5714-2-7L, 5714-2-8L, 5714-2-10L, 5714-2-6L, 5714-2-7L, 5714-2-8L, 5714-2-10L, 5714-3-6, 5714-3-7, 5714-3-8, 5714-3-8E, 5714-3-10, 5717-3-6, 5717-3-7, 5717-3-8, 5717-3-8E, 5717-3-10, 5717-3-8M, 5717-3-8C, 5717-3-8M, 5714-2-10F, 5714-2-10S, 5714-3-10F, 5714-3-10S, 5704-2-2, 5704-2-3, 5707-2-2, 57074-2-3, 5704-3-2, 5704-3-3, 5707-3-2, 5707-3-3, 5614-3-10, 5614-3-6, 5614-3-8 | | |

| | | | |
|---|---|-----------------|----------------------------|
|  | | | |
| 1 | | | |
| GEV No. | 693797 | Ref. No. | 004104 0G1982 234701 |
| description | console upper/lower for cam | | |
| For models: | FDV40G, FDV40E, FDV40GZ, FDV40EL, FDV40GA, FDV20G, FDV20E, FDV20GZ, FDV20EL, FDV20GA, FCV/G20L3, FCVG202L3, FCV/E20L3, FCVE202L3, FCV/G20L6, FCV/E20L6, FCVG202L6, FCVE202L6, FCV/G201/1, FVC/E201/1, FCV/G202/1, FVC/E202/1, FCFG201-0, FCFG202-0, FCFE201-0, FCFE202-0, FCF201ENS, FCS201E4, FCS201EP, FCS202E4, FCS202EP, FCS201G4, FCS201GP, FCS202G4, FCS202GP, FCS201EX, FCS201EXLN, FCS202EX, FCS201GX, FCS202GX, 5714-2-6, 5714-2-7, 5714-2-8, 5714-2-10, 5717-2-6, 5714-2-7, 5714-2-8, 5714-2-10, 5714-2-6L, 5714-2-7L...(Other models you can see in the webshop) | | |

| | | | |
|---|---|-----------------|--------------------------------------|
|  | | | |
| 1 | | | |
| GEV No. | 692013 | Ref. No. | 052061 060920 0H6043 0K8575 |
| description | roll pin ø 3mm L 16mm | | |
| For models: | MCF/G1090, MCF/G1095, MCF/G995, MR/G721, MR/G1071, MR/G1070, MR/G720, MR/G725, MR/G1075, MR/G726, MR/G1076, MFR/G350, MFR/G700, MFR/G350D, MFR/G700D, MFR/G350F, MFR/G700F, MFR/G350E, MFR/G700E, MFR/E355, MFR/E355UK, MFR/E355D, MFR/E705, MFR/E705UK, MFR/E705D, MFR/G740, MFR/E740, MFR/G350, MFR/G351, MFR/G700, MFR/G701, FDV40G, FDV40E, FDV40GZ, FDV40EL, FDV40GA, FDV20G, FDV20E, FDV20GZ, FDV20EL, FDV20GA, RCF/G1095, RR/G720D, 7FTGC7L, 7FTGC1L, RR/G1070D, 7FTGC7M, RR/G1076, RFR/G350, RFR/G700...(Other models you can see in the webshop) | | |

| | | | |
|---|--|-----------------|---|
|  | | | |
| 1 | | | |
| GEV No. | 694381 | Ref. No. | 006246 88390400 |
| description | espagnolette lock complete with flange L 1135mm | | |
| For models: | 5714-2-7, 5714-2-8, 5714-2-10, 5714-2-7, 5714-2-8, 5714-2-10, 5714-2-7L, 5714-2-8L, 5714-2-10L, 5714-2-7L, 5714-2-8L, 5714-2-10L, 5714-3-7, 5714-3-8, 5714-3-8E, 5714-3-10, 5717-3-7, 5717-3-8, 5717-3-8E, 5717-3-10, 5717-3-8M, 5717-3-8M | | |
| spare parts for | 694381 | | |
|  | GEV No. | 690041 | Ref. No. 003822 0H6727 0K2246 251425 751020943 |
| cam L 148mm mounting distance 32mm | | | |
|  | GEV No. | 690042 | Ref. No. 0H6928 0K2719 0K8551 280156 5401006 751020942 |
| latch gear opening to the right shaft intake ø 8x8mm L 170mm W 40mm H 40mm | | | |
|  | GEV No. | 693797 | Ref. No. 004104 0G1982 234701 |
| console upper/lower for cam | | | |
|  | GEV No. | 694366 | Ref. No. 0J0006 0K1618 0K1619 |
| flange for door handle brass L 95mm W 40mm H 28.5mm hole ø 14mm | | | |

| | | | |
|--|--|-----------------|--------|
|  | | | |
| 1 | | | |
| GEV No. | 700489 | Ref. No. | 005037 |
| description | bar for door latch ø 10mm L 465mm | | |
| For models: | FCV/G20L3, FCVG202L3, FCV/E20L3, FCVE202L3, FCV/G20L6, FCV/E20L6, FCVG202L6, FCVE202L6, FCV/G201/1, FVC/E201/1, FCV/G202/1, FVC/E202/1, FCS201E4, FCS201EP, FCS202E4, FCS202EP, FCS201G4, FCS201GP, FCS202G4, FCS202GP, FCS201EX, FCS201EXLN, FCS202EX, FCS201GX, FCS202GX, ECV/G20T4, ECV/E20T4, ECVG202T4, ECVE202T4, ECV/G20T4J, ECV/G20T6, ECV/E20T6, ECVG202T6, ECVE202T6, ACV/G20C4, ACVG202C4, ACV/E20C4, ACVE202C4, ACV/G20C6, ACVG202C6, ACVE20C6, ACV/E202/1, ZCV/G20T4, ZCV/E20T4, ZCV/G202/1, ZCV/E202/1, ZCV/G20T6, ZCV/E20T6, ZCV/G202/1, ZCV/E202/1 | | |

| | | | |
|--|--|-----------------|--------|
|  | | | |
| 1 | | | |
| GEV No. | 691768 | Ref. No. | 005038 |
| description | bar L 420mm ID ø 8mm ext. ø 10 | | |
| For models: | FCV/G20L3, FCVG202L3, FCV/E20L3, FCVE202L3, FCV/G20L6, FCV/E20L6, FCVG202L6, FCVE202L6, FCV/G201/1, FVC/E201/1, FCV/G202/1, FVC/E202/1, FCS201E4, FCS201EP, FCS202E4, FCS202EP, FCS201G4, FCS201GP, FCS202G4, FCS202GP, FCS201EX, FCS201EXLN, FCS202EX, FCS201GX, FCS202GX, ECV/G20T4, ECV/E20T4, ECVG202T4, ECVE202T4, ECV/G20T4J, ECV/G20T6, ECV/E20T6, ECVG202T6, ECVE202T6, ACV/G20C4, ACVG202C4, ACV/E20C4, ACVE202C4, ACV/G20C6, ACVG202C6, ACVE20C6, ACV/E202/1, ZCV/G20T4, ZCV/E20T4, ZCV/G202/1, ZCV/E202/1, ZCV/G20T6, ZCV/E20T6, ZCV/G202/1, ZCV/E202/1 | | |

mechanical components, equipment accessories



| | | | |
|--------------------|---|-----------------|---|
| GEV No. | 690041 | Ref. No. | 003822 0H6727 0K2246 251425 751020943 |
| description | cam L 148mm mounting distance 32mm | | |
| For models: | FDV40G, FDV40E, FDV40GZ, FDV40EL, FDV40GA, FDV20G, FDV20E, FDV20GZ, FDV20EL, FDV20GA, FCZ201EAA, FCZ202EAA, FCZ201E-AH, FCZ201EAN, FCZ201ETA, FCZ202ETA, FCZ201ETH, FCZ201ETN, FCZ201GAG, FCZ202GAG, FCZ201GAD, FCZ202GAD, FCZ201GTG, FCZ202GTG, FCZ201GTD, FCZ202GTD, FCZ201EBA, FCZ202EBA, FCZ201EBH, FCZ201EBN, FCZ201EBC, FCZ201EBA2, FCZ202EBA2, FCZ201EBH2, FCZ201EBN2, FCZ201EBC2, FCZ201GBG, FCZ202GBG, FCZ201GBD, FCZ202GBD, FCZ201GBI, FCZ201GBG2, FCZ202GBG2, FCZ201GBD2, FCZ202GBD2, FCZ201GBI2, FCZ201ECA, FCZ202ECA, FCZ201ECH, FCZ201ECN...(Other models you can see in the webshop) | | |



| | | | |
|--------------------|---|-----------------|----------------------------|
| GEV No. | 693797 | Ref. No. | 004104 0G1982 234701 |
| description | console upper/lower for cam | | |
| For models: | FDV40G, FDV40E, FDV40GZ, FDV40EL, FDV40GA, FDV20G, FDV20E, FDV20GZ, FDV20EL, FDV20GA, FCV/G20L3, FCVG202L3, FCV/E20L3, FCVE202L3, FCV/G20L6, FCV/E20L6, FCVG202L6, FCVE202L6, FCV/G201/1, FVC/E201/1, FCV/G202/1, FVC/E202/1, FCFG201-0, FCFG202-0, FCFE201-0, FCFE202-0, FCF201ENS, FCS201E4, FCS201EP, FCS202E4, FCS202EP, FCS201G4, FCS201GP, FCS202G4, FCS202GP, FCS201EX, FCS201EXLN, FCS202EX, FCS201GX, FCS202GX, 5714-2-6, 5714-2-7, 5714-2-8, 5714-2-10, 5717-2-6, 5714-2-7, 5714-2-8, 5714-2-10, 5714-2-6L, 5714-2-7L...(Other models you can see in the webshop) | | |



| | | | |
|--------------------|--|-----------------|--------|
| GEV No. | 694414 | Ref. No. | 005342 |
| description | espagnolette lock complete with flange L 1310mm | | |
| For models: | FCV/G20L3, FCVG202L3, FCV/E20L3, FCVE202L3, FCV/G20L6, FCV/E20L6, FCVG202L6, FCVE202L6, FCV/G201/1, FVC/E201/1, FCV/G202/1, FVC/E202/1, ECV/G20T4, ECV/E20T4, ECVG202T4, ECVE202T4, ECV/G20T4J, ECV/G20T6, ECV/E20T6, ECVG202T6, ECVE202T6, ACV/G20C4, ACVG202C4, ACV/E20C4, ACVE202C4, ACV/G20C6, ACVG202C6, ACVE20C6, ACV/E202/1, ZCV/G20T4, ZCV/E20T4, ZCV/G202/1, ZCV/E202/1, ZCV/G20T6, ZCV/E20T6, ZCV/G202/1, ZCV/E202/1 | | |



| | | | |
|------------------------|------------------------|-----------------|--|
| accessories for | 694414 | | 005519 0H6728 0K1951 0K2247 0KE636 242817 |
| GEV No. | 700490 | Ref. No. | |
| description | door catch with roller | | |



| | | | |
|--------------------|---|-----------------|--------|
| GEV No. | 700472 | Ref. No. | 004098 |
| description | flange for door handle brass L 95mm W 40mm H 15mm hole ø 14mm | | |
| For models: | FDV40G, FDV40E, FDV40GZ, FDV40EL, FDV40GA, FDV20G, FDV20E, FDV20GZ, FDV20EL, FDV20GA, FCV/G20L3, FCVG202L3, FCV/E20L3, FCVE202L3, FCV/G20L6, FCV/E20L6, FCVG202L6, FCVE202L6, FCV/G201/1, FVC/E201/1, FCV/G202/1, FVC/E202/1, FCFG201-0, FCFG202-0, FCFE201-0, FCFE202-0, FCF201ENS, ECFG201-0, ECFG202-0, ECFE201-0, ECFE202-0, ECF201ENS, ECV/G20T4, ECV/E20T4, ECVG202T4, ECVE202T4, ECV/G20T4J, ECV/G20T6, ECV/E20T6, ECVG202T6, ECVE202T6, ACFG201-0, ACFG202-0, ACFE201-0, ACFE202-0, RCF201E, ACV/G20C4, ACVG202C4, ACV/E20C4, ACVE202C4...(Other models you can see in the webshop) | | |



| | | | |
|--------------------|---|-----------------|--------------------------------------|
| GEV No. | 692013 | Ref. No. | 052061 060920 0H6043 0K8575 |
| description | roll pin ø 3mm L 16mm | | |
| For models: | MCF/G1090, MCF/G1095, MCF/G995, MR/G721, MR/G1071, MR/G1070, MR/G720, MR/G725, MR/G1075, MR/G726, MR/G1076, MFR/G350, MFR/G700, MFR/G350D, MFR/G700D, MFR/G350F, MFR/G700F, MFR/G350E, MFR/G700E, MFR/E355, MFR/E355UK, MFR/E355D, MFR/E705, MFR/E705UK, MFR/E705D, MFR/G740, MFR/E740, MFR/G350, MFR/G351, MFR/G700, MFR/G701, FDV40G, FDV40E, FDV40GZ, FDV40EL, FDV40GA, FDV20G, FDV20E, FDV20GZ, FDV20EL, FDV20GA, RCF/G1095, RR/G720D, 7FTGC7L, 7FTGC1L, RR/G1070D, 7FTGC7M, RR/G1076, RFR/G350, RFR/G700...(Other models you can see in the webshop) | | |

miscellaneous



| | | | |
|--------------------|--|-----------------|--------|
| GEV No. | 700440 | Ref. No. | 003682 |
| description | bolt for catch | | |
| For models: | JCF/G6-1, JCF/G101/1-1, JCF/G102/1-1, JCF/E6-1, JCF/E101/1-1, JCF/E102/1-1, JCF/G6-2, JCF/G101/1-2, JCF/G102/1-2, JCF/E6-2, JCF/E101/1-2, JCF/E102/1-2 | | |



| | | | |
|--------------------|--|-----------------|--------|
| GEV No. | 700452 | Ref. No. | 054854 |
| description | door catch with spigot | | |
| For models: | FCF02EV, FCF02EOEM, FCF/E3, FCF/E2, FCF/E2D, FCF/E2UK, FCF/E2, FCF/E2, FCF/E2D | | |



| | | | |
|--------------------|--|-----------------|--------|
| | | | |
| 1 | | | |
| GEV No. | 694374 | Ref. No. | 0A2413 |
| description | guide ϕ 32/46mm ID ϕ 22.5/26mm L 40mm | | |
| For models: | FF/E40, FF/E10, FF/G10, FF/E20, FF/G20, FF/G40, AFCF/E40 | | |

| | | | |
|--------------------|--|-----------------|--------|
| | | | |
| 1 | | | |
| GEV No. | 701015 | Ref. No. | 005186 |
| description | oven hinge lever length 22mm L 209mm W 20mm Qty 1 pcs | | |
| For models: | FCF/E4, FCF/E4-3KW, JCF/E4, JCF/E4, ECF/E4, ECF/E4-3KW, ACF/E4, ACF/E4-3KW, NCF/E4, ZCF/E4, ZCF/E4 | | |

hinges

oven hinges

| | | | |
|--------------------|--|-----------------|------------------|
| | | | |
| 1 | | | |
| GEV No. | 700003 | Ref. No. | 006091 0K3591 |
| description | opposite support L 110mm W 12mm mounting distance 94mm | | |

| | | | |
|--------------------|---|-----------------|------------------|
| | | | |
| 1 | | | |
| GEV No. | 700457 | Ref. No. | 056439 058934 |
| description | opposite support oven hinge | | |
| For models: | FCF/E4-OLD, FCF/E4D, FCFE4PH, FCF/E4OLD3, FCF/E4OLD4, FCF/E4OLD2, FCF/E4OLD1, FCF/E4D | | |

| | | | |
|--------------------|---|-----------------|--------|
| | | | |
| 1 | | | |
| GEV No. | 701118 | Ref. No. | 006087 |
| description | oven hinge lever length 126mm mounting ear position left L 155mm W 20mm Qty 1 pcs | | |
| For models: | PPL5GG, PPFL5GG | | |

| | | | |
|------------------------|---|-----------------|------------------|
| | | | |
| 1 | | | |
| GEV No. | 700013 | Ref. No. | 0K3593 |
| description | oven hinge mounting distance 118mm lug mounting 13mm lever length 119mm groove distance 13mm spring thickness 3.5mm mounting ear position left spring length 60mm L 154mm | | |
| accessories for | 700013 | | |
| | GEV No. | 700003 | Ref. No. |
| | | | 006091 0K3591 |
| | opposite support L 110mm W 12mm mounting distance 94mm | | |

| | | | |
|------------------------|--|-----------------|------------------|
| | | | |
| 1 | | | |
| GEV No. | 700014 | Ref. No. | 0K3592 |
| description | oven hinge mounting distance 118mm mounting distance 2mm lug mounting 13mm lever length 119mm groove distance 13mm spring thickness 3.5mm mounting ear position right spring length 60mm L 154mm | | |
| accessories for | 700014 | | |
| | GEV No. | 700003 | Ref. No. |
| | | | 006091 0K3591 |
| | opposite support L 110mm W 12mm mounting distance 94mm | | |



1

| | | | |
|--------------------|--|-----------------|--------|
| GEV No. | 701014 | Ref. No. | 058933 |
| description | oven hinge mounting distance 155mm lever length 130mm groove distance 9mm spring thickness 3.5mm spring length 67mm W 20mm Qty 2 pcs | | |
| For models: | FCF/E4-OLD, FCF/E4D, FCFE4PH, FCF/E4OLD3, FCF/E4OLD4, FCF/E4OLD2, FCF/E4OLD1, FCF/E4D | | |



1

| | | | |
|--------------------|---|-----------------|--------|
| GEV No. | 701627 | Ref. No. | 003687 |
| description | oven hinge mounting distance 29mm mounting distance 2 32mm L 115mm mounting pos. lower W 50mm bolt ø 7.8mm bolt 14mm | | |
| For models: | FCF/G6-0, FCF/E6-0, FCF061ELN, FCF6EHOR, FCF061ENS, FCF/G6-1-JAP, FCFE6-1J, ECF/G6/0, ECF/E6-0, ECF061ENS, ECF061E5M, ECF061ECV, ACF/G6-0, ACF/E6-0, JCF/G6-1, JCF/E6-1, JCF/G6-2, JCF/E6-2, RCF061G, RCF061E, NCF/G6-0, NCF/E6-0, ZCF/G6-0, ZCF/E6-0 | | |

door bearing



1

| | | | |
|--------------------|--|-----------------|------------------|
| GEV No. | 700464 | Ref. No. | 054256 055318 |
| description | bolt for hinge | | |
| For models: | FCVE10, FCVE20, FCVE6-1U, FCVE6-3U, FCVE6-1, FCVE6-3, FCVE6-1UK, FCVE6-3UK, FCVG6-1, FCVG6-3, FCVG6-1UK, FCVG6-3UK, FCVE10-2, FCVE10-4, FCVE10-2UK, FCVE10-4UK, FCVG10-2, FCVG10-4, FCVG10-2, FCVG10-4D, FCVG10-2UK, FCVG10-4UK, FCVG10-2, FCVG10-4, FCVE20-2, FCVE20-4, FCVE203CE, FCVE20/P-V, FCVE20-2UK, FCVE20-4UK, FCVG20-2, FCVG20-4, FCVG20-2, FCVG20-4D, FCVG20-2UK, FCVG20-4UK, FCVG20-4, FCVG20-4D, FCVE20-V, FCVE20VUK, FCF/E6-1, FCF/E6-1, FCF/G6-1, ZOFVCV/G6-3, ZOFVCV/E102, ZOFVCV/E104, ZOFVCV/G102, ZOFVCV/G104, ZOFVCV/E202, ZOFVCV/E204...(Other models you can see in the webshop) | | |



1

| | | | |
|--------------------|--|-----------------|--------|
| GEV No. | 700466 | Ref. No. | 059083 |
| description | bolt for hinge | | |
| For models: | FCVE6-1U, FCVE6-3U, FCVE6-1, FCVE6-3, FCVE6-3CE, FCVE6-1UK, FCVE6-3UK, FCVG6-1, FCVG6-3, FCVG6-1UK, FCVG6-3UK, FCVE10-2, FCVE10-4, FCVE103CE, FCVE10-2UK, FCVE10-4UK, FCVG10-1SG, FCVE10-P, FCVE10PUK, FCVG10-P, FCVG10PUK, FCVE20-P, FCVE20PUK, FCVG20-P, FCVG20PUK, FCF/E6-1, FCF/E6-1, FCF/G6-1, ZOFVCV/G6-3, ZOFVCV/E102, ZOFVCV/E104, ACFV/G6-1, ACFV/G6-3, SCO/G6-3, ACFV/G101, ACFV/G103, SCO/G10-3, FCVG10-1SG | | |



1

| | | | |
|--------------------|---|-----------------|--------|
| GEV No. | 701165 | Ref. No. | 003686 |
| description | hinge L 49mm W 50mm H 74mm mounting pos. upper right Qty 1 pcs | | |
| For models: | FCF/G6-0, FCF/E6-0, FCF061ELN, FCF6EHOR, FCF061ENS, FCF/G6-1-JAP, FCFE6-1J, ECF/G6/0, ECF/E6-0, ECF061ENS, ECF061E5M, ECF061ECV, ACF/G6-0, ACF/E6-0, JCF/G6-1, JCF/E6-1, JCF/G6-2, JCF/E6-2, RCF061G, RCF061E, NCF/G6-0, NCF/E6-0, ZCF/G6-0, ZCF/E6-0 | | |



1

| | | | |
|--------------------|--|-----------------|--------|
| GEV No. | 701016 | Ref. No. | 003720 |
| description | hinge L 61.5mm W 49mm H 74mm mounting pos. upper right | | |
| For models: | FCFG101/0, FCFG102-0, FCFG201-0, FCFG202-0, FCFE101-0, FCFE102-0, FCFE201-0, FCFE202-0, FCF101ELN, FCFG10160H, FCF101ENS, FCF102ENS, FCF201ENS, FCFG102-0T, FCF/G101/1-1-JAP, FCF/G102/1-1-JAP, FCFE101-1J, FCFE102-1J, FCF/G101/1, ECFG101-0, ECFG102-0, ECFG201-0, ECFG202-0, ECFE101-0, ECFE102-0, ECFE201-0, ECFE202-0, ECF101ENS, ECF102ENS, ECF201ENS, ACFG101-0, ACFG102-0, ACFG201-0, ACFG202-0, ACFE101-0, ACFE102-0, ACFE201-0, ACFE202-0, ACFG10160H, JCF/G101/1-1, JCF/G102/1-1, JCF/E101/1-1, JCF/E102/1-1, JCF/G101/1-2, JCF/G102/1-2, JCF/E101/1-2, JCF/E102/1-2, RCF101G, RCF101E, RCF201E...(Other models you can see in the webshop) | | |



1

| | | | |
|--------------------|---|-----------------|--------|
| GEV No. | 701017 | Ref. No. | 0F0026 |
| description | hinge L 68mm W 50mm H 72mm mounting pos. bottom right | | |
| For models: | CS7ME4/200-3, CS7ME4/230-3, CS7ME4/400-3N, CS7ME6/400-3N, CS7ME4/400-3N/EO, CS7ME4/400-3/50HZ/MA, CS7ME4/440-3/60HZ/MA, CS7MT4/400-3N, CS7GE4/200-3, CS7GE4/230-3, CS7GE4/400-3N, CS7GE6/400-3N, CS7GE4/400-3N/EO, CS7GE4/400-3/50HZ/MA, CS7GE4/440-3/60HZ/MA, CS7GT4/400-3N, CS7LCE4/200-3, CS7LCE4/230-3, CS7LCE4/400-3N, CS7LCE6/400-3N, CS7LCE4/400-3N/EO, CS7LCE4/400-3/50HZ/M, CS7LCE4/440-3/60HZ/M, CS7LCT4/400-3N, CS10ME4/200-3, CS10ME4/230-3, CS10ME6/230-3, CS10ME4/400-3N, CS10ME6/400-3N, CS10ME4/400-3N/EO, CS10ME4/400-3/50HZ/M, CS10ME4/440-3/60HZ/M, CS10MT4/400-3N, CS10MT6/400-3N, CS10GE4/200-3, CS10GE4/230-3, CS10GE6/230-3, CS10GE4/400-3N, CS10GE6/400-3N, CS10GE4/400-3N/EO, CS10GE4/400-3/50HZ/M, CS10GE4/440-3/60HZ/M, CS10GT4/400-3N, CS10GT6/400-3N, CS10LCE4/200-3, CS10LCE4/230-3, CS10LCE6/230-3, CS10LCE4/400-3N, CS10LCE6/400-3N, CS10LCE4/400-3N/EO...(Other models you can see in the webshop) | | |





| | | | |
|---|---|-----------------|--------|
|  | | | |
| 1 | | | |
| GEV No. | 693775 | Ref. No. | OH7181 |
| description | hinge L 70mm W 45mm H 60mm mounting pos. lower | | |
| For models: | 5611-3-10, 5611-3-6, 5611-3-8, 5612-3-10, 5612-3-6, 5612-3-8, 5614-3-10, 5614-3-6, 5614-3-8 | | |

| | | | |
|---|---|-----------------|--------|
|  | | | |
| 1 | | | |
| GEV No. | 693774 | Ref. No. | OH7182 |
| description | hinge L 70mm W 45mm H 60mm mounting pos. upper | | |
| For models: | 5611-3-10, 5611-3-6, 5611-3-8, 5612-3-10, 5612-3-6, 5612-3-8, 5614-3-10, 5614-3-6, 5614-3-8 | | |

| | | | |
|--|---|-----------------|----------------------------|
|  | | | |
| 1 | | | |
| GEV No. | 693776 | Ref. No. | 005241 005395 OK1659 |
| description | hinge mounting pos. bottom right | | |
| For models: | 5714-2-6, 5714-2-7, 5714-2-8, 5714-2-10, 5717-2-6, 5714-2-7, 5714-2-8, 5714-2-10, 5714-2-6L, 5714-2-7L, 5714-2-8L, 5714-2-10L, 5714-2-6L, 5714-2-7L, 5714-2-8L, 5714-2-10L, 5714-3-6, 5714-3-7, 5714-3-8, 5714-3-8E, 5714-3-10, 5717-3-6, 5717-3-7, 5717-3-8, 5717-3-8E, 5717-3-10, 5717-3-8M, 5717-3-8C, 5704-2-2, 5704-2-3, 5707-2-2, 57074-2-3, 5704-3-2, 5704-3-3, 5707-3-2, 5707-3-3 | | |

| | | | |
|---|--|-----------------|------------------|
|  | | | |
| 1 | | | |
| GEV No. | 693783 | Ref. No. | 005112 OK1661 |
| description | hinge mounting pos. bottom right | | |
| For models: | 5721-2-7, 5721-2-10, 5711-3-7, 5711-3-8, 5711-3-10, 5711-3-10F, 5711-3-10S, 5701-3-2, 5701-3-3 | | |

| | | | |
|---|---|-----------------|------------------|
|  | | | |
| 1 | | | |
| GEV No. | 693767 | Ref. No. | 005110 OK1657 |
| description | hinge mounting pos. lower | | |
| For models: | 5711-2-6, 5711-2-7, 5711-2-8, 5711-2-10, 5711-2-8CH, 5711-2-10CH, 5712-2-6, 5712-2-7, 5712-2-8, 5712-2-10, 5711-2-6L, 5711-2-7L, 5711-2-8L, 5711-2-10L, 5712-2-6L, 5712-2-7L, 5712-2-8L, 5712-2-10L, 5711-3-6, 5711-3-7, 5711-3-8, 5711-3-10, 5711-3-8CH, 5711-3-10CH, 5712-3-6, 5712-3-7, 5712-3-8, 5712-3-8E, 5712-3-10, 5712-3-8CH, 5712-3-10C, 5712-2-10F, 5712-2-10S, 5712-3-10F, 5712-3-10S, 5702-2-2, 5702-2-3, 5702-3-2, 5702-3-3 | | |

| | | | |
|--|--|-----------------|------------------|
|  | | | |
| 1 | | | |
| GEV No. | 693765 | Ref. No. | 005111 OK1655 |
| description | hinge mounting pos. upper | | |
| For models: | 5711-2-6, 5711-2-7, 5711-2-8, 5711-2-10, 5711-2-8CH, 5711-2-10CH, 5712-2-6, 5712-2-7, 5712-2-8, 5712-2-10, 5711-2-6L, 5711-2-7L, 5711-2-8L, 5711-2-10L, 5721-2-7, 5721-2-10, 5712-2-6L, 5712-2-7L, 5712-2-8L, 5712-2-10L, 5711-3-6, 5711-3-7, 5711-3-8, 5711-3-10, 5711-3-8CH, 5711-3-10CH, 5712-3-6, 5712-3-7, 5712-3-8, 5712-3-8E, 5712-3-10, 5712-3-8CH, 5712-3-10C, 5712-2-10F, 5712-2-10S, 5711-3-10F, 5711-3-10S, 5712-3-10F, 5712-3-10S, 5702-2-2, 5702-2-3, 5701-3-2, 5701-3-3, 5702-3-2, 5702-3-3 | | |

| | | | |
|---|---|-----------------|------------------|
|  | | | |
| 1 | | | |
| GEV No. | 693782 | Ref. No. | 005242 OK1658 |
| description | hinge mounting pos. upper right | | |
| For models: | 5714-2-6, 5714-2-7, 5714-2-8, 5714-2-10, 5717-2-6, 5714-2-7, 5714-2-8, 5714-2-10, 5714-2-6L, 5714-2-7L, 5714-2-8L, 5714-2-10L, 5714-2-6L, 5714-2-7L, 5714-2-8L, 5714-2-10L, 5714-3-6, 5714-3-7, 5714-3-8, 5714-3-8E, 5714-3-10, 5717-3-6, 5717-3-7, 5717-3-8, 5717-3-8E, 5717-3-10, 5717-3-8M, 5717-3-8C, 5714-2-10F, 5714-2-10S, 5714-3-10F, 5714-3-10S, 5704-2-2, 5704-2-3, 5707-2-2, 57074-2-3, 5704-3-2, 5704-3-3, 5707-3-2, 5707-3-3 | | |

| | | | |
|--|---|-----------------|------------------|
|  | | | |
| 1 | | | |
| GEV No. | 700475 | Ref. No. | 002652 003721 |
| description | hinge bearing L 125mm W 50mm H 18mm mounting pos. bottom right with bolt | | |
| For models: | FCV/G10L3, FCV/G6L3TOWNGAS, FCV/G6L3, FCV/G10L3T, FCV/G10L3, FCV/E101/1, FCVE6L3J, FCV/E10L3JAP, FCV/E102/1L3JAP, FCV/E10L-6JAP, FCV/E102/1L6JAP, FCV/G6L3JAP, FCV/G10L3J, FCV/G102L3J, FCV/G10L6JAP, FCV/G102/1L6JAP, FCV/G6L3CJ, FCV/E61/1, FCV/G10L2, FCV/E61/1, FCV/E101/1, FCV/E101/1, FCV/E10L2, FCV/E102/1, FCV/E61/1, FCV/E61/1, FCV/E101/1, FCV/E101/2, FCV/G6L3C, FCV/G61/1, FCV/G61/1, FCV/G61/1, FCV/G61/1, FCV/G6L3CT, FCV/G6L3CJ, FCV/E10L3, FCV/E102/1, FCV/E6L3, FCV/E102/1L3, FCV/G6L4, FCV/E6L4, FCV/E101/1, FCV/G10L6, FCV/E10L6, FCV/G102/1L6, FCV/E102/1L6, FCV/E101/1, FCV/G101/1, FVC/E101/1, FCV/G102/1...(Other models you can see in the webshop) | | |

mechanical components, equipment accessories

| | | | |
|---|--|-----------------|--------|
|  | | | |
| 1 | | | |
| GEV No. | 700476 | Ref. No. | 005694 |
| description | hinge bearing mounting pos. bottom right with bolt | | |
| For models: | FDV40G, FDV40E, FDV40GZ, FDV40EL, FDV40GA, FDV20G, FDV20E, FDV20GZ, FDV20EL, FDV20GA, FCV/G20L3, FCVG202L3, FCV/E20L3, FCVE202L3, FCV/G20L6, FCV/E20L6, FCVG202L6, FCVE202L6, FCV/G201/1, FVC/E201/1, FCV/G202/1, FVC/E202/1, FCS201E4, FCS201EP, FCS202E4, FCS202EP, FCS201G4, FCS201GP, FCS202G4, FCS202GP, FCS201EX, FCS201EXLN, FCS202EX, FCS201GX, FCS202GX, ECV/G20T4, ECV/E20T4, ECVG202T4, ECVE202T4, ECV/G20T4J, ECV/G20T6, ECV/E20T6, ECVG202T6, ECVE202T6, ACV/G20C4, ACVG202C4, ACV/E20C4, ACVE202C4, ACV/G20C6, ACVG202C6...(Other models you can see in the webshop) | | |

| | | | |
|---|--|-----------------|--------|
|  | | | |
| 2 | | | |
| GEV No. | 700511 | Ref. No. | 007091 |
| description | hinge bearing mounting pos. bottom right with bolt | | |
| For models: | CL221, AOS202EA2N, AOS202EB2N, AOS202EA, AOS202EB, AOS-201GA, AOS201GB, AOS202GB, AOS202GA | | |

| | | | |
|--|--|-----------------|--------------------------------------|
|  | | | |
| 1 | | | |
| GEV No. | 700480 | Ref. No. | 002875 0F0151 0KE542 0K1114 |
| description | hinge bearing mounting pos. lower with bolt | | |
| For models: | FCV/G10L3, FCV/G6L3TOWNGAS, FCV/G6L3, FCVG10L3T, FCVG102L3, FCV/E101/1, FCV/G20L3, FCVG202L3, FCVE6L3J, FCV/E10L3JAP, FCV/E102/1L3JAP, FCV/E10L6JAP, FCV/E102/1L6JAP, FCV/G6L-3JAP, FCVG10L3J, FCVG102L3J, FCV/G10L6JAP, FCV/G102/1L6JAP, FCVG6L3CJ, FCV/E61/1, FCV/G10L2, FCV/E61/1, FCV/E101/1, FCV/E101/1, FCV/E102, FCV/E102/1, FCV/E61/1, FCV/E61/1, FCV/E101/1, FCV/E101/2, FCV/G6L3C, FCV/G61/1, FCV/G61/1, FCV/G61/1, FCV/G61/1, FCVG6L3CT, FCVG6L3CJ, FCV/E10L3, FCV/E102/1, FCV/E6L3, FCV/E102/1L3, FCV/E20L3, FCVE202L3, FCV/G6L4, FCV/E6L4, FCV/E101/1, FCV/G10L6, FCV/E10L6, FCV/G102/1L6, FCV/E102/1L6...(Other models you can see in the webshop) | | |

| | | | |
|---|--|-----------------|--------|
|  | | | |
| 1 | | | |
| GEV No. | 700462 | Ref. No. | 055415 |
| description | hinge bearing mounting pos. upper right with bolt | | |
| For models: | FCVE6-1U, FCVE6-3U, FCVE6-1, FCVE6-3, FCVE6-3CE, FCVE6-1UK, FCVE6-3UK, FCVG6-1, FCVG6-3, FCVG6-1UK, FCVG6-3UK, FCV/E6-1, FCV/E6-1, FCV/G6-1, ZOFV/G6-3, AFCV/G6-1, AFCV/G6-3, SCO/G6-3 | | |

| | | | |
|--|--|-----------------|----------------------------|
|  | | | |
| 1 | | | |
| GEV No. | 700463 | Ref. No. | 053763 055130 055316 |
| description | hinge bearing mounting pos. upper right with bolt | | |
| For models: | FCFG6D, FCVE6D, FCVE6D, FCFG10, FCFG10D, FCFG10NL, FCVE10, FCVE10UK, FCFG20, FCFG20D, FCFG20F, PFCFG20, FCVE20, FCVE20UK, FCFG40, FCFG41, FCFG40D, FCFG40F, PFCFG40F, FCVE40, FCVE40D, FCVE40UK, PFCFE40F, FCFG6, FCFG6F, PFCFG6, FCVE6, FCVE6UK, PFCFE6, FCVE10, FCVE20, FCVE6J50, FCVE6J60, FCFG10J, FCFG10J, FCVE10J, FCVE10J, FCFG20J, FCFG20J, FCVE20J, FCVE20J, FCFG40J, FCFG40J, FCVE40J, FCVE40J, FCFG6J, FCFG6J, FCFG6J, FCFG6J, FCFG6J, FCFG6J...(Other models you can see in the webshop) | | |

| | | | |
|---|--|-----------------|--------|
|  | | | |
| 1 | | | |
| GEV No. | 700473 | Ref. No. | 002651 |
| description | hinge bearing mounting pos. upper right with bolt | | |
| For models: | FCV/G10L3, FCV/G6L3TOWNGAS, FCV/G6L3, FCVG10L3T, FCVG102L3, FCV/E101/1, FCVE6L3J, FCV/E10L3JAP, FCV/E102/1L3JAP, FCV/E10L-6JAP, FCV/E102/1L6JAP, FCV/G6L3JAP, FCVG10L3J, FCVG102L3J, FCV/G10L6JAP, FCV/G102/1L6JAP, FCVG6L3CJ, FCV/E61/1, FCV/G10L2, FCV/E61/1, FCV/E101/1, FCV/E101/1, FCV/E10L2, FCV/E102/1, FCV/E61/1, FCV/E61/1, FCV/E101/1, FCV/E101/2, FCV/G6L3C, FCV/G61/1, FCV/G61/1, FCV/G61/1, FCVG6L3CT, FCVG6L3CJ, FCV/E10L3, FCV/E102/1, FCV/E6L3, FCV/E102/1L3, FCV/G6L4, FCV/E6L4, FCV/E101/1, FCV/G10L6, FCV/E10L6, FCV/G102/1L6, FCV/E102/1L6, FCV/E101/1, FCV/G101/1, FVC/E101/1, FCV/G102/1...(Other models you can see in the webshop) | | |

| | | | |
|--|--|-----------------|--------------------------------------|
|  | | | |
| 1 | | | |
| GEV No. | 700477 | Ref. No. | 002876 0F0152 0KE543 0T3934 |
| description | hinge bearing mounting pos. upper with bolt | | |
| For models: | FCV/G10L3, FCV/G6L3TOWNGAS, FCV/G6L3, FCVG10L3T, FCVG102L3, FCV/E101/1, FCV/G20L3, FCVG202L3, FCVE6L3J, FCV/E10L3JAP, FCV/E102/1L3JAP, FCV/E10L6JAP, FCV/E102/1L6JAP, FCV/G6L-3JAP, FCVG10L3J, FCVG102L3J, FCV/G10L6JAP, FCV/G102/1L6JAP, FCVG6L3CJ, FCV/E61/1, FCV/G10L2, FCV/E61/1, FCV/E101/1, FCV/E101/1, FCV/E102, FCV/E102/1, FCV/E61/1, FCV/E61/1, FCV/E101/1, FCV/E101/2, FCV/G6L3C, FCV/G61/1, FCV/G61/1, FCV/G61/1, FCV/G61/1, FCVG6L3CT, FCVG6L3CJ, FCV/E10L3, FCV/E102/1, FCV/E6L3, FCV/E102/1L3, FCV/E20L3, FCVE202L3, FCV/G6L4, FCV/E6L4, FCV/E101/1, FCV/G10L6, FCV/E10L6, FCV/G102/1L6, FCV/E102/1L6...(Other models you can see in the webshop) | | |



| | | | |
|---|--|-----------------|--------|
|  | | | |
| 1 | | | |
| GEV No. | 690866 | Ref. No. | 006972 |
| description | hinge bearing with bolt | | |
| For models: | AOS061EABU, AOS061EAFU, AOS061EB, AOS061EA3J, AOS061EB3J, AOS061EA2N, AOS061EB2N, AOS061EB5M, AOS101EB5M, AOS061EB6M, AOS101EB6M, AOS061EA0H, AOS061EB0H, AOS061GA, AOS101GA | | |

| | | | |
|---|--|-----------------|--------|
|  | | | |
| 1 | | | |
| GEV No. | 690867 | Ref. No. | 006980 |
| description | hinge bearing with bolt | | |
| For models: | AOS061GAEU, AOS101GAEU, AOS061GAAU, AOS101GAAU, AOS061EABU, AOS101EABU, AOS061EAFU, AOS101EAFU, AOS061EA, AOS061EB, AOS101EA, AOS101EB, AOS061EA3J, AOS061EB3J, AOS101EA3J, AOS101EB3J, AOS061EA2N, AOS061EB2N, AOS101EA2N, AOS101EB2N, AOS061EB5M, AOS101EB5M, AOS061EB6M, AOS101EB6M, AOS061EA0H, AOS061EB0H, AOS101EA0H, AOS101EB0H, AOS061GA, AOS061GB, AOS101GA, AOS101GB | | |

| | | | |
|---|---|-----------------|--------|
|  | | | |
| 1 | | | |
| GEV No. | 690868 | Ref. No. | 007086 |
| description | hinge bearing with bolt | | |
| For models: | FCZ201EAA, FCZ202EAA, FCZ201EAH, FCZ201EAN, FCZ201ETA, FCZ202ETA, FCZ201ETH, FCZ201ETN, FCZ201GAG, FCZ202GAG, FCZ201GAD, FCZ202GAD, FCZ201GTG, FCZ202GTG, FCZ201GTD, FCZ202GTD, FCZ201EBA, FCZ202EBA, FCZ201EBH, FCZ201EBN, FCZ201EBC, FCZ201EBA2, FCZ202EBA2, FCZ201EBH2, FCZ201EBN2, FCZ201EBC2, FCZ201GBG, FCZ202GBG, FCZ201GBD, FCZ202GBD, FCZ201GBI, FCZ201GBG2, FCZ202GBG2, FCZ201GBD2, FCZ202GBD2, FCZ201GBI2, FCZ201ECA, FCZ202ECA, FCZ201ECH, FCZ201ECN, FCZ201ECA2, FCZ202ECA2, FCZ201ECH2, FCZ201ECN2, FCZ201GCG, FCZ202GCG, FCZ201GCD, FCZ202GCD, FCZ201GCG2, FCZ202GCG2... (Other models you can see in the webshop) | | |

| | | | |
|---|---|-----------------|--------|
|  | | | |
| 1 | | | |
| GEV No. | 700484 | Ref. No. | 007007 |
| description | hinge bearing with bolt | | |
| For models: | FCZ061EAA, FCZ101EAA, FCZ102EAA, FCZ201EAA, FCZ202EAA, FCZ061EAH, FCZ101EAH, FCZ201EAH, FCZ061EAN, FCZ101EAN, FCZ201EAN, FCZ061ETA, FCZ101ETA, FCZ102ETA, FCZ201ETA, FCZ202ETA, FCZ061ETH, FCZ101ETH, FCZ201ETH, FCZ061ETN, FCZ101ETN, FCZ201ETN, FCZ061GAG, FCZ101GAG, FCZ102GAG, FCZ201GAG, FCZ202GAG, FCZ061GAD, FCZ101GAD, FCZ102GAD, FCZ201GAD, FCZ202GAD, FCZ101GTG, FCZ102GTG, FCZ201GTG, FCZ202GTG, FCZ101GTD, FCZ102GTD, FCZ201GTD, FCZ202GTD, FCZ061EBA, FCZ101EBA, FCZ102EBA, FCZ201EBA, FCZ202EBA, FCZ061EBH, FCZ101EBH, FCZ201EBH, FCZ061EBN, FCZ101EBN... (Other models you can see in the webshop) | | |

| | | | |
|---|--|-----------------|--------|
|  | | | |
| 1 | | | |
| GEV No. | 690871 | Ref. No. | 005041 |
| description | hinge bearing without bolt | | |
| For models: | FCV/G20L3, FCV/G20L3, FCV/E20L3, FCVE20L3, FCV/G20L6, FCV/E20L6, FCV/G20L6, FCVE20L6, FCV/G201/1, FVC/E201/1, FCV/G202/1, FVC/E202/1, FCS201E4, FCS201EP, FCS202E4, FCS202EP, FCS201G4, FCS201GP, FCS202G4, FCS202GP, FCS201EX, FCS201EXLN, FCS202EX, FCS201GX, FCS202GX, ECV/G20T4J, ACV/G20C4, ACVG202C4, ACV/E20C4, ACVE202C4, ACV/G20C6, ACVG202C6, ACVE20C6, ACV/E202/1 | | |

miscellaneous

| | | | |
|--|---|-----------------|--------|
|  | | | |
| 1 | | | |
| GEV No. | 519624 | Ref. No. | 003991 |
| description | door hinge for combi-steamer mounting pos. right bottom L 125mm W 50mm | | |
| For models: | FCFG201-0, FCFG202-0, FCFE201-0, FCFE202-0, FCF201ENS, ECFG201-0, ECFG202-0, ECFE201-0, ECFE202-0, ECF201ENS, ACFG201-0, ACFG202-0, ACFE201-0, ACFE202-0, RCF201E, ZCF/G201/1, ZCF/G202/1, ZCF/E201/1-0, ZCF/E202/1-0 | | |

| | | | |
|--|--|-----------------|------------------|
|  | | | |
| 1 | | | |
| GEV No. | 701020 | Ref. No. | 0C5463 0DF006 |
| description | hinge for combi-steamer mounting pos. left | | |
| For models: | FCV31E3, 7CO30, CCO30G, ECO312CF, OTS100 | | |

| | | | |
|--|---|-----------------|------------------|
|  | | | |
| 1 | | | |
| GEV No. | 701019 | Ref. No. | 0C5462 0KB714 |
| description | hinge for combi-steamer mounting pos. right | | |
| For models: | FCV31E3, 7CO30, CCO30G, ECO312CF, OTS100 | | |

mechanical components, equipment accessories

accessories

base plate



| | | | |
|--------------------|---|-----------------|--|
| GEV No. | 700479 | Ref. No. | 002877 0F0149 0KE574 0K1115 30000692 |
| description | base plate for door hinge mounting pos. upper left | | |
| For models: | FCV/G10L3, FCV/G6L3TOWNGAS, FCV/G6L3, FCVG10L3T, FCVG102L3, FCV/E101/1, FCV/G20L3, FCVG202L3, FCVE6L3J, FCV/E10L3JAP, FCV/E102/1L3JAP, FCV/E10L6JAP, FCV/E102/1L6JAP, FCV/G6L-3JAP, FCVG10L3J, FCVG102L3J, FCV/G10L6JAP, FCV/G102/1L6JAP, FCVG6L3CJ, FCV/E61/1, FCV/G10L2, FCV/E61/1, FCV/E101/1, FCV/E101/1, FCV/E10L2, FCV/E102/1, FCV/E61/1, FCV/E61/1, FCV/E101/1, FCV/E101/2, FCV/G6L3C, FCV/G61/1, FCV/G61/1, FCV/G61/1, FCV/G61/1, FCVG6L3CT, FCVG6L3CJ, FCV/E10L3, FCV/E102/1, FCV/E6L3, FCV/E102/1L3, FCV/E20L3, FCVE202L3, FCV/G6L4, FCV/E6L4, FCV/E101/1, FCV/G10L6, FCV/E10L6, FCV/G102/1L6, FCV/E102/1L6...(Other models you can see in the webshop) | | |

miscellaneous



| | | | |
|--------------------|---|-----------------|--|
| GEV No. | 700474 | Ref. No. | 002653 0F0153 0G1988 0K8484 0KE546 273804 |
| description | disc for hinge corrugated | | |
| For models: | FDV40G, FDV40E, FDV40GZ, FDV40EL, FDV40GA, FDV20G, FDV20E, FDV20GZ, FDV20EL, FDV20GA, FCZ201EAA, FCZ202EAA, FCZ201E-AH, FCZ201EAN, FCZ201ETA, FCZ202ETA, FCZ201ETH, FCZ201ETN, FCZ201GAG, FCZ202GAG, FCZ201GAD, FCZ202GAD, FCZ201GTG, FCZ202GTG, FCZ201GTD, FCZ202GTD, FCZ201EBA, FCZ202EBA, FCZ201EBH, FCZ201EBN, FCZ201EBC, FCZ201EBA2, FCZ202EBA2, FCZ201EBH2, FCZ201EBN2, FCZ201EBC2, FCZ201GBG, FCZ202GBG, FCZ201GBD, FCZ202GBD, FCZ201GBI, FCZ201GBG2, FCZ202GBG2, FCZ201GBD2, FCZ202GBD2, FCZ201GBI2, FCZ201ECA, FCZ202ECA, FCZ201ECH, FCZ201ECN...(Other models you can see in the webshop) | | |



| | | | |
|--------------------|---|-----------------|--|
| GEV No. | 700478 | Ref. No. | 002645 0F0166 0K2944 0K8509 0K8738 0KE548 30000731 |
| description | protector for glass door for hinge | | |
| For models: | FCV/G10L3, FCV/G6L3TOWNGAS, FCV/G6L3, FCVG10L3T, FCVG102L3, FCV/E101/1, FCV/G20L3, FCVG202L3, FCVE6L3J, FCV/E10L3JAP, FCV/E102/1L3JAP, FCV/E10L6JAP, FCV/E102/1L6JAP, FCV/G6L-3JAP, FCVG10L3J, FCVG102L3J, FCV/G10L6JAP, FCV/G102/1L6JAP, FCVG6L3CJ, FCV/E61/1, FCV/G10L2, FCV/E61/1, FCV/E101/1, FCV/E101/1, FCV/E10L2, FCV/E102/1, FCV/E61/1, FCV/E61/1, FCV/E101/1, FCV/E101/2, FCV/G6L3C, FCV/G61/1, FCV/G61/1, FCV/G61/1, FCV/G61/1, FCVG6L3CT, FCVG6L3CJ, FCV/E10L3, FCV/E102/1, FCV/E6L3, FCV/E102/1L3, FCV/E20L3, FCVE202L3, FCV/G6L4, FCV/E6L4, FCV/E101/1, FCV/G10L6, FCV/E10L6, FCV/G102/1L6, FCV/E102/1L6...(Other models you can see in the webshop) | | |

pullouts

rollers

rollers

accessories



| | | | |
|--------------------|---|-----------------|--------------------------|
| GEV No. | 560133 | Ref. No. | 0D0503 0U0336 3653 |
| description | hexagonal nut thread M6 H 5mm WS 10 SS DIN/ISO DIN 934 / ISO 4032/8673 Qty 20 pcs | | |
| For models: | K35, CUTE0523, CUTE0538, VARIO-G, K35, KT055, KT056, MC40AS-01, K35-11, K55-01, TR260-01, TR260-02, TR260-03, TR260-04, K55E-01, EL65, XBE10AS-01, BM20AS-01, MC40AS-02, K35-01, K55-02, XBE10AS-02, K35-02, PL15-01, XBE10AS-03, BM20AS-02, K35-03, XBE10S-1, K55E-05, PL15-02, PL15-03, XBE10S-02, XBE10AS-04, BM20AS-03, BM20AS-04, BM30AS-01, BM30AS-02, MC40AS-03, BMX60AS-01, K55-03, XBE10S-03, XBE10S-04, BM20AS-05, BM30AS-03, BMX60AS-02, BM20AS-06, BMX60AS-03, K35-04, K55-04, K35-05...(Other models you can see in the webshop) | | |

fittings for catering equipment

outlet taps

producer-specific

ELECTROLUX



| | | | |
|--------------------|---|-----------------|----------------------------|
| GEV No. | 540658 | Ref. No. | 053108 0K7222 700610 |
| description | ball valve connection 3/4" IT - 3/4" IT DN20 total length 69mm | | |
| For models: | MFR/G350, MFR/G700, MFR/G350D, MFR/G700D, MFR/G350F, MFR/G700F, MFR/G350E, MFR/G700E, MFR/E355, MFR/E355UK, MFR/E355D, MFR/E705, MFR/E705UK, MFR/E705D, RFR/E1S12, RFR/E2D12, XFR/E1S12, XFR/E2D12, JFR/E1S12, JFR/E2D12, MFR/E1S12, MFR/E2D12, RFR/G350, RFR/G700, RFR/G350D, RFR/G700D, RFR/G350F, RFR/G700F, M35GFR, M70GFR, XFR/G350D, XFR/G700D, XFR/G350F, XFR/G700F, XFR/G351, CFR/G351, CFR/G700, RFR/G301, RFR/G300, RFR/G301, RFR/G701, RFR/G701F, HFR/G420, HFR/G420, HFR/G840, HFR/G840, HFR/G840, HFR/E420, HFR/E420UK, HFR/E840...(Other models you can see in the webshop) | | |



| | | | |
|---|--|-----------------|--------|
|  | | | |
| 1 | | | |
| GEV No. | 540978 | Ref. No. | 003378 |
| description | bracket | | |
| For models: | MFR/E355, MFR/E355UK, MFR/E355D, MFR/E705, MFR/E705UK, MFR/E705D, MFR/G740, MFR/E740, MFR/G350, MFR/G351, MFR/G700, MFR/G701, RFR/G1S12, RFR/G2D12, RCP/E2S, XFR/G1S12, XFR/G2D12, JFR/G1S12, JFR/G2D12, MCP/E1SH, MCP/E1SUH, MCP/E2SUHS, MFR/G1S12, MFR/G2D12, MCP/E2S, MCP/E2SH, MCP/E2SUH, MCP/E2SUT, MCP/E2SHB, RFR/E356, RFR/E741, RFR/E701, RFR/G741, 7FRG03S, 7FRG07S, CFR/G741, CFR/E702, M35GFR, M70GFR, CFR/G351, CFR/G701, HFR/G410, HFR/G810, HFR/E410, HFR/E810, HFR/G411, HFR/E411, HFR/E412, HFR/E418, HFR/E818...(Other models you can see in the webshop) | | |

| | | | |
|---|---|-----------------|---------------------------|
|  | | | |
| 2 | | | |
| GEV No. | 110704 | Ref. No. | 00329 004906 0K3527 |
| description | cone handle thread M6 ø 16mm L 25mm plastic black | | |
| For models: | SFRE700, SME350, SME700, SGE350, SFRG350, SFRG700, SFRE350, SFRE700, SME350, SME700, SGE350, SFRG350, SFRG700, SMG350, SMG700, BM35E6U, SFRE350, SFRE351, SFRE700, SFRE701, GR35E6U | | |

| | | | |
|--|--|-----------------|--------|
|  | | | |
| 1 | | | |
| GEV No. | 540979 | Ref. No. | 003377 |
| description | handle rod L 200mm for outlet tap | | |
| For models: | MFR/E355, MFR/E355UK, MFR/E355D, MFR/E705, MFR/E705UK, MFR/E705D, MFR/G740, MFR/E740, MFR/G350, MFR/G351, MFR/G700, MFR/G701, RFR/G1S12, RFR/G2D12, XFR/G1S12, XFR/G2D12, JFR/G1S12, JFR/G2D12, MFR/G1S12, MFR/G2D12, RFR/E356, RFR/E741, RFR/E701, RFR/G741, 7FRG03S, 7FRG07S, CFR/G741, CFR/E702, M35GFR, M70GFR, CFR/G351, CFR/G701, HFR/G410, HFR/G810, HFR/G410D, HFR/G810D, HFR/G410NL, HFR/G810NL, HFR/G411, ZFR/G410, ZFR/G810, ZFR/G410D, ZFR/G810D, ZFR/G411, AFR/G410, AFR/G810, M40GFR90, AFR/G411, AFR/G412, OFR/G810 | | |

aerators and air bleeders

| | | | |
|--|--|-----------------|--|
|  | | | |
| 1 | | | |
| GEV No. | 540949 | Ref. No. | 0H6420 0H9729 0H9963 0K2998 0K5385 0KG799 127296 670420 |
| description | aerator and air bleeder thread 1/2" ET chrome-plated with O-ring L 15mm ø 25mm | | |
| For models: | ACSGRT, GWACOE00RO, FWAA0MOORO, GWACOMOORO, IWKCOE0000, HWAHOEOORO, GWAHOEO000, GWAHOEOORO, FWAHOEOORO, BEN150EW87, HWAJOEOORO, GWAJOEOORO, FWAJOEOORO, BEN200EW87, GWAJOMOORO, FWFJOEX000, FWFJOEXORO, BEN300E.S35.H97, GWAKOEOORO, FWAKOEOORO, IWAKOMOORO, GWAKOMOORO, FWFKOEXORO, FWKKOEOORO, IWALOE0000, IWALOE00RO, BEN400E.S35.H97, BEN400EF97, FWALOE00RO, GWALOMOORO, IVAAOE0000, HVAOE00RO, GVAOE0000, GVAOE00RO, FVAOE00RO, IVKAOE0000, FVKAOE00RO, HVABOE00RO, GVABOE0000, GVABOE00RO, FVABOE00RO, FVFB0EXORO, IVKBOE0000, FVKBOE00RO, IVACOE00RO, BON080EF88, GVACOE00RO, FVACOE00RO, IVACOMOORO, GVACOMOORO...(Other models you can see in the webshop) | | |

drain taps

accessories

| | | | |
|--|--|-----------------|--|
|  | | | |
| 1 | | | |
| GEV No. | 540222 | Ref. No. | 053809 0H6848 0K2958 0K3045 0TR613 68226012 |
| description | O-ring EPDM thickness 2.62mm ID ø 47.3mm Qty 1 pcs | | |
| For models: | FCFG101/0, FCFG102-0, FCFG201-0, FCFG202-0, FCFE101-0, FCFE102-0, FCFE201-0, FCFE202-0, FCF101ELN, FCFG10160H, FCF201ENS, FCFG102-0T, FCF/G101/1-1-JAP, FCF/G102/1-1-JAP, FCFE101-1J, FCFE102-1J, FCF/G101/1, FCFG6D, FCFE6D, FCFE6D, FCFG10, FCFG10D, FCFG10NL, FCFE10, FCFE10UK, FCFG20, FCFG20D, FCFG20F, PFCFG20, FCFE20, FCFE20UK, FCFG40, FCFG41, FCFG40D, FCFG40F, PFCFG40F, FCFE40, FCFE40D, FCFE40UK, PFCFE40F, FCFG6, FCFG6F, PFCFG6, FCFE6, FCFE6UK, PFCFE6, FCVE10, FCVE20, FCFE6J50, FCFE6J60...(Other models you can see in the webshop) | | |

mechanical components, equipment accessories

safety valves



| | | | |
|--------------------|---|-----------------|---|
| GEV No. | 541458 | Ref. No. | OG0122 OK2987 OK5784 OK5785 610515106 75701101 |
| description | safety valve T1: 1/2" T2: 1/2" triggering pressure 1.3bar | | |
| For models: | VARIOSTEAM/S-33.3/F, STEAM-O-MAT | | |

equipment feet and end caps

equipment feet

with screw mounting



| | | | |
|--------------------|--|-----------------|--------|
| GEV No. | 701012 | Ref. No. | 0H2317 |
| description | equipment foot tube ø 50mm H 95-165mm plastic Qty 1 pcs WS 45 | | |
| For models: | CS7ME4/200-3, CS7ME4/230-3, CS7ME4/400-3N, CS7ME6/400-3N, CS7ME4/400-3N/EO, CS7ME4/400-3/50HZ/MA, CS7ME4/440-3/60HZ/MA, CS7MT4/400-3N, CS7GE4/200-3, CS7GE4/230-3, CS7GE4/400-3N, CS7GE6/400-3N, CS7GE4/400-3N/EO, CS7GE4/400-3/50HZ/MA, CS7GE4/440-3/60HZ/MA, CS7GT4/400-3N, CS7LCE4/200-3, CS7LCE4/230-3, CS7LCE4/400-3N, CS7LCE6/400-3N, CS7LCE4/400-3N/EO, CS7LCE4/400-3/50HZ/M, CS7LCE4/440-3/60HZ/M, CS7LCT4/400-3N, C7E4/200-3, C7E4/230-3, C7E4/400-3N, C7E6/400-3N, C7PE4/200-3, C7PE4/230-3, C7PE4/400-3N, C7PT4/400-3N, AR85, AR85, AR85, AR85, AR85, AR85, AR85, AR85, AR85, AR6ES, AR6ES, AR6ES, AR6ES, AR6ES, AR6ES, AR6ES, AR6ES... (Other models you can see in the webshop) | | |

components



| | | | |
|--------------------|--|-----------------|--------|
| GEV No. | 700103 | Ref. No. | 053792 |
| description | equipment foot tube ø 56mm plate sizemm hole distancemm H 130mm SS size 2" Qty 1 pcs | | |
| For models: | ICF110, ICP110, ICP111, ICP130, ICP112, ICF110, ICN110UK, ICF110, AP20, ILP111, ILP221, ILN111, ILNSO120, ILN221, ILNN120, ILNF120, TRN1301, TRNA1301, TRNM1301, TRRN1301, TRF1301, TRN1302, TRNA1302, TRNM1302, TRRN1302, TRN1303, TRNA1303, TRNM1303, TRRN1303, TRN1801, TRNA1801, ARNM1801, TRRN1801, TRF1801, TRN1802, TRNA1802, TRNM1802, TRRN1802, TRN1803, TRNA1803, TRNM1803, TRRN1803, TRN2201, TRNA2201, TRNM2201, TRRN2201, TRF2201, TRN2202, TRNA2202, TRNM2202... (Other models you can see in the webshop) | | |

filters

accessories

fastening material



| | | | |
|--------------------|---|-----------------|------------------|
| GEV No. | 693914 | Ref. No. | 054905 0F0156 |
| description | spring clip for drain filter | | |
| For models: | MCP/E700, MCP/G700, MCP/E700D, MCP/G701, MCP/G710, MCP/G711, MCP/G705, MCP/G706, RCP/G1S, RCP/G2D, RCP/E1S, RCP/E2D, RCP/E2S, XCP/G1S, XCP/G2D, XCP/E1S, XCP/E2D, JCP/G1S, JCP/G2D, JCP/E1S, JCP/E2D, MCP/E1SH, MCP/E1SUH, MCP/E2SUHS, MCP/G1S, MCP/G2D, MCP/E1S, MCP/E2D, MCP/E2S, MCP/E2SH, MCP/E2SUH, MCP/E2SUT, MCP/E2SHB, ACPG2S, 7CPE07P, 7CPG07P, RCP/G701, RCP/G706, M70EPC, M70GPC, M70GPC, XCP/G706, CCP/G700, CCP/E700, ECP/E1ELHU, PCP/G1S, PCP/G2D, PCP/E1S, PCP/E2D, PCP/E2SHP... (Other models you can see in the webshop) | | |

| | | | |
|------------------------|--------|-----------------|--------|
| accessories for | 693914 | | |
| GEV No. | 694000 | Ref. No. | 004836 |
| filter | | | |



mechanical components, equipment accessories



with fixing plate

| | | | |
|---|---|-----------------|--------|
|  | | | |
| 1 | | | |
| GEV No. | 701618 | Ref. No. | 048579 |
| description | equipment foot tube ø 64mm plate size 74x74mm hole distance 58mm H 135-230mm SS | | |
| For models: | BC11, BC22, BC44H, BCF11, BCF22, BCF44H, AQC31U US, AQC60U, AQC119U US, , BC28A6, Crosswise, , BCF15A6, , , BCW061, BCW101, BCW102, BCFW061, BCFW101, BC11, BC22, BC44H, BCF11, BCF22, BCF44H, BCWS061T, BCFW102, BC11, BC22, BC44H, BCF11, BCF22, BCF44H, BCFW5102, BCFW5101, BC15A, Crosswise, BC28A, Crosswise, BC56VA, Crosswise 20, BC56HA, BCF15A, Crosswise, BCF28A, Crosswise, BCF64A, Crosswise 20...(Other models you can see in the webshop) | | |

| | | | |
|---|--|-----------------|--------|
|  | | | |
| 2 | | | |
| GEV No. | 701620 | Ref. No. | 0C4824 |
| description | equipment foot tube ø 64mm plate size 74x74mm hole distance 58mm H 190-250mm SS | | |
| For models: | FCZ201EAA, FCZ202EAA, FCZ201EAH, FCZ201EAN, FCZ201ETA, FCZ202ETA, FCZ201ETH, FCZ201ETN, FCZ201GAG, FCZ202GAG, FCZ201GAD, FCZ202GAD, FCZ201GTG, FCZ202GTG, FCZ201GTD, FCZ202GTD, FCZ201EBA, FCZ202EBA, FCZ201EBH, FCZ201EBN, FCZ201EBC, FCZ201EBA2, FCZ202EBA2, FCZ201EBH2, FCZ201EBN2, FCZ201EBC2, FCZ201GBG, FCZ202GBG, FCZ201GBD, FCZ202GBD, FCZ201GBI, FCZ201GBG2, FCZ202GBG2, FCZ201GBD2, FCZ202GBD2, FCZ201GBI2, FCZ201ECA, FCZ202ECA, FCZ201ECH, FCZ201ECN, FCZ201ECA2, FCZ202ECA2, FCZ201ECH2, FCZ201ECN2, FCZ201GCG, FCZ202GCG, FCZ201GCD, FCZ202GCD, FCZ201GCG2, FCZ202GCG2...(Other models you can see in the webshop) | | |

components

| | | | |
|---|---|-----------------|--------|
|  | | | |
| 1 | | | |
| GEV No. | 700103 | Ref. No. | 053792 |
| description | equipment foot tube ø 56mm plate sizemm hole distancemm H 130mm SS size 2" Qty 1 pcs | | |
| For models: | ICF110, ICP110, ICP111, ICP130, ICP112, ICF110, ICN110UK, ICF110, AP20, ILP111, ILP221, ILN111, ILNSO120, ILN221, ILNN120, ILNF120, TRN1301, TRNA1301, TRNM1301, TRRN1301, TRF1301, TRN1302, TRNA1302, TRNM1302, TRRN1302, TRN1303, TRNA1303, TRNM1303, TRRN1303, TRN1801, TRNA1801, ARNM1801, TRRN1801, TRF1801, TRN1802, TRNA1802, TRNM1802, TRRN1802, TRN1803, TRNA1803, TRNM1803, TRRN1803, TRN2201, TRNA2201, TRNM2201, TRRN2201, TRF2201, TRN2202, TRNA2202, TRNM2202...(Other models you can see in the webshop) | | |



screw-in feet

| | | | |
|---|---|-----------------|--------|
|  | | | |
| 1 | | | |
| GEV No. | 699395 | Ref. No. | 026806 |
| description | equipment foot thread M6 thread L 17mm ø 18mm H 20mm | | |
| For models: | RC/G320, RC/G330, RC/G320F, RC/G720, RC/G730, RC/E320, RC/E320U, RC/E720, RC/E720, MC/G355, MC/G350, MC/G355E, MC/G350D, MC/G355F, MC/G355NL, MC/G705, MC/G700, MC/G705E, MC/G700D, MC/G705NL, MC/G1055, MC/G1050, MC/E350D, MC/E350UK, MC/E700D, MC/E700UK, MC/E1050D, MC/G1050D, MC/G1055NL, MC/G705F, MC/E350, MC/E700, MC/E1050, MI/E350, MI/E700, MI/E350D, MI/E700D, MI/E360, MI/E710, MI/E360D, MI/E710D, MC/G352, MC/G702, MC/G1052, MC/G350, MC/G700, MC/G1050, MR/E350D, MR/E350UK, MR/E360...(Other models you can see in the webshop) | | |

DERBY RUOTE

with fixing plate

chrome-plated steel

| | | | |
|---|---|-----------------|-------------------|
|  | | | |
| 1 | | | |
| GEV No. | 701287 | Ref. No. | 0C2216 |
| description | swivel castor ø 125mm plate fixing housing chrome-plated sheet steel plate size 95x70mm hole distance 70x50mm capacity 100kg bearing cup-and-cone bearing wheel body polypropylene tread TPE tyres H 162mm wheel width 30mm Qty 1 pcs | | |
| For models: | FCZ202EAA, FCZ202ETA, FCZ202GAG, FCZ202GAD, FCZ202GTG, FCZ202GTD, FCZ202EBA, FCZ202EBA2, FCZ202GBG, FCZ202GBD, FCZ202GBG2, FCZ202GBD2, FCZ202ECA, FCZ202ECA2, FCZ202GCG, FCZ202GCD, FCZ202GCG2, FCZ202GCD2, AOS202GAEU, AOS-202GAAU, AOS202EA2N, AOS202EB2N, AOS202EA, AOS202EB, AOS202GB, AOS202GA, AOS202EAAQ, AOS202EBAQ, AOS202EANQ, AOS202EBNQ, AOS202GAGQ, AOS202GBGQ, AOS202GADQ, AOS202GBDQ, AOS202GAPQ, AOS202EAA1, AOS202EAM1, AOS202EAB1, AOS202EAK1, AOS202EAT1, AOS202ETA1, AOS202ETM1, AOS202ETK1, AOS202GAG1, AOS202GAD1, AOS202GAP1, AOS202GAU1, AOS202GTG1, AOS202GTD1, AOS202GTP1...(Other models you can see in the webshop) | | |
| accessories for | 701287 | | |
| | GEV No. | 701286 | Ref. No. — |
| |  swivel castor with swivel brake ø 125mm plate fixing housing chrome-plated sheet steel plate size 95x70mm hole distance 70x50mm capacity 100kg bearing cup-and-cone bearing wheel body polypropylene tread TPE tyres H 162mm wheel width 30mm Qty 1 pcs | | |

mechanical components, equipment accessories



with bolt hole

chrome-plated steel



1

| | | | |
|--------------------|--|-----------------|--------|
| GEV No. | 700200 | Ref. No. | 033657 |
| description | swivel castor ø 100mm bolt hole bolt hole ø 12mm housing chrome-plated sheet steel capacity 80kg bearing ball bearing wheel body polypropylene tread TPE tyres H 132mm wheel width 30mm Qty 1 pcs | | |
| For models: | TG1000RL, TG1100RL, TG1200RL, TG1300RL, TG1400RL, TG1500RL, TG1600RL, TG1700RL, TG1800RL, TG1900RL, TG2000RL, TG1010RL, TG1110RL, TG1210RL, TG1210RL, TG1410RL, TG1510RL, TG1610RL, TG1710RL, TG1810RL, TG1910RL, TG2010RL, TG1000R, TG1100R, TG1200R, TG1300R, TG1400R, TG1500R, TG1600R, TG1700R, TG1800R, TG1900R, TG2000R, TG1010R, TG1110R, TG1210R, TG1310R, TG1410R, TG1510R, TG1610R, TG1710R, TG1810R, TG1910R, TG2010R, TLC1210H, TLC1810H, TLV1210, TLV1810H, TG1000P, TG1100...(Other models you can see in the webshop) | | |

with thread



1

| | | | |
|--------------------|--|-----------------|--------|
| GEV No. | 710012 ¹ | Ref. No. | 0C1631 |
| description | swivel castor with swivel brake ø 100mm thread housing chrome-plated steel capacity 80kg spigot hight 30mm spigot-ø M12mm bearing ball bearing wheel body polypropylene tread TPE tyres H 132mm wheel width 30mm -20 up to +60°C Qty 1 pcs | | |
| For models: | FCZ201EAA, FCZ202EAA, FCZ201EAH, FCZ201EAN, FCZ201ETA, FCZ202ETA, FCZ201ETH, FCZ201ETN, FCZ201GAG, FCZ202GAG, FCZ201GAD, FCZ202GAD, FCZ201GTG, FCZ202GTG, FCZ201GTD, FCZ202GTD, FCZ201EBA, FCZ202EBA, FCZ201EBH, FCZ201EBN, FCZ201EBC, FCZ201EBA2, FCZ202EBA2, FCZ201EBH2, FCZ201EBN2, FCZ201EBC2, FCZ201GBG, FCZ202GBG, FCZ201GBD, FCZ202GBD, FCZ201GBI, FCZ201GBG2, FCZ202GBG2, FCZ201GBD2, FCZ202GBD2, FCZ201GBI2, FCZ201ECA, FCZ202ECA, FCZ201ECH, FCZ201ECN, FCZ201ECA2, FCZ202ECA2, FCZ201ECH2, FCZ201ECN2, FCZ201GCG, FCZ202GCG, FCZ201GCD, FCZ202GCD, FCZ201GCG2, FCZ202GCG2...(Other models you can see in the webshop) | | |

¹with swivel brake

1

| | | | |
|--------------------|---|-----------------|-------------------------------|
| GEV No. | 700207 | Ref. No. | 0E5373 0KB549 461208700 |
| description | swivel castor ø 125mm bolt hole bolt hole ø 12mm housing chrome-plated sheet steel capacity 100kg bearing ball bearing wheel body polypropylene tread TPE tyres H 159mm wheel width 30mm Qty 1 pcs | | |
| For models: | CS10ME4/200-3, CS10ME4/230-3, CS10ME6/230-3, CS10ME4/400-3N, CS10ME6/400-3N, CS10ME4/400-3N/EO, CS10ME4/400-3/50HZ/M, CS10ME4/440-3/60HZ/M, CS10MT4/400-3N, CS10MT6/400-3N, CS10GE4/200-3, CS10GE4/230-3, CS10GE6/230-3, CS10GE4/400-3N, CS10GE6/400-3N, CS10GE4/400-3N/EO, CS10GE4/400-3/50HZ/M, CS10GE4/440-3/60HZ/M, CS10GT4/400-3N, CS10GT6/400-3N, CS10LCE4/200-3, CS10LCE4/230-3, CS10LCE6/230-3, CS10LCE4/400-3N, CS10LCE6/400-3N, CS10LCE4/400-3N/EO, CS10LCE4/400-3/50HZ/, CS10LCE4/440-3/60HZ/, CS10LCT4/400-3N, CS10LCT6/400-3N, CS20ME4/200-3, CS20ME4/230-3, CS20ME6/230-3, CS20ME4/400-3N, CS20ME6/400-3N, CS20ME4/400-3NE, CS20ME4/400-3, CS20ME4/440-3, CS20MT4/400-3N, CS20MT6/400-3N, CS20GE4/200-3, CS20GE4/230-3, CS20GE6/230-3, CS20GE4/400-3N, CS20GE6/400-3N, CS20GE4/400-3NE, CS20GE4/400-3, CS20GT4/400-3N, CS20GT6/400-3N...(Other models you can see in the webshop) | | |



1

| | | | |
|--------------------|---|-----------------|------------------|
| GEV No. | 710025 | Ref. No. | 007107 0C1632 |
| description | swivel castor without brake ø 100mm thread housing chrome-plated steel capacity 80kg spigot hight 30mm spigot-ø M12mm bearing ball bearing wheel body polypropylene tread TPE tyres H 132mm wheel width 30mm -20 up to +60°C Qty 1 pcs | | |
| For models: | FCZ201EAA, FCZ201EAH, FCZ201EAN, FCZ201ETA, FCZ201ETH, FCZ201ETN, FCZ201GAG, FCZ201GAD, FCZ201GTG, FCZ201GTD, FCZ201EBA, FCZ201EBH, FCZ201EBN, FCZ201EBC, FCZ201EBA2, FCZ201EBH2, FCZ201EBN2, FCZ201EBC2, FCZ201GBG, FCZ201GBD, FCZ201GBI, FCZ201GBG2, FCZ201GBD2, FCZ201GBI2, FCZ201ECA, FCZ201ECH, FCZ201ECN, FCZ201ECA2, FCZ201ECH2, FCZ201ECN2, FCZ201GCG, FCZ201GCD, FCZ201GCG2, FCZ201GCD2, CL21, AOS201GAEU, AOS201GAU, AOS201EABU, AOS201EAFU, AOS201EA, AOS201EB, AOS201EA3J, AOS201EB3J, AOS201EA2N, AOS201EB2N, AOS201EB5M, AOS201EB6M, AOS201EA0H, AOS201EB0H, AOS201GA...(Other models you can see in the webshop) | | |

stainless steel



1

| | | | |
|--------------------|---|-----------------|--------|
| GEV No. | 700222 | Ref. No. | 0S1427 |
| description | swivel castor ø 125mm bolt hole bolt hole ø 12mm housing SS capacity 100kg bearing ball bearing wheel body polypropylene tread TPE tyres H 159mm wheel width 30mm Qty 1 pcs | | |



miscellaneous

with bolt hole

ø125mm



| | | | |
|--------------------|---|-----------------|---------------------|
| GEV No. | 710005 | Ref. No. | OK6717 461208704 |
| description | swivel castor with swivel brake ø 125mm bolt hole ø10.5/13mm housing zinc-plated sheet steel capacity 100kg wheel width 30mm MANNER | | |
| For models: | HCCS20W, HCCS20W, LOR, LOT440, LOT470, BUF8W, BUF12W, BU-F8IW, BUF12IW, BUF8S, BUF12S, BUF8L, BUF12L, BUF8BM, BUF12BM, BUF8ROT, BUF12WOT, BUF81WOT, BUF12IWOT, BUF8BMOT, BUF12B-MOT, BUF2BMOT, BUF3BMOT, BUF2BM, BUF3BM, LOT385, AR170, AR170, AR170, AR170, AR170, AR170, AR170, AR170, AR170, AR170, AR170S, AR170S, AR170S, AR170S, AR170S, AR170S, AR170S, AR170S, AR170S, AR170S, AR340, AR340...(Other models you can see in the webshop) | | |

| | | | |
|------------------------|---|-----------------|-------------------|
| GEV No. | 970123 | Ref. No. | 003189 |
| description | grate W 650mm D 530mm GN 2/1 stainless steel wire gauge frame 7.8mm lengthwise wires gauge 3.8mm crossing wires 2 | | |
| For models: | FCV/E102/1, FCV/E102/1 | | |
| accessories for | 970123 | | |
| | GEV No. | 690330 | Ref. No. — |
| | rack L 1000mm W 22mm H 4mm aperture 3x8mm hole distance 12.5mm stainless steel | | |
| | GEV No. | 694700 | Ref. No. — |
| | shelf support L 31/28mm W 22mm H 18mm SS Qty 12 pcs | | |
| | GEV No. | 694701 | Ref. No. — |
| | shelf support L 31/28mm W 22mm H 17mm SS with hook Qty 12 pcs | | |

shelves and shelf rails

grates

universal

without upstand



| | | | |
|------------------------|---|-----------------|-------------------|
| GEV No. | 970120 | Ref. No. | 057468 |
| description | grate W 325mm D 530mm GN 1/1 chrome-plated steel wire gauge frame 7mm lengthwise wires gauge 4mm crossing wires 1 | | |
| For models: | FCFG6D, FCFE6D, FCFE6D, FCFG6, FCFG6F, PFCFG6, FCFE6, FCFE6UK, PFCFE6, FCFE6J50, FCFE6J60, FCFG6J, FCFG6J, FCFG6J, FCFG6J, FCFG6J, FCF/G6, FCF/E6, AFCF/E6, FF/G6, COCO6G, COCO6E, COCVC423AF, FCFE061, ZOFCF/G6D | | |
| accessories for | 970120 | | |
| | GEV No. | 690330 | Ref. No. — |
| | rack L 1000mm W 22mm H 4mm aperture 3x8mm hole distance 12.5mm stainless steel | | |
| | GEV No. | 694700 | Ref. No. — |
| | shelf support L 31/28mm W 22mm H 18mm SS Qty 12 pcs | | |
| | GEV No. | 694701 | Ref. No. — |
| | shelf support L 31/28mm W 22mm H 17mm SS with hook Qty 12 pcs | | |

| | | | |
|------------------------|--|-----------------|-------------------|
| GEV No. | 970527 | Ref. No. | 025020 081883 |
| description | grate W 530mm D 650mm GN 2/1 chrome-plated steel with hinge camp crossing wires 2 suitable for refrigerator | | |
| For models: | ALP110, ALP120, ALP111, ALP220, ALP240, ALP221, ALN110, ALN120, ALN111, ALN220, ALN240, ALN221, ALNN220, ALP110UK, ALN110UK, ALNN220UK, ALF110, ALF220UK, ALNF220, ALF110, ALF120, ALF220, ALF240, ALNF220, ILP110, ILP110UK, ILN120, ILP111, ILP220, ILP220UK, ILP240, ILP221, ILN110, ILN110UK, ILN120, ILN111, ILN220, ILN220UK, ILN240, ILN221, ILNN220, ILNN220UK, ALP110UK, ALN110UK, ALNN220UK, ALF110UK, ALNF220UK, ILF110, ILF110, ILF120...(Other models you can see in the webshop) | | |
| accessories for | 970527 | | |
| | GEV No. | 690330 | Ref. No. — |
| | rack L 1000mm W 22mm H 4mm aperture 3x8mm hole distance 12.5mm stainless steel | | |
| | GEV No. | 694700 | Ref. No. — |
| | shelf support L 31/28mm W 22mm H 18mm SS Qty 12 pcs | | |
| | GEV No. | 694701 | Ref. No. — |
| | shelf support L 31/28mm W 22mm H 17mm SS with hook Qty 12 pcs | | |

mechanical components, equipment accessories



1

| | | | |
|--------------------|---|-----------------|--------|
| GEV No. | 970528 | Ref. No. | 087343 |
| description | grate W 650mm D 530mm GN 2/1 stainless steel with hinge camp crossing wires 2 suitable for refrigerator | | |

shelf rails and supports

producer-specific



1

| | | | |
|--------------------|--|-----------------|--------|
| GEV No. | 690626 | Ref. No. | 031970 |
| description | shelf support L 32mm W 14mm H 20mm | | |
| For models: | TC1200TOP, TC1210TOP, TC1400TOP, TC1410TOP, TC1600TOP, TC1610TOP, TC1800TOP, TC1810TOP, TC2000TOP, TC2010TOP, TCD1200TOP, TCD1400TOP, TCD1600TOP, TCD1800TOP, TCD2000TOP, TF1400, TF1410, TF2000, TF2010, TN1000, TN1010, TN1200, TN1210, TN1400, TN1410, TN1600, TN1610, TN1800, TN1810, TN2000, TN2010, TND1000, TND1200S, TND1400, TND1600, TND1800, TND2000, TC1000, TC1010, TC1200, TC1210, TC1400, TC1410, TC1600, TC1610, TC1800, TC1810, TC2000, TC2010, TCD1000...(Other models you can see in the webshop) | | |

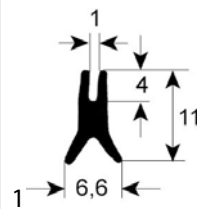

| | | | |
|--------------------|---|-----------------|--------|
| GEV No. | 900752 | Ref. No. | 0K2281 |
| description | window gasket profile 1550 Qty 3m | | |
| For models: | 5714-2-6, 5714-2-7, 5714-2-8, 5714-2-10, 5717-2-6, 5714-2-7, 5714-2-8, 5714-2-10, 5714-2-6L, 5714-2-7L, 5714-2-8L, 5714-2-10L, 5714-2-6L, 5714-2-7L, 5714-2-8L, 5714-2-10L, 5714-3-6, 5714-3-7, 5714-3-8, 5714-3-8E, 5714-3-10, 5717-3-6, 5717-3-7, 5717-3-8, 5717-3-8E, 5717-3-10, 5717-3-8M, 5717-3-8C, 5714-2-10F, 5714-2-10S, 5714-3-10F, 5714-3-10S, 5704-2-2, 5704-2-3, 5707-2-2, 57074-2-3, 5704-3-2, 5704-3-3, 5707-3-2, 5707-3-3 | | |

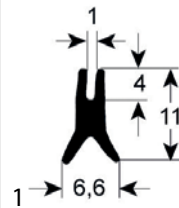

| | | | |
|--------------------|--|-----------------|----------------------------|
| GEV No. | 900591 | Ref. No. | 005109 0H6761 0K2280 |
| description | window gasket profile 1550 Wmm L 3000mm | | |
| For models: | 5711-2-6, 5711-2-7, 5711-2-8, 5711-2-10, 5711-2-8CH, 5711-2-10CH, 5712-2-6, 5712-2-7, 5712-2-8, 5712-2-10, 5711-2-6L, 5711-2-7L, 5711-2-8L, 5711-2-10L, 5721-2-7, 5721-2-10, 5712-2-6L, 5712-2-7L, 5712-2-8L, 5712-2-10L, 5711-3-6, 5711-3-7, 5711-3-8, 5711-3-10, 5711-3-8CH, 5711-3-10CH, 5712-3-6, 5712-3-7, 5712-3-8, 5712-3-8E, 5712-3-10, 5712-3-8CH, 5712-3-10C, 5712-2-10F, 5712-2-10S, 5711-3-10F, 5711-3-10S, 5712-3-10F, 5712-3-10S, 5702-2-2, 5702-2-3, 5701-3-2, 5701-3-3, 5702-3-2, 5702-3-3 | | |

gaskets

gaskets for heated units

window seals

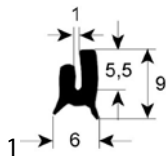

| | | | |
|--------------------|--|-----------------|--|
| GEV No. | 900270 | Ref. No. | 053754 054460 057397 057529 057655 057866 0C1325 |
| description | window gasket profile 1510 Qty 5m | | |
| For models: | HBR/G800, HBR/G805, HBR/G801, HBR/G806, HBR/G810, HBR/G815, HBR/G811, HBR/G816, HBR/G800D, HBR/G805D, HBR/G801D, HBR/G806D, HBR/G810D, HBR/G815D, HBR/G811D, HBR/G816D, HBR/E800, HBR/E805, HBR/E801, HBR/E806, HBR/E810, HBR/E815, HBR/E811, HBR/E816, HBR/G800NL, HBR/G805NL, HBR/G810NL, HBR/G800UK, HBR/E800UK, HBR/G800, HBR/G805, HBR/G810, HBR/G815, HBR/G811, HBR/G816, HBR/E800, HBR/E805, HBR/E810, HBR/E815, HBR/E811, HBR/E816, HBR/G800UK, HBR/E800UK, ZBR/G800, ZBR/G805, ZBR/G801, ZBR/G806, ZBR/G810, ZBR/G815, ZBR/G811...(Other models you can see in the webshop) | | |

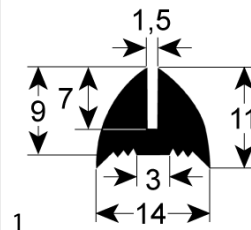

| | | | |
|--------------------|--|-----------------|------------------|
| GEV No. | 901356 | Ref. No. | 0H2421 0K8006 |
| description | window gasket profile 1653 L 1685mm Qty 1 | | |
| For models: | AR170, AR170, AR170, AR170, AR170, AR170, AR170, AR170, AR170, AR170, AR170S, AR170S, AR170S, AR170S, AR170S, AR170S, AR170S, AR170S, AR170S, AR170S, AR170S, AR340S, AR340S, AR340S, AR340S, AR340S, AR340S, AR340S, AR340S, AR10ES, AR10ES, AR10ES, AR10ES, AR10ES, AR10ES, AR10ES, AR10ES, AR10ES, AR10ES, AR10ESP, AR10ESP, AR10ESP, AR10ESP, AR10ESP, AR10ESP, AR10ES, AR10ES, AR10ES, AR10ES...(Other models you can see in the webshop) | | |

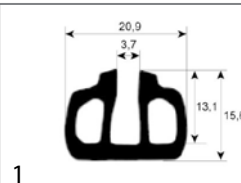

| | | | |
|--------------------|--|-----------------|--------|
| GEV No. | 900036 | Ref. No. | 0H6663 |
| description | window gasket profile 1800 Qty supplied by meter | | |

| | | | |
|--------------------|--|-----------------|--------|
| GEV No. | 900269 | Ref. No. | 003739 |
| description | window gasket profile 1874 perimeter 2060mm Qty 1 | | |
| For models: | FCFG101/0, FCFG102-0, FCFG201-0, FCFG202-0, FCFE101-0, FCFE102-0, FCFE201-0, FCFE202-0, FCF101ELN, FCFG10160H, FCF101ENS, FCF102ENS, FCF201ENS, FCFG102-0T, FCF/G101/1-1-JAP, FCF/G102/1-1-JAP, FCFE101-1J, FCFE102-1J, FCF/G101/1, ECFG101-0, ECFG102-0, ECFG201-0, ECFG202-0, ECFE101-0, ECFE102-0, ECFE201-0, ECFE202-0, ECF101ENS, ECF102ENS, ECF201ENS, ACFG101-0, ACFG102-0, ACFG201-0, ACFG202-0, ACFE101-0, ACFE102-0, ACFE201-0, ACFE202-0, ACFG10160H, JCF/G101/1-1, JCF/G102/1-1, JCF/E101/1-1, JCF/E102/1-1, JCF/G101/1-2, JCF/G102/1-2, JCF/E101/1-2, JCF/E102/1-2, RCF101G, RCF101E, RCF201E...(Other models you can see in the webshop) | | |

| | | | |
|--------------------|---|-----------------|--------|
| GEV No. | 900185 | Ref. No. | 002837 |
| description | window gasket profile 1875 perimeter 1500mm Qty 1 | | |
| For models: | FCV/G6L3TOWNGAS, FCV/G6L3, FCVE6L3J, FCV/G6L3JAP, FCVG6L3CJ, FCV/E61/1, FCV/E61/1, FCV/E61/1, FCV/E61/1, FCV/G6L3C, FCV/G61/1, FCV/G61/1, FCV/G61/1, FCV/G61/1, FCV/G6L3CT, FCVG6L3CJ, FCV/E6L3, FCV/G6L4, FCV/E6L4, ECV/G6T4, ECV/E6T4, ECV/G6T4C, ECV/G61/1, ECV/G61/1, RCV061G2, RCV061E2, RCV061E4, ACV/G6C3, ACV/G6C3C, ACV/E6C3, NCV/G6L2, NCV/E6L2, ZCV/G6T4C, ZCV/G61/1, ZCV/G6T4, ZCV/E6T4 | | |

| | | | |
|--------------------|--|-----------------|----------------------------|
| GEV No. | 900186 | Ref. No. | 002878 0K2279 253249 |
| description | window gasket profile 1875 perimeter 2000mm Qty 1 | | |
| For models: | FCV/G10L3, FCVG10L3T, FCVG102L3, FCV/E101/1, FCV/G20L3, FCVG202L3, FCV/E10L3JAP, FCV/E102/1L3JAP, FCV/E10L6JAP, FCV/E102/1L6JAP, FCVG10L3J, FCVG102L3J, FCV/G10L6JAP, FCV/G102/1L6JAP, FCV/G10L2, FCV/E101/1, FCV/E101/1, FCV/E10L2, FCV/E102/1, FCV/E101/1, FCV/E101/2, FCV/E10L3, FCV/E102/1, FCV/E102/1L3, FCV/E20L3, FCVE202L3, FCV/E101/1, FCV/G10L6, FCV/E10L6, FCV/G102/1L6, FCV/E102/1L6, FCV/G20L6, FCV/E20L6, FCVG202L6, FCVE202L6, FCV/E101/1, FCV/G101/1, FVC/E101/1, FCV/G102/1, FVC/E102/1, FCV/G201/1, FVC/E201/1, FCV/G202/1, FVC/E202/1, FCFG101/0, FCFG102-0, FCFG201-0, FCFG202-0, FCFE101-0, FCFE102-0...(Other models you can see in the webshop) | | |

door seals

| | | | |
|--------------------|--|-----------------|--------|
| GEV No. | 900142 | Ref. No. | OLX024 |
| description | door seal profile 2010 Qty supplied by meter | | |

| | | | |
|--------------------|--|-----------------|--------|
| GEV No. | 900044 | Ref. No. | 0H6655 |
| description | door seal profile 2030 W 414mm L 620mm external size Qty 1 | | |

| | | | |
|--------------------|---|-----------------|--------|
| GEV No. | 900042 ¹ | Ref. No. | 0H6653 |
| description | door seal profile 2030 W 414mm L 620mm external size Qty 1 long side open | | |

¹3-sided (long side open)

| | | | |
|--------------------|--|-----------------|--------|
| GEV No. | 900041 ¹ | Ref. No. | 0H6654 |
| description | door seal profile 2030 W 620mm L 699mm external size Qty 1 short side open | | |

¹3-sided (short side open)

| | | | |
|--------------------|--|-----------------|--------|
| GEV No. | 900189 | Ref. No. | 053751 |
| description | door seal profile 2260 W 645mm L 715mm external size Qty 1 10 x 2/1 | | |
| For models: | FCFG20, FCFG20D, FCFG20F, PFCFG20, FCFE20, FCFE20UK, FCFG201, FCF/E20, COCO20G, COCO20E, FCFE201, ZOCFC/G20D | | |



| | | | |
|--------------------|---|-----------------|--------------------------------------|
| | | | |
| GEV No. | 900577 | Ref. No. | 005710 0F0002 0K8378 0KB642 |
| description | door seal profile 2520 W 450mm L 550mm external size Qty 1 suitable for ELECTROLUX 450x550 | | |
| For models: | CS7ME4/200-3, CS7ME4/230-3, CS7ME4/400-3N, CS7ME6/400-3N, CS7ME4/400-3N/EO, CS7ME4/400-3/50HZ/MA, CS7ME4/440-3/60HZ/MA, CS7MT4/400-3N, CS7GE4/200-3, CS7GE4/230-3, CS7GE4/400-3N, CS7GE6/400-3N, CS7GE4/400-3N/EO, CS7GE4/400-3/50HZ/MA, CS7GE4/440-3/60HZ/MA, CS7GT4/400-3N, CS7LCE4/200-3, CS7LCE4/230-3, CS7LCE4/400-3N, CS7LCE6/400-3N, CS7LCE4/400-3N/EO, CS7LCE4/400-3/50HZ/M, CS7LCE4/440-3/60HZ/M, CS7LCT4/400-3N, C7E4/200-3, C7E4/230-3, C7E4/400-3N, C7E6/400-3N, C7PE4/200-3, C7PE4/230-3, C7PE4/400-3N, C7PT4/400-3N | | |

| | | | |
|--------------------|--|-----------------|------------------|
| | | | |
| GEV No. | 900590 | Ref. No. | 005706 0H6521 |
| description | door seal profile 2520 W 640mm L 730mm external size Qty 1 suitable for ELECTROLUX 640x730 | | |
| For models: | 5712-2-6, 5712-2-7, 5712-2-8, 5712-2-10, 5712-2-6L, 5712-2-7L, 5712-2-8L, 5712-2-10L, 5712-3-6, 5712-3-7, 5712-3-8, 5712-3-8E, 5712-3-10, 5712-3-8CH, 5712-3-10C, 5712-2-10F, 5712-2-10S, 5712-3-10F, 5712-3-10S, 5702-2-2, 5702-2-3, 5702-3-2, 5702-3-3 | | |

| | | | |
|--------------------|---|-----------------|----------------------------|
| | | | |
| GEV No. | 900578 | Ref. No. | 005709 0F0069 0K8379 |
| description | door seal profile 2520 W 450mm L 770mm external size Qty 1 suitable for ELECTROLUX 450x770 | | |
| For models: | CS10ME4/200-3, CS10ME4/230-3, CS10ME6/230-3, CS10ME4/400-3N, CS10ME6/400-3N, CS10ME4/400-3N/EO, CS10ME4/400-3/50HZ/M, CS10ME4/440-3/60HZ/M, CS10MT4/400-3N, CS10MT6/400-3N, CS10GE4/200-3, CS10GE4/230-3, CS10GE6/230-3, CS10GE4/400-3N, CS10GE6/400-3N, CS10GE4/400-3N/EO, CS10GE4/400-3/50HZ/M, CS10GE4/440-3/60HZ/M, CS10GT4/400-3N, CS10GT6/400-3N, CS10LCE4/200-3, CS10LCE4/230-3, CS10LCE6/230-3, CS10LCE4/400-3N, CS10LCE6/400-3N, CS10LCE4/400-3N/EO, CS10LCE4/400-3/50HZ/M, CS10LCE4/440-3/60HZ/M, CS10LCT4/400-3N, CS10LCT6/400-3N, C104200-3, C104230-3, C104400-3N, C106400-3N, C10T4/400-3, C10P4200-3, C10P4230-3, C10P44003N, C10P64003N, C10PT4/400 | | |

| | | | |
|--------------------|--|-----------------|------------------|
| | | | |
| GEV No. | 900434 | Ref. No. | 003995 005711 |
| description | door seal profile 2520 W 655mm L 1400mm external size Qty 1 suitable for ELECTROLUX 660x1400 | | |
| For models: | FDV40G, FDV40E, FDV40GZ, FDV40EL, FDV40GA, FDV20G, FDV20E, FDV20GZ, FDV20EL, FDV20GA, FCV/G20L3, FCVG202L3, FCV/E20L3, FCVE202L3, FCV/G20L6, FCV/E20L6, FCVG202L6, FCVE202L6, FCV/G201/1, FVC/E201/1, FCV/G202/1, FVC/E202/1, FCFG201-0, FCFG202-0, FCFE201-0, FCFE202-0, FCF201ENS, FCS201E4, FCS201EP, FCS202E4, FCS202EP, FCS201G4, FCS201GP, FCS202G4, FCS202GP, FCS201EX, FCS201EXLN, FCS202EX, FCS201GX, FCS202GX, 5714-2-7, 5714-2-8, 5714-2-10, 5714-2-7, 5714-2-8, 5714-2-10, 5714-2-7L, 5714-2-8L, 5714-2-10L, 5714-2-7L...(Other models you can see in the webshop) | | |

| | | | |
|--------------------|---|-----------------|--------------------------------------|
| | | | |
| GEV No. | 900161 | Ref. No. | 003088 005705 0K1842 237389 |
| description | door seal profile 2520 W 640mm L 1400mm external size Qty 1 suitable for ELECTROLUX 640x1400 | | |
| For models: | 5714-2-6, 5714-2-7, 5714-2-8, 5714-2-10, 5717-2-6, 5714-2-7, 5714-2-8, 5714-2-10, 5714-2-6L, 5714-2-7L, 5714-2-8L, 5714-2-10L, 5714-2-6L, 5714-2-7L, 5714-2-8L, 5714-2-10L, 5714-3-6, 5714-3-7, 5714-3-8, 5714-3-8E, 5714-3-10, 5717-3-6, 5717-3-7, 5717-3-8, 5717-3-8E, 5717-3-10, 5717-3-8M, 5717-3-8C, 5714-2-10F, 5714-2-10S, 5714-3-10F, 5714-3-10S, 5704-2-2, 5704-2-3, 5707-2-2, 57074-2-3, 5704-3-2, 5704-3-3, 5707-3-2, 5707-3-3 | | |

| | | | |
|--------------------|---|-----------------|--|
| | | | |
| GEV No. | 900160 | Ref. No. | 002654 004227 005712 0K1840 0KC476 0KE753 237387 |
| description | door seal profile 2520 W 655mm L 725mm external size Qty 1 suitable for ELECTROLUX | | |
| For models: | FCV/G10L3, FCVG10L3T, FCVG102L3, FCV/E101/1, FCV/E10L3JAP, FCV/E102/1L3JAP, FCV/E10L6JAP, FCV/E102/1L6JAP, FCVG10L3J, FCVG102L3J, FCV/G10L6JAP, FCV/G102/1L6JAP, FCV/G10L2, FCV/E101/1, FCV/E101/1, FCV/E101/2, FCV/E101/2, FCV/E10L3, FCV/E102/1L3, FCV/E101/1, FCV/G10L6, FCV/E10L6, FCV/G102/1L6, FCV/E102/1L6, FCV/E101/1, FCV/G101/1, FVC/E101/1, FCV/G102/1, FVC/E102/1, FCFG101/0, FCFG102-0, FCFE101-0, FCFE102-0, FCF101ELN, FCFG10160H, FCF101ENS, FCF102ENS, FCFG102-0T, FCF/G101/1-1-JAP, FCF/G102/1-1-JAP, FCFE101-1J, FCFE102-1J, FCF/G101/1, FCS101E2, FCS101E4J, FCS101EP4J, FCS101G2, FCS101E4, FCS101G4...(Other models you can see in the webshop) | | |

mechanical components, equipment accessories

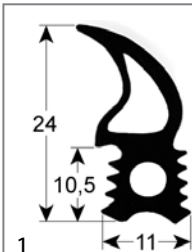

| | | | |
|--------------------|--|-----------------|--------|
| GEV No. | 900930 | Ref. No. | ORT058 |
| description | door seal profile 2715 W 460mm H 770mm outer plug size Qty 1 | | |

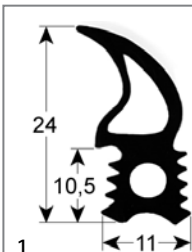

| | | | |
|--------------------|--|-----------------|--------|
| GEV No. | 900369 | Ref. No. | ORT059 |
| description | door seal profile 2715 W 465mm H 510mm outer plug size Qty 1 | | |

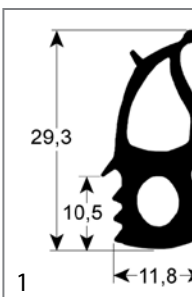

| | | | |
|--------------------|--|-----------------|------------------|
| GEV No. | 900276 | Ref. No. | OC0881 OC1473 |
| description | door seal profile 2760 W 480mm L 1460mm outer plug size Qty 1 suitable for ELECTROLUX 1438x450 | | |
| For models: | FCZ201EAA, FCZ201EAH, FCZ201EAN, FCZ201ETA, FCZ201ETH, FCZ201ETN, FCZ201GAG, FCZ201GAD, FCZ201GTG, FCZ201GTD, FCZ201EBA, FCZ201EBH, FCZ201EBN, FCZ201EBC, FCZ201EBA2, FCZ201EBH2, FCZ201EBN2, FCZ201EBC2, FCZ201GBG, FCZ201GBD, FCZ201GBI, FCZ201GBG2, FCZ201GBD2, FCZ201GBI2, FCZ201ECA, FCZ201ECH, FCZ201ECN, FCZ201ECA2, FCZ201ECH2, FCZ201ECN2, FCZ201GCG, FCZ201GCD, FCZ201GCG2, FCZ201GCD2, AOS201GAEU, AOS201GAAU, AOS201EABU, AOS201EAFU, AOS201EA, AOS201EB, AOS201EA3J, AOS201EB3J, AOS201EA2N, AOS201EB2N, AOS201EB5M, AOS201EB6M, AOS201EA0H, AOS201EB0H, AOS201GA, AOS201GB...(Other models you can see in the webshop) | | |

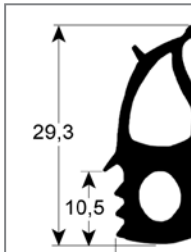

| | | | |
|--------------------|--|-----------------|------------------|
| GEV No. | 900278 | Ref. No. | 006992 OC1496 |
| description | door seal profile 2760 W 480mm L 505mm outer plug size Qty 1 suitable for ELECTROLUX 475x450 | | |
| For models: | FCZ061EAA, FCZ061EAH, FCZ061EAN, FCZ061ETA, FCZ061ETH, FCZ061ETN, FCZ061GAG, FCZ061GAD, FCZ061EBA, FCZ061EBH, FCZ061EBN, FCZ061EBC, FCZ061EBA2, FCZ061EBH2, FCZ061EBN2, FCZ061EBC2, FCZ061GBG, FCZ061GBD, FCZ061GBI, FCZ061ECA, FCZ061ECH, FCZ061ECN, FCZ061ECA2, FCZ061ECH2, FCZ061ECN2, FCZ061GCG, FCZ061GCD, AOS061GAEU, AOS061GAAU, AOS061EABU, AOS061EAFU, AOS061EA, AOS061EB, AOS061EA3J, AOS061EB3J, AOS061EA2N, AOS061EB2N, AOS061EB5M, AOS061EB6M, AOS061EA0H, AOS061EB0H, AOS061GA, AOS061GB, AOS061EAAQ, AOS061EBAQ, AOS061EANQ, AOS061EBNQ, AOS061EACQ, AOS061EBCQ, AOS061EAHQ...(Other models you can see in the webshop) | | |

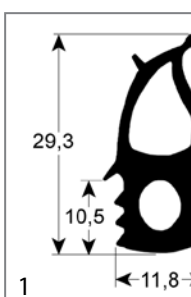

| | | | |
|--------------------|--|-----------------|------------------|
| GEV No. | 900268 | Ref. No. | 007069 OC1477 |
| description | door seal profile 2760 W 480mm L 755mm outer plug size Qty 1 suitable for ELECTROLUX 450x725 | | |
| For models: | FCZ101EAA, FCZ101EAH, FCZ101EAN, FCZ101ETA, FCZ101ETH, FCZ101ETN, FCZ101GAG, FCZ101GAD, FCZ101GTG, FCZ101GTD, FCZ101EBA, FCZ101EBH, FCZ101EBN, FCZ101EBC, FCZ101EBA2, FCZ101EBH2, FCZ101EBN2, FCZ101EBC2, FCZ101GBG, FCZ101GBD, FCZ101GBI, FCZ101GBG2, FCZ101GBD2, FCZ101GBI2, FCZ101ECA, FCZ101ECH, FCZ101ECN, FCZ101ECA2, FCZ101ECH2, FCZ101ECN2, FCZ101GCG, FCZ101GCD, FCZ101GCG2, FCZ101GCD2, AOS101GAEU, AOS101GAAU, AOS101EABU, AOS101EAFU, AOS101EA, AOS101EB, AOS101EA3J, AOS101EB3J, AOS101EA2N, AOS101EB2N, AOS101EB5M, AOS101EB6M, AOS101EA0H, AOS101EB0H, AOS101GA, AOS101GB...(Other models you can see in the webshop) | | |

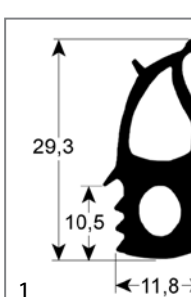

| | | | |
|--------------------|--|-----------------|------------------|
| GEV No. | 900267 | Ref. No. | OC1195 OC1889 |
| description | door seal profile 2760 W 660mm L 1460mm outer plug size Qty 1 suitable for ELECTROLUX 1438x630 | | |
| For models: | AOS202GAEU, AOS202GAAU, AOS202EA2N, AOS202EB2N, AOS202EA, AOS202EB, AOS202GB, AOS202GA, AOS202EAAQ, AOS202EBAQ, AOS202EANQ, AOS202EBNQ, AOS202GAGQ, AOS202GBGQ, AOS202GADQ, AOS202GBDQ, AOS202GAPQ | | |

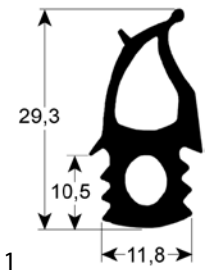
| | | | |
|--------------------|--|-----------------|------------------|
| GEV No. | 901146 | Ref. No. | 0C1218 0C1887 |
| description | door seal profile 2760 W 665mm L 760mm outer plug size Qty 1 suitable for ELECTROLUX 725x630 | | |
| For models: | FCZ102EAA, FCZ102ETA, FCZ102GAG, FCZ102GAD, FCZ102GTG, FCZ102GTD, FCZ102EBA, FCZ102EBA2, FCZ102GBG, FCZ102GBD, FCZ102GBG2, FCZ102GBD2, FCZ102GBI2, FCZ102ECA, FCZ102ECA2, FCZ102GCG, FCZ102GCD, FCZ102GCG2, FCZ102GCD2, AOS-102GAEU, AOS102GAAU, AOS102EA2N, AOS102EB2N, AOS102EA, AOS102EB, AOS102GB, AOS102GA, AOS102EAAQ, AOS102EBAQ, AOS102EANQ, AOS102EBNQ, AOS102GAGQ, AOS102GBGQ, AOS102GADQ, AOS102GBDQ, AOS102EAMQ, AOS102EABQ, AOS-102GAPQ, AOS102EAA1, AOS102EAC1, AOS102EAS1, AOS102EAM1, AOS102EAB1, AOS102EAK1, AOS102EAT1, AOS102ETA1, AOS102ETM1, AOS102ETK1, AOS102GAG1, AOS102GAD1...(Other models you can see in the webshop) | | |

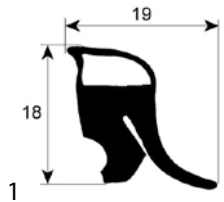

| | | | |
|--------------------|--|-----------------|------------------|
| GEV No. | 900764 | Ref. No. | 0H2492 0K8159 |
| description | door seal profile 2921 L 1600mm Qty 1 | | |
| For models: | AR6ES, AR6ES, AR6ES, AR6ES, AR6ES, AR6ES, AR6ES, AR6ES, AR6ES, AR6ES, AR6ES, AR6ES, AR6ES, AR6ES, AR6ES, AR6E, AR6E, AR6E, AR6E, AR6E, AR6EP, AR6EP, AR6EP | | |



| | | | |
|--------------------|---|-----------------|--------|
| GEV No. | 901603 | Ref. No. | 0LX015 |
| description | door seal profile 2770/2771 H 800mm W 760mm outer plug size Qty 1 | | |



| | | | |
|--------------------|--|-----------------|-------------------|
| GEV No. | 900145 | Ref. No. | 003384 1501396 |
| description | door seal profile 2940 W 600mm L 670mm external size Qty 1 | | |



| | | | |
|--------------------|--|-----------------|----------------------------|
| GEV No. | 900306 | Ref. No. | 057396 057528 057656 |
| description | door seal profile 2947 Qty supplied by meter | | |

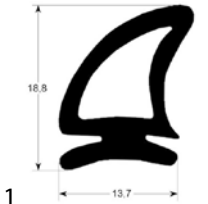

| | | | |
|--------------------|--|-----------------|--|
| GEV No. | 900753 | Ref. No. | 0H2270 0K7510 0K7513 0K9171 LM3524 |
| description | door seal profile 2905 Qty supplied by meter | | |



| | | | |
|--------------------|--|-----------------|--------|
| GEV No. | 900147 | Ref. No. | 0H6760 |
| description | door seal profile 2950 Qty supplied by meter | | |

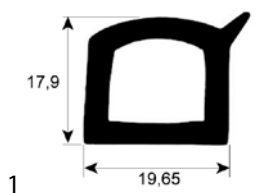

| | | | |
|--------------------|--|-----------------|------------------|
| GEV No. | 900051 | Ref. No. | 0G1819 0H6767 |
| description | door seal profile 2955 Qty supplied by meter | | |



| | | | |
|--------------------|--|-----------------|--------|
| GEV No. | 900273 | Ref. No. | 054850 |
| description | door seal profile 2970 L 1133mm Qty 1 | | |
| For models: | FCF02EV, FCF02EOEM, FCF/E3, FCF/E2, FCF/E2D, FCF/E2UK, FCF/E2, FCF/E2, FCF/E2D | | |

door seals with fixing hook

| | | | |
|--------------------|--|-----------------|--------|
| GEV No. | 900027 | Ref. No. | 0E3680 |
| description | door seal L 290mm W 260mm external size | | |
| For models: | FCV31E3, 7CO30, CCO30G, ECO312CF, OTS100 | | |

| | | | |
|--------------------|--|-----------------|--------|
| GEV No. | 901699 | Ref. No. | 0C4159 |
| description | door seal W 410mm with 4 mounting clips H 340mm | | |
| For models: | FCF/E4, FCF/E4-3KW, FCF4E, FCF4E-3KW, ECF4E, ECF4E3KW, ECF/E4, ECF/E4-3KW, ACF/E4, ACF/E4-3KW, ACF4E, ACF4E3KW | | |

door gaskets (wire reinforced)

| | | | |
|--------------------|---|-----------------|--------|
| GEV No. | 900279 | Ref. No. | 005194 |
| description | door seal wire reinforced L 395mm W 285mm | | |

gaskets for tray rack trolleys

| | | | |
|--------------------|---|-----------------|------------------|
| GEV No. | 900150 | Ref. No. | 0H6661 246281 |
| description | tray rack trolley gasket profile 4040 L 510mm Qty 1 | | |
| For models: | 5614-3-10, 5614-3-6, 5614-3-8 | | |

| | | | |
|--------------------|---|-----------------|------------------|
| GEV No. | 900592 | Ref. No. | 0H6662 0K2102 |
| description | tray rack trolley gasket profile 4040 L 658mm Qty 1 | | |
| For models: | 5714-3-6, 5714-3-7, 5714-3-8, 5714-3-8E, 5714-3-10, 5717-3-6, 5717-3-7, 5717-3-8, 5717-3-8E, 5717-3-10, 5717-3-8M, 5717-3-8C, 5714-2-10F, 5714-2-10S, 5714-3-10F, 5714-3-10S, 5704-2-2, 5704-2-3, 5707-2-2, 57074-2-3, 5704-3-2, 5704-3-3, 5707-3-2, 5707-3-3 | | |

| | | | |
|--------------------|---|-----------------|--------|
| GEV No. | 900495 | Ref. No. | 0H6985 |
| description | tray rack trolley gasket profile 4045 L 460mm Qty 1 | | |

| | | | |
|--------------------|---|-----------------|--------|
| GEV No. | 900584 | Ref. No. | 0H6866 |
| description | tray rack trolley gasket profile 4045 L 900mm Qty 1 | | |

| | | | |
|--------------------|--|-----------------|--------|
| GEV No. | 900580 | Ref. No. | 006176 |
| description | tray rack trolley gasket profile 4055 L 660mm Qty 1 | | |
| For models: | 5714-2-7, 5714-2-8, 5714-2-10, 5714-2-7, 5714-2-8, 5714-2-10, 5714-2-7L, 5714-2-8L, 5714-2-10L, 5714-2-7L, 5714-2-8L, 5714-2-10L, 5714-3-7, 5714-3-8, 5714-3-8E, 5714-3-10, 5717-3-7, 5717-3-8, 5717-3-8E, 5717-3-10, 5717-3-8M, 5717-3-8M | | |

mechanical components, equipment accessories



| | | | |
|--------------------|--|-----------------|------------------|
| GEV No. | 900295 | Ref. No. | OC0899 OC1484 |
| description | tray rack trolley gasket profile 4100 L 610mm Qty 1 | | |
| For models: | AOS201GAEU, AOS201GAAU, AOS201EABU, AOS201EAFU, AOS201EA, AOS201EB, AOS201EA3J, AOS201EB3J, AOS201EA2N, AOS201EB2N, AOS201EB5M, AOS201EB6M, AOS201EA0H, AOS201EB0H, AOS201GA, AOS201GB | | |

| | | | |
|--------------------|--|-----------------|--------|
| GEV No. | 901631 | Ref. No. | OC4121 |
| description | tray rack trolley gasket profile 4100 L 660mm | | |
| For models: | FCZ201EAA, FCZ201EAH, FCZ201EAN, FCZ201ETA, FCZ201ETH, FCZ201ETN, FCZ201GAG, FCZ201GAD, FCZ201GTG, FCZ201GTD, FCZ201EBA, FCZ201EBH, FCZ201EBN, FCZ201EBC, FCZ201EBA2, FCZ201EBH2, FCZ201EBN2, FCZ201EBC2, FCZ201GBG, FCZ201GBD, FCZ201GBI, FCZ201GBG2, FCZ201GBD2, FCZ201GBI2, FCZ201ECA, FCZ201ECH, FCZ201ECN, FCZ201ECA2, FCZ201ECH2, FCZ201ECN2, FCZ201GCG, FCZ201GCD, FCZ201GCG2, FCZ201GCD2, AOS201EAAQ, AOS201EBAQ, AOS201EANQ, AOS201EBNQ, AOS201EACQ, AOS201EBCQ, AOS201EAHQ, AOS201EBHQ, AOS201EBFQ, AOS-201GAGQ, AOS201GBGQ, AOS201GADQ, AOS201GBDQ, AOS-201GAIQ, AOS201GALQ, AOS201EAMQ...(Other models you can see in the webshop) | | |

| | | | |
|--------------------|--|-----------------|------------------|
| GEV No. | 900274 | Ref. No. | OC1196 OC1890 |
| description | tray rack trolley gasket profile 4100 L 745mm Qty 1 | | |
| For models: | AOS202GAEU, AOS202GAAU, AOS202EA2N, AOS202EB2N, AOS202EA, AOS202EB, AOS202GB, AOS202GA | | |

| | | | |
|--------------------|---|-----------------|--------|
| GEV No. | 901630 | Ref. No. | OC4131 |
| description | tray rack trolley gasket profile 4100 L 810mm | | |
| For models: | FCZ202EAA, FCZ202ETA, FCZ202GAG, FCZ202GAD, FCZ202GTG, FCZ202GTD, FCZ202EBA, FCZ202EBA2, FCZ202GBG, FCZ202GBD, FCZ202GBG2, FCZ202GBD2, FCZ202ECA, FCZ202ECA2, FCZ202GCG, FCZ202GCD, FCZ202GCG2, FCZ202GCD2, AOS202EAAQ, AOS202EBAQ, AOS202EANQ, AOS202EBNQ, AOS202GAGQ, AOS202GBGQ, AOS202GADQ, AOS202GBDQ, AOS202GAPQ, AOS202EAA1, AOS202EAM1, AOS202EAB1, AOS202EAK1, AOS202EAT1, AOS202ETA1, AOS202ETM1, AOS202ETK1, AOS202GAG1, AOS202GAD1, AOS202GAP1, AOS202GAU1, AOS202GTG1, AOS202GTD1, AOS-202GTP1, AOS202GTW1, AOS202EBA1, AOS202EBK1, AOS202EBA2, AOS202EBK2, AOS202GBG1, AOS202GBD1, AOS202GBG2...(Other models you can see in the webshop) | | |

O-rings

EPDM

ø1.78mm

| | | | |
|--------------------|--|-----------------|--------|
| GEV No. | 510824 | Ref. No. | 052779 |
| description | O-ring EPDM thickness 1.78mm ID ø 20.35mm Qty 1 pcs | | |
| For models: | BF/E1S12, MCP/E700, MCP/G700, MCP/E700D, MCP/G701, MCP/G710, MCP/G711, MCP/G705, MCP/G706, RCP/E2S, MCP/E15H, MCP/E15UH, MCP/E2SUH, MCP/E2S, MCP/E2SH, MCP/E2SUH, MCP/E2SUT, MCP/E2SHB, 7CPE07P, 7CPG07P, RCP/G701, RCP/G706, M70EPC, M70GPC, M70GPC, XCP/G706, CCP/G700, CCP/E700, RCP/G700, RCPE700, KPI/G10, KPI/G15, KPI/E10, KPI/E15, KPD/G10, KPD/G15, KPD/G15A, KPI/G15A, KPI/E15A, KPI/G15H, KPI/E15H, KPI/G10H, KPI/E10H, HPN/GI810, HPN/GI815, HPN/GI815D, HPN/GI816, HPN/GI816, HPN/EI815D, HPN/EI810...(Other models you can see in the webshop) | | |

| | | | |
|--------------------|--|-----------------|--------|
| GEV No. | 510303 | Ref. No. | OC1935 |
| description | O-ring EPDM thickness 1.78mm ID ø 6.75mm Qty 1 pcs | | |
| For models: | FCZ061EAA, FCZ101EAA, FCZ102EAA, FCZ201EAA, FCZ202EAA, FCZ061EAH, FCZ101EAH, FCZ201EAH, FCZ061EAN, FCZ101EAN, FCZ201EAN, FCZ061ETA, FCZ101ETA, FCZ102ETA, FCZ201ETA, FCZ202ETA, FCZ061ETH, FCZ101ETH, FCZ201ETH, FCZ061ETN, FCZ101ETN, FCZ201ETN, FCZ061GAG, FCZ101GAG, FCZ102GAG, FCZ201GAG, FCZ202GAG, FCZ061GAD, FCZ101GAD, FCZ102GAD, FCZ201GAD, FCZ202GAD, FCZ101GTG, FCZ102GTG, FCZ201GTG, FCZ202GTG, FCZ101GTD, FCZ102GTD, FCZ201GTD, FCZ202GTD, FCZ061EBA, FCZ101EBA, FCZ102EBA, FCZ061EBH, FCZ101EBH, FCZ061EBN, FCZ101EBN, FCZ061EBC, FCZ101EBC, FCZ201EBC...(Other models you can see in the webshop) | | |

| | | | |
|--------------------|--|-----------------|--------|
| GEV No. | 504574 | Ref. No. | 046376 |
| description | O-ring EPDM thickness 1.78mm ID ø 9.25mm Qty 1 pcs | | |
| For models: | EPPWELG, WT4, WT4B, WT4D, WT4DB, WT46, WT4DG, WT4WS1, WT4BWS, WT4DWS1, WT4BDWS, NUC3DD, WT4D60, WT4DDG, EUC1, EUC1DP, EUC1WS, EUC1DPWS, EUC3, EUC3WS, EUC3DP, EUC3DPWS, EUC1G, EUC1DP60, EUC3DD, ZUCADDROW, ZUCADDROW6, LS5/1, LS5/1DP, LS5/1WS, LS5/1WSDP, LS5/3, LS5/3DP, LS5/3WS, LS5/3WSDP, FUCA3DD, LS5/3WSDPD, LB5DPG, LS5/1DP60, LS5/1DPAUS, LS5/1D-PCS, KUC3, KUC3DP, NUC1, NUC1DP, NUC1WS, NUC1DPWS, NUC3, NUC3WS, NUC3DP...(Other models you can see in the webshop) | | |

ø2.62mm



| | | | |
|--------------------|--|-----------------|------------------|
| GEV No. | 528223 | Ref. No. | 067292 0G1952 |
| description | O-ring EPDM thickness 2.62mm ID ø 11.91mm Qty 1 pcs | | |
| For models: | C55, WT4, WT4B, WT4D, WT302, WT302/4.5, WT302F, WT302/60, WT4DB, WT46, C55A, WT303, WT303/4.5, WT303F, WT303/60, EUC1/2, EUC1DP/2, EUC3/2, WT4D60, WT4DDG, EUC3DP/2, EUC3DD/2, ZUC1, ZUC1DP, ZUC3, ZUC3DP, ZUC3DD, EUC1G/2, EUC1DP602, ZUC1DP60, EUC1GMS, ZUC1G, ZUCA1DDG, ZUC1GMS, VUC1, VUC3, VUC3G, VUC1G, EUC3DDMCD, LS5/1, LS5/1DP, LS5/3, LS5/3DP, NUC1DPP, EUC1DDM60, NUC1DUK, NUC1DDUK, LS5/1DP60, LS5/1DPAUS, LS5/1DPCS...(Other models you can see in the webshop) | | |

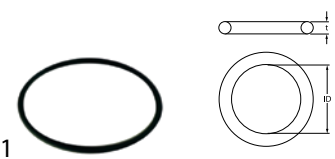

| | | | |
|--------------------|--|-----------------|--|
| GEV No. | 540222 | Ref. No. | 053809 0H6848 0K2958 0K3045 0TR613 68226012 |
| description | O-ring EPDM thickness 2.62mm ID ø 47.3mm Qty 1 pcs | | |
| For models: | FCFG101/0, FCFG102-0, FCFG201-0, FCFG202-0, FCFE101-0, FCFE102-0, FCFE201-0, FCFE202-0, FCF101ELN, FCFG10160H, FCF201ENS, FCFG102-0T, FCF/G101/1-1-JAP, FCF/G102/1-1-JAP, FCFE101-1J, FCFE102-1J, FCF/G101/1, FCFG6D, FCFE6D, FCFE6D, FCFG10, FCFG10D, FCFG10NL, FCFE10, FCFE10UK, FCFG20, FCFG20D, FCFG20F, PFCFG20, FCFE20, FCFE20UK, FCFG40, FCFG41, FCFG40D, FCFG40F, PFCFG40F, FCFE40, FCFE40D, FCFE40UK, PFCFE40F, FCFG6, FCFG6F, PFCFG6, FCFE6, FCFE6UK, PFCFE6, FCVE10, FCVE20, FCFE6J50, FCFE6J60...(Other models you can see in the webshop) | | |

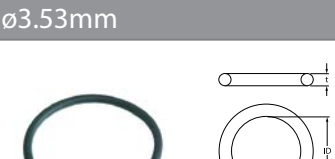

| | | | |
|--------------------|--|-----------------|--------|
| GEV No. | 505180 | Ref. No. | OHA075 |
| description | O-ring EPDM thickness 3.53mm ID ø 47.22mm Qty 1 pcs | | |
| For models: | LB035C, LB035Q, LB040Q, LB040AUS, G350C, LBICEQ010, LBIOEQ010, G350, G350DP, LBIOEQ014, G400, G400DP, LCFBE003 | | |

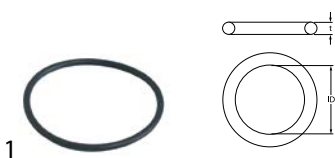

| | | | |
|--------------------|---|-----------------|------------------|
| GEV No. | 532612 | Ref. No. | 068799 0L0185 |
| description | O-ring EPDM thickness 3.53mm ID ø 60.33mm Qty 1 pcs | | |
| For models: | CT92DXE, CT92SXE, CT92DXEUK, CT92SXEUUK, CT92DXV, CT92SXV, CT92DXVUK, CT92SXVUK, WT60/GJ60, WT60/GJ50, PH10/12-RP, LS10, LS14EA, LS10UKDP, ET12E, LS10/60HZ, LS10CW, LS10INS, HT1200INS, LS14EAI, LS10N, LS10DP, LS10HD, LS14EAI/AU, LS14EA/60, LS10UK/1, LS10UK/3, LS12INS, LS12, LS12DP, LS12/60HZ, LS12CW, HT1200DEK, LS14EAASIA, LS14EA/G, WT60DP, WT60, WT60CW, WT60UKPCW, WT60INS, WT60INSCW, WT60NAUCW, WT60NAU, LS10EA, WT60/60HZ, WT60/60HZC, WT60N, WT609NINS, LS12HD, LS14EAI/DD...(Other models you can see in the webshop) | | |



| | | | |
|--------------------|---|-----------------|--------|
| GEV No. | 505092 | Ref. No. | 0C3142 |
| description | O-ring EPDM thickness 5.34mm ID ø 43.82mm Qty 1 pcs | | |

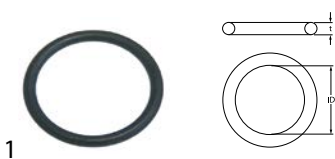

| | | | |
|--------------------|---|-----------------|---|
| GEV No. | 510408 | Ref. No. | 046213 055533 065710 067620 0G0216 0G1615 0H2559 0K2935 0K5546 0K8688 0L2765 718042198 |
| description | O-ring EPDM thickness 5.34mm ID ø 47mm Qty 1 pcs | | |
| For models: | MPN/EI760, MPNEI760UK, MPN/EI760D, MCP/E700, MCP/G700, MCP/E700D, MCP/G701, MCP/G710, MCP/G711, FDV40E, FDV40EL, FDV20E, FDV20EL, RPI/E240, RPI/E260, RPI/E260P, RCP/E25, XPI/E240, XPI/E260, XPI/E260P, JPI/E240, JPI/E260, MPI/E240, MPI/E260, MPI/E260P, MCP/E25, 7PIE06, RPN/EI760UK, RPN/EI760D, 7CPE07P, 7CPG07P, RCP/G701, M70EIKE, XPN/EI760UK, XPN/EI760D, M70EPC, M70GPC, M70GPC, CCP/G700, CCP/E700, XFV/E700, PPI/E260P, ECP/E1ELHU, PCP/E25SH, PCP/E1ELH, OPI/E260P, OCP/E25, TPI/E260P, TCP/E1ELHU, TCP/E25...(Other models you can see in the webshop) | | |

mechanical components, equipment accessories



| Viton | | | |
|--------------------|--|-----------------|--|
| ø3.53mm | | | |
| | | | |
| GEV No. | 511300 | Ref. No. | 002873 0F0199 0G0014 0K2486 0K5556 0K8687 0K8840 |
| description | O-ring Viton thickness 3.53mm ID ø 28.17mm for 57 series for motor shaft | | |
| For models: | FCZ061EAA, FCZ101EAA, FCZ102EAA, FCZ201EAA, FCZ202EAA, FCZ061EAH, FCZ101EAH, FCZ201EAH, FCZ061EAN, FCZ101EAN, FCZ201EAN, FCZ061ETA, FCZ101ETA, FCZ102ETA, FCZ201ETA, FCZ202ETA, FCZ061ETH, FCZ101ETH, FCZ201ETH, FCZ061ETN, FCZ101ETN, FCZ201ETN, FCZ061GAG, FCZ101GAG, FCZ102GAG, FCZ201GAG, FCZ202GAG, FCZ061GAD, FCZ101GAD, FCZ102GAD, FCZ201GAD, FCZ202GAD, FCZ101GTG, FCZ102GTG, FCZ201GTG, FCZ202GTG, FCZ101GTD, FCZ102GTD, FCZ201GTD, FCZ202GTD, FCZ061EBA, FCZ101EBA, FCZ102EBA, FCZ201EBA, FCZ202EBA, FCZ061EBH, FCZ101EBH, FCZ201EBH, FCZ061EBN, FCZ101EBN...(Other models you can see in the webshop) | | |

| | | | |
|--------------------|---|-----------------|--------|
| | | | |
| GEV No. | 532506 | Ref. No. | 007074 |
| description | O-ring Viton thickness 3.53mm ID ø 29.75mm Qty 1 pcs | | |
| For models: | FCZ061EAA, FCZ101EAA, FCZ102EAA, FCZ201EAA, FCZ202EAA, FCZ061EAH, FCZ101EAH, FCZ201EAH, FCZ061EAN, FCZ101EAN, FCZ201EAN, FCZ061GAG, FCZ101GAG, FCZ102GAG, FCZ201GAG, FCZ202GAG, FCZ061GAD, FCZ101GAD, FCZ102GAD, FCZ201GAD, FCZ202GAD, FCZ061ECA, FCZ101ECA, FCZ102ECA, FCZ201ECA, FCZ202ECA, FCZ061ECH, FCZ101ECH, FCZ201ECH, FCZ061ECN, FCZ101ECN, FCZ201ECN, FCZ061GCG, FCZ101GCG, FCZ102GCG, FCZ201GCG, FCZ202GCG, FCZ061GCD, FCZ101GCD, FCZ102GCD, FCZ201GCD, FCZ202GCD, AOS061GAEU, AOS101GAEU, AOS102GAEU, AOS201GAEU, AOS202GAEU, AOS061GAU, AOS101GAU, AOS102GAU...(Other models you can see in the webshop) | | |

| | | | |
|--------------------|--|-----------------|--------------------------------------|
| | | | |
| GEV No. | 528412 | Ref. No. | 002874 0F0200 0K2485 0K8686 |
| description | O-ring Viton thickness 3.53mm ID ø 31.34mm Qty 1 pcs | | |
| For models: | FDV40G, FDV40GZ, FDV40GA, FDV20G, FDV20GZ, FDV20GA, FCZ061EAA, FCZ101EAA, FCZ102EAA, FCZ201EAA, FCZ202EAA, FCZ061EAH, FCZ101EAH, FCZ201EAH, FCZ061EAN, FCZ101EAN, FCZ201EAN, FCZ061ETA, FCZ101ETA, FCZ102ETA, FCZ201ETA, FCZ061ETH, FCZ101ETH, FCZ201ETH, FCZ061ETN, FCZ101ETN, FCZ201ETN, FCZ061GAG, FCZ101GAG, FCZ102GAG, FCZ202GAG, FCZ061GAD, FCZ101GAD, FCZ102GAD, FCZ202GAD, FCZ101GTG, FCZ102GTG, FCZ202GTG, FCZ101GTD, FCZ102GTD, FCZ202GTD, FCZ061EBA, FCZ101EBA, FCZ102EBA, FCZ201EBA, FCZ202EBA, FCZ061EBH, FCZ101EBH, FCZ201EBH, FCZ061EBN...(Other models you can see in the webshop) | | |

| | | | |
|--------------------|--|-----------------|--------|
| | | | |
| GEV No. | 550529 | Ref. No. | 055349 |
| description | O-ring Viton thickness 3.53mm ID ø 34.52mm Qty 1 pcs | | |
| For models: | FCV/G61/1, FCV/G61/1, FCV/G61/1, FCV/G61/1, FCS061GP, FCS061G4, FCVE6-1U, FCVE6-3U, FCVE6-1, FCVE6-3, FCVE6-1UK, FCVE6-3UK, FCVG6-1, FCVG6-3, FCVG6-1UK, FCVG6-3UK, FCVE10-2, FCVE10-4, FCVE103CE, FCVE10-2UK, FCVE10-4UK, FCVG10-2, FCVG10-4, FCVG10-1SG, FCVG10-2, FCVG10-4D, FCVG10-2UK, FCVG10-4UK, FCVG10-2, FCVG10-4, FCVE20-2, FCVE20-4, FCVE203CE, FCVE20/P-V, FCVE20-2UK, FCVE20-4UK, FCVG20-2, FCVG20-4, FCVG20-2, FCVG20-4D, FCVG20-2UK, FCVG20-4UK, FCVG20-4, FCVG20-4D, FCVE20-V, FCVE20VUK, FCVE10-P, FCVE10PUK, FCVG10-P, FCVG10PUK...(Other models you can see in the webshop) | | |

| ø5.34mm | | | |
|--------------------|---|-----------------|--------|
| | | | |
| GEV No. | 550530 | Ref. No. | 055323 |
| description | O-ring Viton thickness 5.34mm ID ø 37.8mm Qty 1 pcs | | |
| For models: | FDV20G, FDV20GZ, FDV20GA, 7CPE07P, 7CPG07P, M70EPC, M70GPC, FCV/G10L3, FCV/G6L3TOWNGAS, FCV/G6L3, FCVG10L3T, FCVG102L3, FCV/E101/1, FCV/G20L3, FCVE6L3J, FCV/E10L3JAP, FCV/E102/1L-3JAP, FCV/E10L6JAP, FCV/E102/1L6JAP, FCV/G6L3JAP, FCVG10L3J, FCVG102L3J, FCV/G10L6JAP, FCV/G102/1L6JAP, FCVG6L3CJ, FCV/E61/1, FCV/G10L2, FCV/E61/1, FCV/E101/1, FCV/E101/1, FCV/E10L2, FCV/E102/1, FCV/E61/1, FCV/E61/1, FCV/E101/1, FCV/E101/2, FCV/G6L3C, FCV/G61/1, FCV/G61/1, FCV/G61/1, FCV/G61/1, FCVG6L3CT, FCVG6L3CJ, FCV/E10L3, FCV/E102/1, FCV/E6L3, FCV/E102/1L3, FCV/E20L3, FCV/G6L4, FCV/E6L4...(Other models you can see in the webshop) | | |

| miscellaneous | | | |
|--------------------|---|-----------------|--------|
| | | | |
| GEV No. | 530887 | Ref. No. | 0C3128 |
| description | O-ring Viton thickness 3.53mm ID ø 49.2mm Qty 1 pcs | | |
| For models: | FCZ202ETA, FCZ202EBA2, FCZ202ECA2, AOS202EA2N, AOS202EB2N, AOS202EA, AOS202EB, AOS202ETA1, AOS202ETM1, AOS202ETK1, AOS202EBA2, AOS202EBK2, AOS202ECA2 | | |

sealing washers

fibre gaskets



| | | | |
|--------------------|---|-----------------|---|
| GEV No. | 510404 | Ref. No. | 0E2240 0H2578 0H2612 0K6137 0K8703 0KG502 3427TJ1,5 |
| description | flat gasket fibre ED ø 44mm ID ø 34mm thickness 2mm Qty 1 pcs | | |
| For models: | EBS50, EBS50, EBS50, EBS50, EBV50, EBV50, EBV50, EBV50, EBV50, EBS100, EBS100, EBS100, EBS100, EBV100, EBV100, EBV100, EBV100, EBV100, EBV-C100, EBV-C100, EBV-C100, EBV-C100, EBV-C100, EBS200, EBS200, EBS200, EBS200, EBV200, EBV200, EBV200, EBV200, EBV200, EBV-C200, EBV-C200, EBV-C200, EBV-C200, EBV-C200, EBS300, EBS300, EBS300, EBS300, EBV300, EBV300, EBV300, EBV300, EBV300, EBV-C300, EBV-C300, EBV-C300, EBV-C300...(Other models you can see in the webshop) | | |

rubber gaskets



| | | | |
|--------------------|---|-----------------|------------------|
| GEV No. | 510878 | Ref. No. | 046925 061488 |
| description | gasket rubber ED ø 23.5mm ID ø 14mm thickness 2.3mm Qty 1 pcs size 3/4" | | |
| For models: | MCP/E700, MCP/G700, MCP/E700D, MCP/G701, MCP/G710, MCP/G711, FDV40G, FDV40E, FDV40GZ, FDV40EL, FDV40GA, FDV20G, FDV20E, FDV20GZ, FDV20EL, FDV20GA, 7CPE07P, 7CPG07P, RCP/G701, M70EPC, M70GPC, M70GPC, CCP/G700, CCP/E700, RCP/G700, RCPE700, FCZ202GAG, FCZ202GAD, FCZ202GBG, FCZ202GBD, FCZ202GCG, FCZ202GCD, FCV/G10L3, FCV/G6L3TOWNGAS, FCV/G6L3, FCVG10L3T, FCVG102L3, FCV/E101/1, FCV/G20L3, FCVG202L3, FCVE6L3J, FCV/E10L3JAP, FCV/E102/1L3JAP, FCV/E10L6JAP, FCV/E102/1L6JAP, FCV/G6L3JAP, FCVG10L3J, FCVG102L3J, FCV/G10L6JAP, FCV/G102/1L6JAP...(Other models you can see in the webshop) | | |

copper gaskets

DIN-7603-A



| | | | |
|--------------------|--|-----------------|--------|
| GEV No. | 528660 | Ref. No. | 0C4201 |
| description | flat gasket copper ED ø 21mm ID ø 17mm thickness 1.5mm suitable for 3/8" | | |
| For models: | FCZ061EAA, FCZ101EAA, FCZ102EAA, FCZ061EAH, FCZ101EAH, FCZ061EAN, FCZ101EAN, FCZ061ETA, FCZ101ETA, FCZ102ETA, FCZ201ETA, FCZ202ETA, FCZ061ETH, FCZ101ETH, FCZ201ETH, FCZ061ETN, FCZ101ETN, FCZ201ETN, FCZ061GAG, FCZ061GAD, FCZ101GTG, FCZ102GTG, FCZ201GTG, FCZ202GTG, FCZ101GTD, FCZ102GTD, FCZ201GTD, FCZ202GTD, FCZ061EBA, FCZ101EBA, FCZ102EBA, FCZ061EBH, FCZ101EBH, FCZ061EBN, FCZ101EBN, FCZ061EBC, FCZ101EBC, FCZ201EBC, FCZ061EBA2, FCZ101EBA2, FCZ102EBA2, FCZ201EBA2, FCZ202EBA2, FCZ061EBH2, FCZ101EBH2, FCZ201EBH2, FCZ061EBN2, FCZ101EBN2, FCZ201EBN2, FCZ061EBC2...(Other models you can see in the webshop) | | |

PTFE gaskets



| | | | |
|--------------------|--|-----------------|--------------------------------------|
| GEV No. | 693745 | Ref. No. | 002624 0C3641 0F0165 237382 |
| description | gasket PTFE ED ø 20mm ID ø 15mm thickness 1mm Qty 1 pcs | | |
| For models: | FCZ061EAA, FCZ101EAA, FCZ102EAA, FCZ201EAA, FCZ202EAA, FCZ061EAH, FCZ101EAH, FCZ201EAH, FCZ061EAN, FCZ101EAN, FCZ201EAN, FCZ061ETA, FCZ101ETA, FCZ102ETA, FCZ201ETA, FCZ061ETH, FCZ101ETH, FCZ201ETH, FCZ061ETN, FCZ101ETN, FCZ201ETN, FCZ061GAG, FCZ101GAG, FCZ102GAG, FCZ201GAG, FCZ202GAG, FCZ061GAD, FCZ101GAD, FCZ102GAD, FCZ201GAD, FCZ202GAD, FCZ101GTG, FCZ102GTG, FCZ201GTG, FCZ202GTG, FCZ101GTD, FCZ102GTD, FCZ201GTD, FCZ202GTD, FCZ061EBA, FCZ101EBA, FCZ102EBA, FCZ201EBA, FCZ202EBA, FCZ061EBH, FCZ101EBH, FCZ201EBH, FCZ061EBN, FCZ101EBN, FCZ201EBN...(Other models you can see in the webshop) | | |

foam rubber gaskets

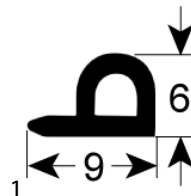

| | | | |
|--------------------|---|-----------------|--------------------------------------|
| GEV No. | 512510 | Ref. No. | 088581 0E5245 0L0113 0L3189 |
| description | foam rubber gasket self-adhesive Qty supplied by meter W 8mm | | |
| For models: | BC100A, BC100DA, BC100RA, BC100RDA, BC180A, BC180DA, BC180RA, BC180RDA, BC180RPA, BCF100A, BCF100DA, BCF100RA, BCF100RDA, BCF180A, BCF180DA, BCF180RA, BCF180RDA, BCF180RPA, AQC22U US, AQC31U US, AQC60U, AQC119U US, , , BC28A6, Crosswise, , , BCF15A6, , , BCW061, BCW101, BCW102, BCFW061, BCFW101, BC120A, BC120RA, BCF120A, BCF120RA, ADN220ES, ADF110ES, ADF220ES, ADN110ESP, ADF110ESP, BCWS061T, BCFW102, BLAST C/FREEZER, BLAST C/FREEZER, BLAST C/FREEZER...(Other models you can see in the webshop) | | |



| | | | |
|--------------------|---|-----------------|--------|
| GEV No. | 560638 | Ref. No. | 053829 |
| description | gasket suitable for ELECTROLUX, ZANUSSI for combi-steamer ED ø 85mm ID ø 60mm rubber thickness 7mm | | |
| For models: | RMV/E1C, RMV/E2C, XMV/E1C, XMV/E2C, JMV/E1C, JMV/E2C, MMV/E1C, MMV/E2C, FCV/G10L3, FCV/G6L3TOWNGAS, FCV/G6L3, FCVG10L3T, FCVG102L3, FCV/E101/1, FCV/G20L3, FCVG202L3, FCV/E6L3J, FCV/E10L3JAP, FCV/E102/1L3JAP, FCV/E10L6JAP, FCV/E102/1L6JAP, FCV/G6L3JAP, FCVG10L3J, FCVG102L3J, FCV/G10L6JAP, FCV/G102/1L6JAP, FCVG6L3CJ, FCV/E61/1, FCV/G10L2, FCV/E61/1, FCV/E101/1, FCV/E101/1, FCV/E102/1, FCV/E61/1, FCV/E61/1, FCV/E101/1, FCV/E101/2, FCV/G6L3C, FCV/G61/1, FCV/G61/1, FCV/G61/1, FCV/G61/1, FCVG6L3CT, FCVG6L3CJ, FCV/E10L3, FCV/E102/1, FCV/E6L3, FCV/E102/1L3, FCV/E20L3, FCV/E202L3...(Other models you can see in the webshop) | | |



| | | | |
|--------------------|--|-----------------|--------|
| GEV No. | 560641 | Ref. No. | ODF005 |
| description | gasket suitable for ELECTROLUX, ZANUSSI for combi-steamer L 38mm W 16mm for steam generator thickness 5mm hole distance 24mm | | |
| For models: | FCV31E3, 7CO30, CCO30G, ECO312CF, OTS100 | | |



| | | | |
|--------------------|---|-----------------|--------|
| GEV No. | 560639 | Ref. No. | 002612 |
| description | gasket suitable for ELECTROLUX, ZANUSSI for combi-steamer L 60mm W 46mm silicone thickness 2mm hole distance 50mm | | |
| For models: | FDV40G, FDV40E, FDV40GZ, FDV40EL, FDV40GA, FDV20G, FDV20E, FDV20GZ, FDV20EL, FDV20GA, FCV/G10L3, FCV/G6L3TOWNGAS, FCV/G6L3, FCVG10L3T, FCVG102L3, FCV/E101/1, FCV/G20L3, FCVG202L3, FCV/E6L3J, FCV/E10L3JAP, FCV/E102/1L3JAP, FCV/E10L6JAP, FCV/E102/1L6JAP, FCV/G6L3JAP, FCVG10L3J, FCVG102L3J, FCV/G10L6JAP, FCV/G102/1L6JAP, FCVG6L3CJ, FCV/E61/1, FCV/G10L2, FCV/E61/1, FCV/E101/1, FCV/E101/1, FCV/E10L2, FCV/E102/1, FCV/E61/1, FCV/E61/1, FCV/E101/1, FCV/E101/2, FCV/G6L3C, FCV/G61/1, FCV/G61/1, FCV/G61/1, FCV/G61/1, FCVG6L3CT, FCVG6L3CJ, FCV/E10L3, FCV/E102/1, FCV/E6L3...(Other models you can see in the webshop) | | |



| | | | |
|--------------------|---|-----------------|--------|
| GEV No. | 560640 | Ref. No. | 005760 |
| description | gasket suitable for ELECTROLUX, ZANUSSI for combi-steamer L 74mm W 74mm for heat exchanger graphite thickness 2mm hole distance 60mm | | |
| For models: | FCVG6L3CJ, FCV/G6L3C, FCV/G61/1, FCV/G61/1, FCV/G61/1, FCV/G61/1, FCVG6L3CT, FCVG6L3CJ, FCS061G48J, FCS061GP, FCS061G3D1, FCS061G4, FCS061G4DT, FCS061G49J, 5721-2-7, 5721-2-10, ECV/G6T4C, ECV/G61/1, ECV/G61/1, RCV061G2, ACV/G6C3C, ZCV/G6T4C, ZCV/G61/1 | | |



| | | | |
|--------------------|--|-----------------|--------|
| GEV No. | 560637 | Ref. No. | 007005 |
| description | gasket suitable for ELECTROLUX, ZANUSSI for combi-steamer L 94mm W 84mm | | |
| For models: | FCZ061EAA, FCZ101EAA, FCZ061EAH, FCZ101EAH, FCZ061EAN, FCZ101EAN, FCZ061ETA, FCZ101ETA, FCZ061ETH, FCZ101ETH, FCZ061ETN, FCZ101ETN, FCZ061GAG, FCZ101GAG, FCZ102GAG, FCZ201GAG, FCZ061GAD, FCZ101GAD, FCZ102GAD, FCZ201GAD, FCZ101GTG, FCZ102GTG, FCZ101GTD, FCZ102GTD, FCZ061EBA, FCZ101EBA, FCZ061EBH, FCZ101EBH, FCZ061EBN, FCZ101EBN, FCZ061EBC, FCZ101EBC, FCZ061EBA2, FCZ101EBA2, FCZ061EBH2, FCZ101EBH2, FCZ061EBN2, FCZ061EBC2, FCZ101EBC2, FCZ061GBG, FCZ101GBG, FCZ102GBG, FCZ201GBG, FCZ061GBD, FCZ101GBD, FCZ102GBD, FCZ201GBD, FCZ061GBI, FCZ101GBI...(Other models you can see in the webshop) | | |

miscellaneous

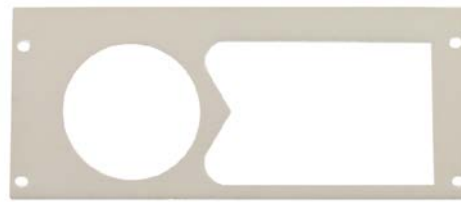

| | | | |
|--------------------|--|-----------------|------------------|
| GEV No. | 693402 | Ref. No. | 002706 OK1836 |
| description | boiler gasket | | |
| For models: | FDV40G, FDV40GZ, FDV40GA, FDV20G, FDV20GZ, FDV20GA, FCV/G10L3, FCVG10L3T, FCVG102L3, FCV/G20L3, FCVG202L3, FCVG10L3J, FCV/G10L6JAP, FCV/G102/1L6JAP, FCV/G10L6, FCV/G102/1L6, FCV/G20L6, FCVG202L6, FCV/G201/1, FCV/G202/1, FCS101G4, FCS101G4DT, FCS101GP9J, FCS101G49J, FCS101GP, FCS102G4, FCS102GA9J, FCS102G49J, FCS102GP, FCS201G4, FCS201GP, FCS202G4, FCS202GP, FCS101GX9J, FCS101GX, FCS102GX9J, FCS102GX, FCS201GX, FCS202GX, 5712-2-6, 5712-2-7, 5712-2-8, 5712-2-10, 5714-2-6, 5714-2-7, 5714-2-8, 5714-2-10, 5717-2-6, 5714-2-7...(Other models you can see in the webshop) | | |



| | | | |
|--------------------|---|-----------------|--------|
| GEV No. | 901629 | Ref. No. | 0C5834 |
| description | flange gasket L 101mm W 83mm hole ø 6mm hole distance 7 holes thickness 5mm for heating element | | |
| For models: | FCZ061EAA, FCZ101EAA, FCZ102EAA, FCZ061EAH, FCZ101EAH, FCZ061EAN, FCZ101EAN, FCZ061ETA, FCZ101ETA, FCZ102ETA, FCZ201ETA, FCZ202ETA, FCZ061ETH, FCZ101ETH, FCZ201ETH, FCZ061ETN, FCZ101ETN, FCZ201ETN, FCZ061EBA, FCZ101EBA, FCZ102EBA, FCZ061EBH, FCZ101EBH, FCZ061EBN, FCZ101EBN, FCZ061EBC, FCZ101EBC, FCZ201EBC, FCZ061EBA2, FCZ101EBA2, FCZ102EBA2, FCZ201EBA2, FCZ202EBA2, FCZ061EBH2, FCZ101EBH2, FCZ201EBH2, FCZ061EBN2, FCZ101EBN2, FCZ201EBN2, FCZ061EBC2, FCZ101EBC2, FCZ201EBC2, FCZ061ECA, FCZ101ECA, FCZ102ECA, FCZ061ECH, FCZ101ECH, FCZ061ECN, FCZ101ECN, FCZ061ECA2...(Other models you can see in the webshop) | | |

| | | | |
|---|--------|-----------------|--------|
| accessories for | 901629 | | |
| GEV No. | 420284 | Ref. No. | 0C5841 |
| heating element 24000W 400V heating circuits 6 L 535mm W 60mm H 75mm 7 hole fixing connection male faston 6.3mm flange length 105mm flange width 87mm tube ø 8.4mm immersion heater number of thermostat sleeves 1 length thermostat sleeves 120mm thermostat sleeve eccentric, clinging thermostat sleeves ø 4.7mm | | | |



| | | | |
|---|---|-----------------|--------|
|  | | | |
| 1 | | | |
| GEV No. | 550916 | Ref. No. | 0H6666 |
| description | gasket | | |
| For models: | 5611-3-10, 5611-3-6, 5611-3-8, 5612-3-10, 5612-3-6, 5612-3-8, 5614-3-10, 5614-3-6, 5614-3-8 | | |

| | | | |
|---|--|-----------------|--------|
|  | | | |
| 1 | | | |
| GEV No. | 697971 | Ref. No. | 0C1048 |
| description | gasket ED ø 148mm graphite thickness 3mm | | |
| For models: | AOS102GAEU, AOS201GAEU, AOS202GAEU, AOS102GAAU, AOS201GAAU, AOS202GAAU, AOS101GA, AOS101GB, AOS201GA, AOS201GB, AOS102GB, AOS102GA, AOS202GB, AOS202GA | | |

| | | | |
|--|--|-----------------|--------|
|  | | | |
| 1 | | | |
| GEV No. | 697969 | Ref. No. | 0C1111 |
| description | gasket ED ø 84mm thickness 3mm hole distance 50mm | | |
| For models: | AOS102GAEU, AOS201GAEU, AOS202GAEU, AOS102GAAU, AOS201GAAU, AOS202GAAU, AOS201GA, AOS201GB, AOS102GB, AOS102GA, AOS202GB, AOS202GA | | |

| | | | |
|---|--|-----------------|--------|
|  | | | |
| 1 | | | |
| GEV No. | 697960 | Ref. No. | 0C1077 |
| description | gasket ED ø 87mm ID ø 43mm graphite thickness 3mm | | |
| For models: | AOS061GAEU, AOS061GAAU, AOS061GA, AOS061GB, AOS101GA, AOS061GAGQ, AOS061GBGQ, AOS061GADQ, AOS061GBDQ, AOS061GAIQ, AOS061GALQ, AOS061GAPO | | |

| | | | |
|---|--|-----------------|--------|
|  | | | |
| 1 | | | |
| GEV No. | 697966 | Ref. No. | 0K2100 |
| description | gasket ED ø 88mm ID ø 68mm rubber thickness 3mm hole distance 39mm | | |
| For models: | FDV40G, FDV40GZ, FDV40GA, FDV20G, FDV20GZ, FDV20GA, FCVG202L3, FCVE202L3, FCVG202L6, FCVE202L6, FCV/G202/1, FVC/E202/1, FCS202E4, FCS201G4, FCS202G4, 5714-2-7, 5714-2-8, 5714-2-10, 5714-2-7L, 5714-2-8L, 5714-2-10L, ECVG202T4, ECVE202T4, ECVG202T6, ECVE202T6, ACVG202C4, ACVE202C4, ACVG202C6, ACV/E202/1, ZCV/G202/1, ZCV/E202/1, ZCV/E202/1 | | |

| | | | |
|--|---|-----------------|------------------|
|  | | | |
| 1 | | | |
| GEV No. | 517456 | Ref. No. | 0C3442 0C7033 |
| description | gasket for boiler ED ø 107mm thickness 5.5mm | | |
| For models: | FCZ061EAA, FCZ101EAA, FCZ102EAA, FCZ201EAA, FCZ202EAA, FCZ061EAH, FCZ101EAH, FCZ201EAH, FCZ061EAN, FCZ101EAN, FCZ201EAN, FCZ061ETA, FCZ101ETA, FCZ102ETA, FCZ201ETA, FCZ202ETA, FCZ061ETH, FCZ101ETH, FCZ201ETH, FCZ061ETN, FCZ101ETN, FCZ201ETN, FCZ061GAG, FCZ101GAG, FCZ102GAG, FCZ201GAG, FCZ202GAG, FCZ061GAD, FCZ101GAD, FCZ102GAD, FCZ201GAD, FCZ202GAD, FCZ101GTG, FCZ102GTG, FCZ201GTG, FCZ202GTG, FCZ101GTD, FCZ102GTD, FCZ201GTD, FCZ202GTD, FCZ061EBA, FCZ101EBA, FCZ102EBA, FCZ061EBH, FCZ101EBH, FCZ061EBN, FCZ101EBN, FCZ061EBC, FCZ101EBC, FCZ201EBC... (Other models you can see in the webshop) | | |

| | | | |
|---|---|-----------------|--------|
|  | | | |
| 1 | | | |
| GEV No. | 697956 | Ref. No. | 003875 |
| description | gasket for heat exchanger ID ø 70mm ceramic fibre thickness 3mm hole distance 85mm | | |
| For models: | FCV/G10L3, FCVG10L3T, FCVG102L3, FCV/G20L3, FCVG202L3, FCVG10L3J, FCVG102L3J, FCV/G10L6JAP, FCV/G102/1L6JAP, FCV/G10L2, FCV/G10L6, FCV/G102/1L6, FCV/G20L6, FCVG202L6, FCV/G101/1, FCV/G102/1, FCV/G201/1, FCV/G202/1, FCS101G2, FCS101G4, FCS101G4DT, FCS101GP9J, FCS101G49J, FCS101GP, FCS102G4, FCS102GA9J, FCS102G49J, FCS102GP, FCS201G4, FCS201GP, FCS202G4, FCS202GP, FCS101GX9J, FCS101GX, FCS102GX9J, FCS102GX, FCS201GX, FCS202GX, 5712-2-6, 5712-2-7, 5712-2-8, 5712-2-10, 5714-2-6, 5714-2-7, 5714-2-8, 5714-2-10, 5717-2-6, 5714-2-7, 5714-2-8, 5714-2-10... (Other models you can see in the webshop) | | |

| | | | |
|--|--|-----------------|--------|
|  | | | |
| 1 | | | |
| GEV No. | 697957 | Ref. No. | 002704 |
| description | gasket for heat exchanger L 100mm W 100mm ID ø 55mm ceramic fibre thickness 3mm hole distance 78mm | | |
| For models: | FCV/G10L3, FCVG10L3T, FCV/G20L3, FCVG10L3J, FCV/G10L6JAP, FCV/G10L2, FCV/G10L6, FCV/G20L6, ECV/G10T4, ECV/G20T4, ECV/G10T4J, ECV/G10T6, ECV/G20T6, RCV101G2, ACV/G10C2, ACV/G10C4, ACV/G20C4, ACV/G10C6, ACV/G20C6, NCV/G10L2, NCV/G10L4, ZCV/G10T4, ZCV/G20T4, ZCV/G10T6, ZCV/G20T6 | | |

mechanical components, equipment accessories



1

| | | | |
|--------------------|--|-----------------|--------|
| GEV No. | 697967 | Ref. No. | 002629 |
| description | gasket for heat exchanger L 100mm W 100mm ID ø 76mm thickness 2.5mm | | |
| For models: | FCV/G10L3, FCVG10L3T, FCV/G20L3, FCVG10L3J, FCV/G10L6JAP, FCV/G10L2, FCV/G10L6, FCV/G20L6, ECV/G10T4, ECV/G20T4, ECV/G10T4J, ECV/G10T6, ECV/G20T6, RCV101G2, ACV/G10C2, ACV/G10C4, ACV/G20C4, ACV/G10C6, ACV/G20C6, NCV/G10L2, NCV/G10L4, ZCV/G10T4, ZCV/G20T4, ZCV/G10T6, ZCV/G20T6 | | |



1

| | | | |
|--------------------|--|-----------------|------------------|
| GEV No. | 697964 | Ref. No. | 003873 0G5209 |
| description | gasket for heat exchanger L 100mm W 100mm ID ø 77mm thickness 5mm | | |
| For models: | FCV/G10L3, FCVG10L3T, FCV/G20L3, FCVG10L3J, FCV/G10L6JAP, FCV/G10L2, FCV/G10L6, FCV/G20L6, FCV/G101/1, FCV/G201/1, FCS101G2, FCS101G4, FCS101G4DT, FCS101GP9J, FCS101G49J, FCS101GP, FCS201G4, FCS201GP, FCS101GX9J, FCS101GX, FCS201GX, 5712-2-6, 5712-2-7, 5712-2-8, 5712-2-10, 5714-2-6, 5714-2-7, 5714-2-8, 5714-2-10, 5712-2-6L, 5712-2-7L, 5712-2-8L, 5712-2-10L, 5714-2-6L, 5714-2-7L, 5714-2-8L, 5714-2-10L, 5712-2-10F, 5712-2-10S, 5714-2-10F, 5714-2-10S, 5702-2-2, 5702-2-3, 5704-2-2, 5704-2-3, ECV/G10T4, ECV/G20T4, ECV/G10T4J, ECV/G20T4J, ECV/G10T6...(Other models you can see in the webshop) | | |



1

| | | | |
|--------------------|--|-----------------|--------|
| GEV No. | 697958 | Ref. No. | 0C2569 |
| description | gasket ID ø 66.5mm ceramic fibre thickness 5mm | | |



1

| | | | |
|--------------------|---|-----------------|--------|
| GEV No. | 520938 | Ref. No. | 0C1168 |
| description | gasket L 115mm rubber W 100mm thickness 3.5mm hole ø 7mm | | |
| For models: | FCZ102EAA, FCZ201EAA, FCZ202EAA, FCZ201EAH, FCZ201EAN, FCZ102ETA, FCZ201ETA, FCZ202ETA, FCZ201ETH, FCZ201ETN, FCZ102GAG, FCZ201GAG, FCZ202GAG, FCZ102GAD, FCZ201GAD, FCZ202GAD, FCZ102GTG, FCZ201GTG, FCZ202GTG, FCZ102GTD, FCZ201GTD, FCZ202GTD, FCZ102EBA, FCZ201EBA, FCZ202EBA, FCZ201EBH, FCZ201EBC, FCZ102EBA2, FCZ201EBA2, FCZ202EBA2, FCZ201EBH2, FCZ201EBN2, FCZ201EBC2, FCZ102GBG, FCZ201GBG, FCZ202GBG, FCZ102GBD, FCZ201GBD, FCZ202GBD, FCZ201GBI, FCZ102GBG2, FCZ201GBG2, FCZ202GBG2, FCZ102GBD2, FCZ201GBD2, FCZ202GBD2, FCZ102GBI2, FCZ201GBI2, FCZ102ECA...(Other models you can see in the webshop) | | |

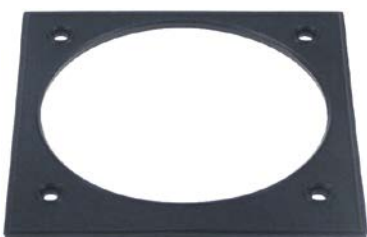

1

| | | | |
|--------------------|--|-----------------|--------|
| GEV No. | 697962 | Ref. No. | 0C1628 |
| description | gasket L 130mm W 125mm ID ø 106mm rubber | | |
| For models: | AOS102GB, AOS102GA | | |



1

| | | | |
|--------------------|---|-----------------|--------|
| GEV No. | 697963 | Ref. No. | 003882 |
| description | gasket L 139mm W 134mm rubber thickness 4mm | | |
| For models: | FCVG102L3, FCVG202L3, FCVG102L3J, FCV/G102/1L6JAP, FCV/G102/1L6, FCVG202L6, FCV/G102/1, FCV/G202/1, FCS102G4, FCS102GA9J, FCS102G49J, FCS102GP, FCS202G4, FCS202GP, FCS102GX9J, FCS102GX, FCS202GX, 5717-2-6, 5714-2-7, 5714-2-8, 5714-2-10, 5714-2-6L, 5714-2-7L, 5714-2-8L, 5714-2-10L, 5707-2-2, 57074-2-3, ECVG102T4, ECVG202T4, ECV/G102/1T6, ECVG202T6, ACVG102C4, ACVG202C4, ACV/G102/1C6, ACVG202C6, NCV/G102/1, ZCV/G102/1, ZCV/G202/1, ZCV/G102/1T6, ZCV/G202/1 | | |



1

| | | | |
|--------------------|---|-----------------|--------|
| GEV No. | 697959 | Ref. No. | 005768 |
| description | gasket L 163mm W 120mm graphite thickness 2mm | | |
| For models: | FCV/G61/1, FCV/G61/1, FCV/G61/1, FCS061GP, FCS061G4, 5721-2-7, 5721-2-10, ECV/G61/1, ECV/G61/1, ZCV/G61/1 | | |



1

| | | | |
|--------------------|---|-----------------|--------|
| GEV No. | 700491 | Ref. No. | 003990 |
| description | gasket suitable for JUNO equiv. no. 03990 L 40mm W 35mm door catch thickness 1mm | | |
| For models: | FDV40G, FDV40E, FDV40GZ, FDV40EL, FDV40GA, FDV20G, FDV20E, FDV20GZ, FDV20EL, FDV20GA, FCFG201-0, FCFG202-0, FCFE201-0, FCFE202-0, FCF201ENS, 5714-2-6, 5714-2-7, 5714-2-8, 5714-2-10, 5717-2-6, 5714-2-7, 5714-2-8, 5714-2-10, 5714-2-6L, 5714-2-7L, 5714-2-8L, 5714-2-10L, 5714-2-6L, 5714-2-7L, 5714-2-8L, 5714-2-10L, 5714-3-6, 5714-3-7, 5714-3-8, 5714-3-8E, 5714-3-10, 5717-3-6, 5717-3-7, 5717-3-8, 5717-3-8E, 5717-3-10, 5717-3-8M, 5717-3-8C, 5717-3-8M, 5704-2-2, 5704-2-3, 5707-2-2, 57074-2-3, 5704-3-2, 5704-3-3...(Other models you can see in the webshop) | | |



2

| | | | |
|--------------------|---|-----------------|--------|
| GEV No. | 504732 | Ref. No. | 046360 |
| description | gasket suitable for ZANUSSI equiv. no. 046360 L 47mm W 18.5mm thickness 3mm | | |
| For models: | LS360DK, LS365F, LS365, LS365PH, LS500F, LS501F, LS540F, LS540DK, LS541F, LS360D, LS365D, LS360, LS365, LS360/63, LS365/63, LS367, LS720F, LSE720DK, LSE720PH, LS860F, LS860DK, LS860PH, LS1080F, LS1080UK, LS1080PH, LSE721F, LS861F, LS540, LS1080M, LS1080, LS1080D, LS1080UK, LS1080/63, LS500F, LS500UK, LS501, LS501UK, LS540D, LS540/63, LSE721, LS720, LSE720UK, LS721UK, LSE720D, LS541, LS860, LS860D, LS860UK, LS861UK...(Other models you can see in the webshop) | | |

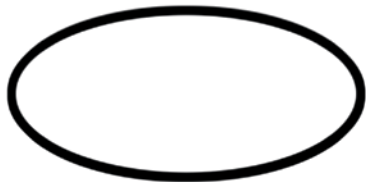

1

| | | | |
|--------------------|--|-----------------|----------------------------|
| GEV No. | 693404 | Ref. No. | 054260 055371 OKF018 |
| description | gasket suitable for ZANUSSI equiv. no. 55371 fanwheel ED ø 800mm | | |
| For models: | FCVE10, FCVE20, FCVE6-1U, FCVE6-3U, FCVE6-1, FCVE6-3, FCVE6-3CE, FCVE6-1UK, FCVE6-3UK, FCFG6-1, FCFG6-3, FCFG6-1UK, FCFG6-3UK, FCVE10-2, FCVE10-4, FCVE103CE, FCVE10-2UK, FCVE10-4UK, FCFG10-2, FCFG10-4, FCFG10-1SG, FCFG10-2, FCFG10-4D, FCFG10-2UK, FCFG10-4UK, FCFG10-2, FCFG10-4, FCVE20-2, FCVE20-4, FCVE203CE, FCVE20/P-V, FCVE20-2UK, FCVE20-4UK, FCFG20-2, FCFG20-4, FCFG20-2, FCFG20-4D, FCFG20-2UK, FCFG20-4UK, FCFG20-4, FCFG20-4D, FCVE20-V, FCVE20VUK, FCVE10-P, FCVE10PUK, FCFG10-P, FCFG10PUK, FCVE20-P, FCVE20PUK, FCFG20-P...(Other models you can see in the webshop) | | |



1

| | | | |
|--------------------|---|-----------------|------------------|
| GEV No. | 693403 | Ref. No. | 003874 237394 |
| description | gasket suitable for ZANUSSI hot air | | |
| For models: | FCV/G10L3, FCFG10L3T, FCV/G20L3, FCFG10L3J, FCV/G10L6JAP, FCV/G10L2, FCV/G10L6, FCV/G20L6, FCV/G101/1, FCV/G201/1, FCS101G2, FCS101G4, FCS101G4DT, FCS101GP9J, FCS101G49J, FCS101GP, FCS201GP, FCS101GX9J, FCS101GX, FCS201GX, 5712-2-6, 5712-2-7, 5712-2-8, 5712-2-10, 5714-2-6, 5714-2-7, 5714-2-8, 5714-2-10, 5712-2-6L, 5712-2-7L, 5712-2-8L, 5712-2-10L, 5714-2-6L, 5714-2-7L, 5714-2-8L, 5714-2-10L, 5712-2-10F, 5712-2-10S, 5714-2-10F, 5714-2-10S, 5702-2-2, 5702-2-3, 5704-2-2, 5704-2-3, ECV/G10T4, ECV/G20T4, ECV/G10T4J, ECV/G20T4J, ECV/G10T6, ECV/G20T6...(Other models you can see in the webshop) | | |



1

| | | | |
|--------------------|--|-----------------|--------|
| GEV No. | 697974 | Ref. No. | 003700 |
| description | gasket U-shape ED ø 22.5mm ID ø 14.5mm | | |
| For models: | DCS | | |

miscellaneous



1

| | | | |
|--------------------|--|-----------------|------------------|
| GEV No. | 900757 | Ref. No. | 0H6888 OK2603 |
| description | strengthening for gasket | | |
| For models: | 5611-3-10, 5611-3-6, 5611-3-8, 5612-3-10, 5612-3-6, 5612-3-8 | | |



transmission technology and ball bearings

ball bearings

deep-groove ball bearings 2RS



1

| | | | |
|--------------------|---|-----------------|------------------|
| GEV No. | 523522 | Ref. No. | 051298 089921 |
| description | deep-groove ball bearing type 6004-2RS shaft \varnothing 20mm ED \varnothing 42mm W 12mm with sealing discs deep-groove ball bearing DIN 625-1 | | |
| For models: | HBR/G820, HBR/G825, HBR/E820, HBR/E825, HBR/G821UK, ZBR/E820, ZBR/E825, ZBR/G821, ZBR/G826, ABR/G820, ABR/G825, ABR/E820, ABR/E825, HBR/G803, HBR/G804, HBR/G803, HBR/G804, HBR/G803, HBR/G805, HBR/G1003, HBR/G1003, HBR/G1004, HBR/E801, HBR/E803, HBR/E804, HBR/E805UK, HBR/E1003, HBR/G803, HBR/G804, HBR/G1013, HBR/E1013, HBR/G803, HBR/G804, HBR/G1003, HBR/G1013, HBR/E801, HBR/E803, HBR/E804, HBR/E1003, HBR/E1013, HBR/G1004 | | |



1

| | | | |
|--------------------|--|-----------------|----------------------------|
| GEV No. | 523509 | Ref. No. | 072019 0D5346 0D7113 |
| description | deep-groove ball bearing type 6201-2RS shaft \varnothing 12mm ED \varnothing 32mm W 10mm with sealing discs deep-groove ball bearing DIN 625-1 | | |
| For models: | TT600E, TT600G, TT600V, D1000V, T5S-01, T5S-02, T5S-03, DMIX5-01, DMIX5-02, T5S-04, DMIX5-03, DMIX5-04, DMIX5-05, DMIX5-06, T5S-08, T5S-09, T5S-10, T5S-11, DMIX5-14, AMIX-01, AMIX-02, DMIX-09, DMIX-07, AMIX-03, DDMIX5C, T5S-07, T5S-05, T5S-06, DMIX-08, DMIX5-11, DMIX5-12, DMIX5-10, DMIX5-13, DMIX5-14, DDMIX5CYW, DDMIX5CBL, DDMIX5CRD, DDMIX5CBK, DDMIX5COR, DMIX5-18, DDMIX5G, DMIX5-15, DMIX5-16, T5S-03, T5S-12, DMIX5-17, DMIX5-18, DMIX5-19, DMIXSIR, T5S-12 | | |



1

| | | | |
|--------------------|---|-----------------|---|
| GEV No. | 523510 | Ref. No. | 045312 045726 056820 065048 072702 072751 0D0035 0H2689 0KT988 62022Z 6202Z 63646403 |
| description | deep-groove ball bearing type 6202-2RS shaft \varnothing 15mm ED \varnothing 35mm W 11mm with sealing discs deep-groove ball bearing DIN 625-1 | | |
| For models: | MBR/G710D, MBR/E710D, MBR/G700, MBR/G700F, MBR/E700, MBR/E700UK, MBR/G700UK, MBR/G701, MBR/G706, MBR/G701UK, MBR/G751, MBR/G756, MBR/E716, MBR/E706, RBR/G2FM, RBR/G2IM, RBK/G2FM, RBR/E2FM, RBR/E2IM, RBK/E2FM, XBR/G2FM, XBR/G2IM, XBK/G2FM, XBR/E2FM, XBR/E2IM, XBK/E2FM, JBR/G2FM, JBR/E2FM, MBR/G2FM, MBR/G2IM, MBK/G2FM, MBR/E2FM, MBR/E2IM, MBK/E2FM, RBR/G710D, 7BRE60XN, RBR/G700, RBR/G700F, 7BRE60X, RBR/E700UK, 7BRG60, 7BRG60X, RBR/G701UK, RBR/G751, RBR/G756, RBR/E716, RBR/E706, XBR/G710D, XBR/E710D, XBR/G700...(Other models you can see in the webshop) | | |



1

| | | | |
|--------------------|---|-----------------|------------------------------------|
| GEV No. | 523511 | Ref. No. | 089918 0D0821 0KJ007 3041 |
| description | deep-groove ball bearing type 6203-2RS shaft \varnothing 17mm ED \varnothing 40mm W 12mm with sealing discs deep-groove ball bearing DIN 625-1 | | |
| For models: | K35, K35, K35-11, MULTI2-01, TRS-3-02, TRS-3-03, TRS-1-02, T15S-01, TRS-1-03, MULTI2-02, XBE10AS-01, K35-01, T10S-01, T15S-02, XBE10AS-02, T10S-02, TRS-3-04, K35-02, TRS-3-05, PL15-01, XBE10AS-03, K35-03, XBE10S-1, TRS-1-04, CD4-02, CD8-02, PL15-02, PL15-03, XBE10S-02, XBE10AS-04, XBE10S-03, TRS-1-05, XBE10S-04, PL4-01, PL8-01, TRS-1-06, MULTI2-03, T10S-03, T15S-03, K35-04, TRS-1-07, S4A3STD, S4A1STD, S8A3STD, S8A1STD, K35-05, TRS-1-08, TRS-3-06, TR300-01, BM10S-01...(Other models you can see in the webshop) | | |



1

| | | | |
|--------------------|--|-----------------|------------------|
| GEV No. | 523512 | Ref. No. | 0H2694 0KQ395 |
| description | deep-groove ball bearing type 6204-2RS shaft \varnothing 20mm ED \varnothing 47mm W 14mm with sealing discs deep-groove ball bearing DIN 625-1 | | |

mechanical components, equipment accessories

springs

torsion springs

| | | | |
|---|---|-----------------|--------|
|  | | | |
| GEV No. | 700487 | Ref. No. | 054560 |
| description | torsion spring ø 10.8mm L2 5mm wire gauge ø 2.2mm L1 86mm L3 86mm | | |
| For models: | COCO6G, COCO6E | | |

| | | | |
|---|---|-----------------|--------|
|  | | | |
| GEV No. | 700450 | Ref. No. | 054282 |
| description | torsion spring ø 13mm L2 177mm wire gauge ø 2.5mm L1 10mm L3 177mm Qty 1 pcs | | |
| For models: | FCF/G6-0, FCFG101/0, FCFG102-0, FCF/E6-0, FCFE101-0, FCFE102-0, FCF061ELN, FCF101ELN, FCF6EHOR, FCFG10160H, FCF061ENS, FCF101ENS, FCF102ENS, FCFG102-0T, FCF/G6-1-JAP, FCF/G101/1-1-JAP, FCF/G102/1-1-JAP, FCFE6-1J, FCFE101-1J, FCFE102-1J, FCF/G101/1, FCFG10, FCFG10D, FCFG10NL, FCFE10, FCFE10UK, FCFG20, FCFG20D, FCFG20F, PFCFG20, FCFE20, FCFE20UK, FCFG40, FCFG41, FCFG40D, FCFG40F, PFCFG40F, FCFE40, FCFE40D, FCFE40UK, PFCFE40F, FCVE10, FCVE20, FCFG10J, FCFG10J, FCFE10J, FCFE10J, FCFG20J, FCFG20J, FCFE20J...(Other models you can see in the webshop) | | |

compression springs

| | | | |
|--|---|-----------------|------------------|
|  | | | |
| GEV No. | 700445 | Ref. No. | 053757 0F0155 |
| description | compression spring ø 21.7mm L 29mm wire gauge ø 1.5mm | | |
| For models: | HCCS20W, HCCS20W, FCF/G6-0, FCFG101/0, FCFG102-0, FCF/E6-0, FCFE101-0, FCFE102-0, FCF061ELN, FCF101ELN, FCF6EHOR, FCFG10160H, FCF061ENS, FCF101ENS, FCF102ENS, FCFG102-0T, FCF/G6-1-JAP, FCF/G101/1-1-JAP, FCF/G102/1-1-JAP, FCFE6-1J, FCFE101-1J, FCFE102-1J, FCF/G101/1, FCFG10, FCFG10D, FCFG10NL, FCFE10, FCFE10UK, FCFG20, FCFG20D, FCFG20F, PFCFG20, FCFE20, FCFE20UK, FCFG40, FCFG41, FCFG40D, FCFG40F, PFCFG40F, FCFE40, FCFE40D, FCFE40UK, PFCFE40F, FCVE10, FCVE20, FCFG10J, FCFG10J, FCFE10J, FCFE10J, FCFG20J...(Other models you can see in the webshop) | | |

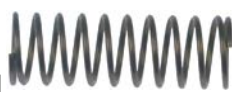
| | | | |
|---|--|-----------------|--------------------|
|  | | | |
| GEV No. | 519544 | Ref. No. | 047489 30213076 |
| description | compression spring ø 9.1mm L 28mm wire gauge ø 0.8mm | | |
| For models: | LSD551, LSD55V, LS510, LS520, LS520D, LS520F, LS520M, LS520K, LS521, LS521D, LS521F, LS521M, LS521K, LS521, LS4, ZLS510, ZLS520, ZLS521, ALLS521, ALLS520, ALS510, C51, C52, C50, LS520ZD, LS521ZD, CF314, LS510MZ, LS520MZ, LS521MZ | | |

miscellaneous

| | | | |
|---|--|-----------------|--------|
|  | | | |
| GEV No. | 700455 | Ref. No. | 055558 |
| description | spring | | |
| For models: | FCF02EV, FCF02EOEM, FCF/E3, FCF/E2, FCF/E2D, FCF/E2UK, FCF/E2, FCF/E2, FCF/E2D | | |

| | | | |
|--|--|-----------------|----------------------------|
|  | | | |
| GEV No. | 691220 | Ref. No. | 053342 058444 0G2210 |
| description | spring clip shaft diameter 6mm ømm L 17mm W 14mm H 5mm wire gauge ø 1.5mm | | |
| For models: | ICP111, ICF110, ICF110, AP20, BC100A, BC100DA, BC100RA, BC100R-DA, BC180A, BC180DA, BC180RA, BC180RDA, BC180RPA, BC11, BC22, BC44, BC44H, BCF11, BCF22, BCF44, BCF44H, BCF100A, BCF100DA, BCF100RA, BCF100RDA, BCF180A, BCF180DA, BCF180RA, BCF180R-DA, BCF180RPA, AQC22U US, AQC31U US, AQC60U, AQC119U US, ,, BC28A6, Crosswise, ,, BCF15A6, ,, ALP110, ALP120, ALP111, ALP220, ALP240, ALP221, ALN110...(Other models you can see in the webshop) | | |

kitchen accessories

gastronorm

GN containers

SS 18/10 - standard

| | | | |
|---|--|-----------------|---|
|  | | | |
| GEV No. | 993020 | Ref. No. | 050871 0S1873 |
| description | GN container SS 18/10 size GN 1/1 D 40mm | | |
| accessories for | 993020 | | |
| | GEV No. | Ref. No. | — |
| | | | lid SS 18/10 size GN 1/1 for GN container Dmm |

baking sheets

| | | | |
|--|---|-----------------|--------|
|  | | | |
| GEV No. | 694965 | Ref. No. | OKI553 |
| description | baking sheet W 265mm L 325mm H 40mm SS GN 1/2 perforated inner edges rounded suitable for combi-steamer | | |
| For models: | 7CO30, CCO30G, ECO312CF, OTS100 | | |



manometers

| | | | |
|--------------------|---|-----------------|--------|
| <p>1</p> | | | |
| GEV No. | 541798 | Ref. No. | 058941 |
| description | manometer ø 52mm pressure range 0-6bar connection lower thread 1/4" | | |
| For models: | FCV/G6L3TOWNGAS, FCV/G6L3, FCV/E101/1, FCVE6L3J, FCV/G6L3JAP, FCVG6L3CJ, FCV/E61/1, FCV/G10L2, FCV/E10L2, FCV/E61/1, FCV/G6L3C, FCV/G61/1, FCVG6L3CT, FCVG6L3CJ, FCV/E6L3, FCV/E101/1, FCS061E44J, FCS061G48J, FCS061G3DI, FCS061E3CI, FCS101E2, FCS061G4DT, FCS061G49J, FCS101G2, FCVG10-ISG, FCVMG62, ECV/G6T4C, ECV/E10IGP, RCV061G2, RCV061E2, RCV101G2, RCV101E2, ACV/G10C2, ACV/E10C2, ACV/G6C3, ACV/G6C3C, ACV/E6C3, NCV/G6L2, NCV/G10L2, NCV/E6L2, NCV/E10L2, FCVG10-ISG, ZCV/G6T4C | | |

| | | | |
|------------------------|---|-----------------|--------------------------------------|
| <p>1</p> | | | |
| GEV No. | 541062 | Ref. No. | 0H6487 0K083 236116 9151915 |
| description | manometer ø 63mm pressure range 0 up to 1bar connection marking adjustable kettle thread 1/4" | | |
| spare parts for | 541062 | | |
| | GEV No. | 541130 | Ref. No. — |
| | <p>glass panel ø 58mm thickness 2mm</p> | | |

| | | | |
|--------------------|---|-----------------|---|
| <p>1</p> | | | |
| GEV No. | 541460 | Ref. No. | 0H9970 0K2991 0K5402 129648 9877132KL16 |
| description | manometer pressure range 0 up to 2.5bar marking 1.3 | | |
| For models: | VARIOSTEAM/S-33.3/F, STEAM-O-MAT | | |

hose reels and spray guns

spray guns

| | | | |
|--------------------|--|-----------------|--------------------|
| <p>1</p> | | | |
| GEV No. | 542964 | Ref. No. | 00920003 050323 |
| description | spray gun for appliances 1/2" ET L 135mm | | |

| | | | |
|------------------------|---|-----------------|-------------------------------|
| <p>1</p> | | | |
| GEV No. | 549332 | Ref. No. | 003167 7i003167 9030100 |
| description | spray gun for appliances 1/2" IT L 215mm type ZANUSSI | | |
| accessories for | 549332 | | |
| | GEV No. | 520168 | Ref. No. — |
| | <p>double nipple nickel-plated brass thread 1/2" - 1/2" Qty 1 pcs</p> | | |

| | | | |
|--------------------|--|-----------------|--------|
| <p>1</p> | | | |
| GEV No. | 542098 | Ref. No. | 0L0454 |
| description | spray gun for appliances 3/8" IT L 130mm type LAINOX | | |



1

| | | | |
|--------------------|--|-----------------|---------------------------------------|
| GEV No. | 542038 | Ref. No. | 003175 0K1055 903030 9030302 |
| description | spray gun for appliances 3/8" IT L 135mm | | |
| For models: | DCS | | |



1

| | | | |
|--------------------|----------------------------|-----------------|-------------------|
| GEV No. | 542966 | Ref. No. | 003513 9030070 |
| description | wall holder for hand spray | | |

hose reels

appliance hose reels



1

| | | | |
|--------------------|---|-----------------|--------|
| GEV No. | 542357 | Ref. No. | 0C4248 |
| description | hose reel complete hose length 1.3m connection 1/8" hose ø 13mm | | |
| For models: | FCZ061EAA, FCZ101EAA, FCZ102EAA, FCZ061EAH, FCZ101EAH, FCZ061EAN, FCZ101EAN, FCZ061ETA, FCZ101ETA, FCZ102ETA, FCZ061ETH, FCZ101ETH, FCZ061ETN, FCZ101ETN, FCZ061GAG, FCZ101GAG, FCZ102GAG, FCZ061GAD, FCZ101GAD, FCZ102GAD, FCZ101GTG, FCZ102GTG, FCZ101GTD, FCZ102GTD, FCZ061EBA, FCZ101EBA, FCZ102EBA, FCZ061EBH, FCZ101EBH, FCZ061EBN, FCZ101EBN, FCZ061EBC, FCZ101EBC, FCZ061EBA2, FCZ101EBA2, FCZ102EBA2, FCZ061EBH2, FCZ101EBH2, FCZ061EBN2, FCZ101EBN2, FCZ061EBC2, FCZ101EBC2, FCZ061GBI, FCZ101GBI, FCZ101GBG2, FCZ102GBG2, FCZ101GBD2, FCZ102GBD2, FCZ101GBI2, FCZ102GBI2...(Other models you can see in the webshop) | | |



1

| | | | |
|--------------------|--|-----------------|--------|
| GEV No. | 542395 | Ref. No. | 0S0662 |
| description | spray gun for appliances set 1/2" IT type KLARCO | | |



1

| | | | |
|--------------------|--|-----------------|--------|
| GEV No. | 520532 | Ref. No. | 003170 |
| description | shower hose connections 3/8" L 1600mm EPDM t.max. 110°C burst p. 10bar for combi-steamer | | |
| For models: | DCS | | |



1

| | | | |
|--------------------|--|-----------------|--------|
| GEV No. | 542397 | Ref. No. | 0C2218 |
| description | hose reel complete with spray gun hose length 1.4m hose ø 6.3x13.2mm hose type silicone SS | | |
| For models: | AOS061GAEU, AOS101GAEU, AOS061GAU, AOS101GAU, AOS061EABU, AOS101EABU, AOS061EAFU, AOS101EAFU, AOS061EA, AOS061EB, AOS101EA, AOS101EB, AOS061EA3J, AOS061EB3J, AOS101EA3J, AOS101EB3J, AOS061EA2N, AOS061EB2N, AOS101EA2N, AOS101EB2N, AOS061EA0H, AOS061EB0H, AOS101EA0H, AOS101EB0H, AOS101GA, AOS101GB | | |



1

| | | | |
|--------------------|-------------|-----------------|--------|
| GEV No. | 540675 | Ref. No. | 003164 |
| description | shower head | | |



1

| | | | |
|--------------------|---|-----------------|--------|
| GEV No. | 545800 | Ref. No. | OC1128 |
| description | hose reel complete with spray gun hose length 1.6m | | |
| For models: | AOS201EB, AOS201EB3J, AOS201EB2N, AOS202EB2N, AOS201EB0H, AOS202EB, AOS201GB, AOS202GB, AOS201EBAQ, AOS202EBAQ, AOS201EBN, AOS202EBN, AOS201EBCQ, AOS201EBHQ, AOS201EB-FQ, AOS201GBGQ, AOS202GBGQ, AOS201GBDQ, AOS202GBDQ | | |



1

| | | | |
|--------------------|--|-----------------|------------------|
| GEV No. | 545178 | Ref. No. | 007039 OC1156 |
| description | hose reel for combi-steamer complete with spray gun hose length 1.6m connection 1/2" IT hose ø 12mm hose type EPDM | | |
| For models: | AOS061EA, AOS061EB, AOS101EA, AOS101EB, AOS061EA3J, AOS061EB3J, AOS101EA3J, AOS101EB3J, AOS061EA2N, AOS061EB2N, AOS101EA2N, AOS101EB2N, AOS061EA0H, AOS061EB0H, AOS101EA0H, AOS101EB0H, AOS061GA, AOS101GA | | |

spare parts and accessories

miscellaneous



1

| | | | |
|--------------------|---|-----------------|--------|
| GEV No. | 545179 | Ref. No. | 003701 |
| description | spring for hose reel thickness 1mm for hose 6x12mm spring steel combi-steamer | | |
| For models: | DCS | | |

dosing pumps

membrane dosing pumps

self-priming

LANG

accessories



1

| | | | | |
|--|---|-----------------|------------------|------------------|
| GEV No. | 101286 | Ref. No. | 020992 053666 | |
| description | olive ID ø 6mm Qty 1 pcs | | | |
| For models: | MTF/G1050, MTF/GE1050, MT/G700F, MTF/G700F, MTF/G1055F, MTFGE1055F, RCF/G720, RCF/G1020, RCF/G730, RCF/G1030, RCF/G720F, RCF/G1020, 7TPG10F, RT/G700F, RTF/G700, RTF/G1050, CCF/G710, RTFG720, RTF/G720F, RTF/G1020, RTF/G1030, RTF/G1020F, HR/G403, HR/G803, HR/G413, HR/G814, HR/G403D, HR/G803D, HBR/G820, HBR/G825, HTR/G411, HTR/G811, ZR/G403, ZR/G803, ZR/G413, ZR/G814, ZR/G403D, ZR/G803D, 2FTGF4L, 2FTGF8L, AR/G403, AR/G803, AR/G403D, AR/G803D, ABR/G820, ABR/G825, ATR/G411, FCFG10, FCFG10D, FCFG10NL...(Other models you can see in the webshop) | | | |
| accessories for | 101286 | | | |
|  | GEV No. | 100909 | Ref. No. | 003859 057821 |
| | union screw thread M10x1 for pipe ø 6mm Qty 1 pcs | | | |
|  | GEV No. | 101464 | Ref. No. | — |
| | union nut thread M12x1 for pipe ø 6mm | | | |

accessories

container filters



1

| | | | |
|--------------------|---|-----------------|--------|
| GEV No. | 362014 | Ref. No. | OC1155 |
| description | container filter for combi-steamer SS hose ø 6mm | | |
| For models: | FCZ061EAA, FCZ101EAA, FCZ102EAA, FCZ201EAA, FCZ202EAA, FCZ061EAH, FCZ101EAH, FCZ201EAH, FCZ061EAN, FCZ101EAN, FCZ201EAN, FCZ061ETA, FCZ101ETA, FCZ102ETA, FCZ061ETH, FCZ101ETH, FCZ061ETN, FCZ101ETN, FCZ061GAG, FCZ101GAG, FCZ102GAG, FCZ201GAG, FCZ061GAD, FCZ101GAD, FCZ102GAD, FCZ101GTG, FCZ102GTG, FCZ101GTD, FCZ102GTD, FCZ061EBA, FCZ101EBA, FCZ102EBA, FCZ201EBA, FCZ202EBA, FCZ061EBH, FCZ101EBH, FCZ201EBH, FCZ061EBN, FCZ101EBN, FCZ201EBN, FCZ061EBC, FCZ101EBC, FCZ201EBC, FCZ061EBA2, FCZ101EBA2, FCZ102EBA2, FCZ061EBH2, FCZ101EBH2, FCZ061EBN2, FCZ101EBN2...(Other models you can see in the webshop) | | |



mounting sets



| | | | |
|--------------------|---|-----------------|--------|
| GEV No. | 361942 | Ref. No. | OC1127 |
| description | hose set detergent/rinse aid hose type 6x9mm hose length 2x2m PVC incl. container filter and screw connection | | |
| For models: | FCZ201EAA, FCZ202EAA, FCZ201EAH, FCZ201EAN, FCZ201ETA, FCZ202ETA, FCZ201ETH, FCZ201ETN, FCZ201GAG, FCZ202GAG, FCZ201GAD, FCZ202GAD, FCZ201GTG, FCZ202GTG, FCZ201GTD, FCZ202GTD, FCZ201EBC, FCZ201EBA2, FCZ202EBA2, FCZ201EBH2, FCZ201EBN2, FCZ201EBC2, FCZ201GBI, FCZ201GBG2, FCZ202GBG2, FCZ201GBD2, FCZ202GBD2, FCZ201GBI2, FCZ201ECA, FCZ202ECA, FCZ201ECH, FCZ201ECN, FCZ201ECA2, FCZ202ECA2, FCZ201ECH2, FCZ201ECN2, FCZ201GCG, FCZ202GCG, FCZ201GCD, FCZ202GCD, FCZ201GCG2, FCZ202GCG2, FCZ201GCD2, FCZ202GCD2, AOS-201GAEU, AOS202GAEU, AOS201GAU, AOS202GAU, AOS201EABU, AOS201EAFU...(Other models you can see in the webshop) | | |

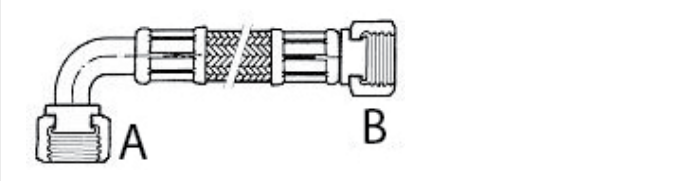
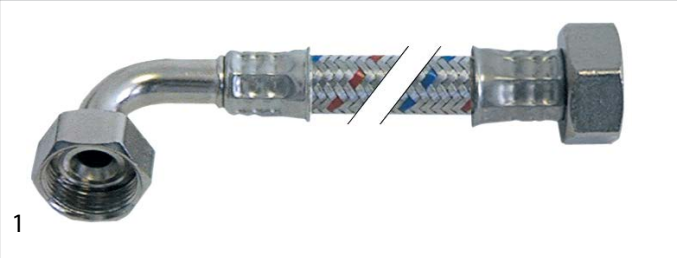

| | | | |
|---|--|-----------------|---|
| GEV No. | 520008 | Ref. No. | 069571 0A6098 0S0151 0S0733 143016 252 |
| description | flex hose SS braid straight-curved DN12 connection 1: 3/4" connection 2: 3/4" L 1500mm operating p. 10bar test pressure 32bar burst p. 95bar | | |
| For models: | LTB11, LTB12, LTB22, LTB11UK, LTB12UK, LTB22UK, LTB11, LTB22, 910-00-021, 910-00-023, 910-00-031, 910-00-033, 911-00-022, 911-00-024, 911-00-032, 911-00-034, CRYSTAL 11, CRYSTAL 22 | | |
| accessories for | 520008 | | |
|  | GEV No. | 520054 | Ref. No. — |
| | flat gasket rubber ED ø 23.5mm ID ø 14mm thickness 2.3mm Qty 10 pcs | | |

hoses

supply hoses

stainless steel flexi hoses

universal hoses

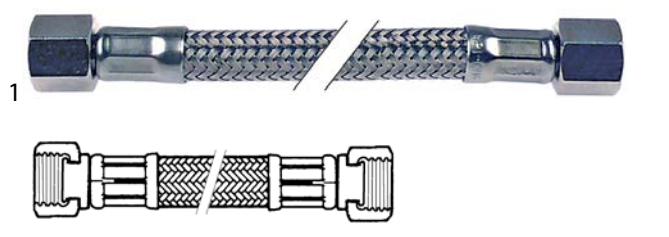

| | | | |
|--------------------|--|-----------------|--------|
| GEV No. | 520612 | Ref. No. | 0D2999 |
| description | flex hose SS braid straight-straight DN10 connections 1/2" L 1000mm approval DVGW operating p. 10bar test pressure 32bar burst p. 95bar | | |
| For models: | T5E-04, T5E-01, T5M-01, T5E-02, T5E-03, T8E-01, T8E-02, T8M-01, T8E-03, T5E-05, T5E-06, T5E-05, T5E-04, T5E-01, T5M-01, T5E-02, T8E-01, T8E-02, T8M-01, T8E-03 | | |

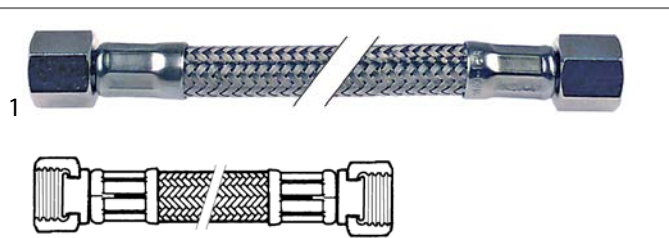

| | | | |
|--------------------|---|-----------------|--------|
| GEV No. | 520613 | Ref. No. | 0S0348 |
| description | flex hose SS braid straight-straight DN10 connections 1/2" L 1500mm approval DVGW operating p. 10bar test pressure 32bar burst p. 95bar | | |

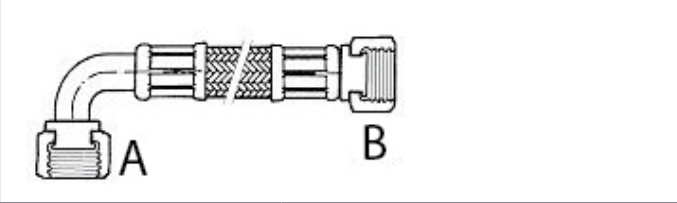
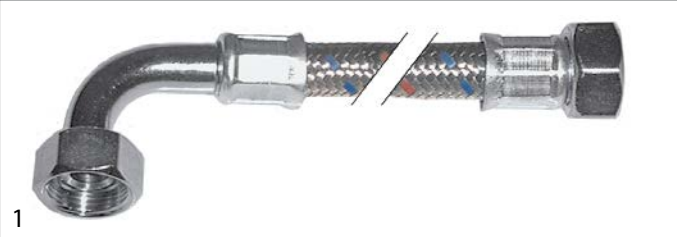

| | | | |
|--------------------|--|-----------------|------------------|
| GEV No. | 520007 | Ref. No. | 048621 049540 |
| description | flex hose SS braid straight-curved DN15 connection 1: 3/4" connection 2: 3/4" L 2500mm approval operating p. 10bar test pressure 32bar burst p. 95bar | | |
| For models: | LS5/1DPAUS, LS5/1DPCS, WT38/M50, WT38WS, WT38MEDWS, WT37LEV/9, WT38DWS, WT38M50/4, WT38D, WT37, WT38, WT37/4.5, WT38/4.5, WT38C, WT38C60, WT38/4.5NW, WT37J60, WT37J50, LS6AH240U, WT30H208U, WT30H240U, WT30H208DU, WT30H240DU, WT30H208RU, WT30H240RU, LS6AH208DU, LS6AH208U, WT38/60, WT38/M60, WT38MED, LS6AH240DU, LS6AH208RU, LS6AH240RU, WT30M208U, WT30M240U, WT30M208DU, WT30M240DU, WT30M-208RU, WT30M240RU, WT30C208DU, WT30C240DU, WT38M60/4, WT30H208WS, WT30H240WS, WT32/4,5N, WT33/4,5N, WT38WL, WT34/4,5N, LS10D, LS10...(Other models you can see in the webshop) | | |





1





| | | | |
|--------------------|---|-----------------|--------|
| GEV No. | 520533 | Ref. No. | 003166 |
| description | flex hose SS straight-curved DN6 connection 1: 1/2" connection 2: 1/2" L 2500mm approval DVGW operating p. 10bar test pressure 32bar burst p. 95bar | | |

PVC supply hoses



1

| | | | |
|---|---|-----------------|------------------------|
| GEV No. | 520460 | Ref. No. | 0C8316 |
| description | supply hose PVC straight-curved DN12 connections 3/4" L 1500mm operating p. 10bar burst p. 32bar t.max. 90°C blue approval WRAS | | |
| accessories for | 520460 | | |
|  | GEV No. | 520053 | Ref. No. 0C4096 |
| | screen connection 3/4" D1 ø 26mm D2 ø 15mm Qty 10 pcs rubber thickness 8mm | | |
|  | GEV No. | 520054 | Ref. No. — |
| | flat gasket rubber ED ø 23.5mm ID ø 14mm thickness 2.3mm Qty 10 pcs | | |

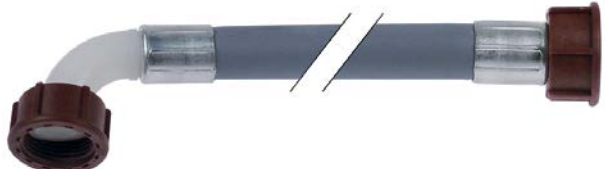

1

| | | | |
|---|--|-----------------|--|
| GEV No. | 520010 | Ref. No. | 005131 053789 066463 0C5562 0K2438 0S0150 |
| description | supply hose PVC straight-curved DN13 connections 3/4" L 1500mm operating p. 10bar burst p. 32bar t.max. 90°C blue approval VDE flat seal | | |
| For models: | FDV40G, FDV40E, FDV40GZ, FDV40EL, FDV40GA, FDV20G, FDV20E, FDV20GZ, FDV20EL, FDV20GA, FCZ061EAA, FCZ061EAH, FCZ061E-AN, FCZ061EBA, FCZ061EBH, FCZ061EBN, FCZ061EBC, FCZ061ECA, FCZ061ECH, FCZ061ECN, FCV/G10L3, FCV/G6L3TOWNGAS, FCV/G6L3, FCVG10L3T, FCVG10L3, FCV/E101/1, FCV/G20L3, FCVG20L3, FCVE6L3J, FCV/E10L3JAP, FCV/E102/1L3JAP, FCV/E10L6JAP, FCV/E102/1L6JAP, FCV/G6L3JAP, FCVG10L3J, FCVG10L3J, FCV/G10L6JAP, FCV/G102/1L6JAP, FCVG6L3CJ, FCV/E61/1, FCV/G10L2, FCV/E61/1, FCV/E101/1, FCV/E101/1, FCV/E10L2, FCV/E102/1, FCV/E61/1, FCV/E61/1, FCV/E101/1, FCV/E101/2...(Other models you can see in the webshop) | | |
| accessories for | 520010 | | |
|  | GEV No. | 520053 | Ref. No. 0C4096 |
| | screen connection 3/4" D1 ø 26mm D2 ø 15mm Qty 10 pcs rubber thickness 8mm | | |

accessories for 520010

| | | | | |
|---|---|--------|-----------------|---|
|  | GEV No. | 520054 | Ref. No. | — |
| | flat gasket rubber ED ø 23.5mm ID ø 14mm thickness 2.3mm Qty 10 pcs | | | |



1

| | | | |
|--------------------|---|-----------------|--|
| GEV No. | 520011 | Ref. No. | 047605 048816 049378 0K1135 0L1031 0L1887 0S0153 |
| description | supply hose PVC straight-curved DN13 connections 3/4" L 2000mm operating p. 10bar burst p. 32bar t.max. 90°C approval VDE flat seal | | |
| For models: | EPPWELG, LS32, LS32/4.5, LS32UK/RP, LS32F, LV32F, C55, LV32/60, WT4, WT4B, WT4D, WT302, WT302/4.5, WT302UK/RP, WT302F, WT302/60, WT4DB, WT46, WT4DG, WT4WS1, LS33, LS33/4.5, LS33UK/RP, LS33F, LV33F, C55A, LS33/60, WT4BWS, WT4DWS1, WT4BDWS, WT303, WT303/4.5, WT303UK/RP, WT303F, WT303/60, EUC1/2, EUC1DP/2, EUC1WS/2, EUC1DPWS/2, EUC3/2, NUC3DD, WT4D60, WT4DDG, EUC3WS/2, EUC3DP/2, EUC3DD/2, EUC3DPWS/2, EUC3DDWS/2, ZUC1, ZUC1DP...(Other models you can see in the webshop) | | |



1

| | | | |
|--------------------|---|-----------------|------------------|
| GEV No. | 520888 | Ref. No. | 060933 0S0152 |
| description | supply hose PVC straight-straight DN14 connections 3/4" L 1500mm operating p. 10bar burst p. 32bar t.max. 90°C grey approval VDE flat seal | | |
| For models: | LB8G, LB8G/63, LB8GF, LB8GPH, LB8G, LB8GPHm, LB80EPH, LB80E, LB120EPH, LB120E, LB160EPH, LB160E, LB160V, CLB160E, CLB160V, LB70E, LB110E, LB80E, LB8G, LB70E, LB120E, LB160EZ, LB160V, CLB160E, CLB160V, EWM120, EWM160 | | |

pre-rinse hoses

PVC braided hoses



1

| | | | |
|--------------------|---|-----------------|--|
| GEV No. | 520531 | Ref. No. | 0C4539 0C4541 0L0674 0L0675 0L1161 0S1262 |
| description | shower hose L 1400mm silicone FDA-BGA compliant | | |



industrial hoses

Niplaflex hoses



| | | | |
|--------------------|--|-----------------|------------------|
| GEV No. | 530719 | Ref. No. | 055345 055445 |
| description | hose ID ø 11mm ED ø 18mm L 0.4m operating p. 10bar burst p. 30bar t.max. 110°C | | |
| For models: | MBR/G710D, MBR/E710D, MBR/G700, MBR/G700F, MBR/E700, MBR/E700UK, MBR/G700UK, MBR/G701, MBR/G706, MBR/G701UK, MBR/G751, MBR/G756, MBR/E716, MBR/E706, MCP/E700, MCP/G700, MCP/E700D, MCP/G701, MCP/G710, MCP/G711, RCP/E2S, MCP/E1SH, MCP/E1SUH, MCP/E2SUHS, MCP/E2S, MCP/E2SH, MCP/E2SUH, MCP/E2SUT, MCP/E2SHB, RBR/G710D, 7BRE60XN, RBR/G700, RBR/G700F, 7BRE60X, RBR/E700UK, 7BRG60, 7BRG60X, RBR/G701UK, RBR/G751, RBR/G756, RBR/E716, RBR/E706, 7CPE07P, 7CPG07P, RCP/G701, XBR/G710D, XBR/E710D, XBR/G700, XBR/G710, M70EBP...(Other models you can see in the webshop) | | |



| | | | |
|--------------------|--|-----------------|-------------|
| GEV No. | 570561 | Ref. No. | 086085-40MT |
| description | pressure hose ID ø 10mm ED ø 17mm L 40m thickness 3.5mm operating p. 10bar burst p. 30bar t.max. 110°C | | |



| | | | |
|--------------------|--|-----------------|--|
| GEV No. | 530561 | Ref. No. | 002707 086085 0C3165 0C4158 0F0092 0K2439 0K8058 0K8734 263246 28190001 |
| description | pressure hose ID ø 10mm ED ø 17mm L 5m thickness 3.5mm operating p. 10bar burst p. 30bar t.max. 110°C | | |
| For models: | FDV40G, FDV40E, FDV40GZ, FDV40EL, FDV40GA, FDV20G, FDV20E, FDV20GZ, FDV20EL, FDV20GA, RPD/G240, RPD/G260, RPI/G260, RPI/E240, RPI/E260, RPI/G260P, RPI/E260P, RBV/G2, RBV/E2, XPD/G240, XPD/G260, XPI/G260, XPI/E240, XPI/E260, XPI/G260P, XPI/E260P, XBV/G2, XBV/E2, JPD/G240, JPD/G260, JPI/G260, JPI/E240, JPI/E260, JBV/G2, JBV/E2, MPD/G240, MPD/G260, MPI/G260, MPI/E240, MPI/E260, MPI/G260P, MPI/E260P, MBV/G2, MBV/E2, PPD/G260, PPI/G260P, PPI/E260P, PBV/G2, PB/E1, PB/E2...(Other models you can see in the webshop) | | |

PVC hoses

PVC hoses without fabric



| | | | |
|--------------------|---|-----------------|--------|
| GEV No. | 520029 | Ref. No. | 0C2309 |
| description | PVC hose ID ø 6mm ED ø 9mm L 10m thickness 1.5mm t.max. 60°C transparent | | |
| For models: | FCZ061ETA, FCZ061ETH, FCZ061ETN, FCZ061EBA2, FCZ061EBH2, FCZ061EBN2, FCZ061EBC2, FCZ061ECA2, FCZ061ECH2, FCZ061ECN2, AOW101EA, AOS061GA, AOS101GA, AOW101EABU, AOS062EAM1, AOS062EAB1, AOS061ETA1, AOS061ETH1, AOS061ETN1, AOS061ETC1, AOS061ETE1, AOS061ETF1, AOS061ETM1, AOS062ETM1, AOS061ETK1, AOS061EBA2, AOS061EBH2, AOS061EBN2, AOS061EBC2, AOS061EBE2, AOS061EBF2, AOS061EBK2, AOS062ECM1, AOS062ECB1, AOS061ECA2, AOS061ECH2, AOS061ECN2, AOS062ECM2 | | |

silicone hoses

without fabric



| | | | |
|--------------------|---|-----------------|--------|
| GEV No. | 570121 ¹ | Ref. No. | 006248 |
| description | silicone hose ID ø 20mm ED ø 26mm Lm t.max. 200°C | | |
| For models: | FDV40G, FDV40GZ, FDV40GA, FDV20G, FDV20GZ, FDV20GA, FCV/E101/1, FCV/G20L3, FCVG202L3, FCV/E61/1, FCV/E61/1, FCV/E101/1, FCV/E101/1, FCV/E102/1, FCV/E61/1, FCV/E61/1, FCV/E101/1, FCV/E101/2, FCV/G61/1, FCV/G61/1, FCV/G61/1, FCV/E102/1, FCV/E101/1, FCV/G20L6, FCVG202L6, FCV/G101/1, FVC/E101/1, FCV/G102/1, FVC/E102/1, FCV/G201/1, FVC/E201/1, FCV/G202/1, FVC/E202/1, FCS061E44J, FCS061G48J, FCS061EP, FCS061G3DI, FCS061E3CI, FCS101E2, FCS061G4DT, FCS061G49J, FCS101EP4J, FCS101EP, FCS102EP4J, FCS102EP, FCS201E4, FCS201EP, FCS202E4, FCS202EP, FCS201GP...(Other models you can see in the webshop) | | |

¹by the meter

formed hoses

straight



| | | | |
|--------------------|---|-----------------|--------------------------------------|
| GEV No. | 504626 | Ref. No. | 045457 045768 045806 068640 |
| description | formed hose D1 ø 55mm D2 ø 45mm L 300mm dishwasher straight | | |
| For models: | EPPWELG, LS32, LS32/4.5, LS32UK/RP, LS32F, LV32F, C55, LV32/60, WT302, WT302/4.5, WT302UK/RP, WT302F, WT302/60, WT4DG, WT4WS1, LS33, LS33/4.5, LS33UK/RP, LS33F, LV33F, C55A, LS33/60, WT4BWS, WT4DWS1, WT4BDWS, WT303, WT303/4.5, WT303UK/RP, WT303F, WT303/60, EUC1WS/2, EUC1DPWS/2, EUC3WS/2, EUC3DPWS/2, EUC3DDWS/2, ZUC1WS, ZUC1DPWS, ZUC3WS, EUC1WS, EUC1DPWS, EUC3WS, EUC3DPWS, ZUC3DPWS, ZUC3DDWS, VUCA3WSG, LS5/1WS, LS5/1WSDP, LS5/3WS, LS5/3WSDP, LS5/3WSDPD...(Other models you can see in the webshop) | | |



accessories



| | | | |
|--------------------|--|-----------------|--------|
| GEV No. | 520053 | Ref. No. | 0C4096 |
| description | screen connection 3/4" D1 ø 26mm D2 ø 15mm Qty 10 pcs rubber thickness 8mm | | |

fittings, hose and pipe connectors

hose connectors

without screw connection



| | | | |
|--------------------|--|-----------------|------------------|
| GEV No. | 501210 | Ref. No. | 047431 OKW990 |
| description | Y-piece plastic hose ø 10-10-10mm | | |
| For models: | FDV40G, FDV40E, FDV40GZ, FDV40EL, FDV40GA, FDV20G, FDV20E, FDV20GZ, FDV20EL, FDV20GA, RPI/E240, RPI/E260, RPI/G260P, RPI/E260P, RCP/E2S, XPI/E240, XPI/E260, XPI/G260P, XPI/E260P, JPI/E240, JPI/E260, MCP/E1SH, MCP/E1SUH, MCP/E2SUHS, MPI/E240, MPI/E260, MPI/G260P, MPI/E260P, MCP/E2S, MCP/E2SH, MCP/E2SUH, MCP/E2SUT, MCP/E2SHB, PPD/G260, PPI/G260P, PPI/E260P, OPD/G260, OPI/G260P, OPI/E260P, TPD/G260, TPI/G260P, TPI/E260P, KPI/G10, KPI/G15, KPI/E10, KPI/E15, KPD/G10, KPD/G15, KPD/G15A, KPI/G15A...(Other models you can see in the webshop) | | |

hose connectors

brass



| | | | |
|--------------------|--|-----------------|--------|
| GEV No. | 520866 | Ref. No. | 007117 |
| description | hose connector brass straight thread 3/4" hose ø 30mm Qty 1 pcs | | |
| For models: | FDV40G, FDV40GZ, FDV40GA, FDV20G, FDV20GZ, FDV20GA, FCZ061EAA, FCZ101EAA, FCZ102EAA, FCZ201EAA, FCZ202EAA, FCZ061EAH, FCZ101EAH, FCZ201EAH, FCZ061EAN, FCZ101EAN, FCZ201EAN, FCZ061ETA, FCZ101ETA, FCZ102ETA, FCZ201ETA, FCZ202ETA, FCZ061ETH, FCZ101ETH, FCZ201ETH, FCZ061ETN, FCZ101ETN, FCZ201ETN, FCZ201GAG, FCZ201GAD, FCZ201GTG, FCZ201GTD, FCZ061EBA, FCZ101EBA, FCZ102EBA, FCZ201EBA, FCZ202EBA, FCZ061EBH, FCZ101EBH, FCZ201EBH, FCZ061EBN, FCZ101EBN, FCZ201EBN, FCZ061EBC, FCZ101EBC, FCZ201EBC, FCZ061EBA2, FCZ101EBA2, FCZ102EBA2, FCZ201EBA2...(Other models you can see in the webshop) | | |

nickel-plated brass



| | | | |
|--------------------|---|-----------------|--------|
| GEV No. | 520201 | Ref. No. | 0C1626 |
| description | hose connector nickel-plated brass straight thread 1/4" hose ø 12mm Qty 1 pcs | | |
| For models: | ECP/E1ELHU, PCP/E2SHP, PCP/E1SH, PCP/E2SH, PCP/E2SH3B, PCP/E1ELH, OCP/E2S, OCP/E1SH, OCP/E2SH, TCP/E1ELHU, TCP/E2S, TCP/E2SH, TCP/E1ELH, KCP/G1RU, KCP/G2RU, KCP/E1RU, KCP/E2RU, KCP/G1, KCP/G1R, KCP/G2, KCP/G2R, KCP/E1, KCP/E1R, KCP/E2, KCP/E2R, KCP/G1U, KCP/G2U, KCP/E1U, KCP/E2U, QCP/G1, QCP/G1R, QCP/G2, QCP/G2R, QCP/E1, QCP/E1R, QCP/E2, QCP/E2R, WCP/G1, WCP/G1R, WCP/G2, WCP/G2R, WCP/E1, WCP/E1R, WCP/E2, WCP/E2R, DCP/G400, FCZ061EAA, FCZ101EAA, FCZ102EAA, FCZ201EAA...(Other models you can see in the webshop) | | |

stainless steel



| | | | |
|--------------------|--|-----------------|--------|
| GEV No. | 542346 | Ref. No. | 0C4198 |
| description | hose connector thread 1/4" with O-ring hose ø 5mm stainless steel Qty 1 pcs | | |
| For models: | FCZ061EAA, FCZ101EAA, FCZ102EAA, FCZ201EAA, FCZ202EAA, FCZ061EAH, FCZ101EAH, FCZ201EAH, FCZ061EAN, FCZ101EAN, FCZ201EAN, FCZ061ETA, FCZ101ETA, FCZ102ETA, FCZ201ETA, FCZ202ETA, FCZ061ETH, FCZ101ETH, FCZ201ETH, FCZ061ETN, FCZ101ETN, FCZ201ETN, FCZ061GAG, FCZ101GAG, FCZ102GAG, FCZ201GAG, FCZ202GAG, FCZ061GAD, FCZ101GAD, FCZ102GAD, FCZ201GAD, FCZ202GAD, FCZ101GTG, FCZ102GTG, FCZ201GTG, FCZ202GTG, FCZ101GTD, FCZ102GTD, FCZ201GTD, FCZ202GTD, FCZ061EBA, FCZ101EBA, FCZ102EBA, FCZ061EBH, FCZ101EBH, FCZ061EBN, FCZ101EBN, FCZ061EBC, FCZ101EBC, FCZ201EBC...(Other models you can see in the webshop) | | |

push-in fittings

JOHN GUEST



| | | | |
|--------------------|---|-----------------|--------|
| GEV No. | 440033 | Ref. No. | 0C1124 |
| description | push-in fitting John Guest T-piece pipe connection ø15mm - ø15mm - ø15mm | | |
| For models: | FCZ061EAA, FCZ101EAA, FCZ102EAA, FCZ201EAA, FCZ202EAA, FCZ061EAH, FCZ101EAH, FCZ201EAH, FCZ061EAN, FCZ101EAN, FCZ201EAN, FCZ061GAG, FCZ101GAG, FCZ102GAG, FCZ201GAG, FCZ202GAG, FCZ061GAD, FCZ101GAD, FCZ102GAD, FCZ201GAD, FCZ202GAD, FCZ061EBC, FCZ101EBC, FCZ201EBC, FCZ061GBI, FCZ101GBI, FCZ201GBI, FCZ061ECA, FCZ101ECA, FCZ102ECA, FCZ201ECA, FCZ202ECA, FCZ061ECH, FCZ101ECH, FCZ201ECH, FCZ061ECN, FCZ101ECN, FCZ201ECN, FCZ061GCG, FCZ101GCG, FCZ102GCG, FCZ201GCG, FCZ202GCG, FCZ061GCD, FCZ101GCD, FCZ102GCD, FCZ201GCD, FCZ202GCD, FCS061EXLN, FCS061EX... (Other models you can see in the webshop) | | |

4 water and beverage technology



1

| | | | |
|--------------------|--|-----------------|--------|
| GEV No. | 440032 | Ref. No. | OC1123 |
| description | push-in fitting John Guest T-piece pipe connection ø22mm - ø15mm - ø22mm | | |
| For models: | FCZ201EAA, FCZ202EAA, FCZ201EAH, FCZ201EAN, FCZ201GAG, FCZ202GAG, FCZ201GAD, FCZ202GAD, FCZ201EBC, FCZ201GBI, FCZ201ECA, FCZ202ECA, FCZ201ECH, FCZ201ECN, FCZ201GCG, FCZ202GCG, FCZ201GCD, FCZ202GCD, AOS201GAEU, AOS202GAEU, AOS201GAAU, AOS202GAAU, AOS201EABU, AOS201EAFU, AOS201EA, AOS201EA3J, AOS201EA2N, AOS202EA2N, AOS201EA0H, AOS202EA, AOS201GA, AOS202GA, AOS201EAAQ, AOS202EAAQ, AOS201EANQ, AOS202EANQ, AOS201EACQ, AOS201EAHQ, AOS-201GAGQ, AOS202GAGQ, AOS201GADQ, AOS202GADQ, AOS-201GAIQ, AOS201GALQ, AOS201EAMQ, AOS201EABQ, AOS201GAPQ, AOS202GAPQ, AOS201EAA1, AOS202EAA1...(Other models you can see in the webshop) | | |



1

| | | | |
|--------------------|---|-----------------|--------|
| GEV No. | 440030 | Ref. No. | OC1149 |
| description | push-in fitting John Guest straight thread 1/2" BSP stub ø 15 | | |
| For models: | FCZ061EAA, FCZ101EAA, FCZ102EAA, FCZ061EAH, FCZ101EAH, FCZ061EAN, FCZ101EAN, FCZ061GAG, FCZ101GAG, FCZ102GAG, FCZ061GAD, FCZ101GAD, FCZ102GAD, FCZ061EBC, FCZ101EBC, FCZ061GBI, FCZ101GBI, FCZ061ECA, FCZ101ECA, FCZ102ECA, FCZ061ECH, FCZ101ECH, FCZ061ECN, FCZ101ECN, FCZ061GCG, FCZ101GCG, FCZ102GCG, FCZ061GCD, FCZ101GCD, FCZ102GCD, FCS061EXLN, FCS061EX, FCS101EX4J, FCS101EXLN, FCS101EX, FCS102EX4J, FCS102EX, FCS201EX, FCS201EXLN, FCS202EX, FCS-101GX9J, FCS101GX, FCS102GX9J, FCS102GX, FCS201GX, FCS202GX, AOS061GAEU, AOS101GAEU, AOS102GAEU, AOS061GAAU...(Other models you can see in the webshop) | | |



1

| | | | |
|--------------------|--|-----------------|--------|
| GEV No. | 440029 | Ref. No. | OC1122 |
| description | push-in fitting John Guest straight thread 3/4" BSP stub ø 22 | | |
| For models: | FCZ201EAA, FCZ202EAA, FCZ201EAH, FCZ201EAN, FCZ201GAG, FCZ202GAG, FCZ201GAD, FCZ202GAD, FCZ201EBC, FCZ201GBI, FCZ201ECA, FCZ202ECA, FCZ201ECH, FCZ201ECN, FCZ201GCG, FCZ202GCG, FCZ201GCD, FCZ202GCD, AOS201GAEU, AOS202GAEU, AOS201GAAU, AOS202GAAU, AOS201EABU, AOS201EAFU, AOS201EA, AOS201EA3J, AOS201EA2N, AOS202EA2N, AOS201EA0H, AOS202EA, AOS201GA, AOS202GA, AOS201EAAQ, AOS202EAAQ, AOS201EANQ, AOS202EANQ, AOS201EACQ, AOS201EAHQ, AOS-201GAGQ, AOS202GAGQ, AOS201GADQ, AOS202GADQ, AOS-201GAIQ, AOS201GALQ, AOS201EAMQ, AOS201EABQ, AOS201GAPQ, AOS202GAPQ, AOS201EAA1, AOS202EAA1...(Other models you can see in the webshop) | | |

valves and tank inlets

ball valves

universal

mini ball valves



1

| | | | |
|------------------------|---|-----------------|------------------|
| GEV No. | 520296 | Ref. No. | 0H6056 0H6384 |
| description | ball valve connection 1/2" IT - 1/2" IT DN10 total length 47mm chrome-plated brass | | |
| For models: | 5614-3-10, 5614-3-6, 5614-3-8 | | |
| accessories for | 520296 | | |
| |  | GEV No. | 515040 |
| | | Ref. No. | — |
| | drain fitting size 1/2" usable heightmm overall height 16mm ED ø 28mm chrome-plated brass | | |

ball valves with butterfly handle



1

| | | | |
|--------------------|---|-----------------|----------------------------|
| GEV No. | 540658 | Ref. No. | 053108 0K7222 700610 |
| description | ball valve connection 3/4" IT - 3/4" IT DN20 total length 69mm | | |
| For models: | MFR/G350, MFR/G700, MFR/G350D, MFR/G700D, MFR/G350F, MFR/G700F, MFR/G350E, MFR/G700E, MFR/E355, MFR/E355UK, MFR/E355D, MFR/E705, MFR/E705UK, MFR/E705D, RFR/E1S12, RFR/E2D12, XFR/E1S12, XFR/E2D12, JFR/E1S12, JFR/E2D12, MFR/E1S12, MFR/E2D12, RFR/G350, RFR/G700, RFR/G350D, RFR/G700D, RFR/G350F, RFR/G700F, M35GFR, M70GFR, XFR/G350D, XFR/G700D, XFR/G350F, XFR/G700F, XFR/G351, CFR/G351, CFR/G700, RFR/G301, RFR/G300, RFR/G301, RFR/G701, RFR/G701F, HFR/G420, HFR/G420, HFR/G840, HFR/G840, HFR/G840, HFR/E420, HFR/E420UK, HFR/E840...(Other models you can see in the webshop) | | |



ball valves with lever handle



1

| | | | |
|--------------------|---|-----------------|---|
| GEV No. | 520280 | Ref. No. | 010369 0901/2 098215 0H6385 0KF802 0T3680 231203ERSATZ231 231205 430033 |
| description | ball valve connection 1/2" IT - 1/2" IT DN15 total length 50mm with lever handle handle length 85mm | | |
| For models: | RPNV740, RPNV760, RPN/V740, RPN/V760, 5611-3-10, 5611-3-6, 5611-3-8, 5612-3-10, 5612-3-6, 5612-3-8, 5614-3-10, 5614-3-6, 5614-3-8 | | |

ball valves electric



1

| | | | |
|--------------------|---|-----------------|------------------|
| GEV No. | 401140 | Ref. No. | 005026 0K1518 |
| description | ball valve inlet 1" IT outlet 1" IT with plug 230V L 152mm 50/60Hz closed off-current mode of operation electric connection cable 200mm size DN25 | | |
| For models: | FCVG202L3, FCV/G20L6, FCV/E20L6, FCVG202L6, FCVE202L6, FCV/G201/1, FVC/E201/1, FVC/E202/1, 5712-2-7, 5712-2-8, 5712-2-10, 5714-2-7, 5714-2-8, 5714-2-10, 5717-2-6, 5714-2-7, 5714-2-8, 5714-2-10, 5712-2-7L, 5712-2-8L, 5712-2-10L, 5714-2-7L, 5714-2-8L, 5714-2-10L, 5714-2-6L, 5714-2-7L, 5714-2-8L, 5714-2-10L, 5711-3-7, 5711-3-8, 5711-3-10, 5711-3-8CH, 5711-3-10CH, 5712-3-7, 5712-3-8, 5712-3-8E, 5712-3-10, 5712-3-8CH, 5712-3-10C, 5714-3-7, 5714-3-8, 5714-3-8E, 5714-3-10, 5717-3-6, 5717-3-7, 5717-3-8, 5717-3-8E, 5717-3-10, 5717-3-8M, 5717-3-8C...(Other models you can see in the webshop) | | |



1

| | | | |
|--------------------|--|-----------------|------------------|
| GEV No. | 400293 | Ref. No. | 059004 0L0949 |
| description | ball valve inlet 3/4" IT outlet 3/4" IT electric 24V 50/60Hz cable length 250mm | | |
| For models: | FCVE10-P, FCVE10PUK, FCVG10-P, FCVG10PUK, FCVE20-P, FCVE20PUK, FCVG20-P, FCVG20PUK, WTM140ERA, WTM140ELA, WTM140ERB, WTM140ELB, WTM165ERA, WTM165ELA, WTM165ERB, WTM165ELB, WTM200ERA, WTM200ELA, WTM200ERB, WTM200ELB, WTM250ERA, WTM250ELA, WTM250ERB, WTM250ELB, WTM300ERA, WTM300ELA, WTM300ERB, WTM300ELB, WTM180ERA, WTM180ELA, WTM180ERB, WTM180ELB, WTM140SRA, WTM140SLA, WTM165SRA, WTM165SLA, WTM180SRA, WTM180SLA, WTM200SRA, WTM200SLA, WTM250SRA, WTM250SLA, WTM300SRA, WTM300SLA, RTM140ERA, RTM140ELA, RTM140ERB, RTM140ELB, RTM165ERA, RTM165ELA...(Other models you can see in the webshop) | | |



1

| | | | |
|--------------------|--|-----------------|---|
| GEV No. | 401139 | Ref. No. | 002713 0C0882 0F0171 0K1526 0K8453 0K9349 2255318 696804201 867016 8670160 |
| description | ball valve inlet 3/4" IT outlet 3/4" IT with plug 230V L 65mm 50/60Hz closed off-current mode of operation electric connection cable 200mm | | |
| For models: | FCZ061EAA, FCZ101EAA, FCZ102EAA, FCZ201EAA, FCZ202EAA, FCZ061EAH, FCZ101EAH, FCZ201EAH, FCZ061EAN, FCZ101EAN, FCZ201EAN, FCZ061ETA, FCZ101ETA, FCZ102ETA, FCZ201ETA, FCZ202ETA, FCZ061ETH, FCZ101ETH, FCZ201ETH, FCZ061ETN, FCZ101ETN, FCZ201ETN, FCZ061GAG, FCZ101GAG, FCZ102GAG, FCZ201GAG, FCZ202GAG, FCZ061GAD, FCZ101GAD, FCZ102GAD, FCZ201GAD, FCZ202GAD, FCZ101GTG, FCZ102GTG, FCZ201GTG, FCZ202GTG, FCZ101GTD, FCZ102GTD, FCZ201GTD, FCZ202GTD, FCZ061EBA, FCZ101EBA, FCZ102EBA, FCZ201EBA, FCZ202EBA, FCZ061EBH, FCZ101EBH, FCZ201EBH, FCZ061EBN, FCZ101EBN...(Other models you can see in the webshop) | | |



shut-off valves

universal



1

| | | | |
|---|---|-----------------|----------------------------------|
| GEV No. | 540935 | Ref. No. | 056616 110120 |
| description | shut-off valve connection tube ø 10mm total length 110mm shaft 7x7mm | | |
| For models: | HCP/G800, HCP/G400, HCP/E800, HCP/E400 | | |
| accessories for | 540935 | | |
|  | GEV No. | 110287 | Ref. No. 025260 054254 |
| | knob water t.max.°C temperature range°C ø 50mm shaft ø 7x7mm shaft flat black | | |

producer-specific

ZANUSSI



1

| | | | |
|--------------------|---|-----------------|----------------------------|
| GEV No. | 110288 | Ref. No. | 025255 025256 054367 |
| description | cover cap knob white | | |
| For models: | MFR/G350, MFR/G351, RCV/G2, RCV/G3, RCV/E2, RCV/E3, RRV/G1FL, RRV/G1FR, RRV/G2FL, RRV/G2FM, RRV/E1FL, RRV/E1FR, RRV/E2FL, RRV/E2FM, RG/G1, RG/G2, RGV/G1, RGV/G2, RGV/E1, RGV/E2, RTV/G2, RSV/G2, RIV/E2, RBV/G2, RBV/E2, XCV/G2, XCV/G3, XCV/E2, XCV/E3, XRV/G1FL, XRV/G1FR, XRV/G2FL, XRV/G2FM, XRV/E1FL, XRV/E1FR, XRV/E1CL, XRV/E2FL, XRV/E2FM, XRV/E2CL, XGV/G1, XGV/G2, XGV/E1, XGV/E2, XTV/G2, XSV/G2, XIV/E2, XBV/G2, XBV/E2, JCV/G2, JCV/G3... (Other models you can see in the webshop) | | |

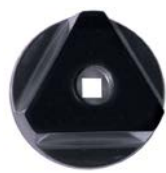

1

| | | | |
|---|---|-----------------|--|
| GEV No. | 110287 | Ref. No. | 025260 054254 |
| description | knob water t.max.°C temperature range°C ø 50mm shaft ø 7x7mm shaft flat black | | |
| For models: | HCP/G800, HCP/G400, HMS/E800, HMS/E400, HM/G800T, HM/E800T, HQN/G1917, HQN/G1917, HQN/G1225, HQN/G1225, HQN/EI917, HQN/GI122, HQN/V917, HPN/G810, HQN/EI1225, HPN/GI810, HPN/GI810, HPN/G815, HPA/G815, HPN/E810, HPN/GI815, HPA/GI815, HPN/EI810, HPA/GI815, HPN/E815, HPN/EI810, HPA/EI810, HPN/GI810, HBR/G803, HBR/G804, HBR/G803, HBR/G804, HBR/G803, HBR/G805, HBR/G803, HBR/G804, HBR/G1004, HBR/E801, HBR/E803, HBR/E804, HBR/E805UK, HBR/E1003, HBR/G803, HBR/G804, HBR/G1013, HBR/E1013, HCP/E800, HCP/E400 | | |
| accessories for | 110287 | | |
|  | GEV No. | 110288 | Ref. No. 025255 025256 054367 |
| | cover cap knob white | | |

water softeners

automatic softeners

with Autotrol control Logix 255/740 (timer)



1

| | | | |
|---|---|-----------------|------------------------|
| GEV No. | 530843 | Ref. No. | 050716 051079 |
| description | softener automatic type GIX8 container capacity 8l amount of resin 5.6l salt amount/regeneration 1kg capacity at 16°dH/20°e/29°fH 1120l W 250mm L 480mm H 540mm connection 3/4" operation pressure 2-8bar water temperature 6-25°C flow rate 1500l/h with control Autotrol 255/740 (timer) supply 230VAC with timer | | |
| spare parts for | 530843 | | |
|  | GEV No. | 402775 | Ref. No. — |
| | PCB with timer type 740 LOGIX suitable for GIX8 | | |
|  | GEV No. | 520136 | Ref. No. 050333 |
| | ion-exchange resin type Dowex HCR-S/S 25l 20.5kg | | |
|  | GEV No. | 520306 | Ref. No. — |
| | overflow stock type CABLT/MINI/MAXI | | |
|  | GEV No. | 520309 | Ref. No. — |
| | container SS connection 2½" 8l | | |
|  | GEV No. | 520318 | Ref. No. — |
| | gasket set suitable for CABLT/MINI/MAXI | | |
|  | GEV No. | 520322 | Ref. No. — |
| | O-ring | | |
|  | GEV No. | 520521 | Ref. No. — |
| | control head complete for softener suitable for GIX 5/8/12 | | |
|  | GEV No. | 520522 | Ref. No. — |
| | cover for control head suitable for GIX 5/8/12 | | |
|  | GEV No. | 520523 | Ref. No. — |
| | camshaft for softener suitable for GIX 5/8/12 | | |
|  | GEV No. | 520524 | Ref. No. — |
| | spring for cam shaft suitable for GIX 5/8/12 | | |
|  | GEV No. | 520525 | Ref. No. — |
| | sensor optic for softener suitable for GIX 5/8/12 | | |

Table continues overleaf



| spare parts for | | 530843 | | |
|-----------------|--------------------|--|----------|---|
| GEV No. | | 520526 | Ref. No. | — |
| | connection cable | for sensor suitable for GIX 5/8/12 | | |
| | GEV No. | 520527 | Ref. No. | — |
| | O-ring | EPDM thickness 5.34mm ID ø 24.77mm Qty 1 pcs | | |
| | GEV No. | 520528 | Ref. No. | — |
| | valve set | for softener suitable for GIX 5/8/12 | | |
| | GEV No. | 520529 | Ref. No. | — |
| | lid | for softener suitable for GIX 5/8 + ISI 5/8 | | |
| | GEV No. | 520530 | Ref. No. | — |
| | O-ring | EPDM thickness 3.53mm ID ø 36.1mm Qty 1 pcs | | |
| | GEV No. | 530037 | Ref. No. | — |
| | O-ring set | suitable for CABLT/MINI/MAXI | | |
| | GEV No. | 530041 | Ref. No. | — |
| | power supply unit | 6W primary 230V 50Hz secondary 12VACV 0.5A suitable for Autotrol 255/440 255/460 | | |
| | GEV No. | 530216 | Ref. No. | — |
| | gear motor | 4W 11V 50/60Hz for softener suitable for GIX 5/8/12 0.8/1rpm | | |
| | GEV No. | 530238 | Ref. No. | — |
| | regenerant salt | type BROXETTEN content 25kg format tablets | | |
| | GEV No. | 530240 | Ref. No. | — |
| | ion-exchange resin | PURE type PC002 25l 20.5kg | | |
| | GEV No. | 530273 | Ref. No. | — |
| | ion-exchange resin | type Dowex HCR-S/S 6l 5kg | | |
| | GEV No. | 530274 | Ref. No. | — |
| | ion-exchange resin | type Dowex HCR-S/S 9l 7.5kg | | |
| | GEV No. | 530275 | Ref. No. | — |
| | container | L 435mm W 240mm H 320mm for GIX8 | | |
| | GEV No. | 530312 | Ref. No. | — |
| | filter | type CABLT/MINI/MAXI | | |
| | GEV No. | 530316 | Ref. No. | — |
| | ball | type CABLT/MINI/MAXI | | |
| | GEV No. | 530402 | Ref. No. | — |
| | bracket | holding fork type CABLT/MINI/MAXI | | |
| | GEV No. | 530831 | Ref. No. | — |
| | cover | salt tank suitable for GIX 8/ISI 8 | | |
| accessories for | | 530843 | | |
| | GEV No. | 510836 | Ref. No. | — |
| | supply filter | thread 3/4" ET - 3/4" IT total length 76mm plastic | | |
| | GEV No. | 515143 | Ref. No. | — |
| | hose nipple | suitable for high temperature pipe DN50 for hose ID 8/10/13/19/25mm straight polypropylene | | |

| accessories for | | 530843 | | |
|-----------------|----------------------|---|----------|------------------|
| GEV No. | | 515144 | Ref. No. | — |
| | hose nipple | suitable for high temperature pipe DN40 for hose ID 8/10/13/19/25mm straight polypropylene | | |
| | GEV No. | 520007 | Ref. No. | 048621 049540 |
| | flex hose | SS braid straight-curved DN15 connection 1: 3/4" connection 2: 3/4" L 2500mm approval operating p. 10bar test pressure 32bar burst p. 95bar | | |
| | GEV No. | 520169 | Ref. No. | — |
| | double nipple | brass thread 3/4" - 3/4" Qty 1 pcs | | |
| | GEV No. | 530238 | Ref. No. | — |
| | regenerant salt | type BROXETTEN content 25kg format tablets | | |
| | GEV No. | 530628 | Ref. No. | — |
| | water shock arrestor | connection 3/4" - 3/4" operating p. up to 10bar water hammer max. 50bar t.max. 90°C damping range 3-50bar brass | | |
| | GEV No. | 530844 | Ref. No. | — |
| | Chlorine generator | for softener for Autotrol 255/740 255/760 | | |
| | GEV No. | 540039 | Ref. No. | — |
| | pipe aerator | inlet 3/4" outlet 3/4" approval DVGW | | |

water filters

BRITA

water filters

PURITY C Quell ST

carbonate hardness reduction specifically for coffee and vending machines

| 1 | | | | |
|-----------------|---|---|----------|---|
| GEV No. | 530835 | Ref. No. | 0S1056 | |
| description | water filter BRITA type PURITY C500 Quell ST capacity 4125-6800l flow rate 100l/h operation p max 8.6bar water temperature +4 up to +30°C filter power 10µm decarbonisation | | | |
| accessories for | 530835 | | | |
| | GEV No. | 520540 | Ref. No. | — |
| | flex hose | connections 3/8" L 1500mm SS braid straight-straight with ball valve DN8 | | |
| | GEV No. | 520541 | Ref. No. | — |
| | flex hose | SS braid straight-curved DN8 connection 1: 3/4" straight connection 2: 3/8" curved L 1500mm approval DVGW operating p. 10bar test pressure 32bar burst p. 95bar | | |

Table continues overleaf



| accessories for | | 530835 | |
|---|---------|--------|------------|
| | GEV No. | 520542 | Ref. No. — |
| reducer IT 3/8" ET 3/4" plastic total length 30mm WS 22 with gasket Qty 1 pcs | | | |
| | GEV No. | 530055 | Ref. No. — |
| flow meter with digital display connection 3/8" IT - 3/8" ET total length 81mm flow rate 10-100l/h operation p max 8bar water temperature 4-30°C ambient temperature max. 0-60°C cable length 1500mm display 6 digits | | | |
| | GEV No. | 530836 | Ref. No. — |
| filter head BRITA connection 3/8" type PURITY C blend 30% water temperature +4 up to +30°C decarbonisation for coffee machine/combi-steamer | | | |
| | GEV No. | 530837 | Ref. No. — |
| filter head connection 3/8" type PURITY C blend 0-70% decarbonisation for coffee machine/combi-steamer | | | |
| | GEV No. | 530838 | Ref. No. — |
| filter head connection John Guest 8mm type PURITY C blend 0-70% universal with wall holder | | | |
| | GEV No. | 530840 | Ref. No. — |
| wall holder suitable for PURITY C Qty 1 pcs | | | |
| | GEV No. | 530841 | Ref. No. — |
| cover suitable for PURITY C Qty 1 pcs | | | |
| | GEV No. | 543007 | Ref. No. — |
| backflow preventer plastic thread 3/8" IT - 3/8" ET total length 46mm Qty 1 pcs | | | |
| | GEV No. | 800031 | Ref. No. — |
| measuring device carbonate hardness | | | |

PURITY Clean

partial desalination for dishwashers

| | | | |
|---|--|-----------------|------------------|
| | | | |
| 1 | | | |
| GEV No. | 530379 | Ref. No. | 0S0682 0S0801 |
| description | water filter BRITA type Purity 1200 Clean capacity 12000l flow rate 600l/h operation p max 6bar water temperature +4 up to +60°C ø 288mm H 550mm partial desalination for dishwashers flow rate 5l/min | | |
| spare parts for | 530379 | | |
| | GEV No. | 530378 | Ref. No. — |
| filter cartridge BRITA type Purity 1200 Clean capacity 12000l flow rate 600l/h operation p max 6bar water temperature +4 up to +60°C ø 550mm H 288mm partial desalination for dishwashers | | | |
| accessories for | 530379 | | |
| | GEV No. | 520584 | Ref. No. — |
| flex hose SS straight-curved DN12 connection 1: 3/4" connection 2: 3/4" L 2000mm approval DVGW operating p. 10bar test pressure 32bar burst p. 95bar | | | |

water cycle components

pressure reduction valves

pressure reduction valves

universal



| | | | |
|--------------------|--|-----------------|--------|
| GEV No. | 520967 | Ref. No. | 002678 |
| description | pressure reduction valve series HP WR01 connection 1/2" default setting 3bar setting range 1-6bar p max 16bar t.max. 40°C chrome-plated brass IMPORT | | |

supply filters



| | | | |
|--------------------|---|-----------------|--|
| 1 | | | |
| GEV No. | 520261 | Ref. No. | 000119-10 053037 054450 067392 46202 |
| description | supply filter thread 1/2" IT - 1/2" IT total length 58mm red brass mesh opening 0.4mm | | |
| For models: | FCV/G6L3TOWNGAS, FCV/G6L3, FCV/E101/1, FCVE6L3J, FCV/G6L3JAP, FCVG6L3CJ, FCV/E61/1, FCV/G10L2, FCV/E10L2, FCV/E61/1, FCV/G6L3C, FCV/G61/1, FCVG6L3CT, FCVG6L3CJ, FCV/E6L3, FCV/E101/1, FCS061E44J, FCS061G48J, FCS061G3DI, FCS061E3CI, FCS101E2, FCS061G4DT, FCS061G49J, FCS101G2, FVGC4, FV4G, FV4E, FCVG10-1SG, FCVMG62, ECV/G6T4C, ECV/E10IGP, CR15G, CR15V, CR15E, CR/41G, CR42G, CR/41E, CR/41V, CR/42V, CR40G, CR40V, CR/40E, CR/42E, FV4G, FV4E, FVAC041, LS365F, LS365, LS365PH, LS365D...(Other models you can see in the webshop) | | |



| | | | |
|---|---|-----------------|--------|
|  | | | |
| 1 | | | |
| GEV No. | 520262 | Ref. No. | 068121 |
| description | supply filter thread 3/4" IT - 3/4" IT total length 70mm red brass DN20 mesh opening 0.4mm | | |
| For models: | CLB160V, LS500F, LS501F, LS540F, LS540DK, LS541F, LS720F, LSE720DK, LSE720PH, LS860F, LS860DK, LS860PH, LS1080F, LS1080UK, LS1080PH, LSE721F, LS861F, LS540, LS1080M, LS1080, LS1080D, LS1080UK, LS1080/63, LS500F, LS500UK, LS501, LS501UK, LS540D, LS540/63, LSE721, LS720, LSE720UK, LS721UK, LSE720D, LS541, LS860, LS860, LS860D, LS860UK, LS861UK, LS860/63, LS861, WT38/M50, WT38M50/4, EUCAIDPJ, EUCAIDPJ60, WT37J60, WT37J50, LS6AH240U, WT30H208U...(Other models you can see in the webshop) | | |

| | | | |
|--|--|-----------------|---|
|  | | | |
| 1 | | | |
| GEV No. | 520112 | Ref. No. | 007019 046797 048126 057545 065121 0G2046 0K2123 0KX145 158CS |
| description | hose clamp ø 12-20mm width 9mm Qty 10 pcs DIN 3017 | | |
| For models: | ACPG25, PPD/G260, PPI/G260P, PPI/E260P, OPD/G260, OPI/G260P, OPI/E260P, TPD/G260, TPI/G260P, TPI/E260P, EPPWELG, KPI/E10, KPI/E15, KPD/G10, KPD/G15, KPD/G15A, KPI/E15A, KPI/G06, KPI/E06, KPI/G15H, KPI/E15H, KPI/G10H, KPI/E10H, KBR/G2F, KBR/G2C, KBR/G3F, KBR/G3FH, KBR/G3C, KBR/G3CH, KBR/E2F, KBR/E2C, KBR/E3F, KBR/E3FH, KBR/E3C, KBR/E3CH, KBR/G2FH, KBR/G2CH, KBR/E2FH, KBR/E2CH, KCP/G1RU, KCP/G2RU, KCP/E1RU, KCP/E2RU, KCP/G1, KCP/G1R, KCP/G2, KCP/G2R, KCP/E1, KCP/E1R, KCP/E2...(Other models you can see in the webshop) | | |

non-return valves

| | | | |
|--|--|-----------------|--------|
|  | | | |
| 1 | | | |
| GEV No. | 543034 | Ref. No. | 0C2312 |
| description | non-return valve plastic total length 22mm Qty 1 pcs ø 19.5mm | | |
| For models: | FCZ061EAA, FCZ101EAA, FCZ102EAA, FCZ201EAA, FCZ202EAA, FCZ061EAH, FCZ101EAH, FCZ201EAH, FCZ061EAN, FCZ101EAN, FCZ201EAN, FCZ061ETA, FCZ101ETA, FCZ102ETA, FCZ201ETA, FCZ202ETA, FCZ061ETH, FCZ101ETH, FCZ201ETH, FCZ061ETN, FCZ101ETN, FCZ201ETN, FCZ061GAG, FCZ101GAG, FCZ102GAG, FCZ201GAG, FCZ202GAG, FCZ061GAD, FCZ101GAD, FCZ102GAD, FCZ201GAD, FCZ202GAD, FCZ101GTG, FCZ102GTG, FCZ201GTG, FCZ202GTG, FCZ101GTD, FCZ102GTD, FCZ201GTD, FCZ202GTD, FCZ061EBA, FCZ101EBA, FCZ102EBA, FCZ201EBA, FCZ202EBA, FCZ061EBH, FCZ101EBH, FCZ201EBH, FCZ061EBN, FCZ101EBN...(Other models you can see in the webshop) | | |

| | | | |
|--|---|-----------------|------------------|
|  | | | |
| 1 | | | |
| GEV No. | 520114 | Ref. No. | 0E1166 0KB299 |
| description | hose clamp ø 20-32mm width 9mm Qty 10 pcs DIN 3017 | | |
| For models: | W3400H06, W355HE, W365H, W375H5, W3105H, W3130H, W3130H, W3240H., W3240H, W3400H, W3400H, W355HQSR, W3130H, W3180H, W3180H, W3180H, W3240H_EL, W3240H_CLA, W3180H, W3130H, W3180H, W3105H, W3105H, W3105H, W355H, W375H, W3105H, W3130H, W3180H, W3300H, W3300H, W355H, W455H04, W455HQSR, WE66MP, WE66MP, WE106MP, LC12EC, CLC12EC, CLC22, LACE22M, CLC22V, LACV22M/V, CLC22VC, LB81E, LB81BP, LB81COP, W375N, W375N...(Other models you can see in the webshop) | | |

ancillary products

clamps

hose clamps

DIN 3017 - W2

| | | | |
|---|---|-----------------|--------|
|  | | | |
| 1 | | | |
| GEV No. | 520111 | Ref. No. | 0L0266 |
| description | hose clamp ø 10-16mm width 9mm Qty 10 pcs DIN 3017 | | |
| For models: | WT4WS1, WT4BWS, WT4DWS1, WT4BDWS, EUC1WS/2, EUC1DPWS/2, EUC3WS/2, EUC3DPWS/2, EUC3DDWS/2, ZUC1WS, ZUC1DPWS, ZUC3WS, EUC1WS, EUC1DPWS, EUC3WS, EUC3DPWS, ZUC3DPWS, ZUC3DDWS, VUCA3WSG, LS5/1WS, LS5/1WSDP, LS5/3WS, LS5/3WSDP, LS5/3WSDPD, NUC1WS, NUC1DPWS, NUC3WS, NUC3DPWS, NUC3DDWS, LV5/3WSDP, FL5/3WSDP, UCSWSDP | | |

| | | | |
|--|--|-----------------|--------------------------------------|
|  | | | |
| 1 | | | |
| GEV No. | 520115 | Ref. No. | 047578 049446 0K0198 0L0367 |
| description | hose clamp ø 25-40mm width 9mm Qty 10 pcs DIN 3017 | | |
| For models: | EPPWELG, EBS50., EBS50H, EBS100., EBS100H, EBS150., EBS150H, EBS200., EBS200H, EBS300., EBS300H, EBV50., EBV50H, EBV100., EBV100H, EBV150, EBV150H, EBV200., EBV200H, EBV300., EBV300H, EBVC50, EBVC50H, EBVC100, EBVC100H, EBVC150, EBVC150H, EBVC200, EBVC200H, EBVC300, EBVC300H, EBP100., EBP100M, EBP150, EBP150M, EBP200., EBP200M, EBP300., EBP300M, EBPC100, EBPC100M, EBPC150, EBPC150M, EBPC200, EBPC200M, EBPC300, EBPC300M, MED50H, MED100H, MED150H...(Other models you can see in the webshop) | | |



| | | | |
|---|--|-----------------|--|
|  | | | |
| 1 | | | |
| GEV No. | 520116 | Ref. No. | 046566 046878 060407 066056 0E2686 0K8981 |
| description | hose clamp ø 32-50mm width 9mm Qty 5 pcs DIN 3017 | | |
| For models: | LS32, LS32/4.5, LS32UK/RP, LS32F, LV32F, C55, LV32/60, WT4, WT4B, WT4D, WT302, WT302/4.5, WT302UK/RP, WT302F, WT302/60, WT4DB, WT46, WT4DG, WT4WS1, LS33, LS33/4.5, LS33UK/RP, LS33F, LV33F, C55A, LS33/60, WT4BWS, WT4DWS1, WT4BDWS, WT303, WT303/4.5, WT303UK/RP, WT303F, WT303/60, EUC1/2, EUC1DP/2, EUC1WS/2, EUC1DPWS/2, EUC3/2, NUC3DD, WT4D60, WT4DDG, EUC3WS/2, EUC3DP/2, EUC3DD/2, EUC3DPWS/2, EUC3DDWS/2, ZUC1, ZUC1DP, ZUC1WS...(Other models you can see in the webshop) | | |

| | | | |
|--|---|-----------------|---|
|  | | | |
| 1 | | | |
| GEV No. | 520110 | Ref. No. | 046946 048224 0539812 0H2566 0KB296 211003001008 |
| description | hose clamp ø 8-12mm width 9mm Qty 10 pcs DIN 3017 | | |
| For models: | EPPWELG, LS32, LS32/4.5, LS32UK/RP, LS32F, LV32F, C55, LV32/60, WT4, WT4B, WT4D, WT302, WT302/4.5, WT302UK/RP, WT302F, WT302/60, WT4DB, WT46, WT4DG, LS33, LS33/4.5, LS33UK/RP, LS33F, LV33F, C55A, LS33/60, WT4DWS1, WT4BDWS, WT303, WT303/4.5, WT303UK/RP, WT303F, WT303/60, EUC1/2, EUC1DP/2, EUC1DPWS/2, EUC3/2, NUC3DD, WT4D60, WT4DDG, EUC3DP/2, EUC3DD/2, EUC3DPWS/2, EUC3DDWS/2, ZUC1, ZUC1DP, ZUC1DPWS, ZUC3, EUC1, EUC1DP...(Other models you can see in the webshop) | | |

| | | | |
|---|--|-----------------|--|
|  | | | |
| 1 | | | |
| GEV No. | 520118 | Ref. No. | 046855 065537 072582 0E1358 0K8983 |
| description | hose clamp ø 50-70mm width 9mm Qty 5 pcs DIN 3017 | | |
| For models: | LS32, LS32/4.5, LS32UK/RP, LS32F, LV32F, C55, LV32/60, WT4, WT4B, WT4D, WT302, WT302/4.5, WT302UK/RP, WT302F, WT302/60, WT4DB, WT46, WT4DG, WT4WS1, LS33, LS33/4.5, LS33UK/RP, LS33F, LV33F, C55A, LS33/60, WT4BWS, WT4DWS1, WT4BDWS, WT303, WT303/4.5, WT303UK/RP, WT303F, WT303/60, NUC3DD, WT4D60, WT4DDG, EUC1, EUC1DP, EUC1WS, EUC1DPWS, EUC3, EUC3WS, EUC3DP, EUC3DPWS, EUC1G, EUC1DP60, EUC3DD, ZUCADDROW, ZUCADDROW6...(Other models you can see in the webshop) | | |

| | | | |
|--|---|-----------------|--------|
|  | | | |
| 1 | | | |
| GEV No. | 520117 | Ref. No. | 0L0193 |
| description | hose clamp stainless steel ø 40-60mm width 9mm Qty 5 pcs DIN 3017 | | |
| For models: | EPPWELG, EUC1/2, EUC1DP/2, EUC1WS/2, EUC1DPWS/2, EUC3/2, EUC3WS/2, EUC3DP/2, EUC3DD/2, EUC3DPWS/2, EUC3DDWS/2, ZUC1, ZUC1DP, ZUC1WS, ZUC1DPWS, ZUC3, ZUC3WS, EUCADD60, ZUC3DP, ZUC3DD, ZUC3DPWS, ZUC3DDWS, EUC1G/2, EUCA1DDG, EUC1DP602, ZUC1DP60, EUC1GMS, ZUC1G, ZUCA1DDG, ZUC1GMS, VUC1, VUC3, VUC3G, VUCA3WSG, VUCA3G, VUC1G, EUC3DDMCD, NUC1DPP, EUC1DDM60, NUC1DUK, NUC1DDUK, NUC1DDRUKP, NUC1GRUK, NUC3DPP, NUC1D, NUC1DD, EUCA1DP, NUC1GMS, EUC3DPCAG, NUC1DPDD...(Other models you can see in the webshop) | | |

| | | | |
|---|---|-----------------|--------------------------------------|
|  | | | |
| 1 | | | |
| GEV No. | 520119 | Ref. No. | 046478 046853 065047 0E0992 |
| description | hose clamp ø 60-80mm width 9mm Qty 5 pcs DIN 3017 | | |
| For models: | EPPWELG, LB8G, LB8G/63, LB8GF, LB8GPH, LB8G, LB8GPHm, LB80EPH, LB80E, LB120EPH, LB120E, LB160EPH, LB160E, LB160V, CLB160E, CLB160V, LB70E, LB110E, SPE144/23, SPE144/23U, SPE144/23, LS500F, LS501F, LS540F, LS540DK, LS541F, LS720F, LSE720DK, LSE720PH, LS860F, LS860DK, LS860PH, LS1080F, LS1080UK, LS1080PH, LSE721F, LS861F, LS540, LS1080M, LS1080, LS1080D, LS1080UK, LS1080/63, LS500F, LS500UK, LS501, LS501UK, LS540D, LS540/63, LSE721...(Other models you can see in the webshop) | | |



| | | | |
|--|--|-----------------|------------------|
| DIN 3017 - W4 | | | |
|  | | | |
| 1 | | | |
| GEV No. | 520120 | Ref. No. | 049888 0U1043 |
| description | hose clamp SS W4 ø 12-20mm width 9mm Qty 1 pcs DIN 3017 | | |
| For models: | LB035C, LB035R, LB035Q, LB040R, LB040Q, LB040AUS, EUCB, EUCBDPDD, NUCB, NUCBDPDD, WT60/GJ60, WT60/GJ50, PH10/12-RP, LS14EA, ET12E, LS14EA1, LS14EA1/AU, LS14EA/60, LS14EAA-SIA, LS14EA/G, LS10EA, LS14EA1/DD, WT65E, WT65EB, WT65EI, ECOTEMP12S, WT65EBI, WT65EBIA, WT65EIA, WT65E60, WT65EB60, WT65EBIDG, WT65EBASIA, WT65EIM50, WT65EIM60, LS14EADP/G, WT65MED, WT65EJ50, WT65EJ60, LS14AH240U, WT65H208U, WT65H240U, LS14H208DU, LS14AH208U, LS14H240DU, LS14H240RU, WT65H208DU, WT65H240DU, WT65H208RU...(Other models you can see in the webshop) | | |



| | | | |
|---|--|-----------------|--------|
|  | | | |
| 1 | | | |
| GEV No. | 520121 | Ref. No. | 0G2823 |
| description | hose clamp SS W4 ø 16-27mm width 9mm Qty 1 pcs DIN 3017 | | |
| For models: | CE128-106, CE158-133.3.HV, CE158-244.3, CE158-246.3, CK248-209, D1ABBB, CK248-211.D1ABBB, HCE128-100, HCE128-104, HCE158-252W.3, HCE158-253.3, HLE129-100, HLE129-103, HLE129-104W, HLE159-252W.3.6, HLE159-328.3.HV, HLE159-351W.3.HV, HLE249-200.3, HLE249-208.3, HLE259-088.3.HV, HLE259-089.3.HV, HLE259-384W.3, LE129-101, LE159-261.3, LE159-281.3.6, LE159-318.3.HV, LE159-322.3.HV, LE159-330.3.HV, LE159-337.3.HV, LE159-344.3.MS92, LE159-347.3.HV, LE249-199.3, LE249-203.3, LE249-207.3, LE249-211.3, LE249-215.3, LE249-219.3, LE249-223.3, LE249-232.3, LE249-238.3, LE259-081.3.HV, LE259-082.3.HV, LE259-083.3.HV, LE259-094.3.HV, LE259-099.3.HV, LE259-382.3, LK259-707.D1ACCB, LK259-708.D1ACCB, CK248-205.D1ABBB, CK248-207.D1ABBB, LK159-707.D1BC...(Other models you can see in the webshop) | | |

tools

cleaning tools

| | | | |
|---|---|-----------------|--------|
|  | | | |
| 1 | | | |
| GEV No. | 890049 | Ref. No. | 0S1606 |
| description | scraper for ceramic hobs | | |
| spare parts for | 890049 | | |
| | GEV No. | Ref. No. | — |
| | | | |
| |  | | |
| | spare blades for scraper Qty 10 pcs | | |

measuring equipment

meters

leak detectors

for natural and liquid gas

| | | | |
|---|--|-----------------|--------|
|  | | | |
| 1 | | | |
| GEV No. | 802153 | Ref. No. | 0S2023 |
| description | leak detector natural/liquid gas signal optic/acoustic incl. bag and battery display LED type SE151NM dimensions 90x160x30mm sensor external 275 + 1500mm cabledmm | | |

thermometers

built-in thermometers

ø52mm

| | | | |
|--|--|-----------------|--------|
|  | | | |
| 1 | | | |
| GEV No. | 541347 | Ref. No. | 052987 |
| description | thermometer mounting ø 52mm t.max. 350°C +50 up to +350°C probe ø 4mm probe L 60mm capillary pipe 1000mm | | |

| | | | |
|--|---|-----------------|--------|
|  | | | |
| 1 | | | |
| GEV No. | 541582 | Ref. No. | 056383 |
| description | thermometer mounting ø 52mm t.max. 350°C +50 up to +350°C probe ø 6mm probe L 17mm capillary pipe 1700mm | | |
| For models: | FCFG101/0, FCFG102-0, FCFG201-0, FCFG202-0, FCFE101-0, FCFE102-0, FCFE201-0, FCFE202-0, FCF101ELN, FCFG10160H, FCF201ENS, FCFG102-0T, FCF/G101/1-1-JAP, FCF/G102/1-1-JAP, FCFE101-1J, FCFE102-1J, FCF/G101/1, FCFE6J50, FCFE6J60, FCFG10J, FCFG10J, FCFE10J, FCFE10J, FCFG20J, FCFG20J, FCFE20J, FCFE20J, FCFG40J, FCFG40J, FCFE40J, FCFE40J, FCFG6J, FCFG6J, FCFG6J, FCFG6J, FCFG6J, FCFG10J, FCFG10J, FCFG20J, FCFG20J, FCFG41J, FCFG40J, ECFG101-0, ECFG102-0, ECFG201-0, ECFG202-0, ECFE101-0, ECFE102-0, ECFE201-0, ECFE202-0, ECF201ENS...(Other models you can see in the webshop) | | |

| | | | |
|--|--|-----------------|--------|
|  | | | |
| 1 | | | |
| GEV No. | 541090 | Ref. No. | 053808 |
| description | thermometer mounting ø 52mm t.max. 350°C 0 up to +350°C probe ø 6.5mm probe L 22mm capillary pipe 1450mm | | |
| For models: | FC1G, FC2G, RF/G1680, RF/G2480, FCFG6D, FCFE6D, FCFE6D, FCFG10, FCFG10D, FCFG10NL, FCFE10, FCFE10UK, FCFG20, FCFG20D, FCFG20F, PFCFG20, FCFE20, FCFE20UK, FCFG40, FCFG41, FCFG40D, FCFG40F, PFCFG40F, FCFE40, FCFE40D, FCFE40UK, PFCFE40F, FCFG6, FCFG6F, PFCFG6, FCFE6, FCFE6UK, PFCFE6, FCVE10, FCVE20, FCVE6-1U, FCVE6-3U, FCVE6-1, FCVE6-3, FCVE6-1UK, FCVE6-3UK, FCVG6-1, FCVG6-3, FCVG6-1UK, FCVG6-3UK, FCVE10-2, FCVE10-4, FCVE10-2UK, FCVE10-4UK, FCVG10-2...(Other models you can see in the webshop) | | |

ø60mm



| | | | |
|--------------------|---|-----------------|------------------|
| GEV No. | 379593 | Ref. No. | 057622 058081 |
| description | thermometer mounting ø 60mm t.max. 300°C 50-300°C probe ø 4mm probe L 135mm capillary pipe 1050mm | | |
| For models: | M70EIKE, XPN/EI760UK | | |



| | | | |
|--------------------|--|-----------------|--------|
| GEV No. | 541054 | Ref. No. | 004162 |
| description | thermometer mounting ø 60mm t.max. 500°C 0 up to +500°C probe ø 10mm probe L 80mm capillary pipe 700mm | | |
| For models: | ZCMME6, ZCBME12, ZCMME4, ZCBME8, ZCMME9, ZCBME18 | | |

various



| | | | |
|--------------------|---|-----------------|------------------|
| GEV No. | 381358 | Ref. No. | OKU570 OKZQ05 |
| description | thermostat t.max. 120°C temperature range 0-120°C 1-pole 1CO probe ø 8.5mm probe L 32mm capillary pipe 1600mm mounting ø 60mm | | |
| For models: | HCCS20W, HCCS20W, A-O-H/S, A-O-H/W, A-O-H/PT, A-O-H/M50, A-O-H/M60, HC-CS, HC-CS | | |

fastening material

screws

countersunk screws



| | | | |
|--------------------|---|-----------------|--------|
| GEV No. | 501370 | Ref. No. | OK8911 |
| description | countersunk screw thread M6 L 50mm SS DIN 963/ISO 2009 Qty 1 pcs intake slotted head ø 11mm | | |
| For models: | CS7ME4/200-3, CS7ME4/230-3, CS7ME4/400-3N, CS7ME6/400-3N, CS7ME4/400-3N/EO, CS7ME4/400-3/50HZ/MA, CS7ME4/440-3/60HZ/MA, CS7MT4/400-3N, CS7GE4/200-3, CS7GE4/230-3, CS7GE4/400-3N, CS7GE6/400-3N, CS7GE4/400-3N/EO, CS7GE4/400-3/50HZ/MA, CS7GE4/440-3/60HZ/MA, CS7GT4/400-3N, CS7LCE4/200-3, CS7LCE4/230-3, CS7LCE4/400-3N, CS7LCE6/400-3N, CS7LCE4/400-3N/EO, CS7LCE4/400-3/50HZ/M, CS7LCE4/440-3/60HZ/M, CS7LCT4/400-3N, CS10ME4/200-3, CS10ME4/230-3, CS10ME6/230-3, CS10ME4/400-3N, CS10ME6/400-3N, CS10ME4/400-3N/EO, CS10ME4/400-3/50HZ/M, CS10ME4/440-3/60HZ/M, CS10MT4/400-3N, CS10MT6/400-3N, CS10GE4/200-3, CS10GE4/230-3, CS10GE6/230-3, CS10GE4/400-3N, CS10GE6/400-3N, CS10GE4/400-3N/EO, CS10GE4/400-3/50HZ/M, CS10GE4/440-3/60HZ/M, CS10GT4/400-3N, CS10GT6/400-3N, CS10LCE4/200-3, CS10LCE4/230-3, CS10LCE6/230-3, CS10LCE4/400-3N, CS10LCE6/400-3N, CS10LCE4/400-3N/EO...(Other models you can see in the webshop) | | |

oval head screws



| | | | |
|--------------------|---|-----------------|--------|
| GEV No. | 560057 | Ref. No. | OC3539 |
| description | oval head screw thread M5 L 13mm stainless steel intake Phillips Qty 10 pcs | | |
| For models: | EHT8TIEL, EHT8TIELG4, EHT8TIELG8, EHT8IELG, EHT8IEWSG, EHT8IELGJ, EHT8IELGJ6, ZHT8IELG, NHT8IELG, NHT8IEWSG, EHT8IELG6, EHT8TIELG, ECRT66R208, ECRT66L208, ECRT66R240, ECRT66L240, ECRT44R208, ECRT44L208, ECRT44R240, ECRT44L240 | | |

grub screws

DIN 913/ISO 4026





| | | | |
|--------------------|--|-----------------|------------------|
| GEV No. | 504733 | Ref. No. | 047846 0H2563 |
| description | grub screw thread M4 L 5mm stainless steel DIN 913 intake internal hexagon WS 2 Qty 1 pcs | | |
| For models: | LS860F, LS860DK, LS860PH, LS1080F, LS1080UK, LS1080PH, LS861F, LS1080M, LS1080, LS1080D, LS1080UK, LS1080/63, LS860, LS860, LS860D, LS860UK, LS861UK, LS860/63, LS861, LS510, LS520, LS520D, LS520F, LS520M, LS520K, LS521, LS521D, LS521F, LS521M, LS521K, LS521, LS4, LS61, LS61/60, LS62, LS62D, LS62/UKRP, LS62F, LV62, LS62/60, ECOTEMP5, LS62/1P, LS62HD, LS65, LS62/UK, LS63, LS63D, LS63/UKRP, LS63F, LV63...(Other models you can see in the webshop) | | |





| DIN 916/ISO 4029 | | | |
|---|---|-----------------|--------|
|  | | | |
| 1 | | | |
| GEV No. | 504734 | Ref. No. | 046258 |
| description | grub screw thread M4 L 6mm black DIN 916 intake internal hexagon WS 2 Qty 1 pcs | | |
| For models: | RTV/G720, RTV/G720, RTFG720, RTF/G720F, RTF/G1020, RTF/G1030, RTF/G1020F, KPI/G15H, KPI/G10H, QPI/G15H, QPI/G10H, WPI/G15H, WPI/G10H, FCV/E101/1, FCV/E10L6JAP, FCV/E102/1L6JAP, FCV/G10L6JAP, FCV/G102/1L6JAP, FCV/E61/1, FCV/E101/1, FCV/E102/1, FCV/E61/1, FCV/E101/1, FCV/G61/1, FCV/G10L6, FCV/E10L6, FCV/G102/1L6, FCV/E102/1L6, FCV/G20L6, FCV/E20L6, FCVG202L6, FCVE202L6, FCS061GP, FCS101EP4J, FCS101EP, FCS101GP9J, FCS102EP4J, FCS101GP, FCS102EP, FCS102GA9J, FCS201EP, FCS102GP, FCS202EP, FCS201GP, FCS202GP, FCS061E4, FCS101EX4J, FCS101EXLN, FCS101EX, FCS102EX4J...(Other models you can see in the webshop) | | |

| miscellaneous | | | |
|---|--|-----------------|----------------------------|
|  | | | |
| 1 | | | |
| GEV No. | 700442 | Ref. No. | 025033 052220 0G6450 |
| description | thread bolt thread M6 L 32mm thread L 13mm head ø 8mm for rail | | |
| For models: | MCF/G705, MCF/G1055, MCF/G700, MCF/G1050, MCF/G705E, MCF/G1055E, MCF/G700D, MCF/G700, MCF/G705F, MCF/G1055F, MCF/G705NL, MCF/GE705, MCF/GE1055, MCF/GE700, MCFGE1050, MCF/GE700D, MCFGE1050D, MCF/G1050D, MCFG1055NL, MCF/E700D, MCF/E700, MCF/E700UK, MCF/E1050D, MCF/E1050, MCF/GE1055UK, MI/E350, MI/E700, MIF/E700, MI/E350D, MI/E700D, MIF/E700D, MI/E360, MI/E710, MIF/E710, MI/E360D, MI/E710D, MIF/E710D, MCF/G995, MCF/G702, MCF/GE702, MCF/G1052, MCFGE1052, MCF/G700, MCF/GE700, MCF/G1050, MCFGE1050, MR/E350D, MR/E350UK, MR/E360, MR/E700D...(Other models you can see in the webshop) | | |

| nuts | | | |
|---|---|-----------------|--------|
| cap nuts | | | |
|  | | | |
| 1 | | | |
| GEV No. | 560137 | Ref. No. | 0K1297 |
| description | cap nuts thread M6 WS 10 SS Qty 20 pcs DIN/ISO DIN 1587 | | |

| knurled nuts | | | |
|---|---|-----------------|--------|
|  | | | |
| 1 | | | |
| GEV No. | 697970 | Ref. No. | 056150 |
| description | knurled nut thread M6 ø 20mm H 7.7mm SS | | |
| For models: | FCV/G6L3TOWNGAS, FCV/G6L3, FCVE6L3J, FCV/G6L3JAP, FCVG6L3CJ, FCV/E61/1, FCV/E61/1, FCV/E61/1, FCV/E61/1, FCV/G6L3C, FCV/G61/1, FCV/G61/1, FCV/G61/1, FCV/G61/1, FCV/G61/1, FCV/G6L3CT, FCVG6L3CJ, FCV/E6L3, FCV/G6L4, FCV/E6L4, FCF6EHOR, FCS061E44J, FCS061G48J, FCS061GP, FCS061EP, FCS061G3DI, FCS061E3CI, FCS061G4, FCS061G4DT, FCS061G49J, FCS061E4, FCS061EXLN, FCS061EX, FCFE6J50, FCFE6J60, FCFG6J, FCFG6J, FCFG6J, FCFG6J, FCVE6-1U, FCVE6-3U, FCVE6-1, FCVE6-3, FCVE6-3CE, FCVE6-1UK, FCVE6-3UK, FCVG6-1, FCVG6-3, FCVG6-1UK, FCVG6-3UK, 5711-2-6...(Other models you can see in the webshop) | | |

| hexagonal nuts | | | |
|---|---|-----------------|--------|
| DIN 934 / ISO 4032/8673 | | | |
|  | | | |
| 1 | | | |
| GEV No. | 560223 | Ref. No. | 0U0182 |
| description | hexagonal nut thread M3 H 2.4mm WS 5.5 SS DIN/ISO DIN 934 / ISO 4032/8673 Qty 1 pcs | | |
| For models: | AIARHFFOOB, AIARHAFOOB, AIARHBF00B, AIAWHFF00B, AIAWHAF00B, AIAWHBF00B, ADGRAAOOOO, ADGRHAOOO, ADGRAFOOOO, ADGRHF0000, ADGUAOOOO, ADGUHAOOO, ADGUAFOOOO, ADGUHF0000, AKGROAOOOO, AKGROFOOOO, ADGROI0000, ADGUOIOOOO, AIAROI00B, AIAWOIFF0B, AIAWAAKK0B, AIAWABK0B, AIAWAFK0B, AIAROI00B, AIARA00B, AIARABK0B, AIARAFK0B, AIAWOIK0B, AIARA00B, AIARABQ0B, AIARAFQ0B, AIAROIQ0B, AIAWAAQ0B, AIAWABQ0B, AIAWAFQ0B, AIAWOIQ0B, SLE159-170, SLE159-180, AIARAFF00B, AIARA00B, AIARABFO0B, AIAWAFF00B, AIAWAFF00B, AIAWABFF0B | | |

| | | | |
|---|---|-----------------|--------|
|  | | | |
| 1 | | | |
| GEV No. | 511212 | Ref. No. | 0K4516 |
| description | hexagonal nut thread M6 H 5mm WS 10 SS DIN/ISO DIN 934 / ISO 4032/8673 Qty 1 pcs | | |
| For models: | HLE159-241W.3.6, FSAKOE00RO, HWAKOE00RO, GSACOE00O, BEN300E.S35.H97, LK259-728.D1ACCB, BOT150G.MS25.F17, GU3E-OEWOOZ, LG259-711.0.SS/SS, GWKJOMOOO, LG159-753.A1BC, LG159-703.0.FF, BEN200EW87, ISKJOMOOO, LE159-231.3, HCE158-131W.3.HV, LE159-316.3.HV, ISKJOMOOO, HCE158-122W.3.HV, LE159-343.3.MS92, GWFHOEXORO, GWKCOEOORO, GSKCOEOOOO, LG159-706.0.ZN, GSKCOMOOO, HLE259-089.3.HV, LE159-307.3.HV, IWFKOMXORO, HLE249-228.3, IWAJOMOOO, LE249-207.3, GSKCOEOORO, GWFCEXOOO, HSKCOEOORO, CE158-252.3, LG159-704.0.ZS, IWFJOMXORO, CG248-240.0.NN/ZZ, CE158-142.3.MS82, LE259-954.3.MS92, ALAWCBSOOC, HWALOE00RO, GWKKOMOOO, HCE158-231W.3, GPWCOEOOBO, AGGWHBGBOO, GPXCOEOOBO, AGGYOIGFCO, GWACOMOOO, KUYJOEWOOO...(Other models you can see in the webshop) | | |

| | | | |
|---|---|-----------------|--------------------------|
|  | | | |
| 1 | | | |
| GEV No. | 560133 | Ref. No. | OD0503 OU0336 3653 |
| description | hexagonal nut thread M6 H 5mm WS 10 SS DIN/ISO DIN 934 / ISO 4032/8673 Qty 20 pcs | | |
| For models: | K35, CUTE0523, CUTE0538, VARIO-G, K35, KT055, KT056, MC40AS-01, K35-11, K55-01, TR260-01, TR260-02, TR260-03, TR260-04, K55E-01, EL65, XBE10AS-01, BM20AS-01, MC40AS-02, K35-01, K55-02, XBE10AS-02, K35-02, PL15-01, XBE10AS-03, BM20AS-02, K35-03, XBE10S-1, K55E-05, PL15-02, PL15-03, XBE10S-02, XBE10AS-04, BM20AS-03, BM20AS-04, BM30AS-01, BM30AS-02, MC40AS-03, BMX60AS-01, K55-03, XBE10S-03, XBE10S-04, BM20AS-05, BM30AS-03, BMX60AS-02, BM20AS-06, BMX60AS-03, K35-04, K55-04, K35-05...(Other models you can see in the webshop) | | |

| | | | |
|---|--|-----------------|--------|
| DIN 985 | | | |
|  | | | |
| 1 | | | |
| GEV No. | 560142 | Ref. No. | 049372 |
| description | hexagonal nut thread M6 H 6mm SS WS 10 Qty 20 pcs DIN/ISO DIN 985 self-locking | | |
| For models: | LS32, LS32/4.5, LS32UK/RP, LS32F, LV32F, C55, LV32/60, WT4, WT4B, WT4D, WT302, WT302/4.5, WT302UK/RP, WT302F, WT302/60, WT4DB, WT46, WT4DG, WT4WS1, LS33, LS33/4.5, LS33UK/RP, LS33F, LV33F, C55A, LS33/60, WT4BWS, WT4DWS1, WT4BDWS, WT303, WT303/4.5, WT303UK/RP, WT303F, WT303/60, EUC1/2, EUC1DP/2, EUC1WS/2, EUC1DPWS/2, EUC3/2, NUC3DD, WT4D60, WT4DDG, EUC3WS/2, EUC3DP/2, EUC3DD/2, EUC3DPWS/2, EUC3DDWS/2, ZUC1, ZUC1DP, ZUC1WS...(Other models you can see in the webshop) | | |

| | | | |
|---|--|-----------------|------------------|
| hexagonal nuts metric (without norm) | | | |
|  | | | |
| 1 | | | |
| GEV No. | 550261 | Ref. No. | 006245 OK9627 |
| description | nut thread M14x1 H 4mm WS 19 SS Qty 1 pcs | | |
| For models: | FCV/G6L3TOWNGAS, FCV/G6L3, FCV/E101/1, FCV/G20L3, FCVG20L3, FCV/E10L6JAP, FCV/E102/1L6JAP, FCV/G6L3JAP, FCV/G10L6JAP, FCV/G102/1L6JAP, FCV/E61/1, FCV/E61/1, FCV/E101/1, FCV/E101/1, FCV/E102/1, FCV/E61/1, FCV/E61/1, FCV/E101/1, FCV/G61/1, FCV/G61/1, FCV/G61/1, FCV/E102/1, FCV/G6L4, FCV/E101/1, FCV/G10L6, FCV/E10L6, FCV/G102/1L6, FCV/E102/1L6, FCV/G101/1, FVC/E101/1, FCV/G102/1, FVC/E102/1, FCV/G201/1, FVC/E201/1, FCV/G202/1, FVC/E202/1, FCF/G6-0, FCFG101/0, FCFG102-0, FCFG201-0, FCFG202-0, FCF/E6-0, FCFE101-0, FCFE102-0, FCF061ELN, FCF101ELN, FCF6EHOR, FCFG10160H, FCF061ENS, FCF101ENS...(Other models you can see in the webshop) | | |

| | | | |
|---|---|-----------------|------------------|
|  | | | |
| 1 | | | |
| GEV No. | 101345 | Ref. No. | 020997 OF0146 |
| description | nut thread M15x1 H 3mm WS 19 brass Qty 1 pcs | | |
| For models: | MCF/G705, MCF/G1055, MCF/G700, MCF/G1050, MCF/G705E, MCF/G1055E, MCF/G700D, MCF/G700, MCF/G705F, MCF/G1055F, MCF/G705NL, MCF/G1050D, MCF/G1055NL, MCF/G1095, MCF/G995, MCF/G702, MCF/G1052, MCF/G700, MCF/G1050, MR/G351, MR/G701, MR/G721, MR/G1071, MR/G350, MR/G350F, MR/G350NL, MR/G350E, MR/G360, MR/G360F, MR/G700, MR/G700F, MR/G700NL, MR/G700E, MR/G710, MR/G710F, MR/G1070, MR/G720, MR/G715, MR/G725, MR/G1075, MR/G361, MR/G711, MR/G716, MR/G726, MR/G1076, MFR/G350, MFR/G700, MFR/G350D, MFR/G700D, MFR/G360...(Other models you can see in the webshop) | | |

| | | | |
|---|---|-----------------|------------------|
|  | | | |
| 1 | | | |
| GEV No. | 693430 | Ref. No. | 051263 OF0147 |
| description | nut thread M22x1.5 H 5mm WS 26 zinc-coated steel Qty 1 pcs | | |
| For models: | FCZ061EAA, FCZ101EAA, FCZ102EAA, FCZ201EAA, FCZ202EAA, FCZ061EAAH, FCZ101EAAH, FCZ201EAAH, FCZ061EAN, FCZ101EAN, FCZ201EAN, FCZ061ETA, FCZ101ETA, FCZ102ETA, FCZ201ETA, FCZ202ETA, FCZ061ETH, FCZ101ETH, FCZ201ETH, FCZ061ETN, FCZ101ETN, FCZ201ETN, FCZ061GAG, FCZ101GAG, FCZ102GAG, FCZ201GAG, FCZ202GAG, FCZ061GAD, FCZ101GAD, FCZ102GAD, FCZ201GAD, FCZ202GAD, FCZ101GTG, FCZ102GTG, FCZ201GTG, FCZ202GTG, FCZ101GTD, FCZ102GTD, FCZ201GTD, FCZ202GTD, FCZ061EBA, FCZ101EBA, FCZ102EBA, FCZ201EBA, FCZ202EBA, FCZ061EBH, FCZ101EBH, FCZ201EBH, FCZ061EBN, FCZ101EBN...(Other models you can see in the webshop) | | |

| | | | |
|---|--|-----------------|-------------------|
|  | | | |
| 1 | | | |
| GEV No. | 102067 | Ref. No. | 055033 0992014 |
| description | nut thread M8x1 H 3mm brass Qty 1 pcs type SEF 1 | | |
| For models: | MBR/E710D, MBR/E700, MBR/E700UK, MBR/G701, MBR/G706, MBR/G701UK, MBR/G751, MBR/G756, MBR/E716, MBR/E706, 7BRE60XN, 7BRE60X, RBR/E700UK, 7BRG60, 7BRG60X, RBR/G701UK, RBR/G751, RBR/G756, RBR/E716, RBR/E706, XBR/E710D, M70EBP, XBR/E710, XBR/G701, M70GBP, XBR/G701UK, XBR/G751, XBR/G756, CBR/G700, CBR/E700, XBR/E716, XBR/E706, HR/G420D, HR/G820D, HR/G420, HR/G820, HR/G821, HBR/G800, HBR/G805, HBR/G801, HBR/G806, HBR/G810, HBR/G815, HBR/G811, HBR/G816, HBR/G800D, HBR/G805D, HBR/G801D, HBR/G806D, HBR/G810D...(Other models you can see in the webshop) | | |

| | | | |
|---|--|-----------------|--------|
|  | | | |
| 1 | | | |
| GEV No. | 506160 | Ref. No. | OKM405 |
| description | plain washer ID ø 8.6mm ED ø 16mm thickness 1.5mm SS Qty 1 pcs | | |
| For models: | AG25, AG30, AG35, AG37, AV25, AV30, AV35, AV37, AG30, Europa350, Europa350, EUROPA370, MAX300, MAX350, MAX300, LUX350, LUX370, MEAT350, MAX300, MXMATIC300, AG25, AG30, EUROPA350, AV30, AV35, AV37, ECO300, MEET350, MEET370, MEET300 | | |

| | | | |
|---|---|-----------------|----------------------------|
|  | | | |
| 1 | | | |
| GEV No. | 690844 | Ref. No. | 055475 056416 OK2973 |
| description | plain washer plastic | | |
| For models: | FCVE6-1U, FCVE6-3U, FCVE6-1, FCVE6-3, FCVE6-3CE, FCVE6-1UK, FCVE6-3UK, FCVG6-1, FCVG6-3, FCVG6-1UK, FCVG6-3UK, FCVE10-2, FCVE10-4, FCVE103CE, FCVE10-2UK, FCVE10-4UK, FCVG10-2, FCVG10-4, FCVG10-1SG, FCVG10-2, FCVG10-4D, FCVG10-2UK, FCVG10-4UK, FCVG10-2, FCVG10-4, FCVE20-2, FCVE20-4, FCVE203CE, FCVE20/P-V, FCVE20-2UK, FCVE20-4UK, FCVG20-2, FCVG20-4, FCVG20-2, FCVG20-4D, FCVG20-2UK, FCVG20-4UK, FCVG20-4, FCVG20-4D, FCVE20-V, FCVE20VUK, FCVE10-P, FCVE10PUK, FCVG10-P, FCVG10PUK, FCVE20-P, FCVE20PUK, FCVG20-P, FCVG20PUK, FCV/E6-1...(Other models you can see in the webshop) | | |

tooth lock washers

DIN 6798A

| | | | |
|---|--|-----------------|------------------|
|  | | | |
| 1 | | | |
| GEV No. | 560229 | Ref. No. | OQ0008 OTH044 |
| description | tooth lock washer ID ø 5.2mm ED ø 10mm SS DIN/ISO DIN 6798A Qty 1 pcs for thread M5 | | |
| For models: | ECRT66R208, ECRT66L208, ECRT66R240, ECRT66L240, ECRT44R208, ECRT44L208, ECRT44R240, ECRT44L240, LWC44AR208, LWC44AL208, LWC66AR208, LWC66AL208, LWC44AR240, LWC44AL240, LWC66AR240, LWC66AL240 | | |

fasteners

clamps

hose clamps

DIN 3017 - W2

| | | | |
|---|---|-----------------|--------|
|  | | | |
| 1 | | | |
| GEV No. | 520111 | Ref. No. | 0L0266 |
| description | hose clamp ø 10-16mm width 9mm Qty 10 pcs DIN 3017 | | |
| For models: | WT4WS1, WT4BWS, WT4DWS1, WT4BDWS, EUC1WS/2, EUC1DPWS/2, EUC3WS/2, EUC3DPWS/2, EUC3DDWS/2, ZUC1WS, ZUC1DPWS, ZUC3WS, EUC1WS, EUC1DPWS, EUC3WS, EUC3DPWS, ZUC3DPWS, ZUC3DDWS, VUCA3WSG, LS5/1WS, LS5/1WSDP, LS5/3WS, LS5/3WSDP, LS5/3WSDPD, NUC1WS, NUC1DPWS, NUC3WS, NUC3DPWS, NUC3DDWS, LV5/3WSDP, FL5/3WSDP, UC5WSDP | | |

| | | | |
|--|--|-----------------|---|
|  | | | |
| 1 | | | |
| GEV No. | 520112 | Ref. No. | 007019 046797 048126 057545 065121 0G2046 0K2123 0KX145 158CS |
| description | hose clamp ø 12-20mm width 9mm Qty 10 pcs DIN 3017 | | |
| For models: | ACPG25, PPD/G260, PPI/G260P, PPI/E260P, OPD/G260, OPI/G260P, OPI/E260P, TPD/G260, TPI/G260P, TPI/E260P, EPPWELG, KPI/E10, KPI/E15, KPD/G10, KPD/G15, KPD/G15A, KPI/E15A, KPI/G06, KPI/E06, KPI/G15H, KPI/E15H, KPI/G10H, KPI/E10H, KBR/G2F, KBR/G2C, KBR/G3F, KBR/G3FH, KBR/G3C, KBR/G3CH, KBR/E2F, KBR/E2C, KBR/E3F, KBR/E3FH, KBR/E3C, KBR/E3CH, KBR/G2FH, KBR/G2CH, KBR/E2FH, KBR/E2CH, KCP/G1RU, KCP/G2RU, KCP/E1RU, KCP/E2RU, KCP/G1, KCP/G1R, KCP/G2, KCP/G2R, KCP/E1, KCP/E1R, KCP/E2...(Other models you can see in the webshop) | | |

| | | | |
|--|---|-----------------|------------------|
|  | | | |
| 1 | | | |
| GEV No. | 520114 | Ref. No. | 0E1166 0KB299 |
| description | hose clamp ø 20-32mm width 9mm Qty 10 pcs DIN 3017 | | |
| For models: | W3400H06, W355HE, W365H, W375H5, W3105H, W3130H, W3130H, W3240H., W3240H, W3400H, W3400H, W355HQSR, W3130H, W3180H, W3180H, W3180H, W3180H, W3240H_EL, W3240H_CLA, W3180H, W3130H, W3180H, W3105H, W3105H, W3105H, W355H, W375H, W3105H, W3130H, W3180H, W3300H, W3300H, W355H, W455H04, W455HQSR, WE66MP, WE66MP, WE106MP, LC12EC, CLC12EC, CLC22, LACE22M, CLC22V, LACV22M/V, CLC22VC, LB81E, LB81BP, LB81COP, W375N, W375N...(Other models you can see in the webshop) | | |

| | | | |
|--|--|-----------------|--------------------------------------|
|  | | | |
| 1 | | | |
| GEV No. | 520115 | Ref. No. | 047578 049446 0K0198 0L0367 |
| description | hose clamp ø 25-40mm width 9mm Qty 10 pcs DIN 3017 | | |
| For models: | EPPWELG, EBS50., EBS50H, EBS100., EBS100H, EBS150., EBS150H, EBS200., EBS200H, EBS300., EBS300H, EBV50., EBV50H, EBV100., EBV100H, EBV150, EBV150H, EBV200., EBV200H, EBV300., EBV300H, EBVC50, EBVC50H, EBVC100, EBVC100H, EBVC150, EBVC150H, EBVC200, EBVC200H, EBVC300, EBVC300H, EBP100., EBP100M, EBP150, EBP150M, EBP200., EBP200M, EBP300., EBP300M, EBPC100, EBPC100M, EBPC150, EBPC150M, EBPC200, EBPC200M, EBPC300, EBPC300M, MED50H, MED100H, MED150H...(Other models you can see in the webshop) | | |



| | | | |
|---|--|-----------------|--|
|  | | | |
| 1 | | | |
| GEV No. | 520116 | Ref. No. | 046566 046878 060407 066056 0E2686 0K8981 |
| description | hose clamp ø 32-50mm width 9mm Qty 5 pcs DIN 3017 | | |
| For models: | LS32, LS32/4.5, LS32UK/RP, LS32F, LV32F, C55, LV32/60, WT4, WT4B, WT4D, WT302, WT302/4.5, WT302UK/RP, WT302F, WT302/60, WT4DB, WT46, WT4DG, WT4WS1, LS33, LS33/4.5, LS33UK/RP, LS33F, LV33F, C55A, LS33/60, WT4BWS, WT4DWS1, WT4BDWS, WT303, WT303/4.5, WT303UK/RP, WT303F, WT303/60, EUC1/2, EUC1DP/2, EUC1WS/2, EUC1DPWS/2, EUC3/2, NUC3DD, WT4D60, WT4DDG, EUC3WS/2, EUC3DP/2, EUC3DD/2, EUC3DPWS/2, EUC3DDWS/2, ZUC1, ZUC1DP, ZUC1WS...(Other models you can see in the webshop) | | |

| | | | |
|--|---|-----------------|---|
|  | | | |
| 1 | | | |
| GEV No. | 520110 | Ref. No. | 046946 048224 0539812 0H2566 0KB296 211003001008 |
| description | hose clamp ø 8-12mm width 9mm Qty 10 pcs DIN 3017 | | |
| For models: | EPPWELG, LS32, LS32/4.5, LS32UK/RP, LS32F, LV32F, C55, LV32/60, WT4, WT4B, WT4D, WT302, WT302/4.5, WT302UK/RP, WT302F, WT302/60, WT4DB, WT46, WT4DG, LS33, LS33/4.5, LS33UK/RP, LS33F, LV33F, C55A, LS33/60, WT4DWS1, WT4BDWS, WT303, WT303/4.5, WT303UK/RP, WT303F, WT303/60, EUC1/2, EUC1DP/2, EUC1DPWS/2, EUC3/2, NUC3DD, WT4D60, WT4DDG, EUC3DP/2, EUC3DD/2, EUC3DPWS/2, EUC3DDWS/2, ZUC1, ZUC1DP, ZUC1DPWS, ZUC3, EUC1, EUC1DP...(Other models you can see in the webshop) | | |

| | | | |
|---|--|-----------------|--|
|  | | | |
| 1 | | | |
| GEV No. | 520118 | Ref. No. | 046855 065537 072582 0E1358 0K8983 |
| description | hose clamp ø 50-70mm width 9mm Qty 5 pcs DIN 3017 | | |
| For models: | LS32, LS32/4.5, LS32UK/RP, LS32F, LV32F, C55, LV32/60, WT4, WT4B, WT4D, WT302, WT302/4.5, WT302UK/RP, WT302F, WT302/60, WT4DB, WT46, WT4DG, WT4WS1, LS33, LS33/4.5, LS33UK/RP, LS33F, LV33F, C55A, LS33/60, WT4BWS, WT4DWS1, WT4BDWS, WT303, WT303/4.5, WT303UK/RP, WT303F, WT303/60, NUC3DD, WT4D60, WT4DDG, EUC1, EUC1DP, EUC1WS, EUC1DPWS, EUC3, EUC3WS, EUC3DP, EUC3DPWS, EUC1G, EUC1DP60, EUC3DD, ZUCADDROW, ZUCADDROW6...(Other models you can see in the webshop) | | |

| | | | |
|--|--|-----------------|--------|
|  | | | |
| 1 | | | |
| GEV No. | 520117 | Ref. No. | 0L0193 |
| description | hose clamp stainless steel ø 40-60mm width 9mm Qty 5 pcs DIN 3017 | | |
| For models: | EPPWELG, EUC1/2, EUC1DP/2, EUC1WS/2, EUC1DPWS/2, EUC3/2, EUC3WS/2, EUC3DP/2, EUC3DD/2, EUC3DPWS/2, EUC3DDWS/2, ZUC1, ZUC1DP, ZUC1WS, ZUC1DPWS, ZUC3, ZUC3WS, EUCADD60, ZUC3DP, ZUC3DD, ZUC3DPWS, ZUC3DDWS, EUC1G/2, EUCA1DDG, EUC1DP602, ZUC1DP60, EUC1GMS, ZUC1G, ZUCA1DDG, ZUC1GMS, VUC1, VUC3, VUC3G, VUCA3WSG, VUCA3G, VUC1G, EUC3DDMCD, NUC1DPP, EUC1DDM60, NUC1DUK, NUC1DDUK, NUC1DDRUKP, NUCA1GRUK, NUC3DPP, NUC1D, NUC1DD, EUCA1DP, NUC1GMS, EUC3DPCAG, NUC1DPDD...(Other models you can see in the webshop) | | |

| | | | |
|---|---|-----------------|--------------------------------------|
|  | | | |
| 1 | | | |
| GEV No. | 520119 | Ref. No. | 046478 046853 065047 0E0992 |
| description | hose clamp ø 60-80mm width 9mm Qty 5 pcs DIN 3017 | | |
| For models: | EPPWELG, LB8G, LB8G/63, LB8GF, LB8GPH, LB8G, LB8GPHm, LB80EPH, LB80E, LB120EPH, LB120E, LB160EPH, LB160E, LB160V, CLB160E, CLB160V, LB70E, LB110E, SPE144/23, SPE144/23U, SPE144/23, LS500F, LS501F, LS540F, LS540DK, LS541F, LS720F, LSE720DK, LSE720PH, LS860F, LS860DK, LS860PH, LS1080F, LS1080UK, LS1080PH, LSE721F, LS861F, LS540, LS1080M, LS1080, LS1080D, LS1080UK, LS1080/63, LS500F, LS500UK, LS501, LS501UK, LS540D, LS540/63, LSE721...(Other models you can see in the webshop) | | |

| | | | |
|--|--|-----------------|------------------|
| DIN 3017 - W4 | | | |
|  | | | |
| 1 | | | |
| GEV No. | 520120 | Ref. No. | 049888 0U1043 |
| description | hose clamp SS W4 ø 12-20mm width 9mm Qty 1 pcs DIN 3017 | | |
| For models: | LB035C, LB035R, LB035Q, LB040R, LB040Q, LB040AUS, EUCB, EUCBDPDD, NUCB, NUCBDPDD, WT60/GJ60, WT60/GJ50, PH10/12-RP, LS14EA, ET12E, LS14EAI, LS14EAI/AU, LS14EA/60, LS14EAA-SIA, LS14EA/G, LS10EA, LS14EAI/DD, WT65E, WT65EB, WT65EI, ECOTEMP12S, WT65EBI, WT65EBIA, WT65EIA, WT65E60, WT65EB60, WT65EBIDG, WT65EBASIA, WT65EIM50, WT65EIM60, LS14EADP/G, WT65MED, WT65EJ50, WT65EJ60, LS14AH240U, WT65H208U, WT65H240U, LS14H208DU, LS14AH208U, LS14H240DU, LS14H208RU, LS14H240RU, WT65H208DU, WT65H240DU, WT65H208RU...(Other models you can see in the webshop) | | |

| | | | |
|---|--|-----------------|--------|
|  | | | |
| 1 | | | |
| GEV No. | 520121 | Ref. No. | OG2823 |
| description | hose clamp SS W4 ø 16-27mm width 9mm Qty 1 pcs DIN 3017 | | |
| For models: | CE128-106, CE158-133.3.HV, CE158-244.3, CE158-246.3, CK248-209, D1ABBB, CK248-211.D1ABBB, HCE128-100, HCE128-104, HCE158-252W.3, HCE158-253.3, HLE129-100, HLE129-103, HLE129-104W, HLE159-252W.3.6, HLE159-328.3.HV, HLE159-351W.3.HV, HLE249-200.3, HLE249-208.3, HLE259-088.3.HV, HLE259-089.3.HV, HLE259-384W.3, LE129-101, LE159-261.3, LE159-281.3.6, LE159-318.3.HV, LE159-322.3.HV, LE159-330.3.HV, LE159-337.3.HV, LE159-344.3.MS92, LE159-347.3.HV, LE249-199.3, LE249-203.3, LE249-207.3, LE249-211.3, LE249-215.3, LE249-219.3, LE249-223.3, LE249-232.3, LE249-238.3, LE259-081.3.HV, LE259-082.3.HV, LE259-083.3.HV, LE259-094.3.HV, LE259-099.3.HV, LE259-382.3, LK259-707.D1ACCB, LK259-708.D1ACCB, CK248-205.D1ABBB, CK248-207.D1ABBB, LK159-707.D1BC...(Other models you can see in the webshop) | | |

one ear clamps

| | | | |
|---|---|-----------------|--------|
|  | | | |
| 1 | | | |
| GEV No. | 520991 | Ref. No. | OC5385 |
| description | one ear clamp ø 16mm width 8mm SS | | |
| For models: | BCP/G1, BCP/E1, ACPG25, ECP/E1ELHU, PCP/E1ELH, TCP/E1ELHU, TCP/E1ELH, FCZ061EAA, FCZ061EAH, FCZ061EAN, FCZ061ETA, FCZ061ETH, FCZ061ETN, FCZ061EBA, FCZ061EBH, FCZ061EBN, FCZ061EBC, FCZ061EBA2, FCZ061EBH2, FCZ061EBN2, FCZ061EBC2, FCZ061ECA, FCZ061ECH, FCZ061ECN, FCZ061ECA2, FCZ061ECH2, FCZ061ECN2, AOW101EA, AOW101EABU, AOS061EAA1, AOS061EAH1, AOS061EAN1, AOS061EAC1, AOS061EAE1, AOS061EAF1, AOS061EAM1, AOS061EAB1, AOS061EAK1, AOS061EAT1, AOS061ETA1, AOS061ETH1, AOS061ETN1, AOS061ETC1, AOS061ETE1, AOS061ETF1, AOS061ETM1, AOS061ETK1, AOS061EBA1, AOS061EBH1, AOS061EBN1...(Other models you can see in the webshop) | | |

retaining rings

DIN 6799

| | | | |
|---|---|-----------------|--------------------------------------|
|  | | | |
| 1 | | | |
| GEV No. | 507015 | Ref. No. | 068293 0C6421 0H6035 117584 |
| description | retaining ring E D1 ø 7mm D2 ø 14mm SS DIN 6799 thickness 0.9mm for shaft ø 8-11mm | | |
| For models: | FCZ061EAA, FCZ101EAA, FCZ102EAA, FCZ061EAH, FCZ101EAH, FCZ061EAN, FCZ101EAN, FCZ061ETA, FCZ101ETA, FCZ102ETA, FCZ201ETA, FCZ202ETA, FCZ061ETH, FCZ101ETH, FCZ201ETH, FCZ061ETN, FCZ101ETN, FCZ201ETN, FCZ101GTG, FCZ102GTG, FCZ201GTG, FCZ202GTG, FCZ101GTD, FCZ102GTD, FCZ201GTD, FCZ202GTD, FCZ061EBA, FCZ101EBA, FCZ102EBA, FCZ061EBH, FCZ101EBH, FCZ061EBN, FCZ101EBN, FCZ061EBC, FCZ101EBC, FCZ061EBA2, FCZ101EBA2, FCZ102EBA2, FCZ201EBA2, FCZ202EBA2, FCZ061EBH2, FCZ101EBH2, FCZ201EBH2, FCZ061EBN2, FCZ101EBN2, FCZ201EBN2, FCZ061EBC2, FCZ101EBC2, FCZ201EBC2, FCZ101GBG2...(Other models you can see in the webshop) | | |

roll pins

| | | | |
|--|---|-----------------|--------------------------------------|
|  | | | |
| 1 | | | |
| GEV No. | 692013 | Ref. No. | 052061 060920 0H6043 0K8575 |
| description | roll pin ø 3mm L 16mm | | |
| For models: | MCF/G1090, MCF/G1095, MCF/G995, MR/G721, MR/G1071, MR/G1070, MR/G720, MR/G725, MR/G1075, MR/G726, MR/G1076, MFR/G350, MFR/G700, MFR/G350D, MFR/G700D, MFR/G350F, MFR/G700F, MFR/G350E, MFR/G700E, MFR/E355, MFR/E355UK, MFR/E355D, MFR/E705, MFR/E705UK, MFR/E705D, MFR/G740, MFR/E740, MFR/G350, MFR/G351, MFR/G700, MFR/G701, FDV40G, FDV40E, FDV40GZ, FDV40EL, FDV40GA, FDV20G, FDV20E, FDV20GZ, FDV20EL, FDV20GA, RCF/G1095, RR/G720D, 7FTGC7L, 7FTGC1L, RR/G1070D, 7FTGC7M, RR/G1076, RFR/G350, RFR/G700...(Other models you can see in the webshop) | | |

cotter pins

| | | | |
|--|--|-----------------|--------|
|  | | | |
| 1 | | | |
| GEV No. | 695209 | Ref. No. | OK8898 |
| description | cotter pin ø 2mm L 20mm SS | | |
| For models: | FT36EDTS, FT36ESTS, FT36VDTs, FT36VSTs, FT36ED, FT36ES, FT36VD, FT36VS, FT50ED, FT50ES, FT50VD, FT50VS, FT72ED, FT72ES, FT72VD, FT72VS, FT36EDT, FT36EST, FT36VDT, FT36VST, FT50EDT, FT50EST, FT50VDT, FT50VST, FT72EDT, FT72EST, FT72VDT, FT72VST, FT36WED, FT36WES, FT36WVD, FT36WVS, FT50WED, FT50WES, FT50WVD, FT50WVS, FT72WED, FT72WES, FT72WVD, FT72WVS, FT36WEDT, FT36WEST, FT36WVDT, FT36WVST, FT50WEDT, FT50WEST, FT50WVDT, FT50WVST, FT72WEDT, FT72WEST...(Other models you can see in the webshop) | | |

pins

| | | | |
|--|---|-----------------|--------|
|  | | | |
| 1 | | | |
| GEV No. | 551400 | Ref. No. | 002958 |
| description | threaded shaft L 43mm M6 WS 10 | | |
| For models: | FCV/G6L3TOWNGAS, FCV/G6L3, FCVE6L3J, FCV/G6L3JAP, FCVG6L3CJ, FCV/E61/1, FCV/E61/1, FCV/E61/1, FCV/E61/1, FCV/G6L3C, FCV/G61/1, FCV/G61/1, FCV/G61/1, FCV/G61/1, FCV/G61/1, FCV/G6L3CT, FCV/G6L3CJ, FCV/E6L3, FCV/G6L4, FCV/E6L4, FCF/G6-0, FCF/E6-0, FCF061ELN, FCF6EHOR, FCF061ENS, FCF/G6-1-JAP, FCFE6-1J, FCS061E44J, FCS061G48J, FCS061GP, FCS061EP, FCS061G3DI, FCS061E3CI, FCS061G4, FCS061G4DT, FCS061G49J, FCS061E4, FCS061EXLN, FCS061EX, 5711-2-6, 5711-2-7, 5711-2-8, 5711-2-10, 5711-2-8CH, 5711-2-10CH, 5711-2-6L, 5711-2-7L, 5711-2-8L, 5711-2-10L, 5721-2-7, 5721-2-10...(Other models you can see in the webshop) | | |





consumables

sealants and adhesives

high temperature silicone

| | | | |
|--|---|-----------------|--|
|  <p>1</p> | | | |
| GEV No. | 890059 | Ref. No. | 00004106 0G1878 0G1997 0H7008 422779 |
| description | high temperature silicone FERMITOPP 300 neutral curing -40 up to +265°C black cartridge 310ml | | |
| description | <p>Fermitopp HN 300 - cartridge 310ml - black</p> <p>Is used for sealing expansion joints on heating flues, ovens, reactors, chimneys, stacks, etc. The sealant is neutrally cross-linking, reacts with the moisture in the air and is characterised by extremely good hot air-resistance. The adhesive surfaces must be dry, clean and free of loose parts and in the case of porous substrates they should, if necessary, be given a first coat of primer. Post-smoothing e.g. with soap solution must take place before skinning.</p> <p>Highly refractory, odourless, UV/water/colour/hot-air resistant Temperature range -50°C to +250°C</p> | | |

| | | | |
|--|---|-----------------|---|
|  <p>1</p> | | | |
| GEV No. | 890050 | Ref. No. | 0D6223 0H9711 0H9717 0K3948 0K4520 0KG971 0KI337 11018918 7076467 |
| description | high temperature silicone NOVASIL S76 acetoxy-curing -40 up to +265°C t.max. 280°C anthracite cartridge 310ml | | |
| description | <p>Novasil S56 - cartridge 310ml - anthracite</p> <ul style="list-style-type: none"> - Developed for applications in the home appliance industry: - Gluing of oven door seals - Gluing of mounting brackets for cooker fascias, oven door seals and handles - Attachment of elastic seals, e.g. to oven doors <p>Temperature resistance: -40°C to +265°C</p> | | |
| For models: | <p>CE128-106, CE158-133.3.HV, CE158-244.3, CE158-246.3, CK248-209. D1ABBB, CK248-211.D1ABBB, HCE128-100, HCE128-104, HCE158-252W.3, HCE158-253.3, HLE129-100, HLE129-103, HLE129-104W, HLE159-252W.3.6, HLE159-328.3.HV, HLE159-351W.3.HV, HLE249-200.3, HLE249-208.3, HLE259-088.3.HV, HLE259-089.3.HV, HLE259-384W.3, HLI159-371W.3, HLI159-373.3, HLI259-390W.3, LE129-101, LE159-261.3, LE159-281.3.6, LE159-318.3.HV, LE159-322.3.HV, LE159-330.3.HV, LE159-337.3.HV, LE159-344.3.MS92, LE159-347.3.HV, LE249-199.3, LE249-203.3, LE249-207.3, LE249-211.3, LE249-215.3, LE249-219.3, LE249-223.3, LE249-232.3, LE249-238.3, LE259-081.3.HV, LE259-082.3.HV, LE259-083.3.HV, LE259-094.3.HV, LE259-099.3.HV, LE259-382.3, LI159-375.3, LI159-376.3...(Other models you can see in the webshop)</p> | | |

| | | | |
|--|--|-----------------|--------|
|  <p>1</p> | | | |
| GEV No. | 890035 | Ref. No. | 0H7009 |
| description | high temperature silicone SIL-BOND RTV4500 -52 up to +204°C white cartridge 305ml | | |
| description | <p>Sil-Bond RTV 4500 - cartridge 305ml - white</p> <p>One component room temperature vulcanizing RTV acetoxy cure silicone sealant and adhesive that has been chemically formulated for high strength adhesion. When fully cured, this unique VOC compliant formula offers UV stability and excellent adhesion to form waterproof and airtight bonds to metal, steel, tile, fiberglass, ceramic, glass, aluminum, painted surfaces, wood, plywood, marble, plus many other common substrates. This product is specifically formulated to offer all weather performance.</p> <p>Temperature range: -52°C to +204°C NTF approved</p> | | |
| For models: | 5611-3-10, 5611-3-6, 5611-3-8, 5612-3-10, 5612-3-6, 5612-3-8, 5614-3-10, 5614-3-6, 5614-3-8 | | |

| | | | |
|---|--|-----------------|--------|
|  | | | |
| 1 | | | |
| GEV No. | 890258 | Ref. No. | 059611 |
| description | high temperature silicone TOMABOND TB77 -40 up to +250°C t.max. 300°C anthracite cartridge 310ml | | |
| description | Tomabond TB 77 - cartridge 310ml - anthracite Special neutral adhesive sealant with extraordinary quality and workability characteristics. Suitable for producing bonds and seals with high thermal loads in numerous materials such as ABS, PA, PC, PMMA, Al (including anodised), stainless steel, zinc sheet, glass, ceramic, natural stone counters and many composite materials. Non-corrosive to metal or electronic parts, good grease resistance, high adhesion (1.1 N/mm ²) Temperature-resistant from -40 °C to +250 °C (short-term to +300 °C) | | |
| For models: | V350, V700, V1050, V1400 | | |

cleaning agents

degreasers

| | | | |
|--|----------------------|-----------------|--------|
|  | | | |
| 1 | | | |
| GEV No. | 802212 | Ref. No. | 0S1195 |
| description | degreaser for grills | | |

fuses

fine fuses

| | | | |
|---|--|-----------------|--------|
|  | | | |
| 1 | | | |
| GEV No. | 358666 | Ref. No. | 0W3499 |
| description | fine fuse size ø5x20mm 0.315A fast-acting rated 250V Qty 10 pcs | | |
| For models: | C240, C260, D1000V, T1000, T1000, T1000, C24001, C240R01, C26001, C260R01, C290R01, C260R02, C240R02 | | |

| | | | |
|--|--|-----------------|--------|
|  | | | |
| 1 | | | |
| GEV No. | 358669 | Ref. No. | 0W5452 |
| description | fine fuse size ø5x20mm 0.63A fast-acting rated 250V Qty 10 pcs | | |
| For models: | T4250, T4250, T4350, T419002, T419003, PD9, T353019, T3650, T3650, T3650, T3530, T3530, T419001, T419005, T425001, T425002, T425003, T425004, T425005, T425006, T425007, T425008, T425009, T425010, T425011, T425012, T329001, T329002, T329003, T329004, T329005, T329006, T329007, T329008, T329009, T329010, T329011, T329012, T4300S01, T4300S02, T435001, T435002, T435003, T435004, T435005, T435006, T435007, T435008, T435009, T435010...(Other models you can see in the webshop) | | |

| | | | |
|--|---|-----------------|----------------------------|
|  | | | |
| 1 | | | |
| GEV No. | 358610 | Ref. No. | 002347 058869 0W3317 |
| description | fine fuse size ø5x20mm 10A fast-acting rated 250V Qty 10 pcs | | |
| For models: | FCZ102EAA, FCZ102ETA, FCZ102GAG, FCZ102GAD, FCZ101GTG, FCZ102GTG, FCZ101GTD, FCZ102GTD, FCZ102EBA, FCZ102EBA2, FCZ102GBG, FCZ102GBD, FCZ061GBI, FCZ101GBI, FCZ101GBG2, FCZ102GBG2, FCZ101GBD2, FCZ102GBD2, FCZ101GBI2, FCZ102GBI2, FCZ102ECA, FCZ102ECA2, FCZ102GCG, FCZ102GCD, FCZ101GCG2, FCZ102GCG2, FCZ101GCD2, FCZ102GCD2, FCFE201-0, FCFE202-0, FCF201ENS, FCFM62E, FCFM62EUK, FCFM62G, 5714-2-7, 5714-2-8, 5714-2-10, 5717-2-6, 5714-2-7, 5714-2-8, 5714-2-10, 5714-2-7L, 5714-2-8L, 5714-2-10L, 5714-2-6L, 5714-2-7L, 5714-2-8L, 5714-2-10L, 5714-3-6, 5714-3-7...(Other models you can see in the webshop) | | |

| | | | |
|--|--|-----------------|--------|
|  | | | |
| 1 | | | |
| GEV No. | 358611 | Ref. No. | 005136 |
| description | fine fuse size ø5x20mm 16A fast-acting rated 250V Qty 10 pcs | | |
| For models: | FCZ202ETA, FCZ202GAG, FCZ202GAD, FCZ201GTG, FCZ202GTG, FCZ201GTD, FCZ202GTD, FCZ202EBA2, FCZ202GBG, FCZ202GBD, FCZ201GBI, FCZ201GBG2, FCZ202GBG2, FCZ201GBD2, FCZ202GBD2, FCZ201GBI2, FCZ202ECA2, FCZ202GCG, FCZ202GCD, FCZ201GCG2, FCZ202GCG2, FCZ201GCD2, FCZ202GCD2, FCFV202L3, FCFV202L3, FCFV202L6, FCFV202L6, FCFV/G202/1, FCFV/E202/1, FCFE201-0, FCFE202-0, FCF201ENS, FCS202E4, FCS202EP, FCS201GP, FCS202G4, FCS202GP, FCS202EX, FCS201GX, FCS202GX, 5714-2-7, 5714-2-8, 5714-2-10, 5714-2-7L, 5714-2-8L, 5714-2-10L, 5717-3-7, 5717-3-8, 5717-3-8E, 5717-3-10...(Other models you can see in the webshop) | | |

| | | | |
|--|--|-----------------|--------|
|  | | | |
| 1 | | | |
| GEV No. | 358671 | Ref. No. | 0W5451 |
| description | fine fuse size ø5x20mm 1A fast-acting rated 250V Qty 10 pcs | | |
| For models: | T4250, T4250, T4350, T419002, T419003, PD9, T353019, T3650, T3650, T3650, T3530, T3530, T419001, T419005, T425001, T425002, T425003, T425004, T425005, T425006, T425007, T425008, T425009, T425010, T425011, T425012, T329001, T329002, T329003, T329004, T329005, T329006, T329007, T329008, T329009, T329010, T329011, T329012, T4300S01, T4300S02, T435001, T435002, T435003, T435004, T435005, T435006, T435007, T435008, T435009, T435010...(Other models you can see in the webshop) | | |





| | | | |
|--|---|-----------------|--------|
|  <p>1</p> | | | |
| GEV No. | 358532 | Ref. No. | 0A8438 |
| description | fine fuse size ø5x20mm 2A fast-acting rated 250V Qty 10 pcs | | |

| | | | |
|--|--|-----------------|--|
|  <p>1</p> | | | |
| GEV No. | 358677 | Ref. No. | 053741 057783 088227 090017 0H0516 OKD887 OKP602 OKP604 OKT789 |
| description | fine fuse size ø5x20mm 4A fast-acting rated 250V Qty 10 pcs | | |
| For models: | BCF11, AQC119U US, , BCW061, BCFW061, BCF11, BCWS061T, BC56VA, Crosswise 20, BC56HA, BCF64A, Crosswise 20, BCF56HA, BCFWS061, BCFWS061T, BLAST C/FREEZER, MBR/E710D, MBR/E700, MBR/E700UK, MBR/E716, MBR/E706, MFR/E350, MFR/E700, MFR/E370, MFR/E350UK, MFR/E700UK, MFR/E370UK, MFR/E370D, MFR/E350D, MFR/E700D, MFR/E355, MFR/E355UK, MFR/E355D, MFR/E705, MFR/E705UK, MFR/E705D, MFR/E740, RBR/E2FM, RBR/E2IM, RBK/E2FM, RCP/E2S, XBR/E2FM, XBR/E2IM, XBK/E2FM, JBR/E2FM, MBR/E2FM, MBR/E2IM, MBK/E2FM, MCP/E2S...(Other models you can see in the webshop) | | |

| | | | |
|--|--|-----------------|---|
|  <p>1</p> | | | |
| GEV No. | 358533 | Ref. No. | 002348 005077 053534 058871 068914 072068 0C1480 0F0187 0H7033 OK8698 11019129 CF00023 |
| description | fine fuse size ø5x20mm 6.3A fast-acting rated 250V Qty 10 pcs | | |
| For models: | BC44, BC44H, BCW101, BCW102, BCFW101, BC44, BC44H, BCFW102, BC44, BC44H, BCFWS102, BCFWS101, STRP1101, STRP1102, STRP1601, STRP1602, STRP1603, STRP2201, STRP2202, STRP2203, STRP1101S, STRP1601S, STRP2201S, STRP1602R, STRP1603R, STRP2201R, STRP2202R, STRP2203R, STRP1101R, STRP1102R, STRP1601R, FDV40G, FDV40E, FDV40GZ, FDV40EL, FDV40GA, FDV20G, FDV20E, FDV20GZ, FDV20EL, FDV20GA, MCP/E1SH, MCP/E1SUH, MCP/E2SUHS, MCP/E2SH, MCP/E2SUH, MCP/E2SUT, MCP/E2SHB, ECP/E1ELHU, PCP/E1SH...(Other models you can see in the webshop) | | |

| | | | |
|---|---|-----------------|---|
|  <p>1</p> | | | |
| GEV No. | 358695 | Ref. No. | 005032 0H9825 0K3350 0K4542 0K4994 11019096 4005032 |
| description | fine fuse size ø5x20mm 3.15A medium lag rated 250V Qty 10 pcs | | |
| For models: | FCV/G20L3, FCVG202L3, FCV/E20L3, FCVE202L3, FCV/G20L6, FCV/E20L6, FCVG202L6, FCVE202L6, FCV/G201/1, FVC/E201/1, FVC/E202/1, 5714-2-7, 5714-2-8, 5714-2-10, 5714-2-7, 5714-2-8, 5714-2-10, 5714-2-7L, 5714-2-8L, 5714-2-10L, 5714-2-7L, 5714-2-8L, 5714-2-10L, 5714-3-7, 5714-3-8, 5714-3-8E, 5714-3-10, 5717-3-7, 5717-3-8, 5717-3-8E, 5717-3-10, 5717-3-8M, 5717-3-8M, ECV/G20T4, ECV/E20T4, ECVG202T4, ECVE202T4, ECV/G20T4J, ECV/G20T6, ECV/E20T6, ECVG202T6, ECVE202T6, CE128-106, CE158-133.3.HV, CE158-244.3, CE158-246.3, CEB068, CK248-209.D1ABBB, CK248-211.D1ABBB, HCE128-100...(Other models you can see in the webshop) | | |

| | | | |
|---|--|-----------------|--|
|  <p>1</p> | | | |
| GEV No. | 358594 | Ref. No. | 002820 0F0189 0H7031 11019111 |
| description | fine fuse size ø5x20mm 0.16A slow-acting rated 250V Qty 10 pcs | | |
| For models: | FCV/G10L3, FCV/G6L3TOWNGAS, FCV/G6L3, FCVG10L3T, FCVG102L3, FCV/E101/1, FCV/G20L3, FCVG202L3, FCVE6L3J, FCV/E10L3JAP, FCV/E102/1L3JAP, FCV/E10L6JAP, FCV/E102/1L6JAP, FCV/G6L-3JAP, FCVG10L3J, FCVG102L3J, FCV/G10L6JAP, FCV/G102/1L6JAP, FCVG6L3CJ, FCV/E61/1, FCV/G10L2, FCV/E61/1, FCV/E101/1, FCV/E101/1, FCV/E10L2, FCV/E102/1, FCV/E61/1, FCV/E61/1, FCV/E101/1, FCV/E101/2, FCV/G6L3C, FCV/G61/1, FCV/G61/1, FCV/G61/1, FCV/G61/1, FCV/G6L3CT, FCVG6L3CJ, FCV/E10L3, FCV/E102/1, FCV/E6L3, FCV/E102/1L3, FCV/E20L3, FCVE202L3, FCV/G6L4, FCV/E6L4, FCV/E101/1, FCV/G10L6, FCV/E10L6, FCV/G102/1L6, FCV/E102/1L6...(Other models you can see in the webshop) | | |

| | | | |
|---|---|-----------------|-------------------|
|  <p>1</p> | | | |
| GEV No. | 358592 | Ref. No. | 086338 3049003 |
| description | fine fuse size ø5x20mm 0.1A slow-acting rated 250V Qty 10 pcs | | |
| For models: | CIM120AS, CIM120WS | | |

| | | | |
|---|---|-----------------|--------|
|  | | | |
| 1 | | | |
| GEV No. | 358596 | Ref. No. | 002920 |
| description | fine fuse size ø5x20mm 0.25A slow-acting rated 250V Qty 10 pcs | | |
| For models: | FCV/G10L3, FCV/G6L3TOWNGAS, FCV/G6L3, FCVG10L3T, FCVE6L3J, FCV/E10L3JAP, FCV/E10L6JAP, FCV/G6L3JAP, FCVG10L3J, FCV/G10L6JAP, FCVG6L3CJ, FCV/E61/1, FCV/G10L2, FCV/E61/1, FCV/E10L2, FCV/E61/1, FCV/E61/1, FCV/G6L3C, FCV/G61/1, FCV/G61/1, FCV/G61/1, FCV/G61/1, FCV/G61/1, FCV/E10L3, FCV/E6L3, FCV/G6L4, FCV/E6L4, FCV/G10L6, FCV/E10L6, FCV/E101/1, FCV/G101/1, FVC/E101/1, FCS061G48J, FCS061GP, FCS061G3DI, FCS061E-3CI, FCS061G4, FCS101E2, FCS061G4DT, FCS101E44J, FCS061G49J, FCS101G2, FCS101E4, FCS101G4, FCS101G4DT, FCS101G49J, AOW101EA, 5711-2-8CH, 5711-2-10CH...(Other models you can see in the webshop) | | |

| | | | |
|---|--|-----------------|----------------------------|
|  | | | |
| 2 | | | |
| GEV No. | 358703 | Ref. No. | 002750 0F0188 0K8741 |
| description | fine fuse size ø5x20mm 0.4A slow-acting rated 250V Qty 10 pcs | | |
| For models: | FCVG102L3, FCV/E101/1, FCV/E102/1L3JAP, FCV/E102/1L6JAP, FCVG102L3J, FCV/G102/1L6JAP, FCV/E101/1, FCV/E101/1, FCV/E102/1, FCV/E101/1, FCV/E101/2, FCV/E102/1, FCV/E102/1L3, FCV/E101/1, FCV/G102/1L6, FCV/E102/1L6, FCV/G102/1, FVC/E102/1, FCS102E44J, FCS102E4, FCS102G4, FCS201E4, FCS102G49J, FCS202E4, FCS202G4, CS7ME4/200-3, CS7ME4/230-3, CS7ME4/400-3N, CS7ME6/400-3N, CS7ME4/400-3N/EO, CS7ME4/400-3/50HZ/MA, CS7ME4/440-3/60HZ/MA, CS7MT4/400-3N, CS7GE4/200-3, CS7GE4/230-3, CS7GE4/400-3N, CS7GE6/400-3N, CS7GE4/400-3N/EO, CS7GE4/400-3/50HZ/MA, CS7GE4/440-3/60HZ/MA, CS7GT4/400-3N, CS7LCE4/200-3, CS7LCE4/230-3, CS7LCE4/400-3N, CS7LCE6/400-3N, CS7LCE4/400-3N/EO, CS7LCE4/400-3/50HZ/M, CS7LCE4/440-3/60HZ/M, CS7LCT4/400-3N, CS10ME4/200-3...(Other models you can see in the webshop) | | |

| | | | |
|---|--|-----------------|--------|
|  | | | |
| 1 | | | |
| GEV No. | 358599 | Ref. No. | 0C2301 |
| description | fine fuse size ø5x20mm 0.8A slow-acting rated 250V Qty 10 pcs | | |
| For models: | FCZ061EAA, FCZ101EAA, FCZ102EAA, FCZ201EAA, FCZ202EAA, FCZ061EAH, FCZ101EAH, FCZ201EAH, FCZ061EAN, FCZ101EAN, FCZ201EAN, FCZ061ETA, FCZ101ETA, FCZ102ETA, FCZ201ETA, FCZ202ETA, FCZ061ETH, FCZ101ETH, FCZ201ETH, FCZ061ETN, FCZ101ETN, FCZ201ETN, FCZ061GAG, FCZ101GAG, FCZ102GAG, FCZ201GAG, FCZ202GAG, FCZ061GAD, FCZ101GAD, FCZ102GAD, FCZ201GAD, FCZ202GAD, FCZ101GTG, FCZ102GTG, FCZ201GTG, FCZ202GTG, FCZ101GTD, FCZ102GTD, FCZ201GTD, FCZ202GTD, FCZ061EBA, FCZ101EBA, FCZ102EBA, FCZ201EBA, FCZ202EBA, FCZ061EBH, FCZ101EBH, FCZ201EBH, FCZ061EBN, FCZ101EBN...(Other models you can see in the webshop) | | |

| | | | |
|--|--|-----------------|------------------|
|  | | | |
| 1 | | | |
| GEV No. | 358608 | Ref. No. | 0C5431 0L1295 |
| description | fine fuse size ø5x20mm 10A slow-acting rated 250V Qty 10 pcs | | |
| For models: | EPPWELG, FCZ102EAA, FCZ102ETA, FCZ102EBA, FCZ102EBA2, FCZ102ECA, FCZ102ECA2, AOS102EAA1, AOS102EAC1, AOS102EAS1, AOS062EAM1, AOS102EAM1, AOS062EAB1, AOS102EAB1, AOS102EAK1, AOS102EAT1, AOS102ETA1, AOS062ETM1, AOS102ETM1, AOS102ETK1, AOS102EBA1, AOS102EBC1, AOS102EBK1, AOS102EBA2, AOS102EBK2, AOS102ECA1, AOS062ECM1, AOS102ECM1, AOS062ECB1, AOS102ECB1, AOS102ECA2, AOS062ECM2, AOS102ECM2, EPPWESG, EPPWESG60, EPPWEHG, ZPPWESG, ZPPWEHG, ZPPWSSG, EPPWELG, EPPWELG60, ZPPWELG, ZPPWSLG, EPPWESGFB, EPPWEHGF, EPPWELGF, EPPWESGM6, NPPWESG, NPPWEHG, NPPWELG...(Other models you can see in the webshop) | | |

| | | | |
|--|--|-----------------|--------|
|  | | | |
| 1 | | | |
| GEV No. | 358603 | Ref. No. | 090098 |
| description | fine fuse size ø5x20mm 2A slow-acting rated 250V Qty 10 pcs | | |
| For models: | BC100A, BC100DA, BC100RA, BC100RDA, BC180A, BC180DA, BC180RA, BC180RDA, BC180RPA, BCF100A, BCF100DA, BCF100RA, BCF100RDA, BCF180A, BCF180DA, BCF180RA, BCF180RDA, BCF180RPA, BCW201R, BCFW201R, BC120A, BC120RA, BCF120A, BCF120RA, BLAST C/FREEZER, BLAST C/FREEZER, BLAST C/FREEZER, BLAST C/FREEZER, BLAST C/FREEZER, BLAST C/FREEZER, BLAST C/FREEZER, BC0144, BC072, ESBC72R, ESBC144R, ESBF70, ESBF70R, ESBF144, ESBF144R, AOCP2028R, AOCP2028RD, AOCP2028RT, AOFP2028R, AOFP2028RD, AOFP2028RT, EABPR101, EABC101R, AOFP201CR, AOFP201RU, AOFP202RU...(Other models you can see in the webshop) | | |

| | | | |
|--|--|-----------------|--------|
|  | | | |
| 1 | | | |
| GEV No. | 358605 | Ref. No. | 0C4996 |
| description | fine fuse size ø5x20mm 3.15A slow-acting rated 250V Qty 10 pcs | | |
| For models: | BCP/E1, PCP/E1ELH, TCP/E1ELH, FCZ201GTG, FCZ201GTD, FCZ201GBG2, FCZ201GBD2, FCZ201GBI2, FCZ201GCG2, FCZ201GCD2, AOS201GTG1, AOS201GTD1, AOS201GTP1, AOS201GTW1, AOS201GBG2, AOS201GBD2, AOS201GBW2, AOS201GCG2, AOS201GCD2, ECRT66R208, ECRT66L208, ECRT66R240, ECRT66L240, ECRT44R208, ECRT44L208, ECRT44R240, ECRT44L240, LWC44AR208, LWC44AL208, LWC44AR240, LWC44AL240, LWC66AR208, LWC66AL208, LWC66AR240, LWC66AL240 | | |

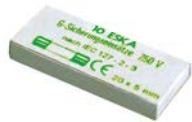
| | | | |
|--|---|-----------------|--------|
|  | | | |
| 1 | | | |
| GEV No. | 358607 | Ref. No. | 007054 |
| description | fine fuse size ø5x20mm 6.3A slow-acting rated 250V Qty 10 pcs | | |
| For models: | AOS061EA, AOS061EB, AOS101EA, AOS101EB, AOS061EA3J, AOS061EB3J, AOS101EA3J, AOS101EB3J, AOS061EA2N, AOS061EB2N, AOS101EA2N, AOS101EB2N, AOS061EB5M, AOS101EB5M, AOS201E-B5M, AOS061EB6M, AOS101EB6M, AOS201EB6M, AOS102EA2N, AOS102EB2N, AOS202EA2N, AOS202EB2N, AOS061EA0H, AOS061EB0H, AOS101EA0H, AOS101EB0H, AOS102EA, AOS102EB, AOS202EA, AOS202EB, AOS061GA, AOS101GA, AOS201GA, AOS201GB, AOS102GB, AOS102GA, AOS202GB, AOS202GA | | |



| ø6.3x32mm 500V | | | |
|---|---|-----------------|--------|
|  | | | |
| 1 | | | |
| GEV No. | 358751 | Ref. No. | 0C2230 |
| description | fine fuse size ø6.3x32mm 6.3A fast-acting rated 500V Qty 10 pcs | | |
| For models: | FCZ061EAA, FCZ101EAA, FCZ061EAH, FCZ101EAH, FCZ061EAN, FCZ101EAN, FCZ061ETA, FCZ101ETA, FCZ201ETA, FCZ061ETH, FCZ101ETH, FCZ201ETH, FCZ061ETN, FCZ101ETN, FCZ201ETN, FCZ061EBA, FCZ101EBA, FCZ061EBH, FCZ101EBH, FCZ061EBN, FCZ101EBN, FCZ061EBC, FCZ101EBC, FCZ061EBA2, FCZ101EBA2, FCZ201EBA2, FCZ061EBH2, FCZ101EBH2, FCZ201EBH2, FCZ061EBN2, FCZ101EBN2, FCZ201EBN2, FCZ061EBC2, FCZ101EBC2, FCZ201EBC2, FCZ061ECA, FCZ101ECA, FCZ061ECH, FCZ101ECH, FCZ061ECN, FCZ101ECN, FCZ061ECA2, FCZ101ECA2, FCZ201ECA2, FCZ061ECH2, FCZ101ECH2, FCZ201ECH2, FCZ061ECN2, FCZ101ECN2, FCZ201ECN2... (Other models you can see in the webshop) | | |

| ø10x38mm 500V | | | |
|---|---|-----------------|--------|
|  | | | |
| 1 | | | |
| GEV No. | 358020 | Ref. No. | 048995 |
| description | fine fuse size ø10x38mm 1A rated 500V type Gg fast-acting Qty 1 pcs | | |
| For models: | WT33/M50, WT33/M60, WT30U400, WT30U440 | | |

| | | | |
|---|--------------|---------------------------------|----------|
| A | | | |
| alarm devices | 59 | female fastons | 128 |
| appliance hose reels | 244 | ferrite rings | 124 |
| audible timers | 59 | filters | 124 |
| automatic softeners | 252 | fine fuses | 266 |
| axial fans | 108 | foam rubber gaskets | 234 |
| | | forced air burners | 171 |
| | | formed hoses | 248 |
| | | fuses | 125, 266 |
| B | | | |
| ball valves | 250 | G | |
| ball valves electric | 103, 251 | gas burners | 170 |
| bar burners | 170 | gas control valves | 132 |
| bi-metal thermostats | 18, 18 | gas hoses | 183 |
| | | gas lines | 183 |
| | | gas nozzles | 172 |
| | | gas thermostats | 131 |
| | | gaskets for heated units | 222 |
| | | gaskets for tray rack trolleys | 230 |
| | | gastronorm | 242 |
| | | GEV | 2 |
| | | grates | 221 |
| | | grub screws | 258 |
| C | | | |
| cables | 128 | H | |
| cam switches | 34 | halogen lamp | 48 |
| cap nuts | 259 | handle latches | 201 |
| castors and bumper angles | 219 | heating elements | 2 |
| clamps | 29, 255, 262 | heating elements for convection | 10 |
| cleaning agents | 266 | heating elements for ovens | 2 |
| cleaning tools | 257 | hexagonal nuts | 259 |
| condensators & interference suppression filters | 121 | high temperature silicone | 265 |
| connection cables | 128 | hose clamps | 255, 262 |
| consumables | 265 | hose connectors | 249, 249 |
| contactors | 60 | hose reels | 244 |
| container filters | 245 | hoses | 246 |
| control equipment | 41 | hot air fans | 118 |
| control thermostats | 18 | hot air motors | 109 |
| cotter pins | 264 | | |
| countersunk screws | 258 | I | |
| | | ignition boxes | 141 |
| | | ignition cables | 160 |
| | | ignition switches | 163 |
| | | ignition units | 163 |
| | | immersion heating elements | 2 |
| | | indicator lights | 42 |
| | | indicator lights (complete) | 45 |
| | | industrial hoses | 248 |
| | | infrared lamps | 49 |
| D | | | |
| degreasers | 266 | K | |
| door catches | 203 | knurled nuts | 259 |
| door gaskets (wire reinforced) | 230 | | |
| door seals | 224 | | |
| door seals with fixing hook | 230 | | |
| dosing pumps | 245 | | |
| | | | |
| E | | | |
| edgemount latches | 201 | | |
| electric accessories | 128 | | |
| electric timers | 58 | | |
| electrodes | 105 | | |
| electronic controllers | 71 | | |
| energy regulators | 17 | | |
| espagnolette locks | 204 | | |
| | | | |
| F | | | |
| fans | 108 | | |
| fasteners | 262 | | |
| fastening material | 258 | | |

| | | | |
|----------------------------------|----------|---------------------------------|----------|
| L | | | |
| lamp accessories | 57 | | |
| lamps | 42 | | |
| leak detectors | 257 | | |
| light bulbs | 47 | | |
| linear lamps | 49 | | |
| M | | | |
| magnetic switches | 40 | | |
| measuring equipment | 257 | | |
| mechanical timers | 58 | | |
| meters | 257 | | |
| microswitches | 32 | | |
| motors | 121 | | |
| N | | | |
| neon light bulbs | 44, 47 | | |
| Niplaflex hoses | 248 | | |
| non-return valves | 255 | | |
| nuts | 259 | | |
| O | | | |
| one ear clamps | 264 | | |
| operating capacitors | 122 | | |
| O-rings | 231 | | |
| oval head screws | 258 | | |
| oven hinges | 211 | | |
| oven lamps | 49 | | |
| P | | | |
| piezoelectric igniters | 162 | | |
| pilot burners | 143 | | |
| pilot heating elements | 2 | | |
| pins | 264 | | |
| pre-rinse hoses | 247 | | |
| pressure reduction valves | 254, 254 | | |
| pressure switches | 104, 183 | | |
| probe clips | 29 | | |
| probes | 72 | | |
| programme timers | 57 | | |
| pumps | 121 | | |
| push/momentary push switches | 31 | | |
| push-in fittings | 249 | | |
| PVC braided hoses | 247 | | |
| PVC hoses | 248 | | |
| PVC supply hoses | 247 | | |
| R | | | |
| radial fans | 120 | | |
| relays | 66 | | |
| retaining rings | 264 | | |
| rocker/momentary rocker switches | 29 | | |
| | | roll pins | 264 |
| | | rotary switches | 39 |
| S | | | |
| | | safety bi-metal thermostats | 18 |
| | | safety thermostats | 23, 28 |
| | | safety valves | 143 |
| | | screws | 258 |
| | | sealants and adhesives | 265 |
| | | sealing washers | 234 |
| | | shaft gaskets | 235 |
| | | shelves and shelf rails | 221 |
| | | shut-off valves | 252 |
| | | silicone | 265 |
| | | silicone hoses | 248 |
| | | snap locks | 204 |
| | | solenoid valves | 88 |
| | | spray guns | 243 |
| | | spray guns with external thread | 243 |
| | | stainless steel flexi hoses | 246 |
| | | starting capacitors | 121 |
| | | supply filters | 254, 254 |
| | | supply hoses | 246 |
| | | switches and momentary switches | 29 |
| | | system switches (ROLD) | 34 |
| T | | | |
| | | temperature probes | 72 |
| | | terminals | 128 |
| | | terminals and connectors | 128 |
| | | thermocouples | 163 |
| | | thermostats | 18 |
| | | time relays | 69 |
| | | timers | 57 |
| | | tools | 257 |
| | | tooth lock washers | 262 |
| | | transformers | 70 |
| | | turning lever locks | 201 |
| U | | | |
| | | universal hoses | 246 |
| | | universal probes | 72 |
| V | | | |
| | | valves and tank inlets | 250 |
| | | vibration pumps | 121 |
| W | | | |
| | | washers | 261 |
| | | water cycle components | 254 |
| | | water filters | 253 |
| | | water softeners | 252 |
| | | window seals | 222 |