

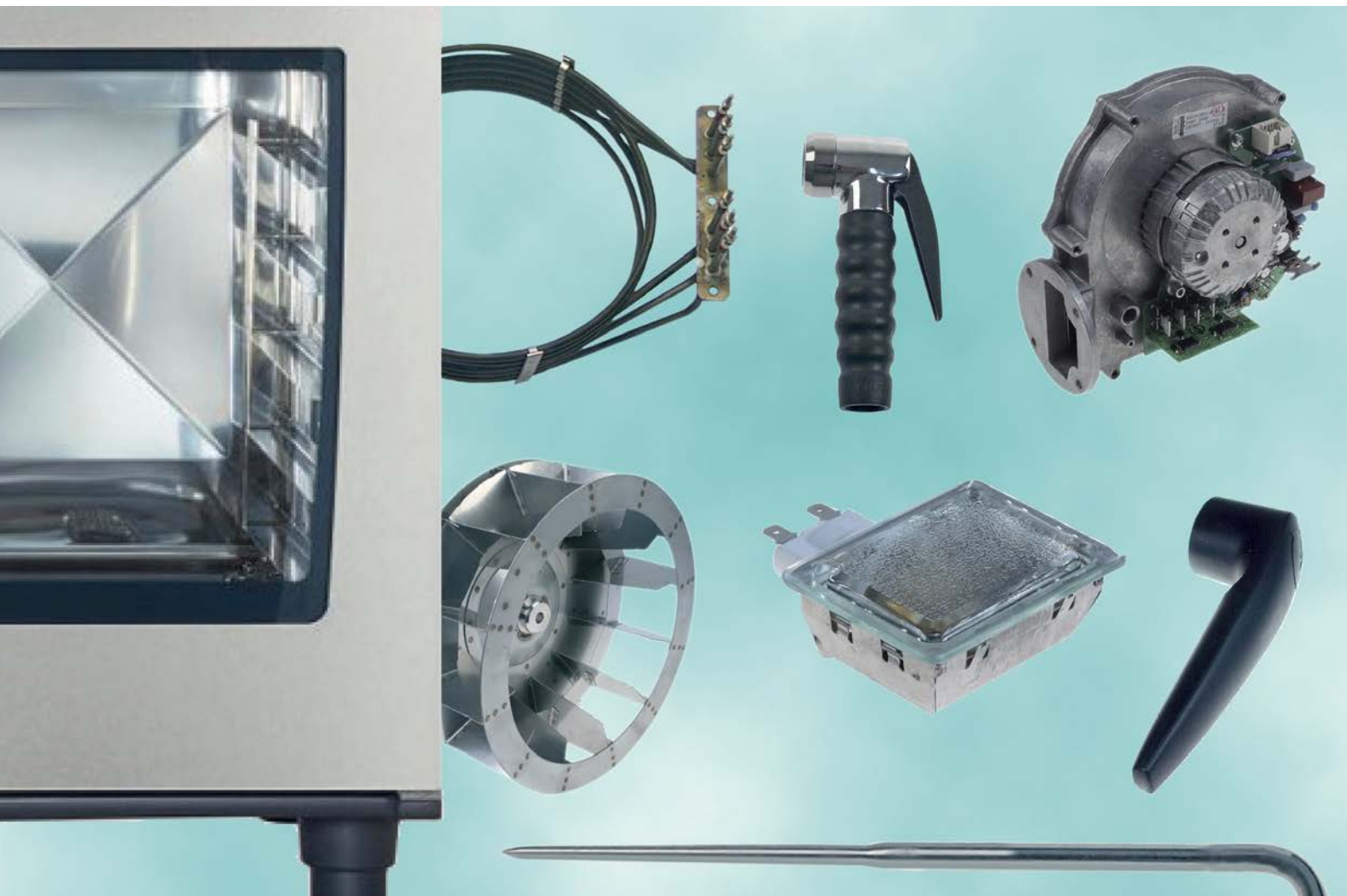

Reparatie-onderdelen voor Ovens & Combisteamers



Reparatie-onderdelen passend voor

REPAGAS

2018

Het complete assortiment vindt u altijd up-to-date in onze webshop



verwarmingselementen

dompelementen

3-gatsflens ø47,5mm

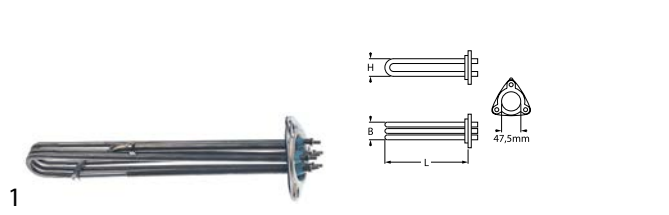

bestelnr.	418136	fabrikantnr.	1250007
------------------	--------	---------------------	---------

omschrijving
verwarmingselement 4360W 240V inbouw ø 47.5mm VC 3 L 310mm B 31mm H 35mm aantal thermostaathulzen 1 thermostaathuls ø 7mm themostaathuls lengte 200mm thermostaathuls aangrenzend pijp ø 6.3mm LA 62mm gat ø 8mm aansluiting M4 3-gatsflens dompel verwarmingselement

Reparatie-onderdelen voor 418136

	bestelnr.	510408	fabrikantnr.	—
	O-ring EPDM materiaaldikte 5.34mm ID ø 47mm vpe 1stuk			

Toebehoren voor 418136

	bestelnr.	510408	fabrikantnr.	—
	O-ring EPDM materiaaldikte 5.34mm ID ø 47mm vpe 1stuk			

	bestelnr.	510562	fabrikantnr.	—
	O-ring silicone materiaaldikte 5.34mm ID ø 47mm vpe 1stuk			

met expansieflens 70 x 18mm



bestelnr.	417781	fabrikantnr.	48900001
------------------	--------	---------------------	----------

omschrijving
verwarmingselement 2000W 230V VC 1 flens 70x18mm L 210mm B 60mm aansluiting vlaksteker 6,3mm pijp ø 8.2mm dompel verwarmingselement expansieflens aansluitingslengte 34mm



bestelnr.	418137	fabrikantnr.	42000003
------------------	--------	---------------------	----------

omschrijving
verwarmingselement 3000W 230V VC 1 flens 70x18mm L 220mm B 65mm aansluiting vlaksteker 6,3mm pijp ø 8.5mm dompel verwarmingselement expansieflens aansluitingslengte 34mm



bestelnr.	418138	fabrikantnr.	43700003
------------------	--------	---------------------	----------

omschrijving
verwarmingselement 6000W 230V VC 1 flens 70x18mm L 445mm B 68mm aansluiting vlaksteker 6,3mm pijp ø 8.5mm dompel verwarmingselement expansieflens aansluitingslengte 34mm

hetelucht elementen



bestelnr.	418129	fabrikantnr.	42000002
------------------	--------	---------------------	----------

omschrijving
verwarmingselement 16000W 230V VC 3 ID ø 337mm OD ø 358mm L 450mm H 100mm L1 84mm B1 108mm H1 15mm H2 85mm flens L 142mm flens B 25mm LA 64mm aansluiting M4 pijp ø 8.5mm rond verwarmingselement gat ø 6mm rechthoekige flens



bestelnr.	418102	fabrikantnr.	91600001
------------------	--------	---------------------	----------

omschrijving
verwarmingselement 16400W 230V VC 3 ID ø 441mm OD ø 458mm L 492mm H 143mm L1 34mm B1 104mm H1 128mm H2 115mm flens L 142mm flens B 25mm LA 63mm aansluiting M6x1 pijp ø 8.5mm rond verwarmingselement gat ø 6mm rechthoekige flens

Toebehoren voor 418102

	bestelnr.	699165	fabrikantnr.	—
	pakking L 142mm B 25mm D1 ø 6.5mm D2 ø 12mm LA 17mm 9gaten grafiet materiaaldikte 2mm			



bestelnr.	416412	fabrikantnr.	1270033
------------------	--------	---------------------	---------

omschrijving
verwarmingselement 2500W 230V VC 1 ID ø 188mm OD ø 200mm L 215mm H 30mm L1 3mm B1 53mm H1 5mm H2 25mm flens L 100mm flens B 22mm LA 86mm aansluiting vlaksteker 6,3mm



1

bestelnr.	418134	fabrikantnr.	1230005
omschrijving	verwarmingselement 3300W 240V VC 1 ID ø 185mm OD ø 200mm L 215mm H 30mm B1 60mm H1 5mm H2 25mm flens L 100mm flens B 22mm LA 85mm aansluiting vlaksteker 6,3mm aansluitingslengte 22mm pijp ø 6.5mm rond verwarmingselement gat ø 5mm rechthoekige flens		

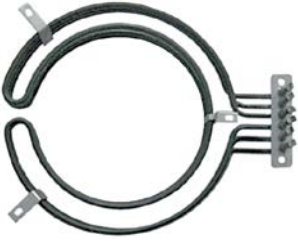

1

bestelnr.	415855	fabrikantnr.	41100003
omschrijving	verwarmingselement 3900W 230V VC 3 ID ø 176mm OD ø 244mm L 282mm H 43mm L1 38mm B1 61mm H1 13mm H2 30mm flens L 92mm flens B 22mm LA 78mm aansluiting vlaksteker 6,3mm aansluitingslengte 60mm pijp ø 6.3mm rond verwarmingselement gat ø 6.3mm rechthoekige flens		



1

bestelnr.	418132	fabrikantnr.	1250016
omschrijving	verwarmingselement 7350W 230V VC 3 ID ø 250mm OD ø 265mm L 277mm H 75mm L1 17mm B1 102mm H1 12mm H2 67mm flens L 143mm flens B 25mm LA 7mm aansluiting M4 pijp ø 6.5mm rond verwarmingselement gat ø 63mm rechthoekige flens		



1

bestelnr.	418753	fabrikantnr.	45200001
omschrijving	verwarmingselement 8000W 230V VC 3 ID ø 287mm OD ø 300mm L 345mm H 90mm L1 39mm H1 20mm H2 67mm flens L 142mm flens B 25mm LA 12.7mm aansluiting M4 aansluitingslengte 67mm pijp ø 6.5mm rond verwarmingselement gat ø 7mm rechthoekige flens		



1

bestelnr.	418135	fabrikantnr.	1230006	
omschrijving	verwarmingselement 920W 230V VC 1 ID ø 200mm OD ø 215mm L 255mm H 40mm draad 1/4" aansluiting vlaksteker 6,3mm 2-gatsbevestiging bevestigingsafstand 24mm pijp ø 8.5mm rond verwarmingselement			
Toebehoren voor	418135			
	bestelnr.	361182	fabrikantnr.	—
	moer draad 1/4" H 5mm MsNi SB 17 vpe 1stuk			
	bestelnr.	510417	fabrikantnr.	—
	vlakpakking fiber OD ø 20mm ID ø 14mm materiaaldikte 2mm vpe 1stuk			
	bestelnr.	520228	fabrikantnr.	—
	tanding ID ø 15,3mm OD ø 24mm staal vpe 1stuk voor draad M14			
	bestelnr.	550262	fabrikantnr.	—
	vlakpakking koper OD ø 20mm ID ø 14mm materiaaldikte 2mm			



1

bestelnr.	419261	fabrikantnr.	92000041
omschrijving	verwarmingselement 9500/10400W 230/240V VC 3 ID ø 320mm OD ø 337mm L 380mm H 148mm L1 40mm B1 105mm H1 20mm H2 120mm flens L 142mm flens B 25mm LA 18mm aansluiting M6x1 aansluitingslengte 85mm pijp ø 8.5mm rond verwarmingselement flens combi-steamer		



1

bestelnr.	419222	fabrikantnr.	92800004
omschrijving	verwarmingselement 27000/29000W 400/415V L 590mm B 545mm H 140mm VC 3 kabellengtemm		

			
1			
bestelnr.	418139	fabrikantnr.	1240014
omschrijving	verwarmingselement 3500W 240V VC 1 L 620mm B 120mm L1 33mm L2 587mm B2 90mm flens L 70mm flens B 22mm LA 56mm aansluitingslengte 100mm aansluiting M4 pijp ø 8.5mm gat ø 6mm B1 30mm rechthoekige flens rond verwarmingselement windingen 2		

toebehoren

zeskantmoeren

			
1			
bestelnr.	520230	fabrikantnr.	00112127 010106
omschrijving	moer draad M14x1,5 H 5mm SB 19 verzinkt staal vpe 1stuk		

energieregelaars

EGO

1-kring

			
1			
bestelnr.	380019	fabrikantnr.	1230018
omschrijving	energieregelaar 240V 13A enkel circuit draairichting rechts as ø 6x4,6mm as L 23mm bevestigingsdraad M4 vermogen- safgave 6-100% nr. 50.57071.010		

thermostaten

regel- en maximaalthermostaten

EGO

regelthermostaten

serie 55.10/19_

			
1			
bestelnr.	390068	fabrikantnr.	1230017
omschrijving	thermostaat t.max. 269°C instelbereik 55-269°C 1-polig 1CO 16A voeler ø 3.1mm voeler L 219mm capillaire 1280mm capillaire pijp geïsoleerd 1270mm stopbus as ø 6x4,6mm as L 23mm aspositie boven° rotatiehoek 318°		

			
1			
bestelnr.	375002	fabrikantnr.	1270013
omschrijving	thermostaat t.max. 320°C instelbereik 55-320°C 1-polig 1NO 16A voeler ø 3.1mm voeler L 226mm capillaire 870mm ca- pillaire pijp geïsoleerd 850mm stopbus as L 23mm aspositie boven rotatiehoek 270°		

Serie 55.13_

			
1			
bestelnr.	375505	fabrikantnr.	32403007
omschrijving	thermostaat t.max. 320°C instelbereik 50-320°C 1-polig 1NO 16A voeler ø 3mm voeler L 160mm capillaire 870mm capillaire pijp geïsoleerdmm stopbus as ø 6x4,6mm as L 23mm aspositie boven rotatiehoek 270°		

serie 55.34_

			
1			
bestelnr.	375038	fabrikantnr.	32104009
omschrijving	thermostaat t.max. 300°C instelbereik 50-300°C 3-polig 3NO 16A voeler ø 6mm voeler L 79mm capillaire 1740mm capillaire pijp geïsoleerd 800mm stopbus as ø 6x4,6mm as L 23mm aspositie boven rotatiehoek 270°		
Toebehoren voor	375038		
		bestelnr.	110123
		fabrikantnr.	—
	knop thermostaat t.max. 300°C ø 50mm as ø 6x4,6mm af- vlakking boven zwart instelbereik 50-300°C rotatiehoek 270°		



maximaal thermostaten

serie 55.10/19_

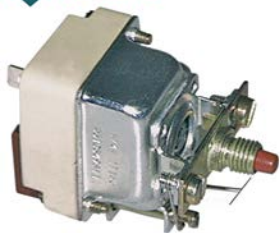

bestelnr.	375250	fabrikantnr.	1440003
omschrijving	maximaalthermostaat capillaire 870mm voeler ø 6mm 1-polig voeler L 129mm 16A capillaire pijp geïsoleerdmm stopbus uitschakeltemp. 130°C voeler RVS		

Reparatie-onderdelen voor 375250



bestelnr.	551083	fabrikantnr.	—
kap voor maximaal thermostaat draad M8x1			

Serie 55.13_



bestelnr.	390804	fabrikantnr.	010677 20400023 73313025
omschrijving	maximaalthermostaat uitschakeltemp. 340°C 1-polig 1NC 16A voeler ø 3mm voeler L 160mm capillaire 870mm capillaire pijp geïsoleerd 600mm stopbus voeler aansluiting vlaksteker 6,3mm		

serie 55.32_



bestelnr.	375649	fabrikantnr.	1250025
omschrijving	maximaalthermostaat uitschakeltemp. 160°C 3-polig 20A voeler ø 6mm voeler L 87mm capillaire 890mm capillaire pijp geïsoleerd 880mm stopbus voeler RVS		

schakelaars en tasters

microschakelaars

stiftbediening

M10



1

bestelnr.	347216	fabrikantnr.	1230024
omschrijving	microschakelaar met drukstift draad M10x0,75 draad L 14mm 250V 10A 1CO aansluiting vlaksteker 6,3mm slag 7.5mm bevestigingsafstand 22mm L 28mm omgevingstemperatuur max. 125°C type NR6K5 besturingskracht: 260g		

systemeschakelaar ROLD



1

bestelnr.	345539	fabrikantnr.	44700003
omschrijving	druktaster grootte 17x13mm grijs		



1

bestelnr.	345538	fabrikantnr.	1260022
omschrijving	druktaster ø 11.9mm zwart		

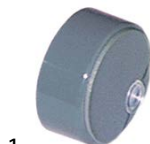

1

bestelnr.	346211	fabrikantnr.	1510008
omschrijving	druktaster ø 23mm grijs met lens		



1

bestelnr.	345537	fabrikantnr.	44700004
omschrijving	elementhouder inbouwmaat 20,6x16,4mm lichtgrijs gebogen voor drukknoppen 13x17mm		



1

bestelnr.	345131	fabrikantnr.	1510009
omschrijving	elementhouder inbouwmaat 28,5x28,5mm grijs enkele houder		



1

bestelnr.	345605	fabrikantnr.	1250039
omschrijving	schakelement 2CO 250V 16A aansluiting vlaksteker 6,3mm		



1

bestelnr.	345606	fabrikantnr.	43000005
omschrijving	tastelement 2CO 250V 16A aansluiting vlaksteker 6,3mm		

nokkenschakelaars

4-schakelstanden

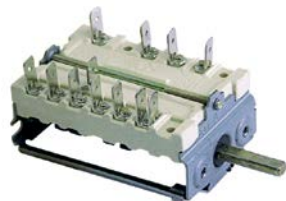

1

bestelnr.	300010	fabrikantnr.	1230016
omschrijving	nokkenschakelaar 4 schakelstanden 2NO/2CO schakelvolgorde 0-1-2-3 16A as \varnothing 6x4,6mm as L 23mm aansluiting vlaksteker 6,3mm keramiek		

voorzetschakelaars



1

bestelnr.	300002	fabrikantnr.	62500051
omschrijving	nokkenschakelaar 2 schakelstanden 4NO 16A schakelvolgorde 0-1 as \varnothing 6x4,6mm as L 23mm aansluiting vlaksteker 6,3mm keramiek		



1

bestelnr.	300153	fabrikantnr.	1270012
omschrijving	nokkenschakelaar 3 schakelstanden voorzetschakelaar 16A schakelvolgorde 0-1-2 as \varnothing 6x4,6mm as L 23mm aansluiting vlaksteker 6,3mm kunststof omgevingstemperatuur max. 240°C		

magneetschakelaars

37x16mm

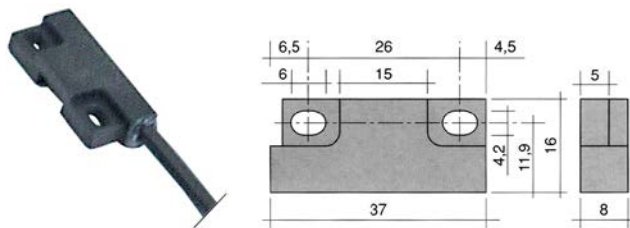

1

bestelnr.	345600	fabrikantnr.	92000018
omschrijving	magneetschakelaar L 37mm B 16mm 1NO 250V 0.2A P max. 50W aansluiting kabel kabellengte 960mm		
Toebehoren voor	345600		
	bestelnr.	fabrikantnr.	—
	magneet \varnothing mm L 63mm H 10.7mm B 18.8mm LA 52mm M2 gat \varnothing 2mm		

toebehoren

magneten



1

bestelnr.	691178	fabrikantnr.	92000021
omschrijving	magneet \varnothing 22mm Lmm H 7mm Bmm OD \varnothing 22mm M5		



1

bestelnr.	348007	fabrikantnr.	65100002
omschrijving	magneet \varnothing 23mm Lmm H 10mm Bmm ID \varnothing 4.5mm OD \varnothing 23mm M3 gat \varnothing 4.5mm		



encoders en potentiometers

			
1			
bestelnr.	402322	fabrikantnr.	90200019
omschrijving	potmeter		

			
1			
bestelnr.	300272	fabrikantnr.	90100015
omschrijving	potmeter as ø 6x4,6mm voor heteluchtoven		

lampen

signaallampen

signaallampen compleet

ø10mm

met steekfitting

			
1			
bestelnr.	359140	fabrikantnr.	1230023
omschrijving	signaallamp ø 10mm geel 230V aansluiting vlakstekker 6,3mm vpe 1stuk		

			
1			
bestelnr.	359139	fabrikantnr.	1250050
omschrijving	signaallamp ø 10mm groen 230V aansluiting vlakstekker 6,3mm vpe 1stuk		

			
1			
bestelnr.	359138	fabrikantnr.	1260025
omschrijving	signaallamp ø 10mm rood 230V aansluiting vlakstekker 6,3mm vpe 1stuk		

33x10mm

			
1			
bestelnr.	359451	fabrikantnr.	8500005
omschrijving	signaallamp inbouwmaat 33,1x10,3mm 400V geel aansluiting vlakstekker 6,3mm		

			
1			
bestelnr.	359452	fabrikantnr.	8500007
omschrijving	signaallamp inbouwmaat 33,1x10,3mm 400V groen aansluiting vlakstekker 6,3mm		

lampen voor steek-/schroeffittingen

gloeilampen

voor ovens

			
1			
bestelnr.	359610	fabrikantnr.	1230009
omschrijving	gloeilamp t.max. 300°C fitting E14 15W 230V ø 22mm L 47mm glas L 20mm voor ovenlamp type Philips		

			
1			
bestelnr.	357153	fabrikantnr.	1250021
omschrijving	gloeilamp t.max. 300°C fitting E14 25W 230V ø 25mm L 55mm glas L 30mm voor oven type 120 1000		

halogeenlamp

voor fitting G4 / G6,35 / G9

			
1			
bestelnr.	359599	fabrikantnr.	42200007
omschrijving	halogeenlamp fitting G4 12V 20W temp. bestendigheid 500°C 250 2000		

ovenlampen



universele ovenlampen

inbouwdiameter 35,5mm

			
1			
bestelnr.	359701	fabrikantnr.	1230010
omschrijving	lampfitting fitting E14 220-230V inbouw ø 35,5mm aansluiting vlakstekker 6,3mm 15W		
Toebehoren voor	359701		
	bestelnr.	359705	fabrikantnr.
			—
	lensnippel draad ø 33,5mm ø 52mm hardglas temp. bestendigheid 350°C		

Tabel wordt vervolgd op de volgende pagina



Toebehoren voor	359701		
	bestelnr.	359709	fabrikantnr. —
	lensnippel draad ø 33.5mm ø 42mm hardglas temp. bestendigheid 350°C		
	bestelnr.	359721	fabrikantnr. 1230008
	pakking silicone OD ø 48mm ID ø 39.5mm materiaaldikte 5mm vpe 1stuk		
	bestelnr.	359942	fabrikantnr. —
	lensnippel draad ø 33.5mm H 39mm ø 40mm hardglas temp. bestendigheid 350°C		

	bestelnr.	359661	fabrikantnr. 1230007
omschrijving	lensnippel draad 32.1 ø 58mm hardglas temp. bestendigheid 350°C		
Toebehoren voor	359661		
	bestelnr.	359700	fabrikantnr. —
	pakking voor pizzaoven glasvezel ID ø 32.5mm OD ø 55mm materiaaldikte 5mm		
	bestelnr.	360782	fabrikantnr. —
	pakking voor lampaansluiting glasvezel ID ø 35mm OD ø 45mm materiaaldikte 5mm		

	bestelnr.	359721	fabrikantnr. 1230008
omschrijving	pakking silicone OD ø 48mm ID ø 39.5mm materiaaldikte 5mm vpe 1stuk		

55x70mm			
	bestelnr.	359297	fabrikantnr. 44100006
omschrijving	frame L 95mm B 81mm bevestigingsafstand 68/83mm dikte 6mm		
Toebehoren voor	359297		
	bestelnr.	359299	fabrikantnr. 44100005
	pakking L 91mm B 77mm gat ø 3mm voor ovenlamp		

	bestelnr.	359296	fabrikantnr. 44100004
omschrijving	lampglas L 74mm B 58mm materiaaldikte 3mm		











	bestelnr.	359299	fabrikantnr. 44100005
omschrijving	pakking L 91mm B 77mm gat ø 3mm voor ovenlamp		

55x100mm			
	bestelnr.	359698	fabrikantnr. 1250065
omschrijving	lampfitting L 100mm B 55mm fitting E14 aansluiting vlaksteker 6,3mm		
Reparatie-onderdelen voor	359698		
	bestelnr.	358119	fabrikantnr. —
	frame L 118mm B 72mm bevestigingsafstand 143mm voor lampaansluiting		
	bestelnr.	358122	fabrikantnr. —
	pakking L 112mm B 68mm silicone materiaaldikte 3mm voor lampaansluiting		
	bestelnr.	358123	fabrikantnr. —
	lampglas L 112mm B 68mm		
	bestelnr.	359612	fabrikantnr. —
	gloeilamp t.max. 300°C fitting E14 25W 230V ø 25mm L 56mm glas L 30mm voor ovenlamp type Philips		
	bestelnr.	359714	fabrikantnr. 1250020
	pakking silicone L 140mm B 75mm voor lampaansluiting		
	bestelnr.	359715	fabrikantnr. 1250019
	lampglas L 110mm B 65mm materiaaldikte 5mm		
	bestelnr.	359716	fabrikantnr. 1250018
	frame voor lampaansluiting		
Toebehoren voor	359698		
	bestelnr.	359612	fabrikantnr. —
	gloeilamp t.max. 300°C fitting E14 25W 230V ø 25mm L 56mm glas L 30mm voor ovenlamp type Philips		
	bestelnr.	359938	fabrikantnr. —
	borsalicaglas L 115mm B 69mm		



			
1			
bestelnr.	359716	fabrikantnr.	1250018
omschrijving	frame voor lampaansluiting		

			
1			
bestelnr.	359714	fabrikantnr.	1250020
omschrijving	pakking silicone L 140mm B 75mm voor lampaansluiting		

			
1			
bestelnr.	359698	fabrikantnr.	1250065
omschrijving	lampfitting L 100mm B 55mm fitting E14 aansluiting vlaksteker 6,3mm		
Reparatie-onderdelen voor	359698		
	bestelnr.	358119	fabrikantnr. —
	frame L 118mm B 72mm bevestigingsafstand 143mm voor lampaansluiting		
	bestelnr.	358122	fabrikantnr. —
	pakking L 112mm B 68mm silicone materiaaldikte 3mm voor lampaansluiting		
	bestelnr.	358123	fabrikantnr. —
	lampglas L 112mm B 68mm		
	bestelnr.	359612	fabrikantnr. —
	gloeilamp t.max. 300°C fitting E14 25W 230V ø 25mm L 56mm glas L 30mm voor ovenlamp type Philips		
	bestelnr.	359714	fabrikantnr. 1250020
	pakking silicone L 140mm B 75mm voor lampaansluiting		
	bestelnr.	359715	fabrikantnr. 1250019
	lampglas L 110mm B 65mm materiaaldikte 5mm		
	bestelnr.	359716	fabrikantnr. 1250018
	frame voor lampaansluiting		
Toebehoren voor	359698		
	bestelnr.	359612	fabrikantnr. —
	gloeilamp t.max. 300°C fitting E14 25W 230V ø 25mm L 56mm glas L 30mm voor ovenlamp type Philips		
	bestelnr.	359938	fabrikantnr. —
	borsalicaglas L 115mm B 69mm		

			
1			
bestelnr.	359715	fabrikantnr.	1250019
omschrijving	lampglas L 110mm B 65mm materiaaldikte 5mm		

verlichtingen

gloeilampen

			
1			
bestelnr.	359610	fabrikantnr.	1230009
omschrijving	gloeilamp t.max. 300°C fitting E14 15W 230V ø 22mm L 47mm glas L 20mm voor ovenlamp type Philips		

			
1			
bestelnr.	357153	fabrikantnr.	1250021
omschrijving	gloeilamp t.max. 300°C fitting E14 25W 230V ø 25mm L 55mm glas L 30mm voor oven type 120 1000		

halogeenlampen

voor fitting G4 / G6,35 / G9

			
1			
bestelnr.	359599	fabrikantnr.	42200007
omschrijving	halogeenlamp fitting G4 12V 20W temp. bestendigheid 500°C 250 2000		

fittingen

G4 / G5,3 / G6,35

			
1			
bestelnr.	359646	fabrikantnr.	42200008
omschrijving	lampfitting fitting G4/G5,3/G6,35 24V ø 17mm H 15mm aansluiting kabel 130mm bevestigingsafstand 26mm voor hologeelamp houderlengte 31mm kabellengte 130mm		



timers

programmatimers



1

bestelnr.	360645	fabrikantnr.	92000036
omschrijving	timer CDC 11901F motoren 1 kamers 1 looptijd 20s 230V 50/60Hz as \varnothing 6x4mm as L 25mm fabrikant nr. 11901F1CEE000.0000		



1

bestelnr.	360339	fabrikantnr.	41900007
omschrijving	timer FIBER P25 motoren 1 kamers 1 looptijd 20s 230V as \varnothing 6x4,6mm as L 20mm fabrikant nr. P255J01C1N4 motortype M51BJOR6400		

Reparatie-onderdelen voor 360339



bestelnr.	360673	fabrikantnr.	—
omschrijving	motor set tandwiel \varnothing 6.8mm tanden 15 230V spanning AC 50/60Hz draairichting rechtsom motor \varnothing 48mm H 18.5mm motortype UDS40NE1RNZ165 kabellengte 150mm met houder		

mechanische timers



1

bestelnr.	350008	fabrikantnr.	1250037
omschrijving	tijdschakelaar M2 met bel 2-polig looptijd 120min aandrijving mechanisch 2NO bij 250V 16A vaste positie ja as \varnothing 6x4,6mm as 6x4,6mm as L 24mm bevestigingsafstand 28mm aansluiting zijdelings		

alarmapparaten

zoemers



1

bestelnr.	350050	fabrikantnr.	1230015
omschrijving	zoemer 230VAC aansluiting vlaksteker 6,3mm schroefbevestiging draad M4 60dB		

magneetschakelaars

GENERAL ELECTRIC (AEG)

magneetschakelaars



1

bestelnr.	380262	fabrikantnr.	15500002
omschrijving	relais AC1 32A 230VAC (AC3/400V) 17A/7,5kW hoofdcontact 3NO hulpcontact 1NC aansluiting schroefaansluiting type AEG LS7K01A type GE CL02A 301 H 85mm		

LOVATO

magneetschakelaars



1

bestelnr.	380704	fabrikantnr.	92000046
omschrijving	relais AC1 20A 230VAC (AC3/400V) 9A/4kW hoofdcontact 3NO hulpcontact 1NC aansluiting schroefaansluiting type 11BG0901A230		

1

bestelnr.	380083	fabrikantnr.	16300011 92000044
omschrijving	relais AC1 25A 230VAC (AC3/400V) 9A/4,2kW hoofdcontact 3NO hulpcontact 1NC aansluiting schroefaansluiting type BF0901A230		

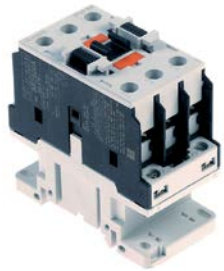

1

bestelnr.	380722	fabrikantnr.	92200003
omschrijving	relais AC1 56A 230VAC (AC3/400V) 32A/16kW hoofdcontact 3NO hulpcontact aansluiting schroefaansluiting type BF3200A230		

overbelastingsschakelaars



1

bestelnr.	381002	fabrikantnr.	1420005
omschrijving	maximaalstroombeveiliging instelbereik 1,8-2,5A		

motorbeveiligingsschakelaars



1

bestelnr.	382000	fabrikantnr.	1270009
omschrijving	motorbeschermerschakelaar type 3RU1116-1EBO instelbereik 2,8-4A (AC3/400V) 1.5kW		

SIEMENS

magneetschakelaars



1

bestelnr.	380645	fabrikantnr.	1260010
omschrijving	relais 230VAC met hulpcontact		



1

bestelnr.	380389	fabrikantnr.	1430006
omschrijving	relais AC1 22A 230VAC (AC3/400V) 9A/4kW hoofdcontact 3NO hulpcontact 1NO aansluiting schroefaansluiting type 3RT10-16-1AP01		

TELEMECANIQUE (Schneider Electric)

magneetschakelaars



1

bestelnr.	380820	fabrikantnr.	1130014
omschrijving	relais AC1 25A 230VAC (AC3/400V) 9A/4kW hoofdcontact 3NO hulpcontact 1NO/1NC aansluiting schroefaansluiting type LC1D0900M7		



solid state relais

CELDUC



1

bestelnr.	403040	fabrikantnr.	67401000
omschrijving	aansluitblok solidstate relais CELDUC fasen 1 25A 24-520V 4-30VDC L 58mm B 44mm schroefaansluiting type SC762110V 4-30VDC		

relais



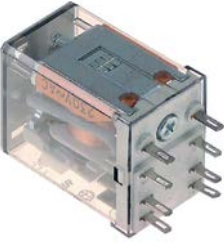

vermogensrelais

met steekcontacten

steekcontact 2,0mm







1

bestelnr.	380129	fabrikantnr.	41200002
omschrijving	vermogensrelais 24VAC 12A 2CO aansluiting F2 steekaansluiting 94.92.3 250V aansluiting 2mm		
Toebehoren voor	380129		
	bestelnr.	380341	fabrikantnr. —
	relaissokkel 4-polig contact 12 300V spanning AC 6A Italiana Relè fabrikant nr. ZMD4		
	bestelnr.	380378	fabrikantnr. —
	relaissokkel 2-polig 55/85 maat 70,5x30x27mm 250V spanning AC 10A FINDER fabrikant nr. 94.72		
	bestelnr.	380384	fabrikantnr. —
	relaissokkel 2-polig contact vlaksteker 2,8mm 250V spanning AC 10A B 23mm voor serie		
	bestelnr.	380399	fabrikantnr. —
	relaissokkel 4-polig maat 76,2x27x86,1mm 250V spanning AC 1A FINDER fabrikant nr. 94.94.3		



1

bestelnr.	380377	fabrikantnr.	43000001
omschrijving	vermogensrelais FINDER 220-240VAC 10A 2CO aansluiting F2 steekaansluiting fabrikant nr. 55.32.8.230.0000 94.92.3 250V		
Toebehoren voor	380377		
	bestelnr.	380341	fabrikantnr. —
	relaissokkel 4-polig contact 12 300V spanning AC 6A Italiana Relè fabrikant nr. ZMD4		
	bestelnr.	380378	fabrikantnr. —
	relaissokkel 2-polig 55/85 maat 70,5x30x27mm 250V spanning AC 10A FINDER fabrikant nr. 94.72		
	bestelnr.	380384	fabrikantnr. —
	relaissokkel 2-polig contact vlaksteker 2,8mm 250V spanning AC 10A B 23mm voor serie		
	bestelnr.	380399	fabrikantnr. —
	relaissokkel 4-polig maat 76,2x27x86,1mm 250V spanning AC 1A FINDER fabrikant nr. 94.94.3		

niveaurelais



1

bestelnr.	401224	fabrikantnr.	43700002
omschrijving	niveaurelais 230V aansluiting F6,3 type RL30/3ES/F/G		

tijdsrelais



1

bestelnr.	380329	fabrikantnr.	43000002
omschrijving	tijdsrelais FIBER 85.02.8.240 tijd bereik 0,05s - 100h 230-240VAC 10A inbouwmaat 20,6x27,7mm 2CO aansluiting 2,0		
Toebehoren voor	380329		
	bestelnr.	380378	fabrikantnr. —
	relaissokkel 2-polig 55/85 maat 70,5x30x27mm 250V spanning AC 10A FINDER fabrikant nr. 94.72		

Tabel wordt vervolgd op de volgende pagina



Toebehoren voor	380329		
	bestelnr.	380803	fabrikantnr.
	—		
	relaissokkel 2-polig maat 76,2x27x86,1mm 250V spanning AC 10A FINDER fabrikant nr. 94.92.3		



bestelnr.	380639	fabrikantnr.	41100005
omschrijving	tijdrelais TECHNOLOGIC RTR12DS06S tijdbereik 6s 230VAC 5A inbouwmaat 34x34mm 1CO aansluiting steekaansluiting rond 8-polig		
Toebehoren voor	380639		
	bestelnr.	380638	fabrikantnr.
	—		
	relaissokkel 8-polig maat 51x41x23mm 250V 10A FINDER fabrikant nr. 90.26		



bestelnr.	380640	fabrikantnr.	41100006
omschrijving	tijdrelais TECHNOLOGIC RTR12DS60S tijdbereik 60s 230VAC 5A 1CO aansluiting steekaansluiting rond 8-polig		
Toebehoren voor	380640		
	bestelnr.	380638	fabrikantnr.
	—		
	relaissokkel 8-polig maat 51x41x23mm 250V 10A FINDER fabrikant nr. 90.26		

transformatoren

open transformatoren

met klemaansluitingen



bestelnr.	403905	fabrikantnr.	92000016
omschrijving	transformator primair 230V/50-60Hz secundair 12V 50VA aansluiting schroefaansluiting type T1ULF		

met steekverbinding



bestelnr.	400956	fabrikantnr.	92000045
omschrijving	transformator primair 230VAC secundair 12VAC 20VA aansluiting vlaksteker 6,3mm 50/60Hz type T602012/E temp. begrenzing 150°C omgevingstemperatuur max. 80°C		





elektronische regelaars

EVCO - EVERY CONTROL

universele regelaars

inbouwversies



bestelnr.	378131	fabrikantnr.	1230020
omschrijving	elektronische regelaar EVERY CONTROL EVK411M inbouwmaat 71x29mm 12V spanning AC/DC NTC/PTC/Pt100/Pt1000 relaisuitgang 1 CO-16A(8) NTC/PTC/Pt100/Pt1000/TC(J,K)/mV/mA ja bescherming IP65 afhankelijk van voeler ² C beeldscherm 3½ digits		
Toebehoren voor	378131		
	bestelnr.	379050	fabrikantnr.
	—		
	temperatuurvoeler Pt100 kabel Vetrotex voeler -200 tot +600°C kabel -50 tot +350°C voeler ø6x100mm kabel lengte 2.7m zonder schroefaansluiting 3-aderig		
	bestelnr.	379160	fabrikantnr.
	—		
	temperatuurvoeler NTC 10kOhm kabel thermoplast voeler -40 tot +110°C kabel -40 tot +110°C voeler ø6x14mm kabel lengte 1.5m zonder schroefaansluiting 2-aderig		
	bestelnr.	379781	fabrikantnr.
	—		
	temperatuurvoeler PTC 1kOhm kabel thermoplast voeler -50 tot +150°C kabel -40 tot +110°C voeler ø6x14mm kabel lengte 1.5m zonder schroefaansluiting 2-aderig		
	bestelnr.	379944	fabrikantnr.
	—		
	temperatuurvoeler Pt1000 kabel Vetrotex voeler -70 tot +500°C kabel -50 tot +350°C aansluiting 2-aderig draad voeler ø6x180mm kabel lengte 1.7m		



voelers

universele voelers

temperatuurvoelers



bestelnr.	379052	fabrikantnr.	44300002
omschrijving	temperatuurvoeler PTC 1kOhm kabel silicone voeler -50 tot +150°C kabel -50 tot +180°C voeler ø6x40mm kabellengte 1.5m zonder schroefaansluiting 2-aderig		

fabrikantspecifieke voelers

voelers



bestelnr.	402154	fabrikantnr.	1460011
omschrijving	temperatuurvoeler Pt100 kabel silicone voeler -100 tot +450°C kabel -50 tot +180°C aansluiting 3-aderig draad 1/8" voeler ø6x35mm kabellengte 1.5m		



bestelnr.	379331	fabrikantnr.	92000004
omschrijving	temperatuurvoeler Pt1000 kabel PTFE voeler -70 tot +500°C kabel -40 tot +250°C aansluiting 2-aderig draad M10x1 voeler ø3x60mm kabellengte 0.7m		

insteekvoeler



bestelnr.	379945	fabrikantnr.	4270004
omschrijving	kerntemperatuurvoeler Pt100 kabel PTFE voeler -40 tot +250°C kabel -40 tot +250°C aansluiting steker voeler ø3,5x-100mm draad kabellengte 0.5m greep ø 10mm greeplengte 80mm		



bestelnr.	379946	fabrikantnr.	011915 4270001
omschrijving	kerntemperatuurvoeler Pt100 kabel PTFE voeler -40 tot +250°C kabel -40 tot +250°C aansluiting steker voeler ø3,5x-100mm draad kabellengte 0.7m greep ø 10mm greeplengte 80mm		



bestelnr.	379947	fabrikantnr.	42300004
omschrijving	kerntemperatuurvoeler Pt100 kabel PTFE voeler -40 tot +250°C kabel -40 tot +250°C aansluiting steker voeler ø3,5x-100mm draad kabellengte 1.2m greep ø 10mm greeplengte 80mm		

elektronica

printplaten

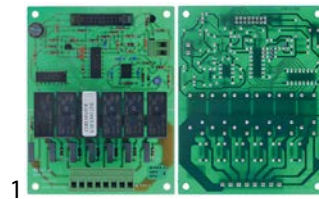

bestelnr.	403953	fabrikantnr.	005736 49200003
omschrijving	controleprint L 119mm B 93mm CQC411(24)		



bestelnr.	404028	fabrikantnr.	92100004
omschrijving	printplaat voor heteluchtoven ANGELO PO L 140mm B 100mm		

magneetventielen

magneetventielen voor water

ELBI

recht



bestelnr.	373017	fabrikantnr.	1230013
omschrijving	magneetventiel enkel recht 230VAC ingang 3/4" uitgang 11,5mm DN10 ELBI		
Reparatie-onderdelen voor	373017		
	bestelnr.	370467	fabrikantnr. —
	magneetventielzeef passend voor ELBI		

RPE

verlopen

uitgangzijde



bestelnr.	371269	fabrikantnr.	009006 1250022
omschrijving	reducer doorstroomsnelheid 0,07-0,14l/min bruin		



			
1			
bestelnr.	371266	fabrikantnr.	008887 1250009
omschrijving	reducerer doorstroomsnelheid 0.2l/min rood		

magneetventielen met reducering			
4-voudig			
			
1			
bestelnr.	374111	fabrikantnr.	1450003
omschrijving	magneetventiel 4-maal recht 230VAC ingang 3/4" uitgang 10.5 inschakeltijd 100% RPE type H drukbereik 0,2-10bar		

TP			
magneetventielen met reducering			
			
1			
bestelnr.	370648	fabrikantnr.	92000030 92000031
omschrijving	magneetventiel dubbel recht 220-240VAC ingang 3/4" ingang 10l/min DN10 TP uitgang 11.5mm uitgang A 3.4l/min reducering uitgang A groen		



			
1			
bestelnr.	370628	fabrikantnr.	1240007
omschrijving	magneetventiel dubbel recht 230VAC ingang 3/4" ingang 16l/min DN10 TP kunststof uitgang 11.5mm		

kogelkranen elektrisch

			
1			
bestelnr.	401233	fabrikantnr.	43000004
omschrijving	kogelkraan ingang 1/2" ID uitgang 1/2" ID 230V 50/60Hz werkingsmodus elektrisch B 60mm H 99mm kabel 4-polig 2.5W 4-polig inschakeltijd 50%		

pressostaten

voor combi-steamers

			
1			
bestelnr.	541806	fabrikantnr.	92000033
omschrijving	pressostaat ø 38mm drukbereik 0,2-3,0bar aansluiting 1/8" 250V 10A GP600 drukaansluiting 1/8"		
Toebehoren voor	541806		
	bestelnr.	fabrikantnr.	—
	beschermkap voor pressostaat EPDM XP600		

elektroden

			
1			
bestelnr.	401161	fabrikantnr.	43000007
omschrijving	niveau elektrode 1/4" totale lengte 210mm voeler L 184mm voelerlengte geïsoleerd 26mm aansluiting vlaksteker 6,3mm RVS ø 2.5mm		

			
1			
bestelnr.	401225	fabrikantnr.	1250012
omschrijving	niveau elektrode M12 OD - 1/8" OD totale lengte 124/127/139mm voeler L 91/95/104mm voelerlengte geïsoleerd 42mm 3-delige set aansluiting vlaksteker 6,3mm ø 2.5mm		

			
1			
bestelnr.	401226	fabrikantnr.	1260005
omschrijving	niveau elektrode M12x1 totale lengte 150/160/171mm voeler L 117/127/138mm voelerlengte geïsoleerd 20mm 3-delige set aansluiting vlaksteker 6,3mm ø 2.5mm		





ventilatoren

axiaalventilatoren

Import



bestelnr.	601080 ¹	fabrikantnr.	42300006
omschrijving	axiaalventilator L 119mm B 119mm H 38mm 230VAC 50/60Hz 23/20W lager kogellager aansluiting vlaksteker 2,8mm metaal ADDA ventilatorblad ø 110mm temp. bestendigheid 70°C		
Toebehoren voor	601080		
	bestelnr.	550898	fabrikantnr. —
	aansluitkabel kabellengte 2000mm aansluiting F 2,8 aansluitafstand 7.9mm voor axiaalventilator		
	bestelnr.	692519	fabrikantnr. —
	beschermrooster L 120mm B 120mm kunststof		

¹met kogellager



bestelnr.	601130 ¹	fabrikantnr.	41100009
omschrijving	axiaalventilator L 80mm B 80mm H 25mm 230VAC 50/60Hz 13/14W lager kogellager aansluiting vlaksteker 2,8mm metaal ADDA ventilatorblad ø 75mm temp. bestendigheid 70°C vermogen 30.6m³/h		
Toebehoren voor	601130		
	bestelnr.	550898	fabrikantnr. —
	aansluitkabel kabellengte 2000mm aansluiting F 2,8 aansluitafstand 7.9mm voor axiaalventilator		

¹met kogellager

heteluchtmotoren



bestelnr.	511172	fabrikantnr.	43000045
omschrijving	asafdichting ID ø 24mm OD ø 29mm materiaaldikte 3mm		

bestelnr.	691810	fabrikantnr.	002067 43000043
omschrijving	flens voor ventilatormotor OD ø 48mm binnen ø 1 19.5mm binnen ø 2 15mm materiaaldikte 3.5mm koper		

bestelnr.	550858	fabrikantnr.	002101 43000046
omschrijving	flens voor ventilatormotor OD ø 60mm binnen ø 1 28.5mm binnen ø 2 25mm materiaaldikte 4mm koper		

bestelnr.	550686	fabrikantnr.	90200030
omschrijving	pakking voor ventilatormotor ID ø 12mm OD ø 58mm materiaaldikte 1mm met 3 schroefgaten		

bestelnr.	511171	fabrikantnr.	43000042
omschrijving	simmerring ID ø 14.5mm OD ø 20mm materiaaldikte 3mm		

bestelnr.	550757	fabrikantnr.	002080 43000044
omschrijving	tegenflens voor ventilatormotor OD ø 48mm binnen ø 1 24mm binnen ø 2 15mm materiaaldikte 5mm koper		

bestelnr.	550859	fabrikantnr.	002115 43000047
omschrijving	tegenflens voor ventilatormotor OD ø 60mm binnen ø 1 34mm binnen ø 2 25mm materiaaldikte 6mm koper		



1



bestelnr.	601067	fabrikantnr.	41100010
omschrijving	ventilatorblad D1 ø 150mm H1 38mm messen 36 D2 ø 6mm D3 ø 6mm H2 14mm		

1



bestelnr.	601060	fabrikantnr.	1250014
omschrijving	ventilatorblad D1 ø 180mm H1 60mm messen 16 D2 ø 11mm D3 ø 16mm H2 30mm		

1



bestelnr.	601064	fabrikantnr.	44700002
omschrijving	ventilatorblad D1 ø 220mm H1 78mm messen 20 D2 ø 11.5mm D3 ø 16.5mm H2 30mm		

1



bestelnr.	601224	fabrikantnr.	1260007
omschrijving	ventilatorblad D1 ø 300mm H1 100mm messen 24 D2 ø 19.5mm D3 ø 23mm H2 46mm		

1



bestelnr.	601063	fabrikantnr.	1410004
omschrijving	ventilatorblad D1 ø 350mm H1 100mm messen 24 D2 ø 19.5mm D3 ø 23mm H2 46mm		

1

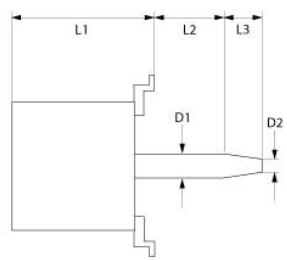



bestelnr.	601046	fabrikantnr.	1240004
omschrijving	ventilatormotor 220/380V fasen 3 50/60Hz 0.75kW 1350/1650U/min snelheid 1 L1 185mm L2 42mm L3 47mm D1 ø 24mm D2 ø 20mm M12L ID 1,9/3,3A Cos(fi) 0.83 bij 50Hz 200-240/346-415V bij 60Hz 200-277/346-480V bij 50Hz 1350U/min bij 60Hz 1650U/min type ST80/4 nr. 661512		

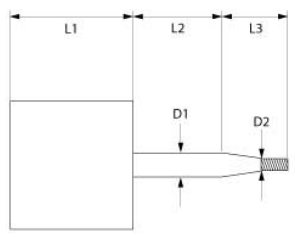

1

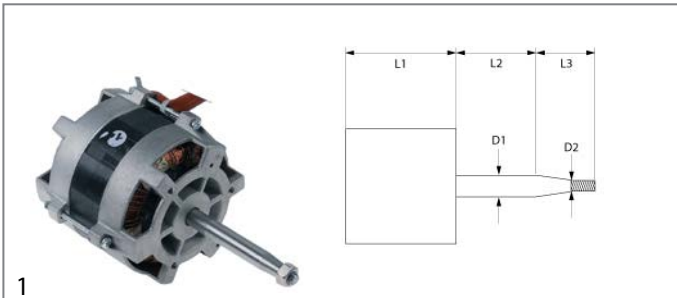



bestelnr.	601043	fabrikantnr.	008939 1250015	
omschrijving	ventilatormotor 220-240V fasen 1 50Hz 0,37/0,07kW 0,1/0,5PS 1400/2700U/min snelheid 2 L1 123mm L2 107mm L3 15mm D1 ø 15mm D2 ø 12mm M10L OD 2/0,7A passende condensator 20µF/250V bij 50Hz 1400/2700U/min type 1057			
Toebehoren voor	601043			
	bestelnr.	365019	fabrikantnr.	—
		bedrijfscondensator capaciteit 20µF 400V bekercondensator tolerantie 5% 50/60Hz omgevingstemperatuur max. -25 tot +85°C ø 39.5mm L 70mm dubbele aansluiting M8 kunststof aansluiting vlaksteker 6,3mm 16.10.25. bescherming		

1

bestelnr.	601166	fabrikantnr.	44700005
omschrijving	ventilatormotor 220-240V fasen 1 50Hz 0.37kW 2700U/min snelheid 1 L1 123mm L2 77mm L3 30mm D1 ø 15mm D2 ø 12mm M10L OD 2A passende condensator 12,5µF/450V bij 50Hz 2700U/min type 1057.2157		
Reparatie-onderdelen voor	601166		
	bestelnr.	365014	fabrikantnr. —
	bedrijfscondensator capaciteit 12,5µF 450V bekercondensator tolerantie 5%Hz omgevingstemperatuur max. -25 tot +85°C ø 35mm L 70mm dubbele aansluiting M8 kunststof aansluiting vlaksteker 6,3mm 45S.C3DS.12,5 bescherming		
Toebehoren voor	601166		
	bestelnr.	601165	fabrikantnr. —
	ventilatorblad D1 ø 160mm H1 60mm messen 15 D2 ø 16mm D3 ø 16mm H2 29mm		



1

bestelnr.	602175	fabrikantnr.	92000040
omschrijving	ventilatormotor 230/400V fasen 3 50/60Hz 0.7kW 1400/1700U/min L1 150mm L2 80mm L3 32mm D1 ø 18mm D2 ø 15mm M8 passende condensator 3µF400V type 3042P4050		



heteluchtventilatoren

overigen

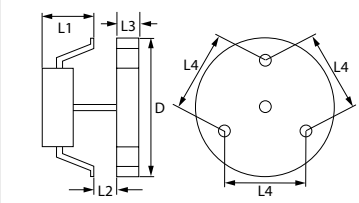

1



bestelnr.	601011	fabrikantnr.	1510006
omschrijving	heteluchtventilator 220-240V 40W 50/60Hz L1 65mm L2 15mm L3 25mm L4 87mm ventilatorblad ø 150mm FIME type C25R8023CLH		
Toebehoren voor	601011		
	bestelnr.	550879	fabrikantnr. —
	isolatie ø 130mm materiaaldikte 3mm gat ø 18mm voor heteluchtventilator		
	bestelnr.	601260	fabrikantnr. —
	moer draad M6S ID voor heteluchtventilator		

1

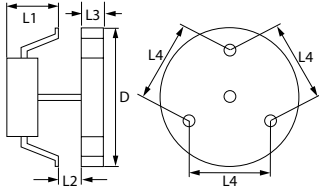

bestelnr.	601125	fabrikantnr.	1270016
omschrijving	heteluchtventilator 220-240V 45W 50/60Hz L1 70mm L2 11mm L3 25mm L4 87mm ventilatorblad ø 150mm FIME type C30R0479CLF		
Toebehoren voor	601125		
	bestelnr.	550879	fabrikantnr. —
	isolatie ø 130mm materiaaldikte 3mm gat ø 18mm voor heteluchtventilator		

pompen

afvoerpompen

ASKOLL



1

bestelnr.	500565	fabrikantnr.	1250030
omschrijving	afvoerpomp 30W		

condensatoren & ontstoringsfilters

bedrijfscondensatoren

kunststof



1

bestelnr.	365022	fabrikantnr.	90400011
omschrijving	bedrijfscondensator capaciteit 40µF 400V bekercondensator tolerantie 5%Hz omgevingstemperatuur max. -25 tot +85°C ø 45mm L 95mm dubbele aansluiting M8 kunststof aansluiting vlakstecker 6,3mm bescherming		

elektra toebehoren

kabels

aardedraad



1

bestelnr.	104684	fabrikantnr.	90200015
omschrijving	massakabel aansluiting F2,8mm / oog M5 kabellengte 350mm 1.5mm ²		

klemmen

porseleinklemmen



1

bestelnr.	550112	fabrikantnr.	32100015
omschrijving	porseleinen kroonsteen 2-polig 2.5mm ² max. 10A max. spanning 250V t.max. 200°C L 22mm B 17mm H 15mm bevestigingsafstandmm vpe 1stuk		

gasventielen en branderautomaten

gasregelventielen

SIT

NOVASIT

toebehoren







1









bestelnr.	100905	fabrikantnr.	00131131 43000018
omschrijving	klemschroef M10x1 voor pijpø 6mm vpe 1stuk		

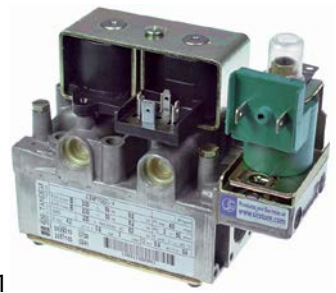



			
1			
bestelnr.	101312	fabrikantnr.	1390009
omschrijving	microschakelaar		

SIGMA			
			
1			
bestelnr.	107894	fabrikantnr.	92100003
omschrijving	gasventiel type 0848083 230V 50Hz gasingang 3/4" gasuitgang 3/4" drukbereik 0,5-12mbar met reduceer 1/2" - 3/4"		

			
1			
bestelnr.	107498	fabrikantnr.	43000009
omschrijving	gasventiel type Sigma 230V 50Hz gasingang 1/2" gasuitgang 1/2" drukbereik 2-50mbar		
Reparatie-onderdelen voor	107498		
	bestelnr.	106214	fabrikantnr. 90200020
	magneetspoel 230V 50Hz Sigma		
Toebehoren voor	107498		
	bestelnr.	107222	fabrikantnr. —
	steker voor magneetventiel 3-polig kabellengte 1070mm		

TANDEM			
			
1			
bestelnr.	101984	fabrikantnr.	1440007
omschrijving	gasventiel 230V 50Hz gasingang 1/2" gasuitgang 1/2" waakvlamaansluiting niveau langzame ontsteking ontstekingsduurs drukbereik 2-50mbar voedingsstroom voor modulator 230VAC gecorrigeerd Tandem vergelijkingsnr. 0.836.010		
Reparatie-onderdelen voor	101984		
	bestelnr.	101379	fabrikantnr. —
	magneetspoel 230V 50Hz passend voor Tandem		
Toebehoren voor	101984		
	bestelnr.	101274	fabrikantnr. —
	snijring voor pijpø 16mm vpe 1stuk		
	bestelnr.	101275	fabrikantnr. —
	knelschroef draad 1/2" voor pijpø 16mm vpe 1stuk		
	bestelnr.	101925	fabrikantnr. —
	plug met o-ring draad M10x1 voor ontstekingsbrander passend voor NOVASIT		
	bestelnr.	102845	fabrikantnr. —
	gasaansluiting haaks 1/2" flens 32x32mm LA 24x24mm Tandem		
	bestelnr.	102846	fabrikantnr. —
	gasaansluiting recht 1/2" flens 32x32mm LA 24x24mm passend voor Tandem		
	bestelnr.	102847	fabrikantnr. —
	O-ring		

gasontstekingsautomaten

HONEYWELL			
			
1			
bestelnr.	101165	fabrikantnr.	1440006
omschrijving	gasbranderautomat HONEYWELL type S4560A 1008 vergelijkingsnr. S4560A 1008 elektroden 1 wachttijd 0s beveiligingstijd 10s 220-240V 10VA 50Hz		
Reparatie-onderdelen voor	101165		
	bestelnr.	358696	fabrikantnr. —
	fijnzekering grootte ø5x20mm 4A middeltraag maximale spanning 250V vpe 10stuk		



Honeywell



1

bestelnr.	102367	fabrikantnr.	43000031
omschrijving	gasbranderautomat HONEYWELL type S4565A 2092 1 elektroden 3 wachttijds beveiligingstijd 10s 220-240V 4VA 50/60Hz		

SIT



1

bestelnr.	102309	fabrikantnr.	43000008
omschrijving	gasbranderautomat SIT type 537ABC elektroden 3 wachttijd 1.5s beveiligingstijd 10s 230V 10VA 50-60Hz bescherming IP44		

ontstekingstechniek

waakvlambranders













SIT

serie 100



1

bestelnr.	106906	fabrikantnr.	00106039
omschrijving	waakvlambrander SIT type serie 100 3-vlammig sproeier ø 0.2mm gasaansluiting 6mm		
Reparatie-onderdelen voor 106906			
	bestelnr.	100245	fabrikantnr. —
	waakvlaminspuiter flessengas identificatienummer 20 boring ø 0.2mm vpe 1stuk draad M8x0,75		
	bestelnr.	100855	fabrikantnr. —
	waakvlambranderhouder drievoudig		
	bestelnr.	100885	fabrikantnr. —
	menghuls voor ontstekingsbrander vpe 1stuk		
	bestelnr.	100916	fabrikantnr. —
	drukveer voor ontstekingsbrander vpe 1stuk		
	bestelnr.	100917	fabrikantnr. —
	pakking voor ontstekingsbrander vpe 1stuk aluminium ID ø 8.5mm OD ø 11mm materiaaldikte 1.2mm		

Reparatie-onderdelen voor 106906			
	bestelnr.	100918	fabrikantnr. —
	schroef voor ontstekingsbrander		
	bestelnr.	107162	fabrikantnr. —
	waakvlambrander bovendeel SIT 3-vlammig Hmm Lmm vpe 1stuk		
	bestelnr.	107701	fabrikantnr. —
	waakvlambranderonderstuk SIT serie 100 sproeier ø 0.2mm		
Toebehoren voor 106906			
	bestelnr.	100245	fabrikantnr. —
	waakvlaminspuiter flessengas identificatienummer 20 boring ø 0.2mm vpe 1stuk draad M8x0,75		
	bestelnr.	100246	fabrikantnr. —
	waakvlaminspuiter aardgas boring ø 0.35mm vpe 1stuk draad M8x0,75		
	bestelnr.	100904	fabrikantnr. —
	klemschroef M10x1 voor pijp ø 4mm vpe 1stuk		
	bestelnr.	100905	fabrikantnr. 00131131 43000018
	klemschroef M10x1 voor pijp ø 6mm vpe 1stuk		
	bestelnr.	102110	fabrikantnr. —
	waakvlamleiding koper pijp ø 4mm dikte 1mm L 3000mm		
	bestelnr.	102111	fabrikantnr. —
	waakvlamleiding koper pijp ø 6mm dikte 1mm L 3000mm		
	bestelnr.	107171	fabrikantnr. —
	waakvlaminspuiter SIT aardgas/flessengas boring ø 0.25mm vpe 1stuk		
	bestelnr.	107700	fabrikantnr. —
	waakvlambranderonderstuk SIT serie 100 sproeier ø 0.25mm		
	bestelnr.	107702	fabrikantnr. —
	waakvlambranderonderstuk SIT serie 100 sproeier ø 0.35mm		

toebehoren

ontstekingselektroden

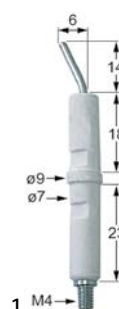















bestelnr.	100706	fabrikantnr.	40100008
omschrijving	bougie aansluiting M4 vpe 1stuk		

2 gas componenten





serie 160

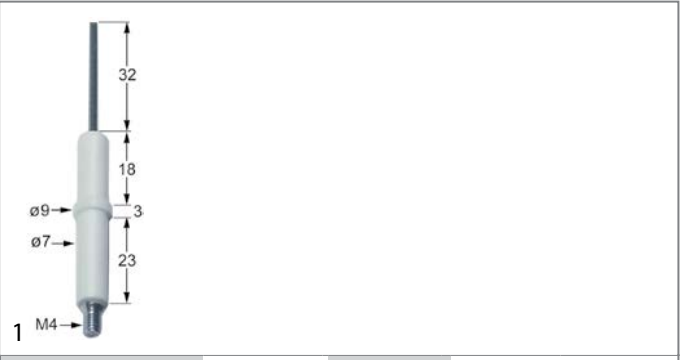

bestelnr.	100056	fabrikantnr.	00142184
omschrijving	waakvlambrander SIT type serie 160 3-vlammig sproeier ømm gasaansluitingmm		
Reparatie-onderdelen voor	100056		
	bestelnr.	100907	fabrikantnr. —
	schroefconnectie draad M10x1 vpe 1stuk type SEF 1 ømm voor thermokoppel		
Toehoren voor	100056		
	bestelnr.	100202	fabrikantnr. —
	waakvlaminspuiters aardgas identificatienummer 41 vpe 1stuk sproeier ø 0.41mm		
	bestelnr.	100203	fabrikantnr. 00150220
	waakvlaminspuiters flessengas identificatienummer 25 vpe 1stuk sproeier ø 0.25mm		
	bestelnr.	100701	fabrikantnr. 00142187
	bougie aansluiting M4 vpe 1stuk		
	bestelnr.	100801	fabrikantnr. —
	pakking voor ontstekingsbrander vpe 1stuk		
	bestelnr.	100869	fabrikantnr. 00142186
	waakvlaminspuiters aardgas identificatienummer 51 vpe 1stuk passend voor serie 160 sproeier ø 0.51mm		
	bestelnr.	100870	fabrikantnr. —
	snijring voor pijpø 4mm vpe 1stuk passend voor serie 160 voor ontstekingsbrander		
	bestelnr.	100906	fabrikantnr. —
	schroefconnectie draad M10x1 voor ontstekingsselektrode koper vpe 1stuk SB 10		
	bestelnr.	100908	fabrikantnr. —
	knelschroef draad M10x1 voor pijpø 4mm vpe 1stuk		
	bestelnr.	100909	fabrikantnr. —
	knelschroef draad M10x1 voor pijpø 6mm vpe 1stuk		
	bestelnr.	101287	fabrikantnr. 00142188
	snijring voor pijpø 6mm vpe 1stuk		
	bestelnr.	102110	fabrikantnr. —
	waakvlamleiding koper pijp ø 4mm dikte 1mm L 3000mm		
	bestelnr.	102111	fabrikantnr. —
	waakvlamleiding koper pijp ø 6mm dikte 1mm L 3000mm		
	bestelnr.	107650	fabrikantnr. —
	waakvlaminspuiters SIT flessengas identificatienummer 30 vpe 1stuk		

elektroden



bestelnr.	100701	fabrikantnr.	00142187
omschrijving	bougie aansluiting M4 vpe 1stuk		
Toehoren voor	100701		
	bestelnr.	100906	fabrikantnr. —
	schroefconnectie draad M10x1 voor ontstekingsselektrode koper vpe 1stuk SB 10		



bestelnr.	100706	fabrikantnr.	40100008
omschrijving	bougie aansluiting M4 vpe 1stuk		



bestelnr.	102871	fabrikantnr.	64100005
omschrijving	bougie D1 ø 7mm D2 ø 9mm aansluiting M4 L1 8mm LL1 18mm LL2 3mm LL3 23mm voor het klemmen		

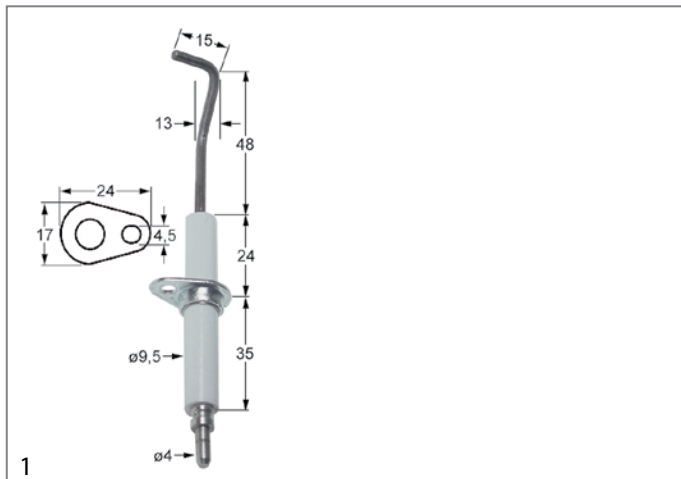

bestelnr.	102342	fabrikantnr.	43000026
omschrijving	bougie flens L 24mm flens B 17mm D1 ø 9,5mm L1 48mm L2 13mm L3 15mm LL1 24mm LL2 35mm bevestigingsmaat ø4,5mm met flens aansluit ø 4mm		



bestelnr.	104799	fabrikantnr.	92900003
omschrijving	bougie set flens L 56mm flens B 22mm D1 ø 9x62mm D2 ø 9x62mm L1 130mm L2 140mm		



bestelnr.	103287	fabrikantnr.	92100002
omschrijving	bougie set flens L 56mm flens B 22mm D1 ø 3mm D2 ø 9,5mm bevestigingsafstand 47mm		

ontstekingskabels

ontstekingskabels



bestelnr.	102180	fabrikantnr.	00106042
omschrijving	ontstekingskabel kabellengte 1200mm aansluiting ø2,4mm / ø2,4mm		



bestelnr.	102187	fabrikantnr.	90200014
omschrijving	ontstekingskabel kabellengte 300mm aansluiting ø4mm / F2,8mm		



bestelnr.	102162	fabrikantnr.	91100002
omschrijving	ontstekingskabel kabellengte 400mm aansluiting F2,8mm / F6,3mm		



bestelnr.	100025	fabrikantnr.	40100009
omschrijving	ontstekingskabel kabellengte 600mm aansluiting ø4mm / F6,3mm		

ontstekingsgroepen



bestelnr.	103334	fabrikantnr.	90200013
omschrijving	ontstekingsgroep uitgangen 2 220-240VAC maat 83x42x-32mm bevestigingsafstand 34mm ingang F2,8 uitgang F2,8 type TSM 17VA 50/60Hz		

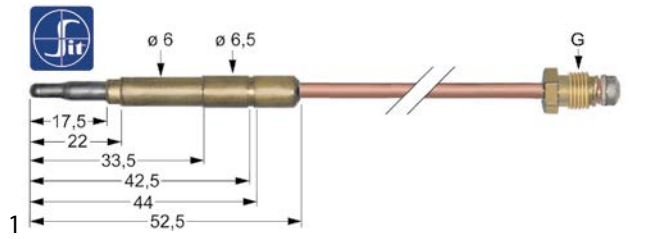

bestelnr.	101002	fabrikantnr.	1430008
omschrijving	ontstekingsgroep uitgangen 2 230VAC maat 88x23x34mm bevestigingsafstand 73mm ingang F6,3x0,8 uitgang F2,8x0,8 0.6VA 50/60Hz		

**thermokoppels****insteekthermokoppels****insteekthermokoppels standaard**met steekhuls $\varnothing 6(6,5)$ mm**thermokoppels SIT**

bestelnr.	107615	fabrikantnr.	24204026
omschrijving	thermokoppel SIT M10x1 L 320mm steekhuls $\varnothing 6,0(6,5)$ mm		

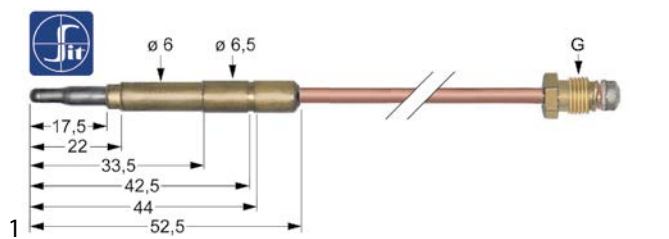

bestelnr.	107600	fabrikantnr.	00100095
omschrijving	thermokoppel SIT M8x1 L 320mm steekhuls $\varnothing 6,0(6,5)$ mm		

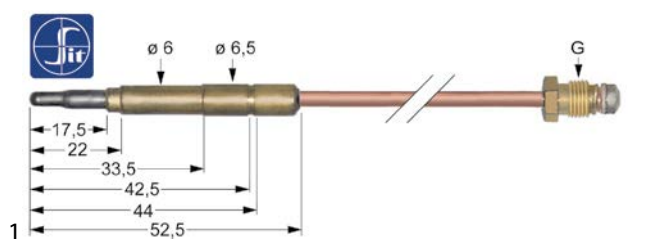

bestelnr.	107612	fabrikantnr.	00106040
omschrijving	thermokoppel SIT M9x1 L 1000mm steekhuls $\varnothing 6,0(6,5)$ mm		

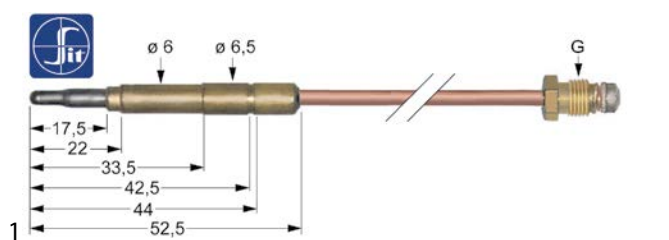

bestelnr.	107613	fabrikantnr.	25100058
omschrijving	thermokoppel SIT M9x1 L 1200mm steekhuls $\varnothing 6,0(6,5)$ mm		

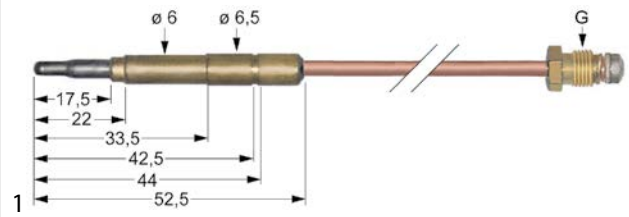
thermokoppels met gealuminiseerde top

bestelnr.	102037	fabrikantnr.	50100032
omschrijving	thermokoppel M8x1 L 1200mm steekhuls $\varnothing 6,0(6,5)$ mm		

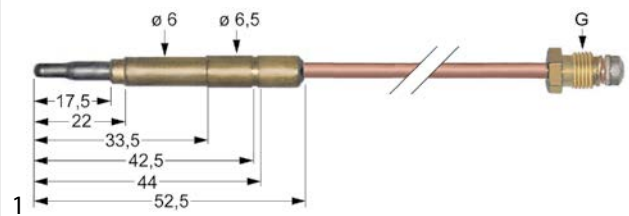

bestelnr.	102038	fabrikantnr.	51600020
omschrijving	thermokoppel M8x1 L 1500mm steekhuls $\varnothing 6,0(6,5)$ mm		

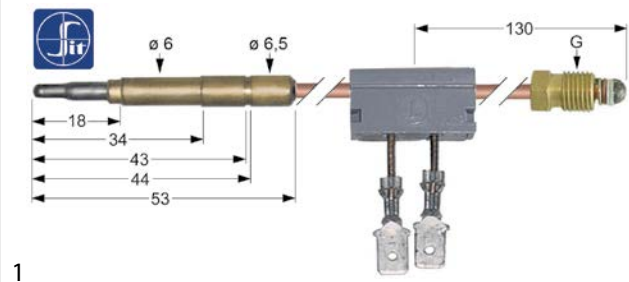
insteekthermokoppels met onderbreking

bestelnr.	107177	fabrikantnr.	9400051
omschrijving	thermokoppel SIT met onderbreker M9x1 L 600mm steekhuls $\varnothing 6,0$ mm F 6,3mm		

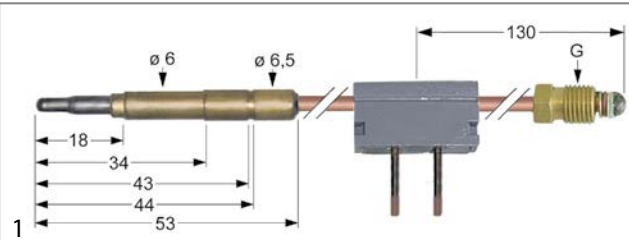

bestelnr.	102069	fabrikantnr.	09500065
omschrijving	thermokoppel met onderbreker M9x1 L 600mm steekhuls $\varnothing 6,0$ mm soldeeraansluiting		

gas componenten

2





schroefthermokoppels

inschroefthermokoppels standaard

met schroefhuls M8x1

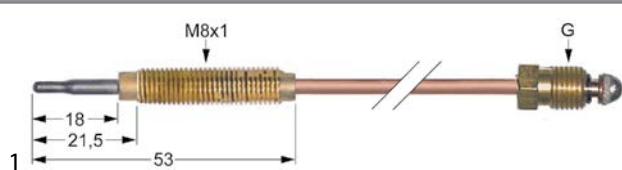
type Junkers met gealuminiseerde top



bestelnr.	102058	fabrikantnr.	04700019
omschrijving	thermokoppel M8x1 L 1000mm M8x1		
Toebehoren voor	102058		
	bestelnr.	102067	fabrikantnr.
	moer draad M8x1 H 3mm koper vpe 1stuk type SEF 1		

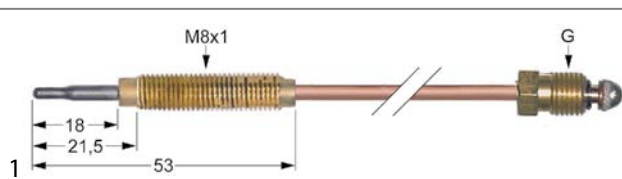

bestelnr.	102057	fabrikantnr.	04700018
omschrijving	thermokoppel M8x1 L 850mm M8x1		
Toebehoren voor	102057		
	bestelnr.	102067	fabrikantnr.
	moer draad M8x1 H 3mm koper vpe 1stuk type SEF 1		

thermogeneratoren

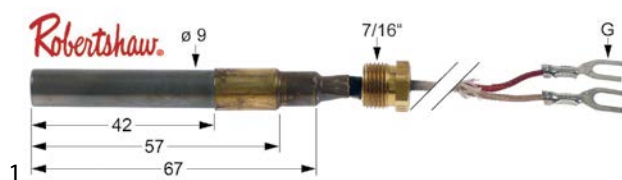

bestelnr.	102116	fabrikantnr.	64100008
omschrijving	thermogenerator ROBERTSHAW L 900mm voeler ø 9mm voeler L 57mm 250-750mV schroefaansluiting 7/16"		

gasbranders

staaftbranders

staaftbranders



bestelnr.	105788	fabrikantnr.	1440002
omschrijving	staaftbrander 1-rij ø 50mm Bmm Hmm L 483mm flens B 71mm heteluchtoven flens ø 75mm		



bestelnr.	105790	fabrikantnr.	008017 1430002
omschrijving	staaftbrander ø 50mm Bmm Hmm L 325mm flens B 57mm flens L 57mm heteluchtoven		

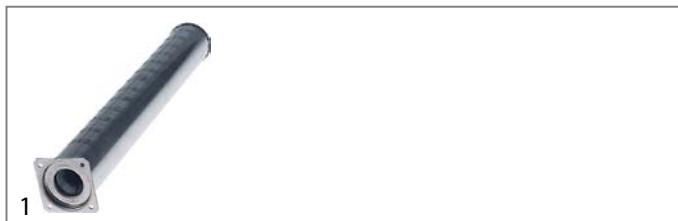

bestelnr.	105791	fabrikantnr.	67500001
omschrijving	staaftbrander ø 50mm Bmm Hmm L 375mm flens B 57mm flens L 57mm heteluchtoven		



bestelnr.	105789	fabrikantnr.	1450001
omschrijving	staaftbrander ø 50mm Bmm Hmm L 618mm flens B 71mm heteluchtoven flens ø 75mm		

gasinspuiters

hoofdinspuiters

gasinspuiters M13x1



bestelnr.	104737	fabrikantnr.	90200025
omschrijving	gasinspuitter draad M8x1 SB 10 boring ø 0.5mm		

gasinspuiters M9x1



bestelnr.	100503	fabrikantnr.	20111020
omschrijving	gasinspuitter draad M9x1 SB 10 boring ø 1.1mm		

gas componenten



1

bestelnr.	100502	fabrikantnr.	21107011
------------------	--------	---------------------	----------

omschrijving	gasinspuiter draad M9x1 SB 10 boring ø 1mm		
---------------------	--	--	--

gasinspuiter M10x1



1

bestelnr.	100638	fabrikantnr.	1390003
------------------	--------	---------------------	---------

omschrijving	gasinspuiter draad M10x1 SB 11 boring ø 1.15mm binnenkant spits		
---------------------	---	--	--



1

bestelnr.	106287	fabrikantnr.	43000027
------------------	--------	---------------------	----------

omschrijving	gasinspuiter draad M10x1 SB 11 boring ø 2.2mm binnenkant spits		
---------------------	--	--	--

waakvlambranderinspuiter

waakvlambranderinspuiter AB



1

bestelnr.	100201	fabrikantnr.	00142185
------------------	--------	---------------------	----------

omschrijving	waakvlaminspuiter PRO-GAS flessengas identificatienummer 30 vpe 1stuk sproeier ø 0.3mm		
---------------------	--	--	--

waakvlambranderinspuiter POLIDORO



1

bestelnr.	104486	fabrikantnr.	40900006
------------------	--------	---------------------	----------

omschrijving	waakvlaminspuiter POLIDORO aardgas identificatienummer 29.2 boring ø 2x0,29mm vpe 1stuk		
---------------------	---	--	--



1

bestelnr.	100000	fabrikantnr.	40900003
------------------	--------	---------------------	----------

omschrijving	waakvlaminspuiter POLIDORO flessengas identificatienummer 22 boring ø 0.22mm vpe 1stuk		
---------------------	--	--	--

schroefnippels

snijringen



1

bestelnr.	101256	fabrikantnr.	43000013
------------------	--------	---------------------	----------

omschrijving	snijring voor pijp ø 16mm vpe 1stuk		
---------------------	-------------------------------------	--	--

Toebehoren voor	101256		
------------------------	--------	--	--



bestelnr.	101253	fabrikantnr.	—
------------------	--------	---------------------	---

overzetmoer draad M24x1,5 PEL voor pijp ø 16mm			
--	--	--	--

klemschroeven



1

bestelnr.	100905	fabrikantnr.	00131131 43000018
------------------	--------	---------------------	----------------------

omschrijving	klemschroef M10x1 voor pijp ø 6mm vpe 1stuk		
---------------------	---	--	--

apparaatspecifieke bouwdeelen

voor heteluchtoven/combi-steamers

afvoerventielen



1

bestelnr.	696788	fabrikantnr.	91200011
------------------	--------	---------------------	----------

omschrijving	afvoerpip draad 1 1/2" ID T-stuk kunststof ID ø 37mm OD ø 40mm voor heteluchtoven		
---------------------	---	--	--

deurmechanieken

sluitingsmechanisme



1

bestelnr.	698503	fabrikantnr.	92800011
------------------	--------	---------------------	----------

omschrijving	draaisluiting compleet		
---------------------	------------------------	--	--

Toebehoren voor	698503		
------------------------	--------	--	--

bestelnr.	690041	fabrikantnr.	—
------------------	--------	---------------------	---



sluiting L 148mm bevestigingsafstand 32mm			
---	--	--	--

bestelnr.	694409	fabrikantnr.	—
------------------	--------	---------------------	---



montageset voor espagnolettesluiting 694382			
---	--	--	--

Tabel wordt vervolgd op de volgende pagina



Toebehoren voor	698503		
	bestelnr.	700604	fabrikantnr. 1260017
	sluitblok rechts geopend asafname ø 8x8mm L 170mm B 40mm H 40mm		

voor ovens

diversen

	1		
bestelnr.	698478	fabrikantnr.	92800013
omschrijving	koppeling voor oven voor deur L 80mm B 26mm opname 8x8		

sluitingen

hendelsluitingen

universeel

buitenbevestiging

sluitingen

	1		
bestelnr.	694065	fabrikantnr.	66300003
omschrijving	deurgreep voor warmapparaat L 145mm B 40mm H 62mm veerlengte 33mm buiten zwart		
Reparatie-onderdelen voor	694065		
	bestelnr.	514390	fabrikantnr. 90100004
	veer voor deurgreep ø 6mm L 54mm B 27.5mm		
	bestelnr.	694734	fabrikantnr. —
	deurgreep L 165mm B 40mm H 25mm zwart		
	bestelnr.	694735	fabrikantnr. —
	afsluitdop ø 32mm zwart		
Toebehoren voor	694065		
	bestelnr.	694066	fabrikantnr. —
	tegenstuk met pin 2-standen L 28mm B 14mm H 15mm H1 16mm totale lengte 51mm draad M8 draad L 23mm RVS		
	bestelnr.	694067	fabrikantnr. —
	tegenstuk met pin 1-stand L 26mm totale lengte 51mm draad M8		

binnenbevestiging

sluitingen

	1		
bestelnr.	694054	fabrikantnr.	90100005
omschrijving	deurgreep voor warmapparaat L 145mm B 40mm H 62mm veerlengte 33mm binnenkant zwart		
Reparatie-onderdelen voor	694054		
	bestelnr.	514390	fabrikantnr. 90100004
	veer voor deurgreep ø 6mm L 54mm B 27.5mm		
	bestelnr.	694675	fabrikantnr. —
	deursluiting L 88mm B 40mm H 37mm veerlengte 33mm bevestigingsafstand 60mm		
	bestelnr.	694734	fabrikantnr. —
	deurgreep L 165mm B 40mm H 25mm zwart		
	bestelnr.	694735	fabrikantnr. —
	afsluitdop ø 32mm zwart		
Toebehoren voor	694054		
	bestelnr.	691123	fabrikantnr. —
	doorvoer voor deuropener		
	bestelnr.	694055	fabrikantnr. —
	tegenstuk L 25mm B 14mm totale lengte 54mm draad M8 draad L 29mm		
	bestelnr.	694066	fabrikantnr. —
	tegenstuk met pin 2-standen L 28mm B 14mm H 15mm H1 16mm totale lengte 51mm draad M8 draad L 23mm RVS		
	bestelnr.	694067	fabrikantnr. —
	tegenstuk met pin 1-stand L 26mm totale lengte 51mm draad M8		

werpsluitingen

hendelsluitingen

CAFF/FERMOD

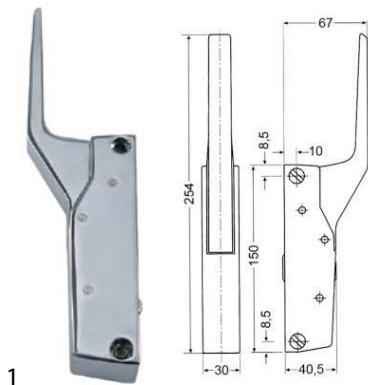

1

bestelnr.	700060	fabrikantnr.	1250056
omschrijving	hendelsluiting L 150mm bevestigingsafstand 133mm niet afsluitbaar warmte apparaat G 791		
Toebehoren voor	700060		
	bestelnr.	700061	fabrikantnr. 1250046
	tegenstuk L 58mm B 20mm H 35mm bevestigingsafstand 42mm messing verchroomd voor warmapparaat		
	bestelnr.	700062	fabrikantnr. —
	greepbescherming warmte apparaat		

tegenstukken



1

bestelnr.	700061	fabrikantnr.	1250046
omschrijving	tegenstuk L 58mm B 20mm H 35mm bevestigingsafstand 42mm messing verchroomd voor warmapparaat		
Toebehoren voor	700061		
	bestelnr.	690414	fabrikantnr. —
	hendelsluiting L 150mm bevestigingsafstand 133mm niet afsluitbaar koelapparaat G 791		

snapsluitingen

universeel



1

bestelnr.	690903	fabrikantnr.	1270034
omschrijving	snapslot L 69mm B 13mm H 20mm bevestigingsafstand 57mm compleet met deursluiting messing vernikkeld		

espagnoletsloten

universeel



1

bestelnr.	700604	fabrikantnr.	1260017
omschrijving	sluitblok rechts geopend asafname \varnothing 8x8mm L 170mm B 40mm H 40mm		

scharnieren

deurlagers



1

bestelnr.	514309	fabrikantnr.	009413 1250067
omschrijving	draailager inbouwpositie boven links zonder bouten		



1

bestelnr.	514310	fabrikantnr.	009400 1250066
omschrijving	draailager inbouwpositie onder links zonder bouten		



roosters en stelrails



roosters

universeel

zonder afkanting



1

bestelnr.	970120	fabrikantnr.	4100029
omschrijving	draadrooster B 325mm D 530mm GN 1/1 staal verchroomd draadsterkte buitenring 7mm draadsterkte lengtedraden 4mm dwarsbalken 1		
Toebehoren voor	970120		
	bestelnr.	690330	fabrikantnr. —
	geleideraildrager L 1000mm B 22mm H 4mm gatgrootte 3x8mm LA 12.5mm RVS		
	bestelnr.	694700	fabrikantnr. —
	rekdrager L 31/28mm B 22mm H 18mm RVS vpe 12stuk		
	bestelnr.	694701	fabrikantnr. —
	rekdrager L 31/28mm B 22mm H 17mm RVS met haak vpe 12stuk		

met afkanting

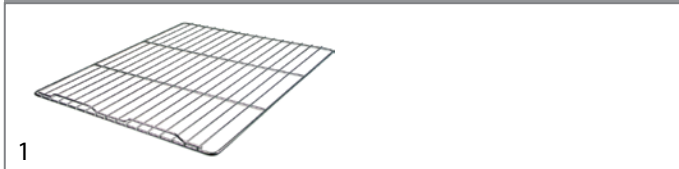

1

bestelnr.	970527	fabrikantnr.	00100115
omschrijving	draadrooster B 530mm D 650mm GN 2/1 staal verchroomd met aanslag dwarsbalken 2 passend voor koelkast		
Toebehoren voor	970527		
	bestelnr.	690330	fabrikantnr. —
	geleideraildrager L 1000mm B 22mm H 4mm gatgrootte 3x8mm LA 12.5mm RVS		
	bestelnr.	694700	fabrikantnr. —
	rekdrager L 31/28mm B 22mm H 18mm RVS vpe 12stuk		
	bestelnr.	694701	fabrikantnr. —
	rekdrager L 31/28mm B 22mm H 17mm RVS met haak vpe 12stuk		

rubbers

thermische pakkingen

raamrubbers

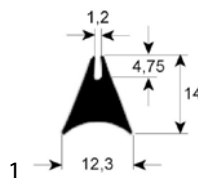

bestelnr.	900058	fabrikantnr.	009293 1240011 1250054
omschrijving	glaspakking profiel 1620 VPE per meter		

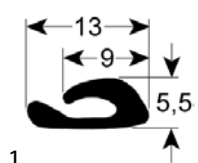

bestelnr.	900470	fabrikantnr.	007609 42300002
omschrijving	glaspakking profiel 1880 L 520mm VPE 1		
Toebehoren voor	900470		
	bestelnr.	900471	fabrikantnr. —
	glaspakking profiel 1880 L 680mm VPE 1		

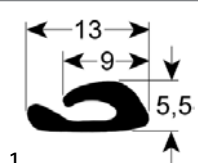

bestelnr.	900882	fabrikantnr.	007620 42300003
omschrijving	glaspakking profiel 1880 VPE per meter		

deurrubbers

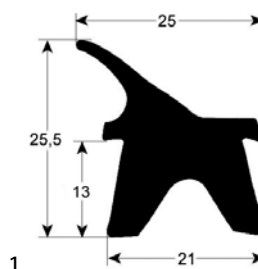

bestelnr.	900348	fabrikantnr.	1240012
omschrijving	deurrubber profiel 2402 VPE per meter		

bestelnr.	902166	fabrikantnr.	48600001
omschrijving	deurrubber profiel 2749 B 660mm L 1450mm buitenmaat passend voor FOINOX		

bestelnr.	901627	fabrikantnr.	92800001
omschrijving	deurrubber profiel 2781 B 688mm L 1410mm buitenmaat passend voor ANGELO PO		

bestelnr.	901624	fabrikantnr.	92600002
omschrijving	deurrubber profiel 2781 B 475mm L 1410mm buitenmaat passend voor ANGELO PO		

bestelnr.	901626	fabrikantnr.	92800010
omschrijving	deurrubber profiel 2781 B 688mm L 886mm buitenmaat passend voor ANGELO PO		

bestelnr.	901622	fabrikantnr.	92000022
omschrijving	deurrubber profiel 2781 B 475mm L 475mm buitenmaat passend voor ANGELO PO		

hordenwagenrubbers

bestelnr.	902520	fabrikantnr.	92600004
omschrijving	rekkenwagendichting profiel 4140 L 515mm VPE 1		

bestelnr.	901623	fabrikantnr.	92200002
omschrijving	deurrubber profiel 2781 B 475mm L 725mm buitenmaat passend voor ANGELO PO		

asafdichtingen

silicone pakkingen

bestelnr.	359721	fabrikantnr.	1230008
omschrijving	pakking silicone OD ø 48mm ID ø 39.5mm materiaaldikte 5mm vpe 1stuk		



schacht pakkingen

schacht pakkingen



1

bestelnr.	511172	fabrikantnr.	43000045
omschrijving	asafdichting ID ø 24mm OD ø 29mm materiaaldikte 3mm		



1

bestelnr.	511171	fabrikantnr.	43000042
omschrijving	simmerring ID ø 14.5mm OD ø 20mm materiaaldikte 3mm		

aandrijfstechniek en kogellagers

kogellagers

rolkogellagers 2Z



1

bestelnr.	692000	fabrikantnr.	38101004
omschrijving	groefkogellager schacht ø 15mm OD ø 35mm B 11mm type 6202-2Z DIN 625-1		

manometers



1

bestelnr.	541508	fabrikantnr.	90200028
omschrijving	manometer ø 40mm drukbereik 0-4bar aansluiting draad 1/8"		

slanghaspels en handdouches

apparaten handdouches



1

bestelnr.	691048	fabrikantnr.	1270003R	
omschrijving	apparatenhanddouche 1/2" OD L 225mm type STAR			
Reparatie-onderdelen voor	691048			
	bestelnr.	507309	fabrikantnr.	—
	O-ring EPDM materiaaldikte 2.62mm ID ø 17.13mm vpe 1stuk			
	bestelnr.	510322	fabrikantnr.	—
	O-ring EPDM materiaaldikte 1.78mm ID ø 17.17mm vpe 1stuk			
	bestelnr.	524055	fabrikantnr.	—
	vlakpakking rubber OD ø 18mm ID ø 12mm materiaaldikte 2mm vpe 1stuk			
	bestelnr.	528485	fabrikantnr.	—
	O-ring EPDM materiaaldikte 1.78mm ID ø 6.07mm vpe 1stuk			
	bestelnr.	528494	fabrikantnr.	—
	pakking rubber OD ø 13mm ID ø 4mm materiaaldikte 4mm vpe 1stuk			

ventielen en containerinlaten

kogelkranen

kogelkranen elektrisch



1

bestelnr.	401233	fabrikantnr.	43000004
omschrijving	kogelkraan ingang 1/2" ID uitgang 1/2" ID 230V 50/60Hz werkingsmodus elektrisch B 60mm H 99mm kabel 4-polig 2.5W 4-polig inschakeltijd 50%		



watercircuit componenten

drukventielen

drukventielen

universeel



1

bestelnr.	520967	fabrikantnr.	90200026
omschrijving	reduceerventiel serie HP WR01 aansluiting 1/2" voorinstelling 3bar instelbereik 1-6bar p max. 16bar t.max. 40°C messing verchromd IMPORT		

meettechniek

thermometers

inbouwthermometers

ø52mm



1

bestelnr.	541077	fabrikantnr.	1230022
omschrijving	thermometer inbouw ø 52mm t.max. 350°C +50 tot +350°C voeler ø 6mm voeler L 30mm capillaire 1000mm inbouwdiepte 28mm		

bevestigingsmaterialen

schroeven

zeskantschroeven



1

bestelnr.	506445	fabrikantnr.	91900007
omschrijving	zeskantschroef draad M10 draad L 35mm RVS SB 17 vpe 1stuk DIN 933 / ISO 4017		

moeren

zeskantmoeren

zeskantmoeren metrisch (zonder norm)



1

bestelnr.	520230	fabrikantnr.	00112127 010106
omschrijving	moer draad M14x1,5 H 5mm SB 19 verzinkt staal vpe 1stuk		

bevestigingen

spanstiften



1

bestelnr.	691637	fabrikantnr.	1260021
omschrijving	spanstift ø 3mm L 20mm		

A		
aardedraad	19	
afvoerpompen	19	
alarmapparaten	10	
apparaten handdouches	31	
asafdichtingen	30	
axiaalventilatoren	16	
B		
bedrijfscondensatoren	19	
bevestigingen	32	
bevestigingsmaterialen	32	
C		
condensatoren & ontstoringsfilters	19	
D		
deurrubbers	29	
dompelementen	2	
drukventielen	32, 32	
E		
elektra toebehoren	19	
elektroden	15	
elektronische regelaars	13	
energieregelaars	4	
espagnoletsloten	28	
G		
gasbranders	25	
gasinspuiters	25	
gasontstekingsautomaten	20	
gasregelventielen	19	
GEV	2	
gloeilampen	7	
H		
halogeenlamp	7	
handdouche met buitendraad	31	
hendelsluitingen	28	
hetelucht elementen	2	
heteluchtmotoren	16	
heteluchtventilatoren	18	
hordenwagenrubbers	30	
K		
kabels	19	
klemmen	19	
kogelkranen	31	
kogelkranen elektrisch	15, 31	
L		
lampen	7	
M		
magneetschakelaars	6, 10	
magneetventielen	14	
maximaal thermostaten	5	
mechanische timers	10	
meettechniek	32	
microschakelaars	5	
moeren	32	
N		
nokkenschakelaars	6	
O		
ontstekingsgroepen	23	
ontstekingskabels	23	
ovenlampen	7	
P		
pompen	19	
pressostaten	15	
programmatimers	10	
R		
raamrubbers	29	
regelthermostaten	4	
relais	12	
roosters	29	
roosters en stelrails	29	
S		
schacht pakkingen	31	
schakelaars en tasters	5	
schroeven	32	
signaallampen	7	
signaallampen compleet	7	
snapsluitingen	28	
solid state relais	12	
spanstiften	32	
staafbranders	25	
systeemschakelaar ROLD	5	
T		
tegenstukken	28	
temperatuurvoelers	14	
thermische pakkingen	29	
thermokoppels	24	
thermostaten	4	
tijdsrelais	12	
timers	10	

transformatoren 13

U

universele voelers 14

V

ventielen en containerinlaten 31

ventilatoren 16

verwarmingselementen 2

voelers 14

W

waakvlambranders 21

watercircuit componenten 32

werpsluitingen 28

Z

zeskantmoeren 32

zeskantschroeven 32