



Spare Parts for Ice Machines



Spare parts suitable for

MANITOWOC

2018

Find the complete and up-to-date range of products in our [GEV Webshop](#)



thermostats

refrigeration thermostats

miscellaneous producers



GEV No.	390762	Ref. No.	20-0883-3
description	thermostat probe ø 2mm probe Lmm capillary pipe 2000mm type WPF20.5B-L for evaporator		



GEV No.	390818	Ref. No.	20-0914-3 MA-04000815 MA-2009149
description	thermostat probe ø6x470mm capillary pipe 1020mm type WPF1 M-L for container		

switches and momentary switches

rocker/momentary rocker switches

30x22mm



GEV No.	301188	Ref. No.	20-0670-9
description	rocker switch mounting measurements 30x22mm black 2NO/2NO 250V 16A I O II connection male faston 6.3mm ambient temperature max. 125/55°C protection IP40		

accessories for 301188



GEV No.	301036	Ref. No.	—
description	protective cover internal size 30x22mm for rocker switch mounting measurementsmm		

magnetic switches

miscellaneous



GEV No.	347697	Ref. No.	23-0148-3
description	magnetic switch 250V 1A P max. 250W 1NO connection male faston 6.3mm L 61mm cable length 2400mm L1 27mm with housing		

timers

electric timers



GEV No.	360513	Ref. No.	040000879 20-0978-9 ma-040000879
description	timer operation time 5-15min/1-6min time spreadmin 1CO/1NO permanent position no time range 5-15 / 1-6min 10A shaft ømm shaftmm shaft Lmm connection male faston 6.3mm ABB for ice-cube maker 24-240V voltage AC/DC 2-pole		

electronics

PCBs

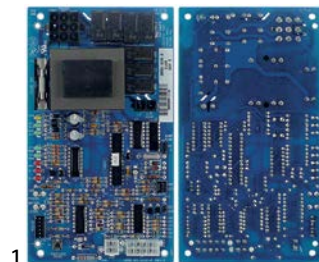

GEV No.	403123	Ref. No.	20-0619-9 MA2006199
description	PCB ice cube maker L 175mm W 99mm		

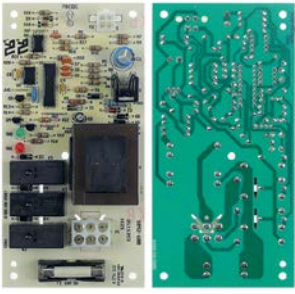
1

GEV No.	403124	Ref. No.	2511393 76-2907-3 MA-7629073
description	PCB ice maker L 153mm W 77mm		



1

GEV No.	403125	Ref. No.	2511233 2511303 7626913 7626993 7627423 76-2782-3 MA-7627823
description	PCB L 175mm W 99mm for ice-cube maker		

solenoid valves

solenoid valves (water)

DELTROL

solenoid valves with reducers



1

GEV No.	370663	Ref. No.	00000887
description	solenoid valve single angled 220-240VAC inlet 3/4" outlet 11.5mm DELTROL DSVP40-X-2-B-0.5-3 plastic flow regulating valve outlet blue		

ROBERTSHAW/INVENSYS

medium temperature: 90°C 90°C 60°C
 ambient temperature: 60°C 25°C 60°C
 duty cycle: 40% 100% 100%

solenoid valves with reducers

single



1

GEV No.	370828	Ref. No.	040001079 MA-040001079
description	solenoid valve single angled 230VAC inlet 3/4" outlet 11.5mm output 0.35l/min ROBERTSHAW		

various



1

GEV No.	370650	Ref. No.	000001768 2404903 2405223 MA000001768
description	solenoid valve single angled 220-240VAC inlet 12.4mm outlet 11mm		

solenoid valves (refrigeration)

various

valves



1

GEV No.	370373	Ref. No.	76-0239-3	
description	solenoid valve angled DN1.9 connection 6mm soldering connection refrigeration angled 90° 230V			
spare parts for	370373			
	GEV No.	371144	Ref. No.	000001144
	solenoid coil 230V 50/60Hz refrigeration			



spare parts and accessories

solenoid coils



1

GEV No.	371144	Ref. No.	000001144
----------------	--------	-----------------	-----------

description	solenoid coil 230V 50/60Hz refrigeration		
--------------------	--	--	--

fans

refrigeration fans

refrigeration motors universal

ebm-papst

miscellaneous



1

GEV No.	601737	Ref. No.	20-0021-9
----------------	--------	-----------------	-----------

description	fan motor 16W 230V 60Hz L1 43mm L3 87mm W 72mm cable length 500mm 1550rpm ebm-papst M4Q045-CF01-05/S01		
--------------------	--	--	--

spare parts for	601737		
------------------------	--------	--	--



GEV No.	601413	Ref. No.	—
----------------	--------	-----------------	---

fixing plate suitable for fanwheel ED ø 32mm shaft ø 7 mounting distance 26mm



1

GEV No.	601736	Ref. No.	20-0020-9
----------------	--------	-----------------	-----------

description	fan motor M4Q045-BD01-05/S01 5W 230V 60Hz L1 45mm L3 75mm W 60mm cable length 300mm 1550rpm ebm-papst double		
--------------------	--	--	--

spare parts for	601736		
------------------------	--------	--	--



GEV No.	601413	Ref. No.	—
----------------	--------	-----------------	---

fixing plate suitable for fanwheel ED ø 32mm shaft ø 7 mounting distance 26mm

accessories

fan wheels

aluminium



1

GEV No.	601385	Ref. No.	30-0566-9
----------------	--------	-----------------	-----------

description	fan wheel sucking ø 172mm fan wheel mounting 25.4mm blade angle 34° W 42mm aluminium		
--------------------	--	--	--



1

GEV No.	601283	Ref. No.	30-0565-9
----------------	--------	-----------------	-----------

description	fan wheel sucking ø 230mm fan wheel mounting 25.4mm blade angle 28° W 41mm aluminium		
--------------------	--	--	--

pumps

drain pumps

HANNING



1

GEV No.	499345	Ref. No.	MA-040005217
----------------	--------	-----------------	--------------

description	pump 83-99W 220-240V inlet ø 24mm outlet ø 24mm 50Hz type MIP 2 REGAL BELOIT		
--------------------	--	--	--



pumps for ice machines



1

GEV No.	499195	Ref. No.	1480279 1480391 8480563 8480813 MA-1480279
description	pump MORRILL type MSP 14W 208-240V 50/60Hz inlet ø 26mm outlet ø 27mm L 140mm rotation direction right for ice-cube maker		



1

GEV No.	499122	Ref. No.	76-26013
description	pump NBK MOTORS type YSP6PJDVF2 208-240V 50/60Hz outlet ø 26mm L 210mm rotation direction right for ice-cube maker		



1

GEV No.	499344	Ref. No.	040005212 MA-040005212
description	pump REGAL BELOIT type MIP 1 39-47W 220-240V 50Hz inlet ø 24mm outlet ø 22mm L 140mm		



1

GEV No.	499355	Ref. No.	040005215
description	pump REGAL BELOIT type MIP 1 39-47W 220-240V 50Hz inlet ø 24mm outlet ø 22mm L 140mm		



1

GEV No.	499194	Ref. No.	2008943 20-0894-9 MA-2008949
description	pump type MSP2 230V 50Hz inlet ø 26mm outlet ø 27mm L 120mm rotation direction right for ice-cube maker		

equipment-specific units for vegetable slicers

ejector discs



1

GEV No.	699132	Ref. No.	HA-3086
description	ejector disc flat H 10mm ø 205mm seat ø 34mm		

for ice-cube maker

probes

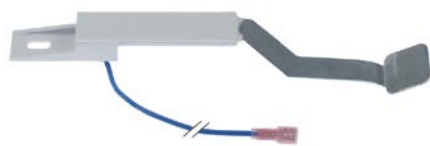

1

GEV No.	694549	Ref. No.	2511293
description	probe for water level 1-pole cable length 1100mm		



1

GEV No.	694544	Ref. No.	76-2781-3
description	sensor for ice thickness 1-pole cable length 1450mm		



1

GEV No.	694545	Ref. No.	76-0160-3
description	sensor for ice thickness 1-pole cable length 300mm		









			
1			
GEV No.	694992	Ref. No.	MA-2008029
description	sensor for ice thickness 1-pole cable length 850mm		

spray systems

MANITOWOC

accessories

			
1			
GEV No.	694419	Ref. No.	40-0876-9 MA-4008769
description	nozzle for ice-cube maker ø 24mm H 19mm		
accessories for	694419		
	GEV No.	Ref. No.	50-0463-9
	O-ring EPDM thickness 1.78mm ID ø 10.82mm Qty 1 pcs		
	GEV No.	Ref. No.	40-0877-9 MA-4008779
	swirl for ice-cube maker ø 11.3mm H 14mm		

			
1			
GEV No.	694420	Ref. No.	40-0877-9 MA-4008779
description	swirl for ice-cube maker ø 11.3mm H 14mm		
accessories for	694420		
	GEV No.	Ref. No.	50-0463-9
	O-ring EPDM thickness 1.78mm ID ø 10.82mm Qty 1 pcs		
	GEV No.	Ref. No.	40-0876-9 MA-4008769
	nozzle for ice-cube maker ø 24mm H 19mm		

doors

doors

			
1			
GEV No.	694417	Ref. No.	40-1245-9
description	door for ice-cube maker W 370mm H 180mm thickness 29mm grey		

			
1			
GEV No.	694408	Ref. No.	40-0937-9
description	door for ice-cube maker W 475mm H 235mm thickness 28mm grey		

curtains

accessories

lamellas

			
1			
GEV No.	694426	Ref. No.	40-1258-9
description	lamella for curtain W 38mm H 94mm ø 6.5mm angled		

			
1			
GEV No.	694422	Ref. No.	40000779 40-0882-9
description	lamella for curtain W 38mm H 95mm ø 6.5mm		

curtain rods

			
1			
GEV No.	694466	Ref. No.	30-0570-9
description	curtain rod for ice-cube maker L 316mm ø 6mm		

			
1			
GEV No.	694421	Ref. No.	30-0455-9
description	curtain rod for ice-cube maker L 466mm ø 6mm		



housing and bezels

fascias



1

GEV No.	692762	Ref. No.	76-2915-3
description	bezel L 500mm W 665mm H 55mm		

refrigeration pipes



1

GEV No.	694418	Ref. No.	76-0240-3
description	refrigeration pipe with collector		



1

GEV No.	694467	Ref. No.	76-0267-9
description	refrigeration pipe with collector		

valves

intake valves



1

GEV No.	694548	Ref. No.	83-6904-9
description	intake valve with float		

hinges

door bearing



1

GEV No.	701213	Ref. No.	MA-7624413
description	door hinge L 77mm W 13mm H 32mm mounting pos. right/left set for ice container		

accessories for	701213		
GEV No.	701214	Ref. No.	—
description	bush set for door hinge ID \varnothing 6.6mm ED \varnothing 9.5mm L 26mm		

gaskets

O-rings

EPDM



1

GEV No.	529545	Ref. No.	50-0463-9
description	O-ring EPDM thickness 1.78mm ID \varnothing 10.82mm Qty 1 pcs		

refrigeration cycle components

cooling water regulators

JOHNSON CONTROLS



1

GEV No.	541839	Ref. No.	82-5272-9
description	cooling water regulator 3/8" type V465A-9952 connection 6mm soldering connection pressure range 5-23bar water pressure max. 18bar water temperature max. 90°C capillary pipe 750mm L 101mm 405kg		

C

cooling water regulators 8

D

drain pumps 4

E

electric timers 2

F

fans 4

M

magnetic switches 2

O

O-rings 7

P

pumps 4

pumps for ice machines 5

R

refrigeration cycle components 8

refrigeration fans 4

refrigeration motors universal 4

refrigeration thermostats 2

rocker/momentary rocker switches 2

S

solenoid valves 3

switches and momentary switches 2

T

thermostats 2

timers 2