



Ersatzteile passend für  
**Kühlgeräte**



Ersatzteile passend für

**LIEBHERR**

2018

Das komplette Sortiment finden Sie immer aktuell im GEV-Webshop



## Thermostate

### Kältethermostate

#### RANCO

##### Serie K50



<b>GEV-Nr.</b>	390619	<b>Vergl.-Nr.</b>	6151995
<b>Beschreibung</b>	Thermostat RANCO Typ K50-P6073/001 Fühler ømm Fühler Lmm Kapillarrohr 2000mm		
<b>Für Modelle:</b>	FKS 5000-20E		
<b>Zubehör für</b>	390619		
	<b>GEV-Nr.</b>	112945	<b>Vergl.-Nr.</b> 7422505
	Knebel ø 22mm Achse ø 6x4,6mm Abflachung vertikal weiß		

##### Serie K57



<b>GEV-Nr.</b>	390618	<b>Vergl.-Nr.</b>	6151761
<b>Beschreibung</b>	Thermostat RANCO Typ K57-L2865 Kapillarrohr 1950mm Arbeitsbereich -40 bis +40°C Fühler ø9,5x107mm		
<b>Zubehör für</b>	390618		
	<b>GEV-Nr.</b>	112945	<b>Vergl.-Nr.</b> 7422505
	Knebel ø 22mm Achse ø 6x4,6mm Abflachung vertikal weiß		



<b>GEV-Nr.</b>	390617	<b>Vergl.-Nr.</b>	6151753
<b>Beschreibung</b>	Thermostat RANCO Typ K57-L2866 Fühler ø 2mm Fühler Lmm Kapillarrohr 2000mm Arbeitsbereich -40 bis +40°C		

## Schalter und Taster

### Mikroschalter

#### mit Drucktaste

##### Schalter mit Schnappbefestigung



<b>GEV-Nr.</b>	347018	<b>Vergl.-Nr.</b>	6060995
<b>Beschreibung</b>	Mikroschalter mit Drucktaste 250V 1A 1CO Anschluss Flachstecker 2,8mm L 28x12mm Umgebungstemperatur max. 85°C Betätigungskraft: 60g		

### Magnetschalter

#### Zubehör

##### Magnete



<b>GEV-Nr.</b>	691490	<b>Vergl.-Nr.</b>	7424266
<b>Beschreibung</b>	Magnet ømm L 29.5mm H 7mm B 28.5mm LA 13mm		

## Fühler

### Herstellerspezifische Fühler

#### Fühler



<b>GEV-Nr.</b>	379753	<b>Vergl.-Nr.</b>	6942216 6942236 9590088 9590142-00
<b>Beschreibung</b>	Fühler NTC Kabel PVC Fühler -40 bis +110°C Kabel -10 bis +100°C Anschluss 2-adrig Gewinde M15x1,75 Fühler ø8x29mm Kabellänge 3.1m		

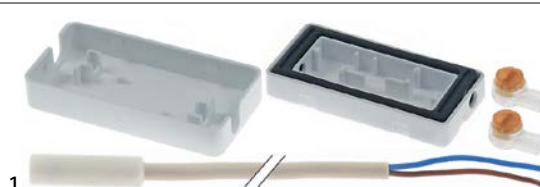

<b>GEV-Nr.</b>	381418	<b>Vergl.-Nr.</b>	9590 206-00
<b>Beschreibung</b>	Fühler Reparatursatz NTC Kabel PVC Fühler -40 bis +110°C Kabel -10 bis +100°C Anschluss 2-adrig Gewinde M15x1,75 Fühler ø8x29mm Kabellänge 3.1m		



## Elektroniken

### Platinen

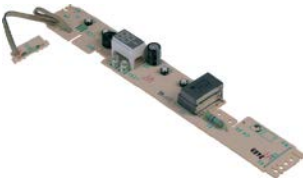
			
1			
<b>GEV-Nr.</b>	402069	<b>Vergl.-Nr.</b>	6113321 6114289-00 6114431-00 6114489-00 6114667-00
<b>Beschreibung</b>	Tastaturplatine Kühlschrank für Gerät GKV5710		

## Kompressoren

### EMBRACO / ASPERA

#### R600A

#### LBP 1-phasig

Niedrige Verdampfungstemperatur unter -20 °C

			
1			
<b>GEV-Nr.</b>	605085	<b>Vergl.-Nr.</b>	6119659
<b>Beschreibung</b>	Kompressor Kältemittel R600a Typ EMT45CDP 220-240V 50Hz HBP vollhermetisch 7.7kg 1/8HP Leistungsaufnahme 152W Hubraum 6.78cm <sup>3</sup> RSIRWWWWW 164W 209W 262W 322W 392W 477W Testverfahren ASHRAE		
<b>Für Modelle:</b>	FKS 5000-20E		
<b>Ersatzteile für</b>	605085		
	<b>GEV-Nr.</b>	381088	<b>Vergl.-Nr.</b> 6940650
	Anlaufrelais ASPERA A2BML		
	<b>GEV-Nr.</b>	390620	<b>Vergl.-Nr.</b> 6940609
	Schutzschalter für thermischen Motorschutz T0357/07 T.max. 150°C Reset automatisch		

#### HBP 1-phasig



Hohe Verdampfungstemperatur über -15 °C

			
1			
<b>GEV-Nr.</b>	605083	<b>Vergl.-Nr.</b>	6119717
<b>Beschreibung</b>	Kompressor Kältemittel R600a Typ EMT30CDP 220-240V 50Hz HBP vollhermetisch 7.2kg 1/8HP Hubraum 4.5cm <sup>3</sup> RSIR H 158mmWW 112W 142W 180W 222W 268W 320W Testverfahren ASHRAE		
<b>Ersatzteile für</b>	605083		
	<b>GEV-Nr.</b>	381088	<b>Vergl.-Nr.</b> 6940650
	Anlaufrelais ASPERA A2BML		
	<b>GEV-Nr.</b>	390621	<b>Vergl.-Nr.</b> 6941014
	Schutzschalter für thermischen Motorschutz T0224/07 T.max. 150°C Reset automatisch		

### Zubehör

#### Anlaufrelais

#### Sonstige

			
1			
<b>GEV-Nr.</b>	381088	<b>Vergl.-Nr.</b>	6940650
<b>Beschreibung</b>	Anlaufrelais ASPERA A2BML		
<b>Für Modelle:</b>	FKS 5000-20E		
			
1			
<b>GEV-Nr.</b>	381087	<b>Vergl.-Nr.</b>	6940863
<b>Beschreibung</b>	Anlaufrelais DANFOSS 103N0021 200-240V		

### Schutzschalter (Klixons)

			
1			
<b>GEV-Nr.</b>	390621	<b>Vergl.-Nr.</b>	6941014
<b>Beschreibung</b>	Schutzschalter für thermischen Motorschutz T0224/07 T.max. 150°C Reset automatisch		

			
1			
<b>GEV-Nr.</b>	390620	<b>Vergl.-Nr.</b>	6940609
<b>Beschreibung</b>	Schutzschalter für thermischen Motorschutz T0357/07 T.max. 150°C Reset automatisch		
<b>Für Modelle:</b>	FKS 5000-20E		

			
1			
<b>GEV-Nr.</b>	601478	<b>Vergl.-Nr.</b>	6118751
<b>Beschreibung</b>	Lüftermotor 230V 50-60Hz Achslänge 22mm Achse ø 3mm Typ F61-10G mit Stecker		
<b>Zubehör für</b>	601478		
	<b>GEV-Nr.</b>	601480	<b>Vergl.-Nr.</b>
			6299905
	Lüfterrad drückend ø 164mm B 27mm Achsaufnahme ø 3mm Kunststoff Schaufeln 3		

Zubehör			
Lüfterräder für Kälteventilatoren			
			
1			
<b>GEV-Nr.</b>	601480	<b>Vergl.-Nr.</b>	6299905
<b>Beschreibung</b>	Lüfterrad drückend ø 164mm B 27mm Achsaufnahme ø 3mm Kunststoff Schaufeln 3		

Bügel für Kälteventilatoren			
 Bild nicht vorhanden			
1			
<b>GEV-Nr.</b>	691504	<b>Vergl.-Nr.</b>	7427581
<b>Beschreibung</b>	Brennerständer		

			
1			
<b>GEV-Nr.</b>	691478	<b>Vergl.-Nr.</b>	7422558
<b>Beschreibung</b>	Brennerständer für Ventilator		



			
1			
<b>GEV-Nr.</b>	691479	<b>Vergl.-Nr.</b>	7427579 7430145 7430145-00
<b>Beschreibung</b>	Brennerständer für Ventilator		

## Lüfter

### Kältelüfter

#### Kälteventilatoren

##### Kälteventilatoren

			
1			
<b>GEV-Nr.</b>	601477	<b>Vergl.-Nr.</b>	6118671 6118791
<b>Beschreibung</b>	Lüftermotor 220-240V 50-60Hz T 40mm B 61mm H 74mm Achslänge 24mm Achse ø 3.2mm Typ F61-10 Kabellänge 450mm		
<b>Zubehör für</b>	601477		
	<b>GEV-Nr.</b>	601480	<b>Vergl.-Nr.</b>
			6299905
	Lüfterrad drückend ø 164mm B 27mm Achsaufnahme ø 3mm Kunststoff Schaufeln 3		

			
1			
<b>GEV-Nr.</b>	601479	<b>Vergl.-Nr.</b>	6108993 6118787 6118795
<b>Beschreibung</b>	Lüftermotor 230V 50-60Hz Achslänge 22mm Achse ø 3mm Typ F61-10G		
<b>Zubehör für</b>	601479		
	<b>GEV-Nr.</b>	601480	<b>Vergl.-Nr.</b>
			6299905
	Lüfterrad drückend ø 164mm B 27mm Achsaufnahme ø 3mm Kunststoff Schaufeln 3		



## Gerätespezifische Bauteile

### für Kühlschränke

#### Gehäuse und Blenden

#### Halterungen



1

<b>GEV-Nr.</b>	691491	<b>Vergl.-Nr.</b>	7424773
<b>Beschreibung</b>	Halter		

## Knebel

### Herstellerspezifische Knebel

#### LIEBHERR



1

<b>GEV-Nr.</b>	112945	<b>Vergl.-Nr.</b>	7422505
<b>Beschreibung</b>	Knebel ø 22mm Achse ø 6x4,6mm Abflachung vertikal weiß		
<b>Für Modelle:</b>	FKS 5000-20E		

## Griffe und Handräder

### Sonstige



1

<b>GEV-Nr.</b>	691492	<b>Vergl.-Nr.</b>	7042411 7042411-01
<b>Beschreibung</b>	Türgriff L 190mm B 83mm LA 155mm Kühlschrank weiß H 25mm		
<b>Für Modelle:</b>	FKS 5000-20E		

## Verschlüsse

### Abschließvorrichtungen

#### Herstellerspezifisch

#### LIEBHERR



1

<b>GEV-Nr.</b>	691482	<b>Vergl.-Nr.</b>	7042814
<b>Beschreibung</b>	Ersatzschlüssel für Schließzylinder 691481		



1

<b>GEV-Nr.</b>	691484	<b>Vergl.-Nr.</b>	7042837
<b>Beschreibung</b>	Ersatzschlüssel für Schließzylinder 691483		



1

<b>GEV-Nr.</b>	691486	<b>Vergl.-Nr.</b>	7042196 7043341
<b>Beschreibung</b>	Ersatzschlüssel für Schließzylinder 691485, 691489		
<b>Für Modelle:</b>	FKS 5000-20E		



1

<b>GEV-Nr.</b>	691481	<b>Vergl.-Nr.</b>	7043513
<b>Beschreibung</b>	Schließzylinder		
<b>Zubehör für</b>	691481		



<b>GEV-Nr.</b>	691482	<b>Vergl.-Nr.</b>	7042814
<b>Beschreibung</b>	Ersatzschlüssel für Schließzylinder 691481		



1

<b>GEV-Nr.</b>	691483	<b>Vergl.-Nr.</b>	7041775 7041789
<b>Beschreibung</b>	Schließzylinder		
<b>Zubehör für</b>	691483		



<b>GEV-Nr.</b>	691484	<b>Vergl.-Nr.</b>	7042837
<b>Beschreibung</b>	Ersatzschlüssel für Schließzylinder 691483		





1

<b>GEV-Nr.</b>	691489	<b>Vergl.-Nr.</b>	7043075-00 7043075-00 + 9190305-00 /020 7043075-00 9190305-00 /020 7043195-00 7043343 9190345-00	
<b>Beschreibung</b>	Schließzylinder			
<b>Zubehör für</b>	691489			
	<b>GEV-Nr.</b>	691486	<b>Vergl.-Nr.</b>	7042196 7043341
Ersatzschlüssel für Schließzylinder 691485, 691489				



1

<b>GEV-Nr.</b>	691485	<b>Vergl.-Nr.</b>	7042356 7042846 7042846-00	
<b>Beschreibung</b>	Schließzylinder Schließer			
<b>Für Modelle:</b>	FKS 5000-20E			
<b>Zubehör für</b>	691485			
	<b>GEV-Nr.</b>	691486	<b>Vergl.-Nr.</b>	7042196 7043341
Ersatzschlüssel für Schließzylinder 691485, 691489				



1

<b>GEV-Nr.</b>	700755	<b>Vergl.-Nr.</b>	7043029 7043461
<b>Beschreibung</b>	Bolzen L 50mm ø 8mm		



1

<b>GEV-Nr.</b>	700754	<b>Vergl.-Nr.</b>	7422079
<b>Beschreibung</b>	Buchse L 30mm ø 9mm weiß für Scharnier		
<b>Für Modelle:</b>	FKS 5000-20E		



1

<b>GEV-Nr.</b>	700752	<b>Vergl.-Nr.</b>	7429351
<b>Beschreibung</b>	Buchse L 46mm EP links ø 14mm weiß für Scharnier		



1

<b>GEV-Nr.</b>	700753	<b>Vergl.-Nr.</b>	7429349
<b>Beschreibung</b>	Buchse L 46mm EP rechts ø 14mm weiß für Scharnier		



1

<b>GEV-Nr.</b>	700751	<b>Vergl.-Nr.</b>	7429517
<b>Beschreibung</b>	Buchse L 49mm ø 11mm weiß für Scharnier		



1

<b>GEV-Nr.</b>	700758	<b>Vergl.-Nr.</b>	7043459 9450457-00 /018 9450469-00 9450649-00
<b>Beschreibung</b>	Lagerbock L 42mm B 38mm H 48mm BA 28mm Bolzen 51mm Bolzen-ø 8mm		

## Scharniere

### Türlager



1

<b>GEV-Nr.</b>	700756	<b>Vergl.-Nr.</b>	7113077
<b>Beschreibung</b>	Bolzen L 21mm Gewinde M6 ø 6mm für Scharnier		
<b>Für Modelle:</b>	FKS 5000-20E		



1

<b>GEV-Nr.</b>	700750	<b>Vergl.-Nr.</b>	7113761
<b>Beschreibung</b>	Bolzen L 48mm Gewinde M6 ø 8mm für Scharnier		

1

<b>GEV-Nr.</b>	700757	<b>Vergl.-Nr.</b>	9450057
<b>Beschreibung</b>	Scharnier Kühlschrank		
<b>Für Modelle:</b>	FKS 5000-20E		
<b>Ersatzteile für</b>	700757		
	<b>GEV-Nr.</b>	700756	<b>Vergl.-Nr.</b> 7113077
	Bolzen L 21mm Gewinde M6 ø 6mm für Scharnier		

Steckbare Gerätefüße



1

<b>GEV-Nr.</b>	701206	<b>Vergl.-Nr.</b>	7402121
<b>Beschreibung</b>	Gerätefuß ø 32mm H 14mm Einbau ø 10mm Gesamthöhe 25.5mm Kunststoff VPE 1 Stück		
<b>Für Modelle:</b>	FKS 5000-20E		

Filter

Gerätefilter



1

<b>GEV-Nr.</b>	694678	<b>Vergl.-Nr.</b>	7429177
<b>Beschreibung</b>	Luftfilter L 315mm B 265mm ømm H 120mm für Gerät LKPV/LGPV 1420,652 passend für LIEBHERR		

Dichtungen

Kälteabdichtungen

Sonstige



1

<b>GEV-Nr.</b>	901339	<b>Vergl.-Nr.</b>	7108528-00 7108528-00+7108528-00 7111062-00 7111062-00+9096042-00
<b>Beschreibung</b>	Kälteabdichtung Umbausatz B 580mm L 675mm Außenmaß		



1

<b>GEV-Nr.</b>	901338	<b>Vergl.-Nr.</b>	7108136 7111004-00 7111004-00+9096042-00
<b>Beschreibung</b>	Kälteabdichtung Umbausatz B 585mm L 765mm Außenmaß		

Gerätefüße und Endkappen

Gerätefüße

mit Schraubbefestigung



1

<b>GEV-Nr.</b>	701205	<b>Vergl.-Nr.</b>	7043485
<b>Beschreibung</b>	Gerätefuß Rohr ø 67mm Gewinde M10 Gewinde L 15mm H 150-210mm CNS Größe 2 1/2" VPE 1 Stück		



1

<b>GEV-Nr.</b>	901337	<b>Vergl.-Nr.</b>	7108154+9086532+7081554 7108154-00
<b>Beschreibung</b>	Kälteabdichtung Umbausatz B 747mm L 1400mm Außenmaß für Gerät FKS 5000/5010, UKS 5000		

Einschraubfüße



1

<b>GEV-Nr.</b>	701207	<b>Vergl.-Nr.</b>	7042301
<b>Beschreibung</b>	Gerätefuß Gewinde M10 SW 22 L 20mm		
<b>Für Modelle:</b>	FKS 5000-20E		



Steckdichtungen

Profil 9952

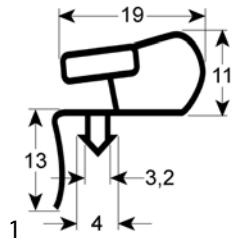

<b>GEV-Nr.</b>	901275	<b>Vergl.-Nr.</b>	7108383
<b>Beschreibung</b>	Kälteichtung Profil 9952 B 572mm L 733mm Steckmaß		

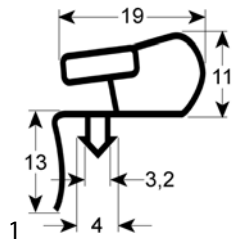

<b>GEV-Nr.</b>	900801	<b>Vergl.-Nr.</b>	7108357
<b>Beschreibung</b>	Kälteichtung Profil 9952 B 580mm L 1650mm Steckmaß		

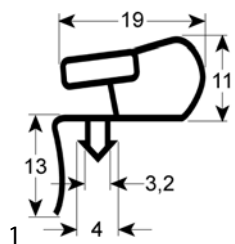

<b>GEV-Nr.</b>	900798	<b>Vergl.-Nr.</b>	7108393
<b>Beschreibung</b>	Kälteichtung Profil 9952 B 580mm L 760mm Steckmaß		

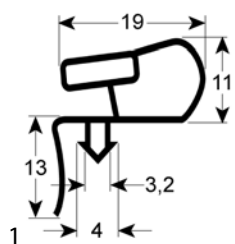

<b>GEV-Nr.</b>	901340	<b>Vergl.-Nr.</b>	7109677-00 7109677-00+7080419-00
<b>Beschreibung</b>	Kälteichtung Profil 9952 B 585mm L 1665mm Steckmaß Servicekit		

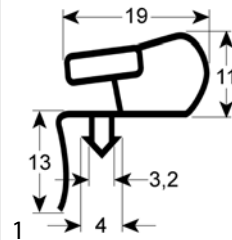

<b>GEV-Nr.</b>	900800	<b>Vergl.-Nr.</b>	7109407
<b>Beschreibung</b>	Kälteichtung Profil 9952 B 710mm L 1565mm Steckmaß		

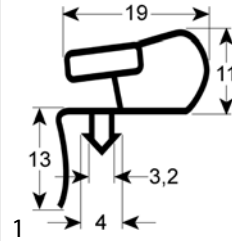

<b>GEV-Nr.</b>	900799	<b>Vergl.-Nr.</b>	7108401
<b>Beschreibung</b>	Kälteichtung Profil 9952 B 730mm L 1380mm Steckmaß		
<b>Für Modelle:</b>	FKS 5000-20E		

Profil 9505

*Dieses Profil kann auf Wunsch in Sondermaßen gefertigt werden*

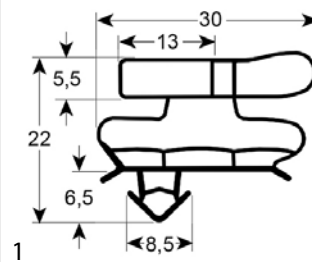

<b>GEV-Nr.</b>	902039	<b>Vergl.-Nr.</b>	N/A
<b>Beschreibung</b>	Kälteichtung Profil 9505 Bmm L 2500mm Steckmaß		

Einschraubdichtungen

Profil 9515

*Dieses Profil kann auf Wunsch in Sondermaßen gefertigt werden*

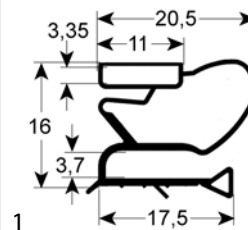

<b>GEV-Nr.</b>	902287	<b>Vergl.-Nr.</b>	N/A
<b>Beschreibung</b>	Kälteichtung Profil 9515 Bmm L 2500mm Außenmaß		





## Kältekreislaufkomponenten

### Filtertrockner

#### Sonstige



1

<b>GEV-Nr.</b>	750165	<b>Vergl.-Nr.</b>	5942032 5942034 5942036
<b>Beschreibung</b>	Trockner Größe 10g ø 16mm L 125mm Anschluss 2,1/4,9mm		
<b>Für Modelle:</b>	FKS 5000-20E		

## Verdampfer

### für Kühlschränke

#### Herstellerspezifisch



1

<b>GEV-Nr.</b>	750147	<b>Vergl.-Nr.</b>	5940997
<b>Beschreibung</b>	Verdampfer für Kühlschrank für Gerät FKS 5000 L 850mm B 575mm Typ FKS5000/02 LIEBHERR		
<b>Für Modelle:</b>	FKS 5000-20E		



1

<b>GEV-Nr.</b>	750146	<b>Vergl.-Nr.</b>	5940757
<b>Beschreibung</b>	Verdampfer für Kühlschrank für Gerät FKV 4310 L 1000mm B 460mm Typ FKDV 3712-20 A LIEBHERR		



1

<b>GEV-Nr.</b>	750148	<b>Vergl.-Nr.</b>	5940995
<b>Beschreibung</b>	Verdampfer für Kühlschrank für Gerät UKS 1800 L 430mm B 460mm LIEBHERR		

## Messtechnik

### Thermometer

#### Einbauthermometer



1

<b>GEV-Nr.</b>	541929	<b>Vergl.-Nr.</b>	6111959
<b>Beschreibung</b>	Thermometer Einbaumaß 58x25,5mm -40 bis +40°C Kapillarrohr 700mm Fühler ø 6mm Fühler L 37mm		

#### batteriebetrieben



1

<b>GEV-Nr.</b>	379752	<b>Vergl.-Nr.</b>	6111963 6111997
<b>Beschreibung</b>	Thermometer Einbaumaß 58x25,5mm Frontmaß 29x62mm Batterie-fach vorne bis +100°C Kabellänge 2200mm		



**E**

Einschraubdichtungen 8

**F**

Filtertrockner 9

Fühler 2

**K**

Kälteabdichtungen 7

Kältekreislaufkomponenten 9

Kältelüfter 4

Kältethermostate 2

Kälteventilatoren 4

Kompressoren 3

**L**

Lüfter 4

**M**

Magnetschalter 2

Messtechnik 9

Mikroschalter 2

**S**

Schalter und Taster 2

Steckdichtungen 8

**T**

Thermostate 2

**V**

Verdampfer 9