



Ersatzteile passend für
Kühlgeräte



Ersatzteile passend für

FORCAR

2018

Das komplette Sortiment finden Sie immer aktuell im GEV-Webshop



Heizkörper

Heizkörper für Kältetechnik

Abtauheizungen



GEV-Nr.	420150	Vergl.-Nr.	GN650BT.01 RC0136
Beschreibung	Heizkörper 400W 230V L 290mm B 75mm H 90mm L1 60mm L2 230mm B1 16mm B2 43mm Anschluss Gabelkabelschuh M4 Kabellänge 700mm Rohr ø 10mm Kältetechnik für Verdampfer		
Für Modelle:	GN650BT, GN650BTG, GN650BTM, GN650TN, GN650TNG, GN650TNM		

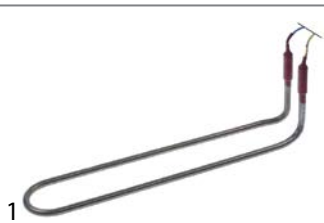

GEV-Nr.	420523	Vergl.-Nr.	RC0234
Beschreibung	Heizkörper 450W 220V L 400mm B 75mm H 135mm Kabellänge 1480mm Rohr ø 9.6mm		



GEV-Nr.	420153	Vergl.-Nr.	GN140BT.02 GN1410BT.01 PA800BT.01 RC0062
Beschreibung	Heizkörper 700W L 590mm B 75mm H 115mm L1 60mm L2 530mm B1 13.5mm B2 48mm Anschluss Gabelkabelschuh M4 Kabellänge 1700mm Rohr ø 10mm Tauchheizkörper Kältetechnik		
Für Modelle:	GE800BT, GN1410BT, GN1410BTM, GN1410TN, GN1410TNG, GN1410TNM, PA800BT, PA800TN		

Schalter und Taster

Wippenschalter/-taster

30x22mm



GEV-Nr.	347791	Vergl.-Nr.	S900.01 SL0621
Beschreibung	Wippenschalter Einbaumaß 30x22mm grün 2NO 230V 20A beleuchtet 0-I Anschluss Flachstecker 6,3mm Umgebungstemperatur max. 125/55°C Schutzart IP65 mit Gummikragen		
Für Modelle:	BC2PS, BC3PS, BI4719, BM11, BM1780, BM1782, BM1784, BM1786, BM21, BM31, BMS1781, BMS1783, BMS1785, BMV11, BMV21, BMV31, CA1439R, CA1439RG, CA1440AC, CA1440ACG, CAR2779, CAR2780, CAR2780BT, CL2772, CL2774, CL2774W, CL2775, CL2775W, CL2776, CL2776W, CL2777, CL2777W, CL2778, CL2778W, CL2781, CL2781W, CL2782, CL2782W, CL2784, CL2786, CL2786W, CL2787, CL2787BT, CL2787BTW, CL2787W, CL2788, CL2788BT, CL2788BTW, CL2788W, CS1751...(Weitere Modelle finden Sie in unserem Webshop)		

Mikroschalter

mit Drucktaste

Schalter mit Schnappbefestigung



GEV-Nr.	346772	Vergl.-Nr.	GN650TN.48 RC0228
Beschreibung	Mikroschalter mit Drucktaste 250V 5A 1CO Anschluss Flachstecker 4,8mm L 24x27mm Umgebungstemperatur max. 85°C Betätigungskraft: 160g		
Für Modelle:	GE800BT, GN1200BT, GN1200DT, GN1200DTV, GN1200TN, GN1410BT, GN1410BTM, GN1410TN, GN1410TNG, GN1410TNM, GN600BT, GN600DTV, GN600TN, GN650BT, GN650BTG, GN650BTM, GN650TN, GN650TNG, GN650TNM, GNB1200BT, GNB1200TN, GNB600BT, GNV1200DT, GNV600DT, PA800BT, PA800TN, SNACK400BT, SNACK400SBT, SNACK400STN, SNACK400TN		

Lampen

Signallampen

Signallampen komplett

30x22mm



GEV-Nr.	346965	Vergl.-Nr.	GN650BT.08 RC0109
Beschreibung	Signallampe Einbaumaß 30x22mm 230V gelb		

Elektronikregler

DIXELL

Kühlstellenregler

Einbauversion



1

GEV-Nr.	378256	Vergl.-Nr.	S900.02
Beschreibung	Elektronikregler DIXELL XR02CX-5N0C0 Einbaumaß 71x29mm Einbautiefe 56mm 230V Spannung AC NTC Relaisausgänge 1 CO-8A(4) NTC Schutzart IP54 Abtaufunktion/Zeitsteuerung -40 bis +110°C Anzeige 2½-stellig		
Für Modelle:	BC2PS, GN1200BT, GN1200DT, GN1200TN, GN2200TN, GN600BT, GN600TN, GNB600BT, PS200, PS300, PS900, S900, S901TOP, S902STD, S903, S903PZ, S903TOP, SNACK340, SNACK400SBT, SNACK400STN, SNACK400TN, SNACK638, SS45BT, VRX1200-330, VRX1200-380, VRX1400-330, VRX1500-330, VRX1500-380, VRX1800-330, VRX1800-380, VRX2000-330, VRX2000-380		
Ersatzteile für	378256		
	GEV-Nr.	Vergl.-Nr.	RC0321 S900.32
	Temperaturfühler NTC 10kOhm Kabel Thermoplast Fühler -40 bis +110°C Kabel -40 bis +110°C Fühler ø6x14mm Kabellänge 3m ohne Verschraubung 2-adrig		
Zubehör für	378256		
	GEV-Nr.	Vergl.-Nr.	—
	Temperaturfühler NTC 10kOhm Kabel PVC Fühler -20 bis +80°C Kabel -10 bis +100°C Fühler ø7x24,5mm Kabellänge 1.5m ohne Verschraubung 2-adrig		
	GEV-Nr.	Vergl.-Nr.	—
	Temperaturfühler NTC 10kOhm Kabel PVC Fühler -20 bis +80°C Kabel -10 bis +100°C Fühler ø6x25mm Kabellänge 3m 2-adrig		
	GEV-Nr.	Vergl.-Nr.	—
	Temperaturfühler NTC 10kOhm Kabel Thermoplast Fühler -40 bis +110°C Kabel -40 bis +110°C Fühler ø6x14mm Kabellänge 1.5m ohne Verschraubung 2-adrig		
	GEV-Nr.	Vergl.-Nr.	RC0321 S900.32
	Temperaturfühler NTC 10kOhm Kabel Thermoplast Fühler -40 bis +110°C Kabel -40 bis +110°C Fühler ø6x14mm Kabellänge 3m ohne Verschraubung 2-adrig		
	GEV-Nr.	Vergl.-Nr.	—
	Temperaturfühler NTC 10kOhm Kabel Silikon Fühler -40 bis +110°C Kabel -50 bis +180°C Fühler ø6x40mm Kabellänge 3m 2-adrig		
	GEV-Nr.	Vergl.-Nr.	—
	Temperaturfühler NTC 10kOhm Kabel Silikon Fühler -40 bis +110°C Kabel -50 bis +180°C Fühler ø6x40mm Kabellänge 1.5m ohne Verschraubung 2-adrig		



1

GEV-Nr.	378273	Vergl.-Nr.	GN650BT.16 GN650TN.47 SLO050
Beschreibung	Elektronikregler DIXELL XR06CX-5N0C1 Einbaumaß 71x29mm 230V Spannung AC NTC -40 bis +110°C Anzeige 2½-stellig DEF Relay 8A Lüfterrelais 8A KompRelais 20A		
Für Modelle:	GE800BT, GN1200DTV, GN1410BT, GN1410BTM, GN1410TN, GN1410TNG, GN1410TNM, GN2100BT, GN2100TN, GN2100TNG, GN3100BT, GN3100TN, GN3100TNG, GN3200BT, GN4100BT, GN4100TN, GN4100TNG, GN4200TN, GN600DTV, GN650BT, GN650BTM, GN650TN, GN650TNG, GN650TNM, GNV1200DT, GNV600DT, PA2100TN, PA3100TN, PA800BT, PA800TN, PZ2600TN, PZ2610TN, PZ3600TN, SNACK2100TN, SNACK3100TN, SNACK4100TN, U-GN2100TN, U-GN3100TN, U-GN4100TN		

EKTRON

Kühlstellenregler

Einbauversion



1

GEV-Nr.	378034	Vergl.-Nr.	CO0862 SL0531
Beschreibung	Elektronikregler EKTRON Typ REK31ED-0021 Einbaumaß 71x29mm 230V Spannung AC NTC/PTC Relaisausgänge 1 CO-8A(4) NTC/PTC NTC/PTC Einbautiefe 71mm Abtaufunktion Ja -50 bis +95°C Anzeige 3-stellig		
Für Modelle:	CA1439RG, CAR2779, CAR2780, CAR2780BT, CLR2782, CLR2782W, CLR2786, CLR2786W, CLR2787, CLR2787BT, CLR2787BTW, CLR2787W, CLR2788, CLR2788BT, CLR2788BTW, CLR2788W, ELR2825, ELR2825W, ELR2826, ELR2826W, ELR2827, ELR2827W, ELS2830, GN1200BT, GN1200TN, GN600BT, GN600TN, GNB1200BT, GNB1200TN, PS200, PS300, PS900, RI330, RI380, S900, S901, S902, S903, S903PZ, S903TOP, SNACK340, SNACK400BT, SNACK400TN, SNACK638, SS45		
Zubehör für	378034		
	GEV-Nr.	Vergl.-Nr.	—
	Temperaturfühler PTC 1kOhm Kabel PVC Fühler -50 bis +150°C Kabel -10 bis +100°C Fühler ø6x30mm Kabellänge 3m ohne Verschraubung 2-adrig		
	GEV-Nr.	Vergl.-Nr.	—
	Temperaturfühler PTC 1kOhm Kabel Thermoplast Fühler -50 bis +150°C Kabel -40 bis +110°C Fühler ø6x14mm Kabellänge 3m 2-adrig Widerstand 1kOhm		



			
1			
GEV-Nr.	378118	Vergl.-Nr.	CO0019
Beschreibung	Elektronikregler EKTRON Typ REK33-1021 Einbaumaß 71x29mm 230V Spannung AC PTC Relaisausgänge 3 NO-16A NO-8A(4) NO-8A(4) PTC PTC Einbautiefe 71mm -50 bis +95°C Anzeige 3½-stellig		
Zubehör für	378118		
	GEV-Nr.	379052	Vergl.-Nr.
	Temperaturfühler PTC 1kOhm Kabel Silikon Fühler -50 bis +150°C Kabel -50 bis +180°C Fühler ø6x40mm Kabellänge 1.5m ohne Verschraubung 2-adrig		

Fühler

Universalfühler

Temperaturfühler

			
1			
GEV-Nr.	379161	Vergl.-Nr.	RC0321 S900.32
Beschreibung	Temperaturfühler NTC 10kOhm Kabel Thermoplast Fühler -40 bis +110°C Kabel -40 bis +110°C Fühler ø6x14mm Kabellänge 3m ohne Verschraubung 2-adrig		
Für Modelle:	BC2PS, BC3PS, EF400, EF600, ER400, ER400G, ER600, ER600G, GN1200BT, GN1200TN, GN600BT, GN600TN, GNB1200BT, GNB1200TN, PS200, PS300, PS900, RI330, RI380, S900, S901, S901TOP, S902, S902STD, S903, S903PZ, S903TOP, SNACK400BT, SNACK400TN, SS45, SS45BT		

Elektroniken

Platinen

			
1			
GEV-Nr.	402813	Vergl.-Nr.	HR600.07 RC0419
Beschreibung	Anzeigeplatine für Kühlschrank L 150mm B 37mm passend für ER400/600 mit Potentiometer mit Thermostat Typ LTC-20HT		
Für Modelle:	ER400, ER400G, ER600, ER600G		

			
1			
GEV-Nr.	402812	Vergl.-Nr.	HF600.07 RC0429
Beschreibung	Anzeigeplatine Kühlschrank für Gerät EF400/600 L 150mm B 38mm mit Potentiometer mit Thermostat Typ LTC-24HT		
Für Modelle:	EF600		

Kompressoren

ACC/ZEL

R134A

LBP 1-phasig

Niedrige Verdampfungstemperatur unter -20 °C

			
1			
GEV-Nr.	605126	Vergl.-Nr.	RC0047 S900.41
Beschreibung	Kompressor Kältemittel R134a Typ OF1350A 220-240V 50Hz LBPkg 1/4HP Leistungsaufnahme 158W Hubraum 7.5cm³ RSIR H 183mmWWWWWWWWWW ZEL		
Für Modelle:	BC3PS, ER600, ER600G, GN1200DT, GN1200DTV, GN2100TN, GN2100TNG, GN2200TN, GN3100TN, GN3100TNG, GN600DTV, GN600TN, GNV1200DT, GNV600DT, PA2100TN, PS200, PS300, PS900, PZ2600TN, PZ2610TN, S900, S901, S901TOP, S902, S902STD, SNACK176, SNACK2100TN, SNACK251, SNACK290, SNACK3100TN, SNACK340, SNACK400STN, SNACK400TN, U-GN2100TN, U-GN3100TN, VRX2000-330, VRX2000-380		



Lüfter

Axiallüfter

Import



GEV-Nr.	601604 ¹	Vergl.-Nr.	RC0011 RC0654 S900.34
Beschreibung	Axiallüfter L 119mm B 119mm H 38mm 230VAC 50/60Hz 17/15W Lager Gleitlager Hersteller-Nr. AA1282HS-AT Anschluss Kabel 300mm Lüfterrad ø 110mm Temp.Best. 70°C Stromaufnahme 0.1A Leistung 130m ³ /h 2600U/min		
Für Modelle:	BC2PS, BC3PS, EF400, EF600, ER400, ER400G, ER600, ER600G, GN1200BT, GN1200DT, GN1200TN, GN600BT, GN600TN, GNB1200BT, GNB1200TN, GNB600BT, PS200, PS300, PS900, RI330, RI380, S900, S901, S902, S902STD, S903, S903PZ, S903TOP, SNACK176, SNACK251, SNACK290, SNACK340, SNACK400BT, SNACK400SBT, SNACK400STN, SNACK400TN, SNACK638, SS45, SS45BT, VRX1200-330, VRX1200-380, VRX1400-330, VRX1500-330, VRX1500-380, VRX1800-330, VRX1800-380, VRX2000-330, VRX2000-380		

¹mit Gleitlager



GEV-Nr.	601055 ¹	Vergl.-Nr.	GN2100TN.35	
Beschreibung	Axiallüfter L 92mm B 92mm H 25mm 230VAC 50/60Hz 14,5/14W Lager Kugellager Anschluss Flachstecker 2,8mm Metall ADDA Lüfterrad ø 85mm Temp.Best. 70°C			
Für Modelle:	GN2100BT, GN2100TN, GN2100TNG, GN2200TN, GN3100BT, GN3100TN, GN3100TNG, GN4100BT, GN4100TN, GN4100TNG, GN4200TN, PA2100TN, PA3100TN, PZ2600TN, PZ2610TN, PZ3600TN, SNACK2100TN, SNACK3100TN, SNACK340, SNACK4100TN, SNACK638			
Zubehör für	601055			
	GEV-Nr.	550898	Vergl.-Nr.	—
	Anschlusskabel Kabellänge 2000mm Anschluss F 2,8 Anschlussabstand 7.9mm für Axiallüfter			
	GEV-Nr.	691103	Vergl.-Nr.	—
	Schutzgitter ø 90mm BA 83mm für Axiallüfter 92mm			

¹mit Kugellager

Kältelüfter

Kältemotoren Universal

ebm-papst

Sonstige



GEV-Nr.	601783	Vergl.-Nr.	GN650TN.34 S900.37	
Beschreibung	Lüftermotor 10W 230V 50/60Hz L3 87mm B 67mm Kabellänge 400mm 1300U/min ebm-papst M4Q045-CA03-51/C18 3 Befestigungsoptionen Lager Gleitlager für Kühltische			
Für Modelle:	GN1200BT, GN1200DT, GN1200DTV, GN1200TN, GN1410BT, GN1410BTM, GN1410TN, GN1410TNG, GN1410TNM, GN2100BT, GN2100TN, GN2100TNG, GN2200TN, GN3100BT, GN3100TN, GN3100TNG, GN3200BT, GN4100BT, GN4100TN, GN4100TNG, GN4200TN, GN600DTV, GN600TN, GN650BT, GN650BTG, GN650BTM, GN650TN, GN650TNG, GN650TNM, GNV1200DT, GNV600DT, PA2100TN, PA3100TN, PA800TN, PS200, PS300, PS900, PZ2600TN, PZ2610TN, PZ3600TN, S900, S901TOP, S902STD, S903, S903PZ, S903TOP, SNACK2100TN, SNACK3100TN, SNACK340, SNACK400SBT... (Weitere Modelle finden Sie in unserem Webshop)			
Ersatzteile für	601783			
	GEV-Nr.	601413	Vergl.-Nr.	—
	Befestigungsplatte passend für Lüfterrad AD ø 32mm Welle ø 7 BA 26mm			
Zubehör für	601783			
	GEV-Nr.	601385	Vergl.-Nr.	—
	Lüfterrad saugend ø 172mm Lüfterradbefestigung 25.4mm Flügelwinkel 34° B 42mm Aluminium			

Zubehör

Lüftergitter





GEV-Nr.	601738	Vergl.-Nr.	RC0219 S900.38
Beschreibung	Schutzgitter für Lüfterrad ø 170mm ø 216mm H 30mm BA1 224 bis 254mm BA2 94.5mm		
Für Modelle:	PS200, PS900, S901TOP, S902STD, SNACK3100TN, SNACK638, SS45BT, U-GN2100TN, U-GN3100TN, U-GN4100TN		



Kältemotoren komplett



1

GEV-Nr.	601739	Vergl.-Nr.	GN650BT.11 RC0229
Beschreibung	Ventilator 230V 10W 50Hz Lüfterrad ø 230mm Achslänge 20mm L 86mm B 67mm Flügelwinkel 34° Anschluss Gabelkabelschuh M4 Kabellänge 1100mm		
Für Modelle:	GE800BT, GN1200BT, GN1200DT, GN1200DTV, GN1200TN, GN1410BT, GN1410BTM, GN1410TN, GN1410TNG, GN1410TNM, GN600BT, GN600DTV, GN600TN, GN650BT, GN650BTG, GN650BTM, GN650TN, GN650TNG, GN650TNM, GNB1200BT, GNB1200TN, GNB600BT, GNV1200DT, GNV600DT, PA800BT, PA800TN, PS200, PS300, PS900, S900, S901, S902, S903, S903PZ, S903TOP, SNACK340, SNACK400BT, SNACK400TN, SNACK638, SS45		
Ersatzteile für	601739		
	GEV-Nr.	601172	Vergl.-Nr. —
	Lüfterrad saugend ø 230mm Lüfterradbefestigung 25.4mm Flügelwinkel 34° B 50mm Aluminium		
	GEV-Nr.	601757	Vergl.-Nr. —
	Lüftermotor 10W 230V 50/60Hz L1 43.5mm L3 82mm B 67mm Kabellänge 1500mm 1300/1550U/min ebm-papst M4Q045-CA03-75 5 Befestigungsoptionen Lager Gleitlager		
	GEV-Nr.	601783	Vergl.-Nr. GN650TN.34 S900.37
	Lüftermotor 10W 230V 50/60Hz L3 87mm B 67mm Kabellänge 400mm 1300U/min ebm-papst M4Q045-CA03-51/C18 3 Befestigungsoptionen Lager Gleitlager für Kühltische		



1

GEV-Nr.	602042	Vergl.-Nr.	RC1184
Beschreibung	Ventilator 240V 7.5W 50/60Hz Lüfterrad ø 100mm BA 95mm ø 150mm		

Elektrozubehör

Kabel

Geräteleitungen



1

GEV-Nr.	551085	Vergl.-Nr.	SL0130
Beschreibung	Kabel CEE7/7 Typ E+F 3-polig Kontakte P+N+PE 1.5mm ² max. 16A max 230V 2m mit Stecker H05VV-F 3G1,5		
Für Modelle:	BI4719, BM111, BM1780, BM1782, BM1784, BM1786, BM21, BM31, BMS1781, BMS1783, BMS1785, BMV11, BMV21, BMV31, CA1439R, CA1439RG, CA1440AC, CA1440ACG, CAR2779, CAR2780, CAR2780BT, CL2772, CL2774, CL2774W, CL2775, CL2775W, CL2776, CL2776W, CL2777, CL2777W, CL2778, CL2778W, CL2781, CL2781W, CLR2782, CLR2782W, CLR2784, CLR2786, CLR2786W, CLR2787, CLR2787BT, CLR2787BTW, CLR2787W, CLR2788, CLR2788BT, CLR2788BTW, CLR2788W, CS1751, CS1753, CS1755...(Weitere Modelle finden Sie in unserem Webshop)		

Klemmdosen



1

GEV-Nr.	551214	Vergl.-Nr.	S900.48
Beschreibung	Klemmdose 4-polig L 90mm B 52mm H 28mm mit Zugentlastung VPE 1 Stück		
Für Modelle:	PS200, PS300, PS900, S900, S901TOP, S902STD, S903, S903PZ, S903TOP, SNACK176, SNACK251, SNACK290, SS45BT, VRX1200-330, VRX1200-380, VRX1400-330, VRX1500-330, VRX1500-380, VRX1800-330, VRX1800-380, VRX2000-330, VRX2000-380		



1

GEV-Nr.	551090	Vergl.-Nr.	GN650TN.16 RC0235
Beschreibung	Klemmdose 5-polig L 95mm B 63mm H 27mm		
Für Modelle:	EF400, EF600, ER400, ER400G, ER600, ER600G, GE800BT, GN1200BT, GN1200DT, GN1200DTV, GN1200TN, GN1410BT, GN1410BTM, GN1410TN, GN1410TNG, GN1410TNM, GN2100BT, GN2100TN, GN2100TNG, GN2200TN, GN3100BT, GN3100TN, GN3100TNG, GN3200BT, GN4100BT, GN4100TN, GN4100TNG, GN4200TN, GN600BT, GN600DTV, GN600TN, GN650BT, GN650BTG, GN650BTM, GN650TN, GN650TNG, GN650TNM, GNB1200BT, GNB1200TN, GNB600BT, GNV1200DT, GNV600DT, PA2100TN, PA3100TN, PA800BT, PA800TN, PZ2600TN, PZ2610TN, RI330, RI380...(Weitere Modelle finden Sie in unserem Webshop)		



Gerätespezifische Bauteile

für Kühlschränke

Gehäuse und Blenden

Kappen



GEV-Nr.	692372	Vergl.-Nr.	PS900.03 RC0736
Beschreibung	Kappe grau ø 16.5mm Einbau ø 12.5mm H 7mm VPE 1 Stück		
Für Modelle:	PS200, PS300, PS900, RI330, RI380, S900, S901, S901TOP, S902, S902STD, S903, S903PZ, S903TOP, SNACK340, SNACK400SBT, SNACK400STN, SNACK638, SS45, SS45BT, VRX1200-330, VRX1200-380, VRX1400-330, VRX1500-330, VRX1500-380, VRX1800-330, VRX1800-380, VRX2000-330, VRX2000-380		

Sonstige



GEV-Nr.	696413	Vergl.-Nr.	GN650TN.01 RC0316
Beschreibung	Schraube Gewinde M6 L 18mm		
Für Modelle:	GN1200BT, GN1200TN, GN1410BT, GN1410BTM, GN1410TN, GN1410TNG, GN1410TNM, GN600BT, GN600TN, GN650BT, GN650BTG, GN650BTM, GN650TN, GN650TNG, GN650TNM, GNB600BT, SNACK400SBT, SNACK400STN, SNACK400TN		

für Kühltische

Ersatzteile und Zubehör



GEV-Nr.	697917	Vergl.-Nr.	CO0140 S900.29
Beschreibung	Befestigungsplatte mit Gegenhalter Gewinde M5		
Für Modelle:	PS200, PS300, S900, S902STD, S903		
Zubehör für	697917		
	GEV-Nr.	Vergl.-Nr.	CO0139 S900.28
	697916		
	Schraubbolzen mit Mutter L 8mm Gewinde M5 ø 6mm		



GEV-Nr.	697916	Vergl.-Nr.	CO0139 S900.28
Beschreibung	Schraubbolzen mit Mutter L 8mm Gewinde M5 ø 6mm		
Für Modelle:	PS200, PS300, PZ2610TN, S900, S902STD, S903		
Zubehör für	697916		
	GEV-Nr.	Vergl.-Nr.	CO0140 S900.29
	697917		
	Befestigungsplatte mit Gegenhalter Gewinde M5		

für Saladetten

Ersatzteile und Zubehör



GEV-Nr.	697917	Vergl.-Nr.	CO0140 S900.29
Beschreibung	Befestigungsplatte mit Gegenhalter Gewinde M5		
Für Modelle:	PS200, PS300, S900, S902STD, S903		
Zubehör für	697917		
	GEV-Nr.	Vergl.-Nr.	CO0139 S900.28
	697916		
	Schraubbolzen mit Mutter L 8mm Gewinde M5 ø 6mm		



GEV-Nr.	697916	Vergl.-Nr.	CO0139 S900.28
Beschreibung	Schraubbolzen mit Mutter L 8mm Gewinde M5 ø 6mm		
Für Modelle:	PS200, PS300, PZ2610TN, S900, S902STD, S903		
Zubehör für	697916		
	GEV-Nr.	Vergl.-Nr.	CO0140 S900.29
	697917		
	Befestigungsplatte mit Gegenhalter Gewinde M5		

für Spülmaschinen

Haubenmechaniken für Spülmaschinen

Laufrollen



GEV-Nr.	694774	Vergl.-Nr.	RC1207
Beschreibung	Laufrolle für Vitrine L 42mm		

Verschlüsse

Abschließvorrichtungen

Herstellerspezifisch

FORCAR



GEV-Nr.	692338	Vergl.-Nr.	RC0725
Beschreibung	Haken H 25mm L 44mm B 30mm Loch ø 3.5mm für Schloss		



GEV-Nr.	692188	Vergl.-Nr.	RC0128
Beschreibung	Schließzylinder mit Hebel ø 17.3mm Drehwinkel 90° Riegelänge 49mm Riegelbreite 13mm		
Für Modelle:	GN1200BT, GN1200TN, GN600BT, GN600TN, GNB1200BT, GNB1200TN, SNACK340, SNACK400BT, SNACK400TN, SNACK638		
Zubehör für	692188		



GEV-Nr.	692338	Vergl.-Nr.	RC0725
Beschreibung	Haken H 25mm L 44mm B 30mm Loch ø 3.5mm für Schloss		



GEV-Nr.	692148	Vergl.-Nr.	GN2100TN.02 GN650TN.86 RC0243 RC0425
Beschreibung	Schließzylinder mit Hebel ø 17.5mm		
Für Modelle:	EF400, EF600, ER400, ER400G, ER600, ER600G, GE800BT, GN1200BT, GN1200DT, GN1200DTV, GN1200TN, GN1410BT, GN1410BTM, GN1410TN, GN1410TNG, GN1410TNM, GN2100BT, GN2100TN, GN2100TNG, GN2200TN, GN3100BT, GN3100TN, GN3100TNG, GN3200BT, GN4100BT, GN4100TN, GN4100TNG, GN4200TN, GN600BT, GN600DTV, GN600TN, GN650BT, GN650BTG, GN650BTM, GN650TN, GN650TNG, GN650TNM, GNB600BT, GNV1200DT, GNV600DT, PA2100TN, PA3100TN, PA800BT, PA800TN, PZ2600TN, PZ2610TN, PZ3600TN, SNACK176, SNACK2100TN, SNACK251...(Weitere Modelle finden Sie in unserem Webshop)		

Scharniere

Federscharniere

Universal

INTERKLIMAT

Scharniere

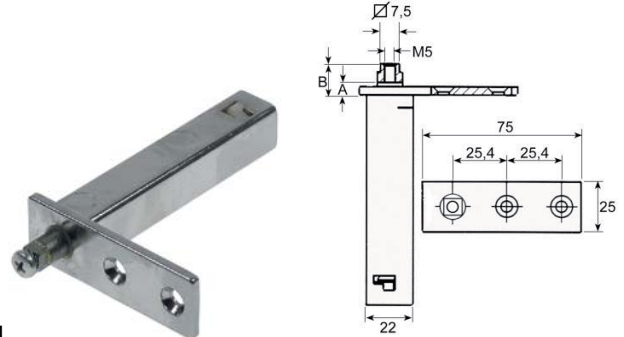

GEV-Nr.	690622	Vergl.-Nr.	GN650TN.14 RC0089
Beschreibung	Federscharnier Serie 28L EP links/rechts L 75mm B 25mm H 103mm A 13mm B 18mm Einbaumaß 22x22mm Aufnahme 7,5x7,5 Kaltgeräte		
Für Modelle:	GE800BT, GN1200BT, GN1200DT, GN1200DTV, GN1200TN, GN1410BT, GN1410BTM, GN1410TN, GN1410TNG, GN1410TNM, GN2100BT, GN2100TN, GN2100TNG, GN2200TN, GN3100BT, GN3100TN, GN3100TNG, GN3200BT, GN4100BT, GN4100TN, GN4100TNG, GN4200TN, GN600BT, GN600DTV, GN600TN, GN650BT, GN650BTG, GN650BTM, GN650TN, GN650TNG, GN650TNM, GNB1200BT, GNB1200TN, GNB600BT, GNV1200DT, GNV600DT, PA2100TN, PA3100TN, PA800BT, PA800TN, PZ2600TN, PZ2610TN, SNACK2100TN, SNACK3100TN, SNACK340, SNACK400BT, SNACK400SBT, SNACK400STN, SNACK400TN, SNACK4100TN...(Weitere Modelle finden Sie in unserem Webshop)		

Türlager





GEV-Nr.	700975	Vergl.-Nr.	HF600.19 RC0536
Beschreibung	Bolzen L 20mm EP oben/unten Gewinde M5 ø 7mm für Scharnier		
Für Modelle:	EF400, EF600, ER400, ER400G, ER600, ER600G		





GEV-Nr.	701257	Vergl.-Nr.	S900.06
Beschreibung	Bolzen L 25mm EP oben Gewinde M5 ø 7mm komplett für Türscharnier VPE 1 Stück		
Für Modelle:	GE800BT, GN1200BT, GN1200DT, GN1200DTV, GN1200TN, GN1410BT, GN1410BTM, GN1410TN, GN1410TNG, GN1410TNM, GN600BT, GN600DTV, GN600TN, GN650BT, GN650BTM, GN650TN, GN650TNG, GN650TNM, GNB600BT, GNV1200DT, PA800BT, PA800TN, PS200, PS300, PS900, S900, S901TOP, S902STD, S903, S903PZ, S903TOP, SNACK400TN, SS45BT		





 <p>1</p>			
GEV-Nr.	701032	Vergl.-Nr.	GN2100TN.03 GN2100TN.05 GN2100TN.06 RC0175 RC0652
Beschreibung	Bolzen L 32.4mm EP oben Gewinde M8x1,25 ø 5/7mm mit Mutter für Tür		
Für Modelle:	GN2100BT, GN2100TN, GN2100TNG, GN2200TN, GN3100BT, GN3100TN, GN3100TNG, GN4100BT, GN4100TN, GN4100TNG, GN4200TN, PA2100TN, PA3100TN, PS200, PS300, PS900, PZ2600TN, PZ2610TN, PZ3600TN, S900, S901, S902, S903, S903PZ, S903TOP, SNACK2100TN, SNACK3100TN, SNACK4100TN, SS45, U-GN2100TN, U-GN3100TN, U-GN4100TN		

 <p>1</p>			
GEV-Nr.	700976	Vergl.-Nr.	GN2100TN.07O RC0176
Beschreibung	Buchse L 20mm ø 9mm ID ø 7.1mm für Scharnier		
Für Modelle:	PS200, PS300, PS900, S900, S901, S902, S903, S903PZ, S903TOP, SNACK340, SNACK638, SS45		

 <p>1</p>			
GEV-Nr.	692258	Vergl.-Nr.	S900.55
Beschreibung	Scharnier L 30mm B 30mm H 45mm EP unten links Materialstärke 3mm		

 <p>1</p>			
GEV-Nr.	692374	Vergl.-Nr.	S900.05
Beschreibung	Scharnier L 30mm B 30mm H 45mm EP unten rechts Materialstärke 3mm VPE 1 Stück		
Für Modelle:	PS200, PS300, PS900, S900, S901TOP, S902STD, S903, S903PZ, S903TOP, SS45BT		

 <p>1</p>			
GEV-Nr.	700974	Vergl.-Nr.	HF600.08 RC0535
Beschreibung	Scharnier L 49mm B 40mm H 43mm EP unten Materialstärke 4mm		
Für Modelle:	EF400, EF600, ER400, ER400G, ER600, ER600G		

 <p>1</p>			
GEV-Nr.	700973	Vergl.-Nr.	HF600.01 RC0534
Beschreibung	Scharnier L 51mm B 40mm EP oben Materialstärke 3mm		
Für Modelle:	EF400, EF600, ER400, ER400G, ER600, ER600G		

 <p>1</p>			
GEV-Nr.	701033	Vergl.-Nr.	GN2100TN.28 RC0063
Beschreibung	Scharnierlager EP links unten L 86mm B 44mm H 19mm LA 25mm Achsaufnahme 8x8mm		

 <p>1</p>			
GEV-Nr.	701035	Vergl.-Nr.	GN650TN.51 RC0088
Beschreibung	Scharnierlager EP oben links L 100mm B 63mm H 30mm LA 60mm Achsaufnahme 8x8mm		

 <p>1</p>			
GEV-Nr.	701038	Vergl.-Nr.	GN650TN.15 RC0087
Beschreibung	Scharnierlager EP oben rechts L 99mm B 64mm H 30mm LA 60mm Achsaufnahme 8x8mm		
Für Modelle:	GE800BT, GN1200BT, GN1200DT, GN1200DTV, GN1200TN, GN1410BT, GN1410BTM, GN1410TN, GN1410TNG, GN1410TNM, GN600BT, GN600DTV, GN600TN, GN650BT, GN650BTM, GN650TN, GN650TNM, GNB1200BT, GNB1200TN, GNB600BT, GNV1200DT, PA800BT, PA800TN, SNACK400BT, SNACK400SBT, SNACK400STN, SNACK400TN		

 <p>1</p>			
GEV-Nr.	701034	Vergl.-Nr.	RC0064
Beschreibung	Scharnierlager EP unten rechts L 86mm B 46mm H 17mm LA 25mm Achsaufnahme 8x8mm		

Gerätefüße und Endkappen

Einschraubfüße



GEV-Nr.	700972	Vergl.-Nr.	S900.13 SL0494
Beschreibung	Gerätefuß Gewinde M10 Gewinde L 16mm ø 29mm H 11.5mm VPE 1 Stück für Kühlschrank		
Für Modelle:	BM11, BM21, BM31, CA1439B, CA1439BG, CA1440B, CA1440BG, EF400, EF600, ER400, ER400G, ER600, ER600G, GE800BT, GN2100BT, GN2100TN, GN2100TNG, GN2200TN, GN3100BT, GN3200BT, GN4100BT, GN4100TN, GN4100TNG, GN4200TN, GN650BT, GN650BTG, GN650BTM, GN650TN, GN650TNG, GN650TNM, PA2100TN, PA3100TN, PA800BT, PA800TN, PS200, PS300, PS900, PZ2600TN, S900, S901, S901TOP, S902, S902STD, S903, S903PZ, S903TOP, SNACK2100TN, SNACK340, SNACK4100TN, SNACK638... (Weitere Modelle finden Sie in unserem Webshop)		

Roste und Stellschienen

Gitterroste

Universal

ohne Aufkantung

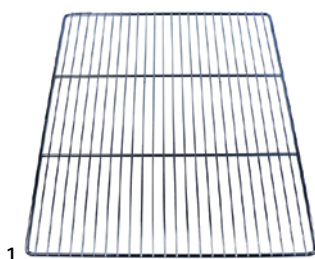

GEV-Nr.	970123	Vergl.-Nr.	GN650TN.08 GRIZ1	
Beschreibung	Gitterrost B 650mm T 530mm GN 2/1 Edelstahl Drahtstärke Rahmen 7.8mm Drahtstärke Längsdrähte 3.8mm Querstreben 2 passend für Kühlschrank			
Für Modelle:	GN1200DTV, GN1410BT, GN1410BTM, GN1410TN, GN1410TNG, GN1410TNM, GN600DTV, GN650BT, GN650BTG, GN650BTM, GN650TN, GN650TNG, GN650TNM, GNV1200DT, GNV600DT			
Zubehör für	970123			
	GEV-Nr.	690330	Vergl.-Nr.	—
	Stellschienenträger L 1000mm B 22mm H 4mm Lochgröße 3x8mm LA 12.5mm Edelstahl			
	GEV-Nr.	694700	Vergl.-Nr.	—
	Fachbodenträger L 31/28mm B 22mm H 18mm CNS VPE 12 Stück			
	GEV-Nr.	694701	Vergl.-Nr.	—
	Fachbodenträger L 31/28mm B 22mm H 17mm CNS mit Haken VPE 12 Stück			

mit Aufkantung



GEV-Nr.	970772	Vergl.-Nr.	GRP600
Beschreibung	Gitterrost B 650mm T 530mm GN 2/1 H 40mm Stahl kunststoffbeschichtet mit Anschlag Querstreben 4		

Stellschienen und Träger

Herstellerspezifisch



GEV-Nr.	694507	Vergl.-Nr.	AG G350.08 RC0361
Beschreibung	Fachbodenträger L 38/26mm B 22mm H 24mm CNS VPE 4 Stück		
Für Modelle:	BC2PS, BC3PS, SNACK176, SNACK251, SNACK290, SNACK340, SNACK638		



GEV-Nr.	696388	Vergl.-Nr.	CG11 GN2100TN.31 S900.10
Beschreibung	Stellschienenpaar U-Form L 550mm B 20mm H 17mm EP links/rechts		
Für Modelle:	GN2100BT, GN2100TN, GN2100TNG, GN2200TN, GN3100BT, GN3100TN, GN3100TNG, GN3200BT, GN4100BT, GN4100TN, GN4100TNG, GN4200TN, PS200, PS300, PS900, S900, S901, S901TOP, S902, S902STD, S903, S903PZ, S903TOP, SS45, SS45BT, U-GN2100TN, U-GN3100TN, U-GN4100TN		



Dichtungen

Kälte-dichtungen

Steckdichtungen

Profil 9153

Dieses Profil kann auf Wunsch in Sondermaßen gefertigt werden

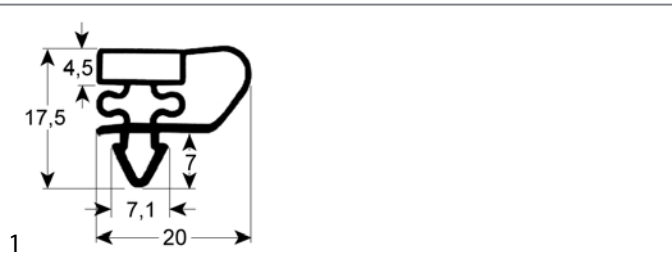

GEV-Nr.	902266	Vergl.-Nr.	N/A
Beschreibung	Kälte-dichtung Profil 9153 Bmm L 2500mm Steckmaß		

Profil 9150

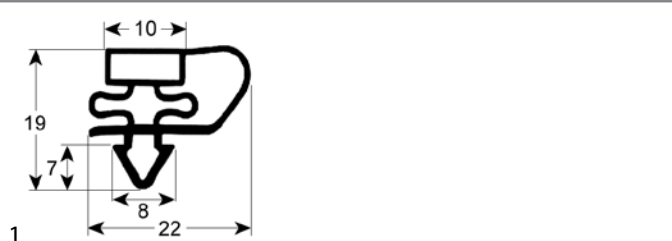

GEV-Nr.	901279	Vergl.-Nr.	RC0072 S900.08
Beschreibung	Kälte-dichtung Profil 9150 B 395mm L 490mm Steckmaß		
Für Modelle:	PS200, PS300, PS900, S900, S901, S901TOP, S902, S902STD, S903, S903PZ, S903TOP, SS45		

Profil 9157

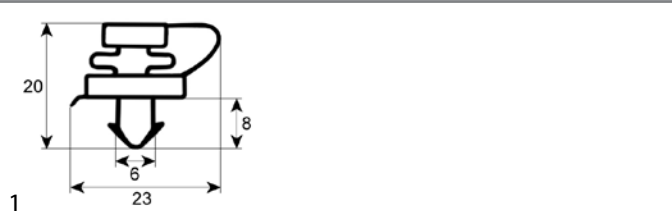

GEV-Nr.	901281	Vergl.-Nr.	HF400.03 RC0421
Beschreibung	Kälte-dichtung Profil 9157 B 570mm L 1650mm Steckmaß VPE 1		
Für Modelle:	EF400, ER400, ER400G		

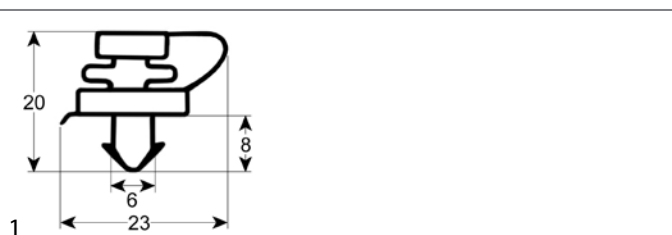

GEV-Nr.	901975	Vergl.-Nr.	RC0199 SNACK400TN.06
Beschreibung	Kälte-dichtung Profil 9157 B 615mm L 1445mm Steckmaß Steckmaß		
Für Modelle:	GN1200BT, GN1200DT, GN1200DTV, GN1200TN, GN600BT, GN600DTV, GN600TN, GNB600BT, GNV1200DT, SNACK400SBT, SNACK400STN, SNACK400TN		

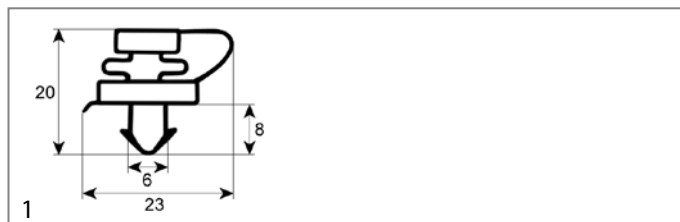

GEV-Nr.	901333	Vergl.-Nr.	GN650TN.13 RC0153
Beschreibung	Kälte-dichtung Profil 9157 B 695mm L 1477mm Steckmaß		
Für Modelle:	GE800BT, GN1410BT, GN1410TN, GN4100TN, GN4100TNG, GN4200TN, GN650BT, GN650BTG, GN650TN, PA800BT, PA800TN, PZ3600TN, SNACK4100TN		

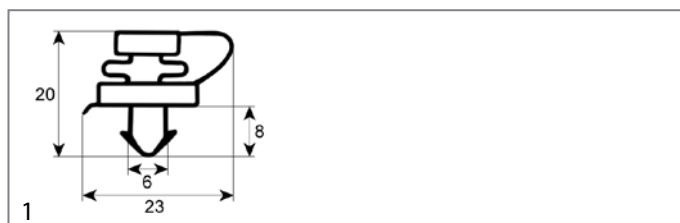

GEV-Nr.	901282	Vergl.-Nr.	HF600.06 RC0426
Beschreibung	Kälte-dichtung Profil 9157 B 750mm L 1700mm Steckmaß		
Für Modelle:	EF600, ER600, ER600G		

Profil 9041

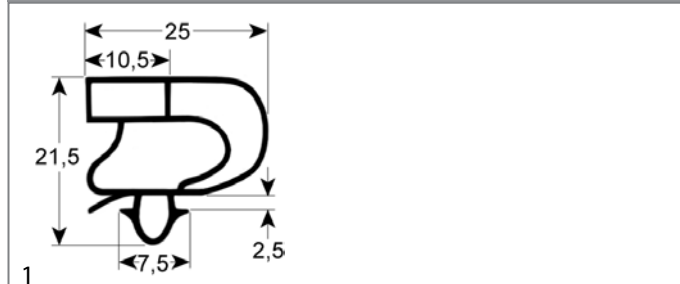

GEV-Nr.	901957	Vergl.-Nr.	GN2100TN.33 RC0041
Beschreibung	Kälte-dichtung Profil 9041 B 385mm L 595mm Steckmaß Steckmaß		
Für Modelle:	GN2100BT, GN2100TN, GN2200TN, GN3100BT, GN3100TN, GN4100BT, GN4100TN, GN4200TN, SNACK2100TN, SNACK3100TN, SNACK4100TN		

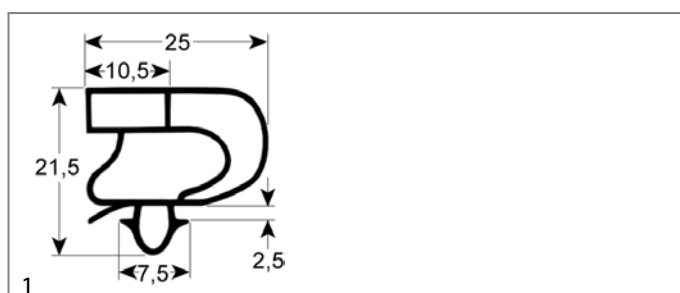

GEV-Nr.	901958	Vergl.-Nr.	PA2100TN.9 RC0162
Beschreibung	Kälte-dichtung Profil 9041 B 460mm L 592mm Steckmaß Steckmaß		
Für Modelle:	PA2100TN, PA3100TN, PZ2600TN, PZ2610TN, PZ3600TN		



Profil 9326

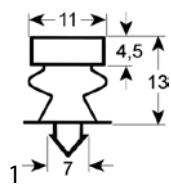

GEV-Nr.	901959	Vergl.-Nr.	RC0770
Beschreibung	Kältdichtung Profil 9326 B 535mm L 1155mm Steckmaß		



GEV-Nr.	750619	Vergl.-Nr.	RC0768
Beschreibung	Trockner Größe 30g ø 24mm L 140mm Anschluss 2,6/6,5mm VPE 1 Stück		

Kälteleitungen

Kapillarrohre



GEV-Nr.	694442	Vergl.-Nr.	RC0523 S900.43
Beschreibung	Kapillarrohr ID ø 1.15mm Kupfer VPE 1m L 300mm Kältetechnik AD ø 2.1mm		
Für Modelle:	BC2PS, BC3PS, GN1200BT, GN1200TN, GN2100BT, GN2100TN, GN2100TNG, GN2200TN, GN3100BT, GN3100TN, GN3100TNG, GN3200BT, GN4100BT, GN4100TN, GN4100TNG, GN4200TN, GN600BT, GN600TN, GNB600BT, PA2100TN, PA3100TN, PS200, PS300, PS900, PZ2600TN, PZ2610TN, PZ3600TN, S900, S901TOP, S902STD, S903, S903PZ, S903TOP, SNACK2100TN, SNACK3100TN, SNACK340, SNACK400STN, SNACK400TN, SNACK4100TN, SNACK638, SS45BT, U-GN2100TN, U-GN3100TN, U-GN4100TN		

Kältekreislaufkomponenten

Ventile

Schraderventile

Schraderventile komplett



GEV-Nr.	750101	Vergl.-Nr.	S900.42
Beschreibung	Schraderventil komplett Anschluss 1/4" SAE Rohrlänge 100mm		

Filtertrockner

Sonstige



GEV-Nr.	750618	Vergl.-Nr.	GN1410TN.14
Beschreibung	Trockner Größe 15g ø 19mm L 114mm Anschluss 2,7/6,5mm Typ XH9 VPE 1 Stück		
Für Modelle:	GE800BT, GN1200BT, GN1200DTV, GN1200TN, GN1410BT, GN1410BTM, GN1410TN, GN1410TNG, GN1410TNM, GN2100BT, GN2100TNG, GN3100BT, GN3200BT, GN4100BT, GN4100TNG, GN600BT, GN600TN, GN650BT, GN650BTG, GN650BTM, GN650TN, GN650TNG, GN650TNM, GNB600BT, GNV600DT, PA2100TN, PA3100TN, PA800BT, PA800TN, PZ2600TN, PZ3600TN, SNACK400SBT, SNACK400STN, SNACK400TN		



GEV-Nr.	750324	Vergl.-Nr.	RC0066 S900.44
Beschreibung	Trockner Größe 20g ø 23mm L 117mm Anschluss 4,8/8,3mm		
Für Modelle:	GN1200BT, GN1200TN, GN2100TN, GN2200TN, GN3100TN, GN3100TNG, GN4100TN, GN4200TN, GN600BT, GN600TN, GNB1200BT, GNB1200TN, PS200, PS300, PS900, PZ2610TN, RI330, RI380, S900, S901, S901TOP, S902, S902STD, S903, S903PZ, S903TOP, SNACK2100TN, SNACK3100TN, SNACK340, SNACK400BT, SNACK400TN, SNACK4100TN, SNACK638, SS45, SS45BT, U-GN2100TN, U-GN3100TN, U-GN4100TN, VRX1200-330, VRX1200-380, VRX1400-330, VRX1500-330, VRX1500-380, VRX1800-330, VRX1800-380, VRX2000-330, VRX2000-380		



1

GEV-Nr.	694443	Vergl.-Nr.	GN1410BT.05
Beschreibung	Kapillarrohr ID ø 1.4mm Kupfer VPE 1m L 2500mm Kältetechnik AD ø 2.8mm		
Für Modelle:	GN1410BT, GN1410BTM		



1

GEV-Nr.	694444	Vergl.-Nr.	GN1410TN.13
Beschreibung	Kapillarrohr ID ø 1.4mm Kupfer VPE 1m L 3000mm Kältetechnik AD ø 2.8mm		
Für Modelle:	GN1410TN, GN1410TNG, GN1410TNM		

Kupferrohre unisoliert



Bild nicht vorhanden

1

GEV-Nr.	694441	Vergl.-Nr.	GN650TN.40
Beschreibung	Kälteleitung isoliert Kupfer ID ø 7mm L 1.8m Saugleitung AD ø 8mm		
Für Modelle:	GE800BT, GN1410TN, GN1410TNG, GN1410TNM, GN650TN, GN650TNG, GN650TNM, PA800BT, PA800TN, SNACK400TN		



1

GEV-Nr.	694452	Vergl.-Nr.	GN2100TN.09
Beschreibung	Kälteleitung Kupfer L 0.5m VPE 1m für Verdampfer AD ø 6mm		
Für Modelle:	GN2100BT, GN2100TN, GN2100TNG, GN2200TN, GN3100BT, GN3100TN, GN3100TNG, GN3200BT, GN4100BT, GN4100TN, GN4100TNG, GN4200TN, PA2100TN, PA3100TN, PZ2600TN, PZ2610TN, PZ3600TN, U-GN2100TN, U-GN3100TN, U-GN4100TN		

Verdampfer für Kühlschränke

Herstellerspezifisch



1

GEV-Nr.	750294	Vergl.-Nr.	HR400.07 RC0605
Beschreibung	Verdampfer für Kühlschrank für Gerät ER400 L 1000mm B 440mm		
Für Modelle:	ER400, ER400G		

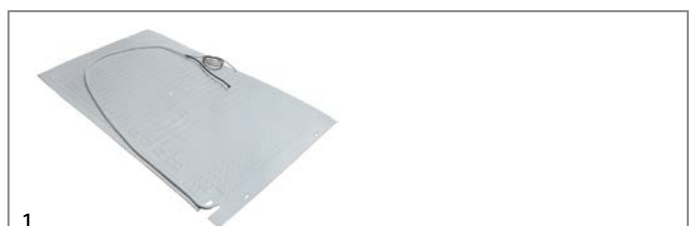

1

GEV-Nr.	750295	Vergl.-Nr.	HR600.04 RC0606
Beschreibung	Verdampfer für Kühlschrank für Gerät ER600 L 1000mm B 580mm		
Für Modelle:	ER600, ER600G		



1

GEV-Nr.	750410	Vergl.-Nr.	GN650TN.21 RC0319
Beschreibung	Verdampfer L 216mm B 130mm H 200mm Gesamtlänge 298mm Gesamtbreite 130mm Gesamthöhe 220mm		
Für Modelle:	GN650TN, GN650TNG, GN650TNM		



1

GEV-Nr.	750317	Vergl.-Nr.	GN650BT.02 RC0283
Beschreibung	Verdampfer L 298mm B 152mm H 220mm Gesamtlänge 518mm für Kühlschrank		
Für Modelle:	GN650BT, GN650BTG, GN650BTM		



1

GEV-Nr.	750322	Vergl.-Nr.	GN2100TN.18 GN2100TN21 RC0285
Beschreibung	Verdampfer L 505mm B 95mm H 265mm passend für ER400/ER400G/ER400SS		
Für Modelle:	GN2100BT, GN2100TN, GN2100TNG, GN2200TN, GN3100BT, GN3100TN, GN3100TNG, GN4100BT, GN4100TN, GN4100TNG, GN4200TN, PA2100TN, PA3100TN, PZ2600TN, PZ2610TN, PZ3600TN, SNACK2100TN, SNACK3100TN, SNACK4100TN		



1

GEV-Nr.	750318	Vergl.-Nr.	GN1410TN.01 RC0320
Beschreibung	Verdampfer L 595mm B 130mm H 220mm für Kühlschrank		
Für Modelle:	GN1410TN, GN1410TNG, GN1410TNM		

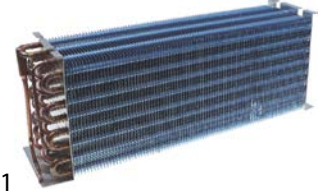

1

GEV-Nr.	750321	Vergl.-Nr.	GN1410BT.08 RC0221
Beschreibung	Verdampfer L 595mm B 130mm H 220mm für Kühlschrank		
Für Modelle:	GN1410BT, GN1410BTM		



1

GEV-Nr.	750300	Vergl.-Nr.	RC0589
Beschreibung	Verflüssiger L 170mm B 85mm H 180mm passend für ER600		

Verflüssiger

Filter



1

GEV-Nr.	694447	Vergl.-Nr.	GN2100TN.34
Beschreibung	Luftfilter für Kondensator B 175mm H 228mm Stärke 6mm		
Für Modelle:	GN2100TN, GN2200TN, GN3100TN, GN4100TN, GN4200TN, SNACK2100TN, SNACK3100TN, SNACK4100TN		



1

GEV-Nr.	694446	Vergl.-Nr.	RC0122 S903.08
Beschreibung	Luftfilter für Kondensator L 218mm B 205mm Stärke 6mm		
Für Modelle:	GN1200BT, GN1200DT, GN1200DTV, GN1200TN, GN600BT, GN600DTV, GN600TN, GN650TN, GN650TNG, GN650TNM, GN-B1200BT, GNB1200TN, GNV1200DT, GNV600DT, PA800TN, PS200, PS300, PS900, S900, S901, S902, S903, S903PZ, S903TOP, SNACK400BT, SNACK400SBT, SNACK400STN, SNACK400TN, SS45		



1

GEV-Nr.	694445	Vergl.-Nr.	GN1410BT.07 RC0556
Beschreibung	Luftfilter für Kondensator L 245mm B 215mm Stärke 6mm		
Für Modelle:	GN1410BT, GN1410BTM		



1

GEV-Nr.	694860	Vergl.-Nr.	RC1340
Beschreibung	Luftfilter L 218mm B 175mm Stärke 4.5mm		

Verflüssiger



1

GEV-Nr.	750347	Vergl.-Nr.	S900.35
Beschreibung	Verflüssiger B 220mm T 100mm H 230mm L 270mm		
Für Modelle:	PS200, PS900, S900, S901TOP, S902STD, SS45BT		



1

GEV-Nr.	750323	Vergl.-Nr.	GN1410BT.06 RC0292
Beschreibung	Verflüssiger für Kühlschrank B 140mm H 271mm L 500mm		
Für Modelle:	GN1410BT, GN1410BTM		



1

GEV-Nr.	750319	Vergl.-Nr.	RC0201 VRX.11
Beschreibung	Verflüssiger für Pizzatisch B 228mm T 77mm H 179mm		
Für Modelle:	VRX1200-330, VRX1200-380, VRX1400-330, VRX1500-330, VRX1500-380, VRX1800-330, VRX1800-380, VRX2000-330, VRX2000-380		



1

GEV-Nr.	750320	Vergl.-Nr.	GN2100TN.08 RC0286
Beschreibung	Verflüssiger für Pizzatisch B 280mm T 190mm H 230mm		
Für Modelle:	GN2100BT, GN2100TN, GN2100TNG, GN2200TN, GN3100BT, GN3100TN, GN3100TNG, GN4100BT, GN4100TN, GN4100TNG, GN4200TN, PA2100TN, PA3100TN, PZ2600TN, PZ2610TN, PZ3600TN, SNACK2100TN, SNACK3100TN, SNACK340, SNACK4100TN, SNACK638		



Befestigungsmaterialien

Schrauben

Sechskantschrauben



1

GEV-Nr.	696413	Vergl.-Nr.	GN650TN.01 RC0316
Beschreibung	Schraube Gewinde M6 L 18mm		
Für Modelle:	GN1200BT, GN1200TN, GN1410BT, GN1410BTM, GN1410TN, GN1410TNG, GN1410TNM, GN600BT, GN600TN, GN650BT, GN650BTG, GN650BTM, GN650TN, GN650TNG, GN650TNM, GNB600BT, SNACK400SBT, SNACK400STN, SNACK400TN		

A			
Abtauheizungen	2	Signallampen	2
Axiallüfter	5	Signallampen komplett	2
		Steckdichtungen	11
B		T	
Befestigungsmaterialien	16	Temperaturfühler	4
E		U	
Elektronikregler	3	Universalfühler	4
Elektrozubehör	6	V	
F		Verdampfer	13
Federscharniere	8	W	
Filtertrockner	12	Wippenschalter/-taster	2
Fühler	4		
G			
Gerätezureitungen	6		
Gitterroste	10		
Gruppe 1	12		
H			
Heizkörper	2		
Heizkörper für Kältetechnik	2		
K			
Kabel	6		
Kältedichtungen	11		
Kältekreislaufkomponenten	12		
Kälteleitungen	12		
Kältelüfter	5		
Kältemotoren Universal	5		
Kapillarrohre	12		
Klemmdosen	6		
Kompressoren	4		
Kupferrohre unisoliert	13		
L			
Lampen	2		
Lüfter	5		
M			
Mikroschalter	2		
R			
Roste und Stellschienen	10		
S			
Schalter und Taster	2		
Schraderventile	12		
Schrauben	16		
Sechskantschrauben	16		