



# Pumpen

## Wasch- und Nachspülumpen

LGB

1 Elektrokomponenten



1			
<b>GEV-Nr.</b>	499220	<b>Vergl.-Nr.</b>	GISH35-V D55
<b>Beschreibung</b>	Pumpe Eingang ø 1½" Ausgang ø 1½" Typ GISH35-V D55 230V 50Hz Phasen 1 0,17kW L 230mm Laufrichtung rechts Kondensator 5µF LGB		
<b>Ersatzteile zu</b>	499220		
	<b>GEV-Nr.</b>	365017	<b>Vergl.-Nr.</b> —
Betriebskondensator Kapazität 5µF 450V			



1			
<b>GEV-Nr.</b>	500334	<b>Vergl.-Nr.</b>	111130 ZF130SX
<b>Beschreibung</b>	Pumpe Eingang ø 1½" IG Ausgang ø 1" AG Typ ZF130SX 230V 50Hz Phasen 1 0,37kW 0,54PS L 220mm Laufrichtung rechts Kondensator 10µF LGB Eingang ø 1¼" IGmm Ausgang ø 1" AGmm		
<b>Ersatzteile zu</b>	500334		
	<b>GEV-Nr.</b>	365012	<b>Vergl.-Nr.</b> —
Betriebskondensator Kapazität 6,3µF 450V			
	<b>GEV-Nr.</b>	510122	<b>Vergl.-Nr.</b> 0002R
Pumpendeckel LGB Eingang ø 28mm Ausgang ø 26mm			
	<b>GEV-Nr.</b>	510703	<b>Vergl.-Nr.</b> 1001R 1058R N/A
Gleitringdichtung für Wellen ø 13mm			
	<b>GEV-Nr.</b>	521085	<b>Vergl.-Nr.</b> 0106-1R
Laufrad ø 72mm H 17mm Gewinde M7L Welle ø 13mm			

<b>Ersatzteile zu</b>	500334		
	<b>GEV-Nr.</b>	528800	<b>Vergl.-Nr.</b> 0042R
O-Ring EPDM Materialstärke 2,62mm ID ø 75,87mm			
<b>Zubehör zu</b>	500334		
	<b>GEV-Nr.</b>	503030	<b>Vergl.-Nr.</b> —
Rundfilter Ablauf			
	<b>GEV-Nr.</b>	503108	<b>Vergl.-Nr.</b> —
Rundfilter Ablauf			
	<b>GEV-Nr.</b>	506015	<b>Vergl.-Nr.</b> —
O-Ring EPDM Materialstärke 3,53mm ID ø 39,69mm			
	<b>GEV-Nr.</b>	510072	<b>Vergl.-Nr.</b> —
O-Ring EPDM Materialstärke 3,53mm ID ø 32,93mm			



1			
<b>GEV-Nr.</b>	500599	<b>Vergl.-Nr.</b>	2349-1 2349A ZF131DX
<b>Beschreibung</b>	Pumpe Eingang ø 28mm Ausgang ø 12mm Typ ZF131DX 230V 50Hz Phasen 1 0,16kW 0,22PS L 175mm Laufrichtung links Kondensator 6,3µF LGB		
<b>Ersatzteile zu</b>	500599		
	<b>GEV-Nr.</b>	365012	<b>Vergl.-Nr.</b> —
Betriebskondensator Kapazität 6,3µF 450V			
	<b>GEV-Nr.</b>	510703	<b>Vergl.-Nr.</b> 1001R 1058R N/A
Gleitringdichtung für Wellen ø 13mm			
	<b>GEV-Nr.</b>	521119	<b>Vergl.-Nr.</b> 2135R
Pumpendeckel LGB Eingang ø 28mm Ausgang ø 12mm			
	<b>GEV-Nr.</b>	521228	<b>Vergl.-Nr.</b> 0105-1R
Laufrad ø 72mm H 17mm Laufrichtung links			
	<b>GEV-Nr.</b>	528800	<b>Vergl.-Nr.</b> 0042R
O-Ring EPDM Materialstärke 2,62mm ID ø 75,87mm			



<b>GEV-Nr.</b>	501503	<b>Vergl.-Nr.</b>	C.F.2745 LA 40 SX
<b>Beschreibung</b>	Pumpe Eingang ø 28mm Ausgang ø 22/27mm Typ CF 2745 230V 50Hz Phasen 1 0,19kW L 175mm Laufrichtung rechts Kondensator 4µF LGB mit Kondensator		
<b>Ersatzteile zu</b>	501503		
	<b>GEV-Nr.</b>	<b>Vergl.-Nr.</b>	—
	Betriebskondensator Kapazität 4µF 450V		
	<b>GEV-Nr.</b>	<b>Vergl.-Nr.</b>	Guarnizione per Pompa CRC-R DX EPR 2570A
	O-Ring EPDM Materialstärke 2,62mm ID ø 82,22mm		
	<b>GEV-Nr.</b>	<b>Vergl.-Nr.</b>	1001R 1058R N/A
	Gleitringdichtung für Wellen ø 13mm		
	<b>GEV-Nr.</b>	<b>Vergl.-Nr.</b>	N/A
	Laufrad ø 70mm H 21mm Laufrichtung rechts		
	<b>GEV-Nr.</b>	<b>Vergl.-Nr.</b>	N/A
	Pumpendeckel LGB Eingang ø 28mm Ausgang ø 22/28mm		



<b>GEV-Nr.</b>	501525	<b>Vergl.-Nr.</b>	CF 3091 LA 40 SX
<b>Beschreibung</b>	Pumpe Eingang ø 28mm Ausgang ø 22/27mm Typ CF 3091 230V 60Hz Phasen 1 0,2kW L 175mm Laufrichtung rechts Kondensator 4µF LGB mit Kondensator		
<b>Ersatzteile zu</b>	501525		
	<b>GEV-Nr.</b>	<b>Vergl.-Nr.</b>	—
	Betriebskondensator Kapazität 4µF 450V		

<b>Ersatzteile zu</b>	501525		
	<b>GEV-Nr.</b>	<b>Vergl.-Nr.</b>	Guarnizione per Pompa CRC-R DX EPR 2570A
	O-Ring EPDM Materialstärke 2,62mm ID ø 82,22mm		
	<b>GEV-Nr.</b>	<b>Vergl.-Nr.</b>	1001R 1058R N/A
	Gleitringdichtung für Wellen ø 13mm		
	<b>GEV-Nr.</b>	<b>Vergl.-Nr.</b>	N/A
	Laufrad ø 70mm H 21mm Laufrichtung rechts		
	<b>GEV-Nr.</b>	<b>Vergl.-Nr.</b>	N/A
	Pumpendeckel LGB Eingang ø 28mm Ausgang ø 22/28mm		



<b>GEV-Nr.</b>	499099	<b>Vergl.-Nr.</b>	CRC-R DX 2570 EPR2570 EPR2570A
<b>Beschreibung</b>	Pumpe Eingang ø 28mm Ausgang ø 26mm Typ CRC-R DX 230V 50Hz Phasen 1 0,2kW L 175mm Laufrichtung links Kondensator 4µF LGB		
<b>Ersatzteile zu</b>	499099		
	<b>GEV-Nr.</b>	<b>Vergl.-Nr.</b>	—
	Betriebskondensator Kapazität 4µF 450V		
	<b>GEV-Nr.</b>	<b>Vergl.-Nr.</b>	Guarnizione per Pompa CRC-R DX EPR 2570A
	O-Ring EPDM Materialstärke 2,62mm ID ø 82,22mm		
	<b>GEV-Nr.</b>	<b>Vergl.-Nr.</b>	1001R 1058R N/A
	Gleitringdichtung für Wellen ø 13mm		
	<b>GEV-Nr.</b>	<b>Vergl.-Nr.</b>	2576R
	Pumpendeckel LGB Eingang ø 28mm Ausgang ø 26mm		
	<b>GEV-Nr.</b>	<b>Vergl.-Nr.</b>	2574R Girante per Pompa CRC-R DX EPR2570A
	Laufrad ø 80mm H 25mm Pumpentyp CRC-R DX		



1

<b>GEV-Nr.</b>	501526	<b>Vergl.-Nr.</b>	2582-1 CRC-R DX 60 HZ
<b>Beschreibung</b>	Pumpe Eingang ø 28mm Ausgang ø 26mm Typ CRC-R DX 230V 60Hz Phasen 1 0,21kW L 175mm Laufrichtung links Kondensator 4µF LGB		
<b>Ersatzteile zu</b>	501526		
	<b>GEV-Nr.</b>	365031	<b>Vergl.-Nr.</b> —
	Betriebskondensator Kapazität 4µF 450V		
	<b>GEV-Nr.</b>	509002	<b>Vergl.-Nr.</b> Guarnizione per Pompa CRC-R DX EPR 2570A
	O-Ring EPDM Materialstärke 2,62mm ID ø 82,22mm		
	<b>GEV-Nr.</b>	510703	<b>Vergl.-Nr.</b> 1001R 1058R N/A
	Gleitringdichtung für Wellen ø 13mm		
	<b>GEV-Nr.</b>	521091	<b>Vergl.-Nr.</b> 2576R
	Pumpendeckel LGB Eingang ø 28mm Ausgang ø 26mm		
	<b>GEV-Nr.</b>	521092	<b>Vergl.-Nr.</b> 2574R Girante per Pompa CRC-R DX EPR2570A
	Laufrad ø 80mm H 25mm Pumpentyp CRC-R DX		



1

<b>GEV-Nr.</b>	499061	<b>Vergl.-Nr.</b>	2753-1 ZF115SX EPR2753
<b>Beschreibung</b>	Pumpe Eingang ø 28mm Ausgang ø 26mm Typ ZF115SX 230V 50Hz Phasen 1 0,21kW L 190mm Kondensator 5µF LGB		
<b>Ersatzteile zu</b>	499061		
	<b>GEV-Nr.</b>	365017	<b>Vergl.-Nr.</b> —
	Betriebskondensator Kapazität 5µF 450V		

<b>Ersatzteile zu</b>	499061		
	<b>GEV-Nr.</b>	510122	<b>Vergl.-Nr.</b> 0002R
	Pumpendeckel LGB Eingang ø 28mm Ausgang ø 26mm		
	<b>GEV-Nr.</b>	510703	<b>Vergl.-Nr.</b> 1001R 1058R N/A
	Gleitringdichtung für Wellen ø 13mm		
	<b>GEV-Nr.</b>	521221	<b>Vergl.-Nr.</b> N/A
	Laufrad ø 67mm H 16mm Laufrichtung rechts		
	<b>GEV-Nr.</b>	528800	<b>Vergl.-Nr.</b> 0042R
	O-Ring EPDM Materialstärke 2,62mm ID ø 75,87mm		



1

<b>GEV-Nr.</b>	500353	<b>Vergl.-Nr.</b>	EPR0499 ZF115SX
<b>Beschreibung</b>	Pumpe Eingang ø 28mm Ausgang ø 26mm Typ ZF115SX 230V 50Hz Phasen 1 0,2kW 0,27PS L 190mm Laufrichtung rechts Kondensator 5µF LGB		
<b>Ersatzteile zu</b>	500353		
	<b>GEV-Nr.</b>	365017	<b>Vergl.-Nr.</b> —
	Betriebskondensator Kapazität 5µF 450V		
	<b>GEV-Nr.</b>	510122	<b>Vergl.-Nr.</b> 0002R
	Pumpendeckel LGB Eingang ø 28mm Ausgang ø 26mm		
	<b>GEV-Nr.</b>	510703	<b>Vergl.-Nr.</b> 1001R 1058R N/A
	Gleitringdichtung für Wellen ø 13mm		
	<b>GEV-Nr.</b>	521223	<b>Vergl.-Nr.</b> 1517R
	Laufrad ø 61mm H 17mm Gewinde M7L Welle ø 13mm		
	<b>GEV-Nr.</b>	528800	<b>Vergl.-Nr.</b> 0042R
	O-Ring EPDM Materialstärke 2,62mm ID ø 75,87mm		



1

<b>GEV-Nr.</b>	500342	<b>Vergl.-Nr.</b>	ZF119SX (BL19655)
<b>Beschreibung</b>	Pumpe Eingang ø 28mm Ausgang ø 26mm Typ ZF119DX 230V 50Hz Phasen 1 0,2kW 0,27PS L 186mm Laufrichtung links Kondensator 5µF LGB		



1

<b>GEV-Nr.</b>	499204	<b>Vergl.-Nr.</b>	ZF119SX
<b>Beschreibung</b>	Pumpe Eingang ø 28mm Ausgang ø 26mm Typ ZF119SX 230V 50Hz Phasen 1 0,15kW 0,2PS L 195mm Laufrichtung rechts Kondensator 5µF Hilfsdruck 12mm LGB		
<b>Ersatzteile zu</b>	499204		
	<b>GEV-Nr.</b>	365017	<b>Vergl.-Nr.</b> —
	Betriebskondensator Kapazität 5µF 450V		
	<b>GEV-Nr.</b>	510703	<b>Vergl.-Nr.</b> 1001R 1058R N/A
	Gleitringdichtung für Wellen ø 13mm		
	<b>GEV-Nr.</b>	521057	<b>Vergl.-Nr.</b> 1650R
	Pumpendeckel LGB Eingang ø 28mm Ausgang ø 26mm		
	<b>GEV-Nr.</b>	521114	<b>Vergl.-Nr.</b> Girante per Pompa ZF119SX C.F.2126
	Laufrad ø 48mm H 17mm Pumpentyp ZF119SX		
	<b>GEV-Nr.</b>	528800	<b>Vergl.-Nr.</b> 0042R
	O-Ring EPDM Materialstärke 2,62mm ID ø 75,87mm		



1

<b>GEV-Nr.</b>	500936	<b>Vergl.-Nr.</b>	ZF119SX
<b>Beschreibung</b>	Pumpe Eingang ø 28mm Ausgang ø 26mm Typ ZF119SX 230V 50Hz Phasen 1 0,24kW 0,33PS L 190mm Laufrichtung rechts Kondensator 5µF LGB		
<b>Ersatzteile zu</b>	500936		
	<b>GEV-Nr.</b>	365017	<b>Vergl.-Nr.</b> —
	Betriebskondensator Kapazität 5µF 450V		
	<b>GEV-Nr.</b>	521057	<b>Vergl.-Nr.</b> 1650R
	Pumpendeckel LGB Eingang ø 28mm Ausgang ø 26mm		
	<b>GEV-Nr.</b>	528800	<b>Vergl.-Nr.</b> 0042R
	O-Ring EPDM Materialstärke 2,62mm ID ø 75,87mm		
<b>Zubehör zu</b>	500936		
	<b>GEV-Nr.</b>	550964	<b>Vergl.-Nr.</b> —
	Befestigungswinkel für Pumpe		





1

<b>GEV-Nr.</b>	499132	<b>Vergl.-Nr.</b>	EPR2894 ZF121SX
<b>Beschreibung</b>	Pumpe Eingang ø 28mm Ausgang ø 26mm Typ ZF121SX 230V 50Hz Phasen 1 0,11kW 0,15PS L 195mm Laufrichtung rechts Kondensator 6,3µF LGB		
<b>Ersatzteile zu</b>	499132		
	<b>GEV-Nr.</b>	365012	<b>Vergl.-Nr.</b> —
	Betriebskondensator Kapazität 6,3µF 450V		
	<b>GEV-Nr.</b>	510703	<b>Vergl.-Nr.</b> 1001R 1058R N/A
	Gleitringdichtung für Wellen ø 13mm		

Tabellenfortsetzung auf der nächsten Seite



<b>Ersatzteile zu</b> 499132				
	GEV-Nr.	521057	Vergl.-Nr.	1650R
Pumpendeckel LGB Eingang ø 28mm Ausgang ø 26mm				
	GEV-Nr.	521085	Vergl.-Nr.	0106-1R
Laufrad ø 72mm H 17mm Gewinde M7L Welle ø 13mm				
	GEV-Nr.	528800	Vergl.-Nr.	0042R
O-Ring EPDM Materialstärke 2,62mm ID ø 75,87mm				



<b>GEV-Nr.</b>	500542	<b>Vergl.-Nr.</b>	EPR0459 ZF130DX	
<b>Beschreibung</b>	Pumpe Eingang ø 28mm Ausgang ø 26mm Typ ZF130DX 230V 50Hz Phasen 1 0,3kW 0,41PS L 190mm Laufrichtung links Kondensator 6,3µF LGB			
<b>Ersatzteile zu</b> 500542				
	GEV-Nr.	365012	Vergl.-Nr.	—
Betriebskondensator Kapazität 6,3µF 450V				
	GEV-Nr.	510703	Vergl.-Nr.	1001R 1058R N/A
Gleitringdichtung für Wellen ø 13mm				
	GEV-Nr.	521107	Vergl.-Nr.	0001R
Pumpendeckel LGB Eingang ø 28mm Ausgang ø 26mm				
	GEV-Nr.	521228	Vergl.-Nr.	0105-1R
Laufrad ø 72mm H 17mm Laufrichtung links				
	GEV-Nr.	528800	Vergl.-Nr.	0042R
O-Ring EPDM Materialstärke 2,62mm ID ø 75,87mm				









<b>GEV-Nr.</b>	500494	<b>Vergl.-Nr.</b>	C.F0551 EPR0551 ZF130DX	
<b>Beschreibung</b>	Pumpe Eingang ø 28mm Ausgang ø 26mm Typ ZF130DX 230V 50Hz Phasen 1 0,3kW 0,4PS L 200mm Laufrichtung links Kondensator 6,3µF LGB			
<b>Ersatzteile zu</b> 500494				
	GEV-Nr.	365012	Vergl.-Nr.	—
Betriebskondensator Kapazität 6,3µF 450V				
	GEV-Nr.	510703	Vergl.-Nr.	1001R 1058R N/A
Gleitringdichtung für Wellen ø 13mm				
	GEV-Nr.	521107	Vergl.-Nr.	0001R
Pumpendeckel LGB Eingang ø 28mm Ausgang ø 26mm				
	GEV-Nr.	521228	Vergl.-Nr.	0105-1R
Laufrad ø 72mm H 17mm Laufrichtung links				
	GEV-Nr.	528800	Vergl.-Nr.	0042R
O-Ring EPDM Materialstärke 2,62mm ID ø 75,87mm				





<b>GEV-Nr.</b>	500352	<b>Vergl.-Nr.</b>	EPR0500 ZF130SX	
<b>Beschreibung</b>	Pumpe Eingang ø 28mm Ausgang ø 26mm Typ ZF130SX 230V 50Hz Phasen 1 0,2kW 0,27PS L 195mm Laufrichtung rechts Kondensator 6,3µF LGB			
<b>Ersatzteile zu</b> 500352				
	GEV-Nr.	365012	Vergl.-Nr.	—
Betriebskondensator Kapazität 6,3µF 450V				

Tabellenfortsetzung auf der nächsten Seite

<b>Ersatzteile zu</b>	500352		
	GEV-Nr.	510122	Vergl.-Nr. 0002R
	Pumpendeckel LGB Eingang ø 28mm Ausgang ø 26mm		
	GEV-Nr.	510703	Vergl.-Nr. 1001R 1058R N/A
	Gleitringdichtung für Wellen ø 13mm		
	GEV-Nr.	521085	Vergl.-Nr. 0106-1R
	Laufrad ø 72mm H 17mm Gewinde M7L Welle ø 13mm		
	GEV-Nr.	528800	Vergl.-Nr. 0042R
	O-Ring EPDM Materialstärke 2,62mm ID ø 75,87mm		

<b>Ersatzteile zu</b>	500382		
	GEV-Nr.	510703	Vergl.-Nr. 1001R 1058R N/A
	Gleitringdichtung für Wellen ø 13mm		
	GEV-Nr.	521228	Vergl.-Nr. 0105-1R
	Laufrad ø 72mm H 17mm Laufrichtung links		
	GEV-Nr.	521524	Vergl.-Nr. 0882R
	Pumpendeckel LGB Eingang ø 28mm Ausgang ø 26mm		
	GEV-Nr.	528800	Vergl.-Nr. 0042R
	O-Ring EPDM Materialstärke 2,62mm ID ø 75,87mm		



<b>GEV-Nr.</b>	500583	<b>Vergl.-Nr.</b>	EPR1219 ZF130SX
<b>Beschreibung</b>	Pumpe Eingang ø 28mm Ausgang ø 26mm Typ ZF130SX 230V 50Hz Phasen 1 0,2kW 0,27PS L 195mm Laufrichtung rechts Kondensator 6,3µF LGB		
<b>Ersatzteile zu</b>	500583		
	GEV-Nr.	509004	Vergl.-Nr. 0951R
	Laufrad ø 71mm H 16mm M7L Laufrichtung rechts		
	GEV-Nr.	510703	Vergl.-Nr. 1001R 1058R N/A
	Gleitringdichtung für Wellen ø 13mm		



<b>GEV-Nr.</b>	500555	<b>Vergl.-Nr.</b>	EPR0532 ZF131DX
<b>Beschreibung</b>	Pumpe Eingang ø 28mm Ausgang ø 26mm Typ ZF131DX 230V 50Hz Phasen 1 0,2kW 0,27PS L 195mm Laufrichtung links Kondensator 6,3µF Hilfsdruck 12mm Hilfsdruck geschlossen LGB		
<b>Ersatzteile zu</b>	500555		
	GEV-Nr.	365012	Vergl.-Nr. —
	Betriebskondensator Kapazität 6,3µF 450V		
	GEV-Nr.	510703	Vergl.-Nr. 1001R 1058R N/A
	Gleitringdichtung für Wellen ø 13mm		
	GEV-Nr.	521228	Vergl.-Nr. 0105-1R
	Laufrad ø 72mm H 17mm Laufrichtung links		
	GEV-Nr.	521524	Vergl.-Nr. 0882R
	Pumpendeckel LGB Eingang ø 28mm Ausgang ø 26mm		
	GEV-Nr.	528800	Vergl.-Nr. 0042R
	O-Ring EPDM Materialstärke 2,62mm ID ø 75,87mm		



<b>GEV-Nr.</b>	500382	<b>Vergl.-Nr.</b>	EPR0542 ZF131DX
<b>Beschreibung</b>	Pumpe Eingang ø 28mm Ausgang ø 26mm Typ ZF131DX 230V 50Hz Phasen 1 0,2kW 0,26PS L 180mm Laufrichtung links Kondensator 6,3µF LGB		
<b>Ersatzteile zu</b>	500382		
	GEV-Nr.	365012	Vergl.-Nr. —
	Betriebskondensator Kapazität 6,3µF 450V		







1

<b>GEV-Nr.</b>	500582	<b>Vergl.-Nr.</b>	EPR1002 EPR1453 ZF131DX 1002
<b>Beschreibung</b>	Pumpe Eingang ø 28mm Ausgang ø 26mm Typ ZF131DX 230V 50Hz Phasen 1 0,2kW 0,27PS L 195mm Laufrichtung links Kondensator 6,3µF LGB		
<b>Ersatzteile zu</b>	500582		
	GEV-Nr.	365012	Vergl.-Nr. —
	Betriebskondensator Kapazität 6,3µF 450V		
	GEV-Nr.	510703	Vergl.-Nr. 1001R 1058R N/A
	Gleitringdichtung für Wellen ø 13mm		
	GEV-Nr.	521084	Vergl.-Nr. 1263R
	Pumpendeckel LGB Eingang ø 28mm Ausgang ø 25mm		
	GEV-Nr.	521228	Vergl.-Nr. 0105-1R
	Laufrad ø 72mm H 17mm Laufrichtung links		
	GEV-Nr.	528800	Vergl.-Nr. 0042R
	O-Ring EPDM Materialstärke 2,62mm ID ø 75,87mm		







1

<b>GEV-Nr.</b>	499301	<b>Vergl.-Nr.</b>	EPR1644 ZF131DX
<b>Beschreibung</b>	Pumpe Eingang ø 28mm Ausgang ø 26mm Typ ZF131DX 230V 50Hz Phasen 1 0,2kW L 195mm Laufrichtung links Kondensator 6,3µF LGB		
<b>Ersatzteile zu</b>	499301		
	GEV-Nr.	365012	Vergl.-Nr. —
	Betriebskondensator Kapazität 6,3µF 450V		
	GEV-Nr.	510703	Vergl.-Nr. 1001R 1058R N/A
	Gleitringdichtung für Wellen ø 13mm		

<b>Ersatzteile zu</b>	499301		
	GEV-Nr.	521084	Vergl.-Nr. 1263R
	Pumpendeckel LGB Eingang ø 28mm Ausgang ø 25mm		
	GEV-Nr.	521228	Vergl.-Nr. 0105-1R
	Laufrad ø 72mm H 17mm Laufrichtung links		
	GEV-Nr.	528800	Vergl.-Nr. 0042R
	O-Ring EPDM Materialstärke 2,62mm ID ø 75,87mm		



1

<b>GEV-Nr.</b>	500094	<b>Vergl.-Nr.</b>	EPR0744 ZF131SX
<b>Beschreibung</b>	Pumpe Eingang ø 28mm Ausgang ø 26mm Typ ZF131SX 230V 50Hz Phasen 1 0,2kW 0,15PS L 195mm Laufrichtung links Kondensator 6,3µF LGB		
<b>Ersatzteile zu</b>	500094		
	GEV-Nr.	365012	Vergl.-Nr. —
	Betriebskondensator Kapazität 6,3µF 450V		
	GEV-Nr.	502266	Vergl.-Nr. 0881R
	Pumpendeckel Eingang ø 28mm Ausgang ø 26mm		
	GEV-Nr.	510703	Vergl.-Nr. 1001R 1058R N/A
	Gleitringdichtung für Wellen ø 13mm		
	GEV-Nr.	521085	Vergl.-Nr. 0106-1R
	Laufrad ø 72mm H 17mm Gewinde M7L Welle ø 13mm		
	GEV-Nr.	528800	Vergl.-Nr. 0042R
	O-Ring EPDM Materialstärke 2,62mm ID ø 75,87mm		



1

<b>GEV-Nr.</b>	500539	<b>Vergl.-Nr.</b>	EPR0861 EPR0861A ZF170SX
<b>Beschreibung</b>	Pumpe Eingang ø 28mm Ausgang ø 26mm Typ ZF170SX 230V 50Hz Phasen 1 0,32kW 0,44PS L 200mm Laufrichtung rechts Kondensator 8µF LGB		
<b>Ersatzteile zu</b>	500539		
	GEV-Nr. 365013	Vergl.-Nr.	—
	Betriebskondensator Kapazität 8µF 400V		
	GEV-Nr. 509004	Vergl.-Nr.	0951R
	Laufrad ø 71mm H 16mm M7L Laufrichtung rechts		
	GEV-Nr. 510703	Vergl.-Nr.	1001R 1058R N/A
	Gleitringdichtung für Wellen ø 13mm		
	GEV-Nr. 521057	Vergl.-Nr.	1650R
	Pumpendeckel LGB Eingang ø 28mm Ausgang ø 26mm		
	GEV-Nr. 528800	Vergl.-Nr.	0042R
	O-Ring EPDM Materialstärke 2,62mm ID ø 75,87mm		



1

<b>GEV-Nr.</b>	500510	<b>Vergl.-Nr.</b>	EPR1106 EPR1106A ZF170SX
<b>Beschreibung</b>	Pumpe Eingang ø 28mm Ausgang ø 26mm Typ ZF170SX 230V 50Hz Phasen 1 0,3kW 0,41PS L 195mm Laufrichtung rechts Kondensator 6,3µF LGB		
<b>Ersatzteile zu</b>	500510		
	GEV-Nr. 365012	Vergl.-Nr.	—
	Betriebskondensator Kapazität 6,3µF 450V		
	GEV-Nr. 510703	Vergl.-Nr.	1001R 1058R N/A
	Gleitringdichtung für Wellen ø 13mm		

<b>Ersatzteile zu</b>	500510		
	GEV-Nr. 521057	Vergl.-Nr.	1650R
	Pumpendeckel LGB Eingang ø 28mm Ausgang ø 26mm		
	GEV-Nr. 521225	Vergl.-Nr.	0110-1R
	Laufrad ø 72mm H 22mm Laufrichtung rechts		
	GEV-Nr. 528800	Vergl.-Nr.	0042R
	O-Ring EPDM Materialstärke 2,62mm ID ø 75,87mm		



1

<b>GEV-Nr.</b>	500460	<b>Vergl.-Nr.</b>	EPR1800 ZFC119DX
<b>Beschreibung</b>	Pumpe Eingang ø 28mm Ausgang ø 26mm Typ ZFC119DX 230V 50Hz Phasen 1 0,2kW 0,27PS L 180mm Laufrichtung links Kondensator 5µF LGB		





1

<b>GEV-Nr.</b>	500979	<b>Vergl.-Nr.</b>	EPR1810 ZFC1121DX
<b>Beschreibung</b>	Pumpe Eingang ø 28mm Ausgang ø 26mm Typ ZFC1121DX 230V 50Hz Phasen 1 0,25kW L 198mm Laufrichtung links Kondensator 6,3µF LGB		
<b>Ersatzteile zu</b>	500979		
	GEV-Nr. 365012	Vergl.-Nr.	—
	Betriebskondensator Kapazität 6,3µF 450V		
	GEV-Nr. 510703	Vergl.-Nr.	1001R 1058R N/A
	Gleitringdichtung für Wellen ø 13mm		

Tabellenfortsetzung auf der nächsten Seite





<b>Ersatzteile zu</b> 500979			
	GEV-Nr.	521098	Vergl.-Nr. 1649R
Pumpendeckel LGB Eingang ø 28mm Ausgang ø 26mm			
	GEV-Nr.	521099	Vergl.-Nr. 1580-1R
Laufrad ø 72mm H 17mm Gewinde M7R Welle ø 13mm			
	GEV-Nr.	528800	Vergl.-Nr. 0042R
O-Ring EPDM Materialstärke 2,62mm ID ø 75,87mm			



<b>1</b>			
GEV-Nr.	500567	Vergl.-Nr.	EPR1626 ZF121DX
Beschreibung	Pumpe Eingang ø 28mm Ausgang ø 28mm Typ ZF121DX 230V 50Hz Phasen 1 0,25kW L 195mm Laufrichtung links Kondensator 6,3µF LGB		
<b>Ersatzteile zu</b> 500567			
	GEV-Nr.	365012	Vergl.-Nr. —
Betriebskondensator Kapazität 6,3µF 450V			
	GEV-Nr.	510703	Vergl.-Nr. 1001R 1058R N/A
Gleitringdichtung für Wellen ø 13mm			
	GEV-Nr.	521098	Vergl.-Nr. 1649R
Pumpendeckel LGB Eingang ø 28mm Ausgang ø 26mm			
	GEV-Nr.	521099	Vergl.-Nr. 1580-1R
Laufrad ø 72mm H 17mm Gewinde M7R Welle ø 13mm			
	GEV-Nr.	528800	Vergl.-Nr. 0042R
O-Ring EPDM Materialstärke 2,62mm ID ø 75,87mm			



<b>1</b>			
GEV-Nr.	500483	Vergl.-Nr.	ZF121DX
Beschreibung	Pumpe Eingang ø 28mm Ausgang ø 28mm Typ ZF121DX 230V 50Hz Phasen 1 0,28kW 0,38PS L 195mm Laufrichtung links Kondensator 6,3µF LGB		
<b>Ersatzteile zu</b> 500483			
	GEV-Nr.	365012	Vergl.-Nr. —
Betriebskondensator Kapazität 6,3µF 450V			



<b>1</b>			
GEV-Nr.	500480	Vergl.-Nr.	EPR2380 ZF131DX
Beschreibung	Pumpe Eingang ø 28mm Ausgang ø 28mm Typ ZF131DX 230V 50Hz Phasen 1 0,29kW 0,4PS L 195mm Laufrichtung links Kondensator 6,3µF LGB		
<b>Ersatzteile zu</b> 500480			
	GEV-Nr.	365012	Vergl.-Nr. —
Betriebskondensator Kapazität 6,3µF 450V			
	GEV-Nr.	510690	Vergl.-Nr. N/A
Gleitringdichtung für Wellen ø 8mm			
	GEV-Nr.	521083	Vergl.-Nr. 0815R
Laufrad ø 73mm H 13mm Gewinde M7R Schaufeln 3			
	GEV-Nr.	521084	Vergl.-Nr. 1263R
Pumpendeckel LGB Eingang ø 28mm Ausgang ø 25mm			
	GEV-Nr.	528800	Vergl.-Nr. 0042R
O-Ring EPDM Materialstärke 2,62mm ID ø 75,87mm			



1

<b>GEV-Nr.</b>	500466	<b>Vergl.-Nr.</b>	EPR1722 ZFC1121DX
<b>Beschreibung</b>	Pumpe Eingang ø 28mm Ausgang ø 28mm Typ ZFC1121DX 230V 50Hz Phasen 1 0,35kW 0,47PS L 200mm Laufrichtung links Kondensator 6,3µF LGB		
<b>Ersatzteile zu</b>	500466		
	<b>GEV-Nr.</b>	365012	<b>Vergl.-Nr.</b> —
	Betriebskondensator Kapazität 6,3µF 450V		
	<b>GEV-Nr.</b>	510703	<b>Vergl.-Nr.</b> 1001R 1058R N/A
	Gleitringdichtung für Wellen ø 13mm		
	<b>GEV-Nr.</b>	521007	<b>Vergl.-Nr.</b> 1774R
	Pumpendeckel LGB Eingang ø 28mm Ausgang ø 26mm		
	<b>GEV-Nr.</b>	521008	<b>Vergl.-Nr.</b> 0109-1R
	Laufrad ø 72mm H 22mm Laufrichtung links		
	<b>GEV-Nr.</b>	528800	<b>Vergl.-Nr.</b> 0042R
	O-Ring EPDM Materialstärke 2,62mm ID ø 75,87mm		



1

<b>GEV-Nr.</b>	500966	<b>Vergl.-Nr.</b>	EPR2111 FC2006
<b>Beschreibung</b>	Pumpe Eingang ø 29mm Ausgang ø 31/38mm Typ FC2006 230V 50Hz Phasen 1 0,7kW 0,95PS L 195mm Laufrichtung links Kondensator 16µF LGB		
<b>Ersatzteile zu</b>	500966		
	<b>GEV-Nr.</b>	365021	<b>Vergl.-Nr.</b> —
	Betriebskondensator Kapazität 16µF 425V		

<b>Ersatzteile zu</b>	500966		
	<b>GEV-Nr.</b>	510703	<b>Vergl.-Nr.</b> 1001R 1058R N/A
	Gleitringdichtung für Wellen ø 13mm		
	<b>GEV-Nr.</b>	521149	<b>Vergl.-Nr.</b> N/A
	Pumpendeckel LGB Ausgang ø 38/31mm		
	<b>GEV-Nr.</b>	521150	<b>Vergl.-Nr.</b> N/A
	Laufrad ø 85mm H 17mm Gewinde M8R Welle ø 13mm		
	<b>GEV-Nr.</b>	532537	<b>Vergl.-Nr.</b> N/A
	O-Ring EPDM Materialstärke 3,53mm ID ø 113,9mm		



1

<b>GEV-Nr.</b>	500351	<b>Vergl.-Nr.</b>	X55X 130994
<b>Beschreibung</b>	Pumpe Eingang ø 29mm Ausgang ø 39mm Typ X55X 230V 50Hz Phasen 1 0,8kW 1,09PS L 210mm Laufrichtung rechts Kondensator 16µF LGB		
<b>Ersatzteile zu</b>	500351		
	<b>GEV-Nr.</b>	365021	<b>Vergl.-Nr.</b> —
	Betriebskondensator Kapazität 16µF 425V		
	<b>GEV-Nr.</b>	510703	<b>Vergl.-Nr.</b> 1001R 1058R N/A
	Gleitringdichtung für Wellen ø 13mm		
	<b>GEV-Nr.</b>	518294	<b>Vergl.-Nr.</b> —
	Flachdichtung Gummi D1 ø 85mm D2 ø 71mm		
	<b>GEV-Nr.</b>	521234	<b>Vergl.-Nr.</b> N/A
	Laufrad Gewinde M8L AD ø 93mm B 16mm		
	<b>GEV-Nr.</b>	523509	<b>Vergl.-Nr.</b> —
	Rillenkugellager Welle ø 12mm AD ø 32mm B 10mm		
	<b>GEV-Nr.</b>	532537	<b>Vergl.-Nr.</b> N/A
	O-Ring EPDM Materialstärke 3,53mm ID ø 113,9mm		



1

<b>GEV-Nr.</b>	500459	<b>Vergl.-Nr.</b>	ZF110SX
<b>Beschreibung</b>	Pumpe Eingang ø 30mm Ausgang ø 29mm Typ ZF110SX 230V 50Hz Phasen 1 0,25kW 0,34PS L 150mm Laufrichtung links Kondensator 8µF LGB		



1

<b>GEV-Nr.</b>	500511	<b>Vergl.-Nr.</b>	EPR1453 ZF140SX
<b>Beschreibung</b>	Pumpe Eingang ø 30mm Ausgang ø 29mm Typ ZF140SX 230V 50Hz Phasen 1 0,36kW 0,5PS L 190mm Laufrichtung rechts LGB		
<b>Ersatzteile zu</b>	500511		
	GEV-Nr.	365017	Vergl.-Nr. —
	Betriebskondensator Kapazität 5µF 450V		
	GEV-Nr.	510703	Vergl.-Nr. 1001R 1058R N/A
	Gleitringdichtung für Wellen ø 13mm		
	GEV-Nr.	521230	Vergl.-Nr. N/A
	Laufrad ø 86mm H 16mm M7L		
	GEV-Nr.	521526	Vergl.-Nr. 0009R 3286R
	Pumpendeckel LGB Eingang ø 30mm Ausgang ø 30mm		
<b>Bild nicht vorhanden</b>	GEV-Nr.	521706	Vergl.-Nr. 2234R
	Pumpendeckeldichtung		





1



<b>GEV-Nr.</b>	499104	<b>Vergl.-Nr.</b>	EPR1598 ZF135SX
<b>Beschreibung</b>	Pumpe Eingang ø 30mm Ausgang ø 30mm Typ ZF135 SX 230V 50Hz Phasen 1 0,37kW L 210mm Laufrichtung rechts Kondensator 8µF LGB		
<b>Ersatzteile zu</b>	499104		
	GEV-Nr.	365013	Vergl.-Nr. —
	Betriebskondensator Kapazität 8µF 400V		
	GEV-Nr.	510703	Vergl.-Nr. 1001R 1058R N/A
	Gleitringdichtung für Wellen ø 13mm		
	GEV-Nr.	521527	Vergl.-Nr. 0645R
	Pumpendeckel LGB Eingang ø 30mm Ausgang ø 30mm		
	GEV-Nr.	521701	Vergl.-Nr. 0044R
	Pumpendeckeldichtung		



1

<b>GEV-Nr.</b>	500538	<b>Vergl.-Nr.</b>	EPR0492 ZF150SX
<b>Beschreibung</b>	Pumpe Eingang ø 30mm Ausgang ø 30mm Typ ZF150SX 230V 50Hz Phasen 1 0,2kW 0,25PS L 170mm Laufrichtung rechts Kondensator 10µF LGB		
<b>Ersatzteile zu</b>	500538		
	GEV-Nr.	365015	Vergl.-Nr. —
	Betriebskondensator Kapazität 10µF 400V		
	GEV-Nr.	510703	Vergl.-Nr. 1001R 1058R N/A
	Gleitringdichtung für Wellen ø 13mm		
	GEV-Nr.	521527	Vergl.-Nr. 0645R
	Pumpendeckel LGB Eingang ø 30mm Ausgang ø 30mm		

Tabellenfortsetzung auf der nächsten Seite

<b>Ersatzteile zu</b> 500538			
	GEV-Nr.	521701	Vergl.-Nr. 0044R
	Pumpendeckeldichtung		
	GEV-Nr.	521707	Vergl.-Nr. —
	Pumpendeckeldichtung		



<b>1</b>			
<b>GEV-Nr.</b>	500384	<b>Vergl.-Nr.</b>	EPR0548 ZF160SX
<b>Beschreibung</b>	Pumpe Eingang ø 30mm Ausgang ø 30mm Typ ZF160SX 230V 50Hz Phasen 1 0,41kW 0,55PS L 180mm Laufrichtung rechts Kondensator 12,5µF LGB		
<b>Ersatzteile zu</b> 500384			
	GEV-Nr.	365014	Vergl.-Nr. —
	Betriebskondensator Kapazität 12,5µF 400V		
	GEV-Nr.	510703	Vergl.-Nr. 1001R 1058R N/A
	Gleitringdichtung für Wellen ø 13mm		
	GEV-Nr.	521527	Vergl.-Nr. 0645R
	Pumpendeckel LGB Eingang ø 30mm Ausgang ø 30mm		
	GEV-Nr.	521701	Vergl.-Nr. 0044R
	Pumpendeckeldichtung		
	GEV-Nr.	521707	Vergl.-Nr. —
	Pumpendeckeldichtung		



<b>1</b>	<b>GEV-Nr.</b>	499078	<b>Vergl.-Nr.</b>	ZF160SX
	<b>Beschreibung</b>	Pumpe Eingang ø 30mm Ausgang ø 30mm Typ ZF160SX 230V 50Hz Phasen 1 0,4kW 0,54PS L 186mm Laufrichtung rechts Kondensator 12µF LGB		



<b>1</b>	<b>GEV-Nr.</b>	500461	<b>Vergl.-Nr.</b>	EPR0524 ZF210SX
	<b>Beschreibung</b>	Pumpe Eingang ø 32mm Ausgang ø 32mm Typ ZF210SX 230V 50Hz Phasen 1 0,6kW 0,8PS L 180mm Kondensator 12,5µF LGB		
<b>Ersatzteile zu</b> 500461				
	GEV-Nr.	365014	Vergl.-Nr.	—
	Betriebskondensator Kapazität 12,5µF 400V			
	GEV-Nr.	502267	Vergl.-Nr.	0935-1R
	Pumpendeckel			
	GEV-Nr.	510702	Vergl.-Nr.	N/A
	Gleitringdichtung Höhe Gegenring 5,5mm			
	GEV-Nr.	521042	Vergl.-Nr.	0116R Girante Pompa EPR0524(Z- F210SX)
	Laufrad ø 103mm H 14mm Pumpentyp ZF210SX			
<b>Bild nicht vorhanden</b>	GEV-Nr.	532719	Vergl.-Nr.	N/A
	O-Ring EPDM Materialstärke 2,62mm ID ø 126,67mm			



<b>GEV-Nr.</b>	499138	<b>Vergl.-Nr.</b>	1826 X3SX
<b>Beschreibung</b>	Pumpe Eingang ø 33mm Ausgang ø 26mm Typ X3SX 230V 50Hz Phasen 1 0,26kW L 300mm Laufrichtung rechts Kondensator 6,3µF LGB		
<b>Ersatzteile zu</b>	499138		
	<b>GEV-Nr.</b>	365012	<b>Vergl.-Nr.</b> —
	Betriebskondensator Kapazität 6,3µF 450V		
	<b>GEV-Nr.</b>	509004	<b>Vergl.-Nr.</b> 0951R
	Laufrad ø 71mm H 16mm M7L Laufrichtung rechts		
	<b>GEV-Nr.</b>	510703	<b>Vergl.-Nr.</b> 1001R 1058R N/A
	Gleitringdichtung für Wellen ø 13mm		
	<b>GEV-Nr.</b>	521088	<b>Vergl.-Nr.</b> N/A
	Pumpendeckel LGB Eingang ø 33mm Ausgang ø 26mm		
	<b>GEV-Nr.</b>	521147	<b>Vergl.-Nr.</b> —
	Flansch		
	<b>GEV-Nr.</b>	521703	<b>Vergl.-Nr.</b> N/A
	Pumpendeckeldichtung EPDM Materialstärke 2,5mm		
	<b>GEV-Nr.</b>	523501	<b>Vergl.-Nr.</b> —
	Rillenkugellager Welle ø 8mm AD ø 22mm B 7mm		



<b>GEV-Nr.</b>	499100	<b>Vergl.-Nr.</b>	EPR2248 Kundenschutz LA50 130982 LA50 2248
<b>Beschreibung</b>	Pumpe Eingang ø 42mm Ausgang ø 24/37mm Typ LA50 230V 50Hz Phasen 1 0,47kW L 220mm Laufrichtung rechts Kondensator 10µF LGB mit Flansch und Schläuchen		
<b>Ersatzteile zu</b>	499100		
	<b>GEV-Nr.</b>	365015	<b>Vergl.-Nr.</b> —
	Betriebskondensator Kapazität 10µF 400V		
	<b>GEV-Nr.</b>	510702	<b>Vergl.-Nr.</b> N/A
	Gleitringdichtung Höhe Gegenring 5,5mm		
	<b>GEV-Nr.</b>	521024	<b>Vergl.-Nr.</b> N/A
	Laufrad ø 88mm H 30mm Laufrichtung rechts		
	<b>GEV-Nr.</b>	698767	<b>Vergl.-Nr.</b> —
	Lüfterflügel ø 110mm H 18mm Achsaufnahme ø 12mm		
	<b>GEV-Nr.</b>	698768	<b>Vergl.-Nr.</b> N/A
	Pumpendeckel LGB Eingang ø 42mm Pumpentyp LA50 AP		
	<b>GEV-Nr.</b>	698810	<b>Vergl.-Nr.</b> N/A
	O-Ring EPDM Materialstärke 3,56mm ID ø 112mm		
	<b>GEV-Nr.</b>	698827	<b>Vergl.-Nr.</b> N/A
	Gewinding LGB Pumpentyp LA50 ø 120mm ID ø 70mm		



1

<b>GEV-Nr.</b>	499190	<b>Vergl.-Nr.</b>	EPR2432 LA50 LA50 2432 LA50 69120
<b>Beschreibung</b>	Pumpe Eingang ø 42mm Ausgang ø 24/37mm Typ LA50 230V 50Hz Phasen 1 0,47kW L 225mm Laufrichtung rechts Kondensator 10µF LGB		
<b>Ersatzteile zu</b>	499190		
	<b>GEV-Nr.</b>	<b>Vergl.-Nr.</b>	—
	365015		
	Betriebskondensator Kapazität 10µF 400V		
	<b>GEV-Nr.</b>	<b>Vergl.-Nr.</b>	N/A
	510702		
	Gleitringdichtung Höhe Gegenring 5,5mm		
	<b>GEV-Nr.</b>	<b>Vergl.-Nr.</b>	N/A
	521024		
	Laufrad ø 88mm H 30mm Laufrichtung rechts		
	<b>GEV-Nr.</b>	<b>Vergl.-Nr.</b>	—
	698767		
	Lüfterflügel ø 110mm H 18mm Achsaufnahme ø 12mm		
	<b>GEV-Nr.</b>	<b>Vergl.-Nr.</b>	N/A
	698768		
	Pumpendeckel LGB Eingang ø 42mm Pumpentyp LA50 AP		
	<b>GEV-Nr.</b>	<b>Vergl.-Nr.</b>	—
	698793		
	Pumpendeckel Ausgang ø 24/36mm Pumpentyp LGB		
	<b>GEV-Nr.</b>	<b>Vergl.-Nr.</b>	N/A
	698810		
	O-Ring EPDM Materialstärke 3,56mm ID ø 112mm		
	<b>GEV-Nr.</b>	<b>Vergl.-Nr.</b>	N/A
	698827		
	Gewinding LGB Pumpentyp LA50 ø 120mm ID ø 70mm		



1

<b>GEV-Nr.</b>	499342	<b>Vergl.-Nr.</b>	LA50 74122
<b>Beschreibung</b>	Pumpe Eingang ø 42mm Ausgang ø 24/37mm Typ LA50 230V 50Hz Phasen 1 0,47kW L 225mm Laufrichtung rechts Kondensator 10µF LGB		
<b>Ersatzteile zu</b>	499342		
	<b>GEV-Nr.</b>	<b>Vergl.-Nr.</b>	—
	365015		
	Betriebskondensator Kapazität 10µF 400V		
	<b>GEV-Nr.</b>	<b>Vergl.-Nr.</b>	N/A
	510702		
	Gleitringdichtung Höhe Gegenring 5,5mm		
	<b>GEV-Nr.</b>	<b>Vergl.-Nr.</b>	N/A
	521024		
	Laufrad ø 88mm H 30mm Laufrichtung rechts		
	<b>GEV-Nr.</b>	<b>Vergl.-Nr.</b>	—
	698767		
	Lüfterflügel ø 110mm H 18mm Achsaufnahme ø 12mm		
	<b>GEV-Nr.</b>	<b>Vergl.-Nr.</b>	N/A
	698768		
	Pumpendeckel LGB Eingang ø 42mm Pumpentyp LA50 AP		
	<b>GEV-Nr.</b>	<b>Vergl.-Nr.</b>	—
	698769		
	Pumpengehäuse ø 125mm Ausgang ø 24/37mm		
	<b>GEV-Nr.</b>	<b>Vergl.-Nr.</b>	N/A
	698810		
	O-Ring EPDM Materialstärke 3,56mm ID ø 112mm		
	<b>GEV-Nr.</b>	<b>Vergl.-Nr.</b>	N/A
	698827		
	Gewinding LGB Pumpentyp LA50 ø 120mm ID ø 70mm		



1			
<b>GEV-Nr.</b>	501484	<b>Vergl.-Nr.</b>	LA50
<b>Beschreibung</b>	Pumpe Eingang ø 42mm Ausgang ø 37/24mm Typ LA50 230V 50Hz Phasen 1 0,47kW L 220mm Laufrichtung rechts Kondensator 10µF Hilfsdruck 8mm LGB		
<b>Ersatzteile zu</b>	501484		
	<b>GEV-Nr.</b>	<b>Vergl.-Nr.</b>	—
	Betriebskondensator Kapazität 10µF 400V		
	<b>GEV-Nr.</b>	<b>Vergl.-Nr.</b>	N/A
	Gleitringdichtung Höhe Gegenring 5,5mm		
	<b>GEV-Nr.</b>	<b>Vergl.-Nr.</b>	N/A
	Laufrad ø 88mm H 30mm Laufrichtung rechts		
	<b>GEV-Nr.</b>	<b>Vergl.-Nr.</b>	—
	Lüfterflügel ø 110mm H 18mm Achsaufnahme ø 12mm		
	<b>GEV-Nr.</b>	<b>Vergl.-Nr.</b>	N/A
	Pumpendeckel LGB Eingang ø 42mm Pumpentyp LA50 AP		
	<b>GEV-Nr.</b>	<b>Vergl.-Nr.</b>	—
	Pumpengehäuse ø 125mm Ausgang ø 24/37mm		
	<b>GEV-Nr.</b>	<b>Vergl.-Nr.</b>	N/A
	O-Ring EPDM Materialstärke 3,56mm ID ø 112mm		
	<b>GEV-Nr.</b>	<b>Vergl.-Nr.</b>	N/A
	Gewinding LGB Pumpentyp LA50 ø 120mm ID ø 70mm		



1			
<b>GEV-Nr.</b>	501486	<b>Vergl.-Nr.</b>	Kundenschutz LA50AP
<b>Beschreibung</b>	Pumpe Eingang ø 42mm Ausgang ø 37mm Typ LA50 AP 230V 50Hz Phasen 1 0,7kW L 220mm Laufrichtung rechts Kondensator 14µF Hilfsdruck 8mm LGB		
<b>Ersatzteile zu</b>	501486		
	<b>GEV-Nr.</b>	<b>Vergl.-Nr.</b>	—
	Betriebskondensator Kapazität 14µF 400V		
	<b>GEV-Nr.</b>	<b>Vergl.-Nr.</b>	N/A
	Gleitringdichtung Höhe Gegenring 5,5mm		
	<b>GEV-Nr.</b>	<b>Vergl.-Nr.</b>	N/A
	Laufrad ø 88mm H 30mm Laufrichtung rechts		
	<b>GEV-Nr.</b>	<b>Vergl.-Nr.</b>	—
	Lüfterflügel ø 110mm H 18mm Achsaufnahme ø 12mm		
	<b>GEV-Nr.</b>	<b>Vergl.-Nr.</b>	N/A
	Pumpendeckel LGB Eingang ø 42mm Pumpentyp LA50 AP		
	<b>GEV-Nr.</b>	<b>Vergl.-Nr.</b>	—
	Pumpendeckel Ausgang ø 24/36mm Pumpentyp LGB		
	<b>GEV-Nr.</b>	<b>Vergl.-Nr.</b>	N/A
	O-Ring EPDM Materialstärke 3,56mm ID ø 112mm		
	<b>GEV-Nr.</b>	<b>Vergl.-Nr.</b>	N/A
	Gewinding LGB Pumpentyp LA50 ø 120mm ID ø 70mm		



1

<b>GEV-Nr.</b>	501485	<b>Vergl.-Nr.</b>	CF3265 LA500
<b>Beschreibung</b>	Pumpe Eingang ø 42mm Ausgang ø 37mm Typ LA500 230V 50Hz Phasen 1 0,47kW L 220mm Laufrichtung rechts Kondensator 10µF Hilfsdruck 8mm LGB		
<b>Ersatzteile zu</b>	501485		
	<b>GEV-Nr.</b>	<b>Vergl.-Nr.</b>	—
	365015		
	Betriebskondensator Kapazität 10µF 400V		
	<b>GEV-Nr.</b>	<b>Vergl.-Nr.</b>	N/A
	510702		
	Gleitringdichtung Höhe Gegenring 5,5mm		
	<b>GEV-Nr.</b>	<b>Vergl.-Nr.</b>	N/A
	521024		
	Laufrad ø 88mm H 30mm Laufrichtung rechts		
	<b>GEV-Nr.</b>	<b>Vergl.-Nr.</b>	—
	698767		
	Lüfterflügel ø 110mm H 18mm Achsaufnahme ø 12mm		
	<b>GEV-Nr.</b>	<b>Vergl.-Nr.</b>	N/A
	698768		
	Pumpendeckel LGB Eingang ø 42mm Pumpentyp LA50 AP		
	<b>GEV-Nr.</b>	<b>Vergl.-Nr.</b>	—
	698769		
	Pumpengehäuse ø 125mm Ausgang ø 24/37mm		
	<b>GEV-Nr.</b>	<b>Vergl.-Nr.</b>	N/A
	698810		
	O-Ring EPDM Materialstärke 3,56mm ID ø 112mm		
	<b>GEV-Nr.</b>	<b>Vergl.-Nr.</b>	N/A
	698827		
	Gewinding LGB Pumpentyp LA50 ø 120mm ID ø 70mm		



1

<b>GEV-Nr.</b>	501528	<b>Vergl.-Nr.</b>	CF3192 LA500 60HZ
<b>Beschreibung</b>	Pumpe Eingang ø 42mm Ausgang ø 37mm Typ LA500 230V 60Hz Phasen 1 0,46kW L 220mm Laufrichtung rechts Kondensator 10µF Hilfsdruck 8mm LGB		
<b>Ersatzteile zu</b>	501528		
	<b>GEV-Nr.</b>	<b>Vergl.-Nr.</b>	—
	365015		
	Betriebskondensator Kapazität 10µF 400V		
	<b>GEV-Nr.</b>	<b>Vergl.-Nr.</b>	N/A
	510702		
	Gleitringdichtung Höhe Gegenring 5,5mm		
	<b>GEV-Nr.</b>	<b>Vergl.-Nr.</b>	N/A
	521024		
	Laufrad ø 88mm H 30mm Laufrichtung rechts		
	<b>GEV-Nr.</b>	<b>Vergl.-Nr.</b>	—
	698767		
	Lüfterflügel ø 110mm H 18mm Achsaufnahme ø 12mm		
	<b>GEV-Nr.</b>	<b>Vergl.-Nr.</b>	N/A
	698768		
	Pumpendeckel LGB Eingang ø 42mm Pumpentyp LA50 AP		
	<b>GEV-Nr.</b>	<b>Vergl.-Nr.</b>	—
	698769		
	Pumpengehäuse ø 125mm Ausgang ø 24/37mm		
	<b>GEV-Nr.</b>	<b>Vergl.-Nr.</b>	N/A
	698810		
	O-Ring EPDM Materialstärke 3,56mm ID ø 112mm		
	<b>GEV-Nr.</b>	<b>Vergl.-Nr.</b>	N/A
	698827		
	Gewinding LGB Pumpentyp LA50 ø 120mm ID ø 70mm		





<b>GEV-Nr.</b>	499084	<b>Vergl.-Nr.</b>	ZF340VSX
<b>Beschreibung</b>	Pumpe Eingang ø 44mm Ausgang ø 39mm Typ ZF340VSX 220-240V 50Hz Phasen 1 0,7kW L 245mm Laufrichtung rechts Kondensator 16µF LGB HOONVED		



<b>GEV-Nr.</b>	500553	<b>Vergl.-Nr.</b>	EPR2008 ZF290SX
<b>Beschreibung</b>	Pumpe Eingang ø 45mm Ausgang ø 38mm Typ ZF290SX 230V 50Hz Phasen 1 0,65kW 0,88PS L 200mm Laufrichtung rechts Kondensator 12,5µF Hilfsdruck 13mm Hilfsdruck offen LGB		
<b>Ersatzteile zu</b>	500553		
	<b>GEV-Nr.</b>	365014	<b>Vergl.-Nr.</b> —
	Betriebskondensator Kapazität 12,5µF 400V		
	<b>GEV-Nr.</b>	510702	<b>Vergl.-Nr.</b> N/A
	Gleitringdichtung Höhe Gegenring 5,5mm		
	<b>GEV-Nr.</b>	521106	<b>Vergl.-Nr.</b> 0114-1R
	Laufrad ø 97mm H 24mm Laufrichtung rechts		
	<b>GEV-Nr.</b>	521542	<b>Vergl.-Nr.</b> 0878R
	Pumpendeckel LGB Eingang ø 45mm Ausgang ø 40mm		
	<b>GEV-Nr.</b>	521714	<b>Vergl.-Nr.</b> 0046R 3283R
	Pumpendeckeldichtung Materialstärke 4x4mm		



<b>GEV-Nr.</b>	499154	<b>Vergl.-Nr.</b>	EPR 1986 ZF320SX
<b>Beschreibung</b>	Pumpe Eingang ø 45mm Ausgang ø 38mm Typ ZF320SX 230V 50Hz Phasen 1 0,55kW 0,75PS L 205mm Laufrichtung rechts Kondensator 12,5µF LGB		
<b>Ersatzteile zu</b>	499154		
	<b>GEV-Nr.</b>	365014	<b>Vergl.-Nr.</b> —
	Betriebskondensator Kapazität 12,5µF 400V		
	<b>GEV-Nr.</b>	510702	<b>Vergl.-Nr.</b> N/A
	Gleitringdichtung Höhe Gegenring 5,5mm		
	<b>GEV-Nr.</b>	521247	<b>Vergl.-Nr.</b> N/A
	Laufrad ø 90mm H 27mm Laufrichtung rechts		
	<b>GEV-Nr.</b>	521542	<b>Vergl.-Nr.</b> 0878R
	Pumpendeckel LGB Eingang ø 45mm Ausgang ø 40mm		
	<b>GEV-Nr.</b>	521714	<b>Vergl.-Nr.</b> 0046R 3283R
	Pumpendeckeldichtung Materialstärke 4x4mm		



<b>GEV-Nr.</b>	500508	<b>Vergl.-Nr.</b>	EPR1204 ZF320VSX
<b>Beschreibung</b>	Pumpe Eingang ø 45mm Ausgang ø 38mm Typ ZF320VSX 230V 50Hz Phasen 1 0,75kW 1PS L 230mm Laufrichtung rechts Kondensator 12,5µF LGB		
<b>Ersatzteile zu</b>	500508		
	<b>GEV-Nr.</b>	365014	<b>Vergl.-Nr.</b> —
	Betriebskondensator Kapazität 12,5µF 400V		

Tabellenfortsetzung auf der nächsten Seite

<b>Ersatzteile zu</b> 500508			
	GEV-Nr.	510702	Vergl.-Nr. N/A
Gleitringdichtung Höhe Gegenring 5,5mm			
	GEV-Nr.	521247	Vergl.-Nr. N/A
Laufrad ø 90mm H 27mm Laufrichtung rechts			
	GEV-Nr.	521542	Vergl.-Nr. 0878R
Pumpendeckel LGB Eingang ø 45mm Ausgang ø 40mm			
	GEV-Nr.	521714	Vergl.-Nr. 0046R 3283R
Pumpendeckeldichtung Materialstärke 4x4mm			



<b>GEV-Nr.</b>	499074	<b>Vergl.-Nr.</b>	EPR2906 ZF340SX
<b>Beschreibung</b>	Pumpe Eingang ø 45mm Ausgang ø 38mm Typ ZF340SX 230V 50Hz Phasen 1 0,7kW 0,95PS L 215mm Laufrichtung rechts Kondensator 16µF Hilfsdruck 13mm LGB		
<b>Ersatzteile zu</b> 499074			
	GEV-Nr.	365021	Vergl.-Nr. —
Betriebskondensator Kapazität 16µF 425V			
	GEV-Nr.	510702	Vergl.-Nr. N/A
Gleitringdichtung Höhe Gegenring 5,5mm			
	GEV-Nr.	521246	Vergl.-Nr. 0591-1R
Laufrad ø 103mm H 26mm Gewinde M8L Welle ø 20mm			
	GEV-Nr.	521542	Vergl.-Nr. 0878R
Pumpendeckel LGB Eingang ø 45mm Ausgang ø 40mm			
	GEV-Nr.	521714	Vergl.-Nr. 0046R 3283R
Pumpendeckeldichtung Materialstärke 4x4mm			



<b>GEV-Nr.</b>	500586	<b>Vergl.-Nr.</b>	EPR1043 FM4023SX
<b>Beschreibung</b>	Pumpe Eingang ø 45mm Ausgang ø 39mm Typ FM4023SX 230V 50Hz Phasen 1 0,8kW 1,09PS L 297mm Laufrichtung rechts Kondensator 16µF LGB		
<b>Ersatzteile zu</b> 500586			
	GEV-Nr.	365021	Vergl.-Nr. —
Betriebskondensator Kapazität 16µF 425V			
	GEV-Nr.	510703	Vergl.-Nr. 1001R 1058R N/A
Gleitringdichtung für Wellen ø 13mm			
	GEV-Nr.	521246	Vergl.-Nr. 0591-1R
Laufrad ø 103mm H 26mm Gewinde M8L Welle ø 20mm			
	GEV-Nr.	521542	Vergl.-Nr. 0878R
Pumpendeckel LGB Eingang ø 45mm Ausgang ø 40mm			
	GEV-Nr.	521714	Vergl.-Nr. 0046R 3283R
Pumpendeckeldichtung Materialstärke 4x4mm			



<b>GEV-Nr.</b>	500984	<b>Vergl.-Nr.</b>	EPR1760 ZF270VSX 230/50/1
<b>Beschreibung</b>	Pumpe Eingang ø 45mm Ausgang ø 39mm Typ ZF270VSX 230V 50Hz Phasen 1 0,4kW L 209mm Laufrichtung rechts Kondensator 10µF LGB		





1

<b>GEV-Nr.</b>	500157	<b>Vergl.-Nr.</b>	ZF320SX (Hoonved 31154)
<b>Beschreibung</b>	Pumpe Eingang ø 45mm Ausgang ø 39mm Typ ZF320SX 230V 50Hz Phasen 1 0,75kW 1PS L 200mm Laufrichtung rechts Kondensator 12µF LGB		







1

<b>GEV-Nr.</b>	500585	<b>Vergl.-Nr.</b>	EPR1041 ZF320VSX
<b>Beschreibung</b>	Pumpe Eingang ø 45mm Ausgang ø 39mm Typ ZF320VSX 230V 50Hz Phasen 1 0,65kW 0,88PS L 230mm Laufrichtung rechts Kondensator 12,5µF LGB		
<b>Ersatzteile zu</b>	500585		
	<b>GEV-Nr.</b>	<b>Vergl.-Nr.</b>	—
	Betriebskondensator Kapazität 12,5µF 400V		
	<b>GEV-Nr.</b>	<b>Vergl.-Nr.</b>	N/A
	Gleitringdichtung Höhe Gegenring 5,5mm		
	<b>GEV-Nr.</b>	<b>Vergl.-Nr.</b>	0114-1R
	Laufrad ø 97mm H 24mm Laufrichtung rechts		
	<b>GEV-Nr.</b>	<b>Vergl.-Nr.</b>	0878R
	Pumpendeckel LGB Eingang ø 45mm Ausgang ø 40mm		
	<b>GEV-Nr.</b>	<b>Vergl.-Nr.</b>	0046R 3283R
	Pumpendeckeldichtung Materialstärke 4x4mm		







1

<b>GEV-Nr.</b>	500398	<b>Vergl.-Nr.</b>	EPR0759 ZF320VSX
<b>Beschreibung</b>	Pumpe Eingang ø 45mm Ausgang ø 39mm Typ ZF320VSX 230V 50Hz Phasen 1 0,6kW 0,82PS L 230mm Laufrichtung rechts Kondensator 12,5µF LGB		
<b>Ersatzteile zu</b>	500398		
	<b>GEV-Nr.</b>	<b>Vergl.-Nr.</b>	—
	Betriebskondensator Kapazität 12,5µF 400V		
	<b>GEV-Nr.</b>	<b>Vergl.-Nr.</b>	N/A
	Gleitringdichtung Höhe Gegenring 5,5mm		
	<b>GEV-Nr.</b>	<b>Vergl.-Nr.</b>	N/A
	Laufrad ø 90mm H 27mm Laufrichtung rechts		
	<b>GEV-Nr.</b>	<b>Vergl.-Nr.</b>	0878R
	Pumpendeckel LGB Eingang ø 45mm Ausgang ø 40mm		
	<b>GEV-Nr.</b>	<b>Vergl.-Nr.</b>	0046R 3283R
	Pumpendeckeldichtung Materialstärke 4x4mm		



1

<b>GEV-Nr.</b>	500513	<b>Vergl.-Nr.</b>	0452 EPR0452 EPR0452A FM4023SX
<b>Beschreibung</b>	Pumpe Eingang ø 45mm Ausgang ø 40mm Typ FM4023SX 230V 50Hz Phasen 1 0,75kW 1PS L 300mm Laufrichtung rechts Kondensator 16µF LGB		
<b>Ersatzteile zu</b>	500513		
	<b>GEV-Nr.</b>	365021	<b>Vergl.-Nr.</b> —
	Betriebskondensator Kapazität 16µF 425V		
	<b>GEV-Nr.</b>	510703	<b>Vergl.-Nr.</b> 1001R 1058R N/A
	Gleitringdichtung für Wellen ø 13mm		
	<b>GEV-Nr.</b>	521246	<b>Vergl.-Nr.</b> 0591-1R
	Laufrad ø 103mm H 26mm Gewinde M8L Welle ø 20mm		
	<b>GEV-Nr.</b>	521542	<b>Vergl.-Nr.</b> 0878R
	Pumpendeckel LGB Eingang ø 45mm Ausgang ø 40mm		
	<b>GEV-Nr.</b>	521714	<b>Vergl.-Nr.</b> 0046R 3283R
	Pumpendeckeldichtung Materialstärke 4x4mm		





1

<b>GEV-Nr.</b>	500942	<b>Vergl.-Nr.</b>	EPR2372 ZF150SX
<b>Beschreibung</b>	Pumpe Eingang ø 45mm Ausgang ø 40mm Typ ZF150SX 230V 50Hz Phasen 1 0,34kW 0,5PS L 180mm Laufrichtung rechts Kondensator 10µF LGB		





1



<b>GEV-Nr.</b>	500937	<b>Vergl.-Nr.</b>	EPR2346-1 ZF150SX
<b>Beschreibung</b>	Pumpe Eingang ø 45mm Ausgang ø 40mm Typ ZF150SX 230V 50Hz Phasen 1 0,36kW 0,48PS L 180mm Laufrichtung rechts Kondensator 10µF Hilfsdruck 13mm Hilfsdruck offen LGB		
<b>Ersatzteile zu</b>	500937		
	<b>GEV-Nr.</b>	365015	<b>Vergl.-Nr.</b> —
	Betriebskondensator Kapazität 10µF 400V		
	<b>GEV-Nr.</b>	510703	<b>Vergl.-Nr.</b> 1001R 1058R N/A
	Gleitringdichtung für Wellen ø 13mm		
	<b>GEV-Nr.</b>	521701	<b>Vergl.-Nr.</b> 0044R
	Pumpendeckeldichtung		



1

<b>GEV-Nr.</b>	500946	<b>Vergl.-Nr.</b>	EPR2660 ZF150SX
<b>Beschreibung</b>	Pumpe Eingang ø 45mm Ausgang ø 40mm Typ ZF150SX 230V 50Hz Phasen 1 0,36kW 0,5PS L 180mm Laufrichtung rechts Kondensator 10µF LGB		
<b>Ersatzteile zu</b>	500946		
	<b>GEV-Nr.</b>	365015	<b>Vergl.-Nr.</b> —
	Betriebskondensator Kapazität 10µF 400V		
	<b>GEV-Nr.</b>	510703	<b>Vergl.-Nr.</b> 1001R 1058R N/A
	Gleitringdichtung für Wellen ø 13mm		

Tabellenfortsetzung auf der nächsten Seite

<b>Ersatzteile zu</b> 500946				
	GEV-Nr.	521140	Vergl.-Nr.	Chiocciola per Pompa EPR2660/ ZF150SX
Pumpendeckel LGB Eingang ø 45mm Ausgang ø 40mm				
	GEV-Nr.	521701	Vergl.-Nr.	0044R
Pumpendeckeldichtung				



1

<b>GEV-Nr.</b>	499096	<b>Vergl.-Nr.</b>	ZF220SX
<b>Beschreibung</b>	Pumpe Eingang ø 45mm Ausgang ø 40mm Typ ZF220SX 230V 50Hz Phasen 1 0,69kW L 188mm Laufrichtung rechts Kondensator 12,5µF LGB		



1

<b>GEV-Nr.</b>	499248	<b>Vergl.-Nr.</b>	C.F.2062 ZF220V SX	
<b>Beschreibung</b>	Pumpe Eingang ø 45mm Ausgang ø 40mm Typ ZF220VSX 230V 50Hz Phasen 1 0,85kW L 230mm Laufrichtung rechts Kondensator 12,5µF LGB			
<b>Ersatzteile zu</b> 499248				
	GEV-Nr.	365014	Vergl.-Nr.	—
Betriebskondensator Kapazität 12,5µF 400V				
	GEV-Nr.	510556	Vergl.-Nr.	N/A
O-Ring EPDM Materialstärke 1,78mm ID ø 94,97mm				
	GEV-Nr.	510694	Vergl.-Nr.	N/A
Gleitringdichtung für Wellen ø 13mm				
	GEV-Nr.	521112	Vergl.-Nr.	N/A
Laufgrad ø 93mm H 21mm Pumpentyp ZF220VSX				

<b>Ersatzteile zu</b> 499248				
	GEV-Nr.	521113	Vergl.-Nr.	N/A
Pumpendeckel LGB Eingang ø 45mm Ausgang ø 40mm				



1

<b>GEV-Nr.</b>	500470	<b>Vergl.-Nr.</b>	EPR2046 ZF270VDX	
<b>Beschreibung</b>	Pumpe Eingang ø 45mm Ausgang ø 40mm Typ ZF270VDX 230V 50Hz Phasen 1 0,6kW 0,8PS L 225mm Laufrichtung links Kondensator 12,5µF LGB			
<b>Ersatzteile zu</b> 500470				
	GEV-Nr.	365014	Vergl.-Nr.	—
Betriebskondensator Kapazität 12,5µF 400V				
	GEV-Nr.	510702	Vergl.-Nr.	N/A
Gleitringdichtung Höhe Gegenring 5,5mm				
	GEV-Nr.	521109	Vergl.-Nr.	1572R
Pumpendeckel LGB Eingang ø 45mm Ausgang ø 40mm				
	GEV-Nr.	521111	Vergl.-Nr.	1574-1R
Laufgrad ø 105mm H 29mm Gewinde M8R Welle ø 20mm				
	GEV-Nr.	521714	Vergl.-Nr.	0046R 3283R
Pumpendeckeldichtung Materialstärke 4x4mm				



1

<b>GEV-Nr.</b>	500584	<b>Vergl.-Nr.</b>	EPR1040 ZF290SX
<b>Beschreibung</b>	Pumpe Eingang ø 45mm Ausgang ø 40mm Typ ZF290SX 230V 50Hz Phasen 1 0,65kW 0,88PS L 200mm Laufrichtung rechts Kondensator 12,5µF LGB		
<b>Ersatzteile zu</b>	500584		
	<b>GEV-Nr.</b>	<b>Vergl.-Nr.</b>	—
	365014		
	Betriebskondensator Kapazität 12,5µF 400V		
	<b>GEV-Nr.</b>	<b>Vergl.-Nr.</b>	N/A
	510702		
	Gleitringdichtung Höhe Gegenring 5,5mm		
	<b>GEV-Nr.</b>	<b>Vergl.-Nr.</b>	0114-1R
	521106		
	Laufrad ø 97mm H 24mm Laufrichtung rechts		
	<b>GEV-Nr.</b>	<b>Vergl.-Nr.</b>	0878R
	521542		
	Pumpendeckel LGB Eingang ø 45mm Ausgang ø 40mm		
	<b>GEV-Nr.</b>	<b>Vergl.-Nr.</b>	0046R 3283R
	521714		
	Pumpendeckeldichtung Materialstärke 4x4mm		



1

<b>GEV-Nr.</b>	500554	<b>Vergl.-Nr.</b>	EPR2030 ZF290SX
<b>Beschreibung</b>	Pumpe Eingang ø 45mm Ausgang ø 40mm Typ ZF290SX 230V 50Hz Phasen 1 0,67kW 0,8PS L 200mm Laufrichtung rechts Kondensator 12,5µF LGB		
<b>Ersatzteile zu</b>	500554		
	<b>GEV-Nr.</b>	<b>Vergl.-Nr.</b>	—
	365014		
	Betriebskondensator Kapazität 12,5µF 400V		



1

<b>GEV-Nr.</b>	500120	<b>Vergl.-Nr.</b>	EPR0926 ZF320SX
<b>Beschreibung</b>	Pumpe Eingang ø 45mm Ausgang ø 40mm Typ ZF320SX 230V 50Hz Phasen 1 0,55kW 0,75PS L 200mm Laufrichtung rechts Kondensator 12,5µF LGB		
<b>Ersatzteile zu</b>	500120		
	<b>GEV-Nr.</b>	<b>Vergl.-Nr.</b>	—
	365014		
	Betriebskondensator Kapazität 12,5µF 400V		
	<b>GEV-Nr.</b>	<b>Vergl.-Nr.</b>	N/A
	510702		
	Gleitringdichtung Höhe Gegenring 5,5mm		
	<b>GEV-Nr.</b>	<b>Vergl.-Nr.</b>	0697-1R
	521300		
	Laufrad ø 94mm H 27mm Pumpentyp ZF320SX		
	<b>GEV-Nr.</b>	<b>Vergl.-Nr.</b>	0878R
	521542		
	Pumpendeckel LGB Eingang ø 45mm Ausgang ø 40mm		
	<b>GEV-Nr.</b>	<b>Vergl.-Nr.</b>	0046R 3283R
	521714		
	Pumpendeckeldichtung Materialstärke 4x4mm		



1

<b>GEV-Nr.</b>	500919	<b>Vergl.-Nr.</b>	EPR0629 ZF320SX
<b>Beschreibung</b>	Pumpe Eingang ø 45mm Ausgang ø 40mm Typ ZF320SX 230V 50Hz Phasen 1 0,55kW 0,75PS L 200mm Laufrichtung rechts Kondensator 12µF LGB		



<b>1</b>			
<b>GEV-Nr.</b>	500121	<b>Vergl.-Nr.</b>	EPR0630 ZF320SX
<b>Beschreibung</b>	Pumpe Eingang ø 45mm Ausgang ø 40mm Typ ZF320SX 230V 50Hz Phasen 1 0,55kW 0,75PS L 220mm Laufrichtung rechts Kondensator 12,5µF LGB		
<b>Ersatzteile zu</b>	500121		
	<b>GEV-Nr.</b>	365014	<b>Vergl.-Nr.</b> —
	Betriebskondensator Kapazität 12,5µF 400V		
	<b>GEV-Nr.</b>	510702	<b>Vergl.-Nr.</b> N/A
	Gleitringdichtung Höhe Gegenring 5,5mm		
	<b>GEV-Nr.</b>	521300	<b>Vergl.-Nr.</b> 0697-1R
	Laufrad ø 94mm H 27mm Pumpentyp ZF320SX		
	<b>GEV-Nr.</b>	521542	<b>Vergl.-Nr.</b> 0878R
	Pumpendeckel LGB Eingang ø 45mm Ausgang ø 40mm		
	<b>GEV-Nr.</b>	521714	<b>Vergl.-Nr.</b> 0046R 3283R
	Pumpendeckeldichtung Materialstärke 4x4mm		



<b>1</b>			
<b>GEV-Nr.</b>	500355	<b>Vergl.-Nr.</b>	EPR1356 ZF320SX
<b>Beschreibung</b>	Pumpe Eingang ø 45mm Ausgang ø 40mm Typ ZF320SX 230V 50Hz Phasen 1 0,7kW 0,95PS L 200mm Laufrichtung rechts Kondensator 12,5µF LGB		
<b>Ersatzteile zu</b>	500355		
	<b>GEV-Nr.</b>	365014	<b>Vergl.-Nr.</b> —
	Betriebskondensator Kapazität 12,5µF 400V		

<b>Ersatzteile zu</b>	500355		
	<b>GEV-Nr.</b>	510702	<b>Vergl.-Nr.</b> N/A
	Gleitringdichtung Höhe Gegenring 5,5mm		
	<b>GEV-Nr.</b>	512404	<b>Vergl.-Nr.</b> 0438R
	Halterung BA 130mm		
	<b>GEV-Nr.</b>	521246	<b>Vergl.-Nr.</b> 0591-1R
	Laufrad ø 103mm H 26mm Gewinde M8L Welle ø 20mm		
	<b>GEV-Nr.</b>	521542	<b>Vergl.-Nr.</b> 0878R
	Pumpendeckel LGB Eingang ø 45mm Ausgang ø 40mm		
	<b>GEV-Nr.</b>	521714	<b>Vergl.-Nr.</b> 0046R 3283R
	Pumpendeckeldichtung Materialstärke 4x4mm		



<b>1</b>			
<b>GEV-Nr.</b>	500381	<b>Vergl.-Nr.</b>	EPR0713 ZF320VSX
<b>Beschreibung</b>	Pumpe Eingang ø 45mm Ausgang ø 40mm Typ ZF320VSX 230V 50Hz Phasen 1 0,6kW 0,82PS L 230mm Laufrichtung rechts Kondensator 12,5µF LGB		
<b>Ersatzteile zu</b>	500381		
	<b>GEV-Nr.</b>	365014	<b>Vergl.-Nr.</b> —
	Betriebskondensator Kapazität 12,5µF 400V		
	<b>GEV-Nr.</b>	510702	<b>Vergl.-Nr.</b> N/A
	Gleitringdichtung Höhe Gegenring 5,5mm		
	<b>GEV-Nr.</b>	512420	<b>Vergl.-Nr.</b> 0437R
	Halterung BA 110mm		
	<b>GEV-Nr.</b>	521058	<b>Vergl.-Nr.</b> 2899R
	Lüfterradabdeckung passend für LGB ID ø 138mm		
	<b>GEV-Nr.</b>	521247	<b>Vergl.-Nr.</b> N/A
	Laufrad ø 90mm H 27mm Laufrichtung rechts		
	<b>GEV-Nr.</b>	521542	<b>Vergl.-Nr.</b> 0878R
	Pumpendeckel LGB Eingang ø 45mm Ausgang ø 40mm		
	<b>GEV-Nr.</b>	521714	<b>Vergl.-Nr.</b> 0046R 3283R
	Pumpendeckeldichtung Materialstärke 4x4mm		



1

<b>GEV-Nr.</b>	500512	<b>Vergl.-Nr.</b>	EPR1227 ZF340VSX
<b>Beschreibung</b>	Pumpe Eingang ø 45mm Ausgang ø 40mm Typ ZF340VSX 230V 50Hz Phasen 1 0,75kW 1PS L 245mm Laufrichtung rechts Kondensator 16µF LGB		
<b>Ersatzteile zu</b>	500512		
	GEV-Nr.	365021	Vergl.-Nr. —
	Betriebskondensator Kapazität 16µF 425V		
	GEV-Nr.	510702	Vergl.-Nr. N/A
	Gleitringdichtung Höhe Gegenring 5,5mm		
	GEV-Nr.	521246	Vergl.-Nr. 0591-1R
	Laufrad ø 103mm H 26mm Gewinde M8L Welle ø 20mm		
	GEV-Nr.	521542	Vergl.-Nr. 0878R
	Pumpendeckel LGB Eingang ø 45mm Ausgang ø 40mm		
	GEV-Nr.	521714	Vergl.-Nr. 0046R 3283R
	Pumpendeckeldichtung Materialstärke 4x4mm		



1

<b>GEV-Nr.</b>	499135	<b>Vergl.-Nr.</b>	EPR2898 ZF350SX
<b>Beschreibung</b>	Pumpe Eingang ø 45mm Ausgang ø 40mm Typ ZF350SX 230/400V 50Hz Phasen 3 0,61kW L 220mm Laufrichtung rechts LGB		
<b>Ersatzteile zu</b>	499135		
	GEV-Nr.	510702	Vergl.-Nr. N/A
	Gleitringdichtung Höhe Gegenring 5,5mm		

<b>Ersatzteile zu</b>	499135		
	GEV-Nr.	521089	Vergl.-Nr. 2037R
	Laufrad ø 88mm H 32mm Gewinde M8L		
	GEV-Nr.	521542	Vergl.-Nr. 0878R
	Pumpendeckel LGB Eingang ø 45mm Ausgang ø 40mm		
	GEV-Nr.	521714	Vergl.-Nr. 0046R 3283R
	Pumpendeckeldichtung Materialstärke 4x4mm		



1

<b>GEV-Nr.</b>	499011	<b>Vergl.-Nr.</b>	EPR2022 ZF350SX
<b>Beschreibung</b>	Pumpe Eingang ø 50mm Ausgang ø 40mm Typ ZF350SX 230V 50Hz Phasen 1 0,63kW L 201mm Laufrichtung rechts LGB 2800U/min passender Kondensator 12,5µF		
<b>Ersatzteile zu</b>	499011		
	GEV-Nr.	365014	Vergl.-Nr. —
	Betriebskondensator Kapazität 12,5µF 400V		
	GEV-Nr.	510702	Vergl.-Nr. N/A
	Gleitringdichtung Höhe Gegenring 5,5mm		
	GEV-Nr.	521086	Vergl.-Nr. 1435R
	Pumpendeckel LGB Eingang ø 50mm Ausgang ø 40mm		
	GEV-Nr.	521278	Vergl.-Nr. 2037R
	Laufrad ø 93mm H 32mm Pumpentyp ZF350SX		
	GEV-Nr.	521714	Vergl.-Nr. 0046R 3283R
	Pumpendeckeldichtung Materialstärke 4x4mm		





<b>GEV-Nr.</b>	500924	<b>Vergl.-Nr.</b>	EPR2353-1 ZF350VSX
<b>Beschreibung</b>	Pumpe Eingang ø 50mm Ausgang ø 40mm Typ ZF350VSX 440V 60Hz Phasen 3 0,75kW 1PS L 230mm Laufrichtung rechts LGB		



<b>GEV-Nr.</b>	499058	<b>Vergl.-Nr.</b>	EPR2024 ZF380SX
<b>Beschreibung</b>	Pumpe Eingang ø 50mm Ausgang ø 40mm Typ ZF380SX 230V 50Hz Phasen 1 0,73kW 0,99PS L 210mm Laufrichtung rechts Kondensator 16µF LGB		

<b>Ersatzteile zu</b>	499058		
	<b>GEV-Nr.</b>	<b>Vergl.-Nr.</b>	—
	Betriebskondensator Kapazität 16µF 425V		
	<b>GEV-Nr.</b>	<b>Vergl.-Nr.</b>	N/A
	Gleitringdichtung Höhe Gegenring 5,5mm		
	<b>GEV-Nr.</b>	<b>Vergl.-Nr.</b>	1435R
	Pumpendeckel LGB Eingang ø 50mm Ausgang ø 40mm		
	<b>GEV-Nr.</b>	<b>Vergl.-Nr.</b>	2038-1R
	Lauftrad ø 100mm H 32mm Gewinde M8L		
	<b>GEV-Nr.</b>	<b>Vergl.-Nr.</b>	0046R 3283R
	Pumpendeckeldichtung Materialstärke 4x4mm		



<b>GEV-Nr.</b>	500092	<b>Vergl.-Nr.</b>	W300SX
<b>Beschreibung</b>	Pumpe Eingang ø 50mm Ausgang ø 44mm Typ W300SX 230V 50Hz Phasen 1 0,3kW 0,5PS L 170mm Laufrichtung rechts Kondensator 10µF LGB		

<b>Ersatzteile zu</b>	500092		
	<b>GEV-Nr.</b>	<b>Vergl.-Nr.</b>	—
	Betriebskondensator Kapazität 10µF 400V		
	<b>GEV-Nr.</b>	<b>Vergl.-Nr.</b>	n/a
	O-Ring EPDM Materialstärke 2mm ID ø 120mm		
	<b>GEV-Nr.</b>	<b>Vergl.-Nr.</b>	N/A
	Lauftrad ø 85mm H 29mm Achsaufnahme ø 9x8mm		
	<b>GEV-Nr.</b>	<b>Vergl.-Nr.</b>	N/A
	Gleitringdichtung für Wellen ø 12mm		
	<b>GEV-Nr.</b>	<b>Vergl.-Nr.</b>	—
	Pumpendeckelunterteil		
	<b>GEV-Nr.</b>	<b>Vergl.-Nr.</b>	N/A
	Pumpendeckel		



<b>GEV-Nr.</b>	500093	<b>Vergl.-Nr.</b>	EPR0962 W500SX
<b>Beschreibung</b>	Pumpe Eingang ø 50mm Ausgang ø 44mm Typ W500SX 230V 50Hz Phasen 1 0,5kW 0,7PS L 200mm Laufrichtung rechts Kondensator 16µF LGB		

<b>Ersatzteile zu</b>	500093		
	<b>GEV-Nr.</b>	<b>Vergl.-Nr.</b>	—
	Betriebskondensator Kapazität 16µF 425V		

Tabellenfortsetzung auf der nächsten Seite

<b>Ersatzteile zu</b> 500093			
	GEV-Nr.	510607	Vergl.-Nr. N/A
Laufrad ø 85mm H 29mm Achsaufnahme ø 9x8mm			
	GEV-Nr.	510693	Vergl.-Nr. N/A
Gleitringdichtung für Wellen ø 12mm			
	GEV-Nr.	521564	Vergl.-Nr. N/A
Pumpendeckel			
	GEV-Nr.	521717	Vergl.-Nr. N/A
O-Ring EPDM Materialstärke 1,78mm ID ø 120,37mm			



<b>1</b>			
<b>GEV-Nr.</b>	499306	<b>Vergl.-Nr.</b>	ZF650SX (2473 - 9099.ZF650.00)
<b>Beschreibung</b>	Pumpe Eingang ø 50mm Ausgang ø 48mm Typ ZF650SX 230V 50Hz Phasen 1 1,47kW L 340mm Laufrichtung rechts LGB		
<b>Ersatzteile zu</b> 499306			
	GEV-Nr.	365019	Vergl.-Nr. —
Betriebskondensator Kapazität 20µF 400V			
	GEV-Nr.	510551	Vergl.-Nr. 0049R
Pumpendeckeldichtung ID ø 158,3mm			
	GEV-Nr.	510694	Vergl.-Nr. N/A
Gleitringdichtung für Wellen ø 13mm			
	GEV-Nr.	521108	Vergl.-Nr. 0021R
Pumpendeckel LGB Eingang ø 50mm Ausgang ø 50mm			
	GEV-Nr.	521240	Vergl.-Nr. 2500R
Laufrad ø 110mm H 32mm Laufrichtung links			



<b>1</b>			
<b>GEV-Nr.</b>	500156	<b>Vergl.-Nr.</b>	EPR0461 ZF400SX
<b>Beschreibung</b>	Pumpe Eingang ø 50mm Ausgang ø 50mm Typ ZF400SX 230V 50Hz Phasen 1 0,6kW 0,8PS L 210mm Laufrichtung rechts Kondensator 16µF LGB		
<b>Ersatzteile zu</b> 500156			
	GEV-Nr.	365021	Vergl.-Nr. —
Betriebskondensator Kapazität 16µF 425V			
	GEV-Nr.	509020	Vergl.-Nr. 1834R
Laufrad ø 104mm H 25mm M8L			
	GEV-Nr.	510703	Vergl.-Nr. 1001R 1058R N/A
Gleitringdichtung für Wellen ø 13mm			
	GEV-Nr.	521548	Vergl.-Nr. 0020R
Pumpendeckel LGB Eingang ø 50mm Ausgang ø 50mm			
	GEV-Nr.	521734	Vergl.-Nr. —
Pumpendeckelunterteil			
	GEV-Nr.	523509	Vergl.-Nr. —
Rillenkugellager Welle ø 12mm AD ø 32mm B 10mm			
	GEV-Nr.	532623	Vergl.-Nr. 1743R
O-Ring EPDM Materialstärke 2,62mm ID ø 120,32mm			



<b>1</b>			
<b>GEV-Nr.</b>	499225	<b>Vergl.-Nr.</b>	ZF400VSX
<b>Beschreibung</b>	Pumpe Eingang ø 50mm Ausgang ø 50mm Typ ZF400VSX 230V 50Hz Phasen 1 0,81kW 1,1PS L 245mm Laufrichtung rechts Kondensator 16µF C 34 dgt / C 44 dgt LGB		
<b>Ersatzteile zu</b>	499225		
	<b>GEV-Nr.</b>	365021	<b>Vergl.-Nr.</b> —
	Betriebskondensator Kapazität 16µF 425V		
	<b>GEV-Nr.</b>	510703	<b>Vergl.-Nr.</b> 1001R 1058R N/A
	Gleitringdichtung für Wellen ø 13mm		
	<b>GEV-Nr.</b>	521090	<b>Vergl.-Nr.</b> Girante per Pompa ZF400SX EPR2287
	Laufрад ø 101mm H 32mm Gewinde M8L Welle ø 13mm		
	<b>GEV-Nr.</b>	521548	<b>Vergl.-Nr.</b> 0020R
	Pumpendeckel LGB Eingang ø 50mm Ausgang ø 50mm		
	<b>GEV-Nr.</b>	532623	<b>Vergl.-Nr.</b> 1743R
	O-Ring EPDM Materialstärke 2,62mm ID ø 120,32mm		



<b>1</b>			
<b>GEV-Nr.</b>	500543	<b>Vergl.-Nr.</b>	EPR0634 ZF400VSX
<b>Beschreibung</b>	Pumpe Eingang ø 50mm Ausgang ø 50mm Typ ZF400VSX 230V 50Hz Phasen 1 0,85kW 1,2PS L 245mm Laufrichtung rechts Kondensator 16µF LGB		
<b>Ersatzteile zu</b>	500543		
	<b>GEV-Nr.</b>	365021	<b>Vergl.-Nr.</b> —
	Betriebskondensator Kapazität 16µF 425V		
	<b>GEV-Nr.</b>	509020	<b>Vergl.-Nr.</b> 1834R
	Laufрад ø 104mm H 25mm M8L		

<b>Ersatzteile zu</b>	500543		
	<b>GEV-Nr.</b>	510703	<b>Vergl.-Nr.</b> 1001R 1058R N/A
	Gleitringdichtung für Wellen ø 13mm		
	<b>GEV-Nr.</b>	521548	<b>Vergl.-Nr.</b> 0020R
	Pumpendeckel LGB Eingang ø 50mm Ausgang ø 50mm		
	<b>GEV-Nr.</b>	521734	<b>Vergl.-Nr.</b> —
	Pumpendeckelunterteil		
	<b>GEV-Nr.</b>	532623	<b>Vergl.-Nr.</b> 1743R
	O-Ring EPDM Materialstärke 2,62mm ID ø 120,32mm		



<b>1</b>			
<b>GEV-Nr.</b>	500361	<b>Vergl.-Nr.</b>	EPR1230 ZF400SX
<b>Beschreibung</b>	Pumpe Eingang ø 60mm Ausgang ø 49mm Typ ZF400SX 230V 50Hz Phasen 1 0,8kW 1PS L 210mm Laufrichtung rechts Kondensator 16µF LGB		
<b>Ersatzteile zu</b>	500361		
	<b>GEV-Nr.</b>	365021	<b>Vergl.-Nr.</b> —
	Betriebskondensator Kapazität 16µF 425V		
	<b>GEV-Nr.</b>	509020	<b>Vergl.-Nr.</b> 1834R
	Laufрад ø 104mm H 25mm M8L		
	<b>GEV-Nr.</b>	510703	<b>Vergl.-Nr.</b> 1001R 1058R N/A
	Gleitringdichtung für Wellen ø 13mm		
	<b>GEV-Nr.</b>	521547	<b>Vergl.-Nr.</b> 0758R 0758R (blu)
	Pumpendeckel LGB Eingang ø 60mm Ausgang ø 50mm		
	<b>GEV-Nr.</b>	532623	<b>Vergl.-Nr.</b> 1743R
	O-Ring EPDM Materialstärke 2,62mm ID ø 120,32mm		



1

<b>GEV-Nr.</b>	501527	<b>Vergl.-Nr.</b>	CF2420 ZF400SX 60HZ
<b>Beschreibung</b>	Pumpe Eingang ø 60mm Ausgang ø 49mm Typ ZF400SX 230V 60Hz Phasen 1 0,77kW 1PS L 210mm Laufrichtung rechts Kondensator 16µF LGB		
<b>Ersatzteile zu</b>	501527		
	GEV-Nr.	365021	Vergl.-Nr. —
	Betriebskondensator Kapazität 16µF 425V		
	GEV-Nr.	509020	Vergl.-Nr. 1834R
	Laufrad ø 104mm H 25mm M8L		
	GEV-Nr.	510703	Vergl.-Nr. 1001R 1058R N/A
	Gleitringdichtung für Wellen ø 13mm		
	GEV-Nr.	521547	Vergl.-Nr. 0758R 0758R (blu)
	Pumpendeckel LGB Eingang ø 60mm Ausgang ø 50mm		
	GEV-Nr.	532623	Vergl.-Nr. 1743R
	O-Ring EPDM Materialstärke 2,62mm ID ø 120,32mm		



1

<b>GEV-Nr.</b>	499282	<b>Vergl.-Nr.</b>	2196 ZF400VSX
<b>Beschreibung</b>	Pumpe Eingang ø 60mm Ausgang ø 49mm Typ ZF400VSX 220-230/380-400V 50Hz Phasen 3 0,7kW L 270mm Laufrichtung rechts LGB		
<b>Ersatzteile zu</b>	499282		
	GEV-Nr.	502279	Vergl.-Nr. 2038R
	Laufrad H 31mm AD ø 100mm Schaufeln 6		
	GEV-Nr.	510702	Vergl.-Nr. N/A
	Gleitringdichtung Höhe Gegenring 5,5mm		

<b>Ersatzteile zu</b>	499282		
	GEV-Nr.	521058	Vergl.-Nr. 2899R
	Lüfterradabdeckung passend für LGB ID ø 138mm		
	GEV-Nr.	521547	Vergl.-Nr. 0758R 0758R (blu)
	Pumpendeckel LGB Eingang ø 60mm Ausgang ø 50mm		
	GEV-Nr.	532623	Vergl.-Nr. 1743R
	O-Ring EPDM Materialstärke 2,62mm ID ø 120,32mm		





1

<b>GEV-Nr.</b>	499114	<b>Vergl.-Nr.</b>	EPR1831
<b>Beschreibung</b>	Pumpe Eingang ø 60mm Ausgang ø 50mm 220-240V 50Hz Phasen 1 0,7kW L 245mm Laufrichtung rechts Kondensator 16µF		
<b>Ersatzteile zu</b>	499114		
	GEV-Nr.	365021	Vergl.-Nr. —
	Betriebskondensator Kapazität 16µF 425V		
	GEV-Nr.	509020	Vergl.-Nr. 1834R
	Laufrad ø 104mm H 25mm M8L		
	GEV-Nr.	510703	Vergl.-Nr. 1001R 1058R N/A
	Gleitringdichtung für Wellen ø 13mm		
<b>Bild nicht vorhanden</b>	GEV-Nr.	521049	Vergl.-Nr. —
	Servicekit für Pumpe Typ ZF400VSX LGB		
	GEV-Nr.	521547	Vergl.-Nr. 0758R 0758R (blu)
	Pumpendeckel LGB Eingang ø 60mm Ausgang ø 50mm		
	GEV-Nr.	532623	Vergl.-Nr. 1743R
	O-Ring EPDM Materialstärke 2,62mm ID ø 120,32mm		







1

<b>GEV-Nr.</b>	500001	<b>Vergl.-Nr.</b>	EPR1638 T150SX
<b>Beschreibung</b>	Pumpe Eingang ø 60mm Ausgang ø 50mm Typ T150SX 230/400V 50Hz Phasen 3 0,9kW 1,2PS L 290mm Laufrichtung rechts LGB		
<b>Ersatzteile zu</b>	500001		
	<b>GEV-Nr.</b>	509020	<b>Vergl.-Nr.</b> 1834R
	Laufrad ø 104mm H 25mm M8L		
	<b>GEV-Nr.</b>	510703	<b>Vergl.-Nr.</b> 1001R 1058R N/A
	Gleitringdichtung für Wellen ø 13mm		
	<b>GEV-Nr.</b>	521547	<b>Vergl.-Nr.</b> 0758R 0758R (blu)
	Pumpendeckel LGB Eingang ø 60mm Ausgang ø 50mm		
	<b>GEV-Nr.</b>	532623	<b>Vergl.-Nr.</b> 1743R
	O-Ring EPDM Materialstärke 2,62mm ID ø 120,32mm		



1

<b>GEV-Nr.</b>	500091	<b>Vergl.-Nr.</b>	EPR0464 ZA160SX
<b>Beschreibung</b>	Pumpe Eingang ø 60mm Ausgang ø 50mm Typ ZA160SX 230/400V 50Hz Phasen 3 1,1kW 1,5PS L 310mm Laufrichtung rechts LGB		
<b>Ersatzteile zu</b>	500091		
	<b>GEV-Nr.</b>	510554	<b>Vergl.-Nr.</b> n/a
	O-Ring EPDM Materialstärke 2mm ID ø 120mm		
	<b>GEV-Nr.</b>	510616	<b>Vergl.-Nr.</b> 0123R
	Laufrad ø 104mm H 25mm Achsaufnahme ø 10mm		

<b>Ersatzteile zu</b>	500091			
	<b>GEV-Nr.</b>	510703	<b>Vergl.-Nr.</b>	1001R 1058R N/A
	Gleitringdichtung für Wellen ø 13mm			
	<b>GEV-Nr.</b>	521547	<b>Vergl.-Nr.</b>	0758R 0758R (blu)
	Pumpendeckel LGB Eingang ø 60mm Ausgang ø 50mm			



1

<b>GEV-Nr.</b>	500148	<b>Vergl.-Nr.</b>	EPR0650 ZA160SX
<b>Beschreibung</b>	Pumpe Eingang ø 60mm Ausgang ø 50mm Typ ZA160SX 230V 50Hz Phasen 1 1,1kW 1,5PS L 310mm Laufrichtung rechts Kondensator 25µF LGB		
<b>Ersatzteile zu</b>	500148		
	<b>GEV-Nr.</b>	365109	<b>Vergl.-Nr.</b> —
	Betriebskondensator Kapazität 25µF 400V		
	<b>GEV-Nr.</b>	510616	<b>Vergl.-Nr.</b> 0123R
	Laufrad ø 104mm H 25mm Achsaufnahme ø 10mm		
	<b>GEV-Nr.</b>	510703	<b>Vergl.-Nr.</b> 1001R 1058R N/A
	Gleitringdichtung für Wellen ø 13mm		
	<b>GEV-Nr.</b>	521547	<b>Vergl.-Nr.</b> 0758R 0758R (blu)
	Pumpendeckel LGB Eingang ø 60mm Ausgang ø 50mm		
	<b>GEV-Nr.</b>	532623	<b>Vergl.-Nr.</b> 1743R
	O-Ring EPDM Materialstärke 2,62mm ID ø 120,32mm		



1

<b>GEV-Nr.</b>	500002	<b>Vergl.-Nr.</b>	EPR0460A ZA400SX
<b>Beschreibung</b>	Pumpe Eingang ø 60mm Ausgang ø 50mm Typ ZA400SX 230V 50Hz Phasen 1 0,9kW 1,2PS L 300mm Laufrichtung rechts Kondensator 20µF LGB		
<b>Ersatzteile zu</b>	500002		
	<b>GEV-Nr.</b>	<b>Vergl.-Nr.</b>	—
	Betriebskondensator Kapazität 20µF 400V		
	<b>GEV-Nr.</b>	<b>Vergl.-Nr.</b>	1834R
	Laufrad ø 104mm H 25mm M8L		
	<b>GEV-Nr.</b>	<b>Vergl.-Nr.</b>	1001R 1058R N/A
	Gleitringdichtung für Wellen ø 13mm		
	<b>GEV-Nr.</b>	<b>Vergl.-Nr.</b>	0758R 0758R (blu)
	Pumpendeckel LGB Eingang ø 60mm Ausgang ø 50mm		
	<b>GEV-Nr.</b>	<b>Vergl.-Nr.</b>	1743R
	O-Ring EPDM Materialstärke 2,62mm ID ø 120,32mm		



1

<b>GEV-Nr.</b>	500474	<b>Vergl.-Nr.</b>	EPR1622 ZF400SX
<b>Beschreibung</b>	Pumpe Eingang ø 60mm Ausgang ø 50mm Typ ZF400SX 230V 50Hz Phasen 1 0,7kW 0,95PS L 215mm Laufrichtung rechts Kondensator 16µF LGB		
<b>Ersatzteile zu</b>	500474		
	<b>GEV-Nr.</b>	<b>Vergl.-Nr.</b>	—
	Betriebskondensator Kapazität 16µF 425V		

**Ersatzteile zu** 500474

	<b>GEV-Nr.</b>	<b>Vergl.-Nr.</b>	1834R
	Laufrad ø 104mm H 25mm M8L		
	<b>GEV-Nr.</b>	<b>Vergl.-Nr.</b>	1001R 1058R N/A
	Gleitringdichtung für Wellen ø 13mm		
	<b>GEV-Nr.</b>	<b>Vergl.-Nr.</b>	0758R 0758R (blu)
	Pumpendeckel LGB Eingang ø 60mm Ausgang ø 50mm		
	<b>GEV-Nr.</b>	<b>Vergl.-Nr.</b>	1743R
	O-Ring EPDM Materialstärke 2,62mm ID ø 120,32mm		



1

<b>GEV-Nr.</b>	499126	<b>Vergl.-Nr.</b>	EPR2287 ZF400SX
<b>Beschreibung</b>	Pumpe Eingang ø 60mm Ausgang ø 50mm Typ ZF400SX 230V 50Hz Phasen 1 1,1kW L 215mm Laufrichtung rechts Kondensator 16µF LGB		
<b>Ersatzteile zu</b>	499126		
	<b>GEV-Nr.</b>	<b>Vergl.-Nr.</b>	—
	Betriebskondensator Kapazität 16µF 425V		
	<b>GEV-Nr.</b>	<b>Vergl.-Nr.</b>	1001R 1058R N/A
	Gleitringdichtung für Wellen ø 13mm		
	<b>GEV-Nr.</b>	<b>Vergl.-Nr.</b>	Girante per Pompa ZF400SX EPR2287
	Laufrad ø 101mm H 32mm Gewinde M8L Welle ø 13mm		
	<b>GEV-Nr.</b>	<b>Vergl.-Nr.</b>	0758R 0758R (blu)
	Pumpendeckel LGB Eingang ø 60mm Ausgang ø 50mm		
	<b>GEV-Nr.</b>	<b>Vergl.-Nr.</b>	1743R
	O-Ring EPDM Materialstärke 2,62mm ID ø 120,32mm		





<b>GEV-Nr.</b>	500486	<b>Vergl.-Nr.</b>	EPR1623 ZF400SX
<b>Beschreibung</b>	Pumpe Eingang ø 60mm Ausgang ø 50mm Typ ZF400VSX 230V 50Hz Phasen 1 0,7kW 0,95PS L 255mm Laufrichtung rechts Kondensator 16µF LGB		
<b>Ersatzteile zu</b>	500486		
	<b>GEV-Nr.</b>	365021	<b>Vergl.-Nr.</b> —
	Betriebskondensator Kapazität 16µF 425V		
	<b>GEV-Nr.</b>	509020	<b>Vergl.-Nr.</b> 1834R
	Laufrad ø 104mm H 25mm M8L		
	<b>GEV-Nr.</b>	510703	<b>Vergl.-Nr.</b> 1001R 1058R N/A
	Gleitringdichtung für Wellen ø 13mm		
	<b>GEV-Nr.</b>	512404	<b>Vergl.-Nr.</b> 0438R
	Halterung BA 130mm		
	<b>GEV-Nr.</b>	521058	<b>Vergl.-Nr.</b> 2899R
	Lüfterradabdeckung passend für LGB ID ø 138mm		
	<b>GEV-Nr.</b>	521547	<b>Vergl.-Nr.</b> 0758R 0758R (blu)
	Pumpendeckel LGB Eingang ø 60mm Ausgang ø 50mm		
	<b>GEV-Nr.</b>	532623	<b>Vergl.-Nr.</b> 1743R
	O-Ring EPDM Materialstärke 2,62mm ID ø 120,32mm		





<b>GEV-Nr.</b>	500377	<b>Vergl.-Nr.</b>	EPR1007 ZF800DX
<b>Beschreibung</b>	Pumpe Eingang ø 61mm Ausgang ø 52mm Typ ZF800DX 230/400V 50Hz Phasen 3 2kW 2,72PS L 330mm Laufrichtung links LGB		
<b>Ersatzteile zu</b>	500377		
	<b>GEV-Nr.</b>	510551	<b>Vergl.-Nr.</b> 0049R
	Pumpendeckeldichtung ID ø 158,3mm		
	<b>GEV-Nr.</b>	510694	<b>Vergl.-Nr.</b> N/A
	Gleitringdichtung für Wellen ø 13mm		
	<b>GEV-Nr.</b>	521276	<b>Vergl.-Nr.</b> 1360-1R
	Laufrad ø 120mm H 39mm Pumpentyp ZF800DX		
	<b>GEV-Nr.</b>	521516	<b>Vergl.-Nr.</b> 0648R
	Pumpendeckel LGB Eingang ø 62mm Ausgang ø 52mm		







<b>GEV-Nr.</b>	500380	<b>Vergl.-Nr.</b>	EPR1208 ZF1200SX
<b>Beschreibung</b>	Pumpe Eingang ø 61mm Ausgang ø 61mm Typ ZF1200SX 230/400V 50Hz Phasen 3 3,2kW 4,4PS L 370mm Laufrichtung rechts Kondensator 16µF LGB		
<b>Ersatzteile zu</b>	500380		
	<b>GEV-Nr.</b>	510896	<b>Vergl.-Nr.</b> 1158R
	O-Ring EPDM Materialstärke 3,53mm ID ø 183,75mm		
	<b>GEV-Nr.</b>	521053	<b>Vergl.-Nr.</b> 1139R
	Pumpendeckel LGB Eingang ø 61mm Ausgang ø 61mm		





Tabellenfortsetzung auf der nächsten Seite

<b>Ersatzteile zu</b> 500380			
	GEV-Nr.	521054	Vergl.-Nr. 1161-1R
Laufrad ø 135mm H 37mm Achsaufnahme ø 18mm			
	GEV-Nr.	521055	Vergl.-Nr. 1159R
Gleitring mit Dichtung ID ø 21mm			
	GEV-Nr.	521056	Vergl.-Nr. 1160R
Laufring für Wellen ø 20mm AD ø 39mm H 16mm			



<b>1</b>			
<b>GEV-Nr.</b>	499241	<b>Vergl.-Nr.</b>	ZF650SX
<b>Beschreibung</b>	Pumpe Eingang ø 62mm Ausgang ø 48mm Typ ZF650SX 230/400V 50Hz Phasen 3 1,33kW L 340mm Laufrichtung rechts LGB		
<b>Ersatzteile zu</b> 499241			
	GEV-Nr.	510551	Vergl.-Nr. 0049R
Pumpendeckeldichtung ID ø 158,3mm			
	GEV-Nr.	510694	Vergl.-Nr. N/A
Gleitringdichtung für Wellen ø 13mm			
	GEV-Nr.	521240	Vergl.-Nr. 2500R
Laufrad ø 110mm H 32mm Laufrichtung links			
	GEV-Nr.	521536	Vergl.-Nr. 0022R
Pumpendeckel ALBA / LGB Eingang ø 62mm			



<b>1</b>			
<b>GEV-Nr.</b>	500376	<b>Vergl.-Nr.</b>	AM5225SX EPR1020 EPR1020A
<b>Beschreibung</b>	Pumpe Eingang ø 62mm Ausgang ø 50mm Typ AM5225SX 230V 50Hz Phasen 1 0,9kW 1,2PS L 300mm Laufrichtung rechts Kondensator 16µF LGB		
<b>Ersatzteile zu</b> 500376			
	GEV-Nr.	365021	Vergl.-Nr. —
Betriebskondensator Kapazität 16µF 425V			
	GEV-Nr.	510551	Vergl.-Nr. 0049R
Pumpendeckeldichtung ID ø 158,3mm			
	GEV-Nr.	510694	Vergl.-Nr. N/A
Gleitringdichtung für Wellen ø 13mm			
	GEV-Nr.	512029	Vergl.-Nr. 1339D103
Laufrad ø 103mm H 26mm Gewinde M8L Welle ø 19mm			
	GEV-Nr.	521536	Vergl.-Nr. 0022R
Pumpendeckel ALBA / LGB Eingang ø 62mm			





<b>1</b>			
<b>GEV-Nr.</b>	500362	<b>Vergl.-Nr.</b>	CE150SX EPR0727
<b>Beschreibung</b>	Pumpe Eingang ø 62mm Ausgang ø 50mm Typ CE150SX 230/400V 50Hz Phasen 3 1,1kW 1,5PS L 280mm Laufrichtung rechts LGB		
<b>Ersatzteile zu</b>	500362		
	GEV-Nr. 510551	Vergl.-Nr.	0049R
	Pumpendeckeldichtung ID ø 158,3mm		
	GEV-Nr. 510693	Vergl.-Nr.	N/A
	Gleitringdichtung für Wellen ø 12mm		
	GEV-Nr. 521240	Vergl.-Nr.	2500R
	Laufrad ø 110mm H 32mm Laufrichtung links		
	GEV-Nr. 521536	Vergl.-Nr.	0022R
	Pumpendeckel ALBA / LGB Eingang ø 62mm		
	GEV-Nr. 602013	Vergl.-Nr.	Lüfterrad für 500362 Ventola per 500362
	Lüfterrad ø 100mm H 28mm Achsaufnahme ø 17,5mm		



<b>1</b>			
<b>GEV-Nr.</b>	500360	<b>Vergl.-Nr.</b>	EPR1231 ZF522SX
<b>Beschreibung</b>	Pumpe Eingang ø 62mm Ausgang ø 50mm Typ ZF522SX 230V 50Hz Phasen 1 1,1kW 1,5PS L 220mm Laufrichtung rechts Kondensator 16µF LGB		
<b>Ersatzteile zu</b>	500360		
	GEV-Nr. 365021	Vergl.-Nr.	—
	Betriebskondensator Kapazität 16µF 425V		
	GEV-Nr. 510551	Vergl.-Nr.	0049R
	Pumpendeckeldichtung ID ø 158,3mm		
	GEV-Nr. 510693	Vergl.-Nr.	N/A
	Gleitringdichtung für Wellen ø 12mm		
	GEV-Nr. 521280	Vergl.-Nr.	1339-1R
	Laufrad ø 107mm H 26mm Gewinde M8L Welle ø 20mm		
	GEV-Nr. 521536	Vergl.-Nr.	0022R
	Pumpendeckel ALBA / LGB Eingang ø 62mm		



1

<b>GEV-Nr.</b>	499163	<b>Vergl.-Nr.</b>	C.F.2147 EPR 2147 kondenschutz ZF 522VSX
<b>Beschreibung</b>	Pumpe Eingang ø 62mm Ausgang ø 50mm Typ ZF522VSX 230V 50Hz Phasen 1 0,76kW 1PS L 255mm Laufrichtung rechts Kondensator 16µF LGB		
<b>Ersatzteile zu</b>	499163		
	<b>GEV-Nr.</b>	365021	<b>Vergl.-Nr.</b> —
	Betriebskondensator Kapazität 16µF 425V		
	<b>GEV-Nr.</b>	510551	<b>Vergl.-Nr.</b> 0049R
	Pumpendeckeldichtung ID ø 158,3mm		
	<b>GEV-Nr.</b>	510693	<b>Vergl.-Nr.</b> N/A
	Gleitringdichtung für Wellen ø 12mm		
	<b>GEV-Nr.</b>	521239	<b>Vergl.-Nr.</b> 2510R
	Lauftrad ø 110mm H 26mm Laufrichtung rechts		
	<b>GEV-Nr.</b>	521536	<b>Vergl.-Nr.</b> 0022R
	Pumpendeckel ALBA / LGB Eingang ø 62mm		



1

<b>GEV-Nr.</b>	500943	<b>Vergl.-Nr.</b>	EPR1625 ZF522VSX
<b>Beschreibung</b>	Pumpe Eingang ø 62mm Ausgang ø 50mm Typ ZF522VSX 230V 50Hz Phasen 1 0,7kW 0,95PS L 250mm Laufrichtung rechts Kondensator 16µF LGB		
<b>Ersatzteile zu</b>	500943		
	<b>GEV-Nr.</b>	365021	<b>Vergl.-Nr.</b> —
	Betriebskondensator Kapazität 16µF 425V		
	<b>GEV-Nr.</b>	510551	<b>Vergl.-Nr.</b> 0049R
	Pumpendeckeldichtung ID ø 158,3mm		
	<b>GEV-Nr.</b>	510694	<b>Vergl.-Nr.</b> N/A
	Gleitringdichtung für Wellen ø 13mm		
	<b>GEV-Nr.</b>	512029	<b>Vergl.-Nr.</b> 1339D103
	Lauftrad ø 103mm H 26mm Gewinde M8L Welle ø 19mm		
	<b>GEV-Nr.</b>	521536	<b>Vergl.-Nr.</b> 0022R
	Pumpendeckel ALBA / LGB Eingang ø 62mm		



1

<b>GEV-Nr.</b>	499267	<b>Vergl.-Nr.</b>	ZF523VSX
<b>Beschreibung</b>	Pumpe Eingang ø 62mm Ausgang ø 50mm Typ ZF523VSX 230/400V 60Hz Phasen 3 1,1kW L 282mm Laufrichtung rechts LGB		
<b>Ersatzteile zu</b>	499267		
	GEV-Nr.	510551	Vergl.-Nr. 0049R
	Pumpendeckeldichtung ID ø 158,3mm		
	GEV-Nr.	510693	Vergl.-Nr. N/A
	Gleitringdichtung für Wellen ø 12mm		
	GEV-Nr.	521093	Vergl.-Nr. Girante per Pompa ZF523 VSX 60Hz
	Laufrad ø 85mm H 29mm Gewinde M8L Welle ø 20mm		
	GEV-Nr.	521536	Vergl.-Nr. 0022R
	Pumpendeckel ALBA / LGB Eingang ø 62mm		

**Ersatzteile zu** 500379

	GEV-Nr.	521536	Vergl.-Nr. 0022R
	Pumpendeckel ALBA / LGB Eingang ø 62mm		



1

<b>GEV-Nr.</b>	499238	<b>Vergl.-Nr.</b>	ZF650SX
<b>Beschreibung</b>	Pumpe Eingang ø 62mm Ausgang ø 50mm Typ ZF650SX 230/400V 50Hz Phasen 3 1,7kW L 340mm Laufrichtung rechts LGB		
<b>Ersatzteile zu</b>	499238		
	GEV-Nr.	510551	Vergl.-Nr. 0049R
	Pumpendeckeldichtung ID ø 158,3mm		
	GEV-Nr.	510694	Vergl.-Nr. N/A
	Gleitringdichtung für Wellen ø 13mm		
	GEV-Nr.	521094	Vergl.-Nr. 2853R
	Laufrad ø 105mm H 34mm Gewinde M8L Welle ø 27mm		
	GEV-Nr.	521536	Vergl.-Nr. 0022R
	Pumpendeckel ALBA / LGB Eingang ø 62mm		



1



<b>GEV-Nr.</b>	500379	<b>Vergl.-Nr.</b>	EPR1005 ZF650SX
<b>Beschreibung</b>	Pumpe Eingang ø 62mm Ausgang ø 50mm Typ ZF650SX 230/400V 50Hz Phasen 3 1,35kW 1,8PS L 335mm Laufrichtung rechts LGB		
<b>Ersatzteile zu</b>	500379		
	GEV-Nr.	510551	Vergl.-Nr. 0049R
	Pumpendeckeldichtung ID ø 158,3mm		
	GEV-Nr.	510694	Vergl.-Nr. N/A
	Gleitringdichtung für Wellen ø 13mm		
	GEV-Nr.	521240	Vergl.-Nr. 2500R
	Laufrad ø 110mm H 32mm Laufrichtung links		



1





<b>GEV-Nr.</b>	500378	<b>Vergl.-Nr.</b>	EPR1006 ZF800SX
<b>Beschreibung</b>	Pumpe Eingang ø 62mm Ausgang ø 50mm Typ ZF800SX 230/400V 50Hz Phasen 3 2kW 2,72PS L 340mm Laufrichtung rechts LGB		
<b>Ersatzteile zu</b>	500378		
	GEV-Nr.	510551	Vergl.-Nr. 0049R
	Pumpendeckeldichtung ID ø 158,3mm		
	GEV-Nr.	510694	Vergl.-Nr. N/A
	Gleitringdichtung für Wellen ø 13mm		

Tabellenfortsetzung auf der nächsten Seite

<b>Ersatzteile zu</b> 500378			
	GEV-Nr.	521242	Vergl.-Nr. 2853R
Laufrad ø 115mm H 36mm M8L Achsaufnahme ø 12mm			
	GEV-Nr.	521536	Vergl.-Nr. 0022R
Pumpendeckel ALBA / LGB Eingang ø 62mm			







<b>GEV-Nr.</b>	499247	<b>Vergl.-Nr.</b>	1612 ZF650DX
<b>Beschreibung</b>	Pumpe Eingang ø 62mm Ausgang ø 51mm Typ ZF650DX 230/400V 50Hz Phasen 3 1,1kW L 333mm Laufrichtung links LGB		

<b>Ersatzteile zu</b> 499247			
	GEV-Nr.	510551	Vergl.-Nr. 0049R
Pumpendeckeldichtung ID ø 158,3mm			
	GEV-Nr.	510694	Vergl.-Nr. N/A
Gleitringdichtung für Wellen ø 13mm			
	GEV-Nr.	521095	Vergl.-Nr. 1360-1R
Laufrad ø 110mm H 39mm Gewinde M8R Welle ø 30mm			
	GEV-Nr.	521516	Vergl.-Nr. 0648R
Pumpendeckel LGB Eingang ø 62mm Ausgang ø 52mm			



<b>GEV-Nr.</b>	500122	<b>Vergl.-Nr.</b>	AM5225DX EPR0854
<b>Beschreibung</b>	Pumpe Eingang ø 62mm Ausgang ø 52mm Typ AM5225DX 230/400V 50Hz Phasen 3 1,2kW 1,6PS L 300mm Laufrichtung links LGB		

<b>Ersatzteile zu</b> 500122			
	GEV-Nr.	501495	Vergl.-Nr. 0189R
Abdeckung Kunststoff für Klemmdose für Pumpe LGB			

<b>Ersatzteile zu</b> 500122			
	GEV-Nr.	510551	Vergl.-Nr. 0049R
Pumpendeckeldichtung ID ø 158,3mm			
	GEV-Nr.	510694	Vergl.-Nr. N/A
Gleitringdichtung für Wellen ø 13mm			
	GEV-Nr.	521236	Vergl.-Nr. 0120D105
Laufrad ø 105mm H 32mm M8R			
	GEV-Nr.	521516	Vergl.-Nr. 0648R
Pumpendeckel LGB Eingang ø 62mm Ausgang ø 52mm			





<b>GEV-Nr.</b>	500536	<b>Vergl.-Nr.</b>	AM5225DX EPR1229
<b>Beschreibung</b>	Pumpe Eingang ø 62mm Ausgang ø 52mm Typ AM5225DX 230V 50Hz Phasen 1 0,9kW 1,2PS L 300mm Laufrichtung links Kondensator 20µF LGB		

<b>Ersatzteile zu</b> 500536			
	GEV-Nr.	365019	Vergl.-Nr. —
Betriebskondensator Kapazität 20µF 400V			
	GEV-Nr.	510551	Vergl.-Nr. 0049R
Pumpendeckeldichtung ID ø 158,3mm			
	GEV-Nr.	510694	Vergl.-Nr. N/A
Gleitringdichtung für Wellen ø 13mm			
	GEV-Nr.	521217	Vergl.-Nr. N/A
Laufrad ø 110mm H 32mm Gewinde M8R Welle ø 20mm			
	GEV-Nr.	521516	Vergl.-Nr. 0648R
Pumpendeckel LGB Eingang ø 62mm Ausgang ø 52mm			



<b>1</b>			
<b>GEV-Nr.</b>	501363	<b>Vergl.-Nr.</b>	AM5226DX EPR0444 EPR0444A
<b>Beschreibung</b>	Pumpe Eingang ø 62mm Ausgang ø 52mm Typ AM5226 230/400V 50Hz 0,65kW L 295mm Laufrichtung links LGB		
<b>Ersatzteile zu</b>	501363		
	GEV-Nr.	510551	Vergl.-Nr. 0049R
	Pumpendeckeldichtung ID ø 158,3mm		
	GEV-Nr.	510694	Vergl.-Nr. N/A
	Gleitringdichtung für Wellen ø 13mm		
	GEV-Nr.	521141	Vergl.-Nr. 0120-1R
	Laufrad ø 70mm H 32mm Gewinde M8R Welle ø 20mm		
	GEV-Nr.	521516	Vergl.-Nr. 0648R
	Pumpendeckel LGB Eingang ø 62mm Ausgang ø 52mm		



<b>1</b>			
<b>GEV-Nr.</b>	499299	<b>Vergl.-Nr.</b>	AM5226DX (DPE1906)
<b>Beschreibung</b>	Pumpe Eingang ø 62mm Ausgang ø 52mm Typ AM5226DX 220-240/380-415V 60Hz Phasen 3 0,55kW L 293mm Laufrichtung links LGB		
<b>Ersatzteile zu</b>	499299		
	GEV-Nr.	510551	Vergl.-Nr. 0049R
	Pumpendeckeldichtung ID ø 158,3mm		
	GEV-Nr.	510694	Vergl.-Nr. N/A
	Gleitringdichtung für Wellen ø 13mm		
	GEV-Nr.	521141	Vergl.-Nr. 0120-1R
	Laufrad ø 70mm H 32mm Gewinde M8R Welle ø 20mm		

<b>Ersatzteile zu</b> 499299			
	GEV-Nr.	521516	Vergl.-Nr. 0648R
	Pumpendeckel LGB Eingang ø 62mm Ausgang ø 52mm		



<b>1</b>			
<b>GEV-Nr.</b>	500537	<b>Vergl.-Nr.</b>	EPR1099 ZF522VDX
<b>Beschreibung</b>	Pumpe Eingang ø 62mm Ausgang ø 52mm Typ ZF522VDX 230V 50Hz Phasen 1 0,85kW 1,16PS L 255mm Laufrichtung links Kondensator 16µF Hilfsdruck 12mm Hilfsdruck offen LGB		
<b>Ersatzteile zu</b>	500537		
	GEV-Nr.	365021	Vergl.-Nr. —
	Betriebskondensator Kapazität 16µF 425V		
	GEV-Nr.	510551	Vergl.-Nr. 0049R
	Pumpendeckeldichtung ID ø 158,3mm		
	GEV-Nr.	510693	Vergl.-Nr. N/A
	Gleitringdichtung für Wellen ø 12mm		
	GEV-Nr.	521281	Vergl.-Nr. 0120D90
	Laufrad ø 90mm H 30mm Gewinde M8R Welle ø 20mm		
	GEV-Nr.	521516	Vergl.-Nr. 0648R
	Pumpendeckel LGB Eingang ø 62mm Ausgang ø 52mm		



1

<b>GEV-Nr.</b>	499242	<b>Vergl.-Nr.</b>	C.F.2561 ZF650DX
<b>Beschreibung</b>	Pumpe Eingang ø 62mm Ausgang ø 52mm Typ ZF650DX 230V 50Hz Phasen 1 1,47kW L 335mm Laufrichtung links Kondensator 20µF LGB		
<b>Ersatzteile zu</b>	499242		
	GEV-Nr.	365019	Vergl.-Nr. —
	Betriebskondensator Kapazität 20µF 400V		
	GEV-Nr.	510551	Vergl.-Nr. 0049R
	Pumpendeckeldichtung ID ø 158,3mm		
	GEV-Nr.	510694	Vergl.-Nr. N/A
	Gleitringdichtung für Wellen ø 13mm		
	GEV-Nr.	521217	Vergl.-Nr. N/A
	Laufrad ø 110mm H 32mm Gewinde M8R Welle ø 20mm		
	GEV-Nr.	521516	Vergl.-Nr. 0648R
	Pumpendeckel LGB Eingang ø 62mm Ausgang ø 52mm		



1

<b>GEV-Nr.</b>	500780	<b>Vergl.-Nr.</b>	EPR1611 ZF800DX
<b>Beschreibung</b>	Pumpe Eingang ø 62mm Ausgang ø 52mm Typ ZF800DX 230/400V 50Hz Phasen 3 1,5kW 2PS L 340mm Laufrichtung links LGB		
<b>Ersatzteile zu</b>	500780		
	GEV-Nr.	510551	Vergl.-Nr. 0049R
	Pumpendeckeldichtung ID ø 158,3mm		
	GEV-Nr.	510694	Vergl.-Nr. N/A
	Gleitringdichtung für Wellen ø 13mm		

<b>Ersatzteile zu</b>	500780		
	GEV-Nr.	521276	Vergl.-Nr. 1360-1R
	Laufrad ø 120mm H 39mm Pumpentyp ZF800DX		
	GEV-Nr.	521516	Vergl.-Nr. 0648R
	Pumpendeckel LGB Eingang ø 62mm Ausgang ø 52mm		



1

<b>GEV-Nr.</b>	499141	<b>Vergl.-Nr.</b>	EPR1874 ZF800DX
<b>Beschreibung</b>	Pumpe Eingang ø 62mm Ausgang ø 52mm Typ ZF800DX 230/400V 50Hz Phasen 3 1,65kW 2,2PS L 336mm Laufrichtung links Hilfsdruck 12mm Hilfsdruck geschlossen LGB		
<b>Ersatzteile zu</b>	499141		
	GEV-Nr.	510551	Vergl.-Nr. 0049R
	Pumpendeckeldichtung ID ø 158,3mm		
	GEV-Nr.	510694	Vergl.-Nr. N/A
	Gleitringdichtung für Wellen ø 13mm		
	GEV-Nr.	521276	Vergl.-Nr. 1360-1R
	Laufrad ø 120mm H 39mm Pumpentyp ZF800DX		
	GEV-Nr.	521516	Vergl.-Nr. 0648R
	Pumpendeckel LGB Eingang ø 62mm Ausgang ø 52mm		



1			
<b>GEV-Nr.</b>	499287	<b>Vergl.-Nr.</b>	ZF800DX (TR0080)
<b>Beschreibung</b>	Pumpe Eingang ø 62mm Ausgang ø 52mm Typ ZF800DX 230/400V 50Hz Phasen 3 2,7kW L 332mm Laufrichtung links LGB		
<b>Ersatzteile zu</b>	499287		
	<b>GEV-Nr.</b>	510551	<b>Vergl.-Nr.</b> 0049R
	Pumpendeckeldichtung ID ø 158,3mm		
	<b>GEV-Nr.</b>	510694	<b>Vergl.-Nr.</b> N/A
	Gleitringdichtung für Wellen ø 13mm		
	<b>GEV-Nr.</b>	521276	<b>Vergl.-Nr.</b> 1360-1R
	Laufrad ø 120mm H 39mm Pumpentyp ZF800DX		
	<b>GEV-Nr.</b>	521516	<b>Vergl.-Nr.</b> 0648R
	Pumpendeckel LGB Eingang ø 62mm Ausgang ø 52mm		





1			
<b>GEV-Nr.</b>	500733	<b>Vergl.-Nr.</b>	AM5225SX EPR2495
<b>Beschreibung</b>	Pumpe Eingang ø 63mm Ausgang ø 48mm Typ AM5225SX 230/400V 50Hz Phasen 3 0,9kW 1,2PS L 300mm Laufrichtung rechts LGB		





1			
<b>GEV-Nr.</b>	500779	<b>Vergl.-Nr.</b>	EPR1489 ZF523VSX
<b>Beschreibung</b>	Pumpe Eingang ø 63mm Ausgang ø 48mm Typ ZF523VSX 230/400V 50Hz Phasen 3 1kW 1,36PS L 280mm Laufrichtung rechts LGB		
<b>Ersatzteile zu</b>	500779		
	<b>GEV-Nr.</b>	510551	<b>Vergl.-Nr.</b> 0049R
	Pumpendeckeldichtung ID ø 158,3mm		
	<b>GEV-Nr.</b>	510693	<b>Vergl.-Nr.</b> N/A
	Gleitringdichtung für Wellen ø 12mm		
	<b>GEV-Nr.</b>	521097	<b>Vergl.-Nr.</b> 1388-1R
	Laufrad ø 100mm H 31mm Gewinde M8L Welle ø 20mm		
	<b>GEV-Nr.</b>	521536	<b>Vergl.-Nr.</b> 0022R
	Pumpendeckel ALBA / LGB Eingang ø 62mm		



1			
<b>GEV-Nr.</b>	500469	<b>Vergl.-Nr.</b>	EPR1806 ZF650SX
<b>Beschreibung</b>	Pumpe Eingang ø 63mm Ausgang ø 48mm Typ ZF650SX 230/400V 50Hz Phasen 3 1,35kW 1,83PS L 335mm Laufrichtung rechts LGB		
<b>Ersatzteile zu</b>	500469		
	<b>GEV-Nr.</b>	510551	<b>Vergl.-Nr.</b> 0049R
	Pumpendeckeldichtung ID ø 158,3mm		
	<b>GEV-Nr.</b>	510694	<b>Vergl.-Nr.</b> N/A
	Gleitringdichtung für Wellen ø 13mm		

Tabellenfortsetzung auf der nächsten Seite

<b>Ersatzteile zu</b> 500469			
	<b>GEV-Nr.</b>	521240	<b>Vergl.-Nr.</b> 2500R
Laufrad ø 110mm H 32mm Laufrichtung links			
	<b>GEV-Nr.</b>	521536	<b>Vergl.-Nr.</b> 0022R
Pumpendeckel ALBA / LGB Eingang ø 62mm			



**GEV**

Bild nicht  
vorhanden

1

<b>GEV-Nr.</b>	500960	<b>Vergl.-Nr.</b>	EPR2042 ZF650SX
<b>Beschreibung</b>	Pumpe Eingang ø 63mm Ausgang ø 48mm Typ ZF650SX 230V 50Hz Phasen 1 1,47kW 2PS L 340mm Laufrichtung rechts Kondensator 20µF LGB Eingang ø 63mm Ausgang ø 48mm		



<b>GEV-Nr.</b>	499271	<b>Vergl.-Nr.</b>	ZF650SX (ATA 8214)
<b>Beschreibung</b>	Pumpe Eingang ø 63mm Ausgang ø 61mm Typ ZF650SX 230/400V 50Hz Phasen 3 0,95kW L 340mm Laufrichtung rechts LGB		



<b>GEV-Nr.</b>	499083	<b>Vergl.-Nr.</b>	EPR1829 ZF650SX (ATA 9821)
<b>Beschreibung</b>	Pumpe Eingang ø 63mm Ausgang ø 63mm Typ ZF650SX 230/400V 50Hz Phasen 3 1,5kW L 335mm		
<b>Ersatzteile zu</b> 499083			
	<b>GEV-Nr.</b>	510551	<b>Vergl.-Nr.</b> 0049R
Pumpendeckeldichtung ID ø 158,3mm			
	<b>GEV-Nr.</b>	510694	<b>Vergl.-Nr.</b> N/A
Gleitringdichtung für Wellen ø 13mm			
<b>Bild nicht vorhanden</b>	<b>GEV-Nr.</b>	521069	<b>Vergl.-Nr.</b> 0180R
Lüfterradabdeckung			
	<b>GEV-Nr.</b>	521240	<b>Vergl.-Nr.</b> 2500R
Laufrad ø 110mm H 32mm Laufrichtung links			
	<b>GEV-Nr.</b>	521537	<b>Vergl.-Nr.</b> N/A
Pumpendeckel Eingang ø 62mm Ausgang ø 62mm			





1

<b>GEV-Nr.</b>	499101	<b>Vergl.-Nr.</b>	C600/PS60 2248 C600/PS60 79056
<b>Beschreibung</b>	Pumpe Eingang $\varnothing$ Ausgang $\varnothing$ 38mm Typ C600 230V 50Hz Phasen 1 0,8kW L 220mm Laufrichtung rechts Kondensator 16 $\mu$ F LGB mit Ablauf und Flansch		
<b>Ersatzteile zu</b>	499101		
	<b>GEV-Nr.</b>	365021	<b>Vergl.-Nr.</b> —
	Betriebskondensator Kapazität 16 $\mu$ F 425V		
	<b>GEV-Nr.</b>	502280	<b>Vergl.-Nr.</b> N/A
	Pumpensumpf LGB Hilfsdruck 7mm		
	<b>GEV-Nr.</b>	510703	<b>Vergl.-Nr.</b> 1001R 1058R N/A
	Gleitringdichtung für Wellen $\varnothing$ 13mm		
	<b>GEV-Nr.</b>	521234	<b>Vergl.-Nr.</b> N/A
	Lauf rad Gewinde M8L AD $\varnothing$ 93mm B 16mm		
	<b>GEV-Nr.</b>	523509	<b>Vergl.-Nr.</b> —
	Rillenkugellager Welle $\varnothing$ 12mm AD $\varnothing$ 32mm B 10mm		
	<b>GEV-Nr.</b>	532537	<b>Vergl.-Nr.</b> N/A
	O-Ring EPDM Materialstärke 3,53mm ID $\varnothing$ 113,9mm		



1

<b>GEV-Nr.</b>	499119	<b>Vergl.-Nr.</b>	1751
<b>Beschreibung</b>	Pumpe Eingang $\varnothing$ Ausgang $\varnothing$ 38mm Typ RV54 230V 50Hz Phasen 1 0,8kW L 380mm Laufrichtung rechts Kondensator 16 $\mu$ F LGB mit Halterung		
<b>Ersatzteile zu</b>	499119		
	<b>GEV-Nr.</b>	365021	<b>Vergl.-Nr.</b> —
	Betriebskondensator Kapazität 16 $\mu$ F 425V		
	<b>GEV-Nr.</b>	502280	<b>Vergl.-Nr.</b> N/A
	Pumpensumpf LGB Hilfsdruck 7mm		
	<b>GEV-Nr.</b>	510703	<b>Vergl.-Nr.</b> 1001R 1058R N/A
	Gleitringdichtung für Wellen $\varnothing$ 13mm		
	<b>GEV-Nr.</b>	521234	<b>Vergl.-Nr.</b> N/A
	Lauf rad Gewinde M8L AD $\varnothing$ 93mm B 16mm		
	<b>GEV-Nr.</b>	523509	<b>Vergl.-Nr.</b> —
	Rillenkugellager Welle $\varnothing$ 12mm AD $\varnothing$ 32mm B 10mm		
	<b>GEV-Nr.</b>	532537	<b>Vergl.-Nr.</b> N/A
	O-Ring EPDM Materialstärke 3,53mm ID $\varnothing$ 113,9mm		



1

<b>GEV-Nr.</b>	500153	<b>Vergl.-Nr.</b>	W180SX
<b>Beschreibung</b>	Pumpe Eingang ø Ausgang ø Typ W180SX 230V 50Hz Phasen 1 0,19kW 0,26PS L 220mm Laufrichtung rechts Kondensator 5µF LGB		
<b>Ersatzteile zu</b>	500153		
	<b>GEV-Nr.</b>	365017	<b>Vergl.-Nr.</b> —
	Betriebskondensator Kapazität 5µF 450V		
	<b>GEV-Nr.</b>	510703	<b>Vergl.-Nr.</b> 1001R 1058R N/A
	Gleitringdichtung für Wellen ø 13mm		
	<b>GEV-Nr.</b>	513267	<b>Vergl.-Nr.</b> —
	Endkappe für Waschpumpe passend für Pumpengehäuse		
	<b>GEV-Nr.</b>	518177	<b>Vergl.-Nr.</b> N/A
	Ablaufeinheit Gewinde 3/4" ID ø 35mm		
	<b>GEV-Nr.</b>	518204	<b>Vergl.-Nr.</b> —
	Verschraubung für Filter ø 67mm		
	<b>GEV-Nr.</b>	518205	<b>Vergl.-Nr.</b> —
	Flachdichtung Gummi D1 ø 61mm D2 ø 47mm		
	<b>GEV-Nr.</b>	521147	<b>Vergl.-Nr.</b> —
	Flansch		
	<b>GEV-Nr.</b>	521221	<b>Vergl.-Nr.</b> N/A
	Laufrad ø 67mm H 16mm Laufrichtung rechts		
	<b>GEV-Nr.</b>	528800	<b>Vergl.-Nr.</b> 0042R
	O-Ring EPDM Materialstärke 2,62mm ID ø 75,87mm		



1

<b>GEV-Nr.</b>	500150	<b>Vergl.-Nr.</b>	EPR130980 W210SX
<b>Beschreibung</b>	Pumpe Eingang ø Ausgang ø Typ W210SX 230V 50Hz Phasen 1 0,24kW 0,33PS L 230mm Laufrichtung rechts Kondensator 6,3µF LGB		
<b>Ersatzteile zu</b>	500150		
	<b>GEV-Nr.</b>	365012	<b>Vergl.-Nr.</b> —
	Betriebskondensator Kapazität 6,3µF 450V		
	<b>GEV-Nr.</b>	509004	<b>Vergl.-Nr.</b> 0951R
	Laufrad ø 71mm H 16mm M7L Laufrichtung rechts		
	<b>GEV-Nr.</b>	510703	<b>Vergl.-Nr.</b> 1001R 1058R N/A
	Gleitringdichtung für Wellen ø 13mm		
	<b>GEV-Nr.</b>	513267	<b>Vergl.-Nr.</b> —
	Endkappe für Waschpumpe passend für Pumpengehäuse		
	<b>GEV-Nr.</b>	513275	<b>Vergl.-Nr.</b> N/A
	O-Ring EPDM Materialstärke 1,78mm ID ø 82,27mm		
	<b>GEV-Nr.</b>	518177	<b>Vergl.-Nr.</b> N/A
	Ablaufeinheit Gewinde 3/4" ID ø 35mm		
	<b>GEV-Nr.</b>	518204	<b>Vergl.-Nr.</b> —
	Verschraubung für Filter ø 67mm		
	<b>GEV-Nr.</b>	518205	<b>Vergl.-Nr.</b> —
	Flachdichtung Gummi D1 ø 61mm D2 ø 47mm		
	<b>GEV-Nr.</b>	521147	<b>Vergl.-Nr.</b> —
	Flansch		



1			
<b>GEV-Nr.</b>	500390	<b>Vergl.-Nr.</b>	ELET.FM4023SX FM4022SX
<b>Beschreibung</b>	Pumpe Typ FM4022SX 230V 50Hz Phasen 1 0,5kW 0,86PS Laufrichtung rechts Kondensator 16µF LGB		
<b>Ersatzteile zu</b>	500390		
	<b>GEV-Nr.</b>	365021	<b>Vergl.-Nr.</b> —
	Betriebskondensator Kapazität 16µF 425V		
	<b>GEV-Nr.</b>	510703	<b>Vergl.-Nr.</b> 1001R 1058R N/A
	Gleitringdichtung für Wellen ø 13mm		
	<b>GEV-Nr.</b>	521246	<b>Vergl.-Nr.</b> 0591-1R
	Laufrad ø 103mm H 26mm Gewinde M8L Welle ø 20mm		
	<b>GEV-Nr.</b>	521542	<b>Vergl.-Nr.</b> 0878R
	Pumpendeckel LGB Eingang ø 45mm Ausgang ø 40mm		
	<b>GEV-Nr.</b>	521714	<b>Vergl.-Nr.</b> 0046R 3283R
	Pumpendeckeldichtung Materialstärke 4x4mm		

**Ersatzteile und Zubehör**
**Gleitringdichtungen**

1			
<b>GEV-Nr.</b>	521055	<b>Vergl.-Nr.</b>	1159R
<b>Beschreibung</b>	Gleitring mit Dichtung ID ø 21mm Höhe Gegenring 8mm Einbau ø 42mm		

1			
<b>GEV-Nr.</b>	510692	<b>Vergl.-Nr.</b>	N/A
<b>Beschreibung</b>	Gleitringdichtung für Wellen ø 11mm Gleitring AD ø 24mm Gleitring H 13mm Gegenring Einbau ø 26mm Höhe Gegenring 8mm Gegenring Innen-ø 14mm Edelstahl/Keramik/EPDM		

1			
<b>GEV-Nr.</b>	510693	<b>Vergl.-Nr.</b>	N/A
<b>Beschreibung</b>	Gleitringdichtung für Wellen ø 12mm Gleitring AD ø 24mm Gleitring H 15,5mm Gleitring Innen-ø 11mm Gegenring Einbau ø 24mm Höhe Gegenring 8mm Gegenring Innen-ø 14mm Edelstahl/Keramik/EPDM		

1			
<b>GEV-Nr.</b>	510703	<b>Vergl.-Nr.</b>	1001R 1058R N/A
<b>Beschreibung</b>	Gleitringdichtung für Wellen ø 13mm Gleitring H 13mm Höhe Gegenring 5,5mm Edelstahl/Keramik/EPDM AD ø 26mm		

1			
<b>GEV-Nr.</b>	510694	<b>Vergl.-Nr.</b>	N/A
<b>Beschreibung</b>	Gleitringdichtung für Wellen ø 13mm Höhe Gegenring 8mm Edelstahl/Keramik/EPDM ID ø 11,5mm H 16mm Einbau ø 24/26mm Innen-ø 14mm		



1

<b>GEV-Nr.</b>	510690	<b>Vergl.-Nr.</b>	N/A
<b>Beschreibung</b>	Gleitringdichtung für Wellen ø 8mm Edelstahl/Keramik/EPDM AD ø 24mm Einbau ø 24/26mm		



1

<b>GEV-Nr.</b>	510702	<b>Vergl.-Nr.</b>	N/A
<b>Beschreibung</b>	Gleitringdichtung Höhe Gegenring 5,5mm Edelstahl/Keramik/EPDM ID ø 12mm		



1

<b>GEV-Nr.</b>	521056	<b>Vergl.-Nr.</b>	1160R
<b>Beschreibung</b>	Laufring für Wellen ø 20mm AD ø 39mm H 16mm ID ø 18,5mm		

**Laufräder**



1

<b>GEV-Nr.</b>	521234	<b>Vergl.-Nr.</b>	N/A
<b>Beschreibung</b>	Laufrad Gewinde M8L AD ø 93mm B 16mm		



1

<b>GEV-Nr.</b>	502279	<b>Vergl.-Nr.</b>	2038R
<b>Beschreibung</b>	Laufrad H 31mm AD ø 100mm Schaufeln 6		



1

<b>GEV-Nr.</b>	521097	<b>Vergl.-Nr.</b>	1388-1R
<b>Beschreibung</b>	Laufrad ø 100mm H 31mm Gewinde M8L Welle ø 20mm Wellenlänge 14mm		



1

<b>GEV-Nr.</b>	521087	<b>Vergl.-Nr.</b>	2038-1R
<b>Beschreibung</b>	Laufrad ø 100mm H 32mm Gewinde M8L		



1

<b>GEV-Nr.</b>	521090	<b>Vergl.-Nr.</b>	Girante per Pompa ZF400SX EPR2287
<b>Beschreibung</b>	Laufrad ø 101mm H 32mm Gewinde M8L Welle ø 13mm Wellenlänge 12mm		



1

<b>GEV-Nr.</b>	521042	<b>Vergl.-Nr.</b>	0116R Girante Pompa EPR0524(ZF210SX)
<b>Beschreibung</b>	Lauftrad ø 103mm H 14mm Pumpentyp ZF210SX Gewinde M10L		



1

<b>GEV-Nr.</b>	509020	<b>Vergl.-Nr.</b>	1834R
<b>Beschreibung</b>	Lauftrad ø 104mm H 25mm M8L		



1

<b>GEV-Nr.</b>	512029	<b>Vergl.-Nr.</b>	1339D103
<b>Beschreibung</b>	Lauftrad ø 103mm H 26mm Gewinde M8L Welle ø 19mm Wellenlänge 15mm Aufnahme ø 8,2mm		



1

<b>GEV-Nr.</b>	521111	<b>Vergl.-Nr.</b>	1574-1R
<b>Beschreibung</b>	Lauftrad ø 105mm H 29mm Gewinde M8R Welle ø 20mm Wellenlänge 5mm		



1

<b>GEV-Nr.</b>	521246	<b>Vergl.-Nr.</b>	0591-1R
<b>Beschreibung</b>	Lauftrad ø 103mm H 26mm Gewinde M8L Welle ø 20mm Wellenlänge 7mm Aufnahme ø 8,2mm Schaufeln 6		



1

<b>GEV-Nr.</b>	521236	<b>Vergl.-Nr.</b>	0120D105
<b>Beschreibung</b>	Lauftrad ø 105mm H 32mm M8R		



1

<b>GEV-Nr.</b>	510616	<b>Vergl.-Nr.</b>	0123R
<b>Beschreibung</b>	Lauftrad ø 104mm H 25mm Achsaufnahme ø 10mm		



1

<b>GEV-Nr.</b>	521094	<b>Vergl.-Nr.</b>	2853R
<b>Beschreibung</b>	Lauftrad ø 105mm H 34mm Gewinde M8L Welle ø 27mm Wellenlänge 7mm		



1

<b>GEV-Nr.</b>	521280	<b>Vergl.-Nr.</b>	1339-1R
<b>Beschreibung</b>	Laufrad ø 107mm H 26mm Gewinde M8L Welle ø 20mm Wellenlänge 15mm Aufnahme ø 8,2mm Schaufeln 6		



1

<b>GEV-Nr.</b>	521242	<b>Vergl.-Nr.</b>	2853R
<b>Beschreibung</b>	Laufrad ø 115mm H 36mm M8L Achsaufnahme ø 12mm Laufrichtung rechts Schaufeln 6		



1

<b>GEV-Nr.</b>	521239	<b>Vergl.-Nr.</b>	2510R
<b>Beschreibung</b>	Laufrad ø 110mm H 26mm Laufrichtung rechts Gewinde M8L Welle ø 19,5mm Wellenlänge 17mm Aufnahme ø 8,2mm Schaufeln 6		



1

<b>GEV-Nr.</b>	521059	<b>Vergl.-Nr.</b>	2854R
<b>Beschreibung</b>	Laufrad ø 120mm H 39mm Laufrichtung links Gewinde M8R passend für LGB ZF900DX Aufnahme ø 12mm		



1

<b>GEV-Nr.</b>	521217	<b>Vergl.-Nr.</b>	N/A
<b>Beschreibung</b>	Laufrad ø 110mm H 32mm Gewinde M8R Welle ø 20mm Wellenlänge 10mm Aufnahme ø 8,2mm Schaufeln 6 für ZF522DX		



1

<b>GEV-Nr.</b>	521276	<b>Vergl.-Nr.</b>	1360-1R
<b>Beschreibung</b>	Laufrad ø 120mm H 39mm Pumpentyp ZF800DX Achsaufnahme ø 12mm Laufrichtung links Gewinde M8R Pumpe für Serie ZF800DX Schaufeln 6		



1

<b>GEV-Nr.</b>	521095	<b>Vergl.-Nr.</b>	1360-1R
<b>Beschreibung</b>	Laufrad ø 110mm H 39mm Gewinde M8R Welle ø 30mm		



1

<b>GEV-Nr.</b>	521054	<b>Vergl.-Nr.</b>	1161-1R
<b>Beschreibung</b>	Laufrad ø 135mm H 37mm Achsaufnahme ø 18mm Laufrichtung rechts Gewinde M14x2L Schaufeln 6		



1

<b>GEV-Nr.</b>	521114	<b>Vergl.-Nr.</b>	Girante per Pompa ZF119SX C.F.2126
<b>Beschreibung</b>	Laufgrad ø 48mm H 17mm Pumpentyp ZF119SX Welle ø 13mm Wellenlänge 12mm		



1

<b>GEV-Nr.</b>	698663	<b>Vergl.-Nr.</b>	0965R
<b>Beschreibung</b>	Laufgrad ø 60mm H 12mm mit Nut Achsaufnahme ø 12mm B 60mm passend für LGB		



1

<b>GEV-Nr.</b>	530455	<b>Vergl.-Nr.</b>	0101-1R
<b>Beschreibung</b>	Laufgrad ø 60mm H 30mm Schraubbefestigung Achsaufnahme ø M5mm Laufrichtung links passend für LGB für Serie ZF115M7 DX Welle ø M5mm Wellenlänge 26mm Schaufeln 3		
<b>Zubehör zu</b>	530455		
	<b>GEV-Nr.</b>	<b>Vergl.-Nr.</b>	EPR0459 ZF-130DX
Pumpe Eingang ø 28mm Ausgang ø 26mm Typ ZF130DX			



1

<b>GEV-Nr.</b>	521223	<b>Vergl.-Nr.</b>	1517R
<b>Beschreibung</b>	Laufgrad ø 61mm H 17mm Gewinde M7L Welle ø 13mm Wellenlänge 12mm		



1

<b>GEV-Nr.</b>	521221	<b>Vergl.-Nr.</b>	N/A
<b>Beschreibung</b>	Laufgrad ø 67mm H 16mm Laufrichtung rechts Gewinde M7L Welle ø 13mm Wellenlänge 12mm Schaufeln 8		



1

<b>GEV-Nr.</b>	698765	<b>Vergl.-Nr.</b>	N/A
<b>Beschreibung</b>	Laufgrad ø 70mm H 21mm Laufrichtung rechts Gewinde M7L passend für LGB Welle ø 13mm Wellenlänge 20mm Schaufeln 4		



1

<b>GEV-Nr.</b>	521141	<b>Vergl.-Nr.</b>	0120-1R
<b>Beschreibung</b>	Laufgrad ø 70mm H 32mm Gewinde M8R Welle ø 20mm Wellenlänge 9mm		



1

<b>GEV-Nr.</b>	509004	<b>Vergl.-Nr.</b>	0951R
<b>Beschreibung</b>	Laufgrad ø 71mm H 16mm M7L Laufrichtung rechts Welle ø 13mm Wellenlänge 13mm Schaufeln 8		



1

<b>GEV-Nr.</b>	521085	<b>Vergl.-Nr.</b>	0106-1R
<b>Beschreibung</b>	Laufrad ø 72mm H 17mm Gewinde M7L Welle ø 13mm Wellenlänge 12mm Schaufeln 3		



1

<b>GEV-Nr.</b>	521225	<b>Vergl.-Nr.</b>	0110-1R
<b>Beschreibung</b>	Laufrad ø 72mm H 22mm Laufrichtung rechts Gewinde M7L Welle ø 13mm Wellenlänge 12mm		



1

<b>GEV-Nr.</b>	521099	<b>Vergl.-Nr.</b>	1580-1R
<b>Beschreibung</b>	Laufrad ø 72mm H 17mm Gewinde M7R Welle ø 13mm Wellenlänge 12mm		



1

<b>GEV-Nr.</b>	521083	<b>Vergl.-Nr.</b>	0815R
<b>Beschreibung</b>	Laufrad ø 73mm H 13mm Gewinde M7R Schaufeln 3 Metall		



1

<b>GEV-Nr.</b>	521228	<b>Vergl.-Nr.</b>	0105-1R
<b>Beschreibung</b>	Laufrad ø 72mm H 17mm Laufrichtung links Gewinde M7R Welle ø 13mm Wellenlänge 12mm Schaufeln 3		



1

<b>GEV-Nr.</b>	521092	<b>Vergl.-Nr.</b>	2574R Girante per Pompa CRC-R DX EPR2570A
<b>Beschreibung</b>	Laufrad ø 80mm H 25mm Pumpentyp CRC-R DX Gewinde M6R Welle ø 13mm Wellenlänge 20mm		



1

<b>GEV-Nr.</b>	521008	<b>Vergl.-Nr.</b>	0109-1R
<b>Beschreibung</b>	Laufrad ø 72mm H 22mm Laufrichtung links Gewinde M7R Welle ø 13mm Wellenlänge 12mm		



1

<b>GEV-Nr.</b>	521150	<b>Vergl.-Nr.</b>	N/A
<b>Beschreibung</b>	Laufrad ø 85mm H 17mm Gewinde M8R Welle ø 13mm Wellenlänge 10mm		





1

<b>GEV-Nr.</b>	521093	<b>Vergl.-Nr.</b>	Girante per Pompa ZF523 VSX 60Hz
<b>Beschreibung</b>	Lauftrad ø 85mm H 29mm Gewinde M8L Welle ø 20mm Wellenlänge 10mm		



1

<b>GEV-Nr.</b>	521089	<b>Vergl.-Nr.</b>	2037R
<b>Beschreibung</b>	Lauftrad ø 88mm H 32mm Gewinde M8L		



1

<b>GEV-Nr.</b>	521230	<b>Vergl.-Nr.</b>	N/A
<b>Beschreibung</b>	Lauftrad ø 86mm H 16mm M7L		



1

<b>GEV-Nr.</b>	521247	<b>Vergl.-Nr.</b>	N/A
<b>Beschreibung</b>	Lauftrad ø 90mm H 27mm Laufrichtung rechts Gewinde M8L Schaufeln 6		



**GEV**  
Bild nicht vorhanden

1

<b>GEV-Nr.</b>	521040	<b>Vergl.-Nr.</b>	1857
<b>Beschreibung</b>	Lauftrad ø 88mm H 16mm Pumpentyp ZF220SX Laufrichtung rechts Gewinde M8L		



1

<b>GEV-Nr.</b>	521281	<b>Vergl.-Nr.</b>	0120D90
<b>Beschreibung</b>	Lauftrad ø 90mm H 30mm Gewinde M8R Welle ø 20mm Wellenlänge 10mm Aufnahme ø 8,2mm Schaufeln 6		



1

<b>GEV-Nr.</b>	521024	<b>Vergl.-Nr.</b>	N/A
<b>Beschreibung</b>	Lauftrad ø 88mm H 30mm Laufrichtung rechts Gewinde M7L Welle ø 12mm Schaufeln 6		



1

<b>GEV-Nr.</b>	521112	<b>Vergl.-Nr.</b>	N/A
<b>Beschreibung</b>	Lauftrad ø 93mm H 21mm Pumpentyp ZF220VSX Gewinde M8L Welle ø 13mm Wellenlänge 11mm		



1

<b>GEV-Nr.</b>	521278	<b>Vergl.-Nr.</b>	2037R
<b>Beschreibung</b>	Laufrad ø 93mm H 32mm Pumpentyp ZF350SX Gewinde M8L		



1

<b>GEV-Nr.</b>	521300	<b>Vergl.-Nr.</b>	0697-1R
<b>Beschreibung</b>	Laufrad ø 94mm H 27mm Pumpentyp ZF320SX Gewinde M8L		



1

<b>GEV-Nr.</b>	521106	<b>Vergl.-Nr.</b>	0114-1R
<b>Beschreibung</b>	Laufrad ø 97mm H 24mm Laufrichtung rechts Gewinde M8L Aufnahme ø 8,2mm Schaufeln 5		

Pumpendeckel



1

<b>GEV-Nr.</b>	518177	<b>Vergl.-Nr.</b>	N/A
<b>Beschreibung</b>	Ablaufeinheit Gewinde 3/4" ID ø 35mm Schlauch ø 24mm		



1

<b>GEV-Nr.</b>	698827	<b>Vergl.-Nr.</b>	N/A
<b>Beschreibung</b>	Gewinding LGB Pumpentyp LA50 ø 120mm ID ø 70mm		



1

<b>GEV-Nr.</b>	502267	<b>Vergl.-Nr.</b>	0935-1R
<b>Beschreibung</b>	Pumpendeckel		



1

<b>GEV-Nr.</b>	521564	<b>Vergl.-Nr.</b>	N/A
<b>Beschreibung</b>	Pumpendeckel		



1

<b>GEV-Nr.</b>	521536	<b>Vergl.-Nr.</b>	0022R
<b>Beschreibung</b>	Pumpendeckel ALBA / LGB Eingang ø 62mm Ausgang ø 50mm Hilfsdruck 12mm Hilfsdruck geschlossen Drehrichtung rechts ø 180mm ID ø 150mm Innenhöhe 38mm		



1

<b>GEV-Nr.</b>	502266	<b>Vergl.-Nr.</b>	0881R
<b>Beschreibung</b>	Pumpendeckel Eingang ø 28mm Ausgang ø 26mm		



1

<b>GEV-Nr.</b>	521119	<b>Vergl.-Nr.</b>	2135R
<b>Beschreibung</b>	Pumpendeckel LGB Eingang ø 28mm Ausgang ø 12mm Hilfsdruck 12mm Pumpentyp ZF131DX		

1



**GEV**  
Bild nicht vorhanden

<b>GEV-Nr.</b>	521037	<b>Vergl.-Nr.</b>	0246
<b>Beschreibung</b>	Pumpendeckel Eingang ø 45mm Ausgang ø 40mm Pumpentyp ZF220SX		



1

<b>GEV-Nr.</b>	698770	<b>Vergl.-Nr.</b>	N/A
<b>Beschreibung</b>	Pumpendeckel LGB Eingang ø 28mm Ausgang ø 22/28mm ø 108mm ID ø 84mm		



1

<b>GEV-Nr.</b>	521537	<b>Vergl.-Nr.</b>	N/A
<b>Beschreibung</b>	Pumpendeckel Eingang ø 62mm Ausgang ø 62mm Hilfsdruck 12mm Hilfsdruck geschlossen Drehrichtung rechts ø 180mm ID ø 150mm Innenhöhe 38mm		



1

<b>GEV-Nr.</b>	521084	<b>Vergl.-Nr.</b>	1263R
<b>Beschreibung</b>	Pumpendeckel LGB Eingang ø 28mm Ausgang ø 25mm Hilfsdruck 13mm Pumpentyp ZF131DX ID ø 78mm		



1

<b>GEV-Nr.</b>	521149	<b>Vergl.-Nr.</b>	N/A
<b>Beschreibung</b>	Pumpendeckel LGB Ausgang ø 38/31mm		



1

<b>GEV-Nr.</b>	521007	<b>Vergl.-Nr.</b>	1774R
<b>Beschreibung</b>	Pumpendeckel LGB Eingang ø 28mm Ausgang ø 26mm Drehrichtung links		



1

<b>GEV-Nr.</b>	521057	<b>Vergl.-Nr.</b>	1650R
<b>Beschreibung</b>	Pumpendeckel LGB Eingang ø 28mm Ausgang ø 26mm Hilfsdruck 12mm Hilfsdruck offen Drehrichtung rechts ø 102mm ID ø 77mm Innenhöhe 31mm		



1

<b>GEV-Nr.</b>	510122	<b>Vergl.-Nr.</b>	0002R
<b>Beschreibung</b>	Pumpendeckel LGB Eingang ø 28mm Ausgang ø 26mm Hilfsdruck 13mm Hilfsdruck offen ø 98mm ID ø 77mm Innenhöhe 31mm		



1

<b>GEV-Nr.</b>	521098	<b>Vergl.-Nr.</b>	1649R
<b>Beschreibung</b>	Pumpendeckel LGB Eingang ø 28mm Ausgang ø 26mm Hilfsdruck 12mm ID ø 77mm		



1

<b>GEV-Nr.</b>	521091	<b>Vergl.-Nr.</b>	2576R
<b>Beschreibung</b>	Pumpendeckel LGB Eingang ø 28mm Ausgang ø 26mm Pumpentyp CRC-R DX		



1

<b>GEV-Nr.</b>	521107	<b>Vergl.-Nr.</b>	0001R
<b>Beschreibung</b>	Pumpendeckel LGB Eingang ø 28mm Ausgang ø 26mm Hilfsdruck 12mm ID ø 77mm		



1

<b>GEV-Nr.</b>	521527	<b>Vergl.-Nr.</b>	0645R
<b>Beschreibung</b>	Pumpendeckel LGB Eingang ø 30mm Ausgang ø 30mm		



1

<b>GEV-Nr.</b>	521524	<b>Vergl.-Nr.</b>	0882R
<b>Beschreibung</b>	Pumpendeckel LGB Eingang ø 28mm Ausgang ø 26mm Hilfsdruck 13mm Drehrichtung links ø 98mm ID ø 78mm Innenhöhe 25mm		



1

<b>GEV-Nr.</b>	521526	<b>Vergl.-Nr.</b>	0009R 3286R
<b>Beschreibung</b>	Pumpendeckel LGB Eingang ø 30mm Ausgang ø 30mm Hilfsdruck 12mm Hilfsdruck offen Drehrichtung rechts ø 117mm ID ø 95mm Innenhöhe 19mm		



1

<b>GEV-Nr.</b>	521088	<b>Vergl.-Nr.</b>	N/A
<b>Beschreibung</b>	Pumpendeckel LGB Eingang ø 33mm Ausgang ø 26mm		



1

<b>GEV-Nr.</b>	698768	<b>Vergl.-Nr.</b>	N/A
<b>Beschreibung</b>	Pumpendeckel LGB Eingang ø 42mm Pumpentyp LA50 AP ø 115mm ID ø 36mm		



1

<b>GEV-Nr.</b>	521109	<b>Vergl.-Nr.</b>	1572R
<b>Beschreibung</b>	Pumpendeckel LGB Eingang ø 45mm Ausgang ø 40mm Hilfsdruck 12		



1

<b>GEV-Nr.</b>	521140	<b>Vergl.-Nr.</b>	Chiocciola per Pompa EPR2660/ ZF150SX
<b>Beschreibung</b>	Pumpendeckel LGB Eingang ø 45mm Ausgang ø 40mm Hilfsdruck 12mm Pumpentyp ZF150SX		



1

<b>GEV-Nr.</b>	521542	<b>Vergl.-Nr.</b>	0878R
<b>Beschreibung</b>	Pumpendeckel LGB Eingang ø 45mm Ausgang ø 40mm Hilfsdruck 13mm Hilfsdruck offen ø 150mm ID ø 120mm Innenhöhe 25mm		



1

<b>GEV-Nr.</b>	521113	<b>Vergl.-Nr.</b>	N/A
<b>Beschreibung</b>	Pumpendeckel LGB Eingang ø 45mm Ausgang ø 40mm Pumpentyp ZF220V SX		



1

<b>GEV-Nr.</b>	521086	<b>Vergl.-Nr.</b>	1435R
<b>Beschreibung</b>	Pumpendeckel LGB Eingang ø 50mm Ausgang ø 40mm		



1

<b>GEV-Nr.</b>	521548	<b>Vergl.-Nr.</b>	0020R
<b>Beschreibung</b>	Pumpendeckel LGB Eingang ø 50mm Ausgang ø 50mm		



1

<b>GEV-Nr.</b>	521108	<b>Vergl.-Nr.</b>	0021R
<b>Beschreibung</b>	Pumpendeckel LGB Eingang ø 50mm Ausgang ø 50mm Hilfsdruck 12mm		



1

<b>GEV-Nr.</b>	521547	<b>Vergl.-Nr.</b>	0758R 0758R (blu)
<b>Beschreibung</b>	Pumpendeckel LGB Eingang ø 60mm Ausgang ø 50mm Hilfsdruck M8 Drehrichtung rechts ø 160mm ID ø 127mm Innenhöhe 36mm		
<b>Ersatzteile zu</b>	521547		
	<b>GEV-Nr.</b>	503122	<b>Vergl.-Nr.</b> —
	Sechskantschraube Gewinde M8 Gewinde L 10mm CNS		
	<b>GEV-Nr.</b>	510177	<b>Vergl.-Nr.</b> —
	O-Ring EPDM Materialstärke 1,78mm ID ø 7,66mm		



1

<b>GEV-Nr.</b>	521053	<b>Vergl.-Nr.</b>	1139R
<b>Beschreibung</b>	Pumpendeckel LGB Eingang ø 61mm Ausgang ø 61mm Drehrichtung rechts ø 210mm ID ø 175mm Innenhöhe 41mm		



1

<b>GEV-Nr.</b>	521516	<b>Vergl.-Nr.</b>	0648R
<b>Beschreibung</b>	Pumpendeckel LGB Eingang ø 62mm Ausgang ø 52mm Hilfsdruck 12mm Hilfsdruck geschlossen Drehrichtung links ø 190mm ID ø 150mm Innenhöhe 40mm		
<b>Ersatzteile zu</b>	521516		
	<b>GEV-Nr.</b>	503122	<b>Vergl.-Nr.</b> —
	Sechskantschraube Gewinde M8 Gewinde L 10mm CNS		
	<b>GEV-Nr.</b>	510177	<b>Vergl.-Nr.</b> —
	O-Ring EPDM Materialstärke 1,78mm ID ø 7,66mm		



1

<b>GEV-Nr.</b>	502280	<b>Vergl.-Nr.</b>	N/A
<b>Beschreibung</b>	Pumpensumpf LGB Hilfsdruck 7mm Hilfsdruck geschlossen Pumpentyp RV54		

Pumpendeckeldichtungen



1

<b>GEV-Nr.</b>	521717	<b>Vergl.-Nr.</b>	N/A
<b>Beschreibung</b>	O-Ring EPDM Materialstärke 1,78mm ID ø 120,37mm VPE 1 Stück		

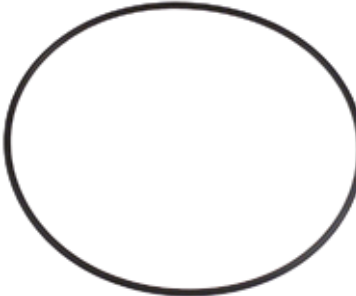

1

<b>GEV-Nr.</b>	513275	<b>Vergl.-Nr.</b>	N/A
<b>Beschreibung</b>	O-Ring EPDM Materialstärke 1,78mm ID ø 82,27mm VPE 1 Stück		

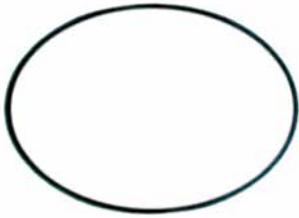

1

<b>GEV-Nr.</b>	510556	<b>Vergl.-Nr.</b>	N/A
<b>Beschreibung</b>	O-Ring EPDM Materialstärke 1,78mm ID ø 94,97mm VPE 1 Stück Pumpentyp T110		



1

<b>GEV-Nr.</b>	509002	<b>Vergl.-Nr.</b>	Guarnizione per Pompa CRC-R DX EPR 2570A
<b>Beschreibung</b>	O-Ring EPDM Materialstärke 2,62mm ID ø 82,22mm VPE 1 Stück		



1

<b>GEV-Nr.</b>	532623	<b>Vergl.-Nr.</b>	1743R
<b>Beschreibung</b>	O-Ring EPDM Materialstärke 2,62mm ID ø 120,32mm VPE 1 Stück		

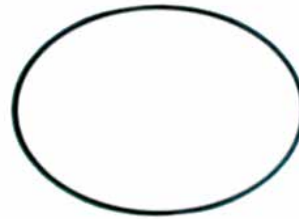

1

<b>GEV-Nr.</b>	510554	<b>Vergl.-Nr.</b>	n/a
<b>Beschreibung</b>	O-Ring EPDM Materialstärke 2mm ID ø 120mm VPE 1 Stück		



1

<b>GEV-Nr.</b>	532719	<b>Vergl.-Nr.</b>	N/A
<b>Beschreibung</b>	O-Ring EPDM Materialstärke 2,62mm ID ø 126,67mm VPE 1 Stück		



1

<b>GEV-Nr.</b>	532537	<b>Vergl.-Nr.</b>	N/A
<b>Beschreibung</b>	O-Ring EPDM Materialstärke 3,53mm ID ø 113,9mm VPE 1 Stück		



1

<b>GEV-Nr.</b>	528800	<b>Vergl.-Nr.</b>	0042R
<b>Beschreibung</b>	O-Ring EPDM Materialstärke 2,62mm ID ø 75,87mm VPE 1 Stück		

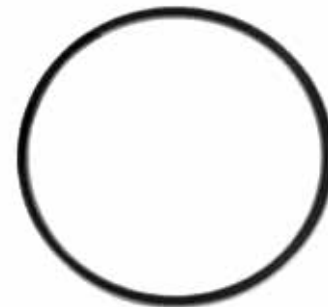

1

<b>GEV-Nr.</b>	510896	<b>Vergl.-Nr.</b>	1158R
<b>Beschreibung</b>	O-Ring EPDM Materialstärke 3,53mm ID ø 183,75mm VPE 1 Stück		



1

<b>GEV-Nr.</b>	698810	<b>Vergl.-Nr.</b>	N/A
<b>Beschreibung</b>	O-Ring EPDM Materialstärke 3,56mm ID ø 112mm VPE 1 Stück		

1



<b>GEV-Nr.</b>	521701	<b>Vergl.-Nr.</b>	0044R
<b>Beschreibung</b>	Pumpendeckeldichtung		

1



<b>GEV-Nr.</b>	510551	<b>Vergl.-Nr.</b>	0049R
<b>Beschreibung</b>	Pumpendeckeldichtung ID ø 158,3mm Pumpentyp 1214/1293/1225/2243/1226/1204/3473/1241 Materialstärke 3,53mm EPDM VPE 1 Stück		

1



Bild nicht vorhanden

<b>GEV-Nr.</b>	521706	<b>Vergl.-Nr.</b>	2234R
<b>Beschreibung</b>	Pumpendeckeldichtung		

1



<b>GEV-Nr.</b>	521714	<b>Vergl.-Nr.</b>	0046R 3283R
<b>Beschreibung</b>	Pumpendeckeldichtung Materialstärke 4x4mm VPE 1 Stück		

1



<b>GEV-Nr.</b>	521703	<b>Vergl.-Nr.</b>	N/A
<b>Beschreibung</b>	Pumpendeckeldichtung EPDM Materialstärke 2,5mm ID ø 75mm VPE 1 Stück		

1



<b>GEV-Nr.</b>	698400	<b>Vergl.-Nr.</b>	0682R
<b>Beschreibung</b>	Pumpendeckeldichtung Pumpentyp PS46 Materialstärke 2mm ID ø 66mm VPE 1 Stück		

1



<b>GEV-Nr.</b>	503125	<b>Vergl.-Nr.</b>	N/A
<b>Beschreibung</b>	Pumpendeckeldichtung EPDM Materialstärke 3mm ID ø 129mm VPE 1 Stück		

1



Bild nicht vorhanden

<b>GEV-Nr.</b>	521038	<b>Vergl.-Nr.</b>	0045R
<b>Beschreibung</b>	Pumpendeckeldichtung Pumpentyp ZF220SX		



