



Pumpen

Wasch- und Nachspülpumpen

OLYMPIA

Pumpen



1			
GEV-Nr.	500521	Vergl.-Nr.	T33
Beschreibung	Pumpe Eingang ø 1" IG Ausgang ø 26mm Typ T33 230V 50Hz Phasen 1 0,25kW 0,34PS L 225mm Laufrichtung rechts Kondensator 5µF Hilfsdruck 11mm Hilfsdruck geschlossen OLYMPIA		
Ersatzteile zu	500521		
	GEV-Nr.	365017	Vergl.-Nr. —
	Betriebskondensator Kapazität 5µF 450V		
	GEV-Nr.	510693	Vergl.-Nr. N/A
	Gleitringdichtung für Wellen ø 12mm		
	GEV-Nr.	521256	Vergl.-Nr. N/A
	Laufrad ø 74mm H 14mm Gewinde M10L Welle ø 12mm		
	GEV-Nr.	521554	Vergl.-Nr. N/A
	Pumpendeckel OLYMPIA Eingang 1" ø 90mm ID ø 66mm		
	GEV-Nr.	521724	Vergl.-Nr. N/A
	O-Ring EPDM Materialstärke 1,78mm ID ø 72,75mm		
	GEV-Nr.	528800	Vergl.-Nr. N/A
	O-Ring EPDM Materialstärke 2,62mm ID ø 75,87mm		





1			
GEV-Nr.	500005	Vergl.-Nr.	T60
Beschreibung	Pumpe Eingang ø 1" IG Ausgang ø 28mm Typ T60 230V 50Hz Phasen 1 0,19kW 0,26PS L 210mm Laufrichtung links Kondensator 5µF OLYMPIA		
Ersatzteile zu	500005		
	GEV-Nr.	365017	Vergl.-Nr. —
	Betriebskondensator Kapazität 5µF 450V		
	GEV-Nr.	509001	Vergl.-Nr. N/A
	Laufrad ø 75mm H 15mm Pumpentyp Typ C		
	GEV-Nr.	509003	Vergl.-Nr. N/A
	Pumpendeckel OLYMPIA Eingang 1" Ausgang ø 28mm		
	GEV-Nr.	510693	Vergl.-Nr. N/A
	Gleitringdichtung für Wellen ø 12mm		
	GEV-Nr.	528800	Vergl.-Nr. N/A
	O-Ring EPDM Materialstärke 2,62mm ID ø 75,87mm		



1			
GEV-Nr.	499257	Vergl.-Nr.	T.45
Beschreibung	Pumpe Eingang ø 1" IG Ausgang ø 30mm Typ L63.T45F_2V 230V 50Hz Phasen 1 0,33kW L 230mm Laufrichtung links Kondensator 8µF OLYMPIA		
Ersatzteile zu	499257		
	GEV-Nr.	365013	Vergl.-Nr. —
	Betriebskondensator Kapazität 8µF 400V		
	GEV-Nr.	509007	Vergl.-Nr. N/A
	Laufrad ø 85mm H 20mm Laufrichtung links		

Tabellenfortsetzung auf der nächsten Seite

Ersatzteile zu	499257		
	GEV-Nr.	510693	Vergl.-Nr. N/A
	Gleitringdichtung für Wellen ø 12mm		
	GEV-Nr.	521167	Vergl.-Nr. N/A
	Pumpendeckel OLYMPIA Eingang ø 1"mm		
	GEV-Nr.	521723	Vergl.-Nr. N/A
	Pumpendeckeldichtung EPDM Materialstärke 2mm		





GEV-Nr.	499131	Vergl.-Nr.	T.19DX
Beschreibung	Pumpe Eingang ø 1" IG Ausgang ø 30mm Typ T.19DX 230V 50Hz Phasen 1 0,19kW L 195mm Laufrichtung links Kondensator 5µF OLYMPIA Ausgang ø 30mm		
Ersatzteile zu	499131		
	GEV-Nr.	365017	Vergl.-Nr. —
	Betriebskondensator Kapazität 5µF 450V		
	GEV-Nr.	510693	Vergl.-Nr. N/A
	Gleitringdichtung für Wellen ø 12mm		
	GEV-Nr.	521168	Vergl.-Nr. N/A
	Pumpendeckel OLYMPIA Eingang ø 1"mm Ausgang ø 30mm		
	GEV-Nr.	521169	Vergl.-Nr. N/A
	Laufblad ø 64mm H 15mm Pumpentyp T.19DX Gewinde M7R		
	GEV-Nr.	521723	Vergl.-Nr. N/A
	Pumpendeckeldichtung EPDM Materialstärke 2mm		



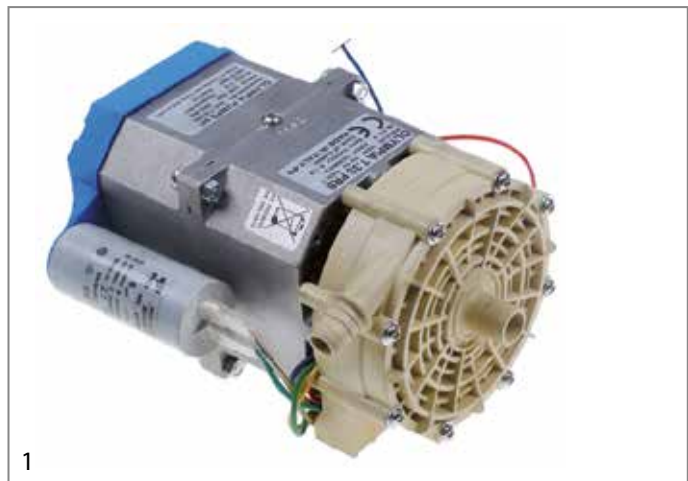

GEV-Nr.	499258	Vergl.-Nr.	R63.T33 PRS
Beschreibung	Pumpe Eingang ø 15mm Ausgang ø 13mm Typ R63.T33 PRS 400V 50Hz Phasen 3 0,25kW L 185mm Laufrichtung links OLYMPIA		
Ersatzteile zu	499258		
	GEV-Nr.	510693	Vergl.-Nr. N/A
	Gleitringdichtung für Wellen ø 12mm		
	GEV-Nr.	521165	Vergl.-Nr. N/A
	Pumpendeckel OLYMPIA Eingang ø 15mm Ausgang ø 13mm		
	GEV-Nr.	521166	Vergl.-Nr. N/A
	Laufblad ø 90mm H 9mm Pumpentyp R63.T33 PRS		
	GEV-Nr.	525022	Vergl.-Nr. N/A
	O-Ring EPDM Materialstärke 1,78mm ID ø 75,92mm		



GEV-Nr.	499095	Vergl.-Nr.	T.33PRS
Beschreibung	Pumpe Eingang ø 15mm Ausgang ø 14mm Typ T.33PRS 230V 50Hz Phasen 1 0,25kW L 185mm Laufrichtung rechts Kondensator 8µF OLYMPIA		
Ersatzteile zu	499095		
	GEV-Nr.	365013	Vergl.-Nr. —
	Betriebskondensator Kapazität 8µF 400V		
	GEV-Nr.	510693	Vergl.-Nr. N/A
	Gleitringdichtung für Wellen ø 12mm		
	GEV-Nr.	521165	Vergl.-Nr. N/A
	Pumpendeckel OLYMPIA Eingang ø 15mm Ausgang ø 13mm		

Tabellenfortsetzung auf der nächsten Seite



Ersatzteile zu 499095				
	GEV-Nr.	521166	Vergl.-Nr.	N/A
Laufрад ø 90mm H 9mm Pumpentyp R63.T33 PRS				
	GEV-Nr.	525022	Vergl.-Nr.	N/A
O-Ring EPDM Materialstärke 1,78mm ID ø 75,92mm				



1				
GEV-Nr.	499318	Vergl.-Nr.	L63.T19	
Beschreibung	Pumpe Eingang ø 28mm Ausgang ø 28mm Typ L63.T19 230V 50Hz Phasen 1 0,19kW L 185mm Laufrichtung rechts Kondensator 5µF OLYMPIA Eingang ø 28mm Ausgang ø 28mm			
Ersatzteile zu 499318				
	GEV-Nr.	365017	Vergl.-Nr.	—
Betriebskondensator Kapazität 5µF 450V				
	GEV-Nr.	510693	Vergl.-Nr.	N/A
Gleitringdichtung für Wellen ø 12mm				
	GEV-Nr.	521163	Vergl.-Nr.	N/A
Pumpendeckel OLYMPIA Eingang ø 28mm Ausgang ø 26mm				
	GEV-Nr.	521164	Vergl.-Nr.	N/A
Laufрад ø 64mm H 15mm Pumpentyp L63.T19				
	GEV-Nr.	521724	Vergl.-Nr.	N/A
O-Ring EPDM Materialstärke 1,78mm ID ø 72,75mm				





1				
GEV-Nr.	500957	Vergl.-Nr.	T.25 Olymبيا	
Beschreibung	Pumpe Eingang ø 28mm Ausgang ø 28mm Typ T25 230V 50Hz Phasen 1 0,19kW 0,25PS L 190mm Laufrichtung links Kondensator 6,3µF OLYMPIA			
Ersatzteile zu 500957				
	GEV-Nr.	365012	Vergl.-Nr.	—
Betriebskondensator Kapazität 6,3µF 450V				
	GEV-Nr.	510248	Vergl.-Nr.	N/A
Pumpendeckel OLYMPIA Eingang ø 28mm Ausgang ø 28mm				
	GEV-Nr.	510249	Vergl.-Nr.	N/A
Laufрад ø 74mm H 19mm Pumpentyp T25				
	GEV-Nr.	510693	Vergl.-Nr.	N/A
Gleitringdichtung für Wellen ø 12mm				
	GEV-Nr.	528800	Vergl.-Nr.	N/A
O-Ring EPDM Materialstärke 2,62mm ID ø 75,87mm				



1				
GEV-Nr.	499229	Vergl.-Nr.	L63.T19	
Beschreibung	Pumpe Eingang ø 28mm Ausgang ø 30mm Typ L63.T19 230V 50Hz Phasen 1 0,19kW L 215mm Laufrichtung rechts Kondensator 5µF OLYMPIA			
Ersatzteile zu 499229				
	GEV-Nr.	365017	Vergl.-Nr.	—
Betriebskondensator Kapazität 5µF 450V				
	GEV-Nr.	510693	Vergl.-Nr.	N/A
Gleitringdichtung für Wellen ø 12mm				

Tabellenfortsetzung auf der nächsten Seite

Ersatzteile zu	499229		
	GEV-Nr.	521164	Vergl.-Nr. N/A
Laufrad ø 64mm H 15mm Pumpentyp L63.T19			
	GEV-Nr.	521170	Vergl.-Nr. N/A
Pumpendeckel OLYMPIA Ausgang ø 30mm			
	GEV-Nr.	521724	Vergl.-Nr. N/A
O-Ring EPDM Materialstärke 1,78mm ID ø 72,75mm			



1

GEV-Nr.	499256	Vergl.-Nr.	L63.T40
Beschreibung	Pumpe Eingang ø 28mm Ausgang ø 30mm Typ L63.T40 230V 50Hz Phasen 1 0,4kW L 235mm Laufrichtung rechts Kondensator 5µF OLYMPIA		
Ersatzteile zu	499256		
	GEV-Nr.	365017	Vergl.-Nr. —
Betriebskondensator Kapazität 5µF 450V			
	GEV-Nr.	510693	Vergl.-Nr. N/A
Gleitringdichtung für Wellen ø 12mm			
	GEV-Nr.	521170	Vergl.-Nr. N/A
Pumpendeckel OLYMPIA Ausgang ø 30mm			
	GEV-Nr.	521171	Vergl.-Nr. N/A
Laufrad ø 74mm H 16mm Pumpentyp L63.T40			
	GEV-Nr.	521724	Vergl.-Nr. N/A
O-Ring EPDM Materialstärke 1,78mm ID ø 72,75mm			





1

GEV-Nr.	500522	Vergl.-Nr.	T41
Beschreibung	Pumpe Eingang ø 29mm Ausgang ø 27mm Typ T41 230V 50Hz Phasen 1 0,29kW 0,4PS L 200mm Laufrichtung links Kondensator 8µF OLYMPIA		
Ersatzteile zu	500522		
	GEV-Nr.	365013	Vergl.-Nr. —
Betriebskondensator Kapazität 8µF 400V			
	GEV-Nr.	510693	Vergl.-Nr. N/A
Gleitringdichtung für Wellen ø 12mm			
	GEV-Nr.	521259	Vergl.-Nr. N/A
Laufrad ø 94mm H 11mm Laufrichtung links			
	GEV-Nr.	521555	Vergl.-Nr. N/A
Pumpendeckel OLYMPIA Eingang ø 29mm Ausgang ø 28mm			
	GEV-Nr.	521726	Vergl.-Nr. N/A
Pumpendeckeldichtung EPDM Materialstärke 2mm			



1

GEV-Nr.	500000	Vergl.-Nr.	T4
Beschreibung	Pumpe Eingang ø 29mm Ausgang ø 28mm Typ T4 230V 50Hz Phasen 1 0,29kW 0,39PS L 202mm Laufrichtung links Kondensator 8µF OLYMPIA		
Ersatzteile zu	500000		
	GEV-Nr.	365013	Vergl.-Nr. —
Betriebskondensator Kapazität 8µF 400V			
	GEV-Nr.	510554	Vergl.-Nr. N/A
O-Ring EPDM Materialstärke 2mm ID ø 120mm			

Tabellenfortsetzung auf der nächsten Seite



Ersatzteile zu 500000			
	GEV-Nr.	510693	Vergl.-Nr. N/A
Gleitringdichtung für Wellen ø 12mm			
	GEV-Nr.	521176	Vergl.-Nr. N/A
Pumpendeckel OLYMPIA Eingang ø 1"mm Ausgang ø 28mm			
	GEV-Nr.	521257	Vergl.-Nr. —
Laufрад ø 80mm H 12mm Laufrichtung links			



1

GEV-Nr.	499296	Vergl.-Nr.	L71.T730_30 (590046)
Beschreibung	Pumpe Eingang ø 30mm Ausgang ø 30mm Typ L71.T730_30 230V 50Hz Phasen 1 0,52kW L 230mm Laufrichtung rechts Kondensator 12,5µF OLYMPIA		
Ersatzteile zu 499296			
	GEV-Nr.	365014	Vergl.-Nr. —
Betriebskondensator Kapazität 12,5µF 400V			
	GEV-Nr.	510554	Vergl.-Nr. N/A
O-Ring EPDM Materialstärke 2mm ID ø 120mm			
	GEV-Nr.	510693	Vergl.-Nr. N/A
Gleitringdichtung für Wellen ø 12mm			
	GEV-Nr.	521159	Vergl.-Nr. N/A
Pumpendeckel OLYMPIA Eingang 30 Eingang ø 30mm			
	GEV-Nr.	521160	Vergl.-Nr. N/A
Laufрад ø 97mm H 22mm Gewinde M10L			



1

GEV-Nr.	499295	Vergl.-Nr.	L71.T730_30 (590108)
Beschreibung	Pumpe Eingang ø 30mm Ausgang ø 30mm Typ L71.T730_30 230V 50Hz Phasen 1 0,52kW L 230mm Laufrichtung rechts Kondensator 12,5µF OLYMPIA Eingang ø 30mm Ausgang ø 30mm		
Ersatzteile zu 499295			
	GEV-Nr.	365014	Vergl.-Nr. —
Betriebskondensator Kapazität 12,5µF 400V			
	GEV-Nr.	510554	Vergl.-Nr. N/A
O-Ring EPDM Materialstärke 2mm ID ø 120mm			
	GEV-Nr.	510693	Vergl.-Nr. N/A
Gleitringdichtung für Wellen ø 12mm			
	GEV-Nr.	521159	Vergl.-Nr. N/A
Pumpendeckel OLYMPIA Eingang 30 Eingang ø 30mm			
	GEV-Nr.	521160	Vergl.-Nr. N/A
Laufрад ø 97mm H 22mm Gewinde M10L			



1

GEV-Nr.	500199	Vergl.-Nr.	T80
Beschreibung	Pumpe Eingang ø 32mm Ausgang ø 30/24mm Typ T80 230V 50Hz Phasen 1 0,25kW 0,34PS L 205mm Laufrichtung links Kondensator 5µF OLYMPIA		
Ersatzteile zu	500199		
	GEV-Nr.	365017	Vergl.-Nr. —
	Betriebskondensator Kapazität 5µF 450V		
	GEV-Nr.	510693	Vergl.-Nr. N/A
	Gleitringdichtung für Wellen ø 12mm		
	GEV-Nr.	521151	Vergl.-Nr. N/A
	Laufrad ø 71mm H 19mm Pumpentyp OLYMPIA		
	GEV-Nr.	521178	Vergl.-Nr. N/A
	Pumpengehäuse OLYMPIA Ausgang ø 30/24mm		
	GEV-Nr.	521552	Vergl.-Nr. N/A
	Pumpendeckel OLYMPIA Eingang ø 32mm		
	GEV-Nr.	521703	Vergl.-Nr. N/A
	Pumpendeckeldichtung EPDM Materialstärke 2,5mm		



1

GEV-Nr.	499322	Vergl.-Nr.	L63.T33DX
Beschreibung	Pumpe Eingang ø 33mm Ausgang ø 30/28mm Typ L63.T33DX 230V 50Hz Phasen 1 0,26kW 0,33PS L 260mm Laufrichtung links Kondensator 5µF OLYMPIA		
Ersatzteile zu	499322		
	GEV-Nr.	365017	Vergl.-Nr. —
	Betriebskondensator Kapazität 5µF 450V		
	GEV-Nr.	510693	Vergl.-Nr. N/A
	Gleitringdichtung für Wellen ø 12mm		
	GEV-Nr.	521258	Vergl.-Nr. N/A
	Laufrad ø 80mm H 13mm Gewinde M10R Welle ø 12mm		
	GEV-Nr.	521551	Vergl.-Nr. N/A
	Pumpendeckel OLYMPIA Eingang ø 33mm Ausgang ø 30mm		
	GEV-Nr.	521723	Vergl.-Nr. N/A
	Pumpendeckeldichtung EPDM Materialstärke 2mm		





1

GEV-Nr.	500520	Vergl.-Nr.	T33
Beschreibung	Pumpe Eingang ø 33mm Ausgang ø 30/28mm Typ T33 230V 50Hz Phasen 1 0,25kW 0,34PS L 190mm Laufrichtung links Kondensator 5µF OLYMPIA		
Ersatzteile zu	500520		
	GEV-Nr.	365017	Vergl.-Nr. —
	Betriebskondensator Kapazität 5µF 450V		
	GEV-Nr.	510693	Vergl.-Nr. N/A
	Gleitringdichtung für Wellen ø 12mm		

Tabellenfortsetzung auf der nächsten Seite



Ersatzteile zu 500520			
	GEV-Nr.	521151	Vergl.-Nr. N/A
Laufrad ø 71mm H 19mm Pumpentyp OLYMPIA			
	GEV-Nr.	521551	Vergl.-Nr. N/A
Pumpendeckel OLYMPIA Eingang ø 33mm Ausgang ø 30mm			
	GEV-Nr.	521723	Vergl.-Nr. N/A
Pumpendeckeldichtung EPDM Materialstärke 2mm			



1			
GEV-Nr.	500958	Vergl.-Nr.	T.45 Krupps
Beschreibung	Pumpe Eingang ø 33mm Ausgang ø 30/28mm Typ T45 230V 50Hz Phasen 1 0,33kW 0,45PS L 215mm Laufrichtung links Kondensator 8µF OLYMPIA		
Ersatzteile zu 500958			
	GEV-Nr.	365013	Vergl.-Nr. —
Betriebskondensator Kapazität 8µF 400V			
	GEV-Nr.	510693	Vergl.-Nr. N/A
Gleitringdichtung für Wellen ø 12mm			
	GEV-Nr.	521257	Vergl.-Nr. —
Laufrad ø 80mm H 12mm Laufrichtung links			
	GEV-Nr.	521551	Vergl.-Nr. N/A
Pumpendeckel OLYMPIA Eingang ø 33mm Ausgang ø 30mm			
	GEV-Nr.	521723	Vergl.-Nr. N/A
Pumpendeckeldichtung EPDM Materialstärke 2mm			







1			
GEV-Nr.	499320	Vergl.-Nr.	L63.T20SX
Beschreibung	Pumpe Eingang ø 33mm Ausgang ø 30mm Typ L63.T20SX 230V 50Hz Phasen 1 0,2kW L 200mm Laufrichtung rechts Kondensator 5µF Hilfsdruck 10mm Hilfsdruck geschlossen OLYMPIA		
Ersatzteile zu 499320			
	GEV-Nr.	365017	Vergl.-Nr. —
Betriebskondensator Kapazität 5µF 450V			
	GEV-Nr.	510693	Vergl.-Nr. N/A
Gleitringdichtung für Wellen ø 12mm			
	GEV-Nr.	521173	Vergl.-Nr. N/A
Pumpendeckel OLYMPIA Eingang ø 33mm Ausgang ø 30mm			
	GEV-Nr.	521174	Vergl.-Nr. N/A
Laufrad ø 60mm H 16mm Pumpentyp L63.T20SX			
	GEV-Nr.	521723	Vergl.-Nr. N/A
Pumpendeckeldichtung EPDM Materialstärke 2mm			



1			
GEV-Nr.	500519	Vergl.-Nr.	T33
Beschreibung	Pumpe Eingang ø 33mm Ausgang ø 30mm Typ T33 230V 50Hz Phasen 1 0,25kW 0,34PS L 195mm Laufrichtung links Kondensator 5µF OLYMPIA		
Ersatzteile zu 500519			
	GEV-Nr.	365017	Vergl.-Nr. —
Betriebskondensator Kapazität 5µF 450V			

Tabellenfortsetzung auf der nächsten Seite

Ersatzteile zu 500519			
	GEV-Nr.	510693	Vergl.-Nr. N/A
Gleitringdichtung für Wellen ø 12mm			
	GEV-Nr.	521257	Vergl.-Nr. —
Laufrad ø 80mm H 12mm Laufrichtung links			
	GEV-Nr.	521553	Vergl.-Nr. N/A
Pumpendeckel OLYMPIA Eingang ø 33mm Ausgang ø 30mm			
	GEV-Nr.	521723	Vergl.-Nr. N/A
Pumpendeckeldichtung EPDM Materialstärke 2mm			





1

GEV-Nr.	500152	Vergl.-Nr.	T90
Beschreibung	Pumpe Eingang ø 44mm Ausgang ø 30mm Typ T90 230V 50Hz Phasen 1 0,33kW 0,45PS L 220mm Laufrichtung links Kondensator 8µF OLYMPIA		
Ersatzteile zu 500152			
	GEV-Nr.	365013	Vergl.-Nr. —
Betriebskondensator Kapazität 8µF 400V			
	GEV-Nr.	509007	Vergl.-Nr. N/A
Laufrad ø 85mm H 20mm Laufrichtung links			
	GEV-Nr.	510693	Vergl.-Nr. N/A
Gleitringdichtung für Wellen ø 12mm			
	GEV-Nr.	521550	Vergl.-Nr. N/A
Pumpendeckel OLYMPIA Eingang ø 44mm Hilfsdruck M8			
	GEV-Nr.	521703	Vergl.-Nr. N/A
Pumpendeckeldichtung EPDM Materialstärke 2,5mm			





1

GEV-Nr.	500003	Vergl.-Nr.	T30
Beschreibung	Pumpe Eingang ø 45mm Ausgang ø 32mm Typ T30 230V 50Hz Phasen 1 0,29kW 0,39PS L 190mm Laufrichtung rechts Kondensator 8µF OLYMPIA		
Ersatzteile zu 500003			
	GEV-Nr.	365013	Vergl.-Nr. —
Betriebskondensator Kapazität 8µF 400V			
	GEV-Nr.	510512	Vergl.-Nr. N/A
Pumpendeckel OLYMPIA Eingang ø 45mm Ausgang ø 31mm			
	GEV-Nr.	510554	Vergl.-Nr. N/A
O-Ring EPDM Materialstärke 2mm ID ø 120mm			
	GEV-Nr.	510615	Vergl.-Nr. N/A
Laufrad ø 90mm H 22mm Laufrichtung rechts			
	GEV-Nr.	510693	Vergl.-Nr. N/A
Gleitringdichtung für Wellen ø 12mm			



1

GEV-Nr.	499208	Vergl.-Nr.	L80.T100_4540
Beschreibung	Pumpe Eingang ø 45mm Ausgang ø 40mm Typ L80.T100 230V 50Hz Phasen 1 0,75kW 1PS L 210mm Laufrichtung rechts Kondensator 12,5µF OLYMPIA		
Ersatzteile zu	499208		
	GEV-Nr.	365014	Vergl.-Nr. —
	Betriebskondensator Kapazität 12,5µF 400V		
	GEV-Nr.	510693	Vergl.-Nr. N/A
	Gleitringdichtung für Wellen ø 12mm		







1

GEV-Nr.	499050	Vergl.-Nr.	MEC71.T75SX
Beschreibung	Pumpe Eingang ø 45mm Ausgang ø 40mm Typ MEC71.T75SX 230V 50Hz Phasen 1 0,55kW 0,75PS L 283mm Laufrichtung rechts Kondensator 12,5µF OLYMPIA		
Ersatzteile zu	499050		
	GEV-Nr.	365014	Vergl.-Nr. —
	Betriebskondensator Kapazität 12,5µF 400V		
	GEV-Nr.	510554	Vergl.-Nr. N/A
	O-Ring EPDM Materialstärke 2mm ID ø 120mm		
	GEV-Nr.	510693	Vergl.-Nr. N/A
	Gleitringdichtung für Wellen ø 12mm		
	GEV-Nr.	517368	Vergl.-Nr. N/A
	Laufrad ø 102mm H 21mm Laufrichtung rechts		

Ersatzteile zu	499050		
	GEV-Nr.	521158	Vergl.-Nr. N/A
	Pumpendeckel OLYMPIA Eingang 45 Eingang ø 40mm		



1



GEV-Nr.	500476	Vergl.-Nr.	T45
Beschreibung	Pumpe Eingang ø 50mm Ausgang ø 30mm Typ T45 230V 50Hz Phasen 1 0,33kW 0,45PS L 215mm Laufrichtung links Kondensator 8µF OLYMPIA		
Ersatzteile zu	500476		
	GEV-Nr.	365013	Vergl.-Nr. —
	Betriebskondensator Kapazität 8µF 400V		
	GEV-Nr.	501312	Vergl.-Nr. —
	O-Ring EPDM Materialstärke 1,78mm ID ø 88,62mm		
	GEV-Nr.	510693	Vergl.-Nr. N/A
	Gleitringdichtung für Wellen ø 12mm		
	GEV-Nr.	521258	Vergl.-Nr. N/A
	Laufrad ø 80mm H 13mm Gewinde M10R Welle ø 12mm		



1

GEV-Nr.	500523	Vergl.-Nr.	T5
Beschreibung	Pumpe Eingang ø 50mm Ausgang ø 30mm Typ T5 230V 50Hz Phasen 1 0,35kW 0,48PS L 205mm Laufrichtung rechts Kondensator 10µF Hilfsdruck 10mm Hilfsdruck offen OLYMPIA		
Ersatzteile zu	500523		
	GEV-Nr.	365015	Vergl.-Nr. —
	Betriebskondensator Kapazität 10µF 400V		

Tabellenfortsetzung auf der nächsten Seite

Ersatzteile zu 500523				
	GEV-Nr.	510554	Vergl.-Nr.	N/A
	O-Ring EPDM Materialstärke 2mm ID ø 120mm			
	GEV-Nr.	510693	Vergl.-Nr.	N/A
	Gleitringdichtung für Wellen ø 12mm			
	GEV-Nr.	521260	Vergl.-Nr.	N/A
	Laufrad ø 90mm H 12mm M10L Typ B			
	GEV-Nr.	521556	Vergl.-Nr.	N/A
	Pumpendeckel OLYMPIA Eingang ø 50mm Ausgang ø 30mm			



1

GEV-Nr.	500524	Vergl.-Nr.	T6	
Beschreibung	Pumpe Eingang ø 50mm Ausgang ø 30mm Typ T6 230V 50Hz Phasen 1 0,48kW 0,65PS L 215mm Laufrichtung rechts Kondensator 10µF OLYMPIA			
Ersatzteile zu 500524				
	GEV-Nr.	365015	Vergl.-Nr.	—
	Betriebskondensator Kapazität 10µF 400V			
	GEV-Nr.	510554	Vergl.-Nr.	N/A
	O-Ring EPDM Materialstärke 2mm ID ø 120mm			
	GEV-Nr.	510693	Vergl.-Nr.	N/A
	Gleitringdichtung für Wellen ø 12mm			
	GEV-Nr.	521262	Vergl.-Nr.	N/A
	Laufrad ø 102mm H 19mm Laufrichtung rechts			
	GEV-Nr.	521556	Vergl.-Nr.	N/A
	Pumpendeckel OLYMPIA Eingang ø 50mm Ausgang ø 30mm			



1

GEV-Nr.	500525	Vergl.-Nr.	T7	
Beschreibung	Pumpe Eingang ø 50mm Ausgang ø 30mm Typ T7 230V 50Hz Phasen 1 0,52kW 0,71PS L 230mm Laufrichtung rechts Kondensator 12,5µF OLYMPIA			
Ersatzteile zu 500525				
	GEV-Nr.	365014	Vergl.-Nr.	—
	Betriebskondensator Kapazität 12,5µF 400V			
	GEV-Nr.	510554	Vergl.-Nr.	N/A
	O-Ring EPDM Materialstärke 2mm ID ø 120mm			
	GEV-Nr.	510693	Vergl.-Nr.	N/A
	Gleitringdichtung für Wellen ø 12mm			
	GEV-Nr.	517368	Vergl.-Nr.	N/A
	Laufrad ø 102mm H 21mm Laufrichtung rechts			
	GEV-Nr.	521556	Vergl.-Nr.	N/A
	Pumpendeckel OLYMPIA Eingang ø 50mm Ausgang ø 30mm			



1

GEV-Nr.	500983	Vergl.-Nr.	T7
Beschreibung	Pumpe Eingang ø 50mm Ausgang ø 30mm Typ T7 230V 50Hz Phasen 1 0,52kW 0,7PS L 220mm Laufrichtung rechts Kondensator 10µF OLYMPIA		
Ersatzteile zu	500983		
	GEV-Nr.	365015	Vergl.-Nr. —
	Betriebskondensator Kapazität 10µF 400V		
	GEV-Nr.	510554	Vergl.-Nr. N/A
	O-Ring EPDM Materialstärke 2mm ID ø 120mm		
	GEV-Nr.	510693	Vergl.-Nr. N/A
	Gleitringdichtung für Wellen ø 12mm		
	GEV-Nr.	517368	Vergl.-Nr. N/A
	Laufrad ø 102mm H 21mm Laufrichtung rechts		
	GEV-Nr.	521569	Vergl.-Nr. N/A
	Pumpendeckel OLYMPIA Eingang ø 50mm Ausgang ø 31mm		



1





GEV-Nr.	499217	Vergl.-Nr.	L80.T7_5040
Beschreibung	Pumpe Eingang ø 50mm Ausgang ø 40mm Typ L80.T7_5040 230V 50Hz Phasen 1 0,6kW 0,8PS L 205mm Laufrichtung rechts Kondensator 12,5µF D 85 dgt OLYMPIA		
Ersatzteile zu	499217		
	GEV-Nr.	365014	Vergl.-Nr. —
	Betriebskondensator Kapazität 12,5µF 400V		

Ersatzteile zu 499217

	GEV-Nr.	510554	Vergl.-Nr.	N/A
	O-Ring EPDM Materialstärke 2mm ID ø 120mm			
	GEV-Nr.	510693	Vergl.-Nr.	N/A
	Gleitringdichtung für Wellen ø 12mm			
	GEV-Nr.	517368	Vergl.-Nr.	N/A
	Laufrad ø 102mm H 21mm Laufrichtung rechts			
	GEV-Nr.	521156	Vergl.-Nr.	N/A
	Pumpendeckel OLYMPIA Eingang ø 50mm Ausgang ø 40mm			



1

GEV-Nr.	500477	Vergl.-Nr.	T5
Beschreibung	Pumpe Eingang ø 50mm Ausgang ø 40mm Typ T5 230V 50Hz Phasen 1 0,35kW 0,48PS L 200mm Laufrichtung rechts Kondensator 10µF OLYMPIA Eingang ø 50mm Ausgang ø 40mm		
Ersatzteile zu	500477		
	GEV-Nr.	365015	Vergl.-Nr. —
	Betriebskondensator Kapazität 10µF 400V		
	GEV-Nr.	507458	Vergl.-Nr. —
	Laufrad ø 90mm H 12mm Laufrichtung rechts		
	GEV-Nr.	510554	Vergl.-Nr. N/A
	O-Ring EPDM Materialstärke 2mm ID ø 120mm		
	GEV-Nr.	510693	Vergl.-Nr. N/A
	Gleitringdichtung für Wellen ø 12mm		



GEV-Nr.	499314	Vergl.-Nr.	L71.T5_5040
Beschreibung	Pumpe Eingang ø 50mm Ausgang ø 41mm Typ L71T5_5040 230V 50Hz Phasen 1 0,38kW L 200mm Laufrichtung rechts Kondensator 10µF OLYMPIA		
Ersatzteile zu	499314		
	GEV-Nr.	Vergl.-Nr.	—
	Betriebskondensator Kapazität 10µF 400V		
	GEV-Nr.	Vergl.-Nr.	N/A
	O-Ring EPDM Materialstärke 2mm ID ø 120mm		
	GEV-Nr.	Vergl.-Nr.	N/A
	Gleitringdichtung für Wellen ø 12mm		
	GEV-Nr.	Vergl.-Nr.	N/A
	Pumpendeckel OLYMPIA Eingang ø 50mm Ausgang ø 40mm		
	GEV-Nr.	Vergl.-Nr.	N/A
	Laufrad ø 82mm H 22mm Gewinde M10L		



GEV-Nr.	499063	Vergl.-Nr.	T15
Beschreibung	Pumpe Eingang ø 50mm Ausgang ø 48mm Typ T15 230V 50Hz Phasen 1 1,1kW L 295mm Laufrichtung rechts Kondensator 16µF Hilfsdruck 10mm Hilfsdruck geschlossen OLYMPIA		
Ersatzteile zu	499063		
	GEV-Nr.	Vergl.-Nr.	—
	Betriebskondensator Kapazität 16µF 425V		





Ersatzteile zu	499063		
	GEV-Nr.	Vergl.-Nr.	N/A
	510693 Gleitringdichtung für Wellen ø 12mm		
	GEV-Nr.	Vergl.-Nr.	N/A
	521065 Pumpendeckel OLYMPIA Eingang ø 50mm Ausgang ø 48mm		
	GEV-Nr.	Vergl.-Nr.	N/A
	521162 Laufrad ø 106mm H 22mm Pumpentyp T75 Gewinde M10L		
	GEV-Nr.	Vergl.-Nr.	N/A
	521727 Pumpendeckeldichtung EPDM Materialstärke 1,78mm		



GEV-Nr.	500475	Vergl.-Nr.	T75
Beschreibung	Pumpe Eingang ø 50mm Ausgang ø 48mm Typ T75 230V 50Hz Phasen 1 0,55kW 0,75PS L 237mm Laufrichtung rechts Kondensator 12,5µF OLYMPIA		
Ersatzteile zu	500475		
	GEV-Nr.	Vergl.-Nr.	—
	365014 Betriebskondensator Kapazität 12,5µF 400V		
	GEV-Nr.	Vergl.-Nr.	N/A
	510693 Gleitringdichtung für Wellen ø 12mm		
	GEV-Nr.	Vergl.-Nr.	N/A
	521161 Pumpendeckel OLYMPIA Eingang ø 50mm		
	GEV-Nr.	Vergl.-Nr.	N/A
	521162 Laufrad ø 106mm H 22mm Pumpentyp T75 Gewinde M10L		
	GEV-Nr.	Vergl.-Nr.	N/A
	521727 Pumpendeckeldichtung EPDM Materialstärke 1,78mm		







1

GEV-Nr.	499260	Vergl.-Nr.	A.4.5/2.6
Beschreibung	Pumpe Eingang ø 60mm Ausgang ø 48mm Typ A.4.5/2.6 220-240/380-415V 50Hz Phasen 3 1,12kW 1,5PS L 310mm Laufrichtung rechts OLYMPIA		
Ersatzteile zu	499260		
	GEV-Nr.	510693	Vergl.-Nr. N/A
	Gleitringdichtung für Wellen ø 12mm		
	GEV-Nr.	521175	Vergl.-Nr. N/A
	Pumpendeckel OLYMPIA Eingang ø 60mm Ausgang ø 48mm		
	GEV-Nr.	521262	Vergl.-Nr. N/A
	Laufrad ø 102mm H 19mm Laufrichtung rechts		
	GEV-Nr.	521727	Vergl.-Nr. N/A
	Pumpendeckeldichtung EPDM Materialstärke 1,78mm		



1

GEV-Nr.	500529	Vergl.-Nr.	T12
Beschreibung	Pumpe Eingang ø 60mm Ausgang ø 48mm Typ T12 230V 50Hz Phasen 1 0,88kW 1,2PS L 270mm Laufrichtung rechts Kondensator 16µF Hilfsdruck 10mm Hilfsdruck offen OLYMPIA		
Ersatzteile zu	500529		
	GEV-Nr.	365021	Vergl.-Nr. —
	Betriebskondensator Kapazität 16µF 425V		

Ersatzteile zu	500529		
	GEV-Nr.	510693	Vergl.-Nr. N/A
	Gleitringdichtung für Wellen ø 12mm		
	GEV-Nr.	521010	Vergl.-Nr. N/A
	Laufrad ø 98mm H 12mm M10L Schaufeln 8		
	GEV-Nr.	521559	Vergl.-Nr. N/A
	Pumpendeckel OLYMPIA Eingang ø 60mm Ausgang ø 48mm		
	GEV-Nr.	521727	Vergl.-Nr. N/A
	Pumpendeckeldichtung EPDM Materialstärke 1,78mm		





1

GEV-Nr.	500530	Vergl.-Nr.	T15
Beschreibung	Pumpe Eingang ø 60mm Ausgang ø 48mm Typ T15 230V 50Hz Phasen 1 1,1kW 1,5PS L 305mm Laufrichtung rechts OLYMPIA		
Ersatzteile zu	500530		
	GEV-Nr.	365021	Vergl.-Nr. —
	Betriebskondensator Kapazität 16µF 425V		
	GEV-Nr.	510693	Vergl.-Nr. N/A
	Gleitringdichtung für Wellen ø 12mm		
	GEV-Nr.	521039	Vergl.-Nr. —
	Lüfterradabdeckung ID ø 156mm AD ø 161mm H 76mm		
	GEV-Nr.	521262	Vergl.-Nr. N/A
	Laufrad ø 102mm H 19mm Laufrichtung rechts		
	GEV-Nr.	521559	Vergl.-Nr. N/A
	Pumpendeckel OLYMPIA Eingang ø 60mm Ausgang ø 48mm		
	GEV-Nr.	521727	Vergl.-Nr. N/A
	Pumpendeckeldichtung EPDM Materialstärke 1,78mm		







1

GEV-Nr.	499291	Vergl.-Nr.	T.15 (6501)
Beschreibung	Pumpe Eingang ø 60mm Ausgang ø 48mm Typ T15 230V 50Hz Phasen 1 1,1kW L 310mm Laufrichtung rechts Kondensator 16µF OLYMPIA		
Ersatzteile zu	499291		
	GEV-Nr. 365021	Vergl.-Nr.	—
	Betriebskondensator Kapazität 16µF 425V		
	GEV-Nr. 510693	Vergl.-Nr.	N/A
	Gleitringdichtung für Wellen ø 12mm		
	GEV-Nr. 521162	Vergl.-Nr.	N/A
	Laufrad ø 106mm H 22mm Pumpentyp T75 Gewinde M10L		
	GEV-Nr. 521175	Vergl.-Nr.	N/A
	Pumpendeckel OLYMPIA Eingang ø 60mm Ausgang ø 48mm		
	GEV-Nr. 521727	Vergl.-Nr.	N/A
	Pumpendeckeldichtung EPDM Materialstärke 1,78mm		

Ersatzteile zu	500526		
	GEV-Nr. 510693	Vergl.-Nr.	N/A
	Gleitringdichtung für Wellen ø 12mm		
	GEV-Nr. 521260	Vergl.-Nr.	N/A
	Laufrad ø 90mm H 12mm M10L Typ B		
	GEV-Nr. 521559	Vergl.-Nr.	N/A
	Pumpendeckel OLYMPIA Eingang ø 60mm Ausgang ø 48mm		
	GEV-Nr. 521727	Vergl.-Nr.	N/A
	Pumpendeckeldichtung EPDM Materialstärke 1,78mm		



1

GEV-Nr.	499338	Vergl.-Nr.	MEC71.T120SX
Beschreibung	Pumpe Eingang ø 62mm Ausgang ø 50mm Typ MEC71.T120SX 220-240/380-415V 50Hz Phasen 3 0,88kW 1,2PS L 310mm Laufrichtung rechts OLYMPIA		
Ersatzteile zu	499338		
	GEV-Nr. 510693	Vergl.-Nr.	N/A
	Gleitringdichtung für Wellen ø 12mm		
	GEV-Nr. 521152	Vergl.-Nr.	N/A
	Pumpendeckel OLYMPIA Eingang 62 ø 190mm		
	GEV-Nr. 521153	Vergl.-Nr.	N/A
	Pumpengehäuse OLYMPIA Ausgang ø 52mm		
	GEV-Nr. 521154	Vergl.-Nr.	N/A
	O-Ring ID ø 152,7mm Materialstärke 2,62mm EPDM		



1

GEV-Nr.	500526	Vergl.-Nr.	T75
Beschreibung	Pumpe Eingang ø 60mm Ausgang ø 48mm Typ T75 230V 50Hz Phasen 1 0,55kW 0,75PS L 250mm Laufrichtung rechts Kondensator 12,5µF Hilfsdruck 10mm Hilfsdruck offen OLYMPIA		
Ersatzteile zu	500526		
	GEV-Nr. 365014	Vergl.-Nr.	—
	Betriebskondensator Kapazität 12,5µF 400V		



1

GEV-Nr.	499259	Vergl.-Nr.	MEC71.T1200X
Beschreibung	Pumpe Eingang ø 62mm Ausgang ø 52mm Typ MEC.T120DX 220-240/380-415V 50Hz Phasen 3 0,89kW 1,2PS L 310mm Laufrichtung links OLYMPIA		
Ersatzteile zu	499259		
	GEV-Nr.	510693	Vergl.-Nr. N/A
	Gleitringdichtung für Wellen ø 12mm		
	GEV-Nr.	521152	Vergl.-Nr. N/A
	Pumpendeckel OLYMPIA Eingang 62 ø 190mm		
	GEV-Nr.	521153	Vergl.-Nr. N/A
	Pumpengehäuse OLYMPIA Ausgang ø 52mm		
	GEV-Nr.	521154	Vergl.-Nr. N/A
	O-Ring ID ø 152,7mm Materialstärke 2,62mm EPDM		
	GEV-Nr.	521172	Vergl.-Nr. N/A
	Laufrad ø 107mm H 28mm Pumpentyp MEC.T120DX		



1

GEV-Nr.	499226	Vergl.-Nr.	MEC80.T200SX
Beschreibung	Pumpe Eingang ø 62mm Ausgang ø 52mm Typ MEC80.T200SX 230/400V 50Hz Phasen 3 1,5kW 2PS L 340mm Laufrichtung rechts OLYMPIA		
Ersatzteile zu	499226		
	GEV-Nr.	510693	Vergl.-Nr. N/A
	Gleitringdichtung für Wellen ø 12mm		
	GEV-Nr.	521152	Vergl.-Nr. N/A
	Pumpendeckel OLYMPIA Eingang 62 ø 190mm		

Ersatzteile zu 499226

	GEV-Nr.	521153	Vergl.-Nr.	N/A
	Pumpengehäuse OLYMPIA Ausgang ø 52mm			
	GEV-Nr.	521154	Vergl.-Nr.	N/A
	O-Ring ID ø 152,7mm Materialstärke 2,62mm EPDM			
	GEV-Nr.	521155	Vergl.-Nr.	N/A
	Laufrad ø 117mm H 31mm Pumpentyp OLYMPIA			
Zubehör zu	499226			
	GEV-Nr.	542157	Vergl.-Nr.	—
	Halterung für Waschpumpe L 267mm B 132mm H 43mm			



1

GEV-Nr.	499290	Vergl.-Nr.	8801
Beschreibung	Pumpe Eingang ø 63mm Ausgang ø 51mm Typ MEC80.T220SX 380-415V 50Hz Phasen 3 1,64kW 2,2PS L 330mm Laufrichtung rechts OLYMPIA		
Ersatzteile zu	499290		
	GEV-Nr.	510693	Vergl.-Nr. N/A
	Gleitringdichtung für Wellen ø 12mm		
	GEV-Nr.	517650	Vergl.-Nr. N/A
	Laufrad ø 107mm H 31mm Pumpentyp MEC80.T220SX		
	GEV-Nr.	521152	Vergl.-Nr. N/A
	Pumpendeckel OLYMPIA Eingang 62 ø 190mm		
	GEV-Nr.	521153	Vergl.-Nr. N/A
	Pumpengehäuse OLYMPIA Ausgang ø 52mm		
	GEV-Nr.	521154	Vergl.-Nr. N/A
	O-Ring ID ø 152,7mm Materialstärke 2,62mm EPDM		



1

GEV-Nr.	500535	Vergl.-Nr.	T70
Beschreibung	Pumpe Eingang ø Ausgang ø 27mm Typ T70 230V 50Hz Phasen 1 0,3kW 0,4PS L 130mm Laufrichtung rechts Kondensator 6,3µF OLYMPIA		
Ersatzteile zu	500535		
	GEV-Nr.	365012	Vergl.-Nr. —
	Betriebskondensator Kapazität 6,3µF 450V		
	GEV-Nr.	510556	Vergl.-Nr. N/A
	O-Ring EPDM Materialstärke 1,78mm ID ø 94,97mm		
	GEV-Nr.	510693	Vergl.-Nr. N/A
	Gleitringdichtung für Wellen ø 12mm		
	GEV-Nr.	521254	Vergl.-Nr. N/A
	Laufrad ø 81mm H 11mm Gewinde M8L Welle ø 12mm		

Ersatzteile und Zubehör

Gleitringdichtungen



1

GEV-Nr.	510693	Vergl.-Nr.	N/A
Beschreibung	Gleitringdichtung für Wellen ø 12mm Gleitring AD ø 24mm Gleitring H 15,5mm Gleitring Innen-ø 11mm Gegenring Einbau ø 24mm Höhe Gegenring 8mm Gegenring Innen-ø 14mm Edelstahl/Keramik/EPDM		

Laufräder



1

GEV-Nr.	521262	Vergl.-Nr.	N/A
Beschreibung	Laufrad ø 102mm H 19mm Laufrichtung rechts Gewinde M10L Schaufeln 6		



1

GEV-Nr.	517368	Vergl.-Nr.	N/A
Beschreibung	Laufrad ø 102mm H 21mm Laufrichtung rechts Gewinde M10L passend für Dihr Schaufeln 8		



1

GEV-Nr.	521162	Vergl.-Nr.	N/A
Beschreibung	Laufrad ø 106mm H 22mm Pumpentyp T75 Gewinde M10L		

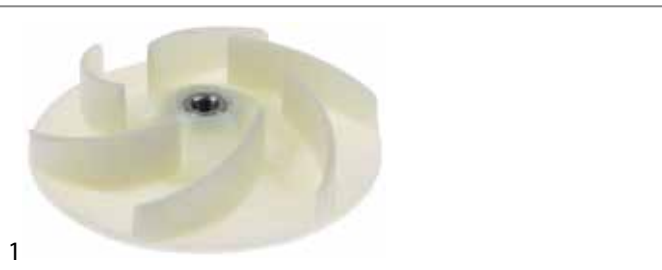

1

GEV-Nr.	521172	Vergl.-Nr.	N/A
Beschreibung	Laufrad ø 107mm H 28mm Pumpentyp MEC.T120DX Gewinde M8R		



1

GEV-Nr.	5217650	Vergl.-Nr.	N/A
Beschreibung	LaufRad ø 107mm H 31mm Pumpentyp MEC80.T220SX Achsaufnahme ø 12mm Laufrichtung rechts Gewinde M8L Schaufeln 6		



1

GEV-Nr.	521155	Vergl.-Nr.	N/A
Beschreibung	LaufRad ø 117mm H 31mm Pumpentyp OLYMPIA Gewinde M8L Schaufeln 6		



1

GEV-Nr.	521174	Vergl.-Nr.	N/A
Beschreibung	LaufRad ø 60mm H 16mm Pumpentyp L63.T20SX Welle ø 12mm Wellenlänge 8mm		



1

GEV-Nr.	521164	Vergl.-Nr.	N/A
Beschreibung	LaufRad ø 64mm H 15mm Pumpentyp L63.T19 Gewinde M7L Welle ø 12mm Wellenlänge 30mm		



1

GEV-Nr.	521169	Vergl.-Nr.	N/A
Beschreibung	LaufRad ø 64mm H 15mm Pumpentyp T.19DX Gewinde M7R Welle ø 12mm Wellenlänge 30mm		



1

GEV-Nr.	521151	Vergl.-Nr.	N/A
Beschreibung	LaufRad ø 71mm H 19mm Pumpentyp OLYMPIA Gewinde M10R Welle ø 12mm Wellenlänge 8mm		



1

GEV-Nr.	521256	Vergl.-Nr.	N/A
Beschreibung	LaufRad ø 74mm H 14mm Gewinde M10L Welle ø 12mm Wellenlänge 7,5mm Schaufeln 8		



1

GEV-Nr.	521171	Vergl.-Nr.	N/A
Beschreibung	LaufRad ø 74mm H 16mm Pumpentyp L63.T40 Gewinde M10L		





1

GEV-Nr.	510249	Vergl.-Nr.	N/A
Beschreibung	Laufrad ø 74mm H 19mm Pumpentyp T25 Laufrichtung links Gewinde M10R Welle ø 12mm Wellenlänge 8mm Schaufeln 6		



1

GEV-Nr.	521157	Vergl.-Nr.	N/A
Beschreibung	Laufrad ø 82mm H 22mm Gewinde M10L		



1

GEV-Nr.	509001	Vergl.-Nr.	N/A
Beschreibung	Laufrad ø 75mm H 15mm Pumpentyp Typ C Laufrichtung links Gewinde M6R Welle ø 11/12mm Wellenlänge 25mm Schaufeln 4		



1

GEV-Nr.	509007	Vergl.-Nr.	N/A
Beschreibung	Laufrad ø 85mm H 20mm Laufrichtung links Gewinde M10R Welle ø 12mm Wellenlänge 7,5mm Schaufeln 12		



1

GEV-Nr.	521258	Vergl.-Nr.	N/A
Beschreibung	Laufrad ø 80mm H 13mm Gewinde M10R Welle ø 12mm Wellenlänge 7,5mm Schaufeln 6		



1

GEV-Nr.	521260	Vergl.-Nr.	N/A
Beschreibung	Laufrad ø 90mm H 12mm M10L Typ B		



1

GEV-Nr.	521254	Vergl.-Nr.	N/A
Beschreibung	Laufrad ø 81mm H 11mm Gewinde M8L Welle ø 12mm Wellenlänge 28mm Schaufeln 6		



1

GEV-Nr.	510615	Vergl.-Nr.	N/A
Beschreibung	Laufrad ø 90mm H 22mm Laufrichtung rechts Gewinde M10L Schaufeln 4		



1

GEV-Nr.	521166	Vergl.-Nr.	N/A
Beschreibung	Laufblad ø 90mm H 9mm Pumpentyp R63.T33 PRS Gewinde M10R Welle ø 12mm Wellenlänge 8mm		



1

GEV-Nr.	521259	Vergl.-Nr.	N/A
Beschreibung	Laufblad ø 94mm H 11mm Laufrichtung links Gewinde M10R Schaufeln 6		



1

GEV-Nr.	521160	Vergl.-Nr.	N/A
Beschreibung	Laufblad ø 97mm H 22mm Gewinde M10L		



1

GEV-Nr.	521010	Vergl.-Nr.	N/A
Beschreibung	Laufblad ø 98mm H 12mm M10L Schaufeln 8		

Pumpendeckel



1

GEV-Nr.	521170	Vergl.-Nr.	N/A
Beschreibung	Pumpendeckel OLYMPIA Ausgang ø 30mm Hilfsdruck 11mm Pumpentyp L63.T19		



1

GEV-Nr.	509003	Vergl.-Nr.	N/A
Beschreibung	Pumpendeckel OLYMPIA Eingang 1" Ausgang ø 28mm Pumpentyp T60		
Zubehör zu	509003		
	GEV-Nr.	528800	Vergl.-Nr. N/A
	O-Ring EPDM Materialstärke 2,62mm ID ø 75,87mm		



1

GEV-Nr.	521554	Vergl.-Nr.	N/A
Beschreibung	Pumpendeckel OLYMPIA Eingang 1" ø 90mm ID ø 66mm Innenhöhe 5mm		



1

GEV-Nr.	521159	Vergl.-Nr.	N/A
Beschreibung	Pumpendeckel OLYMPIA Eingang 30 Eingang ø 30mm Hilfsdruck 10mm Pumpentyp L71.T730_30		



1

GEV-Nr.	521158	Vergl.-Nr.	N/A
Beschreibung	Pumpendeckel OLYMPIA Eingang 45 Eingang ø 40mm Pumpentyp MEC71.T75SX		



1

GEV-Nr.	521165	Vergl.-Nr.	N/A
Beschreibung	Pumpendeckel OLYMPIA Eingang ø 15mm Ausgang ø 13mm Pumpentyp R63.T33 PRS		



1

GEV-Nr.	521152	Vergl.-Nr.	N/A
Beschreibung	Pumpendeckel OLYMPIA Eingang 62 ø 190mm		



1

GEV-Nr.	521163	Vergl.-Nr.	N/A
Beschreibung	Pumpendeckel OLYMPIA Eingang ø 28mm Ausgang ø 26mm Pumpentyp L63.T19		



1

GEV-Nr.	521176	Vergl.-Nr.	N/A
Beschreibung	Pumpendeckel OLYMPIA Eingang ø 1"mm Ausgang ø 28mm Pumpentyp T4		



1

GEV-Nr.	510248	Vergl.-Nr.	N/A
Beschreibung	Pumpendeckel OLYMPIA Eingang ø 28mm Ausgang ø 28mm Hilfsdruck 10,5mm Hilfsdruck geschlossen Drehrichtung links ø 100mm ID ø 83mm Innenhöhe 25mm		



1

GEV-Nr.	521167	Vergl.-Nr.	N/A
Beschreibung	Pumpendeckel OLYMPIA Eingang ø 1"mm Ausgang ø 30/30mm ID ø 94mm		



1

GEV-Nr.	521555	Vergl.-Nr.	N/A
Beschreibung	Pumpendeckel OLYMPIA Eingang ø 29mm Ausgang ø 28mm ø 132mm ID ø 123mm Innenhöhe 18mm		



1

GEV-Nr.	521168	Vergl.-Nr.	N/A
Beschreibung	Pumpendeckel OLYMPIA Eingang ø 1"mm Ausgang ø 30mm Pumpentyp T.19DX		



1

GEV-Nr.	521552	Vergl.-Nr.	N/A
Beschreibung	Pumpendeckel OLYMPIA Eingang ø 32mm Ausgang ø 30/24mm ø 103mm ID ø 93mm		



1

GEV-Nr.	521551	Vergl.-Nr.	N/A
Beschreibung	Pumpendeckel OLYMPIA Eingang ø 33mm Ausgang ø 30mm Ausgang 2 ø 28 Drehrichtung links ø 103mm ID ø 93mm Innenhöhe 30mm		



1

GEV-Nr.	521553	Vergl.-Nr.	N/A
Beschreibung	Pumpendeckel OLYMPIA Eingang ø 33mm Ausgang ø 30mm Drehrichtung links ø 103mm ID ø 93mm Innenhöhe 25mm		



1

GEV-Nr.	521173	Vergl.-Nr.	N/A
Beschreibung	Pumpendeckel OLYMPIA Eingang ø 33mm Ausgang ø 30mm Hilfsdruck 10mm Pumpentyp L63.T20SX		



1

GEV-Nr.	521550	Vergl.-Nr.	N/A
Beschreibung	Pumpendeckel OLYMPIA Eingang ø 44mm Hilfsdruck M8 Hilfsdruck geschlossen ø 103mm ID ø 93mm		



1

GEV-Nr.	510512	Vergl.-Nr.	N/A
Beschreibung	Pumpendeckel OLYMPIA Eingang ø 45mm Ausgang ø 31mm Ausgang 2 ø 24 Drehrichtung rechts ø 130mm ID ø 124mm Innenhöhe 20mm		



1

GEV-Nr.	521556	Vergl.-Nr.	N/A
Beschreibung	Pumpendeckel OLYMPIA Eingang ø 50mm Ausgang ø 30mm Ausgang 2 ø 30 Hilfsdruck 10mm Hilfsdruck offen Drehrichtung rechts ø 130mm ID ø 124mm Innenhöhe 20mm		



1

GEV-Nr.	521569	Vergl.-Nr.	N/A
Beschreibung	Pumpendeckel OLYMPIA Eingang ø 50mm Ausgang ø 31mm Hilfsdruck 10mm Hilfsdruck geschlossen ø 130mm ID ø 124mm Innenhöhe 20mm		



1

GEV-Nr.	521156	Vergl.-Nr.	N/A
Beschreibung	Pumpendeckel OLYMPIA Eingang ø 50mm Ausgang ø 40mm Pumpentyp L71T5_5040		



1

GEV-Nr.	521559	Vergl.-Nr.	N/A
Beschreibung	Pumpendeckel OLYMPIA Eingang ø 60mm Ausgang ø 48mm Ausgang 2 ø 31 Hilfsdruck 10mm Hilfsdruck offen Drehrichtung rechts ø 170mm ID ø 150mm Innenhöhe 22mm		



1

GEV-Nr.	521161	Vergl.-Nr.	N/A
Beschreibung	Pumpendeckel OLYMPIA Eingang ø 50mm Ausgang ø 48/31mm Hilfsdruck 10mm Pumpentyp T75		



1

GEV-Nr.	521178	Vergl.-Nr.	N/A
Beschreibung	Pumpengehäuse OLYMPIA Ausgang ø 30/24mm Pumpentyp T80		



1

GEV-Nr.	521065	Vergl.-Nr.	N/A
Beschreibung	Pumpendeckel OLYMPIA Eingang ø 50mm Ausgang ø 48mm Pumpentyp T15 Drehrichtung rechts ø 170mm ID ø 150mm Innenhöhe 34mm		



1

GEV-Nr.	521153	Vergl.-Nr.	N/A
Beschreibung	Pumpengehäuse OLYMPIA Ausgang ø 52mm		



1

GEV-Nr.	521175	Vergl.-Nr.	N/A
Beschreibung	Pumpendeckel OLYMPIA Eingang ø 60mm Ausgang ø 48mm Ausgang 2 ø 31 Hilfsdruck 10mm		

Pumpendeckeldichtungen



1

GEV-Nr.	521724	Vergl.-Nr.	N/A
Beschreibung	O-Ring EPDM Materialstärke 1,78mm ID ø 72,75mm VPE 1 Stück		

1

GEV-Nr.	525022	Vergl.-Nr.	N/A
Beschreibung	O-Ring EPDM Materialstärke 1,78mm ID ø 75,92mm VPE 1 Stück		

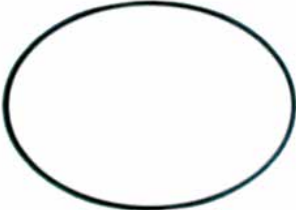

1

GEV-Nr.	510556	Vergl.-Nr.	N/A
Beschreibung	O-Ring EPDM Materialstärke 1,78mm ID ø 94,97mm VPE 1 Stück Pumpentyp T110		



1

GEV-Nr.	528800	Vergl.-Nr.	N/A
Beschreibung	O-Ring EPDM Materialstärke 2,62mm ID ø 75,87mm VPE 1 Stück		

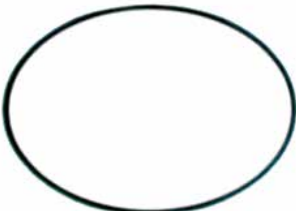

1

GEV-Nr.	510554	Vergl.-Nr.	N/A
Beschreibung	O-Ring EPDM Materialstärke 2mm ID ø 120mm VPE 1 Stück		



1

GEV-Nr.	521154	Vergl.-Nr.	N/A
Beschreibung	O-Ring ID ø 152,7mm Materialstärke 2,62mm EPDM VPE 1 Stück		

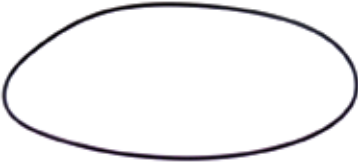

1

GEV-Nr.	521727	Vergl.-Nr.	N/A
Beschreibung	Pumpendeckeldichtung EPDM Materialstärke 1,78mm ID ø 145mm VPE 1 Stück		



1

GEV-Nr.	521703	Vergl.-Nr.	N/A
Beschreibung	Pumpendeckeldichtung EPDM Materialstärke 2,5mm ID ø 75mm VPE 1 Stück		



1

GEV-Nr.	521726	Vergl.-Nr.	N/A
Beschreibung	Pumpendeckeldichtung EPDM Materialstärke 2mm ID ø 120mm VPE 1 Stück		



1

GEV-Nr.	521723	Vergl.-Nr.	N/A
Beschreibung	Pumpendeckeldichtung EPDM Materialstärke 2mm ID ø 90mm VPE 1 Stück		