

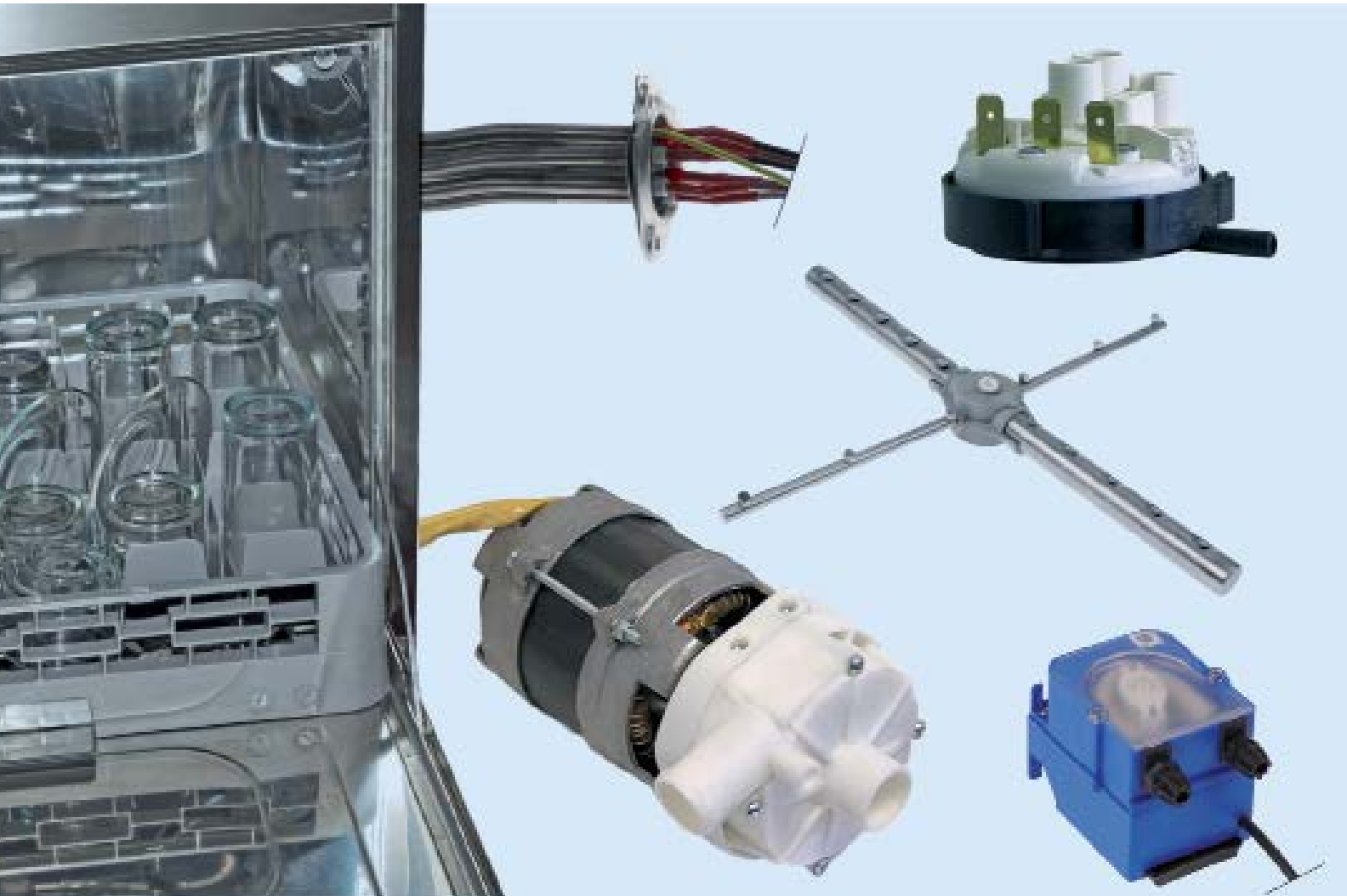

Ersatzteile passend für
Spültechnik



Ersatzteile passend für

UNIVER-BAR

2018

Das komplette Sortiment finden Sie immer aktuell im GEV-Webshop



Heizkörper

Tauchheizkörper

3-Lochflansch ø47,5mm



GEV-Nr.	416318	Vergl.-Nr.	3010
Beschreibung	Heizkörper 3000W 230V Einbau ø 47.5mm HK 3 L 265mm B 32mm H 33mm THA 1 TH ø 6.5mm THL 235mm THP außermittig, nicht anliegend Rohr ø 6.5mm Anschluss M4		
Für Modelle:	CASTA, F40, LOGOS, LOGOS4, LOGOS4D, LOGOSD, MIDI40, MIDI40D, MIDI50, MIDI50D, SINCRO, SINCRO-CF, SINCROD, UBF850-2R		
Zubehör für	416318		
	GEV-Nr.	510408	Vergl.-Nr. 4011
	O-Ring EPDM Materialstärke 5.34mm ID ø 47mm VPE 1 Stück		
	GEV-Nr.	510562	Vergl.-Nr. —
	O-Ring Silikon Materialstärke 5.34mm ID ø 47mm VPE 1 Stück		

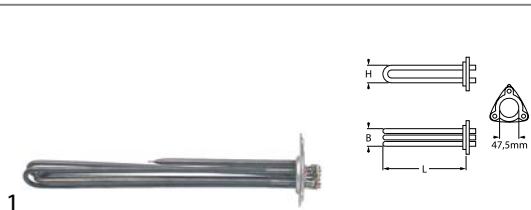

GEV-Nr.	416329	Vergl.-Nr.	3371
Beschreibung	Heizkörper 4500W 230V Einbau ø 47.5mm HK 3 L 370mm B 33mm H 37mm THA 1 TH ø 7mm THL 235mm THP außermittig, nicht anliegend Rohr ø 6.5mm Anschluss M4 3-Lochflansch		
Für Modelle:	BRAMA, OMEGA, OMEGA4, OMEGA4D, OMEGAD		
Ersatzteile für	416329		
	GEV-Nr.	510408	Vergl.-Nr. 4011
	O-Ring EPDM Materialstärke 5.34mm ID ø 47mm VPE 1 Stück		

mit Druckflansch 62 x 26mm



GEV-Nr.	415266	Vergl.-Nr.	2011
Beschreibung	Heizkörper 2000W 230V HK 1 Druckflansch Flansch 62x26mm L 300mm B 41mm Anschluss Flachstecker 6,3mm Rohr ø 6,3mm Tauchheizkörper		
Für Modelle:	ETRA-CF, ETRA-CR, F40, TOP-D		

	GEV-Nr.	416307	Vergl.-Nr.	1532
Beschreibung	Heizkörper 2000W 230V HK 1 Flansch 62x26mm L 270mm B 42mm H 27mm Rohr ø 6mm Anschluss Flachstecker 6,3mm			
Für Modelle:	BET37, BET37D, BET40, BET40D, BET40S, BET40SD, ERGON, ERGON-CF, ERGON-CFD, ERGON-CR, ERGON-CRD, ERGOND, MIDI40, MIDI40D, MINIBET, MINIBETD, TOP-D			

mit Rundflansch ø 47,5mm







GEV-Nr.	416306	Vergl.-Nr.	2010
Beschreibung	Heizkörper 2000W 220V HK 1 Einbau ø 47.5mm L 270mm B 38mm H 22mm Anschluss M4 Rohr ø 6.25mm TH ø 7.5mm THA 1 THL 200mm THP außermittig, nicht anliegend		
Für Modelle:	BET37, BET37D, BET40, BET40D, BET40S, BET40SD, ERGON, ERGON-CF, ERGON-CFD, ERGON-CR, ERGON-CRD, ERGOND, ETRA-CF, ETRA-CR, F40, MINIBET, MINIBETD, UBF530-2R, UBR530-2R		
Zubehör für	416306		
	GEV-Nr.	510408	Vergl.-Nr. 4011
	O-Ring EPDM Materialstärke 5.34mm ID ø 47mm VPE 1 Stück		
	GEV-Nr.	510562	Vergl.-Nr. —
	O-Ring Silikon Materialstärke 5.34mm ID ø 47mm VPE 1 Stück		
	GEV-Nr.	520235	Vergl.-Nr. —
	Dreilochflansch LA 70.5mm Lochung ø 6.5mm ID ø 53.5mm		
	GEV-Nr.	520236	Vergl.-Nr. —
	Flansch für Heizkörper ID ø 50mm AD ø 90mm H 3mm		
	GEV-Nr.	550002	Vergl.-Nr. 3136
	Spannbügel H 10mm L 21mm B 10mm Loch ø 6.5mm für Heizkörper		
	GEV-Nr.	550362	Vergl.-Nr. —
	Blindflansch ø 64mm Einbau ø 47.5mm		

	GEV-Nr.	416319	Vergl.-Nr.	4599
Beschreibung	Heizkörper 2000W 230V HK 1 Einbau ø 47.5mm L 275mm B 39mm H 35mm Anschluss M4 H1 21mm H2 14mm			
Für Modelle:	CASTA, LOGOS, LOGOS4, LOGOS4D, LOGOSD, MIDI50, MIDI50D, SINCRO, SINCRO-CF, SINCROD			
Ersatzteile für	416319			
	GEV-Nr.	510408	Vergl.-Nr.	4011
	O-Ring EPDM Materialstärke 5.34mm ID ø 47mm VPE 1 Stück			
Zubehör für	416319			
	GEV-Nr.	510562	Vergl.-Nr.	—
	O-Ring Silikon Materialstärke 5.34mm ID ø 47mm VPE 1 Stück			



Tabellenfortsetzung auf der nächsten Seite



Zubehör für	416319			
	GEV-Nr.	520235	Vergl.-Nr.	—
Dreilochflansch LA 70.5mm Lochung ø 6.5mm ID ø 53.5mm				
	GEV-Nr.	520236	Vergl.-Nr.	—
Flansch für Heizkörper ID ø 50mm AD ø 90mm H 3mm				
	GEV-Nr.	550002	Vergl.-Nr.	3136
Spannbügel H 10mm L 21mm B 10mm Loch ø 6.5mm für Heizkörper				
	GEV-Nr.	550362	Vergl.-Nr.	—
Blindflansch ø 64mm Einbau ø 47.5mm				

	1			
GEV-Nr.	416327	Vergl.-Nr.	4552	
Beschreibung	Heizkörper 3000W 230V HK 3 Einbau ø 47.5mm L 280mm B 28mm H 60mm Anschluss M4 Rohr ø 6.25mm H1 24mm H2 36mm			
Für Modelle:	BRAMA, COMPACT, COMPACT1200, COSMO, LOGOS, LOGOS4, LOGOS4D, LOGOSD, MIDI50, MIDI50D, OMEGA, OMEGA4, OMEGA4D, OMEGAD, OMEGAD-TRONIC, OMEGA-TRONIC			
Zubehör für	416327			
	GEV-Nr.	510408	Vergl.-Nr.	4011
O-Ring EPDM Materialstärke 5.34mm ID ø 47mm VPE 1 Stück				
	GEV-Nr.	510562	Vergl.-Nr.	—
O-Ring Silikon Materialstärke 5.34mm ID ø 47mm VPE 1 Stück				
	GEV-Nr.	520235	Vergl.-Nr.	—
Dreilochflansch LA 70.5mm Lochung ø 6.5mm ID ø 53.5mm				
	GEV-Nr.	520236	Vergl.-Nr.	—
Flansch für Heizkörper ID ø 50mm AD ø 90mm H 3mm				
	GEV-Nr.	550002	Vergl.-Nr.	3136
Spannbügel H 10mm L 21mm B 10mm Loch ø 6.5mm für Heizkörper				
	GEV-Nr.	550362	Vergl.-Nr.	—
Blindflansch ø 64mm Einbau ø 47.5mm				

	1			
GEV-Nr.	416317	Vergl.-Nr.	4551	
Beschreibung	Heizkörper 6000W 230V HK 3 Einbau ø 47.5mm L 400mm B 36mm H 36mm Anschluss M4 Rohr ø 6.2mm TH ø 7mm THA 1 THL 235mm THP außermittig, nicht anliegend			
Für Modelle:	COMPACT, COMPACT1200, COSMO, OMEGAD-TRONIC, OMEGA-TRONIC			
Ersatzteile für	416317			
	GEV-Nr.	510408	Vergl.-Nr.	4011
O-Ring EPDM Materialstärke 5.34mm ID ø 47mm VPE 1 Stück				
Zubehör für	416317			
	GEV-Nr.	510562	Vergl.-Nr.	—
O-Ring Silikon Materialstärke 5.34mm ID ø 47mm VPE 1 Stück				
	GEV-Nr.	520235	Vergl.-Nr.	—
Dreilochflansch LA 70.5mm Lochung ø 6.5mm ID ø 53.5mm				

Zubehör für	416317			
	GEV-Nr.	520236	Vergl.-Nr.	—
Flansch für Heizkörper ID ø 50mm AD ø 90mm H 3mm				
	GEV-Nr.	550002	Vergl.-Nr.	3136
Spannbügel H 10mm L 21mm B 10mm Loch ø 6.5mm für Heizkörper				
	GEV-Nr.	550362	Vergl.-Nr.	—
Blindflansch ø 64mm Einbau ø 47.5mm				

Zubehör

	1		
GEV-Nr.	550002	Vergl.-Nr.	3136
Beschreibung	Spannbügel H 10mm L 21mm B 10mm Loch ø 6.5mm für Heizkörper		
Für Modelle:	BET37, BET37D, BET40, BET40D, BET40S, BET40SD, COMPACT, ERGON, LOGOS, OMEGAD-TRONIC, OMEGA-TRONIC, SINCRO-CF, UBF850-2R		

Thermostate

Anlegethermostate

Anlege-Sicherheitsthermostate

	1		
GEV-Nr.	390455	Vergl.-Nr.	4751
Beschreibung	Sicherheits-Anlegethermostat LA 40mm Abschalttemp. 100°C 2NC 2-polig 16A Anschluss F6,3 2-Lochbefestigung		
Für Modelle:	BET37, BET37D, BET40, BET40D, BET40S, BET40SD, BRAMA, CASTA, COMPACT, COSMO, ERGON, ERGOND, F40, LOGOS, LOGOS4, LOGOS4D, LOGOSD, MIDI40, MIDI40D, MIDI50, MIDI50D, MINIBET, MINIBETD, OMEGA, OMEGA4, OMEGA4D, OMEGAD, OMEGAD-TRONIC, OMEGA-TRONIC, SINCRO, SINCROD, TOP-D		



Regel- und Sicherheitsthermostate

IMIT / TEMPOMATIC / ARTHERMO

Regelthermostate

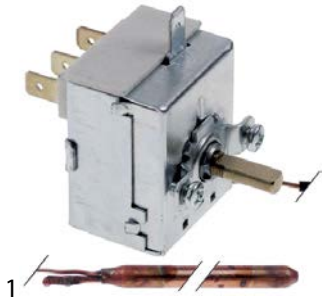

GEV-Nr.	375920	Vergl.-Nr.	4044
Beschreibung	Thermostat T.max. 90°C Arbeitsbereich 0-90°C 1-polig 1CO 16A Fühler ø 6.5mm Fühler L 98mm Kapillarrohr 1030mm Kapillarrohr isoliert 970mm Stopfbuchse Achse ø 6x4,6mm Achslänge 16mm Drehwinkel 270° Fühlermaterial Kupfer 250V		
Für Modelle:	BET37, BET37D, BET40, BET40D, BET40S, BET40SD, BRAMA, CASTA, COMPACT, COMPACT1200, COSMO, ERGON, ERGON-CF, ERGON-CFD, ERGON-CR, ERGON-CRD, ERGOND, ETRA-CF, ETRA-CR, F40, LOGOS, LOGOS4, LOGOS4D, LOGOSD, MIDI40, MIDI40D, MIDI50, MIDI50D, MINIBET, MINIBETD, OMEGA, OMEGA4, OMEGA4D, OMEGAD, OMEGAD-TRONIC, OMEGA-TRONIC, SINCRO, SINCRO-CF, SINCROD, SINTESI, TOP-D, UBF530-2R, UBF850-2R, UBR530-2R		

Zubehör

Tauchhülsen



GEV-Nr.	507462	Vergl.-Nr.	1503
Beschreibung	Tauchhülse Gewinde M10x1 ID ø 7.7mm L 115mm für Fühler 100mm für Fühler ø 7mm		
Für Modelle:	BET37, BET37D, BET40, BET40D, BET40S, BET40SD, BRAMA, CASTA, COMPACT, COSMO, ERGON, ERGON-CF, ERGON-CFD, ERGON-CR, ERGON-CRD, ERGOND, ETRA-CF, ETRA-CR, F40, LOGOS, LOGOS4, LOGOS4D, LOGOSD, MIDI40, MIDI40D, MIDI50, MIDI50D, MINIBET, MINIBETD, OMEGA, OMEGA4, OMEGA4D, OMEGAD, OMEGAD-TRONIC, OMEGA-TRONIC, SINCRO, SINCRO-CF, SINCROD, TOP-D		



GEV-Nr.	345317	Vergl.-Nr.	1519 1520
Beschreibung	Wippentaster Einbaumaß 30x22mm grün 2NO 230V 16A beleuchtet Anschluss Flachstecker 6,3mm Umgebungstemperatur max. 125/55°C Schutzart IP65 mit Gummikragen		
Für Modelle:	BET37, BET37D, BET40, BET40D, BET40S, BET40SD, BRAMA, CASTA, COSMO, ERGON, ERGON-CF, ERGON-CFD, ERGON-CR, ERGON-CRD, ERGOND, ETRA-CF, ETRA-CR, F40, LOGOS, LOGOS4, LOGOS4D, LOGOSD, MICRO, MIDI40, MIDI40D, MIDI50, MIDI50D, MINIBET, MINIBETD, OMEGA, OMEGA4, OMEGA4D, OMEGAD, SINCRO, SINCRO-CF, SINCROD, TOP-D		



GEV-Nr.	346474	Vergl.-Nr.	4671
Beschreibung	Blindkörper Außenmaß 30x22mm passend für Wippenschalter		
Für Modelle:	BRAMA, CASTA, SINCRO		

Mikroschalter

hebelbetätigt



GEV-Nr.	345257	Vergl.-Nr.	4095
Beschreibung	Mikroschalter mit Hebel 250V 16A 1CO Anschluss Flachstecker 6,3mm L 29mm L1 33mm Umgebungstemperatur max. 120°C BA 22mm Betätigungskraft: 130g Hebellänge 31.5mm		
Für Modelle:	BET37, BET37D, BET40, BET40D, BET40S, BET40SD, BRAMA, CASTA, COMPACT, COSMO, ERGON, ERGON-CF, ERGON-CFD, ERGON-CR, ERGON-CRD, ERGOND, ETRA-CF, ETRA-CR, F40, LOGOS, LOGOS4, LOGOS4D, LOGOSD, MICRO, MIDI40, MIDI40D, MIDI50, MIDI50D, MINIBET, MINIBETD, OMEGA, OMEGA4, OMEGA4D, OMEGAD, OMEGAD-TRONIC, OMEGA-TRONIC, SINCRO, SINCRO-CF, SINCROD, SINTESI, TOP-D, UBF530-2R, UBF850-2R, UBR530-2R		

Schalter und Taster

Wippenschalter/-taster

30x22mm



GEV-Nr.	347531	Vergl.-Nr.	4069
Beschreibung	Wippenschalter Einbaumaß 30x22mm grün 2NO 250V 20A beleuchtet 0-I Anschluss Flachstecker 6,3mm Umgebungstemperatur max. 125/55°C Schutzart IP65 mit Gummikragen		
Für Modelle:	BET37, BET37D, BET40, BET40D, BET40S, COMPACT, ERGON, OMEGAD-TRONIC, OMEGA-TRONIC, SINCRO		



GEV-Nr.	347607	Vergl.-Nr.	4780
Beschreibung	Mikroschalter mit Hebel 250V 16A 1CO Anschluss Flachstecker 6,3mm L 77mm Umgebungstemperatur max. 85°C Hebellänge 48mm		
Für Modelle:	COMPACT		

			
1			
GEV-Nr.	346067	Vergl.-Nr.	4074
Beschreibung	Mikroschalter mit Hebel 250V 16A 1CO Anschluss Flachstecker 6,3mm Umgebungstemperatur max. 125°C Hebellänge 30mm		

			
1			
GEV-Nr.	346064	Vergl.-Nr.	4762
Beschreibung	Mikroschalter mit Hebel 250V 16A 3CO Anschluss Flachstecker 6,3mm Umgebungstemperatur max. 125°C Hebellänge 75mm		
Für Modelle:	COMPACT		

Timer

Programmtimer

			
1			
GEV-Nr.	360432	Vergl.-Nr.	4516
Beschreibung	Timer CDC 7802DV Motoren 2 Kammern 2 Laufzeit 1min / 2min 230V Achse ømm Achslängemmm Motorentyp M37RN/M37LN		
Für Modelle:	COMPACT, COMPACT1200, COSMO		

			
1			
GEV-Nr.	360416	Vergl.-Nr.	1912 4090
Beschreibung	Timer CROUZET Motoren 1 Kammern 2 Laufzeit 120s 230V Achse ø 6x4,6mm Achslänge 20mm Hersteller-Nr. 627/5280 Motorentyp 82340		
Für Modelle:	BET37, BET37D, BET40, BET40D, BRAMA, CASTA, ERGON, ERGOND, ETRA-CF, F40, LOGOS, LOGOSD, MIDI40, MIDI40D, MIDI50, MIDI50D, MINIBET, MINIBETD, OMEGA, OMEGAD, SINCRO, SINCRO-CF, SINCROD, SINTESI, TOP-D, UBF530-2R, UBF850-2R, UBR530-2R		

			
1			
GEV-Nr.	360415	Vergl.-Nr.	1507
Beschreibung	Timer CROUZET Motoren 1 Kammern 4 Laufzeit 120s 230V Achse ømm Achslängemmm Hersteller-Nr. 642/5180 Motorentyp 82340		
Für Modelle:	BET37D, BET40D, ERGON-CFD, ERGON-CRD, ERGOND, LOGOS, LOGOSD, MIDI40D, MIDI50D, MINIBETD, OMEGA, OMEGAD, SINCRO-CF, SINCROD, TOP-D		

Schütze

ALLEN BRADLEY

Leistungsschütze

			
1			
GEV-Nr.	380468	Vergl.-Nr.	3045
Beschreibung	Leistungsschütz AC1 20A 230VAC (AC3/400V) 9A/4kW Hauptkontakte 4NO Anschluss Schraubanschluss Typ 100-K09*400		

Relais

Leistungsrelais

mit Laschenbefestigung

			
1			
GEV-Nr.	380815	Vergl.-Nr.	4637
Beschreibung	Leistungsrelais 230VAC 16A 2NO Anschluss Flachstecker 6,3mm Flansch Maße 36x38x68mm		
Für Modelle:	COSMO		



Elektroniken

Platinen



GEV-Nr.	403894	Vergl.-Nr.	3845
Beschreibung	Elektroniktimer L 125mm B 85mm		
Für Modelle:	OMEGAD-TRONIC, OMEGA-TRONIC		



GEV-Nr.	403895	Vergl.-Nr.	4851
Beschreibung	Platine L 135mm B 85mm		
Für Modelle:	BET37D, BET40D, BET40SD, LOGOS4D, OMEGA4D, SINCROD		



GEV-Nr.	692214	Vergl.-Nr.	4850
Beschreibung	Platine Spültechnik für Gerät MID15/COSMO/ERGON L 133mm B 84mm 50/60Hz Eingang 230/240 VacV 230V 17A		
Für Modelle:	BET37, BET40, BET40S, COMPACT, ERGON, LOGOS4, OMEGA4, SINCRO		

Magnetventile

Magnetventile Wasser

TP



GEV-Nr.	370017	Vergl.-Nr.	4075
Beschreibung	Magnetventil 1-fach gerade 230VAC Eingang 3/4" Ausgang 11,5mm DN10 TP p max 10bar		
Für Modelle:	BET37, BET40, BET40S, BRAMA, CASTA, ERGON, ETRA-CF, LOGOS, LOGOS4, MICRO, MIDI50, MINIBET, OMEGA, OMEGA4, OMEGA-TRONIC, SINCRO		

Ersatzteile für	370017		
------------------------	--------	--	--



GEV-Nr.	371013	Vergl.-Nr.	—
	Magnetspule TP 230VAC 50/60Hz		

Zubehör für	370017		
--------------------	--------	--	--



GEV-Nr.	371220	Vergl.-Nr.	—
	Reduzierung TP Durchflussrate 3l/min rot Toleranz ±15%		



















GEV-Nr.	371221	Vergl.-Nr.	—
	Reduzierung TP Durchflussrate 5.5l/min gelb Toleranz ±15%		







GEV-Nr.	371222	Vergl.-Nr.	—
	Reduzierung TP Durchflussrate 6l/min grau Toleranz ±15%		

Zubehör für	370017			
	GEV-Nr.	371223	Vergl.-Nr.	—
	Reduzierung TP Durchflussrate 10l/min weiß Toleranz ±15%			
	GEV-Nr.	371224	Vergl.-Nr.	—
	Reduzierung TP Durchflussrate 12l/min Bronze Toleranz ±15%			
	GEV-Nr.	371225	Vergl.-Nr.	—
	Reduzierung TP Durchflussrate 16l/min hellbraun Toleranz ±15%			
	GEV-Nr.	371226	Vergl.-Nr.	—
	Reduzierung TP Durchflussrate 20l/min rot Toleranz ±15%			
	GEV-Nr.	371230	Vergl.-Nr.	—
	Reduzierung TP Durchflussrate 0.25l/min rot Toleranz ±25%			
	GEV-Nr.	371231	Vergl.-Nr.	—
	Reduzierung TP Durchflussrate 0.35l/min violett Toleranz ±25%			
	GEV-Nr.	371232	Vergl.-Nr.	—
	Reduzierung TP Durchflussrate 0.5l/min orange Toleranz ±25%			
	GEV-Nr.	371233	Vergl.-Nr.	—
	Reduzierung TP Durchflussrate 0.8l/min weiß Toleranz ±25%			
	GEV-Nr.	371234	Vergl.-Nr.	—
	Reduzierung TP Durchflussrate 1l/min hellblau Toleranz ±25%			
	GEV-Nr.	371235	Vergl.-Nr.	—
	Reduzierung TP Durchflussrate 1.2l/min braun Toleranz ±25%			
	GEV-Nr.	371236	Vergl.-Nr.	—
	Reduzierung TP Durchflussrate 1.5l/min hellbraun Toleranz ±25%			
	GEV-Nr.	371237	Vergl.-Nr.	—
	Reduzierung TP Durchflussrate 2.5l/min gelb Toleranz ±25%			
	GEV-Nr.	371238	Vergl.-Nr.	—
	Reduzierung TP Durchflussrate 3.4l/min dunkelgrün Toleranz ±25%			
	GEV-Nr.	371239	Vergl.-Nr.	—
	Reduzierung TP Durchflussrate 5l/min schwarz Toleranz ±25%			
	GEV-Nr.	371240	Vergl.-Nr.	—
	Reduzierung TP Durchflussrate 8l/min blau Toleranz ±20%			



			
1			
GEV-Nr.	370021	Vergl.-Nr.	4076
Beschreibung	Magnetventil 2-fach gerade 230VAC Eingang 3/4" Ausgang 11,5mm DN10 TP Reduzierung Eingang weiß		
Für Modelle:	ERGON, ERGON-CF, ERGON-CFD, ERGON-CR, ERGON-CRD, ETRA-CF, ETRA-CR, F40, LOGOS, MIDI40, OMEGA, SINCRO, SINCRO-CF, UBF530-2R, UBF850-2R, UBR530-2R		
Ersatzteile für	370021		
	GEV-Nr.	Vergl.-Nr.	—
	371013		
	Magnetspule TP 230VAC 50/60Hz		
Zubehör für	370021		
	GEV-Nr.	Vergl.-Nr.	—
	371220		
	Reduzierung TP Durchflussrate 3l/min rot Toleranz ±15%		
	371221	Vergl.-Nr.	—
	Reduzierung TP Durchflussrate 5.5l/min gelb Toleranz ±15%		
	371222	Vergl.-Nr.	—
	Reduzierung TP Durchflussrate 6l/min grau Toleranz ±15%		
	371223	Vergl.-Nr.	—
	Reduzierung TP Durchflussrate 10l/min weiß Toleranz ±15%		
	371224	Vergl.-Nr.	—
	Reduzierung TP Durchflussrate 12l/min Bronze Toleranz ±15%		
	371225	Vergl.-Nr.	—
	Reduzierung TP Durchflussrate 16l/min hellbraun Toleranz ±15%		
	371226	Vergl.-Nr.	—
	Reduzierung TP Durchflussrate 20l/min rot Toleranz ±15%		
	371230	Vergl.-Nr.	—
	Reduzierung TP Durchflussrate 0.25l/min rot Toleranz ±25%		
	371231	Vergl.-Nr.	—
	Reduzierung TP Durchflussrate 0.35l/min violett Toleranz ±25%		
	371232	Vergl.-Nr.	—
	Reduzierung TP Durchflussrate 0.5l/min orange Toleranz ±25%		
	371233	Vergl.-Nr.	—
	Reduzierung TP Durchflussrate 0.8l/min weiß Toleranz ±25%		
	371234	Vergl.-Nr.	—
	Reduzierung TP Durchflussrate 1l/min hellblau Toleranz ±25%		
	371235	Vergl.-Nr.	—
	Reduzierung TP Durchflussrate 1.2l/min braun Toleranz ±25%		
	371236	Vergl.-Nr.	—
	Reduzierung TP Durchflussrate 1.5l/min hellbraun Toleranz ±25%		

Zubehör für	370021		
	GEV-Nr.	Vergl.-Nr.	—
	371237		
	Reduzierung TP Durchflussrate 2.5l/min gelb Toleranz ±25%		
	GEV-Nr.	Vergl.-Nr.	—
	371238		
	Reduzierung TP Durchflussrate 3.4l/min dunkelgrün Toleranz ±25%		
	GEV-Nr.	Vergl.-Nr.	—
	371239		
	Reduzierung TP Durchflussrate 5l/min schwarz Toleranz ±25%		
	GEV-Nr.	Vergl.-Nr.	—
	371240		
	Reduzierung TP Durchflussrate 8l/min blau Toleranz ±20%		

			
1			
GEV-Nr.	370016	Vergl.-Nr.	4078
Beschreibung	Magnetventil 1-fach gewinkelt 230VAC Eingang 3/4" Ausgang 14mm DN10 TP		
Für Modelle:	COMPACT, COSMO, LOGOS, OMEGA		
Ersatzteile für	370016		
	GEV-Nr.	Vergl.-Nr.	—
	371013		
	Magnetspule TP 230VAC 50/60Hz		
Zubehör für	370016		
	GEV-Nr.	Vergl.-Nr.	—
	371220		
	Reduzierung TP Durchflussrate 3l/min rot Toleranz ±15%		
	371221	Vergl.-Nr.	—
	Reduzierung TP Durchflussrate 5.5l/min gelb Toleranz ±15%		
	371222	Vergl.-Nr.	—
	Reduzierung TP Durchflussrate 6l/min grau Toleranz ±15%		
	371223	Vergl.-Nr.	—
	Reduzierung TP Durchflussrate 10l/min weiß Toleranz ±15%		
	371224	Vergl.-Nr.	—
	Reduzierung TP Durchflussrate 12l/min Bronze Toleranz ±15%		
	371225	Vergl.-Nr.	—
	Reduzierung TP Durchflussrate 16l/min hellbraun Toleranz ±15%		
	371226	Vergl.-Nr.	—
	Reduzierung TP Durchflussrate 20l/min rot Toleranz ±15%		
	371230	Vergl.-Nr.	—
	Reduzierung TP Durchflussrate 0.25l/min rot Toleranz ±25%		
	371231	Vergl.-Nr.	—
	Reduzierung TP Durchflussrate 0.35l/min violett Toleranz ±25%		
	371232	Vergl.-Nr.	—
	Reduzierung TP Durchflussrate 0.5l/min orange Toleranz ±25%		

Tabellenfortsetzung auf der nächsten Seite



Zubehör für	370016		
GEV-Nr.	371233	Vergl.-Nr.	—
	Reduzierung TP Durchflussrate 0.8l/min weiß Toleranz ±25%		
GEV-Nr.	371234	Vergl.-Nr.	—
	Reduzierung TP Durchflussrate 1l/min hellblau Toleranz ±25%		
GEV-Nr.	371235	Vergl.-Nr.	—
	Reduzierung TP Durchflussrate 1.2l/min braun Toleranz ±25%		
GEV-Nr.	371236	Vergl.-Nr.	—
	Reduzierung TP Durchflussrate 1.5l/min hellbraun Toleranz ±25%		
GEV-Nr.	371237	Vergl.-Nr.	—
	Reduzierung TP Durchflussrate 2.5l/min gelb Toleranz ±25%		
GEV-Nr.	371238	Vergl.-Nr.	—
	Reduzierung TP Durchflussrate 3.4l/min dunkelgrün Toleranz ±25%		
GEV-Nr.	371239	Vergl.-Nr.	—
	Reduzierung TP Durchflussrate 5l/min schwarz Toleranz ±25%		
GEV-Nr.	371240	Vergl.-Nr.	—
	Reduzierung TP Durchflussrate 8l/min blau Toleranz ±20%		
GEV-Nr.	503139	Vergl.-Nr.	—
	Magnetventilsieb ø 19.5mm H 16mm		

Magnetventile mit Reduzierung



1

GEV-Nr.	370142	Vergl.-Nr.	1542
Beschreibung	Magnetventil 2-fach gerade 230VAC Eingang 3/4" Ausgang 11.5mm Ausgang B 0.6l/min		
Für Modelle:	BET37D, BET40D, BET40SD, ERGON-CFD, ERGON-CRD, ERGOND, LOGOS, LOGOS4D, LOGOSD, MIDI40D, MIDI50D, MINIBETD, OMEGA, OMEGA4D, OMEGAD, OMEGAD-TRONIC, SINCRO-CF, SINCROD, TOP-D		

Pressostate

für Spültechnik

ø58mm mit Flachstecker 6,3mm

mit Anschluss horizontal



1

GEV-Nr.	541140	Vergl.-Nr.	4054
Beschreibung	Pressostat Druckbereich 55/30mbar Anschluss 6mm ø 58mm Druckanschluss horizontal Spültechnik		
Für Modelle:	BET37, BET37D, BET40, BET40D, BET40S, BET40SD, BRAMA, CASTA, COMPACT, COMPACT1200, COSMO, ERGON, ERGON-CF, ERGON-CFD, ERGON-CR, ERGON-CRD, ERGOND, ETRA-CF, ETRA-CR, F40, LOGOS, LOGOS4, LOGOS4D, LOGOSD, MICRO, MIDI40, MIDI40D, MIDI50, MIDI50D, MINIBET, MINIBETD, OMEGA, OMEGA4, OMEGA4D, OMEGAD, OMEGAD-TRONIC, OMEGA-TRONIC, SINCRO, SINCRO-CF, SINCROD, SINTESE, TOP-D, UBF530-2R, UBF850-2R, UBR530-2R		

Pumpen



Wasch- und Nachspülpumpen

FIR

Pumpen



1

GEV-Nr.	500457	Vergl.-Nr.	3823	
Beschreibung	Pumpe Eingang ø 28mm Ausgang ø 26mm Typ 2213.1417 230V 50Hz Phasen 1 0.15kW 0.2PS L 198mm Laufrichtung links Kondensator 6.3µF FIR			
Für Modelle:	BET37, BET37D, BET40, BET40D, BET40S, BET40SD, ERGON, MINIBET, MINIBETD, TOP-D			
Ersatzteile für	500457			
	GEV-Nr.	365012	Vergl.-Nr.	—
	Betriebskondensator Kapazität 6.3µF 450V Becherkondensator Toleranz 5% 50Hz Umgebungstemperatur max. -25 bis + 85°C ø 30mm L 61mm M8 Kunststoff Anschluss Flachstecker 6,3mm Schutzart			
	GEV-Nr.	510384	Vergl.-Nr.	—
	Pumpendeckel Eingang ø 28mm Ausgang ø 26mm ø 100mm ID ø 76mm			
	GEV-Nr.	510695	Vergl.-Nr.	—
	Gleitringdichtung Höhe Gegenring 5.5mm Edelstahl/Keramik/EPDM ID ø 11mm			

Tabellenfortsetzung auf der nächsten Seite

Ersatzteile für	500457			
	GEV-Nr.	521703	Vergl.-Nr.	—
	Pumpendeckeldichtung EPDM Materialstärke 2.5mm ID ø 75mm VPE 1 Stück			



GEV-Nr.	500683	Vergl.-Nr.	4718	
Beschreibung	Pumpe Eingang ø 60mm Ausgang ø 50mm Typ 2223.U150 230V 50Hz Phasen 1 0.89kW 1.2PS L 260mm Laufrichtung rechts Kondensator 16µF FIR			
Für Modelle:	COMPACT			
Ersatzteile für	500683			
	GEV-Nr.	365021	Vergl.-Nr.	—
	Betriebskondensator Kapazität 16µF 425V Becherkondensator Toleranz 5% 50/60Hz Umgebungstemperatur max. -25 bis + 85°C ø 35mm L 73mm 1-fach M8 Kunststoff Anschluss Flachstecker 6,3mm 416.10.99 Schutzart			
	GEV-Nr.	510552	Vergl.-Nr.	—
	Pumpendeckeldichtung Pumpentyp 1292-2/3942/3981/3911/3983			
	GEV-Nr.	510600	Vergl.-Nr.	—
	Laufrad ø 102mm H 29mm Achsaufnahme ø 9/8mm Laufrichtung rechts Schaufeln 6			
	GEV-Nr.	510692	Vergl.-Nr.	—
	Gleitringdichtung für Wellen ø 11mm Gleitring AD ø 24mm Gleitring H 13mm Gegenring Einbau ø 26mm Höhe Gegenring 8mm Gegenring Innen-ø 14mm Edelstahl/Keramik/EPDM			
	GEV-Nr.	521511	Vergl.-Nr.	—
	Pumpendeckel Eingang ø 60mm Ausgang ø 50/30mm Hilfsdruck M12x1,75 Hilfsdruck offen Pumpentyp 2233 Drehrichtung rechts ø 160mm ID ø 120mm Innenhöhe 23mm			



OLYMPIA

Pumpen





GEV-Nr.	500000	Vergl.-Nr.	4112	
Beschreibung	Pumpe Eingang ø 29mm Ausgang ø 28mm Typ T4 230V 50Hz Phasen 1 0.29kW 0.39PS L 202mm Laufrichtung links Kondensator 8µF OLYMPIA			
Für Modelle:	COMPACT 1200, ERGON, ERGON-CF, ERGON-CFD, ERGON-CR, ERGON-CRD, ERGOND, ETRA-CF, ETRA-CR, LOGOS, MICRO, OMEGA, SINCRO-CF, SINTESI, UBF530-2R, UBF850-2R, UBR530-2R			
Ersatzteile für	500000			
	GEV-Nr.	365013	Vergl.-Nr.	—
	Betriebskondensator Kapazität 8µF 400V Becherkondensator Toleranz 5%Hz Umgebungstemperatur max. -25 bis + 85°C ø 31.5mm L 55mm Doppelanschluss M8 Kunststoff Anschluss Flachstecker 6,3mm Schutzart			
	GEV-Nr.	510554	Vergl.-Nr.	—
	O-Ring EPDM Materialstärke 2mm ID ø 120mm VPE 1 Stück			
	GEV-Nr.	510693	Vergl.-Nr.	—
	Gleitringdichtung für Wellen ø 12mm Gleitring AD ø 24mm Gleitring H 15.5mm Gleitring Innen-ø 11mm Gegenring Einbau ø 24mm Höhe Gegenring 8mm Gegenring Innen-ø 13.5mm Edelstahl/Keramik/EPDM			
	GEV-Nr.	521176	Vergl.-Nr.	—
	Pumpendeckel OLYMPIA Eingang ø 1"mm Ausgang ø 28mm Pumpentyp T4			
	GEV-Nr.	521257	Vergl.-Nr.	—
	Laufrad ø 80mm H 12mm Laufrichtung links Gewinde M10R Welle ø 12mm Wellenlänge 7.5mm Schaufeln 6			



1			
GEV-Nr.	500476	Vergl.-Nr.	1808
Beschreibung	Pumpe Eingang ø 50mm Ausgang ø 30mm Typ T45 230V 50Hz Phasen 1 0.33kW 0.45PS L 215mm Laufrichtung links Kondensator 8µF OLYMPIA		
Für Modelle:	MIDI40, MIDI40D		
Ersatzteile für	500476		
	GEV-Nr.	365013	Vergl.-Nr. —
	Betriebskondensator Kapazität 8µF 400V Becherkondensator Toleranz 5%Hz Umgebungstemperatur max. -25 bis + 85°C ø 31.5mm L 55mm Doppelanschluss M8 Kunststoff Anschluss Flachstecker 6,3mm Schutzart		
	GEV-Nr.	501312	Vergl.-Nr. —
	O-Ring EPDM Materialstärke 1.78mm ID ø 88.62mm VPE 1 Stück		
	GEV-Nr.	510693	Vergl.-Nr. —
	Gleitringdichtung für Wellen ø 12mm Gleitring AD ø 24mm Gleitring H 15.5mm Gleitring Innen-ø 11mm Gegenring Einbau ø 24mm Höhe Gegenring 8mm Gegenring Innen-ø 13.5mm Edelstahl/Keramik/EPDM		
	GEV-Nr.	521258	Vergl.-Nr. —
	Laufrad ø 80mm H 13mm Gewinde M10R Welle ø 12mm Wellenlänge 7.5mm Schaufeln 6		



1			
GEV-Nr.	500477	Vergl.-Nr.	3730
Beschreibung	Pumpe Eingang ø 50mm Ausgang ø 40mm Typ T5 230V 50Hz Phasen 1 0.35kW 0.48PS L 200mm Laufrichtung rechts Kondensator 10µF OLYMPIA Eingang ø 50mm Ausgang ø 40mm		
Für Modelle:	CASTA, F40, LOGOS, MIDI50, MIDI50D, SINCRO, SINCRO-CF, SINCROD		
Ersatzteile für	500477		
	GEV-Nr.	365015	Vergl.-Nr. —
	Betriebskondensator Kapazität 10µF 400V Becherkondensator Toleranz 5%Hz Umgebungstemperatur max. -25 bis + 85°C ø 35.5mm L 59mm Doppelanschluss M8 Kunststoff Anschluss Flachstecker 6,3mm Schutzart		

Ersatzteile für	500477		
	GEV-Nr.	507458	Vergl.-Nr. 3731
	Laufrad ø 90mm H 12mm Laufrichtung rechts Gewinde M10L Schaufeln 8		
	GEV-Nr.	510554	Vergl.-Nr. —
	O-Ring EPDM Materialstärke 2mm ID ø 120mm VPE 1 Stück		
	GEV-Nr.	510693	Vergl.-Nr. —
	Gleitringdichtung für Wellen ø 12mm Gleitring AD ø 24mm Gleitring H 15.5mm Gleitring Innen-ø 11mm Gegenring Einbau ø 24mm Höhe Gegenring 8mm Gegenring Innen-ø 13.5mm Edelstahl/Keramik/EPDM		



1			
GEV-Nr.	500475	Vergl.-Nr.	3350
Beschreibung	Pumpe Eingang ø 50mm Ausgang ø 48mm Typ T75 230V 50Hz Phasen 1 0.55kW 0.75PS L 237mm Laufrichtung rechts Kondensator 12.5µF OLYMPIA		
Für Modelle:	BRAMA, LOGOS, LOGOSD, OMEGA, OMEGAD, OMEGAD-TRONIC, OMEGA-TRONIC		
Ersatzteile für	500475		
	GEV-Nr.	365014	Vergl.-Nr. —
	Betriebskondensator Kapazität 12.5µF 450V Becherkondensator Toleranz 5%Hz Umgebungstemperatur max. -25 bis + 85°C ø 35mm L 70mm Doppelanschluss M8 Kunststoff Anschluss Flachstecker 6,3mm 45S.C3DS.12,5 Schutzart		
	GEV-Nr.	510693	Vergl.-Nr. —
	Gleitringdichtung für Wellen ø 12mm Gleitring AD ø 24mm Gleitring H 15.5mm Gleitring Innen-ø 11mm Gegenring Einbau ø 24mm Höhe Gegenring 8mm Gegenring Innen-ø 13.5mm Edelstahl/Keramik/EPDM		
	GEV-Nr.	521161	Vergl.-Nr. —
	Pumpendeckel OLYMPIA Eingang ø 50mm Ausgang ø 48/31mm Hilfsdruck 10mm Pumpentyp T75		
	GEV-Nr.	521162	Vergl.-Nr. —
	Laufrad ø 106mm H 22mm Pumpentyp T75 Gewinde M10L		
	GEV-Nr.	521727	Vergl.-Nr. —
	Pumpendeckeldichtung EPDM Materialstärke 1.78mm ID ø 145mm VPE 1 Stück		



Ablaufpumpen

ASKOLL



GEV-Nr.	500054	Vergl.-Nr.	3385
Beschreibung	Ablaufpumpe Eingang ø 24mm Ausgang ø 22mm 230V 40W 50Hz ASKOLL Typ R113		
Für Modelle:	LOGOS, OMEGA, SINCRO-CF		

Zubehör für	507449		
GEV-Nr.	517181	Vergl.-Nr.	1535
Beschreibung	Flachdichtung Gummi AD ø 44mm ID ø 32mm Materialstärke 3mm VPE 1 Stück		

GEV-Nr.	507460	Vergl.-Nr.	4621
Beschreibung	Ablaufventil Gewinde 1½" AD ø 78mm ID ø 50mm		
Für Modelle:	COMPACT, COSMO		

Elektrozubehör

Klemmen

Geräteanschlussdosen



GEV-Nr.	550300	Vergl.-Nr.	4752
Beschreibung	Netzanschlussklemme 3-polig Kontakte P+N+PE		
Für Modelle:	BET37, BET37D, BET40, BET40D, BET40S, BET40SD, CASTA, ERGON, ERGOND, F40, LOGOS, LOGOS4, LOGOS4D, LOGOSD, MIDI40, MIDI40D, MIDI50, MIDI50D, MINIBET, MINIBETD, SINCRO, SINCROD, TOP-D		

Überlaufrohre

GEV-Nr.	507466	Vergl.-Nr.	1534
Beschreibung	Überlaufrohr L 107mm ø 28mm		
Für Modelle:	BET37, BET37D, BET40, BET40D, BET40S, BET40SD, ERGON, ERGON-CF, ERGON-CFD, ERGON-CR, ERGON-CRD, ERGOND, F40, MIDI40, MIDI40D, MINIBET, MINIBETD, SINCRO, SINCRO-CF, SINCROD		

Gerätespezifische Bauteile

für Spülmaschinen

Ablauf-/Ansaugkomponenten

UNIVERBAR

Ablauf-/Ansaugkörper



GEV-Nr.	507449	Vergl.-Nr.	1536
Beschreibung	Ablaufventil Gewinde 1" Schlauch ø 30mm		
Für Modelle:	BET37, BET37D, BET40, BET40D, BET40S, BET40SD, BRAMA, CASTA, ERGON, ERGON-CF, ERGON-CFD, ERGON-CR, ERGON-CRD, ERGOND, ETRA-CF, ETRA-CR, F40, LOGOS, LOGOSD, MICRO, MIDI40, MIDI40D, MIDI50, MIDI50D, MINIBET, MINIBETD, OMEGA, OMEGAD, OMEGAD-TRONIC, OMEGA-TRONIC, SINCRO, SINCRO-CF, SINCROD, TOP-D		
Zubehör für	507449		
GEV-Nr.	517180	Vergl.-Nr.	—
Beschreibung	Mutter Gewinde 1" H 5mm SW 36 CNS VPE 1 Stück		

GEV-Nr.	517178	Vergl.-Nr.	2112
Beschreibung	Überlaufrohr L 121mm ø 28mm		
Für Modelle:	BRAMA, CASTA, ETRA-CF, ETRA-CR, LOGOS, LOGOS4, LOGOS4D, LOGOSD, MIDI50, MIDI50D, OMEGA, OMEGA4, OMEGA4D, OMEGAD, OMEGAD-TRONIC, OMEGA-TRONIC		

GEV-Nr.	517606	Vergl.-Nr.	1201
Beschreibung	Überlaufrohr L 149mm ø 51mm		
Für Modelle:	COMPACT, COSMO		









1

GEV-Nr.	507500	Vergl.-Nr.	3266
Beschreibung	Überlaufröhr L 88mm ø 28mm		
Für Modelle:	TOP-D		

Behälter

Salzbehälter



GEV-Nr.	510929	Vergl.-Nr.	4333
Beschreibung	Salzbehälter ø 120mm H 117mm Schlauch ø 10mm Einbau ø 70mm Gesamthöhe 157mm		
Für Modelle:	ERGOND, LOGOS, LOGOS4, LOGOS4D, LOGOSD, MIDI40D, MIDI50D, OMEGA, OMEGA4, OMEGA4D, OMEGAD, OMEGAD-TRONIC, OMEGA-TRONIC, SINCRO, SINCRO-CF, SINCROD, SINTESI		
Ersatzteile für	510929		
	GEV-Nr.	506015	Vergl.-Nr. —
	O-Ring EPDM Materialstärke 3.53mm ID ø 39.69mm VPE 1 Stück		
	GEV-Nr.	510018	Vergl.-Nr. —
	Mutter ø 92mm H 10.5mm für Salzbehälter ID ø 64mm		
	GEV-Nr.	524177	Vergl.-Nr. —
	Deckel ø 69mm H 20mm für Salzbehälter ID ø 50mm		
Zubehör für	510929		
	GEV-Nr.	510071	Vergl.-Nr. —
	Flachdichtung Gummi AD ø 81mm ID ø 68mm Materialstärke 3mm für Salzbehälter VPE 1 Stück		
	GEV-Nr.	510654	Vergl.-Nr. —
	Dichtung H 6mm D1 ø 82mm D2 ø 68mm		
	GEV-Nr.	510883	Vergl.-Nr. —
	Dichtung Gummi AD ø 86mm ID ø 66mm Materialstärke 2mm für Salzbehälter VPE 1 Stück		

Boiler

Boiler für Spülmaschinen



1

GEV-Nr.	507465	Vergl.-Nr.	3326
Beschreibung	Boiler ohne Heizkörper ø 150mm L 415mm Eingang ø 12mm Ausgang ø 2x 10mm		
Für Modelle:	BRAMA, CASTA, COMPACT, COSMO, LOGOS, LOGOS4, LOGOS4D, LOGOSD, MIDI50, MIDI50D, OMEGA, OMEGA4, OMEGA4D, OMEGAD, OMEGAD-TRONIC, OMEGA-TRONIC		

Enthärterpatronen

Kolonnen-Enthärter



1



GEV-Nr.	530000	Vergl.-Nr.	4331
Beschreibung	Enthärter 4-fach L 380mm B 180mm		
Für Modelle:	BET37, BET37D, BET40, BET40D, BET40SD, ERGON-CFD, ERGON-CRD, ERGOND, LOGOS, LOGOS4, LOGOS4D, LOGOSD, MIDI40D, MIDI50D, MINIBETD, OMEGA, OMEGA4, OMEGA4D, OMEGAD, OMEGAD-TRONIC, OMEGA-TRONIC, SINCRO, SINCRO-CF, SINCROD, SINTESI, TOP-D		

Luftfallen

Luftfallen



1

GEV-Nr.	507504	Vergl.-Nr.	4032 4032I
Beschreibung	Luftfalle ø 39mm H 35mm Gewinde M8 Schlauch ø 6mm Kunststoff		
Für Modelle:	BET37, BET37D, BET40, BET40D, BET40S, BET40SD, MINIBET, MINIBETD, SINTESI, TOP-D, UBF530-2R, UBF850-2R, UBR530-2R		
Zubehör für	507504		
	GEV-Nr.	507447	Vergl.-Nr. 2017
	Flachdichtung PTFE AD ø 14mm ID ø 8mm Materialstärke 2mm VPE 1 Stück		
	GEV-Nr.	507448	Vergl.-Nr. 2018
	Mutter Gewinde M8 H 8mm CNS SW 13 VPE 1 Stück		



			
1			
GEV-Nr.	507505	Vergl.-Nr.	1360 1360I
Beschreibung	Luftfalle ø 39mm H 90mm Gewinde M8 Schlauch ø 6mm Kunststoff		
Für Modelle:	BRAMA, CASTA, COMPACT, COMPACT1200, COSMO, ERGON, ERGON-CF, ERGON-CFD, ERGON-CR, ERGON-CRD, ERGOND, ETRA-CF, ETRA-CR, F40, LOGOS, LOGOS4, LOGOS4D, LOGOSD, MICRO, MIDI40, MIDI40D, MIDI50, MIDI50D, OMEGA, OMEGA4, OMEGA4D, OMEGAD, OMEGAD-TRONIC, OMEGA-TRONIC, SINCRO, SINCRO-CF, SINCROD		

Rücksaugverhinderer

Rücksaugverhinderer

			
1			
GEV-Nr.	516101	Vergl.-Nr.	4221
Beschreibung	Rücksaugverhinderer Spülmaschine Schlauch ø 12mm		
Für Modelle:	BET37, BET37D, BET40, BET40D, BET40S, BET40SD, BRAMA, CASTA, COMPACT, COSMO, ERGON, LOGOS4, LOGOS4D, OMEGA4, OMEGA4D, OMEGAD-TRONIC, OMEGA-TRONIC, SINCRO, SINCROD		
Ersatzteile für	516101		
	GEV-Nr.	506367	Vergl.-Nr. —
	Flachdichtung Gummi AD ø 40mm ID ø 28mm Materialstärke 1.8mm VPE 1 Stück		

Türmechanik

Sonstiges

			
1			
GEV-Nr.	504428	Vergl.-Nr.	3282
Beschreibung	Buchse für Tür Messing AD ø 10/12mm ID ø 8mm H 5mm		
Für Modelle:	ERGON, ERGOND, F40, LOGOS, LOGOS4, LOGOS4D, LOGOSD, MIDI40, MIDI40D, MIDI50, MIDI50D, OMEGA, OMEGA4, OMEGA4D, OMEGAD, OMEGAD-TRONIC, OMEGA-TRONIC, SINCRO, SINCROD, TOP-D		

			
1			
GEV-Nr.	507450	Vergl.-Nr.	1598
Beschreibung	Feder für Tür		
Für Modelle:	BRAMA, CASTA, COSMO, ERGON, ERGON-CF, ERGON-CFD, ERGON-CR, ERGON-CRD, ERGOND, ETRA-CF, ETRA-CR, LOGOS, LOGOS4, LOGOS4D, LOGOSD, MIDI40, MIDI40D, MIDI50, MIDI50D, OMEGA, OMEGA4, OMEGA4D, OMEGAD, OMEGAD-TRONIC, OMEGA-TRONIC, SINCRO, SINCRO-CF, SINCROD		







Wasch- und Nachspülssysteme

			
1			
GEV-Nr.	517609	Vergl.-Nr.	2528
Beschreibung	Buchse für Nachspülarm PTFE L 10.6mm D1 ø 14mm D2 ø 16.5mm ID ø 10mm		
Für Modelle:	BET37, BET37D, BET40, BET40D, BET40S, BET40SD, BRAMA, CASTA, COMPACT, COSMO, ERGON, ERGOND, ETRA-CF, F40, LOGOS, LOGOS4, LOGOS4D, LOGOSD, MIDI40, MIDI40D, MIDI50, MIDI50D, MINIBET, MINIBETD, OMEGA, OMEGA4, OMEGA4D, OMEGAD, OMEGAD-TRONIC, OMEGA-TRONIC, SINCRO, SINCROD, TOP-D		

Wasch- und Nachspülssysteme (nach Hersteller)

UNIVERBAR

			
1			
GEV-Nr.	507502	Vergl.-Nr.	2540
Beschreibung	Wasch- und Nachspülarm Wasch L 385mm Nachspül L 385mm Waschdüsen 12 Nachspüldüsen 4 Einbau ø 10/32mm EP oben/unten L 390mm B 390mm		
Für Modelle:	BET37, BET37D, ETRA-CF, MINIBET, MINIBETD, SINTESI, TOP-D, UBF530-2R		

			
1			
GEV-Nr.	507581	Vergl.-Nr.	2541
Beschreibung	Wasch- und Nachspülarm Wasch L 430mm Nachspül L 425mm Waschdüsen 12 Nachspüldüsen 5		
Für Modelle:	BET40, BET40D, BET40S, BET40SD, ERGON, ERGON-CF, ERGON-CFD, ERGOND, F40, MIDI40, MIDI40D		
Ersatzteile für	507581		
	GEV-Nr.	505045	Vergl.-Nr. —
	O-Ring EPDM Materialstärke 1.78mm ID ø 5.28mm VPE 1 Stück		
	GEV-Nr.	510893	Vergl.-Nr. —
	O-Ring EPDM Materialstärke 2.62mm ID ø 9.92mm VPE 1 Stück		
	GEV-Nr.	517092	Vergl.-Nr. —
	Führung für Nachspülstift		
	GEV-Nr.	517101	Vergl.-Nr. —
	Dichtung PTFE AD ø 16mm ID ø 10mm Materialstärke 2.5mm VPE 1 Stück		
	GEV-Nr.	517102	Vergl.-Nr. —
	Nachspülstift		
	GEV-Nr.	517103	Vergl.-Nr. —
	Abdeckung		

Tabellenfortsetzung auf der nächsten Seite



Ersatzteile für	507581		
	GEV-Nr.	517104	Vergl.-Nr. —
	O-Ring EPDM Materialstärke 2.62mm ID ø 31.42mm VPE 1 Stück		
	GEV-Nr.	517408	Vergl.-Nr. —
	Rohr für Wascharm AD ø 42mm L 150mm Kunststoff Einbau ø 28mm ID ø 10mm		
	GEV-Nr.	517609	Vergl.-Nr. 2528
	Buchse für Nachspülarm PTFE L 10.6mm D1 ø 14mm D2 ø 16.5mm ID ø 10mm		
	GEV-Nr.	560536	Vergl.-Nr. 2535
	Rändelschraube Gewinde M8 Gewinde L 5mm ø 20mm H 10mm CNS VPE 1 Stück		

	GEV-Nr.	507507	Vergl.-Nr. 3342
	Beschreibung Wasch- und Nachspülarm Wasch L 503mm Nachspül L 475mm Waschküsen 10 Nachspüldüsen 6 Einbau ø 10/32mm EP oben/unten		
	Für Modelle: CASTA, LOGOS, LOGOS4, LOGOS4D, LOGOSD, MIDI50, MIDI50D		

	GEV-Nr.	507468	Vergl.-Nr. 4080
	Beschreibung Endkappe für Nachspülarm Gewinde M10x1 H 8mm Messing verchromt		
	Für Modelle: BET37, BET37D, BET40, BET40D, BET40S, BET40SD, BRAMA, CASTA, COMPACT, COSMO, ERGON, ERGON-CF, ERGON-CFD, ERGON-CR, ERGON-CRD, ERGOND, ETRA-CF, ETRA-CR, F40, LOGOS, LOGOS4, LOGOS4D, LOGOSD, MICRO, MIDI40, MIDI40D, MIDI50, MIDI50D, MINIBET, MINIBETD, OMEGA, OMEGA4, OMEGA4D, OMEGAD, OMEGAD-TRONIC, OMEGA-TRONIC, SINCRO, SINCRO-CF, SINCROD, SINTESI, TOP-D, UBF530-2R, UBF850-2R, UBR530-2R		

	GEV-Nr.	503317	Vergl.-Nr. 4022
	Beschreibung Nachspüldüse H 13mm Gewinde M6x1 SW 10 konisch dichtend		
	Für Modelle: BET37, BET37D, BET40, BET40D, BET40S, BET40SD, BRAMA, CASTA, COMPACT, COSMO, ERGON, ERGON-CF, ERGON-CFD, ERGON-CR, ERGON-CRD, ERGOND, ETRA-CF, ETRA-CR, F40, LOGOS, LOGOS4, LOGOS4D, LOGOSD, MICRO, MIDI40, MIDI40D, MIDI50, MIDI50D, MINIBET, MINIBETD, OMEGA, OMEGA4, OMEGA4D, OMEGAD, OMEGAD-TRONIC, OMEGA-TRONIC, SINCRO, SINCRO-CF, SINCROD, SINTESI, TOP-D, UBF530-2R, UBF850-2R, UBR530-2R		



	GEV-Nr.	507446	Vergl.-Nr. 2530
	Beschreibung Wascharmkreuz		
	Für Modelle: BET37, BET37D, BET40, BET40D, BET40S, BET40SD, CASTA, ERGON, ERGON-CF, ERGON-CFD, ERGOND, ETRA-CF, F40, LOGOS, LOGOS4, LOGOS4D, LOGOSD, MIDI40, MIDI40D, MIDI50, MIDI50D, MINIBET, MINIBETD, SINCRO, SINCRO-CF, SINCROD, TOP-D, UBF530-2R		

	GEV-Nr.	507506	Vergl.-Nr. 3105
	Beschreibung Wasch- und Nachspülarm Wasch L 485mm Nachspül L 470mm Waschküsen 6 Nachspüldüsen 6 Einbau ø 10/43mm EP oben/unten		
	Für Modelle: BRAMA, COMPACT, COSMO, LOGOS4, LOGOS4D, LOGOSD, OMEGA, OMEGA4, OMEGA4D, OMEGAD, OMEGAD-TRONIC, OMEGA-TRONIC, UBF850-2R		

	GEV-Nr.	507468	Vergl.-Nr. 4080
	Beschreibung Endkappe für Nachspülarm Gewinde M10x1 H 8mm Messing verchromt		
	Für Modelle: BET37, BET37D, BET40, BET40D, BET40S, BET40SD, BRAMA, CASTA, COMPACT, COSMO, ERGON, ERGON-CF, ERGON-CFD, ERGON-CR, ERGON-CRD, ERGOND, ETRA-CF, ETRA-CR, F40, LOGOS, LOGOS4, LOGOS4D, LOGOSD, MICRO, MIDI40, MIDI40D, MIDI50, MIDI50D, MINIBET, MINIBETD, OMEGA, OMEGA4, OMEGA4D, OMEGAD, OMEGAD-TRONIC, OMEGA-TRONIC, SINCRO, SINCRO-CF, SINCROD, SINTESI, TOP-D, UBF530-2R, UBF850-2R, UBR530-2R		

	GEV-Nr.	503317	Vergl.-Nr. 4022
	Beschreibung Nachspüldüse H 13mm Gewinde M6x1 SW 10 konisch dichtend		
	Für Modelle: BET37, BET37D, BET40, BET40D, BET40S, BET40SD, BRAMA, CASTA, COMPACT, COSMO, ERGON, ERGON-CF, ERGON-CFD, ERGON-CR, ERGON-CRD, ERGOND, ETRA-CF, ETRA-CR, F40, LOGOS, LOGOS4, LOGOS4D, LOGOSD, MICRO, MIDI40, MIDI40D, MIDI50, MIDI50D, MINIBET, MINIBETD, OMEGA, OMEGA4, OMEGA4D, OMEGAD, OMEGAD-TRONIC, OMEGA-TRONIC, SINCRO, SINCRO-CF, SINCROD, SINTESI, TOP-D, UBF530-2R, UBF850-2R, UBR530-2R		

	GEV-Nr.	517607	Vergl.-Nr. 3109
	Beschreibung Wascharmkreuz Einbau ø 10mm ø 28mm L 77mm B 70mm H 49mm		
	Für Modelle: BRAMA, COMPACT, COSMO, LOGOS4, LOGOS4D, LOGOSD, OMEGA, OMEGA4, OMEGA4D, OMEGAD, OMEGAD-TRONIC, OMEGA-TRONIC		

	GEV-Nr.	507501	Vergl.-Nr. 3259
	Beschreibung Nachspülarm L 375mm Düsen 4 Einbau ø 10mm EP oben		
	Für Modelle: BET37, BET37D, MINIBET, MINIBETD, TOP-D		
Ersatzteile für	507501		
	GEV-Nr.	503317	Vergl.-Nr. 4022
	Nachspüldüse H 13mm Gewinde M6x1 SW 10 konisch dichtend		

Tabellenfortsetzung auf der nächsten Seite





Ersatzteile für	507501		
	GEV-Nr.	507468	Vergl.-Nr. 4080
	Endkappe für Nachspülarm Gewinde M10x1 H 8mm Messing verchromt		

	GEV-Nr.	507468	Vergl.-Nr. 4080
Beschreibung	Endkappe für Nachspülarm Gewinde M10x1 H 8mm Messing verchromt		
Für Modelle:	BET37, BET37D, BET40, BET40D, BET40S, BET40SD, BRAMA, CASTA, COMPACT, COSMO, ERGON, ERGON-CF, ERGON-CFD, ERGON-CR, ERGON-CRD, ERGOND, ETRA-CF, ETRA-CR, F40, LOGOS, LOGOS4, LOGOS4D, LOGOSD, MICRO, MIDI40, MIDI40D, MIDI50, MIDI50D, MINIBET, MINIBETD, OMEGA, OMEGA4, OMEGA4D, OMEGAD, OMEGAD-TRONIC, OMEGA-TRONIC, SINCRO, SINCRO-CF, SINCROD, SINTESI, TOP-D, UBF530-2R, UBF850-2R, UBR530-2R		

	GEV-Nr.	503317	Vergl.-Nr. 4022
Beschreibung	Nachspüldüse H 13mm Gewinde M6x1 SW 10 konisch dichtend		
Für Modelle:	BET37, BET37D, BET40, BET40D, BET40S, BET40SD, BRAMA, CASTA, COMPACT, COSMO, ERGON, ERGON-CF, ERGON-CFD, ERGON-CR, ERGON-CRD, ERGOND, ETRA-CF, ETRA-CR, F40, LOGOS, LOGOS4, LOGOS4D, LOGOSD, MICRO, MIDI40, MIDI40D, MIDI50, MIDI50D, MINIBET, MINIBETD, OMEGA, OMEGA4, OMEGA4D, OMEGAD, OMEGAD-TRONIC, OMEGA-TRONIC, SINCRO, SINCRO-CF, SINCROD, SINTESI, TOP-D, UBF530-2R, UBF850-2R, UBR530-2R		

	GEV-Nr.	507503	Vergl.-Nr. 1918
Beschreibung	Wascharmhalter EP unten		
Für Modelle:	BET37, BET37D, BET40, BET40D, BET40S, BET40SD, ERGON, MINIBET, MINIBETD		

	GEV-Nr.	507467	Vergl.-Nr. 4745
Beschreibung	Wascharmhalter EP unten ø 35mm H 235mm Schlauch ø 33mm		
Für Modelle:	COMPACT, COSMO		

	GEV-Nr.	517608	Vergl.-Nr. 3336
Beschreibung	Wascharmhalter komplett EP unten Gewinde M8x1,25 ø 35mm H 360mm		
Für Modelle:	BRAMA, CASTA, LOGOS, LOGOS4, LOGOS4D, LOGOSD, MIDI50, MIDI50D, OMEGA, OMEGA4, OMEGA4D, OMEGAD, OMEGAD-TRONIC, OMEGA-TRONIC		

Knebel

Herstellerspezifische Knebel

UNIVERBAR



	GEV-Nr.	110949	Vergl.-Nr. 3321
Beschreibung	Knebel Thermostat T.max. 90°C 0-90°C ø 42mm Achse ø 6x4,6mm Abflachung oben schwarz		
Für Modelle:	BET37, BET37D, BET40, BET40D, BET40S, BET40SD, BRAMA, CASTA, COMPACT, COSMO, ERGON, ERGON-CF, ERGON-CFD, ERGON-CR, ERGON-CRD, ERGOND, F40, LOGOS, LOGOS4, LOGOS4D, LOGOSD, MIDI40, MIDI40D, MIDI50, MIDI50D, MINIBET, MINIBETD, OMEGA, OMEGA4, OMEGA4D, OMEGAD, OMEGAD-TRONIC, OMEGA-TRONIC, SINCRO, SINCRO-CF, SINCROD		

Zubehör

Rosetten



	GEV-Nr.	112195	Vergl.-Nr. 3322
Beschreibung	Rosette Knebel Knebel ø 42mm ø 56mm		
Für Modelle:	BET37, BET37D, BET40, BET40D, BET40S, BET40SD, BRAMA, CASTA, COMPACT, COSMO, ERGON, ERGON-CF, ERGON-CFD, ERGON-CR, ERGON-CRD, ERGOND, F40, LOGOS, LOGOS4, LOGOS4D, LOGOSD, MIDI40, MIDI40D, MIDI50, MIDI50D, MINIBET, MINIBETD, OMEGA, OMEGA4, OMEGA4D, OMEGAD, OMEGAD-TRONIC, OMEGA-TRONIC, SINCRO, SINCRO-CF, SINCROD		

Dichtungen

O-Ringe

EPDM

ø1,78mm



	GEV-Nr.	517035	Vergl.-Nr. 3285
Beschreibung	O-Ring EPDM Materialstärke 1.78mm ID ø 4.48mm VPE 1 Stück		
Für Modelle:	F40, TOP-D		



ø2,62mm

1

GEV-Nr.	511511	Vergl.-Nr.	3154
Beschreibung	O-Ring EPDM Materialstärke 2.62mm ID ø 17.13mm VPE 10 Stück		
Für Modelle:	ERGON, ERGON-CF, ERGON-CFD, ERGON-CR, ERGON-CRD, ERGOND, F40, SINTESI, UBF850-2R		

1

GEV-Nr.	505192	Vergl.-Nr.	3337
Beschreibung	O-Ring EPDM Materialstärke 2.62mm ID ø 39.34mm VPE 1 Stück		
Für Modelle:	BRAMA, CASTA, COMPACT, COSMO, F40, LOGOS, LOGOS4, LOGOS4D, LOGOSD, MIDI50, MIDI50D, OMEGA, OMEGA4, OMEGA4D, OMEGAD, OMEGAD-TRONIC, OMEGA-TRONIC, SINCRO, SINCRO-CF, SINCROD		

ø5,34mm

1

GEV-Nr.	510408	Vergl.-Nr.	4011
Beschreibung	O-Ring EPDM Materialstärke 5.34mm ID ø 47mm VPE 1 Stück		
Für Modelle:	BET37, BET37D, BET40, BET40D, BET40S, BET40SD, BRAMA, CASTA, COMPACT, COSMO, ERGON, ERGON-CF, ERGON-CFD, ERGON-CR, ERGON-CRD, ERGOND, ETRA-CF, ETRA-CR, F40, LOGOS, LOGOS4, LOGOS4D, LOGOSD, MIDI40, MIDI40D, MIDI50, MIDI50D, MINIBET, MINIBETD, OMEGA, OMEGA4, OMEGA4D, OMEGAD, OMEGAD-TRONIC, OMEGA-TRONIC, SINCRO, SINCRO-CF, SINCROD, UBF530-2R, UBF850-2R, UBR530-2R		

Dichtungsringe

Gummidichtungen

1

GEV-Nr.	517181	Vergl.-Nr.	1535
Beschreibung	Flachdichtung Gummi AD ø 44mm ID ø 32mm Materialstärke 3mm VPE 1 Stück		
Für Modelle:	BET37, BET37D, BET40, BET40D, BET40S, BET40SD, BRAMA, CASTA, ERGON, ERGON-CF, ERGON-CFD, ERGON-CR, ERGON-CRD, ERGOND, ETRA-CF, ETRA-CR, F40, LOGOS, LOGOS4, LOGOS4D, LOGOSD, MICRO, MIDI40, MIDI40D, MIDI50, MIDI50D, MINIBET, MINIBETD, OMEGA, OMEGA4, OMEGA4D, OMEGAD, OMEGAD-TRONIC, OMEGA-TRONIC, SINCRO, SINCRO-CF, SINCROD, TOP-D, UBF530-2R, UBR530-2R		

PTFE-Dichtungen

1

GEV-Nr.	507447	Vergl.-Nr.	2017
Beschreibung	Flachdichtung PTFE AD ø 14mm ID ø 8mm Materialstärke 2mm VPE 1 Stück		
Für Modelle:	BET37, BET37D, BET40, BET40D, BET40S, BET40SD, BRAMA, CASTA, COMPACT, COMPACT1200, COSMO, ERGON, ERGON-CF, ERGON-CFD, ERGON-CR, ERGON-CRD, ERGOND, ETRA-CF, ETRA-CR, F40, LOGOS, LOGOS4, LOGOS4D, LOGOSD, MICRO, MIDI40, MIDI40D, MIDI50, MIDI50D, MINIBET, MINIBETD, OMEGA, OMEGA4, OMEGA4D, OMEGAD, OMEGAD-TRONIC, OMEGA-TRONIC, SINCRO, SINCRO-CF, SINCROD, SINTESI, TOP-D, UBF530-2R, UBF850-2R, UBR530-2R		

Dosiergeräte

Schlauchpumpendosiergeräte

SEKO

Aufputzversion

mit Drehzahlsteuerung

1

GEV-Nr.	361156 ¹	Vergl.-Nr.	4801
Beschreibung	Dosiergerät SEKO Drehzahlregelung 0,6-4l/h 230VAC Reiniger Schlauch ø 4x6mm Schlauchtyp K Schlauch Santoprene Saughöhe 1.5m Typ PR Aufputzversion Maße 103x82x92mm		
Für Modelle:	BRAMA, CASTA, COSMO, ERGOND, LOGOS, LOGOSD, MIDI40, MIDI40D, MIDI50, MIDI50D, OMEGA, OMEGAD, SINCROD		



Ersatzteile für	361156			
	GEV-Nr.	361136	Vergl.-Nr.	—
	Schlauchroller für Dosiergerät Loch ø 4,8x4mm			
	GEV-Nr.	361815	Vergl.-Nr.	—
	Pumpenschlauch Reiniger Schlauch ø 6x10mm Schlauch ø 4x6mm Schlauchtyp K Schlauch Santoprene Typ SEKO			
	GEV-Nr.	362034	Vergl.-Nr.	—
	Pumpendeckel für Dosiergerät Kunststoff SEKO			
Zubehör für	361156			
	GEV-Nr.	361142	Vergl.-Nr.	—
	Montagesatz Reiniger Schlauchtyp 4x6mm Schlauchlänge 2m PVC 2x Schlauch/Behälterfilter/Wanneneinlauf transparent			
	GEV-Nr.	361891	Vergl.-Nr.	—
	Montagesatz Reiniger Schlauchtyp 4x6mm Schlauchlänge 2m PVC 2x Schlauch/Behälterfilter/Wanneneinlauf transparent			
	GEV-Nr.	520090	Vergl.-Nr.	—
	PVC-Schlauch ID ø 4mm AD ø 6mm L 2m Wandstärke 1mm T.max. 60°C transparent			
	GEV-Nr.	520091	Vergl.-Nr.	—
	Nylonschlauch ID ø 4mm AD ø 6mm L 2m Wandstärke 1mm Arbeitsdruck 10bar Platzdruck 50bar T.max. 100°C transparent			

¹mit Zubehör



Einbauversion				
mit Frequenzsteuerung				
				
1				
GEV-Nr.	361767 ¹	Vergl.-Nr.	1916	
Beschreibung	Dosiergerät SEKO 3l/h 230VAC Reiniger Schlauch ø 4x6mm Schlauchtyp K Schlauch Santoprene Saughöhe 1.5m Typ NBR 3 8W Einbauversion Schlauchpumpe			
Für Modelle:	BRAMA, CASTA, COSMO, ERGOND, LOGOS, LOGOSD, MIDI40, MIDI40D, MIDI50, MIDI50D, OMEGA, OMEGAD, SINCROD			
Ersatzteile für	361767			
	GEV-Nr.	361815	Vergl.-Nr.	—
Pumpenschlauch Reiniger Schlauch ø 6x10mm Schlauch ø 4x6mm Schlauchtyp K Schlauch Santoprene Typ SEKO				

¹inkl. Ansaug- und Förderschlauch

Zubehör für 361535				
	GEV-Nr.	361553	Vergl.-Nr.	—
Membran EPDM				
	GEV-Nr.	361700	Vergl.-Nr.	—
Schlauchanschluss drehbar Schlauch ø 4x6mm Kunststoff Anschluss M10x1				
	GEV-Nr.	361701	Vergl.-Nr.	—
Schlauchanschluss Gewinde M10x1 Tülle ø 7.5mm				
	GEV-Nr.	361703	Vergl.-Nr.	—
Schlauchanschluss Gewinde M10x1 Messing Rohranschluss ø 4x6mmmm				
	GEV-Nr.	361704	Vergl.-Nr.	—
Schlauchanschluss Messing gerade Gewinde M12x1 Schlauch ø 11mm VPE 1 Stück				
	GEV-Nr.	510296	Vergl.-Nr.	—
Membran Silikon				
	GEV-Nr.	520090	Vergl.-Nr.	—
PVC-Schlauch ID ø 4mm AD ø 6mm L 2m Wandstärke 1mm T.max. 60°C transparent				
	GEV-Nr.	520091	Vergl.-Nr.	—
Nylonschlauch ID ø 4mm AD ø 6mm L 2m Wandstärke 1mm Arbeitsdruck 10bar Platzdruck 50bar T.max. 100°C transparent				

Membranpumpen

selbstsaugend mit Hilfsdruck

GERMAC

Typ 2000

				
1				
GEV-Nr.	361535	Vergl.-Nr.	4096	
Beschreibung	Dosiergerät Typ 2000 Klarspüler Eingang 4x6mm Ausgang M10x1 Sauganschluss ø 4x6mm Hilfsdruck 11mm Rückschlagkugel PTFE 1mm GERMAC CODE VNR/U3			
Für Modelle:	BET37, BET37D, BET40, BET40D, BET40S, BET40SD, BRAMA, CASTA, COMPACT, COMPACT1200, COSMO, ERGON, ERGON-CF, ERGON-CFD, ERGON-CR, ERGON-CRD, ERGOND, ETRA-CF, ETRA-CR, F40, LOGOS, LOGOS4, LOGOS4D, LOGOSD, MICRO, MIDI40, MIDI40D, MIDI50, MIDI50D, MINIBET, MINIBETD, OMEGA, OMEGA4, OMEGA4D, OMEGAD, OMEGAD-TRONIC, OMEGA-TRONIC, SINCRO, SINCRO-CF, SINCROD, SINTESI, TOP-D, UBF530-2R, UBF850-2R, UBR530-2R			
Ersatzteile für	361535			
	GEV-Nr.	361550	Vergl.-Nr.	—
Schlauchanschluss Schlauch ø 4x6mm				
	GEV-Nr.	361551	Vergl.-Nr.	—
Druckfeder Drahtstärke ø 1mm				
	GEV-Nr.	361702	Vergl.-Nr.	—
Schlauchanschluss Messing Schlauch ø 4x6mm				
	GEV-Nr.	361705	Vergl.-Nr.	—
Dichtung für Schlauchnippel M12x1				
	GEV-Nr.	510298	Vergl.-Nr.	—
Lippenventil Dosiergerät passend für DB2/DS5				
Zubehör für	361535			
	GEV-Nr.	361142	Vergl.-Nr.	—
Montagesatz Reiniger Schlauchtyp 4x6mm Schlauchlänge 2m PVC 2x Schlauch/Behälterfilter/Wanneneinlauf transparent				

Zubehör

Behälterfilter

			
1			
GEV-Nr.	361905	Vergl.-Nr.	1040
Beschreibung	Behälterfilter Kunststoff Schlauch ø 5mm Reiniger		
Für Modelle:	BRAMA, CASTA, COSMO, ERGOND, LOGOS, LOGOSD, MIDI40, MIDI40D, MIDI50, MIDI50D, OMEGA, OMEGAD, SINCROD		

Schläuche

Zulaufschläuche

PVC-Zulaufschläuche



GEV-Nr.	520010	Vergl.-Nr.	3204
Beschreibung	Zulaufschlauch PVC gerade-gebogen DN13 Anschlüsse 3/4" L 1500mm Arbeitsdruck 10bar Platzdruck 32bar T.max. 90°C blau Zulassung VDE flachdichtend		
Für Modelle:	BET37, BET37D, BET40, BET40D, BET40S, BET40SD, BRAMA, CASTA, ERGON, ERGON-CF, ERGON-CFD, ERGON-CR, ERGON-CRD, ERGOND, ETRA-CF, ETRA-CR, F40, LOGOS, LOGOS4, LOGOS4D, LOGOSD, MID140, MID140D, MID150, MID150D, MINIBET, MINIBETD, OMEGA, OMEGA4, OMEGA4D, OMEGAD, OMEGAD-TRONIC, OMEGA-TRONIC, SINCRO, SINCRO-CF, SINCROD, SINTESI, TOP-D, UBF530-2R, UBF850-2R, UBR530-2R		
Zubehör für	520010		
	GEV-Nr.	520053	Vergl.-Nr.
			—
	Sieb Anschluss 3/4" D1 ø 26mm D2 ø 15mm VPE 10 Stück Gummi Materialstärke 8mm		
	GEV-Nr.	520054	Vergl.-Nr.
			—
	Flachdichtung Gummi AD ø 23.5mm ID ø 14mm Materialstärke 2.3mm VPE 10 Stück		

Ablaufschläuche

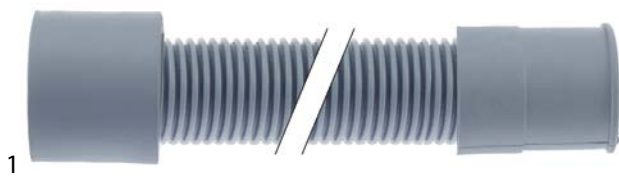

GEV-Nr.	511205	Vergl.-Nr.	1604
Beschreibung	Ablaufschlauch DN19 L 1500mm A ø innen 23mm A ø außen 29mm B ø innen 29mm Schlauch ø außen 29mm B ø außen 35mm		
Für Modelle:	BET37, BET37D, BET40, BET40D, BET40S, BET40SD, BRAMA, CASTA, ERGON, ERGOND, ETRA-CF, F40, LOGOS, LOGOS4, LOGOS4D, LOGOSD, MID140, MID140D, MID150, MID150D, MINIBET, MINIBETD, OMEGA, OMEGA4, OMEGA4D, OMEGAD, OMEGAD-TRONIC, OMEGA-TRONIC, SINCRO, SINCROD, TOP-D		

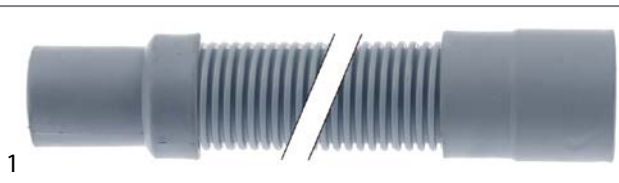

GEV-Nr.	530574	Vergl.-Nr.	4717
Beschreibung	Ablaufschlauch DN31 L 2000mm A ø innen 31mm A ø außen 35mm B ø innen 41mm B ø außen 45mm Schlauch ø außen 38mm		
Für Modelle:	COMPACT, COSMO		

Messtechnik

Thermometer

Einbauthermometer



GEV-Nr.	541086	Vergl.-Nr.	4507
Beschreibung	Thermometer Einbaumaß 58x25,5mm 0 bis +120°C Kapillarrohr 2000mm Fühler ø 6mm Fühler L 23mm		
Für Modelle:	COMPACT, COMPACT1200		

Befestigungsmaterialien

Schrauben

Rändelschrauben



GEV-Nr.	560536	Vergl.-Nr.	2535
Beschreibung	Rändelschraube Gewinde M8 Gewinde L 5mm ø 20mm H 10mm CNS VPE 1 Stück		
Für Modelle:	BET37, BET37D, BET40, BET40D, BET40S, BET40SD, BRAMA, CASTA, COMPACT, COSMO, ERGON, ERGON-CF, ERGON-CFD, ERGOND, ETRA-CF, F40, LOGOS, LOGOS4, LOGOS4D, LOGOSD, MICRO, MID140, MID140D, MID150, MID150D, MINIBET, MINIBETD, OMEGA, OMEGA4, OMEGA4D, OMEGAD, OMEGAD-TRONIC, OMEGA-TRONIC, SINCRO, SINCRO-CF, SINCROD, SINTESI, TOP-D, UBF530-2R, UBF850-2R		

Muttern

Sechskantmutter

DIN 6923 / ISO 4161



GEV-Nr.	507448	Vergl.-Nr.	2018
Beschreibung	Mutter Gewinde M8 H 8mm CNS SW 13 VPE 1 Stück		
Für Modelle:	BET37, BET37D, BET40, BET40D, BET40S, BET40SD, BRAMA, CASTA, COMPACT, COMPACT1200, COSMO, ERGON, ERGON-CF, ERGON-CFD, ERGON-CR, ERGON-CRD, ERGOND, ETRA-CF, F40, LOGOS, LOGOS4, LOGOS4D, LOGOSD, MICRO, MID140, MID140D, MID150, MID150D, MINIBET, MINIBETD, OMEGA, OMEGA4, OMEGA4D, OMEGAD, OMEGAD-TRONIC, OMEGA-TRONIC, SINCRO, SINCRO-CF, SINCROD, TOP-D, UBF530-2R, UBF850-2R, UBR530-2R		



Sechskantmuttern metrisch (ohne Norm)

			
1			
GEV-Nr.	507461	Vergl.-Nr.	1505
Beschreibung	Sechskantmutter Gewinde M10x1 H 3mm SW 17 CNS VPE 1 Stück		
Für Modelle:	BET37, BET37D, BET40, BET40D, BET40S, BET40SD, BRAMA, CASTA, COMPACT, COSMO, ERGON, ERGON-CF, ERGON-CFD, ERGON-CR, ERGON-CRD, ERGOND, ETRA-CF, ETRA-CR, F40, LOGOS, LOGOS4, LOGOS4D, LOGOSD, MIDI40, MIDI40D, MIDI50, MIDI50D, MINIBET, MINIBETD, OMEGA, OMEGA4, OMEGA4D, OMEGAD, OMEGAD-TRONIC, OMEGA-TRONIC, SINCRO, SINCRO-CF, SINCROD, TOP-D		

Sechskantmuttern Zoll

			
1			
GEV-Nr.	507459	Vergl.-Nr.	1533
Beschreibung	Mutter Gewinde 1" H 5mm SW 36 CNS VPE 1 Stück		
Für Modelle:	BET37, BET37D, BET40, BET40D, BET40S, BET40SD, BRAMA, CASTA, ERGON, ERGON-CF, ERGON-CFD, ERGON-CR, ERGON-CRD, ERGOND, ETRA-CF, ETRA-CR, F40, LOGOS, LOGOS4, LOGOS4D, LOGOSD, MICRO, MIDI40, MIDI40D, MIDI50, MIDI50D, MINIBET, MINIBETD, OMEGA, OMEGA4, OMEGA4D, OMEGAD, OMEGAD-TRONIC, OMEGA-TRONIC, SINCRO, SINCRO-CF, SINCROD, TOP-D, UBF530-2R, UBR530-2R		

A		T	
Ablaufpumpen	11	Tauchheizkörper	2
Ablaufschläuche	18	Tauchhülsen	4
Anlege-Sicherheitsthermostate	3	Thermostate	3
Anlegethermostate	3	Timer	5
B		W	
Befestigungsmaterialien	18	Wasch- und Nachspülpumpen	8
Behälterfilter	17	Wippenschalter/-taster	4
D		Z	
Dichtungsringe	16	Zulaufschläuche	18
Dosiergeräte	16		
E			
Elektrozubehör	11		
G			
GEV	2		
H			
Heizkörper	2		
K			
Klemmen	11		
M			
Magnetventile	6		
Messtechnik	18		
Mikroschalter	4		
Muttern	18		
O			
O-Ringe	15		
P			
Pressostate	8		
Programmtimer	5		
Pumpen	8		
PVC-Zulaufschläuche	18		
R			
Rändelschrauben	18		
Regelthermostate	4		
Relais	5		
S			
Schalter und Taster	4		
Schläuche	18		
Schrauben	18		
Schütze	5		
Sechskantmuttern	18		