

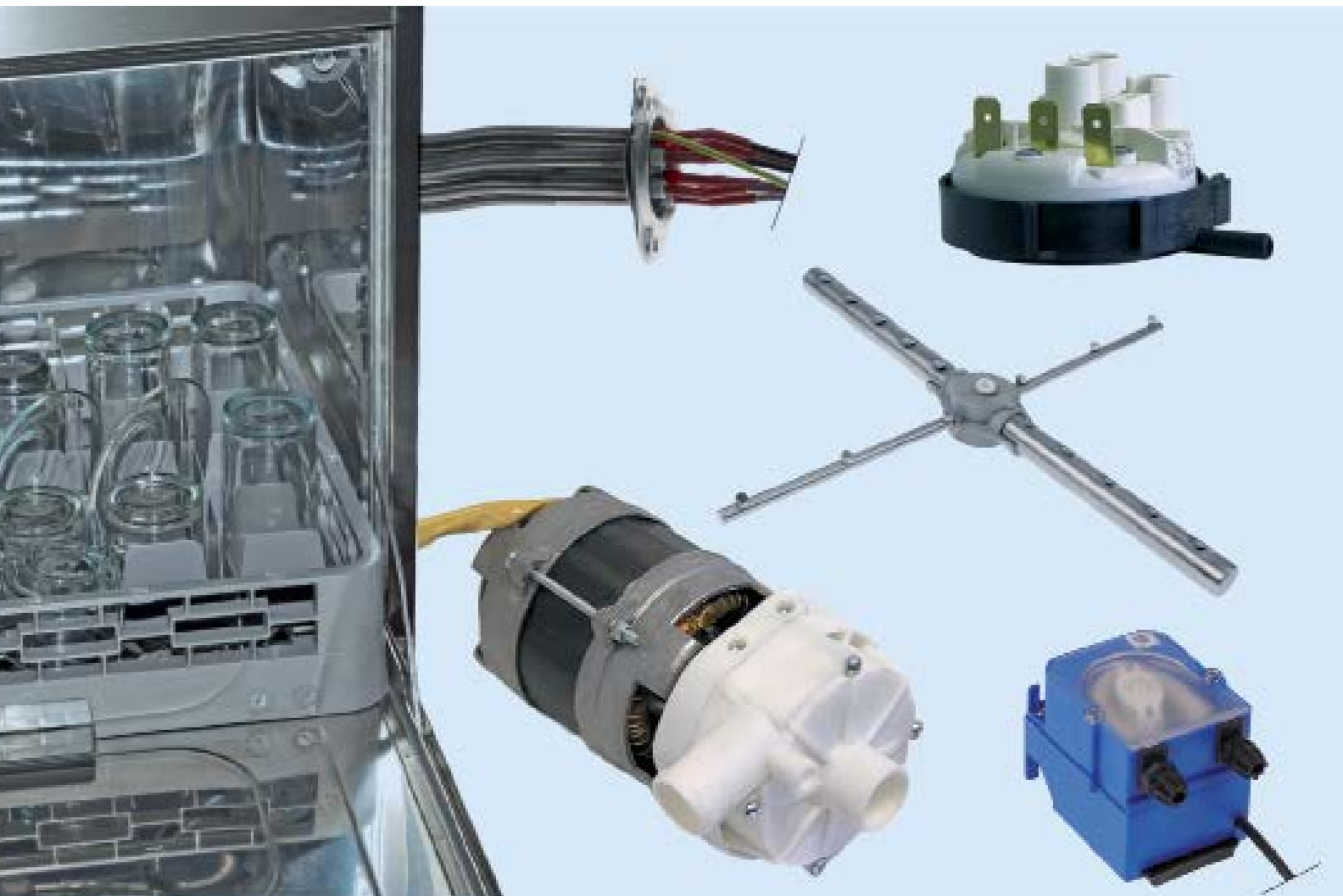

Ricambios para Sistemas de lavado



Repuestos adaptables a

HOBART

2018

Encuentre nuestra gama siempre actualizada en la tienda online de GEV



resistencias

resistencias secas para lavavajillas



código	420180	referencia	229189-26
descripción	resistencia 1220W 254V espirales 1 L 425mm An 65mm tubo ø 8.4mm empalme M4 resistencia seca brida de empalme longitud brida 81mm anchura brida 28mm agujero ø 6.6mm		



código	420179	referencia	229189-22
descripción	resistencia 1830W 254V espirales 1 L 425mm An 65mm tubo ø 8.4mm empalme M4 resistencia seca brida de empalme longitud brida 81mm anchura brida 28mm agujero ø 6.6mm		
Para modelos:	CR-F		



código	420178	referencia	229189-23
descripción	resistencia 2440W 254V espirales 1 L 425mm An 65mm tubo ø 8.4mm empalme M4 resistencia seca brida de empalme longitud brida 81mm anchura brida 28mm agujero ø 6.6mm		
Para modelos:	FTX		

resistencias de inmersión

brida 3 orificios ø 47,5mm

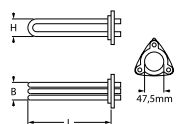

código	420302	referencia	01-240761-001 01-240761-002 01-240761-1 240761-2
---------------	--------	-------------------	---

descripción	resistencia 6000W 240V montaje ø 47.5mm espirales 3 L 325mm An 33mm H 37mm casquillo portasondas 1 ø casquillo portasondas 5mm longitud casquillo portasondas 140mm casquillo termostato centrado, no ajustado tubo ø 8.3mm dist. del agujero 62mm agujero ø 10mm empalme conector Faston 6,3mm brida 3 orificios resistencia de inmersión		
--------------------	--	--	--

Para modelos:	AM-10, AM-11, AM-141, ECOMAX-402, ECOMAX-502, ECOMAX-602-10		
----------------------	---	--	--

accesorios para	420302		
------------------------	--------	--	--

	código	521030	referencia	01-240135-011 01-240135-11 1-240135-11 240135-11
junta tórica Viton espesor 5.34mm int.ø 47mm UE 1 pzs				



código	416240	referencia	139321-1031
descripción	resistencia 6545W 230/400V montaje ø 48mm espirales 3 L 355mm An 31mm H 37mm casquillo portasondas 1 ø casquillo portasondas 7mm longitud casquillo portasondas 175mm casquillo termostato arriba centrado no ajustado tubo ø 6.5mm dist. del agujero 63mm agujero ø 10mm empalme M4 brida 3 orificios resistencia de inmersión		

accesorios para	416240		
------------------------	--------	--	--

	código	510408	referencia	—
junta tórica EPDM espesor 5.34mm int.ø 47mm UE 1 pzs				

	código	510562	referencia	—
junta tórica silicona espesor 5.34mm int.ø 47mm UE 1 pzs				



código	419005	referencia	01-240135-002 01-240135-2 02-240135-001
---------------	--------	-------------------	---

descripción	resistencia 7260W 250V montaje ø 47.5mm espirales 3 L 375mm An 31mm H 35mm casquillo portasondas 1 ø casquillo portasondas 5mm longitud casquillo portasondas 220mm casquillo termostato centrado, no ajustado tubo ø 8.5mm empalme conector Faston 6,3mm brida 3 orificios resistencia de inmersión		
--------------------	--	--	--

Para modelos:	AM900-10N, AM900-90, AMS900-10N, AMX, AMX-10HL, AMX-90, AMXR, AMXS, AMXT, AMXTS, AMXX, AMXXR, AMXXS, AUP, AUP-90, AUPS, AUXX, AUXXL-11N, AUXXLS-11N, AUXXR, AUXXS, AUXXT, AUXXTS, ECOMAX-602-11, ECOMAX-602S-11, ECOMAX-612-10, ECOMAX-612S-10, FP, FX, FX-McDonalds, GP, GX		
----------------------	--	--	--

accesorios para	419005		
------------------------	--------	--	--

	código	510408	referencia	—
junta tórica EPDM espesor 5.34mm int.ø 47mm UE 1 pzs				



código	415668	referencia	139221-246 139321-246 371450-13
---------------	--------	-------------------	---------------------------------------

descripción	resistencia 2625W 230V montaje ø 47.5mm espirales 1 L 190mm An 41mm H 54mm casquillo portasondas 1 ø casquillo portasondas 7mm longitud casquillo portasondas 170mm casquillo termostato descentrado, no ceñido tubo ø 6.3mm dist. del agujero 62mm agujero ø 8mm empalme M4 brida 3 orificios resistencia de inmersión		
--------------------	---	--	--

Para modelos:	GE-400, GF-60, GF-60S, GW-600, GW-600S, GW-601, GW-601S		
----------------------	---	--	--

repuestos para	415668		
-----------------------	--------	--	--

	código	510408	referencia	—
junta tórica EPDM espesor 5.34mm int.ø 47mm UE 1 pzs				

Continúa en la página siguiente

accesorios para	415668			
	código	510562	referencia	—
	junta tórica silicona espesor 5.34mm int.ø 47mm UE 1 pzs			

con brida de presión 50 x 26mm

grupo 1

				
1				
código	420462	referencia	01-240247-001 01-240247-1 01-515292-001 01-515292-1 01-515292-101	
descripción	kit de servicio 975W 250V brida 26,5x50mm L 168mm An 32mm espirales 1 tubo ø 8.5mm H 35mm con accesorios			
Para modelos:	FP, FX, FX-McDonalds, GP, GX			

				
1				
código	420071	referencia	01-240766-001 01-240766-1 01-240766-101	
descripción	resistencia 2000W 240V espirales 1 brida 50x26mm L 320mm An 36mm Hmm brida de presión empalme conector Faston 6,3mm tubo ø 8.6mm resistencia de inmersión			
Para modelos:	ECOMAX-402, ECOMAX-502			
accesorios para	420071			
	código	510387	referencia	—
	junta L 46mm An 22mm ømm EPDM para resistencia para brida 50x26mm			

				
1				
código	416292	referencia	324187-2	
descripción	resistencia 2700W 230V espirales 1 brida 50x26mm L 380mm An 105mm L1 60mm L2 45mm L3 275mm M5 empalme conector Faston 6,3mm tubo ø 8.5mm resistencia de inmersión			
Para modelos:	FE-W, FX, GX			
accesorios para	416292			
	código	510387	referencia	—
	junta L 46mm An 22mm ømm EPDM para resistencia para brida 50x26mm			
	código	510388	referencia	—
	contrabrida ømm dist. del agujeromm ø perforaciónmm L 43mm An 21mm inox para resistencia para brida 50x26mm			

				
1				
código	417517	referencia	00-883423-001 883423-1	
descripción	resistencia 3000W 254V espirales 1 brida 50x26mm L 420mm An 70mm L1 58mm L2 70mm L3 320mm brida de presión empalme conector Faston 6,3mm horizontal tubo ø 8.5mm resistencia de inmersión			
Para modelos:	AM-10, AM-11, AM-141, AM900-10N, AM900-90, AMS900-10N, AMX, AMX-10HL, AMX-90, AMXR, AMXS, AMXT, AMXTS, AMXX, AMXXR, AMXXS, AUP, AUP-90, AUPS, AUXX, AUXXL-11N, AUXXLS-11N, AUXXR, AUXXS, AUXXT, AUXXTS, ECOMAX-602-10, ECOMAX-602-11, ECOMAX-602S-11, ECOMAX-612-10, ECOMAX-612S-10			

				
1				
código	416293	referencia	00-231982-009 231982-9	
descripción	resistencia 610W 254V espirales 1 brida 50x26mm L 370mm An 120mm L1 40mm L2 70mm L3 260mm brida de presión empalme 6.5 tubo ø 8.5mm resistencia de inmersión			
Para modelos:	AMX, AMX-E, AMX-ER, AMX-R, AUX, AUX_, AUX-E, AUX-ER, AUX-R, FE, FX, GX, HE, HE600-HL, HE-P, HX, HX-30, HX-30E, HX-30ES, HX-30S, HX-40, HX-40E, HX-40ES, HX-40S, HX-60-EHL, HX-E, HX-ES, HX-S, UXD-30			
accesorios para	416293			
	código	510387	referencia	—
	junta L 46mm An 22mm ømm EPDM para resistencia para brida 50x26mm			
	código	510388	referencia	—
	contrabrida ømm dist. del agujeromm ø perforaciónmm L 43mm An 21mm inox para resistencia para brida 50x26mm			

				
1				
código	416294	referencia	231982-10	
descripción	resistencia 610W 440V espirales 1 brida 50x26mm L 365mm An 120mm L1 35mm L2 60mm L3 270mm brida de presión empalme conector Faston 6,3mm tubo ø 8.5mm resistencia de inmersión			
Para modelos:	AMX, AMX-E, AMX-ER, AMX-R, AUX, AUX_, AUX-E, AUX-ER, AUX-R, FX, GX, HX, HX-30, HX-30E, HX-30ES, HX-30S, HX-40, HX-40E, HX-40ES, HX-40S, HX-E, HX-ES, HX-S			
accesorios para	416294			
	código	510387	referencia	—
	junta L 46mm An 22mm ømm EPDM para resistencia para brida 50x26mm			
	código	510388	referencia	—
	contrabrida ømm dist. del agujeromm ø perforaciónmm L 43mm An 21mm inox para resistencia para brida 50x26mm			

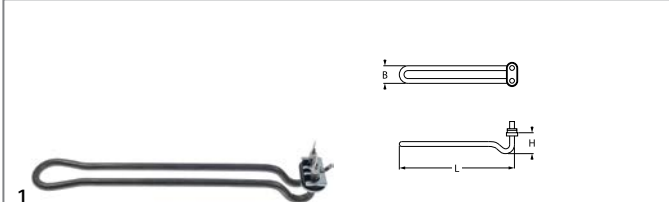

código	420538	referencia	E230102
descripción	resistencia 1600W 230V espirales 1 brida 50x26mm L 305mm An 47mm H 25mm tubo ø 8.5mm empalme F6,3		



código	416234	referencia	139321-719	
descripción	resistencia 600W 230V espirales 1 brida 50x26mm L 160mm An 45mm H 27mm tubo ø 8.8mm empalme conector Faston 6,3mm longitud de empalme 40mm resistencia de inmersión brida de presión			
Para modelos:	CLG-25			
accesorios para	416234			
	código	510387	referencia	—
	junta L 46mm An 22mm ømm EPDM para resistencia para brida 50x26mm			
	código	510388	referencia	—
	contrabrida ømm dist. del agujeromm ø perforaciónmm L 43mm An 21mm inox para resistencia para brida 50x26mm			

con brida de expansión 40 x 16mm

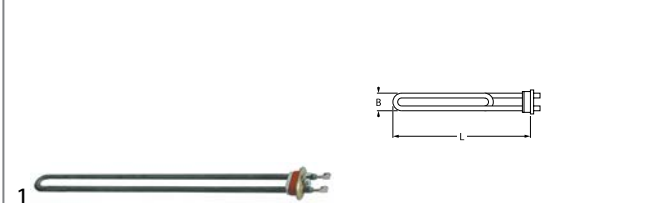

código	416283	referencia	324646-1
descripción	resistencia 1830W 254V brida 40x16mm L 385mm An 36mm empalme conector Faston 6,3mm espirales 1 tubo ø 8.5mm resistencia de inmersión brida de expansión		
Para modelos:	FE, FE-W, FX, GX, HE, HE600-HL, HE-P, HX-60-EHL		

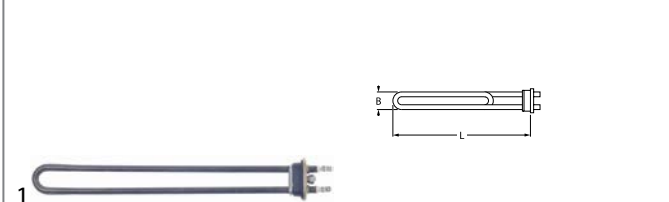

código	420353	referencia	227953-1
descripción	resistencia 2000W 220V brida 40x16mm L 335mm An 39mm empalme conector Faston 6,3mm espirales 1 tubo ø 8.4mm resistencia de inmersión brida de presión distancia de sujeción 24mm		
Para modelos:	CM1E, FM-30, FM-30U, FM-400H, FM-400U, FM-500, FM-500H, UW-55, WM2E		

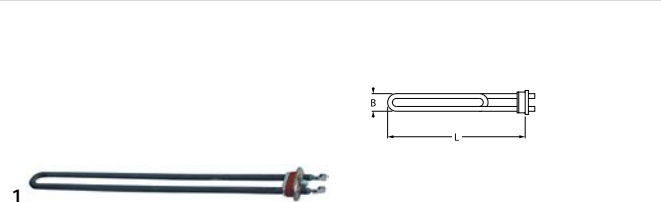

código	416284	referencia	324646-2
descripción	resistencia 2440W 254V brida 40x16mm L 402mm An 34mm empalme conector Faston 6,3mm espirales 1 tubo ø 8.5mm resistencia de inmersión brida de expansión		
Para modelos:	FE, FE-W, FX, GX, HE, HE600-HL, HE-P, HX-60-EHL		

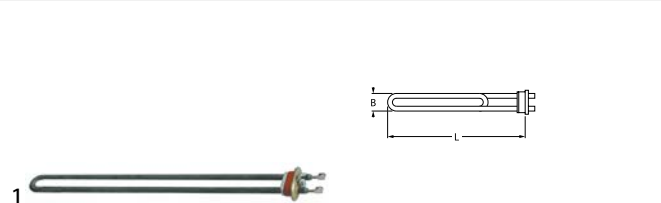

código	416388	referencia	324646-4 D324646-4	
descripción	resistencia 3000W 230V brida 40x16mm L 410mm An 33mm empalme conector Faston 6,3mm espirales 1 tubo ø 8.5mm resistencia de inmersión brida de expansión			
Para modelos:	FE, FE-W, FX, GX, HE, HE600-HL, HE-P, HX-60-EHL			
repuestos para	416388			
	código	416464	referencia	—
	resistencia 2000W 230V L 600mm An 572mm rosca 1/4" distancia de sujeción 563mm longitud de empalme 45mm tubo ø 8.6mm longitud del cable 643mm espirales 1 resistencia seca sujeción 2 orificios			

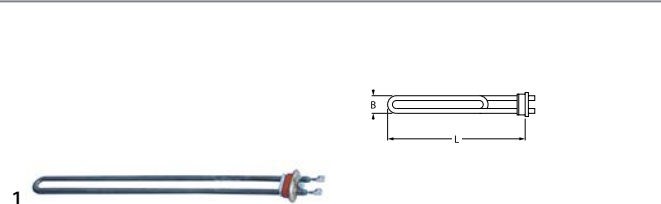

código	416285	referencia	324646-3
descripción	resistencia 3050W 254V brida 40x16mm L 400mm An 36mm empalme conector Faston 6,3mm espirales 1 tubo ø 8.5mm resistencia de inmersión brida de expansión con fusible de temperatura		
Para modelos:	FE, FE-W, FX, GX, HE, HE600-HL, HE-P, HX-60-EHL		

con brida de expansión 70 x 18mm





código	416287	referencia	324644-2
descripción	resistencia 2000W 230V espirales 1 brida 70x18mm L 388mm An 64mm empalme conector Faston 6,3mm tubo ø 8.5mm resistencia de inmersión brida de expansión		
Para modelos:	AM-700, CR-F, ECOMAX-600, ECW, UX, UX-30, UX-30B, UX-30E, UX-30EB, UX-30EH, UX-30ES, UX-30ESB, UX-30ESH, UX-30H, UX-30-McDonalds, UX-30S, UX-30SB, UX-30SH, UX-60, UX-60B, UX-60E, UX-60EB, UX-60EH, UX-60EHB, UX-60H, UX-60HB, UXL, UXLS, UXS		



			
código	416239	referencia	230100
descripción	resistencia 2600W 230V espirales 1 brida 70x18mm L 270mm An 65mm empalme conector Faston 6,3mm tubo ø 8.5mm resistencia de inmersión brida de expansión		
Para modelos:	ECOMAX-400-12, ECOMAX-400S-12		

			
código	416286	referencia	324644-1
descripción	resistencia 3000W 230V espirales 1 brida 70x18mm L 408mm An 65mm empalme conector Faston 6,3mm tubo ø 8.5mm resistencia de inmersión brida de expansión longitud de empalme 18mm		
Para modelos:	AMX, AMX-E, AMX-ER, AMX-R, AUX, AUX-E, AUX-ER, AUX-R, CR-F, ECOMAX-700, ECW, UX, UX-30, UX-30B, UX-30E, UX-30EB, UX-30EH, UX-30ES, UX-30ESB, UX-30ESH, UX-30H, UX-30-McDonalds, UX-30S, UX-30SB, UX-30SH, UX-60, UX-60B, UX-60E, UX-60EB, UX-60EH, UX-60EHB, UX-60H, UX-60HB, UXL, Uxls, Uxs, Uxt, Uxth, Uxthl, Uxthls, Uxths, Uxthl, Uxthlh, Uxthls, Uxthls, Uxthls		

			
código	419162	referencia	775464-002 775464-2
descripción	resistencia 3000W 240V espirales 1 brida 70x18mm L 318mm An 65mm empalme conector Faston 6,3mm tubo ø 8.5mm resistencia de inmersión brida de expansión longitud de empalme 24mm PT ø 10mm con sonda de temperatura		
Para modelos:	AM900, AMS900, FX, GC, GC11, GC12, GC31, GC32, GC41, GC42, GX		
repuestos para	419162		
	código	referencia	402906 775494-1
	 sensor de temperatura NTC 10kOhm cable sonda -40 a +110°C cable°C empalme conector Faston 4,8mm rosca bulbo ø10x30mm longitud de cable m		

			
código	416288	referencia	00-324637-002 324637-... 324637-2
descripción	resistencia 4000W 230V espirales 2 brida 70x18mm L 410mm An 63mm empalme F2,8mm / F6,3mm tubo ø 8.5mm resistencia de inmersión brida de expansión longitud de empalme 30mm		
Para modelos:	CR-F, UX-30, UX-30B, UX-30E, UX-30EB, UX-30ES, UX-30ESB, UX-30S, UX-30SB, UX-60, UX-60B, UX-60E, UX-60EB, UX-60EH, UX-60EHB, UX-60H, UX-60HB		





			
código	416289	referencia	00-324637-001 324637-... 324637-1
descripción	resistencia 6000W 230V espirales 2 brida 70x18mm L 417mm An 65mm empalme conector Faston 6,3mm tubo ø 9mm resistencia de inmersión brida de expansión longitud de empalme 35mm		
Para modelos:	AMX, AMX-E, AMX-ER, AMX-R, AMXX-1300, AMXXT, AUX, AUX-E, AUX-ER, AUX-R, AUXX-1300, AUXXL, AUXXT, CR-F, ECW, UX-60, UX-60B, UX-60E, UX-60EB, UX-60EH, UX-60EHB, UX-60H, UX-60HB, UXT, Uxth, Uxthl, Uxthls, Uxths, Uxthl, Uxthlh, Uxthls, Uxthls, Uxthls		

			
código	419139	referencia	775464-1
descripción	resistencia 6000W 240V espirales 2 brida 70x18mm L 315mm An 62mm empalme conector Faston 6,3mm tubo ø 8.5mm		
Para modelos:	AM900, AMS900, FX, GC, GC11, GC12, GC31, GC32, GC41, GC42, GX		





			
código	419026	referencia	324637-... 324637-3
descripción	resistencia 6100W 254V espirales 2 brida 70x18mm L 420mm An 63mm empalme F6,3 tubo ø 8.5mm resistencia de inmersión brida de expansión longitud de empalme 30mm		
Para modelos:	AM-700, AMX-900, AMXR-900, AMXS-900, AMXX-1300, AMXXR-1300, AMXXS-1300, AMXXT, AUXX-1300, AUXXL, AUXXR-1300, AUXXS-1300, AUXXT, CN, CNA, CNB, CNR, CR, CR-F, CSA, ECOMAX-600, ECOMAX-650, ECOMAX-800, ECW, FTN, FTX, UX-30, UX-30B, UX-30E, UX-30EB, UX-30ES, UX-30ESB, UX-30S, UX-30SB, UX-60, UX-60B, UX-60E, UX-60EB, UX-60EH, UX-60EHB, UX-60H, UX-60HB		

			
código	416243	referencia	139321-463
descripción	resistencia 7600W 230V espirales 3 brida 70x18mm L 390mm An 60mm H 13mm empalme conector Faston 6,3mm tubo ø 6.3mm resistencia de inmersión brida de expansión INCOLOY-800		
Para modelos:	CHF45, EF-40		



con brida redonda ø 47,5mm

			
código	416295	referencia	226807-1
descripción	resistencia 3000W 230V espirales 3 montaje ø 47.5mm L 185mm An 79mm H 30mm L1 35mm L2 150mm B1 23mm B2 34mm brida redonda empalme conector Faston 6,3mm resistencia de inmersión tubo ø 6.5mm		
Para modelos:	AM-12E, AM-12EC, AM-12EF, AM-12ER, AM-600, AM-600C, AM-600CR, AM-600R, UW-100, UW-105		
accesorios para	416295		
	código	referencia	510408 —
	 junta tórica EPDM espesor 5.34mm int.ø 47mm UE 1 pzs		
	código	referencia	510562 —
	 junta tórica silicona espesor 5.34mm int.ø 47mm UE 1 pzs		
	código	referencia	550002 —
	 estribo de fijación H 10mm L 21mm An 10mm agujero ø 6.5mm para resistencia		





			
1			
código	416296	referencia	170495-2
descripción	resistencia 6000W 230V espirales 3 montaje ø 47.5mm L 230mm An 128mm H 32mm L1 30mm L2 200mm B1 46mm B2 34mm brida redonda empalme conector Faston 6,3mm resistencia de inmersión tubo ø 6.3mm		
Para modelos:	AM-12E, AM-12EC, AM-12EF, AM-12ER, AM-600, AM-600C, AM-600CR, AM-600R, UW-105		
accesorios para	416296		
	código	510408	referencia —
	junta tórica EPDM espesor 5.34mm int.ø 47mm UE 1 pzs		
	código	510562	referencia —
	junta tórica silicona espesor 5.34mm int.ø 47mm UE 1 pzs		
	código	550002	referencia —
	estribo de fijación H 10mm L 21mm An 10mm agujero ø 6.5mm para resistencia		

			
1			
código	416297	referencia	173649-1 173649-2
descripción	resistencia 7500W 230V espirales 3 montaje ø 47.5mm L 230mm An 123mm H 31mm L1 32mm L2 198mm B1 45mm B2 35mm brida redonda empalme conector Faston 6,3mm resistencia de inmersión tubo ø 6.5mm		
Para modelos:	AM-600, AM-600C, AM-600CR, AM-600R, UW-105		
accesorios para	416297		
	código	510408	referencia —
	junta tórica EPDM espesor 5.34mm int.ø 47mm UE 1 pzs		
	código	510562	referencia —
	junta tórica silicona espesor 5.34mm int.ø 47mm UE 1 pzs		
	código	550002	referencia —
	estribo de fijación H 10mm L 21mm An 10mm agujero ø 6.5mm para resistencia		



			
1			
código	416298	referencia	226506-1 226506-2
descripción	resistencia 9000W 230V espirales 3 montaje ø 47.5mm L 230mm An 120mm H 34mm L1 25mm L2 205mm B1 42mm B2 36mm brida redonda empalme conector Faston 6,3mm resistencia de inmersión tubo ø 8.5mm longitud de empalme 44mm		
Para modelos:	AM-12E, AM-12EC, AM-12EF, AM-12ER, AM-600, AM-600C, AM-600CR, AM-600R, UW-100, UW-105, UW-135, UW-135H		
accesorios para	416298		
	código	510408	referencia —
	junta tórica EPDM espesor 5.34mm int.ø 47mm UE 1 pzs		
	código	510562	referencia —
	junta tórica silicona espesor 5.34mm int.ø 47mm UE 1 pzs		

accesorios para	416298		
	código	550002	referencia —
	estribo de fijación H 10mm L 21mm An 10mm agujero ø 6.5mm para resistencia		



con brida redonda otros			
			
1			
código	419183	referencia	323949-1
descripción	resistencia 7320W 254V L 355mm An 35mm H 35mm espirales 3 brida redonda empalme F6,3 resistencia de inmersión tubo ø 8.5mm		
Para modelos:	EWS-S, UXT, UXTH, UXTHL, UXTHLS, UXTHS, UXTL, UXTLH, UXTLHS, UXTLS, UXTS		
accesorios para	419183		
	código	510409	referencia 00-276903-053 00-67500-016 00-67500-118 276903-53 670500-118 67500-118 67500-16
	junta tórica EPDM espesor 5.34mm int.ø 56.52mm UE 1 pzs		



			
1			
código	419103	referencia	00-229148-001 229148-1 229148-1 (230V) 229148-2
descripción	resistencia 9000W 240V L 520mm An 47mm H 41mm espirales 3 brida ø 71mm rosca de sujeción M10 empalme M4 tubo ø 8.5mm longitud de empalme 21mm		
Para modelos:	CR-F, CX, ECW, FTX, FUX, UW-135, UW-135H, UWX		
accesorios para	419103		
	código	510409	referencia 00-276903-053 00-67500-016 00-67500-118 276903-53 670500-118 67500-118 67500-16
	junta tórica EPDM espesor 5.34mm int.ø 56.52mm UE 1 pzs		





bridas especiales			
			
1			
código	420351	referencia	166151-1 166151-2 38658-1
descripción	resistencia 10000W 220/380V espirales 3 L 360mm An 127mm longitud brida 90mm anchura brida 90mm empalme brida 4 orificios sistemas de lavado tubo ø 8.5mm H 42mm		
Para modelos:	UW-120, UW-200		





otros			
			
código	416299	referencia	324206-3 324206-6
descripción	resistencia 2200W 230V espirales 1 L 420mm An 45mm H 35mm casquillo portasondas 1 ø casquillo portasondas 5mm longitud casquillo portasondas 365mm tubo ø 8.5mm dist. del agujero 45mm agujero ø 10mm longitud de empalme 25mm brida 4 orificios resistencia de inmersión anchura brida 63mm longitud brida 63mm		
Para modelos:	FX, GX, HX, HX-30, HX-30E, HX-30ES, HX-30S, HX-40, HX-40E, HX-40ES, HX-40S, HX-E, HX-ES, HX-S		
accesorios para	416299		
	código	505180	referencia 00-233982-001 00-276903-021 233982-1 276903-21
junta tórica EPDM espesor 3.53mm int.ø 47.22mm UE 1 pzs			

			
código	416300	referencia	324206-4
descripción	resistencia 4500W 230V espirales 3 L 413mm An 45mm H 45mm casquillo portasondas 1 ø casquillo portasondas 5mm longitud casquillo portasondas 377mm tubo ø 8.5mm dist. del agujero 45mm agujero ø 10mm empalme M4 brida 4 orificios resistencia de inmersión anchura brida 63.5mm longitud brida 63.5mm		
Para modelos:	FX, GX, HX, HX-30, HX-30E, HX-30ES, HX-30S, HX-40, HX-40E, HX-40ES, HX-40S, HX-E, HX-ES, HX-S		

			
código	416290	referencia	324206-5
descripción	resistencia 7500W 230V espirales 3 montaje ø 47.5mm L 415mm An 44mm H 44mm casquillo portasondas 1 ø casquillo portasondas 5mm longitud casquillo portasondas 369mm tubo ø 8.5mm dist. del agujero 46mm agujero ø 10mm empalme M4 brida 4 orificios resistencia de inmersión anchura brida 63.5mm longitud brida 63.5mm		
Para modelos:	FX, GX, HX, HX-30, HX-30E, HX-30ES, HX-30S, HX-40, HX-40E, HX-40ES, HX-40S, HX-E, HX-ES, HX-S		
accesorios para	416290		
	código	505180	referencia 00-233982-001 00-276903-021 233982-1 276903-21
junta tórica EPDM espesor 3.53mm int.ø 47.22mm UE 1 pzs			

			
código	416291	referencia	324206-7 324206-8
descripción	resistencia 9000W 230V espirales 3 L 407mm An 42mm H 43mm casquillo portasondas 1 ø casquillo portasondas 5mm longitud casquillo portasondas 370mm casquillo termostato descentrado, no ceñido dist. del agujero 45mm agujero ø 10mm empalme M4 brida 4 orificios resistencia de inmersión anchura brida 63.5mm longitud brida 63.5mm		
Para modelos:	FX, GX, HX, HX-30, HX-30E, HX-30ES, HX-30S, HX-40, HX-40E, HX-40ES, HX-40S, HX-E, HX-ES, HX-S		
accesorios para	416291		
	código	505180	referencia 00-233982-001 00-276903-021 233982-1 276903-21
junta tórica EPDM espesor 3.53mm int.ø 47.22mm UE 1 pzs			

			
código	415010	referencia	139321203 371450205
descripción	resistencia 2000W 230V espirales 1 L 260mm An 125mm H 20mm L1 110mm L2 150mm B1 42mm B2 83mm rosca M10x1 distancia de sujeción 70mm tubo ø 6.5mm empalme M4 resistencia de inmersión sujeción 2 orificios		
Para modelos:	GE-400, GW-600, GW-600S, GW-601, GW-601S		
repuestos para	415010		
	código	510416	referencia —
junta plana fibra ø ext. 19mm int.ø 10.5mm espesor 1.5mm para rosca M10 UE 1 pzs			
accesorios para	415010		
	código	504306	referencia —
junta fibra ø ext. 16mm int.ø 10mm espesor 2mm UE 1 pzs			
	código	510893	referencia —
junta tórica EPDM espesor 2.62mm int.ø 9.92mm UE 1 pzs			
	código	520231	referencia —
tuerca rosca M10x1 H 6mm EC 14 acero zincado UE 1 pzs			
	código	521103	referencia —
tuerca rosca M4 H 3mm EC 7 latón UE 20 pzs			
	código	521104	referencia —
arandela int.ø 4.3mm ø ext. 8mm espesor 0.5mm latón UE 20 pzs para rosca M4			
	código	521129	referencia —
tuerca rosca M10 H 6mm inox EC 17 UE 1 pzs DIN/ISO DIN 439			
	código	560111	referencia —
arandela int.ø 4.3mm ø ext. 9mm espesor 0.8mm inox UE 20 pzs DIN 125A para rosca M4			
	código	560131	referencia —
tuerca hexagonal rosca M4 H 3.2mm EC 7 inox DIN/ISO DIN 934 / ISO 4032/8673 UE 20 pzs			

			
código	415665	referencia	E230086
descripción	resistencia 2750/3250W 220/240V espirales 1 L 380mm An 110mm H 30mm rosca M10x1 distancia de sujeción 75mm tubo ø 6.5mm empalme M4 resistencia de inmersión sujeción 2 orificios		
repuestos para	415665		
	código	510893	referencia —
junta tórica EPDM espesor 2.62mm int.ø 9.92mm UE 1 pzs			
accesorios para	415665		
	código	510416	referencia —
junta plana fibra ø ext. 19mm int.ø 10.5mm espesor 1.5mm para rosca M10 UE 1 pzs			
	código	520231	referencia —
tuerca rosca M10x1 H 6mm EC 14 acero zincado UE 1 pzs			

Continúa en la página siguiente



accesorios para 415665	
	código 520876 referencia 139321-727 tapa de protección para resistencia \varnothing 11.5mm H 32mm An 25mm plástico
	código 521103 referencia — tuerca rosca M4 H 3mm EC 7 latón UE 20 pzs
	código 521104 referencia — arandela int. \varnothing 4.3mm \varnothing ext. 8mm espesor 0.5mm latón UE 20 pzs para rosca M4
	código 521129 referencia — tuerca rosca M10 H 6mm inox EC 17 UE 1 pzs DIN/ISO DIN 439
	código 560111 referencia — arandela int. \varnothing 4.3mm \varnothing ext. 9mm espesor 0.8mm inox UE 20 pzs DIN 125A para rosca M4
	código 560131 referencia — tuerca hexagonal rosca M4 H 3.2mm EC 7 inox DIN/ISO DIN 934 / ISO 4032/8673 UE 20 pzs

resistencias planas

	1		
código	420355	referencia	775763-1
descripción	resistencia plana L 288mm An 87mm 305W 240V T máx°C silicona longitud del cable 800mm espesor 1mm empalme Faston 6,3mm		
Para modelos:	GC, GC11, GC12, GC31, GC32		

	1		
código	420299	referencia	898 126-1
descripción	resistencia plana L 360mm An 95mm 545W 230V T máx°C silicona longitud del cable 1750mm espesor 1mm		
Para modelos:	AM-700, AM900, AMS900, AMX-900, AMXR-900, AMXS-900, AMXX-1300, AMXXR-1300, AMXXS-1300, AMXXT, AUXX-1300, AUXXL, AUXXR-1300, AUXXS-1300, AUXXT, ECOMAX-650		

	1		
código	420475	referencia	775575-1
descripción	resistencia plana L 370mm An 95mm 390W 230V T máx°C longitud del cable 790mm		
Para modelos:	FX, GX		

accesorios

anillos de junta

juntas tóricas

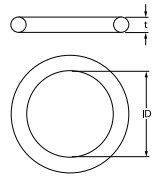
	1		
código	510563	referencia	276903-9
descripción	junta tórica EPDM espesor 3mm int. \varnothing 28mm UE 1 pzs		
Para modelos:	AM-12E, AM-12EC, AM-12EF, AM-12ER, FUX, UW-100, UW-105, UW-120, UW-125, UW-135, UW-135H, UW-200, UW-205		

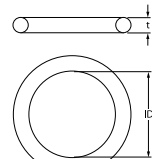
	1		
código	505092	referencia	233982-6
descripción	junta tórica EPDM espesor 5.34mm int. \varnothing 43.82mm UE 1 pzs		
Para modelos:	CS-0612E-A, CS-1012E-A, CS-2012E-A, CSD-0612E-A, CSD-1012E-A, CSD-2012E-A		

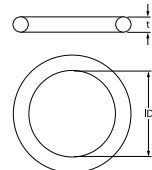
	1		
código	510409	referencia	00-276903-053 00-67500-016 00-67500-118 276903-53 670500-118 67500-16
descripción	junta tórica EPDM espesor 5.34mm int. \varnothing 56.52mm UE 1 pzs		
Para modelos:	CR-F, CX, ECW, EWB-S, FTN, FTT, FTX, FUX, ML-104674, ML-104683, ML-104686, UW-135, UW-135H, UWX, UX-60, UX-60B, UX-60E, UX-60EB, UX-60EH, UX-60EHB, UX-60H, UX-60HB, UXT, UXTH, UXTHL, UXTHLS, UXTHS, UXTL, UXTLH, UXTLHS, UXTLS, UXTS, V1401		

juntas para bridas

	1		
código	511655	referencia	174529-1
descripción	junta fibra L 64mm An 64mm espesor 2.3mm agujero \varnothing 9mm dist. del agujero 45mm 4 orificios int. \varnothing 46mm		
Para modelos:	102-G, 104G, 202-G, 204G, 2226, 2227, 302-G, 304G, UW-135, UW-135H		

termostatos

termostatos de superficie

termostatos de superficie de seguridad



código	390233	referencia	139321-17 139321-923 139321-934 371450-17
descripción	termómetro de superficie de seguridad dist. del agujero 24mm temp. desconexión 110°C 1NC 1 polos 16A empalme F6,3 sujeción 2 orificios sin soporte		
Para modelos:	CHF45, CHH-50, CHH-60D, CHH-70D, CLG-25, EF-40, EH-60, EH-70, GE-400, GF-60, GF-60S		
accesorios para	390233		
	código	504736	referencia —
	soporte para termostato de contacto		
	código	550388	referencia —
	soporte para termostato de contacto distancia de sujeción 24.5mm fijación ø 3.8		



código	390462	referencia	226504
descripción	termómetro de superficie de seguridad dist. del agujeromm temp. desconexión 105°C 1NC 1 polos 10A empalme F6,3 sujeción 1 orificio		
Para modelos:	AM-12E, AM-12EC, AM-12EF, AM-12ER, AM-600, AM-600C, AM-600CR, AM-600R, CM1E, FM-30, FM-30U, FM-400H, FM-400U, FM-500, FM-500H, UW-100, UW-105, UW-135, UW-135H, UW-55, WM2E		
accesorios para	390462		
	código	550388	referencia —
	soporte para termostato de contacto distancia de sujeción 24.5mm fijación ø 3.8		



código	390318	referencia	139321-721
descripción	termómetro de superficie de seguridad temp. desconexión 95°C 1 polos sujeción 2 orificios		
Para modelos:	CLG-25		

termostatos de superficie



código	390504	referencia	236052 E236052
descripción	termostato de contacto dist. del agujero 23.8mm temp. desconexión 90°C 1NO 1 polos 16A 250V empalme F6,3 sujeción 2 orificios sonda ø 16mm		

termostatos de control y seguridad

EGO

termostatos de regulación

serie 55.13_



código	390472	referencia	886638
descripción	termóstato T máx 95°C margen de trabajo 27-95°C 1 polos 1NO 16A sonda ø 4mm sonda L 203mm capilar 1230mm aislamiento del capilar 800mm prensaestopas eje ømm eje Lmm posición del eje° posición del eje ángulo de rotación 270°		

termostatos de seguridad

serie 55.13_



código	390471	referencia	227879
descripción	termostato de seguridad temp. desconexión 125°C 1 polos 16A sonda ø 4mm sonda L 128mm capilar 1130mm aislamiento del capilar 800mm prensaestopas bulbo inox		
Para modelos:	CR-F, CX, FX, GX, HX, HX-30, HX-30E, HX-30ES, HX-30S, HX-40, HX-40E, HX-40ES, HX-40S, HX-E, HX-ES, HX-S		



serie 55.33_





código	390470	referencia	378791
descripción	termostato de seguridad temp. desconexión 100°C 3 polos 20A sonda ø 4mm sonda L 231mm capilar 870mm aislamiento del capilar 800mm prensaestopas bulbo inox		
Para modelos:	CDC, CN, CNA, CNB, CNR, CR, CSA, CTC, ECOMAX-700, ECW, FX, GX, UX, UX-30, UX-30B, UX-30E, UX-30EB, UX-30EH, UX-30ES, UX-30ESB, UX-30ESH, UX-30H, UX-30-McDonalds, UX-30S, UX-30SB, UX-30SH, UXL, UXLS, UXS		

CAEM

termostatos de regulación



código	390672	referencia	139321-20 E236042
descripción	termóstato T máx 53°C margen de trabajo ajuste fijo 53°C 1 polos 1CO 16A sonda ø 9.5mm sonda L 30mm capilar 600mm aislamiento del capilar 540mm prensaestopas eje Lmm sonda roscada rosca sonda M14x1		
Para modelos:	GW-600, GW-600S, GW-601, GW-601S		
repuestos para	390672		
	código	510417	referencia —
	junta plana fibra ø ext. 20mm int.ø 14mm espesor 2mm UE 1 pzs		
	código	550261	referencia —
	tuerca rosca M14x1 H 4mm EC 19 inox UE 1 pzs		



código	390686	referencia	236043 E236043
descripción	termóstato T máx 83°C margen de trabajo°C 1 polos 1CO 20A sonda ø 6mm sonda L 90mm capilar 630mm aislamiento del capilar 550mm prensaestopas eje ømm eje Lmm posición del eje ángulo de rotación 270° material de bulbo cobre		
Para modelos:	CLG-25, CLG-25-NA, ECOMAX-500		

interruptores y pulsadores

interruptores/pulsadores basculantes

30x22mm



código	301003	referencia	15243565 F15243565
descripción	interruptor basculante medida de montaje 30x22mm verde 2NO 250V 16A iluminado 0-1 empalme conector Faston 6,3mm temperatura ambiente máx. 125/55°C protección IP65		
accesorios para	301003		
	código	301036	referencia —
	cubierta protectora dimensión interior 30x22mm para interruptor basculante medida de montaje mm		

microinterruptores

accionado por palanca





código	345257	referencia	139321-41
descripción	microinterruptor con manilla 250V 16A 1CO empalme conector Faston 6,3mm L 29mm L1 33mm temperatura ambiente máx. 120°C distancia de sujeción 22mm fuerza de accionamiento: 130g longitud de palanca 31.5mm		
Para modelos:	GW-600, GW-600S, GW-601, GW-601S		



interruptores posicionales

BERNSTEIN

			
1			
código	347237	referencia	302440-1
descripción	interruptor de posición con palanca de rodillo 1NO/1NC		
Para modelos:	UW-135, UW-135H		

			
1			
código	345921	referencia	228795
descripción	interruptor de posición con rueda 1CO 240V 3A L 93mm An 36mm H 33mm protección IP65 fuerza de accionamiento: 1280g unión roscada M20 distancia de sujeción 25mm		
Para modelos:	ACW, AM-12E, AM-12EC, AM-12EF, AM-12ER, AM-12ER, AM-600C, AM-600CR, FM-30, UWX		

			
1			
código	347721	referencia	00-226916-000
descripción	interruptor de posición con rueda de presión 1NO/1NC 240V 3A L 93mm An 36mm H 34mm protección IP65 fuerza de accionamiento: 1200g unión roscada M18 distancia de sujeción 24.5mm		
Para modelos:	AM-600, AM-600C, AM-600CR, AM-600R, FTX, FUX, RRB, UW-100, UW-105		

			
1			
código	345922	referencia	324195 735221-1
descripción	microinterruptor con mando de rodilla 1NO/1NC 240V 3A L 51mm An 26mm H 21mm protección IP30 fuerza de accionamiento: 580g unión roscada distancia de sujeción 15mm AC-15 3A		
Para modelos:	FE, FE-W, FX, GX		

TELEMECANIQUE (EFA)

			
1			
código	347460	referencia	785286-1
descripción	interruptor de posición con rueda 1NO/1NCL 71mm protección IP67		
Para modelos:	CN, CNA, CNB, CNR, CR, CSA, ECOMAX-800		

interruptores de sistema ROLD

			
1			
código	345605	referencia	E208010
descripción	elemento de conmutación 2CO 250V 16A empalme conector Faston 6,3mm		

			
1			
código	346500	referencia	E226080
descripción	portaelementos medida de montaje 28,5x77,5mm negro soporte triple		

			
1			
código	347705	referencia	227061 E227061
descripción	tecla ø 21mm plata con lente edición		
Para modelos:	CLG-25, CLG-25-NA, ECOMAX-400-12, ECOMAX-400S-12, ECO-MAX-500		

			
1			
código	347517	referencia	E207060 E227060
descripción	tecla ø 21mm plata edición		

			
1			
código	345606	referencia	139321-455 E226071
descripción	unidad de pulsador 2CO 250V 16A empalme conector Faston 6,3mm		
Para modelos:	CLG-25		



interruptores de flotador

1

código	348128	referencia	00-896960-000
descripción	interruptor de flotador rosca M16x2 ø 18mm L 65mm longitud del cable 1050mm Kit 1 polos resis.a la temp. -20 a +90°C		

1

código	403081	referencia	102826 229519 ML102826
descripción	interruptor de flotador rosca 1/4" 1NC/1NO ø 12mm L 65mm montaje ø 16mm 230V 0.5A cable longitud del cable 100mm		
Para modelos:	ACW, CN, CNB, CNR, CX, EWB-S, FTN, FTX, FUX, UW-135H, UWX		
repuestos para	403081		
	código	347433	referencia 00-122674 122674
	flotador con imán ø 47mm L 33mm Anmm Hmm PVC para HOBART		

1

código	403914	referencia	271621
descripción	interruptor de flotador rosca 1/4" ø 29mm L 100mm montaje ø 9,5mm cifrado longitud del cable 240mm sonda L 63mm		

flotadores

1

código	347433	referencia	00-122674
descripción	flotador con imán ø 47mm L 33mm Anmm Hmm PVC para HOBART		
Para modelos:	103G, 203G, 2226, 303G, ACW, AM-12E, AM-12EC, AM-12EF, AM-12ER, AM15, AM15F, AM15T, AM-600, AM-600C, AM-600CR, AM-600R, C44A, C44AW, C54A, C64A, CN, CNA, CNB, CNR, CR, CR-F, CSA, CX, ECOMAX-800, EWB-S, FTN, FTT, FTX, FUX, ML-110025, ML-110976, ML-110977, ML-32614, ML-32615, UW-105, UW-135, UW-135H, UWX		
accesorios para	347433		
	código	347927	referencia 00-112467 112467
	soporte para interruptor magnético int.ø 21mm ø ext. 28.5mm		

conmutadores de levas

8 posiciones de conmutación

1

código	347924	referencia	231960-5
descripción	conmutador de levas 8 posiciones de conmutación 13NO secuencia de conmutación 0-1-2-3-4-5-6-7 16A eje ø 6x4,6mm eje L 19mm empalme conector Faston 6,3mm plástico		
Para modelos:	AMX, AMX-E, AMX-ER, AMX-R, AUX, AUX_, AUX-E, AUX-ER, AUX-R, FX, GX, UX-30, UX-30B, UX-30H, UX-30-McDonalds, UX-30S, UX-30SB, UX-30SH, UX-60, UX-60B, UX-60H, UX-60HB, UXD-30		

conmutadores giratorios

KRAUS & NAIMER

conmutadores giratorios

1

código	347506 ¹	referencia	785574-6
descripción	conmutador giratorio 2 0-1 juegos de contactos 5 tipo KG100-DE10F769 400V 100A eje L 52mm L1,L2,L3,N,PE empalme atornillado código 53/000100 designación T104/D-A025		



¹con pomo y símbolo



interruptores magnéticos

1/4"



código	347490	referencia	226282 226282-2
descripción	interruptor magnético rosca 1/4" longitud del cable 2000mm L 62.5mm		
Para modelos:	103G, 203G, 2226, 303G, AM-12E, AM-12EC, AM-12EF, AM-12ER, AM-600, AM-600C, AM-600CR, AM-600R, CNA, CNR, CR, CR-F, CSA, ECOMAX-800, FTT, UW-100, UW-105, UW-135, UW-135H		
accesorios para	347490		
	código	347433	referencia 00-122674 122674
	flotador con imán ø 47mm L 33mm Anmm Hmm PVC para HOBART		
	código	347927	referencia 00-112467 112467
	soporte para interruptor magnético int.ø 21mm ø ext. 28.5mm		
	código	511516	referencia —
	junta tórica EPDM espesor 3.53mm int.ø 20.22mm UE 10 pzs		

29x19mm

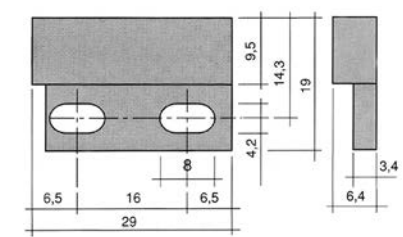

código	345117	referencia	844951-2
descripción	interruptor magnético L 28.5mm An 19mm 1NO 250V 0.04A P máx. 10W empalme cable longitud del cable 1000mm		

36x13mm

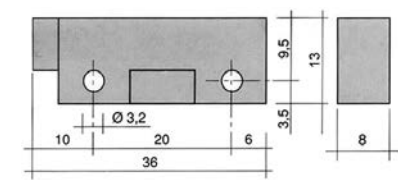
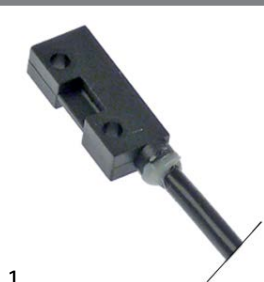

código	345118	referencia	139321-344 139321-586 139321-919
descripción	interruptor magnético L 36mm An 13mm 1NO 250V 1A P máx. 50W empalme cable longitud del cable 980mm		
Para modelos:	CHF45, CHH-50, CHH-60D, CHH-70D, CLG-25, EF-40, EH-60, EH-70, GE-400, GF-60, GF-60S, GW-600, GW-600S, GW-601, GW-601S, UX, UXL, UXLS, UXS, UXT, UXTH, UXTHL, UXTHLS, UXTHS, UXTL, UXTLH, UXTLHS, UXTLS, UXTS		
accesorios para	345118		
	código	345399	referencia —
	imán ø 3.3mm L 40mm H 8mm An 13mm dist. del agujero 30mm M3		

con conexión codificado

50x19mm

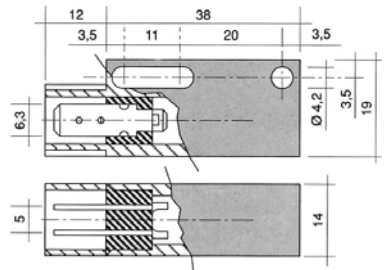

código	345821	referencia	775491-1
descripción	interruptor magnético L 50mm An 19mm 1NO 250V 1A P máx. 50W empalme conector Faston 6,3mm		
Para modelos:	AM-700, AM900, AMS900, AMX, AMX-900, AMX-E, AMX-ER, AMX-R, AMXR-900, AMXS-900, AMXX-1300, AMXXR-1300, AMXXS-1300, AMXXT, AUX, AUX-E, AUX-ER, AUX-R, AUXX-1300, AUXXL, AUXXR-1300, AUXXS-1300, AUXXT, CNA, CNR, ECOMAX-650, ECOMAX-700, FX, GX, UX-30, UX-30B, UX-30E, UX-30EB, UX-30EH, UX-30ES, UX-30ESB, UX-30ESH, UX-30H, UX-30-McDonalds, UX-30S, UX-30SB, UX-30SH, UXD-30		
accesorios para	345821		
	código	519049	referencia —
	imán ø 6mm L 63mm H 10.7mm An 18.8mm dist. del agujero 52mm M2 agujero ø 2mm		



80x30mm



código	347925	referencia	229517
descripción	interruptor magnético L 80mm An 30mm 1NO 250V 0.2A P máx. 100W empalme cable longitud del cable 1300mm		
Para modelos:	CN, CNB, CSA, ECOMAX-800, ECW, FTN, FTT, HX, HX-30, HX-30S, HX-40, HX-40S, HX-E, HX-ES, HX-S, UW-120, UW-200, UX-60EH, UX-60EHB, UX-60H, UX-60HB		



código	345918	referencia	229517-2
descripción	interruptor magnético L 80mm An 30mm 1NO 250V 0.2A P máx. 100W empalme cable longitud del cable 4500mm		
Para modelos:	ECOMAX-600, ECOMAX-700, FTX, FUX, HE, HE600-HL, HE-P, HX-60-EHL		

código	345920	referencia	297980-4
descripción	interruptor magnético L 80mm An 30mm 1NO 250V 3A empalme cable 100W		
Para modelos:	AMX, AMX-E, AMX-ER, AMX-R, AUX, AUX_, AUX-E, AUX-ER, AUX-R, UX-30, UX-30B, UX-30E, UX-30EB, UX-30EH, UX-30ES, UX-30ESB, UX-30ESH, UX-30H, UX-30-McDonalds, UX-30S, UX-30SB, UX-30SH, UX-60, UX-60B, UX-60E, UX-60EB, UX-60EH, UX-60EHB, UX-60H, UX-60HB		

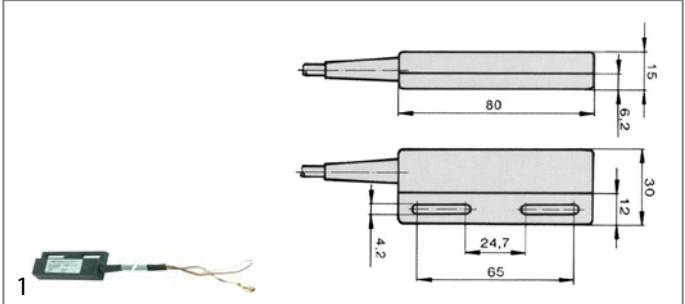

código	345919	referencia	297980-3
descripción	interruptor magnético L 80mm An 30mm empalme cable		
Para modelos:	HX, HX-30E, HX-30ES, HX-40E, HX-40ES, HX-E, HX-ES, HX-S		

ø 6mm



código	347835	referencia	01-235338
descripción	interruptor magnético 150V 1A P máx. 10W sonda L 29mm 1NO empalme de dos hilos longitud del cable 1700mm		



código	347461	referencia	01-240288-001 01-240288-1
---------------	--------	-------------------	------------------------------

descripción	interruptor magnético 28V 0.5A P máx. 15W sonda L 26mm 1NO empalme conector codificado longitud del cable 280mm		
Para modelos:	AM-10, AM-11, AM-141, AM900-10N, AM900-90, AMS900-10N, AMX, AMX-10HL, AMX-90, AMXR, AMXS, AMXT, AMXTS, AMXX, AMXXR, AMXXS, AUP, AUP-90, AUPS, AUXX, AUXXL-11N, AUXXLS-11N, AUXXR, AUXXS, AUXXT, AUXXTS, CN-Protronic, CN-Smartronic, CP-Protronic, ECOMAX-402, ECOMAX-502, ECOMAX-602-10, ECOMAX-602-11, ECOMAX-602S-11, ECOMAX-612-10, ECOMAX-612S-10, FP, FX, FX-McDonalds, GP, GX		

accesorios para	347461	código	524661	referencia	00-883838-001 883838-1
		soporte para interruptor magnético L 34.5mm An 26mm H 9mm			

ø 8mm



código	348194	referencia	87711-352
descripción	interruptor magnético 200V 0.5A P máx. 10W An 8mm sonda L 30mm 1NO empalme conector codificado longitud del cable 290mm M8		



accesorios

imanes



1

código	347926	referencia	166964 170015
descripción	imán ø 22.5mm Lmm H 11.5mm Anmm int.ø 5.2mm M5		
Para modelos:	AM-700, AM900, AMS900, AMX, AMX-900, AMX-E, AMX-ER, AMX-R, AMXR-900, AMXS-900, AMXX-1300, AMXXR-1300, AMXXS-1300, AMXXT, AUX, AUX_, AUX-E, AUX-ER, AUX-R, AUXX-1300, AUXXL, AUXXR-1300, AUXXS-1300, AUXXT, CNR, CR-F, CX, ECOMAX-600, ECOMAX-650, ECOMAX-700, FTT, FTX, FUX, HE, HE600-HL, HE-P, HX, HX-30, HX-30E, HX-30ES, HX-30S, HX-40, HX-40E, HX-40ES, HX-40S, HX-60-EHL, HX-E, HX-ES, HX-S, UW-135...(Otros modelos se puede ver en la tienda web)		



1

código	347722	referencia	00-774714-001 774714-1
descripción	imán ø 34mm Lmm H 17mm Anmm int.ø 5mm M5 con tapa agujero ø 5.25mm		
Para modelos:	CN, CNA, CNB, CN-Protronic, CNR, CN-Smartronic, CP-Protronic, CR, CSA, CS-Easytronic, ECOMAX-800, ECW, FTN, FTX, FUX, UX-30B, UX-30EB, UX-30EH, UX-30ESB, UX-30ESH, UX-30H, UX-30-McDonalds, UX-30SB, UX-30SH, UX-60, UX-60B, UX-60E, UX-60EB, UX-60EH, UX-60EHB, UX-60H, UX-60HB, UXD-30, UXTH, UXTHL, UXTHLS, UXTHS, UXTLH, UXTLHS		

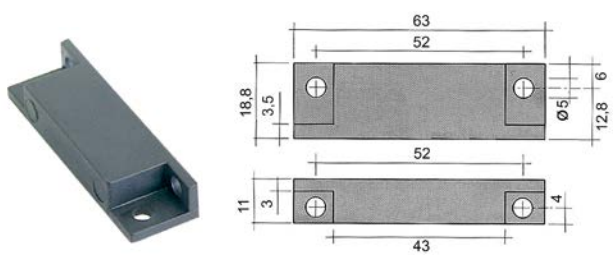

1

código	345336	referencia	E926014
descripción	imán ø 4.8mm L 63mm H 11mm An 18.8mm dist. del agujero 51mm M4		

otros



1

código	347927	referencia	00-112467
descripción	soporte para interruptor magnético int.ø 21mm ø ext. 28.5mm		
Para modelos:	103G, 203G, 2226, 303G, AM-12E, AM-12EC, AM-12EF, AM-12ER, AM15, AM15F, AM15T, C44A, C44AW, C54A, C64A, CN, CNA, CNB, CNR, CR, CR-F, CSA, CX, ECOMAX-800, EWB-S, FTN, FTT, FTX, FUX, ML-110025, ML-110976, ML-110977, ML-32614, ML-32615, UW-100, UW-105, UWX		



1

código	524661	referencia	00-883838-001 883838-1
descripción	soporte para interruptor magnético L 34.5mm An 26mm H 9mm		
Para modelos:	AM-10, AM-11, AM-141, AM900-10N, AM900-90, AMS900-10N, AMX, AMX-10HL, AMX-90, AMXR, AMXS, AMXT, AMXTS, AMXX, AMXXR, AMXXS, AUP, AUP-90, AUPS, AUXX, AUXXL-11N, AUXXLS-11N, AUXXR, AUXXS, AUXXT, AUXXTS, CN-Protronic, CN-Smartronic, CP-Protronic, ECOMAX-402, ECOMAX-502, ECOMAX-602-10, ECOMAX-602-11, ECOMAX-602S-11, ECOMAX-612-10, ECOMAX-612S-10		

aparatos de mando y aviso

MOELLER/EATON

posos



1

código	346728	referencia	887015-71
descripción	interruptor selector medida de montaje ø22mm negro/blanco 330°-0°-30° con enclavamiento secuencia de conmutación 1-0-2		
Para modelos:	ECOMAX-800		



SCHLEGEL

interruptor completo



1

código	347923	referencia	324267-4 897900
descripción	pulsador medida de montaje ø16/24x24mm blanco 1NO/1NC secuencia de conmutación 0-1 sin fin		
Para modelos:	ECOMAX-600, ECOMAX-700, FE, HE, HE600-HL, HE-P		
repuestos para	347923		
	código	359183	referencia —
	unidad de pulsador medida de montaje ø16/24x24mm tipo a impulso antracita/transparente cuadrado		
	código	359194	referencia 324267-1 32427-1
	bloque de contacto con enclavamiento 1NC/1NO empalme conector Faston 2,8mm iluminable casquillo T5.5K tipo AFL		
	código	359796	referencia 324265-11
	tarjeta blanco sin fin		

teclas



1

código	359794	referencia	324266-1
descripción	unidad de pulsador medida de montaje ø16/24x24mm tipo a impulso negro/transparente cuadrado		
Para modelos:	ECOMAX-600, ECOMAX-700, ECOMAX-800, FE, FX, GF-60, GF-60S, GX, HE, HE600-HL, HE-P		

tarjetas



1

código	359193	referencia	324265-12
descripción	tarjeta blanco agua		
Para modelos:	ECOMAX-600, ECOMAX-700, HE, HE600-HL, HE-P		



1

código	359189	referencia	324265-10
descripción	tarjeta blanco conect.		
Para modelos:	ECOMAX-600, ECOMAX-700, HE, HE600-HL, HE-P		



1

código	359795	referencia	00-324265-001 324265-1
descripción	tarjeta blanco reloj		
Para modelos:	ECOMAX-600, ECOMAX-700, FX, GF-60, GF-60S, GX, HE, HE600-HL, HE-P		



1

código	359796	referencia	324265-11
descripción	tarjeta blanco sin fin		
Para modelos:	ECOMAX-600, ECOMAX-700, HE, HE600-HL, HE-P		

bloques de contacto



1

código	359793	referencia	324267-5 897901
descripción	bloque de contacto a impulso 2NO/2NC empalme conector Faston 2,8mm iluminable casquillo T5.5K tipo ATL2		
Para modelos:	ECOMAX-600, ECOMAX-700, FE, HE600-HL		



1

código	359187	referencia	324267-3 897903
descripción	bloque de contacto con enclavamiento 2NO/2NC empalme conector Faston 2,8mm iluminable casquillo T5.5K tipo AFL2		
Para modelos:	ECOMAX-600, ECOMAX-700, HE600-HL		

lámparas

lámparas de señalización

lámparas de señalización 2 piezas (lente y elemento)

casquillos para lámparas de señalización

ø12mm (tipo SDY-3)



1

código	359262	referencia	E926114
descripción	casquillo para lámpara de señalización medida de montaje ø12mm verde redondo UE 1 pzs		

elementos de señalización para casquillo tipo SRZ / SDK / SDY / SFK

1			
código	359130	referencia	216006 E216006
descripción	elemento de señalización 230V claro empalme conector Faston 6,3mm ø 8mm		

lámparas de señalización 3 piezas (casquillo, lente y bombilla)

lámparas
bombillas incandescentes

1			
código	359608	referencia	229167-1
descripción	bombilla incandescente casquillo E14 10/15W 230V ø 16mm L 51mm cristal L 31mm UE 1 pzs		
Para modelos:	CX		

lámpade

bombillas incandescentes
para lámparas de señalización

1			
código	359608	referencia	229167-1
descripción	bombilla incandescente casquillo E14 10/15W 230V ø 16mm L 51mm cristal L 31mm UE 1 pzs		
Para modelos:	CX		

temporizadores

temporizadores de programa

1			
código	360349	referencia	139321-226 E238053
descripción	temporizador CDC 11803 motores 1 cámaras 3 tiempo de funcionamiento 150s aliment. 230V eje ømm eje Lmm N° fabricante 11803F1BEE000.0010 tipo de motor M48R ATS tipo 11803F1 / 238046		
Para modelos:	GW-600, GW-600S, GW-601, GW-601S		
repuestos para	360349		
	código	referencia	—
	kit de motor piñón ø 6.8mm dientes 15 aliment. 230V tensión AC 50/60Hz sentido de rotación en sentido horario ø motor 48mm H 18.5mm tipo motor UDS40NE1RNZ165 longitud del cable 150mm con soporte		

temporizadores eléctricos

1			
código	350201	referencia	00-294650-004-1 294650-4-1
descripción	temporizador M006 con campana tiempo de funcionamiento 15min minuto por minuto hastamin 1NO posición permanente presente accionamiento eléctrico eje ø 6x4,6mm eje L 22mm distancia de sujeción 28mm rosca de sujeción M4 empalme conector Faston 4,8mm 115V tensión AC 60Hz 1 polos		
Para modelos:	A120, H600, H600C, H600D, L800, L800C, L800D, M802, ML-104483, ML-104484, ML-104674, ML-104683, ML-104686, ML-104687, ML-104694, ML-104696, ML-134118, ML-134185, ML-134188, V1401		

contactores

GENERAL ELECTRIC (AEG)

contactores de potencia

1			
código	380239	referencia	00-695507-001
descripción	contactor de potencia AC1 20A 230VAC (AC3/400V) 8,4A/4kW contactos principales 3NO contactos auxiliares 1NC empalme empalme atornillado tipo LS05 01A tipo AEG LS05 01A tipo GE MC1A 301A		

1			
código	380837	referencia	695507-11
descripción	contactor de potencia AC1 20A 400VAC (AC3/400V) 9A/4kW contactos principales 3NO contactos auxiliares 1NO empalme empalme atornillado tipo AEG LS0510A tipo GE MC1A 310A		
Para modelos:	FE, HE		

contactos auxiliares

1			
código	380242	referencia	695508-2 695570-2
descripción	contacto auxiliar contactos 1NO/1NC para contactores M+LS05 empalme atornillado AC-12 10A tipo AEG HS05K 11HS tipo GE MARN 211		
Para modelos:	FE, HE, HE600-HL, HE-P		



MOELLER/EATON

contactores de potencia



1

código	380549	referencia	139270-1
descripción	contactor de potencia AC1 20A 230VAC (AC3/400V) 9A/4kW contactos principales 3NO contactos auxiliares 1NO empalme empalme atornillado tipo DILM9 10		
Para modelos:	AM-12E, AM-12EC, AM-12EF, AM-12ER, H600, H800		

accesorios para 380549



código	380555	referencia	—
descripción	contacto auxiliar contactos 2NO/2NC AC15 16A para contactores DILEM empalme atornillado tipo DILA-XHI22		



código	380556	referencia	—
descripción	contacto auxiliar contactos 4NO AC15 16A para contactores DILM 7-32 empalme atornillado tipo DILA-XHI40		



código	380557	referencia	—
descripción	contacto auxiliar contactos 4NC AC15 16A para contactores DILM 7-32 empalme atornillado tipo DILA-XHI04		



código	380558	referencia	—
descripción	contacto auxiliar contactos 3NO/1NC AC15 16A para contactores DILM 7-32 empalme atornillado tipo DILA-XHI31		



código	380559	referencia	—
descripción	contacto auxiliar contactos 1NO/3NC AC15 16A para contactores DILM 7-32 empalme atornillado tipo DILA-XHI13		



código	380568	referencia	—
descripción	elemento RC apto para DILM 9-12 nominal 110-240V		

SIEMENS

contactores de potencia



1

código	380957	referencia	E927160
descripción	contactor de potencia AC1 22A 24VAC (AC3/400V) 12A/5,5kW contactos principales 3NO contactos auxiliares 1NO empalme empalme atornillado tipo 3RT10-17-1AB01 50/60Hz		

TELEMECANIQUE (Schneider Electric)

contactores de potencia



1

código	380962	referencia	00-695521-062 695521-62
descripción	contactor AC1 20A 230VAC (AC3/400V) 9A/4kW contactos principales 4NO empalme empalme atornillado tipo LC1K09004U7		
Para modelos:	ECOMAX-402, ECOMAX-502		



1

código	380820	referencia	00-695527-002
descripción	contactor de potencia AC1 25A 230VAC (AC3/400V) 9A/4kW contactos principales 3NO contactos auxiliares 1NO/1NC empalme atornillado tipo LC1D0900M7		



1

código	380976	referencia	296926-2
descripción	contactor de potencia AC1 32A 230VAC (AC3/400V) 18A/7,5kW contactos principales 3NO contactos auxiliares 1NO/1NC empalme empalme atornillado		



relés

relés de potencia

con lengüeta de sujeción



1

código	380312	referencia	00-139321-354 229023
descripción	relé de potencia FINDER 230VAC 10A 3CO empalme conector Faston 4,8mm lengüeta de sujeción medidas 52x32,2x36,5mm N° fabricante 60.63.8.230.0000		



1

código	380139	referencia	929115
descripción	relé de potencia FINDER 230VAC 16A 2CO empalme F6,3 lengüeta de sujeción medidas 68x38,2x35,8mm N° fabricante 62.82.8.230.0000		



1

código	380403	referencia	900073
descripción	relé de potencia FINDER 230VAC 16A 3CO empalme F6,3 lengüeta de sujeción N° fabricante 62.83.8.230.0500		

relés de temporización

relés de temporización



1

código	380625	referencia	228180-3
descripción	relé de temporización DOLD CD7839.65/100 margen de tiempo 0,5-5s 220-240VAC 4A 1NO empalme borne d empalme		
Para modelos:	FM-30, FM-30U, FX, GX, HX, HX-30, HX-30E, HX-30ES, HX-30S, HX-40, HX-40E, HX-40ES, HX-40S, HX-E, HX-ES, HX-S		



1

código	380624	referencia	228180-1
descripción	relé de temporización DOLD CD7839.65/100 margen de tiempo 3-30s 220-240VAC 4A 1NO empalme borne d empalme		
Para modelos:	CM1E, FM-30, FM-30U, FX, GX, HX, HX-30, HX-30E, HX-30ES, HX-30S, HX-40, HX-40E, HX-40ES, HX-40S, HX-E, HX-ES, HX-S, WM2E		



1

código	380960	referencia	774103-2
descripción	relé de temporización DOLD IK817N.81/200 margen de tiempo 0,02s-300h 12-240V AC/DC medida de montaje riel DINmm		
Para modelos:	ECOMAX-600, ECOMAX-700		



sensores

sensores específicos del fabricante

sensores



código	402905	referencia	00-775612-001 775612-1
descripción	sensor de temperatura NTC 10kOhm cable PVC sonda -40 a +110°C cable -10 a 100°C empalme conector codificado rosca bulbo ø5x35mm longitud de cable 0.2m		
Para modelos:	AM-10, AM-11, AM-141, AM-700, AM900, AM900-10N, AM900-90, AMS900, AMS900-10N, AMX, AMX-10HL, AMX-90, AMX-900, AMXR, AMXR-900, AMXS, AMXS-900, AMXT, AMXTS, AMXX, AMXX-1300, AMXXR, AMXXR-1300, AMXXS, AMXXS-1300, AMXXT, AUP, AUP-90, AUPS, AUXX, AUXX-1300, AUXXL, AUXXL-11N, AUXXLS-11N, AUXXR, AUXXR-1300, AUXXS, AUXXS-1300, AUXXT, AUXXTS, CNA, CNB, CN-Protronic, CNR, CN-Smartronic, CP-Protronic, ECOMAX-602-10, ECOMAX-602-11, ECOMAX-602S-11, ECOMAX-612-10...(Otros modelos se puede ver en la tienda web)		
accesorios para	402905		
	código	692218	referencia
			00-775489-001 775489-1
	clip para bulbo para sensor de temperatura L 35mm An 24mm H 5mm		



código	402906	referencia	775494-1
descripción	sensor de temperatura NTC 10kOhm cable sonda -40 a +110°C cable °C empalme conector Faston 4,8mm rosca bulbo ø10x30mm longitud de cable m		
Para modelos:	AM900, AMS900, FX, GC, GC11, GC12, GC31, GC32, GC41, GC42, GX		



código	379907	referencia	298543-2
descripción	sensor de temperatura Pt1000 cable silicona sonda -50 a +250°C cable -50 a +180°C empalme conector Faston 6,3mm rosca bulbo ø6x50mm longitud de cable 1.5m -50 a +180°C		
Para modelos:	AM-600, AM-600C, AM-600CR, AM-600R, FM-400H, FM-400U, FM-500, FM-500H, UW-105, UW-135H, UW-55		



código	378262	referencia	298543-1
descripción	sensor de temperatura Pt1000 cable silicona sonda -50 a +400°C cable -50 a +180°C empalme F6,3 rosca bulbo ø6x50mm longitud de cable 2.5m		
Para modelos:	UW-125, UW-135, UW-135H, UW-205		



código	379906	referencia	00-378584-000 229512-2
descripción	sensor de temperatura PTC 2kOhm cable TPE sonda -50 a +150°C cable -40 a +110°C empalme conector codificado rosca bulbo ø4,8x30mm longitud de cable 3.5m		
Para modelos:	AMX-E, AMX-ER, AUX-E, AUX-ER, CN, CX, FE-W, FTN, FTX, FX, GX, HX-30E, HX-30ES, HX-40E, HX-40ES, HX-60-EHL, HX-E, HX-ES, UX-30E, UX-30EB, UX-30EH, UX-30ES, UX-30ESB, UX-30ESH, UX-30-McDonalds, UX-60E, UX-60EB, UX-60EH, UX-60EHB		

accesorios

sujeciones



código	692218	referencia	00-775489-001 775489-1
descripción	clip para bulbo para sensor de temperatura L 35mm An 24mm H 5mm		
Para modelos:	AM-10, AM-11, AM-141, AM-700, AM900, AM900-10N, AM900-90, AMS900, AMS900-10N, AMX, AMX-10HL, AMX-90, AMX-900, AMXR, AMXR-900, AMXS, AMXS-900, AMXT, AMXTS, AMXX, AMXX-1300, AMXXR, AMXXR-1300, AMXXS, AMXXS-1300, AMXXT, AUP, AUP-90, AUPS, AUXX, AUXX-1300, AUXXL, AUXXL-11N, AUXXLS-11N, AUXXR, AUXXR-1300, AUXXS, AUXXS-1300, AUXXT, AUXXTS, CNA, CN-Protronic, CNR, CN-Smartronic, CP-Protronic, CSA, CS-Easytronic, ECOMAX-600, ECOMAX-602-10, ECOMAX-602-11...(Otros modelos se puede ver en la tienda web)		

electrónicas

EPROMs

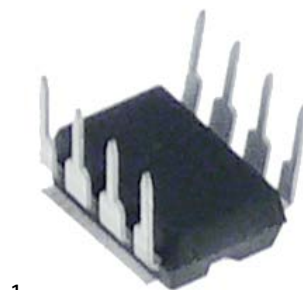

código	403031	referencia	897547-17
descripción	EPROM		

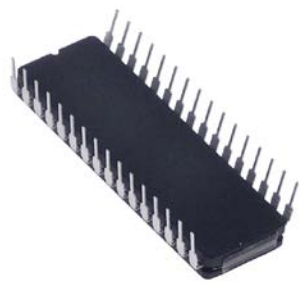
1

código	403046	referencia	775233-3V
descripción	EPROM		



1

código	403216	referencia	897503-1
descripción	EPROM tipo Rev 7.06/403A para lavavajillas apto para HOBART CODE 897503-1 24.04.07		
Para modelos:	FX, GX		



1

código	403702	referencia	897547-15
descripción	EPROM Rev. 1.6 (04.06.2013)		



1

código	403030	referencia	00-897547-006 897547-6
descripción	EPROM tipo REV. L2.3/6101 CODE 897547-6		



1

código	403217	referencia	897503-2
descripción	EPROM tipo Rev 10.4/5D51 para lavavajillas apto para HOBART CODE 897503-2 17.07.07		
Para modelos:	AM-700, AM900, AMS900, AMX-900, AMXR-900, AMXS-900, AMXX-1300, AMXXR-1300, AMXXS-1300, AMXXT, AUXX-1300, AUXXL, AUXXR-1300, AUXXS-1300, AUXXT, GC, GC11, GC12, GC31, GC32, GC41, GC42, UX, UXL, UXLS, UXS, UXT, UXTH, UXTHL, UXTHLS, UXTHS, UXTL, UXTLH, UXTLHS, UXTLS, UXTS		



1

código	403241	referencia	139321-688
descripción	EPROM tipo U61E para lavavajillas CODE 81001-3		
Para modelos:	CHH-50, CHH-60D, CHH-70D, EH-60, EH-70		

placas electrónicas





1

código	403218	referencia	774142-1 774142-1V
descripción	EPROM tipo Rev 13/6B17 para lavavajillas apto para HOBART CODE 774142-1 16.10.01		
Para modelos:	AMX-E, AMX-ER, AUX-E, AUX-ER, FE-W, FX, HX-30E, HX-30ES, HX-40E, HX-40ES, HX-E, HX-ES, UX-30E, UX-30EB, UX-30EH, UX-30ES, UX-30ESB, UX-30ESH, UX-30-McDonalds, UX-60E, UX-60EB, UX-60EH, UX-60EHB		



1

código	403204	referencia	00-897545-005 897545-5	
descripción	placa de control lavavajillas C502/C602 L 148mm An 126mm sin EPROM			
accesorios para	403204			
	código	403030	referencia	00-897547-006 897547-6
	descripción	EPROM tipo REV. L2.3/6101 CODE 897547-6		
	código	403031	referencia	897547-17
	descripción	EPROM		

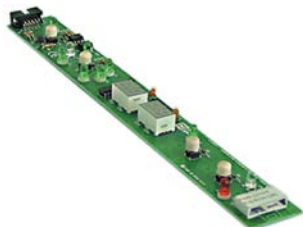

1

código	400897	referencia	139321-456
descripción	placa de display lavavajillas GS 60		
Para modelos:	CHF45, CHH-50, CHH-60D, CHH-70D, EF-40, EH-60, EH-70		
accesorios para	400897		
	código	referencia	403250 139321-684
	cable de cinta plana 10 polos L 3200mm tipo de conector cifrado 2 filas número de polos de conector 10		



1

código	403032	referencia	00-897560-001 00-897560-002 897560-1 897560-2
descripción	placa de teclado lavavajillas C402(S)/C502(S)/C602(S)-xx L 185mm An 35mm apto para COOKMAX con Display tazas 4		
Para modelos:	AM-10, AM-11, AM-141, ECOMAX-402, ECOMAX-502, ECOMAX-602-10, ECOMAX-602-11, ECOMAX-602S-11, ECOMAX-612-10, ECOMAX-612S-10		



1

código	403033	referencia	00-897545-001 00-897545-002 00-897545-003 897543-002/00 897545-1 897545-2 897545-3
descripción	placa electrónica control L 147mm An 125mm sin EPROM 230V		
Para modelos:	AM-10, AM-11, AM-141, AM900-10N, AM900-90, AMS900-10N, AMX, AMX-10HL, AMX-90, AMXR, AMXS, AMXT, AMXTS, AMXX, AMXXR, AMXXS, AUP, AUP-90, AUPS, AUXX, AUXXL-11N, AUXXLS-11N, AUXXR, AUXXS, AUXXT, AUXXTS, ECOMAX-402, ECOMAX-502, ECOMAX-602-10, ECOMAX-602-11, ECOMAX-602S-11, ECOMAX-612-10, ECOMAX-612S-10, FP, FX, FX-McDonalds, GP, GX		
accesorios para	403033		
	código	referencia	403030 00-897547-006 897547-6
	EPROM tipo REV. L2.3/6101 CODE 897547-6		
	código	referencia	403031 897547-17
	EPROM		
	código	referencia	403702 897547-15
	EPROM Rev. 1.6 (04.06.2013)		



1

código	401893	referencia	00-087714-028-2 87714-28-2
descripción	placa electrónica control temporizado apto para HOBART		
Para modelos:	C44A, C44AW, C54A		



1

código	401895	referencia	781142-1
descripción	placa electrónica lavavajillas CR tipo 5E 5A		



1

código	402903	referencia	00-897502-001 897502-1 897502-12 897502-2 897502-22
descripción	placa electrónica lavavajillas GX/FX/HX apto para HOBART sin EPROM		
Para modelos:	AM-700, AM900, AMS900, AMX-900, AMXR-900, AMXS-900, AMXX-1300, AMXXR-1300, AMXXS-1300, AMXXT, AUXX-1300, AUXXL, AUXXR-1300, AUXXS-1300, AUXXT, ECOMAX-650, FX, GC, GC11, GC12, GC31, GC32, GC41, GC42, GX, UX, UXL, UXLS, UXS, UXT, UXTH, UXTHL, UXTHLS, UXTHS, UXTL, UXTLH, UXTLHS, UXTLS, UXTS		
accesorios para	402903		
	código	referencia	403217 897503-2
	EPROM tipo Rev 10.4/5D51 para lavavajillas apto para HOBART CODE 897503-2 17.07.07		



1

código	401946	referencia	324074-1 324250-1 374391-1 785422-1
descripción	placa electrónica lavavajillas HX		
Para modelos:	FX, GX, HX, HX-E, HX-ES, HX-S		



1

código	403882	referencia	01-515340-001 01-515340-1
descripción	placa electrónica para HOBART		



1

código	402904	referencia	00-897501-1
descripción	platina de control lavavajillas AM/AMX 700/900 apto para HOBART tazas 4		
Para modelos:	AM-700, AM900, AMS900, AMX-900, AMXR-900, AMXS-900, AMXX-1300, AMXXR-1300, AMXXS-1300, AMXXT, AUXX-1300, AUXXL, AUXXR-1300, AUXXS-1300, AUXXT, CNA, CNR, ECOMAX-650, FX, GC, GC11, GC12, GC31, GC32, GC41, GC42, GX, UX, UXL, UXLS, UXS, UXT, UXTH, UXTHL, UXTHLS, UXTHS, UXTL, UXTLH, UXTLHS, UXTLS, UXTS		

teclados

membranas de teclado



1

código	402321	referencia	296979-4
descripción	membrana de teclado		
Para modelos:	AM-600, AM-600C, AM-600CR, AM-600R, FM-400H, FM-400U, FM-500, FM-500H, UW-105, UW-135, UW-135H, UW-55		



1

código	698701	referencia	00-897500-001 897500-1
descripción	membrana de teclado lavavajillas AMX 900 L 500mm An 41mm		
Para modelos:	AM900, AMS900, AMX-900, AMXR-900, AMXS-900, AMXX-1300, AMXXR-1300, AMXXS-1300, AMXXT, AUXX-1300, AUXXL, AUXXR-1300, AUXXS-1300, AUXXT, FX, GX, UX, UXL, UXLS, UXS, UXT, UXTH, UXTHL, UXTHLS, UXTHS, UXTL, UXTLH, UXTLHS, UXTLS, UXTS		



1

código	403783	referencia	41357
descripción	membrana de teclado lavavajillas HOBART/EUROTEC L 144mm An 184mm		



1

código	403769	referencia	00-897550-001 897550-1
descripción	membrana de teclado sistemas de lavado AM900 L 187mm An 45mm		
Para modelos:	AM900-10N, AM900-90, AMS900-10N, AMX, AMX-10HL, AMX-90, AMXR, AMXS, AMXT, AMXTS, AMXX, AMXXR, AMXXS, FX, FX-McDonalds, GX		



1

código	694717	referencia	N/A
descripción	membrana de teclado sistemas de lavado lavavajillas universal negro/blanco apto para HOBART L 185mm An 144mm tazas 3		



teclados de membrana



código	402918	referencia	324202
descripción	teclado de membrana sistemas de lavado GX/FX/HX tazas 7 apto para HOBART L 152mm An 52mm		
Para modelos:	AMX-E, AMX-ER, AUX-E, AUX-ER, FX, HX-30E, HX-40E, HX-E, UX-30E, UX-30EB, UX-30EH, UX-30ES, UX-30ESB, UX-30ESH, UX-30-McDonalds, UX-60E		

válvulas magnéticas

válvulas magnéticas agua

INTERELEKTRIK

temperatura líquido: 90°C 90°C 60°C
 temperatura ambiente: 60°C 25°C 60°C
 ciclo de trabajo: 40% 100% 100%

con reducciones













código	370675	referencia	00-883658-001 01-246164-001 01-246164-1 883658-1
descripción	válvula magnética simple recto 230VAC entrada 3/4" salida 10,5mm reducción entrada A 5l/min T máx 90°C		
Para modelos:	AM900-10N, AM900-90, AMS900-10N, AMX, AMX-10HL, AMX-90, AMX-900, AMXR, AMXR-900, AMXS, AMXS-900, AMXT, AMXTS, AMXX, AMXX-1300, AMXXR, AMXXR-1300, AMXXS, AMXXS-1300, AMXXT, AUP, AUP-90, AUPS, AUXX, AUXX-1300, AUXXL-11N, AUXXLS-11N, AUXXR, AUXXR-1300, AUXXS, AUXXS-1300, AUXXT, AUXXTS, ECOMAX-402, ECOMAX-502, ECOMAX-602-11, ECOMAX-602S-11, ECOMAX-612-10, ECOMAX-612S-10, ECOMAX-700, FP, FX, FX-McDonalds, GP, GX, UX, UXL, UXLS, UXS, UXT...(Otros modelos se puede ver en la tienda web)		
accesorios para	370675		
	código	520015	referencia 00-775559-007 00-775559-008 00-775559-013 00-775559-016 139321-125 139321-611 775559-13 775559-16 775559-7 775559-8
tubo flexible de entrada int.ø 10mm ø ext. 17mm L 5m p de trabajo 20bar p de reventamiento 60bar T máx 95°C gris UE 5m			

TECLADOS/VÁLVULAS MAGNÉTICAS HOBART

MÜLLER

temperatura líquido: 90°C
 ciclo de trabajo: 100%



código	370001	referencia	324207-1
descripción	válvula magnética simple acodado 230VAC entrada 3/4" salida 14,5mm DN10 T máx 90°C ciclo de trabajo 100% MÜLLER		
Para modelos:	AM3, AMX, AMX-E, AMX-ER, AMX-R, AUX, AUX_, AUX-E, AUX-ER, AUX-R, FE, FX, GX, HE, HE-P, HX, HX-30, HX-30E, HX-40, HX-40E, HX-60-EHL, HX-E, HX-ES, HX-S, UX-30, UX-30B, UX-30E, UX-30EB, UX-30EH, UX-30H, UX-30-McDonalds, UX-60, UX-60B, UX-60E, UX-60EB, UX-60EH, UX-60EHB, UX-60H, UX-60HB, UXD-30		
repuestos para	370001		
	código	370126	referencia —
cuerpo de válvula magnética simple acodado entrada 3/4" salida 14,5mm DN10 T máx 90°C ciclo de trabajo 100% MÜLLER plástico			
	código	371002	referencia —
soporte de válvula magnética MÜLLER portabridas			
	código	371009	referencia —
resorte de compresión para solenoide			
	código	371011	referencia —
kit de piezas de repuesto membrana con estrella larga anchura estrella 8mm MÜLLER			
	código	371017	referencia —
bobina magnética MÜLLER 230VAC empalme conector Faston 6,3mm			
	código	371122	referencia —
filtro de válvula magnética ø 19mm H 10mm apto para MÜLLER			
	código	501161	referencia —
montura para válvula magnética soporte para solenoides			
accesorios para	370001		
	código	371010	referencia —
bobina magnética 230VAC empalme con cable longitud del cable 2000mm			
	código	371037	referencia —
bobina magnética 24VAC 50/60Hz empalme conector Faston 6,3mm			
	código	371038	referencia —
bobina magnética 230VAC empalme conector			

válvulas magnéticas con reducciones

simple



1

código	370312	referencia	324207-2
descripción	válvula magnética simple acodado 230VAC entrada 3/4" salida 14mm reducción entrada A 10l/min T máx 90°C MÜLLER plástico reducción entrada A blanco		
Para modelos:	AMX-ER, AMX-R, AUX-ER, AUX-R		



1

código	370645	referencia	297808-12
descripción	válvula magnética simple recto 220-240VAC entrada 3/4" salida 3/4" reducción entrada A 20l/min T máx 90°C MÜLLER reducción entrada A verde		
Para modelos:	CNB		



1

código	370640	referencia	297497
descripción	válvula magnética simple recto 230VAC entrada 3/4" salida 14,5mm reducción salida 2.5l/min DN10 T máx 90°C ciclo de trabajo 100% MÜLLER		

doble



1

código	370331	referencia	324208-1
descripción	válvula magnética doble acodado 230VAC entrada 3/4" salida 14mm reducción entrada A 10l/min T máx 90°C MÜLLER plástico reducción salida A 3.5l/min		
Para modelos:	FE-W, FX, GX, HX-30ES, HX-30S, HX-40ES, HX-40S, HX-ES, HX-S, UX-30ES, UX-30ESB, UX-30ESH, UX-30-McDonalds, UX-30S, UX-30SB, UX-30SH		



1

código	370313	referencia	324208-3 324208-5
descripción	válvula magnética doble acodado 230VAC entrada 3/4" salida 4mm reducción entrada A 10l/min T máx 90°C MÜLLER plástico reducción entrada A blanco reducción salida B 3.5l/min reducción salida A azul oscuro		
Para modelos:	FX, GX, HX-30ES, HX-30S, HX-40ES, HX-40S, HX-ES, HX-S, UX-30ES, UX-30ESB, UX-30ESH, UX-30-McDonalds, UX-30S, UX-30SB, UX-30SH		

ROBERTSHAW/INVENSYS

temperatura líquido: 90°C 90°C 60°C
temperatura ambiente: 60°C 25°C 60°C
ciclo de trabajo: 40% 100% 100%

válvulas magnéticas con reducciones

simple



1

código	374013	referencia	775742-1
descripción	válvula magnética simple recto 230VAC entrada 3/4" salida 11,5mm 10 Invensys plástico reducción entrada A rose		
Para modelos:	AM-700, GC, GC11, GC12		

RPE







1

código	370857	referencia	00-883658-002 883658-2
descripción	válvula magnética simple recto 230VAC entrada 3/4" salida 10,5mm reducción entrada A 15l/min T máx 90°C RPE plástico		
Para modelos:	AM-10, AM-11, AM-141, AMX-10HL, ECOMAX-402, ECOMAX-502, ECOMAX-602-10, FP, FX, FX-McDonalds, GP, GX, UX, UXL, UXLS, UXS, UXT, UXTL, UXTLS, UXTS		

TP







1

















código	370111	referencia	E927001
descripción	válvula magnética doble recto 24VAC entrada 3/4" salida 11,5mm DN10 TP		
repuestos para	370111		
	código	371035	referencia —
		bobina magnética 24VAC	
accesorios para	370111		
	código	371220	referencia —
		reducción TP velocidad de flujo 3l/min rojo tolerancia ±15%	
	código	371221	referencia —
		reducción TP velocidad de flujo 5.5l/min amarillo tolerancia ±15%	
	código	371222	referencia —
		reducción TP velocidad de flujo 6l/min gris tolerancia ±15%	
	código	371223	referencia —
		reducción TP velocidad de flujo 10l/min blanco tolerancia ±15%	

Continúa en la página siguiente



accesorios para 370111	
	código 371224 referencia — reducción TP velocidad de flujo 12l/min bronce tolerancia ±15%
	código 371225 referencia — reducción TP velocidad de flujo 16l/min marrón claro tolerancia ±15%
	código 371226 referencia — reducción TP velocidad de flujo 20l/min rojo tolerancia ±15%
	código 371230 referencia — reducción TP velocidad de flujo 0.25l/min rojo tolerancia ±25%
	código 371231 referencia — reducción TP velocidad de flujo 0.35l/min violeta tolerancia ±25%
	código 371232 referencia — reducción TP velocidad de flujo 0.5l/min naranja tolerancia ±25%
	código 371233 referencia — reducción TP velocidad de flujo 0.8l/min blanco tolerancia ±25%
	código 371234 referencia — reducción TP velocidad de flujo 1l/min azul claro tolerancia ±25%
	código 371235 referencia — reducción TP velocidad de flujo 1.2l/min marrón tolerancia ±25%
	código 371236 referencia — reducción TP velocidad de flujo 1.5l/min marrón claro tolerancia ±25%
	código 371237 referencia — reducción TP velocidad de flujo 2.5l/min amarillo tolerancia ±25%
	código 371238 referencia — reducción TP velocidad de flujo 3.4l/min verde oscuro tolerancia ±25%
	código 371239 referencia — reducción TP velocidad de flujo 5l/min negro tolerancia ±25%
	código 371240 referencia — reducción TP velocidad de flujo 8l/min azul tolerancia ±20%

  1	
código	370025 referencia 139321-1
descripción	válvula magnética triple recto 230VAC entrada 3/4" salida 11,5mm DN10 TP
repuestos para	370025
	código 371013 referencia — bobina magnética TP 230VAC 50/60Hz
accesorios para	370025
	código 371220 referencia — reducción TP velocidad de flujo 3l/min rojo tolerancia ±15%

accesorios para 370025	
	código 371221 referencia — reducción TP velocidad de flujo 5.5l/min amarillo tolerancia ±15%
	código 371222 referencia — reducción TP velocidad de flujo 6l/min gris tolerancia ±15%
	código 371223 referencia — reducción TP velocidad de flujo 10l/min blanco tolerancia ±15%
	código 371224 referencia — reducción TP velocidad de flujo 12l/min bronce tolerancia ±15%
	código 371225 referencia — reducción TP velocidad de flujo 16l/min marrón claro tolerancia ±15%
	código 371226 referencia — reducción TP velocidad de flujo 20l/min rojo tolerancia ±15%
	código 371230 referencia — reducción TP velocidad de flujo 0.25l/min rojo tolerancia ±25%
	código 371231 referencia — reducción TP velocidad de flujo 0.35l/min violeta tolerancia ±25%
	código 371232 referencia — reducción TP velocidad de flujo 0.5l/min naranja tolerancia ±25%
	código 371233 referencia — reducción TP velocidad de flujo 0.8l/min blanco tolerancia ±25%
	código 371234 referencia — reducción TP velocidad de flujo 1l/min azul claro tolerancia ±25%
	código 371235 referencia — reducción TP velocidad de flujo 1.2l/min marrón tolerancia ±25%
	código 371236 referencia — reducción TP velocidad de flujo 1.5l/min marrón claro tolerancia ±25%
	código 371237 referencia — reducción TP velocidad de flujo 2.5l/min amarillo tolerancia ±25%
	código 371238 referencia — reducción TP velocidad de flujo 3.4l/min verde oscuro tolerancia ±25%
	código 371239 referencia — reducción TP velocidad de flujo 5l/min negro tolerancia ±25%
	código 371240 referencia — reducción TP velocidad de flujo 8l/min azul tolerancia ±20%

válvulas magnéticas con reducciones



1

código	370245	referencia	E927242
descripción	válvula magnética simple recto 24VAC entrada 3/4" salida 11,5mm reducción entrada A 16l/min T máx 90°C TP plástico reducción entrada A marrón claro		

diversos



1

código	370641	referencia	00-775897-001 775897-1
descripción	válvula magnética 220-240VAC salida 10mm plástico entrada 10mm		
Para modelos:	ECOMAX-402, ECOMAX-502, ECOMAX-602S-11, ECOMAX-612S-10, FX, FX-McDonalds		

metal

ASCO

2 vías



1

código	370121	referencia	173863
descripción	válvula magnética 2vías 230VAC empalme 1/2" L 70mm DN 16mm conector hembra DIN -20° a 85°C Asco serie 210 (control forzado) tipo de bobina 400425-217 membrana NBR (Wasser) p máx. 9bar juego de válvulas A		
Para modelos:	102-G, 103G, 104G, 201G, 202-G, 203G, 204G, 205G, 2222, 2226, 2227, 2228, 301G, 302-G, 303G, 304G, 304T, 305G, AM-12E, AM-12EC, AM-12EF, AM-12ER, AM-600CR, AM-600R, UW-135, UW-135H		

válvulas magnéticas vapor (agua)

2 vías



1

código	370263	referencia	00-168909-001 168909-1 2967951-1
descripción	válvula magnética 2vías 230VAC entrada 3/4" salida 3/4" empalme 3/4" L 72mm DN 19mm conector hembra DIN -20° a 184°C Asco serie 222 (control forzado) tipo de bobina 400426-117 membrana PTFE (agua/vapor) p máx. 9bar juego de válvulas H		
Para modelos:	AM-600, AM-600C, AM-600CR, AM-600R, AMX, AMX-E, AMX-ER, AMX-R, AUX, AUX-E, AUX-ER, AUX-R, UW-100, UW-105, UW-135, UW-135H, UX-30, UX-30B, UX-30E, UX-30EB, UX-30ES, UX-30ESB, UX-30S, UX-30SB, UX-60, UX-60B, UX-60E, UX-60EB		

recambios y accesorios

kits



1

código	371143	referencia	228894-1 228894-11
descripción	complemento de válvula para válvula magnética con accesorios		



1

código	371110	referencia	173863-11
descripción	complemento de válvula tipo A medida 1/2" kit de servicio		
Para modelos:	2226, 2227, AM-12E, AM-12EC, AM-12EF, AM-12ER, AM-600, AM-600C, AM-600CR, AM-600R		

válvulas de desagüe



1

código	370642	referencia	00-774683-001 774683-1
descripción	electroválvula descarga 230V 50/60Hz simple entrada 40mm salida 40mm 26 1vías		
Para modelos:	CN, CNA, CNB, CNR, CSA, EWB-S, FTN		



1

código	370621	referencia	323785-1 323785-11 378562-1
descripción	electroválvula descarga 230V 50Hz simple entrada 17mm salida 17mm 11.5		
Para modelos:	FE-W, FX, GX, HX, HX-30, HX-30E, HX-30ES, HX-30S, HX-40, HX-40E, HX-40ES, HX-40S, HX-60-EHL, HX-E, HX-ES, HX-S, UX-30ES, UX-30ESB, UX-30ESH, UX-30-McDonalds, UX-30S, UX-30SB, UX-30SH		



1

código	370720	referencia	323592-1
descripción	electroválvula descarga recto 230V 50/60Hz simple entrada 17mm salida 19mm 10 plástico		
Para modelos:	AMX-ER, AMX-R, AUX-ER, AUX-R, CN, CNA, CNB, CNR, CR, CSA, FTN		



1

código	370721	referencia	323785-12 323785-2
descripción	electroválvula descarga recto 240V 50Hz simple entrada 17mm salida 19mm 10 plástico		
Para modelos:	FE-W, FX, GX, HX, HX-30, HX-30E, HX-30ES, HX-30S, HX-40, HX-40E, HX-40ES, HX-40S, HX-60-EHL, HX-E, HX-ES, HX-S, UX-30ES, UX-30ESB, UX-30ESH, UX-30-McDonalds, UX-30S, UX-30SB, UX-30SH		

presostatos

para sistemas de lavado

ø58mm con conector Faston 6,3mm

con empalme horizontal



1

código	541003	referencia	139321-23 139321-833
descripción	presostato margen de presión 55/35mbar empalme 6mm ø 58mm conexión de presión horizontal sistemas de lavado empalme presión ø 6mm		
Para modelos:	GE-400, GF-60, GF-60S, GW-600, GW-600S, GW-601, GW-601S		

ø79mm con conector codificado

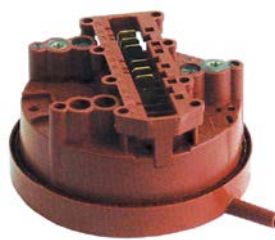

1

código	541321	referencia	231981-2 231981-6
descripción	presostato 2 márgenes de presión margen de presión 35/20 80/60mbar empalme 6mm ø 79mm conexión de presión horizontal sistemas de lavado apto para HOBART empalme presión ø 6mm		
Para modelos:	AMX, AMX-R, AUX, AUX_, AUX-R, CN, CNB, FTN, UX-30, UX-30B, UX-30H, UX-30-McDonalds, UX-30S, UX-30SB, UX-30SH, UX-60, UX-60B, UXD-30		

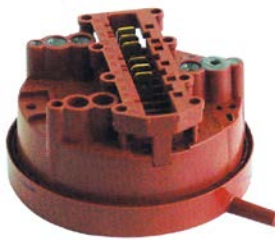

1

código	541318 ¹	referencia	378758-2 378758-6
descripción	presostato 2 márgenes de presión margen de presión 35/25 80/60mbar empalme 6mm ø 79mm con contactos dorados para aparatos electrónicos conexión de presión horizontal sistemas de lavado apto para HOBART empalme presión ø 6mm		
Para modelos:	AMX-E, AMX-ER, AUX-E, AUX-ER, CN, CNB, FTN, UX-30E, UX-30EB, UX-30EH, UX-30ES, UX-30ESB, UX-30ESH, UX-30-McDonalds, UX-60E, UX-60EB		

¹con contactos dorados para aparatos electrónicos

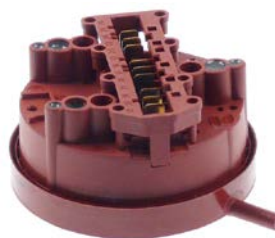

1

código	541902 ¹	referencia	378760-002 378760-2
descripción	presostato 3 márgenes de presión margen de presión 145/120 230/200 280/250mbar empalme 6mm ø 79mm conexión de presión horizontal con contactos dorados para aparatos electrónicos sistemas de lavado		
Para modelos:	CR, CR-F		

¹con contactos dorados para aparatos electrónicos

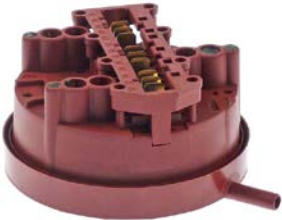
1

código	541904	referencia	378758-8
descripción	presostato 3 márgenes de presión margen de presión 145/120 260/230 385/350mbar empalme 6mm ø 79mm conexión de presión horizontal sistemas de lavado empalme presión ø 6mm		
Para modelos:	UX-30E, UX-30EB, UX-30EH, UX-30ES, UX-30ESB, UX-30ESH, UX-30-McDonalds		

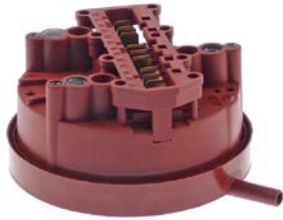

1

código	541316 ¹	referencia	378758-4
descripción	presostato 3 márgenes de presión margen de presión 40/25 57/42 125/105mbar empalme 6mm ø 79mm conexión de presión horizontal con contactos dorados para aparatos electrónicos sistemas de lavado		
Para modelos:	AMX-E, AMX-ER, AUX-E, AUX-ER, FX, GX		

¹con contactos dorados para aparatos electrónicos

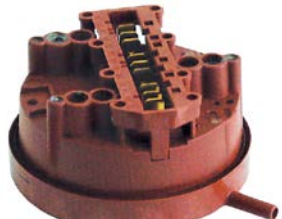

1

código	542151	referencia	378760-6
descripción	presostato 3 márgenes de presión margen de presión 40/25 57/37 125/105mbar empalme 6mm ø 78mm conexión de presión horizontal sistemas de lavado empalme presión ø 6mm		
Para modelos:	FX, GX		

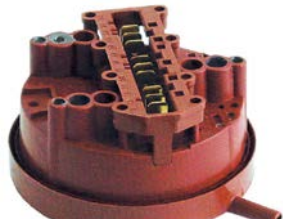

1

código	541317 ¹	referencia	378760-1 378760-3
descripción	presostato 3 márgenes de presión margen de presión 40/25 57/42 125/105mbar empalme 6mm ø 79mm conexión de presión horizontal sistemas de lavado apto para HOBART		
Para modelos:	AMX, AMX-R, AUX, AUX_, AUX-R, UXD-30		

¹con contactos dorados para aparatos electrónicos

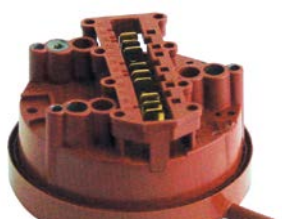

1

código	541320	referencia	231981-1
descripción	presostato 3 márgenes de presión margen de presión 40/25 57/37 125/105mbar empalme 6mm ø 79mm conexión de presión horizontal sistemas de lavado apto para HOBART empalme presión ø 6mm		
Para modelos:	AM3, CR-F, FE, FX, GX, HE, HE600-HL, HE-P, HX, HX-30, HX-30E, HX-30S, HX-40, HX-40E, HX-40S, HX-5		



1

código	541782 ¹	referencia	00-378758-005 378758-5
descripción	presostato 3 márgenes de presión margen de presión 40/25 92/77 160/140mbar empalme 6mm ø 79mm conexión de presión horizontal con contactos dorados para aparatos electrónicos sistemas de lavado apto para HOBART empalme presión ø 6mm		
Para modelos:	AM-700, AM900, AMS900, AMX-900, AMXR-900, AMXS-900, AMXX-1300, AMXXR-1300, AMXXS-1300, AMXXT, AUXX-1300, AUXXL, AUXXR-1300, AUXXS-1300, AUXXT, ECOMAX-600, ECOMAX-650, ECOMAX-700, FE-W, UX, UX-30E, UX-30EB, UX-30EH, UX-30ES, UX-30ESB, UX-30ESH, UX-30-McDonalds, UX-60E, UX-60EB, UXL, UXLs, UXS, UXT, UXTH, UXTHL, UXTHLS, UXTHS, UXTL, UXTLH, UXTLHS, UXTLS, UXTS		

¹con contactos dorados para aparatos electrónicos



1

código	542136 ¹	referencia	00-378758-001 378758-1
descripción	presostato 3 márgenes de presión margen de presión 40/25 57/37 125/105mbar empalme 6mm ø 79mm conexión de presión horizontal sistemas de lavado apto para HOBART empalme presión ø 6mm		
Para modelos:	FX, HX-30E, HX-30ES, HX-40E, HX-40ES, HX-60-EHL, HX-E, HX-ES		

¹con contactos dorados para aparatos electrónicos

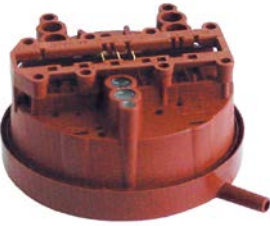
1

código	541319	referencia	231981-3
descripción	presostato margen de presión 35/20mbar empalme 6mm ø 79mm conexión de presión horizontal sistemas de lavado apto para HOBART empalme presión ø 6mm		
Para modelos:	FX, GX, HX, HX-30, HX-30E, HX-30S, HX-40, HX-40E, HX-40S, HX-5		



1

código	541315 ¹	referencia	378758-3
descripción	presostato margen de presión 35/20mbar empalme conector codificado ø 79mm conexión de presión horizontal con contactos dorados para aparatos electrónicos sistemas de lavado apto para HOBART empalme presión ø 6mm		
Para modelos:	FX, GC41, GC42, GX, HX-30E, HX-30ES, HX-40E, HX-40ES, HX-60-EHL, HX-E, HX-ES		

¹con contactos dorados para aparatos electrónicos

transmisores de presión



1

código	541149	referencia	00-775866-202 775866-1
descripción	transmisor de presión margen de presión 0-30mbar tensión de salida 0,5-3,5VDC tensión de entrada 5VDC máx. 200mbar		
Para modelos:	GC11, GC12, GC31, GC32, GC41, GC42		



1

código	541786	referencia	00-775866-002 775866-02 775866-2
descripción	transmisor de presión margen de presión 0-50mbar tensión de salida 0,5-3,5VDC tensión de entrada 5VDC máx. 200mbar		
Para modelos:	AM-10, AM-11, AM-141, AM900-10N, AM900-90, AMS900-10N, AMX, AMX-10HL, AMX-90, AMXR, AMXS, AMXT, AMXTS, AMXX, AMXXR, AMXXS, AUP, AUP-90, AUPS, AUXX, AUXXL-11N, AUXXLS-11N, AUXXR, AUXXS, AUXXT, AUXXTS, ECOMAX-402, ECOMAX-502, ECOMAX-602-10, ECOMAX-602-11, ECOMAX-602S-11, ECOMAX-612-10, ECOMAX-612S-10, FP, FX, FX-McDonalds, GP, GX		
accesorios para	541786		
	código	520027	referencia
			00-324402-005 00-324402-014 139321-126 324402-14 324402-5
tubo flexible de PVC int.ø 4mm ø ext. 7mm L 10m grosor de la pared 1.5mm T máx 60°C transparente			

electródos



1

código	361374	referencia	299956-4
descripción	sonda de conductividad con rosca		
Para modelos:	AM-600, AM-600C, AM-600CR, AM-600R, FM-400H, FM-400U, FM-500, FM-500H, UW-105, UW-135, UW-135H, UW-55		

ventiladores

ventilador axial

importación



1

código	601080 ¹	referencia	00-230324-001
descripción	ventilador axial L 119mm An 119mm H 38mm 230VAC 50/60Hz 23/20W cojinete rodamiento de bolas empalme conector Faston 2,8mm metal ADDA rodete ventilador ø 110mm resis.a la temp. 70°C		
accesorios para	601080		
	código	550898	referencia
			—
cable de conexión longitud del cable 2000mm empalme F 2,8 distancia de empalme 7.9mm para ventilador axial			
	código	692519	referencia
			—
rejilla de protección L 120mm An 120mm plástico			

¹con rodamiento de bolas



bombas







bombas de lavado y aclarado

FIR

bombas







1

código	500598	referencia	139321-490 E929167
descripción	bomba entrada \varnothing 30mm salida \varnothing 26mm tipo 5213E2450 230V 50Hz fases 1 0.22kW 0.1PS L 190mm dirección de rodadura izquierdo condensador 5 μ F FIR		
Para modelos:	CHH-50, CHH-60D, CHH-70D, EH-60, EH-70		
repuestos para	500598		
	código	365017	referencia 00-226568-009 01-235398 01-235399 139321-941 226568-9
	condensador de servicio capacidad 5 μ F 450V tolerancia 5% 50/60Hz temperatura ambiente máx. -25 a + 85°C \varnothing 28mm L 54mm M8 plástico empalme conector Faston 6,3mm 16.10.08 protección		
	código	502265	referencia 139321-976
	cubierta de bomba entrada \varnothing 30mm salida \varnothing 26mm int. \varnothing 89mm altura interior 35mm		
	código	510695	referencia —
	sello mecánico altura contraarandela 5.5mm int. \varnothing 11mm		
	código	521203	referencia —
	rotor \varnothing 72mm H 18mm rosca M7 árbol \varnothing 11mm longitud árbol 32mm palas 3		
	código	532718	referencia —
	junta tórica EPDM espesor 4mm int. \varnothing 80mm UE 1 pzs		
	código	699372	referencia —
	brida para bomba con cubierta tipo 5213 L 103mm An 103mm H 69mm		



1

código	499151	referencia	01-240783-001 01-240783-1
descripción	bomba entrada \varnothing 45mm salida \varnothing 40mm tipo 3910.1421 230V 50Hz fases 1 0.37kW 0.5PS L 190mm dirección de rodadura derecho condensador 10 μ F FIR		
Para modelos:	ECOMAX-502		
repuestos para	499151		
	código	365015	referencia 00-226568-010 226568-10
	condensador de servicio capacidad 10 μ F 400V tolerancia 5%Hz temperatura ambiente máx. -25 a + 85°C \varnothing 35.5mm L 59mm M8 plástico empalme conector Faston 6,3mm protección		
	código	510508	referencia —
	cubierta de bomba FIR entrada \varnothing 45mm salida \varnothing 40mm tipo bomba PU 0,5/3911 sentido de rotación derecho \varnothing 160mm int. \varnothing 125mm altura interior 25mm		
	código	510607	referencia —
	rotor \varnothing 85mm H 29mm soporte de eje \varnothing 9x8mm dirección de rodadura derecho palas 6		
	código	510692	referencia —
	sello mecánico para árbol \varnothing 11mm anillo deslizante \varnothing ext. 24mm anillo deslizante H 13mm contraarandela montaje \varnothing 26mm altura contraarandela 8mm contraarandela \varnothing int. 14mm		
	código	521702	referencia —
	junta de tapa de bomba espesor 3,5x4,5mm UE 1 pzs		



1

código	500400	referencia	774047-1
descripción	bomba entrada \varnothing 45mm salida \varnothing 40mm tipo 4255.1600 230V 50Hz fases 1 0.55kW 0.75PS L 215mm dirección de rodadura derecho condensador 12.5 μ F FIR		
Para modelos:	FE, HE, HE600-HL, HE-P		
repuestos para	500400		
	código	referencia	—
	365014		
	condensador de servicio capacidad 12.5 μ F 450V tolerancia 5%Hz temperatura ambiente máx. -25 a +85°C \varnothing 35mm L 70mm M8 plástico empalme conector Faston 6,3mm 45S.C3DS.12,5 protección		
	código	referencia	—
	510692		
	sello mecánico para árbol \varnothing 11mm anillo deslizante \varnothing ext. 24mm anillo deslizante H 13mm contraarandela montaje \varnothing 26mm altura contraarandela 8mm contraarandela \varnothing int. 14mm		
	código	referencia	—
	521210		
	rotor \varnothing 96mm H 30mm soporte de eje \varnothing 9/8mm soporte \varnothing 16mm palas 6		
	código	referencia	—
	521506		
	cubierta de bomba FIR entrada \varnothing 45mm salida \varnothing 40mm sentido de rotación derecho \varnothing 160mm int. \varnothing 125mm altura interior 25mm		
	código	referencia	—
	521702		
	junta de tapa de bomba espesor 3,5x4,5mm UE 1 pzs		



1

código	499356	referencia	231936-1 775506-1 895499
descripción	bomba tipo 1314A1910 220/240V 50Hz fases 1 0.55kW condensador 12.5 μ F FIR		
Para modelos:	FE-W, FX, GX, HX, HX-30, HX-30E, HX-30ES, HX-30S, HX-40, HX-40E, HX-40ES, HX-40S, HX-60-EHL, HX-E, HX-ES, HX-S		
accesorios para	499356		
	código	referencia	139321-12 323894-12 734530-12 735530-12 896974
	511692		
	sello mecánico juego para árbol \varnothing 12mm \varnothing ext. 24mm H 15mm altura contraarandela 8mm		



HANNING

bombas







1

código	499094	referencia	324913-1 324913-1V
descripción	bomba 220-240V entrada ø 28mm salida ø 26mm 50Hz tipo UP60-343 HANNING L 191mm dirección de rodadura izquierdo velocidad de flujo 110l/min p máx. 0.48bar 0.22kW condensador 5µF fases 1		
Para modelos:	AMX, AMX-900, AMX-E, AMX-ER, AMX-R, AMXR-900, AMXS-900, AMXX-1300, AMXXR-1300, AMXXS-1300, AMXXT, AUX, AUX_, AUX-E, AUX-ER, AUX-R, AUXX-1300, AUXXL, AUXXR-1300, AUXXS-1300, AUXXT, UX, UX-30, UX-30B, UX-30E, UX-30EB, UX-30EH, UX-30H, UX-30-McDonalds, UX-60, UX-60B, UX-60E, UX-60EB, UX-60EH, UX-60EHB, UX-60H, UX-60HB, UXL, UXLS, UXS, UXT, UXTH, UXTHL, UXTHLS, UXTHS, UXTL, UXTLH, UXTLHS, UXTLS, UXTS		



1

código	499147	referencia	00-775854-001 775854-1
descripción	bomba entrada ø 28mm salida ø 26mm tipo UP30-324RU 220-240V 50Hz fases 1 0.14kW L 170mm dirección de rodadura izquierdo condensador 4µF HANNING		
Para modelos:	AM900-10N, AM900-90, AMS900-10N, AMX, AMX-10HL, AMX-90, AMXR, AMXS, AMXT, AMXTS, AMXX, AMXXR, AMXXS, AUP, AUP-90, AUPS, AUXX, AUXXL-11N, AUXXLS-11N, AUXXR, AUXXS, AUXXT, AUXXTS, ECOMAX-402, ECOMAX-502, ECOMAX-602-11, ECOMAX-602S-11, ECOMAX-612-10, ECOMAX-612S-10, FX, FX-McDonalds, GC41, GC42		
repuestos para	499147		
	código	365031	referencia 00-226568-002 226568-2
	condensador de servicio capacidad 4µF 450V tolerancia 5% 50/60Hz temperatura ambiente máx. -25 a + 85°C ø 31mm L 58mm M8 plástico empalme conector Faston 6,3mm protección		
	código	507558	referencia —
	sello mecánico para árbol ø 7mm altura contraarandela 5mm int.ø 6.75mm ø ext. 20mm montaje ø contraarandela 18,5/arandela fricción 20mm		

repuestos para	499147		
	código	532644	referencia —
	junta tórica EPDM espesor 3mm int.ø 78mm UE 1 pzs		
accesorios para	499147		
	código	507498	referencia 00-883837-001 883837-1
	chapa protectora para bomba de lavado apto para HOBART L 300mm An 200mm		



1

código	499213	referencia	01-240234-101
descripción	bomba entrada ø 28mm salida ø 26mm tipo UP30-439Ru. 220-240V 50Hz fases 1 0.14kW L 160mm dirección de rodadura izquierdo condensador 4µF HANNING		





1

código	500534	referencia	00-324093-021 324093-21
descripción	bomba entrada ø 28mm salida ø 26mm tipo UP60-184 230V 50Hz fases 1 0.27kW 0.37PS L 190mm dirección de rodadura izquierdo condensador 5µF HANNING p máx. 0.77bar Qmáx. 160l/min		
Para modelos:	AM3, AMX, AMX-900, AMX-E, AMX-ER, AMX-R, AMXR-900, AMXS-900, AMXX-1300, AMXXR-1300, AMXXS-1300, AMXXT, AUX, AUX_, AUX-E, AUX-ER, AUX-R, AUXX-1300, AUXXL, AUXXR-1300, AUXXS-1300, AUXXT, ECOMAX-402, ECOMAX-650, ECOMAX-700, UX, UXL, UXLS, UXS, UXT, UXTH, UXTHL, UXTHLS, UXTHS, UXTL, UXTLH, UXTLHS, UXTLS, UXTS		
repuestos para	500534		
	código	365017	referencia 00-226568-009 01-235398 01-235399 139321-941 226568-9
	condensador de servicio capacidad 5µF 450V tolerancia 5% 50/60Hz temperatura ambiente máx. -25 a + 85°C ø 28mm L 54mm M8 plástico empalme conector Faston 6,3mm 16.10.08 protección		



Continúa en la página siguiente



repuestos para	500534		
	código	507558	referencia —
	sello mecánico para árbol ø 7mm altura contraarandela 5mm int.ø 6.75mm ø ext. 20mm montaje ø contraarandela 18,5/arandela fricción 20mm		
	código	532644	referencia —
	junta tórica EPDM espesor 3mm int.ø 78mm UE 1 pzs		



1

código	499068	referencia	324093-1V
descripción	bomba entrada ø 28mm salida ø 26mm tipo UP60-313 230V 50Hz fases 1 0.25kW 0.34PS L 190mm dirección de rodadura izquierdo condensador 5µF HANNING		
repuestos para	499068		
	código	365017	referencia 00-226568-009 01-235398 01-235399 139321-941 226568-9
	condensador de servicio capacidad 5µF 450V tolerancia 5% 50/60Hz temperatura ambiente máx. -25 a + 85°C ø 28mm L 54mm M8 plástico empalme conector Faston 6,3mm 16.10.08 protección		
	código	507558	referencia —
	sello mecánico para árbol ø 7mm altura contraarandela 5mm int.ø 6.75mm ø ext. 20mm montaje ø contraarandela 18,5/arandela fricción 20mm		
	código	532644	referencia —
	junta tórica EPDM espesor 3mm int.ø 78mm UE 1 pzs		



1



código	499149	referencia	00-324093-021V 324093-21V
descripción	bomba entrada ø 28mm salida ø 26mm tipo UP60-315RU 220-240V 50Hz fases 1 0.25kW L 185mm dirección de rodadura izquierdo condensador 5µF HANNING países UK		
repuestos para	499149		
	código	365017	referencia 00-226568-009 01-235398 01-235399 139321-941 226568-9
	condensador de servicio capacidad 5µF 450V tolerancia 5% 50/60Hz temperatura ambiente máx. -25 a + 85°C ø 28mm L 54mm M8 plástico empalme conector Faston 6,3mm 16.10.08 protección		
	código	507558	referencia —
	sello mecánico para árbol ø 7mm altura contraarandela 5mm int.ø 6.75mm ø ext. 20mm montaje ø contraarandela 18,5/arandela fricción 20mm		
	código	532644	referencia —
	junta tórica EPDM espesor 3mm int.ø 78mm UE 1 pzs		



1

código	499284	referencia	324914-1 324914-1V
descripción	bomba entrada ø 28mm salida ø 26mm tipo UP60-321 Ru. 220-240V 50Hz fases 1 0.27kW L 190mm dirección de rodadura derecho condensador 5µF HANNING		
Para modelos:	UX-30, UX-30B, UX-30E, UX-30EB, UX-30EH, UX-30ES, UX-30ESB, UX-30ESH, UX-30H, UX-30-McDonalds, UX-30S, UX-30SB, UX-30SH, UX-60, UX-60B, UX-60E, UX-60EB, UX-60EH, UX-60EHB, UX-60H, UX-60HB		
repuestos para	499284		
	código	365017	referencia 00-226568-009 01-235398 01-235399 139321-941 226568-9
	condensador de servicio capacidad 5µF 450V tolerancia 5% 50/60Hz temperatura ambiente máx. -25 a + 85°C ø 28mm L 54mm M8 plástico empalme conector Faston 6,3mm 16.10.08 protección		

Continúa en la página siguiente

repuestos para	499284		
	código	507558	referencia —
	sello mecánico para árbol ø 7mm altura contraarandela 5mm int.ø 6.75mm ø ext. 20mm montaje ø contraarandela 18,5/ arandela fricción 20mm		
	código	532644	referencia —
	junta tórica EPDM espesor 3mm int.ø 78mm UE 1 pzs		



1

código	499112	referencia	774908-108 774908-108V
descripción	bomba entrada ø 32,5mm salida ø 1" tipo UP60-341 Ru 220-240/380-415V 50/60Hz 0.16kW HANNING sin rotor p máx. 0.68bar Qmáx. 160l/min		



1

código	499000	referencia	781237 781237-1 781237-1V
descripción	bomba entrada ø 32mm salida ø 1" tipo UP60-334 230V 50Hz fases 1 0.24kW L 250mm dirección de rodadura izquierdo condensador 5µF HANNING p máx. 0.35bar Qmáx. 85l/min		
Para modelos:	CN, CNA, CNB, CNR, CR, CR-F, CSA, FTN		



1



código	499040	referencia	781237-2
descripción	bomba entrada ø 32mm salida ø 1" tipo UP60-335 230V 50Hz fases 1 0.27kW L 250mm dirección de rodadura izquierdo condensador 5µF HANNING p máx. 0.68bar Qmáx. 160l/min		
Para modelos:	CNA, CNB, CNR, CR-F, CSA, FTN		



1

código	499092	referencia	775465-1 897929
descripción	bomba entrada ø salida ø 26mm tipo 220-240V 50Hz fases 1 0.1kW L 135mm condensador 4µF p máx. 0.55bar HANNING brida ø 92mm velocidad de flujo 45l/min		
Para modelos:	AM900, AMS900, FX, GC, GC31, GC32, GC41, GC42, GX		
accesorios para	499092		
	código	510427	referencia 775465-11
	junta tórica EPDM espesor 3mm int.ø 83mm UE 1 pzs		

**LGB**





1			
código	499150	referencia	00-883833-001 883833-1
descripción	bomba entrada \varnothing 45mm salida \varnothing 40mm tipo ZF220SX 230V 50Hz fases 1 0.4kW L 190mm dirección de rodadura derecho condensador 12.5 μ F LGB		
Para modelos:	AM-10, AM-11, AM-141, ECOMAX-602-10, ECOMAX-602-11, ECOMAX-602S-11		
repuestos para	499150		
	código	521036	referencia 00-883833-010 883833-10
	kit de servicio para bomba tipo ZF220SX HOBART 50Hz rotor, junta cubiertas de bomba, sello mecánico		
accesorios para	499150		
	código	365014	referencia —
	condensador de servicio capacidad 12.5 μ F 450V tolerancia 5%Hz temperatura ambiente máx. -25 a + 85°C \varnothing 35mm L 70mm M8 plástico empalme conector Faston 6,3mm 45S.C3DS.12,5 protección		





1			
código	500543	referencia	130126 139321-512 E130126
descripción	bomba entrada \varnothing 50mm salida \varnothing 50mm tipo ZF400VSX 230V 50Hz fases 1 0.85kW 1.2PS L 245mm dirección de rodadura derecho condensador 16 μ F LGB		
Para modelos:	ECOMAX-500		
repuestos para	500543		
	código	365021	referencia 00-226568-013 139321-448 139321-884 226568-13
	condensador de servicio capacidad 16 μ F 425V tolerancia 5% 50/60Hz temperatura ambiente máx. -25 a + 85°C \varnothing 35mm L 73mm simple M8 plástico empalme conector Faston 6,3mm 416.10.99 protección		

repuestos para	500543		
	código	509020	referencia 139321-509
	rotor \varnothing 104mm H 25mm M8L		
	código	510703	referencia 139321-446
	sello mecánico para árbol \varnothing 13mm anillo deslizante H 13mm altura contraarandela 5.5mm \varnothing ext. 26mm		
	código	521548	referencia 139321-889
	cubierta de bomba LGB entrada \varnothing 50mm salida \varnothing 50mm		
	código	521734	referencia 139321-887
	parte inferior de tapa de boma		
	código	532623	referencia —
	junta tórica EPDM espesor 2.62mm int. \varnothing 120.32mm UE 1 pzs		



1			
código	500361	referencia	139321-548 139321-963
descripción	bomba entrada \varnothing 60mm salida \varnothing 49mm tipo ZF400SX 230V 50Hz fases 1 0.8kW 1PS L 210mm dirección de rodadura derecho condensador 16 μ F LGB		
Para modelos:	CHH-50		
repuestos para	500361		
	código	365021	referencia 00-226568-013 139321-448 139321-884 226568-13
	condensador de servicio capacidad 16 μ F 425V tolerancia 5% 50/60Hz temperatura ambiente máx. -25 a + 85°C \varnothing 35mm L 73mm simple M8 plástico empalme conector Faston 6,3mm 416.10.99 protección		
	código	509020	referencia 139321-509
	rotor \varnothing 104mm H 25mm M8L		
	código	510703	referencia 139321-446
	sello mecánico para árbol \varnothing 13mm anillo deslizante H 13mm altura contraarandela 5.5mm \varnothing ext. 26mm		
	código	521547	referencia —
	cubierta de bomba LGB entrada \varnothing 60mm salida \varnothing 50mm presión secundaria M8 sentido de rotación derecho \varnothing 160mm int. \varnothing 127mm altura interior 36mm		
	código	521736	referencia —
	parte inferior de tapa de boma parte inferior		

Continúa en la página siguiente

repuestos para	500361		
	código	532623	referencia —
	junta tórica EPDM espesor 2.62mm int.ø 120.32mm UE 1 pzs		
accesorios para	500361		
	código	513264	referencia —
	escuadra de sujeción para bomba de lavado		



código	499114	referencia	898253-1
descripción	bomba entrada ø 60mm salida ø 50mm 220-240V 50Hz fases 1 0.7kW L 245mm dirección de rodadura derecho condensador 16µF		
Para modelos:	AM-700, AM900, AMS900, AMX-900, AMXR-900, AMXS-900, ECO-MAX-600, ECOMAX-650		
repuestos para	499114		
	código	365021	referencia 00-226568-013 139321-448 139321-884 226568-13
	condensador de servicio capacidad 16µF 425V tolerancia 5% 50/60Hz temperatura ambiente máx. -25 a + 85°C ø 35mm L 73mm simple M8 plástico empalme conector Faston 6,3mm 416.10.99 protección		
	código	509020	referencia 139321-509
	rotor ø 104mm H 25mm M8L		
	código	510703	referencia 139321-446
	sello mecánico para árbol ø 13mm anillo deslizando H 13mm altura contraarandela 5.5mm ø ext. 26mm		
	código	521049	referencia 898253-10
	kit de servicio para bomba tipo ZF400VSX LGB rotor, 2x junta tórica, sello mecánico, condensador capacidad 16µF		
	código	521547	referencia —
	cubierta de bomba LGB entrada ø 60mm salida ø 50mm presión secundaria M8 sentido de rotación derecho ø 160mm int.ø 127mm altura interior 36mm		
	código	532623	referencia —
	junta tórica EPDM espesor 2.62mm int.ø 120.32mm UE 1 pzs		

OLYMPIA

bombas



1

código	500535	referencia	371450-2
descripción	bomba entrada ø salida ø 27mm tipo T70 230V 50Hz fases 1 0.3kW 0.4PS L 130mm dirección de rodadura derecho condensador 6.3µF OLYMPIA		
Para modelos:	GF-60, GF-60S		
repuestos para	500535		
	código	365012	referencia 206009
	condensador de servicio capacidad 6.3µF 450V tolerancia 5% 50Hz temperatura ambiente máx. -25 a + 85°C ø 30mm L 61mm M8 plástico empalme conector Faston 6,3mm protección		
	código	510556	referencia —
	junta tórica EPDM espesor 1.78mm int.ø 94.97mm UE 1 pzs tipo bomba T110		
	código	510693	referencia 139321-12
	sello mecánico para árbol ø 12mm anillo deslizando ø ext. 24mm anillo deslizando H 15.5mm anillo deslizando ø int. 11mm contraarandela montaje ø 24mm altura contraarandela 8mm contraarandela ø int. 13.5mm		
	código	521254	referencia
	rotor ø 81mm H 11mm rosca M8L árbol ø 12mm longitud árbol 28mm palas 6		

motores para bombas de lavado



1



código	499106	referencia	324818-34
descripción	motor de boma tipo 1326 1500W 220-240/380-415V 50/60Hz fases 3 L 330mm An 200mm H 240mm 1400/1700rev/min árbol ø 22/25mm		
Para modelos:	CR-F		



bombas de aumento de presión I



1

código	500359	referencia	139321-651 139321-661
descripción	bomba entrada \varnothing 12 salida \varnothing 12 tipo PPL46DX 230V 50Hz 0.33kW condensador 10 μ F LGB		
Para modelos:	CHF45, CLG-25, EF-40		
repuestos para	500359		
	código	698663	referencia —
	rotor \varnothing 60mm H 12mm con ranura soporte de eje \varnothing 12mm An 60mm para LGB		
accesorios para	500359		
	código	365015	referencia 00-226568-010 226568-10
	condensador de servicio capacidad 10 μ F 400V tolerancia 5%Hz temperatura ambiente máx. -25 a + 85°C \varnothing 35.5mm L 59mm M8 plástico empalme conector Faston 6,3mm protección		



1

código	500358	referencia	139321-1085
descripción	bomba entrada \varnothing 3/8" salida \varnothing 3/8" tipo PS46 230V 50Hz 0.45kW \varnothing 100mm L 200mm condensador 10 μ F LGB		
repuestos para	500358		
	código	510713	referencia —
	arandela fricción para árbol \varnothing 12mm \varnothing ext. 24mm H 16mm		
	código	510723	referencia —
	contraarandela H 8mm \varnothing ext. 26mm int. \varnothing 13.5mm per sello mecánico		
	código	698400	referencia —
	junta de tapa de bomba tipo bomba PS46 espesor 2mm int. \varnothing 66mm UE 1 pzs		
accesorios para	500358		
	código	365015	referencia 00-226568-010 226568-10
	condensador de servicio capacidad 10 μ F 400V tolerancia 5%Hz temperatura ambiente máx. -25 a + 85°C \varnothing 35.5mm L 59mm M8 plástico empalme conector Faston 6,3mm protección		
	código	511279	referencia —
	empalme de tubo latón recto rosca 3/8" tubo \varnothing 12mm UE 1 pzs		
	código	520202	referencia —
	empalme de tubo latón niquelado recto rosca 3/8" tubo \varnothing 12mm UE 1 pzs		
	código	520677	referencia —
	empalme de tubo latón recto rosca 3/8" tubo \varnothing 13mm UE 1 pzs		

bombas de salida

ASKOLL



1

código	500210	referencia	E130123
descripción	bomba de desagüe 230V 40W		



1

código	501541	referencia	139321-1110
descripción	bomba de desagüe 40W 220-240V entrada \varnothing 30mm salida \varnothing 22mm 50Hz ASKOLL tipo M231 XP		
Para modelos:	CHH-50, CHH-60D, CHH-70D, EH-60, EH-70		



1

código	500346	referencia	130105
descripción	bomba de desagüe entrada \varnothing 30mm salida \varnothing 22mm 230V 40W 50Hz ASKOLL tipo M231 XP con soporte		



GRE



1

código	500212	referencia	371450-1
descripción	bomba de desagüe entrada ømm salida ømm 100W 230V 50Hz GRE sin tapa		
Para modelos:	GF-60, GF-60S		

HANNING



1

código	499094	referencia	324913-1 324913-1V
descripción	bomba 220-240V entrada ø 28mm salida ø 26mm 50Hz tipo UP60-343 HANNING L 191mm dirección de rodadura izquierdo velocidad de flujo 110l/min p máx. 0.48bar 0.22kW condensador 5µF fases 1		
Para modelos:	AMX, AMX-900, AMX-E, AMX-ER, AMX-R, AMXR-900, AMXS-900, AMXX-1300, AMXXR-1300, AMXXS-1300, AMXXT, AUX, AUX_, AUX-E, AUX-ER, AUX-R, AUXX-1300, AUXXL, AUXXR-1300, AUXXS-1300, AUXXT, UX, UX-30, UX-30B, UX-30E, UX-30EB, UX-30EH, UX-30H, UX-30-McDonalds, UX-60, UX-60B, UX-60E, UX-60EB, UX-60EH, UX-60EHB, UX-60H, UX-60HB, UXL, UXLS, UXS, UXT, UXTH, UXTHL, UXTHLS, UXTHS, UXTL, UXTLH, UXTLHS, UXTLS, UXTS		
repuestos para	499094		
	código	365017	referencia 00-226568-009 01-235398 01-235399 139321-941 226568-9
	condensador de servicio capacidad 5µF 450V tolerancia 5% 50/60Hz temperatura ambiente máx. -25 a + 85°C ø 28mm L 54mm M8 plástico empalme conector Faston 6,3mm 16.10.08 protección		



1

código	502290	referencia	00-775854-003 775854-3
descripción	bomba de desagüe 140-160W 220-240V entrada ø 28mm salida ø 26mm 50-60Hz tipo UP30-420 HANNING empalme conector codificado p máx. 0.65bar Qmáx. 115l/min		
Para modelos:	AMXR, AMXXR, AUXXR		



1

código	499319	referencia	01-240010-001 01-240010-1
descripción	bomba de desagüe 65W 230V entrada ømm salida ømm 50Hz tipo BE20B2-083 HANNING sin tapa		
Para modelos:	FP, FX, FX-McDonalds, GP, GX		



1

código	499148	referencia	00-165653-001 00-883993-001 165653-1 883993-1
descripción	bomba de desagüe 80W 220-240V entrada ø 24mm salida ø 24mm 50Hz tipo BE22B3-197 HANNING dirección de rodadura derecho		
Para modelos:	AM-600, AM-600C, AM-600CR, AM-600R, AM-700, AM900, AM900-10N, AM900-90, AMS900, AMS900-10N, AMX, AMX-10HL, AMX-90, AMXR, AMXS, AMXT, AMXTS, AMXX, AMXXR, AMXXS, AUP, AUP-90, AUPS, AUXX, AUXXL-11N, AUXXLS-11N, AUXXR, AUXXS, AUXXT, AUXXTS, ECOMAX-600, ECOMAX-602S-11, ECOMAX-612-10, ECOMAX-612S-10, ECOMAX-650, ECOMAX-700, FE, FM-30U, GC, GC11, GC12, GC31, GC32, GC41, GC42, HE, HE600-HL, HE-P, UW-105, UW-55		

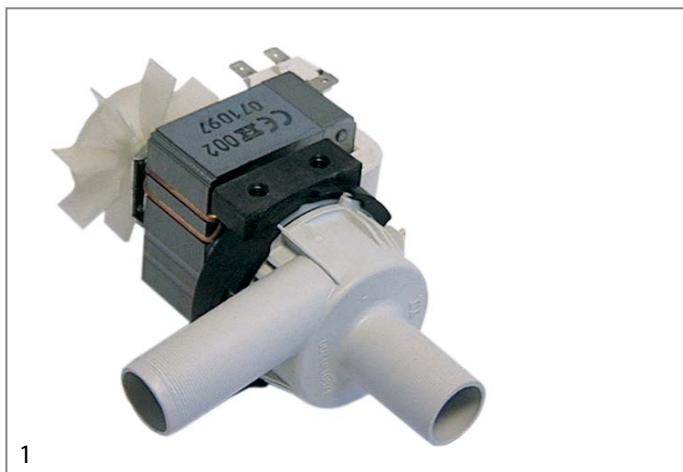

1

código	500042	referencia	165653-1 old version
descripción	bomba de desagüe 80W 230V entrada ø 24mm salida ø 24mm 50Hz tipo KD22B3-679 HANNING		
repuestos para	500042		
	código	510168	referencia —
	rodete ventilador soporte de eje ø 5mm ø 62mm H 14mm		

bombas de aumento de presión II

accesorios



1

código	365015	referencia	00-226568-010 226568-10
descripción	condensador de servicio capacidad 10µF 400V tolerancia 5%Hz temperatura ambiente máx. -25 a + 85°C ø 35.5mm L 59mm M8 plástico empalme conector Faston 6,3mm protección		



1

código	365017	referencia	00-226568-009 01-235398 01-235399 139321-941 226568-9
descripción	condensador de servicio capacidad 5µF 450V tolerancia 5% 50/60Hz temperatura ambiente máx. -25 a + 85°C ø 28mm L 54mm M8 plástico empalme conector Faston 6,3mm 16.10.08 protección		
Para modelos:	AMX, AMX-900, AMX-E, AMX-ER, AMX-R, AMXR-900, AMXS-900, AMXX-1300, AMXXR-1300, AMXXS-1300, AMXXT, AUX, AUX_, AUX-E, AUX-ER, AUX-R, AUXX-1300, AUXXL, AUXXR-1300, AUXXS-1300, AUXXT, CHH-70D, ECOMAX-402, ECOMAX-650, ECOMAX-700, EH-70, FE, FE-W, FX, GX, HX-30, HX-30E, HX-30ES, HX-30S, HX-40, HX-40E, HX-40ES, HX-40S, UX, UX-30, UX-30B, UX-30E, UX-30EB, UX-30EH, UX-30ES, UX-30ESB, UX-30H, UX-30-McDonalds, UX-30S, UX-30SB...(Otros modelos se puede ver en la tienda web)		

accesorios

juntas para cubiertas de bomba



1

código	524923	referencia	00-119038-00003 00-135127-004 119038-3 135127-4
descripción	junta de tapa de bomba Tesnit BA-50 espesor 1mm int.ø 135mm UE 1 pzs		
Para modelos:	AM-12E, AM-12EC, AM-12EF, AM-12ER, AM-600, AM-600C, AM-600CR, AM-600R, UW-100, UW-105, UW-120, UW-125, UW-200, UW-205		

condensadores y filtros antiparasitarios

condensadores de servicio

plástico



1

código	365167	referencia	226568-3
descripción	condensador capacidad 6µF 450V tolerancia 5% 50Hz temperatura ambiente máx. -25 a + 85°C ø 30mm L 58mm M8 plástico empalme conector Faston 6,3mm		
Para modelos:	FE, G10R, G5R, HE-P, HX, HX-60-EHL, HX-E, HX-ES, HX-S, UX-30, UX-30B, UX-30E, UX-30EB, UX-30EH, UX-30ES, UX-30ESB, UX-30ESH, UX-30H, UX-30-McDonalds, UX-30S, UX-30SB, UX-30SH, UX-60, UX-60B, UX-60E, UX-60EB, UX-60EH, UX-60EHB, UX-60H, UX-60HB		



1

código	365015	referencia	00-226568-010 226568-10
descripción	condensador de servicio capacidad 10µF 400V tolerancia 5%Hz temperatura ambiente máx. -25 a + 85°C ø 35.5mm L 59mm M8 plástico empalme conector Faston 6,3mm protección		



			
1			
código	365021	referencia	00-226568-013 139321-448 139321-884 226568-13
descripción	condensador de servicio capacidad 16µF 425V tolerancia 5% 50/60Hz temperatura ambiente máx. -25 a + 85°C ø 35mm L 73mm simple M8 plástico empalme conector Faston 6,3mm 416.10.99 protección		
Para modelos:	AM-700, AM900, AM900-10N, AM900-90, AMS900, AMS900-10N, AMX, AMX-10HL, AMX-90, AMX-900, AMXR, AMXR-900, AMXS, AMXS-900, AMXT, AMXTS, CHF45, ECOMAX-600, ECOMAX-612-10, ECOMAX-612S-10, ECOMAX-650, EF-40		

			
2			
código	365031	referencia	00-226568-002 226568-2
descripción	condensador de servicio capacidad 4µF 450V tolerancia 5% 50/60Hz temperatura ambiente máx. -25 a + 85°C ø 31mm L 58mm M8 plástico empalme conector Faston 6,3mm protección		

			
1			
código	365017	referencia	00-226568-009 01-235398 01-235399 139321-941 226568-9
descripción	condensador de servicio capacidad 5µF 450V tolerancia 5% 50/60Hz temperatura ambiente máx. -25 a + 85°C ø 28mm L 54mm M8 plástico empalme conector Faston 6,3mm 16.10.08 protección		
Para modelos:	AMX, AMX-900, AMX-E, AMX-ER, AMX-R, AMXR-900, AMXS-900, AMXX-1300, AMXXR-1300, AMXXS-1300, AMXXT, AUX, AUX-, AUX-E, AUX-ER, AUX-R, AUXX-1300, AUXXL, AUXXR-1300, AUXXS-1300, AUXXT, CHH-70D, ECOMAX-402, ECOMAX-650, ECOMAX-700, EH-70, FE-W, FX, GX, HX-30, HX-30E, HX-30ES, HX-30S, HX-40, HX-40E, HX-40ES, HX-40S, UX, UX-30, UX-30B, UX-30E, UX-30EB, UX-30EH, UX-30ES, UX-30ESB, UX-30H, UX-30-McDonalds, UX-30S, UX-30SB...(Otros modelos se puede ver en la tienda web)		

filtros

filtros antiparasitarios

			
1			
código	365044	referencia	926144 E926144
descripción	filtro antiparasitario tipo FC701Y2F 250V 50-60Hz conductor 2 con T empalme cable 200mm L 42mm ø 23mm Hmm Anmm plástico UE 1 pzs		

fusibles

fusibles finos

			
1			
código	358666	referencia	926283 E926283
descripción	fusible fino medida ø5x20mm 0.315A rápido nominal 250V UE 10 pzs		

			
1			
código	358606	referencia	228010 E228010
descripción	fusible fino medida ø5x20mm 4A retardado nominal 250V UE 10 pzs		

			
1			
código	358742	referencia	775570-2
descripción	fusible fino medida ø6,3x32mm 0.8A rápido nominal 500V UE 10 pzs		

			
1			
código	358751	referencia	00-775570-001 775570-1
descripción	fusible fino medida ø6,3x32mm 6.3A rápido nominal 500V UE 10 pzs		
Para modelos:	AMX-900, AMXS-900, AMXX-1300, AMXXT, AUXX-1300, AUXXT, ECOMAX-650, UX, UXL, UXLS, UXS, UXT, UXTH, UXTHL, UXTHLS, UXTHS, UXTL, UXTLS, UXTS		

portafusibles

			
1			
código	358026	referencia	00-775548-001 775548-1
descripción	portafusibles fusible adaptable ø6,3x32mm 10A nominal 800V L 61mm An 10mm H 65mm sección nominal 4mm ²		
Para modelos:	AMX-900, AMXS-900, AMXX-1300, AMXXT, AUXX-1300, AUXXT, ECOMAX-402, ECOMAX-502, ECOMAX-650, UX, UXL, UXLS, UXS, UXT, UXTH, UXTHL, UXTHLS, UXTHS, UXTL, UXTLS, UXTS		



accesorios eléctricos

cables

accesorios

pasacables

pasacables



1

código	551102	referencia	00-227748-001 227748-1
descripción	boquilla pasacables int.ø 10mm montaje ø 12mm Neoprene -30 a +120°C UE 1 pzs		
Para modelos:	AM-10, AM-11, AM-141, AM-600, AM-600C, AM-600CR, AM-600R, AM900-10N, AM900-90, AMS900-10N, AMX, AMX-10HL, AMX-90, AMX-E, AMX-ER, AMXR, AMX-R, AMXS, AMXT, AMXTS, AMXX, AMXXR, AMXXS, AUP, AUP-90, AUPS, AUX, AUX_, AUX-E, AUX-ER, AUX-R, AUXX, AUXXL-11N, AUXXLS-11N, AUXXR, AUXXS, AUXXT, AUXXTS, CN-Protronic, CN-Smartronic, CP-Protronic, CS-Easytronic, CX, ECOMAX-602-10, ECOMAX-602-11, ECOMAX-602S-11, ECOMAX-612-10, ECOMAX-612S-10, FM-30, FM-30U...(Otros modelos se puede ver en la tienda web)		

racores para cables

uniones roscadas



1

código	524662	referencia	00-695661-004 695661-4
descripción	racor para cables rosca M25 ø cable 16mm montaje ø 25mm UE 1 pzs plástico EC 33		
Para modelos:	ECOMAX-402, ECOMAX-502		



1

código	524663	referencia	00-695661-005 695661-5
descripción	racor para cables rosca M32 ø cable 21mm montaje ø 32mm UE 1 pzs plástico EC 42		
Para modelos:	AM-10, AM-11, AM-141, AM-700, AM900-10N, AM900-90, AMS900-10N, AMX, AMX-10HL, AMX-90, AMX-900, AMXR, AMXR-900, AMXS, AMXS-900, AMXT, AMXTS, AMXX, AMXX-1300, AMXXR, AMXXR-1300, AMXXS, AMXXS-1300, AMXXT, AUP, AUP-90, AUPS, AUX, AUXX-1300, AUXXL, AUXXL-11N, AUXXLS-11N, AUXXR, AUXXR-1300, AUXXS, AUXXS-1300, AUXXT, AUXXTS, ECOMAX-600, ECOMAX-602-10, ECOMAX-602-11, ECOMAX-602S-11, ECOMAX-612-10, ECOMAX-612S-10, ECOMAX-650, ECOMAX-700, UX, UXL, UXLS, UXS...(Otros modelos se puede ver en la tienda web)		

cables de cinta plana

grupo 1



1

código	402970	referencia	139321-1011
descripción	cable de cinta plana 10 polos L 1200mm tipo de conector 2 filas codificado UE 1m		

terminales

regletas de bornes a tornillo/con contactos de enchufe



1

código	550411	referencia	139321-582 774055-1
descripción	borne de conexión 6 polos máx. 40A máx. 450V empalme ø6mm ² / F6,3 resis.a la temp. 150°C sección nominal 6mm ²		
Para modelos:	AMX-900, AMXS-900, AMXX-1300, AMXXT, AUXX-1300, AUXXT, CHF45, CHH-50, CHH-60D, CHH-70D, ECOMAX-650, EF-40, EH-60, EH-70, FE, FE-W, FX, GC, GC11, GC12, GC31, GC32, GC41, GC42, GX, HE, HE600-HL, HE-P, UX, UXL, UXLS, UXS, UXT, UXTH, UXTHL, UXTHLS, UXTHS, UXTL, UXTLS, UXTS		

cajas de control



1

código	524664	referencia	00-229169-007 229169-7
descripción	junta para caja de distribución L 415mm An 12mm gomaespuma		
Para modelos:	AM-10, AM-11, AM-141, AM900-10N, AM900-90, AMS900-10N, AMX, AMX-10HL, AMX-90, AMXR, AMXS, AMXT, AMXTS, AMXX, AMXXR, AMXXS, AUP, AUP-90, AUPS, AUX, AUXX, AUXXL-11N, AUXXLS-11N, AUXXR, AUXXS, AUXXT, AUXXTS, ECOMAX-602-10, ECOMAX-602-11, ECOMAX-602S-11, ECOMAX-612-10, ECOMAX-612S-10, RRB		

componentes electrónicos

inversor





1

código	402902	referencia	916894
descripción	inversor 200-240V apto para HOBART		



componentes específicos

unidades de infusión			
juntas pra portafiltro			
juntas tóricas			
			
1			
código	510409	referencia	00-276903-053 00-67500-016 00-67500-118 276903-53 670500-118 67500-16
descripción	junta tórica EPDM espesor 5.34mm int.ø 56.52mm UE 1 pzs		
Para modelos:	CR-F, CX, ECW, EWB-S, FTN, FTT, FTX, FUX, ML-104674, ML-104683, ML-104686, UW-135, UW-135H, UWX, UX-60, UX-60B, UX-60E, UX-60EB, UX-60EH, UX-60EHB, UX-60H, UX-60HB, UXT, UXTH, UXTHL, UXTHLS, UXTHS, UXTL, UXTLH, UXTLHS, UXTLS, UXTS, V1401		

			
1			
código	518064	referencia	139321-912
descripción	cuerpo de aspiración ø ext. 140mm int.ø 102mm tubo ø 50/60mm		
Para modelos:	CHH-50, CHH-60D, CHH-70D, EH-60, EH-70		

			
1			
código	518060	referencia	139321-913
descripción	junta goma ø ext. 132mm int.ø 122mm espesor 5mm		
Para modelos:	CHH-50, CHH-60D, CHH-70D, EH-60, EH-70		

para lavavajillas

componentes de salida/aspiración			
HOBART			
cuerpo de salida/aspiración			
			
1			
código	511677	referencia	00-324053-000 00-886639-000
descripción	brida con junta ø ext. 107mm int.ø 70mm para bomba		
Para modelos:	CN-Protronic, CN-Smartronic, CP-Protronic, CR-F, CS-Easytronic, ECOMAX-402, ECOMAX-502, FE-W, FX, GC, GC11, GC12, GC31, GC32, GC41, GC42, GX, HX, HX-30, HX-30E, HX-30ES, HX-30S, HX-40, HX-40E, HX-40ES, HX-40S, HX-60-EHL, HX-E, HX-ES, HX-S		

			
1			
código	507496	referencia	00-324056-000
descripción	junta ø ext. 100mm int.ø 80mm		
Para modelos:	CN, CNA, CNB, CN-Protronic, CNR, CN-Smartronic, CP-Protronic, CR, CR-F, CS-Easytronic, ECOMAX-402, ECOMAX-502, FE, FE-W, FTN, FX, GC, GC11, GC12, GC31, GC32, GC41, GC42, GX, HE, HE600-HL, HE-P, HX, HX-30, HX-30E, HX-30ES, HX-30S, HX-40, HX-40E, HX-40ES, HX-40S, HX-60-EHL, HX-E, HX-ES, HX-S, UX-60, UX-60B, UX-60E, UX-60EB		

			
1			
código	517404	referencia	00-323802-001 323802-1
descripción	cuerpo de aspiración ø ext. 105mm H 110mm int.ø 75mm tubo ø 31mm		
Para modelos:	CR, CR-F, ECOMAX-402, ECOMAX-502, FE, GC, GC11, GC12, GC31, GC32, GC41, GC42, HE, HE600-HL, HE-P		

			
1			
código	524906	referencia	323785-101
descripción	junta por pileta de desagüe ø 14mm		
Para modelos:	FX, GX		

			
1			
código	511962	referencia	172986-15
descripción	junta plana goma ø ext. 62mm int.ø 44mm espesor 0.9mm UE 1 pzs		
Para modelos:	AM-600, AM-600C, AM-600CR, AM-600R, FM-400H, FM-400U, FM-500, FM-500H, FTX, FUX, UW-105, UW-120, UW-135, UW-135H, UW-200, UW-55, UWX		

componentes mecánicos y accesorios aparatos



			
1			
código	524907	referencia	297986-1
descripción	pileta de desagüe rosca 1¼" ø ext. 64.5mm int.ø 41mm		
Para modelos:	AM-600, AM-600C, AM-600CR, AM-600R, FM-400H, FM-400U, FM-500, FM-500H, UW-105, UW-135, UW-135H, UW-55		

			
1			
código	518187	referencia	139321-652
descripción	pileta de desagüe rosca 3/4" int.ø 22mm		
Para modelos:	CHF45, CHH-70D, CLG-25, EF-40, EH-70		

			
1			
código	518065	referencia	139321-914
descripción	soporte filtro H 140mm ø 140mm		
Para modelos:	CHH-50, CHH-60D, CHH-70D, EH-60, EH-70		

filtros

			
1			
código	517584	referencia	00-324768-000
descripción	filtro ø 138mm H 86mm		
Para modelos:	AMX, AMX-900, AMX-E, AMX-ER, AMX-R, AMXR-900, AMXS-900, AMXX-1300, AMXXR-1300, AMXXS-1300, AMXXT, AUX, AUX_, AUX-E, AUX-ER, AUX-R, AUXX-1300, AUXXL, AUXXR-1300, AUXXS-1300, AUXXT, UX, UX-30, UX-30B, UX-30E, UX-30EB, UX-30EH, UX-30ES, UX-30ESB, UX-30ESH, UX-30H, UX-30-McDonalds, UX-30S, UX-30SB, UX-30SH, UX-60, UX-60B, UX-60E, UX-60EB, UX-60EH, UX-60EHB, UX-60H, UX-60HB, UXD-30, UXL, UXLS, UXS, UXT, UXTH, UXTHL...(Otros modelos se puede ver en la tienda web)		

			
1			
código	510647	referencia	323893-1
descripción	filtro aspiración ø 163mm H 112mm agujero ø 33mm		
Para modelos:	FE, HE, HE-P		

			
1			
código	517586	referencia	01-240051-004 01-240051-4
descripción	filtro plano H 43mm L 525mm An 220mm		
Para modelos:	FX, FX-McDonalds, GX		

			
1			
código	507499	referencia	00-898189-001 898189-1
descripción	filtro plano L 523mm An 253mm H 15mm		
Para modelos:	AM-10, AM-11, AM-141, AM-700, AM900, AM900-10N, AM900-90, AMS900, AMS900-10N, ECOMAX-600, ECOMAX-602-10, ECOMAX-602-11, ECOMAX-602S-11, ECOMAX-612-10, ECOMAX-612S-10, ECOMAX-650		

			
1			
código	517581	referencia	229400
descripción	filtro rectangular para lavavajillas H 312mm inox L 435mm An 85mm		
Para modelos:	ACW, CX, FTT, FTX, UW-135, UW-135H		

			
1			
código	524830	referencia	01-240630-003 01-240630-3
descripción	filtro redondo ø 136mm H 47mm		

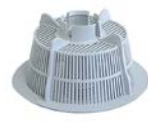
			
1			
código	510041	referencia	139321-51
descripción	filtro redondo ø 136mm H 75mm		
Para modelos:	GE-400, GW-600, GW-600S, GW-601, GW-601S		





			
1			
código	530788	referencia	00-883582-001 01-297817-1 8123 883582-1
descripción	filtro redondo ø 154mm H 116mm para modelo AMX/AUX con anillo		
Para modelos:	AMX, AMX-10HL, AMX-90, AMXR, AMXS, AMXT, AMXTS, AMXX, AMXXR, AMXXS, AUP, AUP-90, AUPS, AUX, AUXXL-11N, AUXXLS-11N, AUXXR, AUXXS, AUXXT, AUXXTS		

			
1			
código	524897	referencia	883733-1
descripción	filtro redondo ø 160mm H 35mm		

			
1			
código	524681	referencia	324179
descripción	filtro redondo ø 161mm H 155mm		
Para modelos:	FE-W, FX, GX, HX, HX-30, HX-30E, HX-30ES, HX-30S, HX-40, HX-40E, HX-40ES, HX-40S, HX-60-EHL, HX-E, HX-ES, HX-S		



			
1			
código	502217	referencia	01-240630-001 01-240630-002 01-240630-1 01-240630-2
descripción	filtro redondo ø 32.5mm H 49mm		
Para modelos:	ECOMAX-402, ECOMAX-502		

tubos de rebose			
			
1			
código	528919	referencia	139321-49
descripción	junta tórica EPDM espesor 2.62mm int.ø 20.24mm UE 1 pzs		
Para modelos:	GE-400, GW-600, GW-600S, GW-601, GW-601S		

			
1			
código	510409	referencia	00-276903-053 00-67500-016 00-67500-118 276903-53 670500-118 67500-16
descripción	junta tórica EPDM espesor 5.34mm int.ø 56.52mm UE 1 pzs		
Para modelos:	CR-F, CX, ECW, EWB-S, FTN, FTT, FTX, FUX, ML-104674, ML-104683, ML-104686, UW-135, UW-135H, UWX, UX-60, UX-60B, UX-60E, UX-60EB, UX-60EH, UX-60EHB, UX-60H, UX-60HB, UXT, UXTH, UXTHL, UXTHLS, UXTHS, UXTL, UXTLH, UXTLHS, UXTLS, UXTS, V1401		

			
1			
código	698632	referencia	324231
descripción	tapa para tubo de derrame ø 55mm H 13mm		
Para modelos:	AMX, AMX-900, AMX-E, AMX-ER, AMX-R, AMXR-900, AMXS-900, AMXX-1300, AMXXR-1300, AMXXS-1300, AMXXT, AUX, AUX_, AUX-E, AUX-ER, AUX-R, AUX-1300, AUXXL, AUXXR-1300, AUXXS-1300, AUXXT, CR, CR-F, FE-W, FX, GX, HX, HX-30, HX-30E, HX-30ES, HX-30S, HX-40, HX-40E, HX-40ES, HX-40S, HX-60-EHL, HX-E, HX-ES, HX-S, UX, UX-30, UX-30B, UX-30E, UX-30EB, UX-30EH, UX-30ES, UX-30ESB, UX-30ESH, UX-30H, UX-30-McDonalds...(Otros modelos se puede ver en la tienda web)		

			
1			
código	517580	referencia	01-240629-001 01-240629-1 01-240744-001 01-240744-002 01-240744-1 01-240744-2
descripción	tubo de rebose L 160mm ø 90mm		
Para modelos:	ECOMAX-402, ECOMAX-502		

			
1			
código	510038	referencia	139321-157
descripción	tubo de rebose L 190mm ø 25mm		
Para modelos:	GE-400, GW-600, GW-600S, GW-601, GW-601S		
accesorios para	510038		
	código	referencia	139321-49
			
	junta tórica EPDM espesor 2.62mm int.ø 20.24mm UE 1 pzs		





1

código	524480	referencia	323999-1
descripción	tubo de rebose L 250mm ø 32mm		
Para modelos:	CR, CR-F, FE, HE, HE600-HL, HE-P		



1

código	524660	referencia	00-883737-001 883737-1
descripción	tubo de rebose L 270mm ø 32mm		
Para modelos:	AM-10, AM-11, AM-141, ECOMAX-602-10, ECOMAX-602-11, ECOMAX-602S-11, ECOMAX-612-10, ECOMAX-612S-10		



1

código	517574	referencia	323534-4
descripción	tubo de rebose L 305mm con filtro ø 155mm tubo ø 56mm plástico int.ø 28mm		
Para modelos:	AMX-900, AMXR-900, AMXS-900		





1

código	517579	referencia	898185-1
descripción	tubo de rebose L 323mm ø 86mm tubo ø 35mm plástico int.ø 24mm		
Para modelos:	AM-700, ECOMAX-600, ECOMAX-650		



1

código	524682	referencia	230346 230346-1 230346-1V
descripción	tubo de rebose L 370mm ø 109mm		
Para modelos:	CX, UW-135, UW-135H		
accesorios para	524682		
	código	521120	referencia —
	junta tórica EPDM espesor 5.34mm int.ø 37.47mm UE 1 pzs		



1

código	517576	referencia	323534-3
descripción	tubo de rebose L 405mm con filtro ø 155mm tubo ø 36mm int.ø 28mm		
Para modelos:	AMXX-1300, AMXXR-1300, AMXXS-1300, AMXXT, AUXX-1300, AUXXL, AUXXR-1300, AUXXS-1300, AUXXT		



1

código	517582	referencia	229426-3 229426-3V
descripción	tubo de rebose L 410mm ø 109mm		
Para modelos:	AM-12E, AM-12EC, AM-12EF, AM-12ER, AM-600, AM-600C, AM-600CR, AM-600R, UW-100, UW-105, UWX		



1

código	517578	referencia	323534-1 774412-1
descripción	tubo de rebose L 458mm con filtro ø 155mm tubo ø 36mm int.ø 28mm		
Para modelos:	AMX, AMX-E, AMX-ER, AMX-R, AUX, AUX_, AUX-E, AUX-ER, AUX-R, UXD-30		



1

código	524921	referencia	323534-2 324666-2
descripción	tubo de rebose L 460mm con filtro ø 150mm tubo ø 36mm plástico int.ø 28mm		
Para modelos:	CR, CR-F, UX-30, UX-30B, UX-30E, UX-30EB, UX-30EH, UX-30ES, UX-30ESB, UX-30ESH, UX-30H, UX-30-McDonalds, UX-30S, UX-30SB, UX-30SH, UX-60, UX-60B, UX-60E, UX-60EB, UX-60EH, UX-60EHB, UX-60H, UX-60HB, UXT, UXTH, UXTHL, UXTHLS, UXTHS, UXTL, UXTLS, UXTS		

1

código	517577	referencia	323534-6
descripción	tubo de rebose L 467mm con filtro ø 155mm tubo ø 36mm plástico int.ø 28mm		
Para modelos:	UXT, UXTH, UXTHS, UXTL, UXTLH, UXTLHS, UXTLS, UXTS		

contenedores

tapas de recipientes



1

código	524685	referencia	227883
descripción	tapa ø 29mm para recipiente de dosificación apto para HOBART		
Para modelos:	CM1E, FX, GX, WM2E		



1

código	542091	referencia	00-775530-050 775530-50
descripción	tapa ø 85mm para contenedor de sal apto para HOBART H 18mm int.ø 58mm		
Para modelos:	AM900, AM900-10N, AM900-90, AMS900, AMS900-10N, AMX, AMX-10HL, AMX-90, AMX-900, AMXR, AMXR-900, AMXS, AMXS-900, AMXT, AMXTS, AMXX, AMXX-1300, AMXXR, AMXXR-1300, AMXXS, AMXXS-1300, AMXXT, AUP, AUP-90, AUPS, AUXX, AUXX-1300, AUXXL, AUXXL-11N, AUXXLS-11N, AUXXR, AUXXR-1300, AUXXS, AUXXS-1300, AUXXT, AUXXTS, FP, FX, FX-McDonalds, GP, GX, UX, UXL, UXLS, UXS, UXT, UXTH, UXTHL, UXTHLS, UXTHS...(Otros modelos se puede ver en la tienda web)		

recipientes de dosificación



1

código	361881	referencia	231969-1 231969-2
descripción	recipiente Kit L 335mm An 105mm H 25mm para abrillantador		
Para modelos:	FX, GX		



1

código	361893	referencia	231969
descripción	recipiente L 335mm An 105mm H 25mm para abrillantador		
Para modelos:	FX, GX		

calentadores de agua

calentadores de agua para lavavajillas



1

código	504375	referencia	01-240791-001 01-240791-1	
descripción	calentador de agua ø 133mm L 420mm brida brida 3 orificios brida ø 47.5mm			
Para modelos:	AM-10, AM-11, AM-141, ECOMAX-502, ECOMAX-602-10			
accesorios para	504375			
	código	504379	referencia	00-774512-001 774512-1
	tapón para vaciado ø 10mm L 18mm			
	código	530821	referencia	00-774080-001 774080-1
	tubo de silicona int.ø 10mm ø ext. 15mm L 1m grosor de la pared 2.5mm presión de trabajo sin presión presión de reventamiento no definido T máx 200°C transparente Shore 60°			

accesorios



código	504378	referencia	01-240452-001 01-240452-1
descripción	empalme de tubo rosca 1/8" rosca L 44mm tubo ø 5mm		
Para modelos:	AM-10, AM-11, AM-141, AM900-10N, AM900-90, AMS900-10N, AMX, AMX-10HL, AMX-90, AMXR, AMXS, AMXT, AMXTS, AMXX, AMXXR, AMXXS, AUP, AUP-90, AUPS, AUXX, AUXXL-11N, AUXXLS-11N, AUXXR, AUXXS, AUXXT, AUXXTS, ECOMAX-602-10, ECOMAX-602-11, ECOMAX-602S-11, ECOMAX-612-10, ECOMAX-612S-10		



código	524905	referencia	228602
descripción	junta para calentador de agua ø 145mm L 187mm An 174mm espesor 7mm agujero ø 7mm		
Para modelos:	FM-30, FM-30U, FM-400H, FM-400U, FM-500, FM-500H, UW-55		



código	511654	referencia	230994
descripción	junta para calentador de agua D1 ø 260mm D2 ø 215mm espesor 2mm 10 orificios goma para HOBART		
Para modelos:	ACW, CR-F, CX, FTN, FTT, FTX, FUX, UWX		



código	518121	referencia	226894-1
descripción	junta para calentador de agua ø 249mm int.ø 235mm espesor 7mm		
Para modelos:	AM-12E, AM-12EC, AM-12EF, AM-12ER, AM-600, AM-600C, AM-600CR, AM-600R, UW-100, UW-105, UW-135, UW-135H		



código	504379	referencia	00-774512-001 774512-1
descripción	tapón para vaciado ø 10mm L 18mm		
Para modelos:	AM-10, AM-11, AM-141, AM-700, AM900, AM900-10N, AM900-90, AMS900, AMS900-10N, AMX, AMX-10HL, AMX-90, AMX-900, AMXR, AMXR-900, AMXS, AMXS-900, AMXT, AMXTS, AMXX, AMXX-1300, AMXXR, AMXXR-1300, AMXXS, AMXXS-1300, AMXXT, AUP, AUP-90, AUPS, AUXX, AUXX-1300, AUXXL, AUXXL-11N, AUXXLS-11N, AUXXR, AUXXR-1300, AUXXS, AUXXS-1300, AUXXT, AUXXTS, ECOMAX-402, ECOMAX-502, ECOMAX-600, ECOMAX-602-10, ECOMAX-602-11, ECOMAX-602S-11, ECOMAX-612-10, ECOMAX-612S-10, FP, FX...(Otros modelos se puede ver en la tienda web)		



código	524908	referencia	00-774808-001 774808-1
descripción	tapón ciego para calentador de agua L 69mm An 17mm		
Para modelos:	AM-700, AMX-900, AMXR-900, AMXS-900, AMXX-1300, AMXXR-1300, AMXXS-1300, AMXXT, AUXX-1300, AUXXL, AUXXR-1300, AUXXS-1300, AUXXT, CN, CNA, CNB, CN-Protronic, CNR, CN-Smartronic, CP-Protronic, CR, CR-F, CSA, CS-Easytronic, ECOMAX-600, ECOMAX-650, ECOMAX-700, ECOMAX-800, ECW, FTN, FTX, UX, UXL, UXLS, UXS, UXT, UXTH, UXTHL, UXTHLS, UXTHS, UXTL, UXTLH, UXTLHS, UXTLS, UXTS		



código	530821	referencia	00-774080-001 774080-1
descripción	tubo de silicona int.ø 10mm ø ext. 15mm L 1m grosor de la pared 2.5mm presión de trabajo sin presión presión de reventamiento no definido T máx 200°C transparente Shore 60°		
Para modelos:	AM-10, AM-11, AM-141, AM-700, AM900, AM900-10N, AM900-90, AMS900, AMS900-10N, AMX, AMX-10HL, AMX-90, AMX-900, AMXR, AMXR-900, AMXS, AMXS-900, AMXT, AMXTS, AMXX, AMXX-1300, AMXXR, AMXXR-1300, AMXXS, AMXXS-1300, AMXXT, AUP, AUP-90, AUPS, AUXX, AUXX-1300, AUXXL, AUXXL-11N, AUXXLS-11N, AUXXR, AUXXR-1300, AUXXS, AUXXS-1300, AUXXT, AUXXTS, ECOMAX-402, ECOMAX-502, ECOMAX-600, ECOMAX-602-10, ECOMAX-602-11, ECOMAX-602S-11, ECOMAX-612-10, ECOMAX-612S-10, FP, FX...(Otros modelos se puede ver en la tienda web)		

cartuchos descalcificadores

completo



código	530327	referencia	00-775918-001 00-775918-010 775918-1
descripción	descalcificador		
Para modelos:	ECOMAX-402, ECOMAX-502, ECOMAX-602S-11, ECOMAX-612S-10		
accesorios para	530327		



código	530174	referencia	00-775918-050 775918-150 775918-50
descripción	tapa Kit para descalcificador		

componentes mecánicos y accesorios aparatos



cajas y paneles frontales

otros



código	513070	referencia	00-886756-004 886756-4
descripción	orificio de paso int.ø 14mm ø ext. 19mm		
Para modelos:	AM-10, AM-11, AM-141, AM-700, AM900, AM900-10N, AM900-90, AMS900, AMS900-10N, AMX, AMX-10HL, AMX-90, AMX-900, AMXR, AMXR-900, AMXS, AMXS-900, AMXT, AMXTS, AMXX, AMXX-1300, AMXXR, AMXXR-1300, AMXXS, AMXXS-1300, AMXXT, AUP, AUP-90, AUPS, AUXX, AUXX-1300, AUXXL, AUXXL-11N, AUXXLS-11N, AUXXR, AUXXR-1300, AUXXS, AUXXS-1300, AUXXT, AUXXTS, ECOMAX-402, ECOMAX-502, ECOMAX-602-10, ECOMAX-602-11, ECOMAX-602S-11, ECOMAX-612-10, ECOMAX-612S-10, ECOMAX-650, ECOMAX-700, FP... (Otros modelos se puede ver en la tienda web)		



código	513049	referencia	00-886756-003 886756-3
descripción	orificio de paso int.ø 29mm ø ext. 38mm		
Para modelos:	AM-10, AM-11, AM-141, AM-700, AM900-10N, AM900-90, AMS900-10N, AMX, AMX-10HL, AMX-90, AMXR, AMXS, AMXT, AMXTS, AMXX, AMXXR, AMXXS, AUP, AUP-90, AUPS, AUXX, AUXXL-11N, AUXXLS-11N, AUXXR, AUXXS, AUXXT, AUXXTS, ECOMAX-402, ECOMAX-502, ECOMAX-600, ECOMAX-602-10, ECOMAX-602-11, ECOMAX-602S-11, ECOMAX-612-10, ECOMAX-612S-10, ECOMAX-700, GC, GC11, GC12, GC31, GC32, GC41, GC42, UX, UXL, UXLS, UXS, UXT, UXTH, UXTHL... (Otros modelos se puede ver en la tienda web)		



código	513048	referencia	00-886756-001 886756-1
descripción	orificio de paso int.ø 41mm ø ext. 50mm		
Para modelos:	AM-10, AM-11, AM-141, AM-700, AM900, AM900-10N, AM900-90, AMS900, AMS900-10N, AMX, AMX-10HL, AMX-90, AMX-900, AMX-E, AMX-ER, AMXR, AMX-R, AMXR-900, AMXS, AMXS-900, AMXT, AMXTS, AMXX, AMXX-1300, AMXXR, AMXXR-1300, AMXXS, AMXXS-1300, AMXXT, AUP, AUP-90, AUPS, AUX, AUX-E, AUX-ER, AUX-R, AUXX, AUXX-1300, AUXXL, AUXXL-11N, AUXXLS-11N, AUXXR, AUXXR-1300, AUXXS, AUXXS-1300, AUXXT, AUXXTS, CN-Protronic, CN-Smartronic, CS-Easytronic...(Otros modelos se puede ver en la tienda web)		

mecanismos de capota para lavavajillas

pernos



código	502220	referencia	00-883965-001 883965-1
descripción	perno roscado ø ext. 10mm L 22mm rosca M5 Kit para rueda de rodadura		
Para modelos:	AM-10, AM-11, AM-141, AM900-10N, AM900-90, AMS900-10N, AMX, AMX-10HL, AMX-90, AMXR, AMXS, AMXT, AMXTS, AMXX, AMXXR, AMXXS, AUP, AUP-90, AUPS, AUXX, AUXXL-11N, AUXXLS-11N, AUXXR, AUXXS, AUXXT, AUXXTS, ECOMAX-602-10, ECOMAX-602-11, ECOMAX-602S-11, ECOMAX-612-10, ECOMAX-612S-10		

soporte de muelle



código	517405	referencia	00-883683-002 883683-2
descripción	soporte de muelle para muelle de campana		
Para modelos:	AM-10, AM-11, AM-141, AM900-10N, AM900-90, AMS900-10N, AMX, AMX-10HL, AMX-90, AMXR, AMXS, AMXX, AMXXR, AMXXS, AUP, AUP-90, AUPS, AUXX, AUXXR, AUXXS, ECOMAX-602-10, ECOMAX-602-11, ECOMAX-602S-11, ECOMAX-612-10, ECOMAX-612S-10		

muelles



código	511965	referencia	119079-2
descripción	resorte para mecanismos de capota espesor de hilo 5.5mm ø 50mm longitud total 385mm		
Para modelos:	AM-12EC, AM-600C, AM-600CR, AMX, AMX-E, AMX-ER, AMX-R, AUX, AUX_, AUX-E, AUX-ER, AUX-R, FM-30, FM-400H, FM-500H, HE, HE600-HL, HE-P, HX, HX-30, HX-30E, HX-30ES, HX-30S, HX-40, HX-40E, HX-40ES, HX-40S, HX-60-EHL, HX-E, HX-ES, HX-S, UX-30EH, UX-30ESH, UX-30H, UX-30-McDonalds, UX-30SH		

barras guía



código	502224	referencia	00-886987-001 886987-1
descripción	distanciador Kit para campana L 79mm An 24mm H 10mm		
Para modelos:	AM-10, AM-11, AM-141, AM900-10N, AM900-90, AMS900-10N, AMX, AMX-10HL, AMX-90, AMX-900, AMXR, AMXR-900, AMXS, AMXS-900, AMXT, AMXTS, AMXX, AMXX-1300, AMXXR, AMXXR-1300, AMXXS, AMXXS-1300, AMXXT, AUP, AUP-90, AUPS, AUXX, AUXX-1300, AUXXL-11N, AUXXLS-11N, AUXXR, AUXXR-1300, AUXXS, AUXXS-1300, AUXXT, AUXXTS, ECOMAX-602-10, ECOMAX-602-11, ECOMAX-602S-11, ECOMAX-612-10, ECOMAX-612S-10		



código	502223	referencia	01-246900-001 01-246900-1
descripción	distanciator para campana L 79mm An 24mm H 10mm		
Para modelos:	AM-10, AM-11, AM-141, AM900-10N, AM900-90, AMS900-10N, AMX, AMX-10HL, AMX-90, AMX-900, AMXR, AMXR-900, AMXS, AMXS-900, AMXT, AMXTS, AMXX, AMXX-1300, AMXXR, AMXXR-1300, AMXXS, AMXXS-1300, AMXXT, AUP, AUP-90, AUPS, AUX, AUX-1300, AUXXL-11N, AUXXLS-11N, AUXXR, AUXXR-1300, AUXXS, AUXXS-1300, AUXXT, AUXXTS, ECOMAX-602-10, ECOMAX-602-11, ECOMAX-602S-11, ECOMAX-612-10, ECOMAX-612S-10		



código	511681	referencia	00-883477-001 01-297717-1 883477-1
descripción	guía L 480mm pos. de montaje abajo para campana		
Para modelos:	AM-10, AM-11, AM-141, AM900-10N, AM900-90, AMS900-10N, AMX, AMX-10HL, AMX-90, AMXR, AMXS, AMXX, AMXXR, AMXXS, AUP, AUP-90, AUPS, AUX, AUXXL-11N, AUXXLS-11N, AUXXR, AUXXS, ECOMAX-602-10, ECOMAX-602-11, ECOMAX-602S-11, ECOMAX-612-10, ECOMAX-612S-10		

soportes para manillas de capota



código	502222	referencia	00-898024-001 898024-1
descripción	cojinete para manilla de campana plástico L 47mm An 38mm H 20mm		
Para modelos:	AM-10, AM-11, AM-141, AM900-10N, AM900-90, AMS900-10N, AMX, AMX-10HL, AMX-90, AMXR, AMXS, AMXT, AMXTS, AMXX, AMXXR, AMXXS, AUP, AUP-90, AUPS, AUX, AUXXL-11N, AUXXLS-11N, AUXXR, AUXXS, AUXXT, AUXXTS, ECOMAX-602-10, ECOMAX-602-11, ECOMAX-602S-11, ECOMAX-612-10, ECOMAX-612S-10		

ruedas de rodadura



código	502221	referencia	00-898080-001 898080-1
descripción	rueda de rodadura ø 29mm para mecanismos de capota Kit agujero ø 10mm		
Para modelos:	AM-10, AM-11, AM-141, AM-700, AM900, AM900-10N, AM900-90, AMS900, AMS900-10N, AMX, AMX-10HL, AMX-90, AMX-900, AMX-E, AMX-ER, AMXR, AMX-R, AMXR-900, AMXS, AMXS-900, AMXT, AMXTS, AMXX, AMXX-1300, AMXXR, AMXXR-1300, AMXXS, AMXXS-1300, AMXXT, AUP, AUP-90, AUPS, AUX, AUX-E, AUX-ER, AUX-R, AUX, AUX-1300, AUXXL, AUXXL-11N, AUXXLS-11N, AUXXR, AUXXR-1300, AUXXS, AUXXS-1300, AUXXT, AUXXTS, ECOMAX-600, ECOMAX-602-10, ECOMAX-602-11...(Otros modelos se puede ver en la tienda web)		
accesorios para	502221		
	código	502220	referencia 00-883965-001 883965-1
	perno roscado ø ext. 10mm L 22mm rosca M5 Kit para rueda de rodadura		

otros



código	502226	referencia	00-228828-000
descripción	tope de goma ø ext. 9mm negro		
Para modelos:	AM-10, AM-11, AM-141, AM-700, AM900, AM900-10N, AM900-90, AMS900, AMS900-10N, AMX, AMX-10HL, AMX-90, AMX-900, AMX-E, AMX-ER, AMXR, AMX-R, AMXR-900, AMXS, AMXS-900, AMXT, AMXTS, AMXX, AMXX-1300, AMXXR, AMXXR-1300, AMXXS, AMXXS-1300, AMXXT, AUP, AUP-90, AUPS, AUX, AUX_, AUX-E, AUX-ER, AUX-R, AUX, AUX-1300, AUXXL, AUXXL-11N, AUXXLS-11N, AUXXR, AUXXR-1300, AUXXS, AUXXS-1300, AUXXT, AUXXTS, ECOMAX-600, ECOMAX-602-10...(Otros modelos se puede ver en la tienda web)		

cámaras de aire

cámaras de aire





código	503162	referencia	01-240372-001 01-240372-1
descripción	cámara de aire completo L 77mm An 83mm ø empalme 24mm tubo ø 6mm		
Para modelos:	AM-10, AM-11, AM-141, AM900-10N, AM900-90, AMS900-10N, AMX, AMX-10HL, AMX-90, AMXR, AMXS, AMXT, AMXTS, AMXX, AMXXR, AMXXS, AUP, AUP-90, AUPS, AUX, AUXXL-11N, AUXXLS-11N, AUXXR, AUXXS, AUXXT, AUXXTS, ECOMAX-402, ECOMAX-502, ECOMAX-602-10, ECOMAX-602-11, ECOMAX-602S-11, ECOMAX-612-10, ECOMAX-612S-10, FP, FX, FX-McDonalds, GP, GX		
accesorios para	503162		
	código	520027	referencia 00-324402-005 00-324402-014 139321-126 324402-14 324402-5
	tubo flexible de PVC int.ø 4mm ø ext. 7mm L 10m grosor de la pared 1.5mm T máx 60°C transparente		





código	517575	referencia	324858
descripción	cámara de aire L 78mm An 40mm H 66mm tubo ø 5mm plástico		
Para modelos:	AM3, AMX, AMX-E, AMX-ER, AMX-R, AUX, AUX_, AUX-E, AUX-ER, AUX-R, FE, HE, HE600-HL, HE-P, UXD-30		





			
1			
código	510103	referencia	139321-47
descripción	cámara de aire L 85mm An 20mm H 80mm tubo ø 6mm plástico		
Para modelos:	AM-700, AM900, AMS900, AMX-900, AMXR-900, AMXS-900, AMXX-1300, AMXXR-1300, AMXXS-1300, AMXXT, AUXX-1300, AUXXL, AUXXR-1300, AUXXS-1300, AUXXT, ECOMAX-600, ECOMAX-650, ECOMAX-700, FE-W, FX, GC, GC11, GC12, GC31, GC32, GC41, GC42, GE-400, GW-600, GW-600S, GW-601, GW-601S, GX, HX, HX-30, HX-30E, HX-30ES, HX-30S, HX-40, HX-40E, HX-40ES, HX-40S, HX-60-EHL, HX-E, HX-ES, HX-S, UX, UX-30, UX-30B, UX-30E...(Otros modelos se puede ver en la tienda web)		
repuestos para	510103		
	código	505045	referencia —
	junta tórica EPDM espesor 1.78mm int.ø 5.28mm UE 1 pzs		
	código	505094	referencia —
	cámara de aire		
	código	510016	referencia 139321-180 897923
	armella para empalme de recipiente abrillantador		

			
1			
código	510111	referencia	139321-550
descripción	cámara de aire ø 34mm H 130mm tubo ø 6mm plástico		
Para modelos:	CHH-50, CHH-60D, CHH-70D, CLG-25, EH-60, EH-70		
repuestos para	510111		
	código	504618	referencia —
	junta tórica EPDM espesor 2.62mm int.ø 15.54mm UE 1 pzs		
	código	510075	referencia 139321-725
	junta plana goma ø ext. 22mm int.ø 13mm espesor 1.5mm UE 1 pzs		
	código	510106	referencia 139321-722
	empalme de tubo para cámara de aire		

			
1			
código	511993	referencia	107013
descripción	cámara de aire ø 43mm H 33mm tubo ø 6mm plástico		
Para modelos:	H-60		

accesorios para cámaras de aire			
			
1			
código	510105	referencia	139321-202 897923
descripción	empalme de tubo para cámara de aire		
Para modelos:	AM-700, AM900, AMS900, AMX, AMX-900, AMX-E, AMX-ER, AMX-R, AMXR-900, AMXS-900, AMXX-1300, AMXXR-1300, AMXXS-1300, AMXXT, AUX, AUX_, AUX-E, AUX-ER, AUX-R, AUXX-1300, AUXXL, AUXXR-1300, AUXXS-1300, AUXXT, ECOMAX-600, ECOMAX-650, FE, FE-W, FX, GE-400, GW-600, GW-600S, GW-601, GW-601S, GX, HE, HE600-HL, HE-P, HX, HX-30, HX-30E, HX-30ES, HX-30S, HX-40, HX-40E, HX-40ES, HX-40S, HX-60-EHL, HX-E, HX-ES...(Otros modelos se puede ver en la tienda web)		
repuestos para	510105		
	código	510017	referencia —
	tornillo de racor		

mecánicas para lavavajillas de cinta transportadora			
			
1			
código	524525	referencia	229326-1
descripción	barra para sistema de transporte L 600mm ø 7mm para HOBART		
Para modelos:	FTX		

			
1			
código	524878	referencia	229 102
descripción	dedo de transporte An 70mm H 87mm dist. del agujero 58.5mm		
Para modelos:	FTX		

			
1			
código	524884	referencia	00-154791-000
descripción	junta H 35mm ø 66mm int.ø 16mm		
Para modelos:	CN, CNA, CNB, CN-Protronic, CNR, CN-Smartronic, CP-Protronic, CR, CR-F, CSA, CS-Easytronic, ECOMAX-800		

			
1			
código	524879	referencia	302 207-22
descripción	rail de deslizamiento para puerta L 380mm		
Para modelos:	UX, UXS, UXT, UXTS		



1

código	524683	referencia	112378-21 302207-4
descripción	rail de deslizamiento para puerta L 870mm An 8mm H 11.5mm para HOBART		
Para modelos:	CX, FTX, FUX		



1

código	524526	referencia	229319
descripción	rollo para sistema de transporte L 24.4mm int.ø 7.4mm ø ext. 20/25mm para HOBART		
Para modelos:	FTX		



1

código	524527	referencia	774643-1
descripción	rollo para sistema de transporte L 26.2mm int.ø 7.2mm ø ext. 20/26mm para HOBART		

tubos



1

código	513047	referencia	00-883512-001 883512-1
descripción	tubo 14x2,0mm tubo ø 14mm L 933mm PE-Xb		
Para modelos:	AM-10, AM-11, AM-141, AM900-10N, AM900-90, AMS900-10N, AMX, AMX-10HL, AMX-90, AMXR, AMXS, AMXT, AMXTS, AMXX, AMXXR, AMXXS, AUP, AUP-90, AUPS, AUXX, AUXXR, AUXXS, AUXXT, AUXXTS, ECOMAX-602-10, ECOMAX-602-11, ECOMAX-602S-11, ECOMAX-612-10, ECOMAX-612S-10		

bloqueos antirretorno

bloqueos antirretorno



1

código	511672	referencia	00-775759-001 775759-1
descripción	bloqueo antirretorno		
Para modelos:	AM-10, AM-11, AM-141, AM-700, AM900-90, AMX-90, AUP-90, CNA, CNB, CNR, CSA, ECOMAX-402, ECOMAX-502, ECOMAX-600, ECOMAX-602-10, ECOMAX-650, ECOMAX-700, ECOMAX-800, FP, FX, FX-McDonalds, GC, GC11, GC12		

accesorios para	511672			
	código	502228	referencia	00-324384-000 324384
tuerca para bloqueo antirretorno ø 35mm EC 30				

accesorios para	511672			
	código	507495	referencia	00-775305-001 172513 775305-1
junta ø ext. 34mm int.ø 25.5mm espesor 2.5mm UE 1 pzs				



1

código	511673	referencia	00-883817-001 883817-1
descripción	bloqueo antirretorno		
Para modelos:	AM900-10N, AM900-90, AMS900-10N, AMX, AMX-10HL, AMX-90, AMXR, AMXS, AMXT, AMXTS, AMXX, AMXXR, AMXXS, AUP, AUP-90, AUPS, AUXX, AUXXL-11N, AUXXLS-11N, AUXXR, AUXXS, AUXXT, AUXXTS, ECOMAX-602-11, ECOMAX-602S-11, ECOMAX-612-10, ECOMAX-612S-10		

repuestos para	511673			
	código	511680	referencia	00-324313-002 324313-2
esfera para bloqueo antirretorno ø 8mm				

accesorios para	511673			
	código	511675	referencia	00-775531-001 775531-1
tapón ciego para bloqueo antirretorno ø 10mm L 26mm goma				



1

código	511674	referencia	01-240142-001 01-240142-1
descripción	bloqueo antirretorno		
Para modelos:	ECOMAX-402, ECOMAX-502, FP, FX, FX-McDonalds, GP, GX		

repuestos para	511674			
	código	511680	referencia	00-324313-002 324313-2
esfera para bloqueo antirretorno ø 8mm				

accesorios para	511674			
	código	511675	referencia	00-775531-001 775531-1
tapón ciego para bloqueo antirretorno ø 10mm L 26mm goma				



código	524457	referencia	00-775540-001 00-775540-011 01-297510-001 01-297510-002 01-297510-2 01-297695-001 01-297695-1 775540-1 775540-11
---------------	--------	-------------------	--

descripción bloqueo antirretorno Kit

Para modelos: AM900, AM900-10N, AM900-90, AMS900, AMS900-10N, AMX, AMX-10HL, AMX-90, AMX-900, AMX-E, AMX-ER, AMXR, AMX-R, AMXR-900, AMXS, AMXS-900, AMXT, AMXTS, AMXX, AMXX-1300, AMXXR, AMXXR-1300, AMXXS, AMXXS-1300, AMXXT, AUP, AUP-90, AUPS, AUX, AUX-E, AUX-ER, AUX-R, AUXX, AUXX-1300, AUXXL, AUXXL-11N, AUXXLS-11N, AUXXR, AUXXR-1300, AUXXS, AUXXS-1300, AUXXT, AUXXTS, ECOMAX-402, ECOMAX-502, ECOMAX-602-11, ECOMAX-602S-11, ECOMAX-612-10, ECOMAX-612S-10, ECOMAX-650... (Otros modelos se puede ver en la tienda web)

repuestos para 524457

	código	502228	referencia	00-324384-000 324384
tuerca para bloqueo antirretorno ø 35mm EC 30				

accesorios para 524457

	código	520015	referencia	00-775559-007 00-775559-008 00-775559-013 00-775559-016 139321-125 139321-611 775559-13 775559-16 775559-7 775559-8
tubo flexible de entrada int.ø 10mm ø ext. 17mm L 5m p de trabajo 20bar p de reventamiento 60bar T máx 95°C gris UE 5m				



código	523077	referencia	01-297695-2
---------------	--------	-------------------	-------------

descripción bloqueo antirretorno Kit con tapa



código	524882	referencia	324091
descripción	bloqueo antirretorno tubo ø 12mm		
Para modelos:	ACW, CR-F, FE, FTN, FTT, FTX, FUX, FX, GX, HE, HE600-HL, HX-30ES, HX-30S, HX-40ES, HX-40S, HX-ES, HX-S, UW-135, UW-135H, UX-30ES, UX-30ESB, UX-30ESH, UX-30-McDonalds, UX-30S, UX-30SB, UX-30SH		



código	524513	referencia	324158 886641
descripción	bloqueo antirretorno tubo ø 13/18mm		
Para modelos:	AM3, AMX, AMX-E, AMX-ER, AMX-R, AUX, AUX_, AUX-E, AUX-ER, AUX-R, FX, UX-30, UX-30B, UX-30E, UX-30EB, UX-30EH, UX-30H, UX-30-McDonalds, UX-60, UX-60B, UX-60E, UX-60EB, UX-60EH, UX-60EHB, UX-60H, UX-60HB, UXD-30		

válvulas de retención



código	517573	referencia	146669-1 292909
descripción	válvula de retención rosca 1/2" H		
Para modelos:	AM-600, AM-600C, AM-600CR, AM-600R, CX, FM-400H, FM-500H, UW-105, UWX		

accesorios

	código	511680	referencia	00-324313-002 324313-2
descripción	esfera para bloqueo antirretorno ø 8mm			
Para modelos:	AMX, AMX-E, AMX-ER, AMX-R, AUX, AUX_, AUX-E, AUX-ER, AUX-R, CR, ECOMAX-402, ECOMAX-502, UX-30, UX-30B, UX-30E, UX-30EB, UX-60, UX-60B, UX-60E, UX-60EB			

1

código	511675	referencia	00-775531-001 775531-1
descripción	tapón ciego para bloqueo antirretorno ø 10mm L 26mm goma		
Para modelos:	AM900, AM900-10N, AM900-90, AMS900, AMS900-10N, AMX, AMX-10HL, AMX-90, AMX-900, AMX-E, AMX-ER, AMXR, AMX-R, AMXR-900, AMXS, AMXS-900, AMXT, AMXTS, AMXX, AMXX-1300, AMXXR, AMXXR-1300, AMXXS, AMXXS-1300, AMXXT, AUP, AUP-90, AUPS, AUX, AUX-E, AUX-ER, AUX-R, AUXX, AUXX-1300, AUXXL, AUXXL-11N, AUXXLS-11N, AUXXR, AUXXR-1300, AUXXS, AUXXS-1300, AUXXT, AUXXTS, ECOMAX-402, ECOMAX-502, ECOMAX-602-11, ECOMAX-612-10, ECOMAX-650, FP, FX...(Otros modelos se puede ver en la tienda web)		



1

código	502228	referencia	00-324384-000
descripción	tuerca para bloqueo antirretorno ø 35mm EC 30		
Para modelos:	AM-10, AM-11, AM-141, AM-600, AM-600C, AM-600CR, AM-600R, AM-700, AM900, AM900-10N, AM900-90, AMS900, AMS900-10N, AMX, AMX-10HL, AMX-90, AMX-900, AMX-E, AMX-ER, AMXR, AMX-R, AMXR-900, AMXS, AMXS-900, AMXT, AMXTS, AMXX, AMXX-1300, AMXXR, AMXXR-1300, AMXXS, AMXXS-1300, AMXXT, AUP, AUP-90, AUPS, AUX, AUX-E, AUX-ER, AUX-R, AUXX, AUXX-1300, AUXXL, AUXXL-11N, AUXXLS-11N, AUXXR, AUXXR-1300, AUXXS, AUXXS-1300...(Otros modelos se puede ver en la tienda web)		

otros



1

código	518129	referencia	136763
descripción	cojinete de árbol latón H 32mm D1 ø 38mm D2 ø 32mm int.ø 25.4mm		



1

código	511676	referencia	00-324097-000 00-883281-001 883281-1
descripción	entrada agua para cuba plástico D1 ø 18mm para HOBART		
Para modelos:	AM-600, AM-600C, AM-600CR, AM-600R, AM900, AM900-10N, AM900-90, AMS900, AMS900-10N, AMX, AMX-10HL, AMX-90, AMX-900, AMX-E, AMX-ER, AMXR, AMX-R, AMXR-900, AMXS, AMXS-900, AMXT, AMXTS, AMXX, AMXX-1300, AMXXR, AMXXR-1300, AMXXS, AMXXS-1300, AMXXT, AUP, AUP-90, AUPS, AUX, AUX-E, AUX-ER, AUX-R, AUXX, AUXX-1300, AUXXL, AUXXL-11N, AUXXLS-11N, AUXXR, AUXXR-1300, AUXXS, AUXXS-1300, AUXXT, AUXXTS, ECOMAX-602-11, ECOMAX-602S-11, ECOMAX-612-10...(Otros modelos se puede ver en la tienda web)		



1

código	530469	referencia	325308-1
descripción	tapón para brazos de lavado goma L 24mm D1 ø 34mm montaje ø 20mm int.ø 15mm		
Para modelos:	CNR, CR, ECW		

macánica de puertas

pernos



1

código	502219	referencia	01-240151-001 01-240151-1
descripción	perno de puerta ø 8mm L 15mm rosca M5 acero inoxidable		
Para modelos:	ECOMAX-402, ECOMAX-502, FP, FX, FX-McDonalds, GP, GX		

muelles

resortes enrollados



1

código	519496	referencia	774749-6
descripción	resorte enrollado An 40mm int.ø 10.5mm longitud de lengüeta 52mm		
Para modelos:	CN, CNA, CNB, CNR, CR, FTN		



1

código	517409	referencia	774749-3
descripción	resorte enrollado An 40mm int.ø 10.5mm longitud de lengüeta 54mm		
Para modelos:	CSA, FTN		



1

código	519515	referencia	229277
descripción	resorte enrollado An 40mm int.ø 35mm longitud de lengüeta 23mm		
Para modelos:	CX, FTT, FTX, FUX		



1

código	520590	referencia	01-245278-7
descripción	resorte enrollado An 55mm int.ø 11mm longitud de lengüeta 30mm		



1

código	694272	referencia	299110 378591
descripción	resorte enrollado An 65mm int.ø 48mm longitud de lengüeta 24mm		
Para modelos:	UW-100, UW-105, UW-120, UW-125, UW-200, UW-205		



1

código	519514	referencia	774749-5
descripción	resorte enrollado completo An 40mm int.ø 10.5mm longitud de lengüeta 49mm		
Para modelos:	CN, CNA, CNB, CNR, CR, FTN		



1

código	519492	referencia	774749-2
descripción	resorte enrollado completo An 40mm int.ø 10.5mm longitud de lengüeta 54mm		
Para modelos:	CN, CNA, CNB, CNR, CR, CR-F, FTN		

resortes de tracción



1

código	504424	referencia	00-324773-000
descripción	muelle de tracción ø 20mm longitud total 245mm espesor de hilo 2.5mm para puerta UE 1 pzs		
Para modelos:	UX-30, UX-30E, UX-30ES, UX-30-McDonalds, UX-30S, UX-60, UX-60E, UXD-30, UXL, UXLS		

varillaje



1

código	518362	referencia	139321-568
descripción	tirante de puerta tirante de puerta		
Para modelos:	CHF45, EF-40		

placas de fricción



1

código	518353	referencia	E307005
descripción	tope plástico para puerta L 60mm An 12.5mm H 10mm		

bisagras



1

código	518547	referencia	139321-267
descripción	bisagra de puerta bisagra pos. de montaje izquierdo		
Para modelos:	GE-400, GW-600, GW-600S, GW-601, GW-601S		



1

código	503500	referencia	324002-1
descripción	bisagra de puerta bisagra/ derecha pos. de montaje derecho		
Para modelos:	FX, GX		



1

código	503501	referencia	324002-2
descripción	bisagra de puerta bisagra/ izquierda pos. de montaje izquierdo		
Para modelos:	FX, GX		

soportes de bisagra



1

código	502225	referencia	01-294108-001 01-294108-1
descripción	bloque de bisagras plástico G1: M5		
Para modelos:	ECOMAX-402, ECOMAX-502		
accesorios para	502225		
	código	502219	referencia 01-240151-001 01-240151-1
	perno de puerta ø 8mm L 15mm rosca M5 acero inoxidable		

guías de puertas



1

código	698702	referencia	325064-4
descripción	rail de deslizamiento L 812mm An 31mm		
Para modelos:	CN, CNA, CNB, CNR, CR		

topes de puerta



1

código	505295	referencia	01-240741-001 01-240741-1
descripción	tope de puerta H 7.5mm L 17mm An 10mm		
Para modelos:	ECOMAX-402, ECOMAX-502		

árboles de puerta



1

código	524883	referencia	774495-1
descripción	eje ø 10mm L 76mm para puerta lavavajilla		
Para modelos:	CN, CNA, CNB, CNR, CR, CR-F, CSA, ECOMAX-800, FTN		

cierres



1

código	701126	referencia	324221
descripción	cierre de enganche L 33mm con rueda rosca M12x1,75 para lavavajillas		
Para modelos:	ECOMAX-700, FE, FX, GX, UX-30, UX-30E, UX-30ES, UX-30-McDonalds, UX-30S, UX-60, UX-60E		



1

código	512287	referencia	01-240763-001 01-510284-1
descripción	cierre de puerta L 51mm An 35mm H 13mm		
Para modelos:	ECOMAX-402, ECOMAX-502		



1

código	518298	referencia	139321-1116
descripción	perno cierre de puerta		

otros



1

código	503502	referencia	228693-1
descripción	casquillo		
Para modelos:	FE-W, FM-30U, FM-400U, FM-500, FX, GX, HX, HX-30, HX-30E, HX-30ES, HX-30S, HX-40, HX-40E, HX-40ES, HX-40S, HX-60-EHL, HX-E, HX-ES, HX-S, UW-55		



			
1			
código	504376	referencia	01-240176-001 01-240176-1
descripción	cojinete de fricción plástico ø ext. 15mm int.ø 8mm D2 ø 10mm		
Para modelos:	ECOMAX-402, ECOMAX-502, FP, FX, FX-McDonalds, GP, GX		

			
1			
código	698634	referencia	324322
descripción	deflector H 30mm L 125mm An 30mm		
Para modelos:	AMX, AMX-E, AMX-ER, AMX-R, AUX, AUX_, AUX-E, AUX-ER, AUX-R, HE, HE-P, HX, HX-30, HX-30E, HX-30ES, HX-30S, HX-40, HX-40E, HX-40ES, HX-40S, HX-E, HX-ES, HX-S		

			
1			
código	524925	referencia	323930-2
descripción	junta para cojinete int.ø 12mm H 23mm L 30mm An 12mm pos. de montaje derecho		
Para modelos:	FE, FE-W		

			
1			
código	524926	referencia	323930-1
descripción	junta para cojinete int.ø 12mm H 23mm L 30mm An 12mm pos. de montaje izquierdo		
Para modelos:	FE, FE-W		

			
1			
código	524458	referencia	324194 886253-1
descripción	junta de gomaespuma para puerta L 560mm An 19mm espesor 4mm		
Para modelos:	FX, GX		

			
1			
código	502218	referencia	00-883947-001 883947-1
descripción	kit de piezas de repuesto para mecánica de puertas		
Para modelos:	AM-10, AM-11, AM-141, AM900-10N, AM900-90, AMS900-10N, AMX, AMX-10HL, AMX-90, AMXR, AMXS, AMXT, AMXTS, AMXX, AMXXR, AMXXS, AUP, AUP-90, AUPS, AUXX, AUXXR, AUXXS, AUXXT, AUXXTS, ECOMAX-602-10, ECOMAX-602-11, ECOMAX-602S-11, ECOMAX-612-10, ECOMAX-612S-10		

			
1			
código	502227	referencia	00-883931-001 883931-1
descripción	llave para resorte de tracción ø 10mm L 285mm rosca M10x1,5		
Para modelos:	AM-10, AM-11, AM-141, AM900-10N, AM900-90, AMS900-10N, AMX, AMX-10HL, AMX-90, AMXR, AMXS, AMXT, AMXTS, AMXX, AMXXR, AMXXS, AUP, AUP-90, AUPS, AUXX, AUXXL-11N, AUXXLS-11N, AUXXR, AUXXS, AUXXT, AUXXTS, ECOMAX-602-10, ECOMAX-602-11, ECOMAX-602S-11, ECOMAX-612-10, ECOMAX-612S-10		

			
1			
código	519524	referencia	00-226640-000
descripción	manilla para mecánica de puertas PVC ø 23mm L 122mm		
Para modelos:	AM-10, AM-11, AM-12E, AM-12EC, AM-12ER, AM-141, AM-600, AM-600C, AM-600CR, AM-600R, AMX, AMX-E, AMX-ER, AMX-R, AUX, AUX-E, AUX-ER, AUX-R, ECOMAX-602-10, ECOMAX-602-11, ECOMAX-602S-11, ECOMAX-612-10, ECOMAX-612S-10, FM-400H, FM-500H, HE, HE600-HL, HE-P, HX, HX-60-EHL, HX-E, HX-ES, HX-S, UX-30EH, UX-30ESH, UX-30H, UX-30-McDonalds, UX-30SH		

			
1			
código	519523	referencia	01-240764-001 01-240764-1
descripción	resorte para cierre de puerta L 45mm An 25mm		
Para modelos:	ECOMAX-402, ECOMAX-502		

<h3>uniones roscadas</h3>			
			
1			
código	505288	referencia	00-695664-004 695664-4
descripción	tuerca rosca M25x1,5 H 6mm EC 30 UE 1 pzs con racor para cables		
Para modelos:	CN-Protronic, CN-Smartronic, CP-Protronic, ECOMAX-402, ECOMAX-502		



cortinas

cortinas



1			
código	533134	referencia	229436-4
descripción	cortina An 1095mm H 400mm sistemas de lavado		
Para modelos:	FTX, FUX		



1			
código	533135	referencia	229436-6
descripción	cortina An 1095mm H 643mm sistemas de lavado		
Para modelos:	FTX, FUX		



1			
código	533139	referencia	230781
descripción	cortina An 625mm H 420mm sistemas de lavado		
Para modelos:	CR-F, CX		

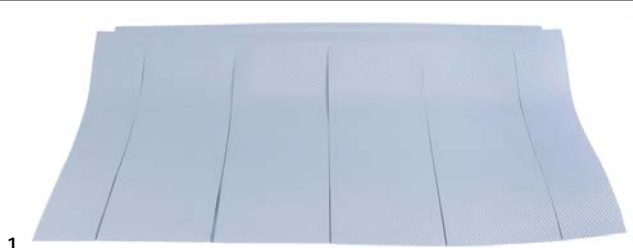

1			
código	533138	referencia	231602-1
descripción	cortina An 640mm H 380mm sistemas de lavado		
Para modelos:	CX		



1			
código	533148	referencia	781284-1
descripción	cortina An 645mm H 290mm sistemas de lavado		
Para modelos:	CN, CNA, CNB, CNR, CR, CSA		



1			
código	533150	referencia	781067-1
descripción	cortina An 645mm H 430mm sistemas de lavado		
Para modelos:	CN, CNA, CNB, CNR, CR, CSA, ECOMAX-800		

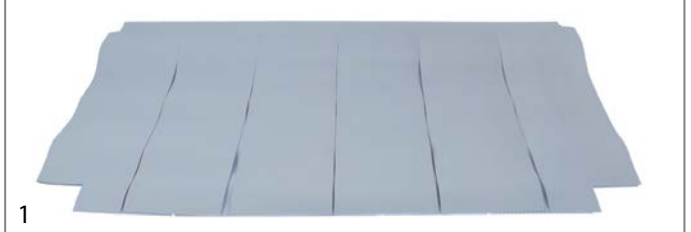

1			
código	533131	referencia	229436-1
descripción	cortina An 740mm H 400mm sistemas de lavado		
Para modelos:	FTX, FUX		



1			
código	533140	referencia	325346-4
descripción	cortina An 750mm H 365mm sistemas de lavado		
Para modelos:	FTN		



1			
código	533141	referencia	325346-8
descripción	cortina An 750mm H 385mm sistemas de lavado		
Para modelos:	FTN		

barras de cortina



1			
código	533159	referencia	231540-5 325360-7
descripción	barra de cortina L 655mm ø 8mm		
Para modelos:	CN, CNA, CNB, CNR, CR, CR-F, CSA, ECOMAX-800		



sistemas de lavado y aclarado

			
1			
código	510638	referencia	324068
descripción	anillo de sujeción int.ø 41mm ø ext. 45mm espesor 3mm		
Para modelos:	AM-700, AM900, AMS900, AMX-900, AMXR-900, AMXS-900, ECO-MAX-600, ECOMAX-650, FE, FE-W, FX, GX, HE, HE600-HL, HE-P, HX, HX-30, HX-30E, HX-30ES, HX-30S, HX-40, HX-40E, HX-40ES, HX-40S, HX-60-EHL, HX-E, HX-ES, HX-S		

			
1			
código	694621	referencia	324751
descripción	anillo de sujeción int.ø 58.5mm ø ext. 64mm espesor 3mm		
Para modelos:	AMX, AMX-E, AMX-ER, AMX-R, AMXX-1300, AMXXR-1300, AMXXS-1300, AMXXT, AUX, AUX_, AUX-E, AUX-ER, AUX-R, AUXX-1300, AUXXL, AUXXR-1300, AUXXS-1300, AUXXT, ECOMAX-700, UX, UX-30, UX-30B, UX-30E, UX-30EB, UX-30EH, UX-30ES, UX-30ESB, UX-30ESH, UX-30H, UX-30-McDonalds, UX-30S, UX-30SB, UX-30SH, UX-60, UX-60B, UX-60E, UX-60EB, UX-60EH, UX-60EHB, UX-60H, UX-60HB, UXD-30, UXL, UXLs, UXS, UXT, UXTH, UXTHL, UXTHLS, UXTHS...(Otros modelos se puede ver en la tienda web)		

			
1			
código	518127	referencia	119227 B119227
descripción	anillo deslizante para brazo de lavado pos. de montaje arriba/abajo ø ext. 40mm int.ø 19.4mm espesor 6.2mm		
Para modelos:	AM-12E, AM-12EC, AM-12EF, AM-12ER, LM-12E, UW-100, UW-105, UW-120, UW-125, UW-135, UW-135H, UW-200, UW-205		

			
1			
código	518119	referencia	00-774072-001 774072-1
descripción	anillo deslizante PTFE ø ext. 19mm int.ø 14.5mm espesor 0.5mm para brazo de aclarado UE 1 pzs para HOBART		
Para modelos:	AM-10, AM-11, AM-141, AM-700, AM900, AM900-10N, AM900-90, AMS900, AMS900-10N, AMX, AMX-10HL, AMX-90, AMX-900, AMX-E, AMX-ER, AMXR, AMX-R, AMXR-900, AMXS, AMXS-900, AMXT, AMXTS, AMXX, AMXX-1300, AMXXR, AMXXR-1300, AMXXS, AMXXS-1300, AMXXT, AUP, AUP-90, AUPS, AUX, AUX_, AUX-E, AUX-ER, AUX-R, AUXX, AUXX-1300, AUXXL, AUXXL-11N, AUXXLS-11N, AUXXR, AUXXR-1300, AUXXS, AUXXS-1300, AUXXT, AUXXTS, ECOMAX-402, ECOMAX-502...(Otros modelos se puede ver en la tienda web)		

			
1			
código	518120	referencia	00-774072-002 774072-2
descripción	anillo deslizante PTFE ø ext. 21mm int.ø 16mm espesor 0.5mm para brazo de aclarado UE 1 pzs		
Para modelos:	AM-10, AM-11, AM-141, AM-700, AM900, AM900-10N, AM900-90, AMS900, AMS900-10N, AMX, AMX-10HL, AMX-90, AMX-900, AMX-E, AMX-ER, AMXR, AMX-R, AMXR-900, AMXS, AMXS-900, AMXT, AMXTS, AMXX, AMXX-1300, AMXXR, AMXXR-1300, AMXXS, AMXXS-1300, AMXXT, AUP, AUP-90, AUPS, AUX, AUX_, AUX-E, AUX-ER, AUX-R, AUXX, AUXX-1300, AUXXL, AUXXL-11N, AUXXLS-11N, AUXXR, AUXXR-1300, AUXXS, AUXXS-1300, AUXXT, AUXXTS, ECOMAX-402, ECOMAX-502...(Otros modelos se puede ver en la tienda web)		

			
1			
código	511678	referencia	00-774072-007 774072-7
descripción	anillo deslizante PTFE ø ext. 24mm int.ø 13mm espesor 1mm para brazo de aclarado UE 1 pzs		
Para modelos:	AM-10, AM-11, AM-141, AMX, AMX-10HL, AMX-90, AMXR, AMXS, AMXX, AMXXR, AMXXS, AUP, AUP-90, AUPS, AUXX, AUXXR, AUXXS, ECOMAX-402, ECOMAX-502, ECOMAX-602-10, ECOMAX-602-11, ECOMAX-602S-11, ECOMAX-612-10, ECOMAX-612S-10, FP, FX, FX-McDonalds, GP, GX		

			
1			
código	524922	referencia	898263-1
descripción	arandela distanciadora para soporte de brazo de lavado int.ø 49mm ø ext. 70mm H 3mm		
Para modelos:	AM-700, AM900, AMS900, AMX-900, AMXR-900, AMXS-900, ECO-MAX-600, ECOMAX-650		

			
1			
código	510016	referencia	139321-180 897923
descripción	armella para empalme de recipiente abrillantador		
Para modelos:	AM-700, AM900, AMS900, AMX, AMX-900, AMX-E, AMX-ER, AMX-R, AMXR-900, AMXS-900, AMXX-1300, AMXXR-1300, AMXXS-1300, AMXXT, AUX, AUX_, AUX-E, AUX-ER, AUX-R, AUXX-1300, AUXXL, AUXXR-1300, AUXXS-1300, AUXXT, ECOMAX-600, ECOMAX-650, FE, FE-W, FX, GE-400, GW-600, GW-600S, GW-601, GW-601S, GX, HE, HE600-HL, HE-P, HX, HX-30, HX-30E, HX-30ES, HX-30S, HX-40, HX-40E, HX-40ES, HX-40S, HX-60-EHL, HX-E, HX-ES...(Otros modelos se puede ver en la tienda web)		



1

código	518114	referencia	228643 B228643
descripción	casquillo para brazo de aclarado ø 14mm H 21mm		
Para modelos:	AM-12E, AM-12EC, AM-12EF, AM-12ER, AM-600, AM-600C, AM-600CR, AM-600R, FM-30, FM-300U, FM-30U, FM-400H, FM-400U, FM-500, FM-500H, UW-100, UW-105, UW-120, UW-125, UW-135, UW-135H, UW-200, UW-205, UW-55		



1

código	530468	referencia	493414
descripción	cojinete para brazo de aclarado pos. de montaje arriba/abajo ø 15mm int.ø 12mm H 16mm		
Para modelos:	CNR, CR, CR-F		



1

código	518079	referencia	734803-1
descripción	cojinete de brazo de lavado con tuerca		
Para modelos:	AM-700, AM900, AMS900, AMX-900, AMXR-900, AMXS-900, ECOMAX-600, ECOMAX-650, FE, FE-W, FX, GX, HE, HE600-HL, HE-P, HX, HX-60-EHL, HX-E, HX-ES, HX-S		
repuestos para	518079		
	código	510634	referencia 324042
	cojinete de brazo de lavado ø 22mm H 39mm		
	código	510637	referencia 324043
	tuerca para soporte de brazo de lavado		



1

código	524880	referencia	883974-001 883974-1
descripción	cojinete de brazo de lavado pos. de montaje arriba/abajo ø 22mm H 37mm rosca 3/4"		



1

código	524831	referencia	01-510702-1 883974-002 883974-2
descripción	cojinete de brazo de lavado pos. de montaje arriba/abajo ø 22mm H 53mm con tuerca rosca 3/4"		



1

código	507497	referencia	00-883481-001 883481-1
descripción	empalme tubo de lavado ø 47mm empalme 66x36mm		
Para modelos:	AM-10, AM-11, AM-141, AM900-10N, AM900-90, AMS900-10N, AMX, AMX-10HL, AMX-90, AMXR, AMXS, AMXT, AMXTS, AMXX, AMXXR, AMXXS, AUP, AUP-90, AUPS, AUXX, AUXXL-11N, AUXXL-11N, AUXXR, AUXXS, AUXXT, AUXXTS, ECOMAX-602-10, ECOMAX-602-11, ECOMAX-602S-11, ECOMAX-612-10, ECOMAX-612S-10		



1

código	524901	referencia	371450-190
descripción	junta para carcasa de bomba L 45mm An 13mm espesor 1mm goma UE 1m		
Para modelos:	GF-60, GF-60S		



1

código	518116	referencia	00-172986-019 172986-19
descripción	junta para soporte de brazo de lavado goma ø 60mm int.ø 47mm espesor 1mm		
Para modelos:	AMX-900, AMXS-900, ECOMAX-402, ECOMAX-502, ECOMAX-650, FE, FE-W, FP, FX, FX-McDonalds, GC, GC11, GC12, GC31, GC32, GC41, GC42, GP, GX, HE, HE600-HL, HE-P, HX, HX-30, HX-30E, HX-30ES, HX-30S, HX-40, HX-40E, HX-40ES, HX-40S, HX-60-EHL, HX-E, HX-ES, HX-S		



1

código	524924	referencia	226643
descripción	junta para soporte de brazo de lavado Tesnit BA-50 int.ø 22mm L 71mm An 45mm espesor 2mm		
Para modelos:	AM-12E, AM-12EC, AM-12EF, AM-12ER, FM-30, FM-30U, FM-400H, FM-400U, FM-500, FM-500H, UW-105, UW-120, UW-125, UW-200, UW-205, UW-55		





			
1			
código	517403	referencia	00-172986-035 172986-35
descripción	junta plana EPDM ø ext. 71mm int.ø 61mm espesor 1.5mm UE 1 pzs		
Para modelos:	AM-10, AM-11, AM-141, AM900-10N, AM900-90, AMS900-10N, AMX, AMX-10HL, AMX-90, AMXR, AMXS, AMXT, AMXTS, AMXX, AMXXR, AMXXS, AUP, AUP-90, AUPS, AUXX, AUXXL-11N, AUXXLS-11N, AUXXR, AUXXS, AUXXT, AUXXTS, ECOMAX-602-10, ECOMAX-602-11, ECOMAX-602S-11, ECOMAX-612-10, ECOMAX-612S-10		

			
1			
código	511651	referencia	00-172986-022 172986-22
descripción	junta plana goma ø ext. 71mm int.ø 59mm espesor 2mm para soporte de brazo de lavado UE 1 pzs		
Para modelos:	AMX, AMX-E, AMX-ER, AMX-R, AMXX-1300, AMXXR-1300, AMXXS-1300, AMXXT, AUX, AUX_, AUX-E, AUX-ER, AUX-R, AUXX-1300, AUXXL, AUXXR-1300, AUXXS-1300, AUXXT, CR, ECOMAX-700, UX, UX-30, UX-30B, UX-30E, UX-30EB, UX-30EH, UX-30ES, UX-30ESB, UX-30ESH, UX-30H, UX-30-McDonalds, UX-30S, UX-30SB, UX-30SH, UX-60, UX-60B, UX-60E, UX-60EB, UX-60EH, UX-60EHB, UX-60H, UX-60HB, UXD-30, UXL, UXLS, UXS, UXT, UXTH, UXTHL, UXTHLS...(Otros modelos se puede ver en la tienda web)		

			
1			
código	511679	referencia	00-324071-000
descripción	pieza T empalme 17.5mm plástico L 80mm An 40mm empalme 1: 13.5mm empalme 2: 13.5mm para HOBART		
Para modelos:	AM-10, AM-11, AM-141, AM900-10N, AM900-90, AMS900-10N, AMX, AMX-10HL, AMX-90, AMXR, AMXS, AMXT, AMXTS, AMXX, AMXXR, AMXXS, AUP, AUP-90, AUPS, AUXX, AUXXL-11N, AUXXLS-11N, AUXXR, AUXXS, AUXXT, AUXXTS, ECOMAX-402, ECOMAX-602-10, ECOMAX-602-11, ECOMAX-602S-11, ECOMAX-612-10, ECOMAX-612S-10, ECOMAX-700, FE, FP, FX, FX-McDonalds, GC, GC11, GC12, GC31, GC32, GP, GX, UX, UXL, UXLS, UXS, UXT, UXTH...(Otros modelos se puede ver en la tienda web)		
accesorios para	511679		
	código	520573	referencia 00-324510-202 324510-202
	abrazadera de tubo ø 20mm espesor de hilo 2mm UE 1 pzs		

			
1			
código	511966	referencia	119229
descripción	resorte de compresión ø 23mm L 22mm espesor de hilo 1.5mm		
Para modelos:	AM-12E, AM-12EC, AM-12EF, AM-12ER, AM-600, AM-600C, AM-600CR, AM-600R, UW-100, UW-105, UW-120, UW-125, UW-135, UW-135H, UW-200, UW-205		

			
1			
código	511634	referencia	296092
descripción	soporte de brazo de aclarado pos. de montaje arriba ø 15mm H 42.5mm		
Para modelos:	AM-12E, AM-12EC, AM-12EF, AM-12ER, AM-600, AM-600C, AM-600CR, AM-600R, UW-100, UW-105, UW-120, UW-125, UW-135, UW-135H, UW-200, UW-205		

			
1			
código	518003	referencia	139321-28 139321-872
descripción	tapa roscada		
Para modelos:	GE-400, GW-600, GW-600S, GW-601, GW-601S		

			
1			
código	524684	referencia	885500-1
descripción	tapón para brazo de lavado ø 43mm int.ø 27mm		
Para modelos:	CN, CNA, CNB, CNR, CSA, ECOMAX-800, FTN		

			
1			
código	510112	referencia	139321-107 139321-873 E454002
descripción	tornillo de cabeza moleteada rosca M10 rosca L 10mm ø 22mm H 4.5mm inox		
Para modelos:	GE-400, GW-600, GW-600S, GW-601, GW-601S		

			
1			
código	518148	referencia	01-240097-001 01-240097-1
descripción	tubo de aclarado ø 17mm L 60mm		
Para modelos:	ECOMAX-402, ECOMAX-502, FP, FX, FX-McDonalds, GP, GX		



1

código	518149	referencia	00-883479-002 883479-2
descripción	tubo de aclarado ø 17mm L 69mm		
Para modelos:	AM-10, AM-11, AM-141, ECOMAX-602-10, ECOMAX-602-11, ECO-MAX-602S-11, ECOMAX-612-10, ECOMAX-612S-10		



1

código	518633	referencia	139321-643
descripción	tubo de lavado		
Para modelos:	CHF45, EF-40		



1

código	511670	referencia	00-883529-001 883529-1
descripción	tubo de lavado ø 28x56mm acero inoxidable L-Form L1 685mm L2 275mm		
Para modelos:	AM-10, AM-11, AM-141, AM900-10N, AM900-90, AMS900-10N, AMX, AMX-10HL, AMX-90, AMXR, AMXS, AMXT, AMXTS, AMXX, AMXXR, AMXXS, AUP, AUP-90, AUPS, AUXX, AUXXR, AUXXS, AUXXT, AUXXTS, ECOMAX-602-10, ECOMAX-602-11, ECOMAX-602S-11, ECO-MAX-612-10, ECOMAX-612S-10		
accesorios para	511670		



código	507497	referencia	00-883481-001 883481-1
descripción	empalme tubo de lavado ø 47mm empalme 66x36mm		



1

código	517454	referencia	308031 E308031
descripción	tuerca para brazo de lavado ø ext. 35mm espesor 11mm plástico		
Para modelos:	ECOMAX-601, H-60		



1

código	518139	referencia	01-240021-001 01-240021-1
descripción	tuerca para soporte de brazo de lavado ø 60mm		
Para modelos:	ECOMAX-402, ECOMAX-502, FP, FX, FX-McDonalds, GP, GX		



1

código	524512	referencia	324698-1
descripción	tuerca para soporte de brazo de lavado ø 74mm		
Para modelos:	AMX, AMX-E, AMX-ER, AMX-R, AMXX-1300, AMXXR-1300, AMXXS-1300, AMXXT, AUX, AUX_, AUX-E, AUX-ER, AUX-R, AUXX-1300, AUXXL, AUXXR-1300, AUXXS-1300, AUXXT, ECOMAX-700, UX, UX-30, UX-30B, UX-30E, UX-30EB, UX-30EH, UX-30ES, UX-30ESB, UX-30ESH, UX-30H, UX-30-McDonalds, UX-30S, UX-30SB, UX-30SH, UX-60, UX-60B, UX-60E, UX-60EB, UX-60EH, UX-60EHB, UX-60H, UX-60HB, UXD-30, UXL, UXLs, UXS, UXT, UXTH, UXTHL, UXTHLS, UXTHS...(Otros modelos se puede ver en la tienda web)		



1

código	518144	referencia	00-883496-001 883496-1
descripción	tuerca para soporte de brazo de lavado ø ext. 74mm EC 65 agujero ø 36mm		
Para modelos:	AM-10, AM-11, AM-141, AM900-10N, AM900-90, AMS900-10N, AMX, AMX-10HL, AMX-90, AMXR, AMXS, AMXT, AMXTS, ECOMAX-602-10, ECOMAX-602-11, ECOMAX-602S-11, ECOMAX-612-10, ECO-MAX-612S-10		

sistemas de lavado y aclarado (por fabricante)

HOBART



1

código	513145	referencia	139321-943
descripción	brazo de lavado L 510mm boquillas 10 montaje ø 16mm pos. de montaje arriba y abajo		
Para modelos:	CHH-50, CHH-60D, CHH-70D, EH-60, EH-70		



1

código	524657	referencia	01-294032-001 01-294032-1
descripción	brazo de lavado L 390mm boquillas 7 montaje ø 17/45mm		
Para modelos:	ECOMAX-402		
repuestos para	524657		



código	524665	referencia	01-240028-001 01-240028-1
descripción	boquilla ciega para limpieza M20		

Continúa en la página siguiente



accesorios para 524657			
	código	518153	referencia 01-294038-001 01-294038-1
soporte de brazo de lavado pos. de montaje arriba			





código	524645	referencia	01-240050-001 01-240050-1
descripción	brazo de lavado L 515mm boquillas 8 montaje ø 17/45mm pos. de montaje arriba/abajo		
Para modelos:	AM-10, AM-11, AM-141, ECOMAX-502, ECOMAX-602-10, ECOMAX-602-11, ECOMAX-602S-11, ECOMAX-612-10, ECOMAX-612S-10, FP, FX, FX-McDonalds, GP, GX		
repuestos para	524645		
	código	524665	referencia 01-240028-001 01-240028-1
boquilla ciega para limpieza M20			

	código	524665	referencia 01-240028-001 01-240028-1
descripción	boquilla ciega para limpieza M20		
Para modelos:	AM-10, AM-11, AM-141, ECOMAX-402, ECOMAX-502, ECOMAX-602-10, ECOMAX-602-11, ECOMAX-602S-11, ECOMAX-612-10, ECOMAX-612S-10, FP, FX, FX-McDonalds, GP, GX		

	código	518629	referencia 324039 324444 883472-1
descripción	brazo de lavado L 512mm boquillas 8 montaje ø 16/45,5mm pos. de montaje arriba y abajo		
Para modelos:	AM-700, AM900, AMS900, AMX-900, AMXR-900, AMXS-900, ECOMAX-600, ECOMAX-650, FE, FE-W, FX, HE, HE600-HL, HE-P, HX, HX-30, HX-30E, HX-30ES, HX-30S, HX-40, HX-40E, HX-40ES, HX-40S, HX-60-EHL, HX-E, HX-ES, HX-S		

	código	517589	referencia 00-324614-000 324798-1 883453-1
descripción	brazo de lavado L 535mm boquillas 16		
Para modelos:	AMX, AMX-E, AMX-ER, AMX-R, AMXX-1300, AMXXR-1300, AMXXS-1300, AMXXT, AUX, AUX_, AUX-E, AUX-ER, AUX-R, AUXX-1300, AUXXL, AUXXR-1300, AUXXS-1300, AUXXT, UXD-30		

	código	517590	referencia 00-324691-000 00-324798-002 324798-2
descripción	brazo de lavado pos. de montaje arriba/abajo L 690mm boquillas 20		
Para modelos:	ECOMAX-700, UX, UX-30, UX-30B, UX-30E, UX-30EB, UX-30EH, UX-30ES, UX-30ESB, UX-30ESH, UX-30H, UX-30-McDonalds, UX-30S, UX-30SB, UX-30SH, UX-60, UX-60B, UX-60E, UX-60EB, UX-60EH, UX-60EHB, UX-60H, UX-60HB, UXL, UXLS, UXS, UXT, UXTH, UXTHL, UXTHLS, UXTHS, UXTL, UXTLH, UXTLHS, UXTLS, UXTS		

	código	517585	referencia 00-324785-000 886610
descripción	tapa terminal para brazo de lavado ø 28mm H 10mm UE 4 pzs		
Para modelos:	AMX, AMX-E, AMX-ER, AMX-R, AMXX-1300, AMXXR-1300, AMXXS-1300, AMXXT, AUX, AUX_, AUX-E, AUX-ER, AUX-R, AUXX-1300, AUXXL, AUXXR-1300, AUXXS-1300, AUXXT, ECOMAX-700, UX, UX-30, UX-30B, UX-30E, UX-30EB, UX-30EH, UX-30ES, UX-30ESB, UX-30ESH, UX-30H, UX-30-McDonalds, UX-30S, UX-30SB, UX-30SH, UX-60, UX-60B, UX-60E, UX-60EB, UX-60EH, UX-60EHB, UX-60H, UX-60HB, UXD-30, UXL, UXLS, UXS, UXT, UXTH, UXTHL, UXTHLS, UXTHS... (Otros modelos se puede ver en la tienda web)		

	código	517587	referencia 00-886898-001 324738 324831 886898-1
descripción	brazo de aclarado pos. de montaje abajo L 680mm boquillas 11 rosca 1/4"		
Para modelos:	ECOMAX-700, UX, UX-30, UX-30B, UX-30E, UX-30EB, UX-30EH, UX-30ES, UX-30ESB, UX-30ESH, UX-30H, UX-30-McDonalds, UX-30S, UX-30SB, UX-30SH, UX-60, UX-60B, UX-60E, UX-60EB, UX-60EH, UX-60EHB, UX-60H, UX-60HB, UXL, UXLS, UXS, UXT, UXTH, UXTHL, UXTHLS, UXTHS, UXTL, UXTLH, UXTLHS, UXTLS, UXTS		

componentes mecánicos y accesorios aparatos





1

código	517588	referencia	01-240096-001 01-240096-1 323805 883126
descripción	brazo de aclarado pos. de montaje arriba/abajo L 520mm boquillas 9 rosca 1/4"		
Para modelos:	AM-700, ECOMAX-600, ECOMAX-650, FE, HE, HE600-HL, HE-P		
repuestos para	517588		
	código	referencia	324172 867429-1 886609
tapa terminal para brazo de aclarado juego 4 piezas			







1

código	510636	referencia	324172 867429-1 886609
descripción	tapa terminal para brazo de aclarado juego 4 piezas		
Para modelos:	AM-700, AM900, AMS900, AMX, AMX-900, AMX-E, AMX-ER, AMX-R, AMXR-900, AMXS-900, AMXX-1300, AMXXR-1300, AMXXS-1300, AMXXT, AUX, AUX_, AUX-E, AUX-ER, AUX-R, AUXX-1300, AUXXL, AUXXR-1300, AUXXS-1300, AUXXT, ECOMAX-600, ECOMAX-650, ECOMAX-700, FE, FE-W, FX, GX, HE, HE600-HL, HE-P, HX, HX-30, HX-30E, HX-30ES, HX-30S, HX-40, HX-40E, HX-40ES, HX-40S, HX-60-EHL, HX-E, HX-ES, HX-S, UX, UX-30, UX-30B...(Otros modelos se puede ver en la tienda web)		









1

código	524658	referencia	01-294029-001 01-294029-1
descripción	brazo de aclarado L 395mm boquillas 7 montaje ø 14mm con perno de aclarado		
Para modelos:	ECOMAX-402		
repuestos para	524658		
	código	referencia	00-774072-007 774072-7
anillo deslizante PTFE ø ext. 24mm int.ø 13mm espesor 1mm para brazo de aclarado UE 1 pzs			
	código	referencia	00-774072-001 774072-1
anillo deslizante PTFE ø ext. 19mm int.ø 14.5mm espesor 0.5mm para brazo de aclarado UE 1 pzs para HOBART			
	código	referencia	00-774072-002 774072-2
anillo deslizante PTFE ø ext. 21mm int.ø 16mm espesor 0.5mm para brazo de aclarado UE 1 pzs			



1

código	524659	referencia	01-240096-003 01-240096-3
descripción	brazo de aclarado L 515mm boquillas 8 montaje ø 16mm con perno de aclarado edición FX		
Para modelos:	AM-10, AM-11, AM-141, ECOMAX-502, ECOMAX-602-10, ECOMAX-602-11, ECOMAX-602S-11, ECOMAX-612-10, ECOMAX-612S-10, FP, FX, FX-McDonalds, GP, GX		
repuestos para	524659		
	código	referencia	00-774072-007 774072-7
anillo deslizante PTFE ø ext. 24mm int.ø 13mm espesor 1mm para brazo de aclarado UE 1 pzs			
	código	referencia	00-774072-001 774072-1
anillo deslizante PTFE ø ext. 19mm int.ø 14.5mm espesor 0.5mm para brazo de aclarado UE 1 pzs para HOBART			
	código	referencia	00-774072-002 774072-2
anillo deslizante PTFE ø ext. 21mm int.ø 16mm espesor 0.5mm para brazo de aclarado UE 1 pzs			
	código	referencia	01-240095-001 01-240095-1
perno de aclarado			
	código	referencia	01-240205-001 01-240205-1 324036
tuerca moleteada rosca M12x1 ø 32mm H 3mm pos. de montaje arriba/abajo inox para brazo de lavado int.ø 11.5mm ø ext. 32mm espesor 3mm			





1

código	503161	referencia	00-324052-000 00-324445-000 01-240096-002 01-240096-2
descripción	brazo de aclarado L 520mm boquillas 9 montaje ø 16mm		
Para modelos:	AM900, AMS900, AMX, AMX-900, AMX-E, AMX-ER, AMX-R, AMXR-900, AMXS-900, AMXX-1300, AMXXR-1300, AMXXS-1300, AMXXT, AUX, AUX_, AUX-E, AUX-ER, AUX-R, AUXX-1300, AUXXL, AUXXR-1300, AUXXS-1300, AUXXT, ECOMAX-650, FE, FX, GX, HE-P, HX, HX-30, HX-30E, HX-30ES, HX-30S, HX-40, HX-40E, HX-40ES, HX-40S, HX-60-EHL, HX-E, HX-ES, HX-S, UXD-30		



			
1			
código	503183	referencia	01-240096-004 01-240096-4
descripción	brazo de aclarado L 520mm pos. de montaje arriba/abajo boquillas 8		
Para modelos:	AM900-10N, AM900-90, AMS900-10N, AMX, AMX-10HL, AMX-90, AMXR, AMXS, AMXT, AMXTS, AMXX, AMXXR, AMXXS, AUP, AUP-90, AUPS, AUXX, AUXXL-11N, AUXXL-11N, AUXXR, AUXXS, AUXXT, AUXXTS		

			
1			
código	510648	referencia	226800-3
descripción	boquilla de aclarado		
Para modelos:	CX, FM-500, FM-500H, UW-100, UW-105, UW-120, UW-125, UW-135, UW-135H, UW-200, UW-205, UW-55, UWX		



			
1			
código	511656	referencia	00-172986-018 172986-18
descripción	junta plana goma ø ext. 13mm int.ø 7.5mm espesor 0.5mm UE 1 pzs		
Para modelos:	CX, FM-400H, FM-400U, FM-500, FM-500H, FTT, UW-105, UW-120, UW-125, UW-135, UW-135H, UW-200, UW-205, UW-55, UWX		

			
1			
código	520498	referencia	226816
descripción	tapa terminal para brazo de aclarado ø 16mm H 11mm		
Para modelos:	AM-12E, AM-12EC, AM-12EF, AM-12ER, AM-600, AM-600C, AM-600CR, AM-600R, FM-30, FM-30U, FM-400H, FM-400U, FM-500, FM-500H, UW-100, UW-105, UW-120, UW-125, UW-135, UW-135H, UW-200, UW-205, UW-55		

			
1			
código	524829	referencia	775762-1
descripción	brazo de lavado y de aclarado pos. de montaje arriba/abajo L - brazo de lavado 395mm L - brazo de aclarado 395mm boquillas de lavado 6 boquillas de aclarado 6 montaje ø 45/17mm		
Para modelos:	GC, GC11, GC12, GC31, GC32, GC41, GC42		

			
1			
código	517559	referencia	139321-870 E990109
descripción	brazo de lavado L - brazo de lavado 500mm L - brazo de aclarado 495mm boquillas de lavado 9 boquillas de aclarado 5		

			
1			
código	510010	referencia	139321-35
descripción	cruceta de brazo de lavado L1 64mm L2 60mm montaje ø 16.5mm		
Para modelos:	GE-400, GW-600, GW-600S, GW-601, GW-601S		

			
1			
código	518419	referencia	139321-784 139321-944
descripción	tapa terminal para brazo de aclarado		
Para modelos:	CHH-70D, CLG-25, EH-70		
accesorios para	518419		
	código	referencia	—
	 junta tórica EPDM espesor 1.78mm int.ø 6.07mm UE 1 pzs		



			
1			
código	518117	referencia	226800-1
descripción	boquilla de aclarado ø 7.5mm H 21.5mm		
Para modelos:	AM-12E, AM-12EC, AM-12EF, AM-12ER, FM-30, FM-30U, UW-100		

			
1			
código	530467	referencia	ML102842
descripción	soporte de brazo de lavado Kit H 56mm D1 ø 50mm int.ø 36mm		
accesorios para	530467		
	código	referencia	493414
	 cojinete para brazo de aclarado pos. de montaje arriba/abajo ø 15mm int.ø 12mm H 16mm		









			
código	524680	referencia	324670 886607
descripción	soporte de brazo de lavado Kit pos. de montaje arriba ø 62mm H 112mm int.ø 51mm		
Para modelos:	AMX, AMX-E, AMX-ER, AMX-R, AMXX-1300, AMXXR-1300, AMXXS-1300, AMXXT, AUX, AUX_, AUX-E, AUX-ER, AUX-R, AUXX-1300, AUXXL, AUXXR-1300, AUXXS-1300, AUXXT, UX-30, UX-30B, UX-30E, UX-30EB, UX-30EH, UX-30ES, UX-30ESB, UX-30ESH, UX-30H, UX-30-McDonalds, UX-30S, UX-30SB, UX-30SH, UX-60, UX-60B, UX-60E, UX-60EB, UX-60EH, UX-60EHB, UX-60H, UX-60HB, UXD-30, UXTH, UXTHL, UXTHLS, UXTHS, UXTLH, UXTLHS		

			
código	518145	referencia	00-883488-001 883488-1
descripción	soporte de brazo de lavado pos. de montaje abajo		
Para modelos:	AM-10, AM-11, AM-141, AM900-10N, AM900-90, AMS900-10N, AMX, AMX-10HL, AMX-90, AMXR, AMXS, AMXT, AMXTS, AMXX, AMXXR, AMXXS, AUP, AUP-90, AUPS, AUXX, AUXXL-11N, AUXXLS-11N, AUXXR, AUXXS, AUXXT, AUXXTS, ECOMAX-602-10, ECOMAX-602-11, ECOMAX-602S-11, ECOMAX-612-10, ECOMAX-612S-10		



accesorios para	518145			
	código	517403	referencia	00-172986-035 172986-35
	junta plana EPDM ø ext. 71mm int.ø 61mm espesor 1.5mm UE 1 pzs			
	código	518143	referencia	00-775933-003 01-515356-001 01-515356-1 775933-3
	anillo deslizante para brazo de lavado ø ext. 46mm int.ø 41mm espesor 3mm			
	código	518144	referencia	00-883496-001 883496-1
	tuerca para soporte de brazo de lavado ø ext. 74mm EC 65 agujero ø 36mm			

			
código	524669	referencia	898194-1
descripción	soporte de brazo de lavado pos. de montaje abajo		
Para modelos:	AM-700, AM900, AMS900, AMX-900, AMXR-900, AMXS-900, ECOMAX-600, ECOMAX-650		

			
código	518146	referencia	00-883467-001 883467-1
descripción	soporte de brazo de lavado pos. de montaje arriba		
Para modelos:	AM-10, AM-11, AM-141, AM900-10N, AM900-90, AMS900-10N, AMX, AMX-10HL, AMX-90, AMXR, AMXS, AMXT, AMXTS, ECOMAX-602-10, ECOMAX-602-11, ECOMAX-602S-11, ECOMAX-612-10, ECOMAX-612S-10		

				
código	518153	referencia	01-294038-001 01-294038-1	
descripción	soporte de brazo de lavado pos. de montaje arriba			
Para modelos:	ECOMAX-402, ECOMAX-502			
accesorios para	518153			
	código	518116	referencia	00-172986-019 172986-19
	junta para soporte de brazo de lavado goma ø 60mm int.ø 47mm espesor 1mm			
	código	518139	referencia	01-240021-001 01-240021-1
	tuerca para soporte de brazo de lavado ø 60mm			
	código	518143	referencia	00-775933-003 01-515356-001 01-515356-1 775933-3
	anillo deslizante para brazo de lavado ø ext. 46mm int.ø 41mm espesor 3mm			
	código	518148	referencia	01-240097-001 01-240097-1
	tubo de aclarado ø 17mm L 60mm			

			
código	518115	referencia	324268 324480
descripción	soporte de brazo de lavado pos. de montaje arriba Kit HE, HX para HOBART		
Para modelos:	AM-700, AM900, AMS900, AMX-900, AMXR-900, AMXS-900, ECOMAX-600, ECOMAX-650, HE, HE600-HL, HE-P, HX, HX-30, HX-30E, HX-30ES, HX-30S, HX-40, HX-40E, HX-40ES, HX-40S, HX-60-EHL, HX-E, HX-ES, HX-S		

				
código	510634	referencia	324042	
descripción	cojinete de brazo de lavado ø 22mm H 39mm			
Para modelos:	FE, FE-W, FX, GX, HE, HX-30, HX-30E, HX-30ES, HX-30S, HX-40, HX-40E, HX-40ES, HX-40S			
accesorios para	510634			
	código	510637	referencia	324043
	tuerca para soporte de brazo de lavado			



 <p>1</p>			
código	505253	referencia	324727 324729+324728+324730 734804.1
descripción	cojinete de brazo de lavado ø 24mm H 58mm		
Para modelos:	AMX, AMX-E, AMX-ER, AMX-R, AMXX-1300, AMXXR-1300, AMXXS-1300, AMXXT, AUX, AUX_, AUX-E, AUX-ER, AUX-R, AUXX-1300, AUXXL, AUXXR-1300, AUXXS-1300, AUXXT, ECOMAX-700, UX, UX-30, UX-30B, UX-30E, UX-30EB, UX-30EH, UX-30ES, UX-30ESB, UX-30ESH, UX-30H, UX-30-McDonalds, UX-30S, UX-30SB, UX-30SH, UX-60, UX-60B, UX-60E, UX-60EB, UX-60EH, UX-60EHB, UX-60H, UX-60HB, UXD-30, UXL, UXLS, UXS, UXT, UXTH, UXTHL, UXTHLS, UXTHS...(Otros modelos se puede ver en la tienda web)		

 <p>1</p>			
código	510635	referencia	231893-1
descripción	tuerca para soporte de brazo de lavado		
Para modelos:	AM-700, AM900, AMS900, AMX-900, AMXR-900, AMXS-900, ECOMAX-600, ECOMAX-650, FE, FE-W, FX, GX, HE, HE600-HL, HE-P, HX, HX-30, HX-30E, HX-30ES, HX-30S, HX-40, HX-40E, HX-40ES, HX-40S, HX-60-EHL, HX-E, HX-ES, HX-S		

 <p>1</p>			
código	510637	referencia	324043
descripción	tuerca para soporte de brazo de lavado		
Para modelos:	FE, FE-W, FX, GX, HE, HX-30, HX-30E, HX-30ES, HX-30S, HX-40, HX-40E, HX-40ES, HX-40S		

 <p>1</p>			
código	511671	referencia	01-240631-001 01-240631-1 01-240631-2
descripción	tuerca para soporte de brazo de lavado pos. de montaje abajo ø ext. 60mm int.ø 36mm H 45mm ø empalme 42mm		
Para modelos:	ECOMAX-402		

pernos de aclarado

 <p>1</p>			
código	510108	referencia	139321-113 E327006
descripción	perno de aclarado		
Para modelos:	GE-400, GW-600, GW-600S, GW-601, GW-601S		

 <p>1</p>			
código	513159	referencia	139321-947
descripción	perno de aclarado		
Para modelos:	CHH-70D, EH-70		



 <p>1</p>			
código	518147	referencia	01-240095-001 01-240095-1
descripción	perno de aclarado		
Para modelos:	AM-10, AM-11, AM-141, AM900-10N, AM900-90, AMS900-10N, AMX, AMX-10HL, AMX-90, AMXR, AMXS, AMXT, AMXTS, AMXX, AMXXR, AMXXS, AUP, AUP-90, AUPS, AUXX, AUXXL-11N, AUXLS-11N, AUXXR, AUXXS, AUXXT, AUXXTS, ECOMAX-402, ECOMAX-502, ECOMAX-602-10, ECOMAX-602-11, ECOMAX-602S-11, ECOMAX-612-10, ECOMAX-612S-10, FP, FX, FX-McDonalds, GP, GX		

 <p>1</p>			
código	518598	referencia	324067
descripción	perno de aclarado		
Para modelos:	AM-700, AM900, AMS900, AMX, AMX-900, AMX-E, AMX-ER, AMX-R, AMXR-900, AMXS-900, AMXX-1300, AMXXT, AUX, AUX_, AUX-E, AUX-ER, AUX-R, AUXX-1300, AUXXL, AUXXT, ECOMAX-600, ECOMAX-650, FE, FE-W, FX, GX, HE, HE600-HL, HE-P, HX, HX-30, HX-30E, HX-30ES, HX-30S, HX-40, HX-40E, HX-40ES, HX-40S, HX-60-EHL, HX-E, HX-ES, HX-S, UXD-30		

 <p>1</p>			
código	524686	referencia	324040
descripción	perno de aclarado ø 16mm H 59.5mm rosca M16x2 rosca L 14mm		
Para modelos:	AM-700, AM900, AMS900, AMX-900, AMXR-900, AMXS-900, ECOMAX-600, ECOMAX-650, FE, FE-W, FX, GX, HE, HE600-HL, HE-P, HX, HX-30, HX-30E, HX-30ES, HX-30S, HX-40, HX-40E, HX-40ES, HX-40S, HX-60-EHL, HX-E, HX-ES, HX-S		

tubos de lavado

tubos de lavado

 <p>1</p>			
código	513715	referencia	115113 139321-866
descripción	tubo de lavado		
Para modelos:	ECOMAX-500		
accesorios para	513715		
			
código	518339	referencia	139321-864
descripción	junta D2 ø 50mm espesor 2mm con 3 orificios roscados soporte brazo de lavado núm. Ref. 437064 para COLGED agujero ø 50mm dist. del agujero 67mm		

Continúa en la página siguiente

accesorios para	513715		
	código	518461	referencia 139321-865
brida para soporte de brazo de lavado			

cierres

cierres de enganche

específico del fabricante

HOBART



1	código	701126	referencia	324221
descripción cierre de enganche L 33mm con rueda rosca M12x1,75 para lavavajillas				
Para modelos: ECOMAX-700, FE, FX, GX, UX-30, UX-30E, UX-30ES, UX-30-McDonalds, UX-30S, UX-60, UX-60E				

bisagras

soporte de puerta



1	código	701301	referencia	01-240709-002 01-240709-2
descripción bisagra de puerta L 90mm An 19mm H 29mm pos. de montaje derecho abajo espesor 3mm				
Para modelos: ECOMAX-502				



1	código	701300	referencia	01-240709-001 01-240709-1
descripción bisagra de puerta L 90mm An 19mm H 29mm pos. de montaje izquierdo abajo espesor 3mm				
Para modelos: ECOMAX-502				

accesorios

otros



1	código	692307	referencia	01-240789-001 01-240789-1
descripción arandela para bisagra int. ø 8mm ø ext. 18mm plástico espesor 1mm UE 1 pzs				
Para modelos: ECOMAX-502				

pies para aparatos y tapas terminales

pies enroscables



1	código	701101	referencia	01-294066-001 01-294066-1
descripción pie de aparato rosca M10 rosca L 60mm ø 30mm H 10mm UE 1 pzs apto para HOBART				
Para modelos: ECOMAX-402, ECOMAX-502				



1	código	513284	referencia	371450-23
descripción pie de aparato rosca M8 rosca L 20mm ø 30mm H 12mm UE 1 pzs				
Para modelos: GF-60, GF-60S				

cestos

cestos de lavado

cestos de alambre de acero octogonal

cestas de lavado



1	código	971013 ¹	referencia	139321-54
descripción cesta para vajillas diversas L 382mm An 382mm H 90mm tipo de maneta de malla gruesa				
Para modelos: GW-600, GW-600S, GW-601, GW-601S				

¹de malla gruesa



cestos para vasos



1

código	971017	referencia	139321-58
descripción	cesta para vasos L 382mm An 382mm H 170mm cantidad de filas 3 distancia entre filas 120mm		
Para modelos:	GW-600, GW-600S, GW-601, GW-601S		
repuestos para	971017		
	código	970001	referencia
			—
	esquina deslizando espesor de hilo 5mm L 120mm An 120mm H 12mm L-Form		



1

código	971018	referencia	139321-57
descripción	cesta para vasos L 382mm An 382mm H 170mm cantidad de filas 4 distancia entre filas 85mm base inclinada		
Para modelos:	GW-600, GW-600S, GW-601, GW-601S		

juntas

juntas térmicas

juntas para puertas



1

código	902444	referencia	01-235313 1235313 162007
descripción	junta de puerta perfil 2510 An 670mm L 775mm medidas exteriores		

juntas tóricas

EPDM

ø1,78mm

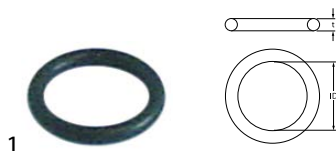

1

código	504574	referencia	67500-30
descripción	junta tórica EPDM espesor 1.78mm int.ø 9.25mm UE 1 pzs		
Para modelos:	AM-12E, AM-12EC, AM-12EF, AM-12ER, AM-600, AM-600C, AM-600CR, AM-600R, CM1E, FM-30, FM-30U, FM-400H, FM-400U, FM-500, FM-500H, FX, GX, UW-100, UW-105, UW-120, UW-125, UW-135, UW-135H, UW-200, UW-205, UW-55, WM2E		

ø2,50mm



1

código	512500	referencia	01-245340-001 01-245340-1
descripción	junta tórica EPDM espesor 0.2mm int.ø 20mm UE 1 pzs		
Para modelos:	CN-Protronic, CN-Smartronic, CP-Protronic, CS-Easytronic		

ø2,62mm



1

código	529412	referencia	139321-178
descripción	junta tórica EPDM espesor 2.62mm int.ø 10.78mm UE 1 pzs		
Para modelos:	AM-700, AM900, AMS900, AMX, AMX-900, AMX-E, AMX-ER, AMX-R, AMXR-900, AMXS-900, AMXX-1300, AMXXR-1300, AMXXS-1300, AMXXT, AUX, AUX_, AUX-E, AUX-ER, AUX-R, AUXX-1300, AUXXL, AUXXR-1300, AUXXS-1300, AUXXT, ECOMAX-600, ECOMAX-650, FE, FE-W, FX, GE-400, GW-600, GW-600S, GW-601, GW-601S, GX, HE, HE600-HL, HE-P, HX, HX-30, HX-30E, HX-30ES, HX-30S, HX-40, HX-40E, HX-40ES, HX-40S, HX-60-EHL, HX-E, HX-ES...(Otros modelos se puede ver en la tienda web)		



1

código	528919	referencia	139321-49
descripción	junta tórica EPDM espesor 2.62mm int.ø 20.24mm UE 1 pzs		
Para modelos:	GE-400, GW-600, GW-600S, GW-601, GW-601S		

ø3,00mm

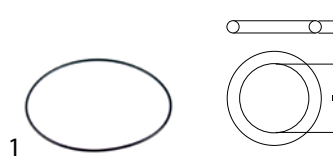

1

código	510419	referencia	00-276903-019 276903-19
descripción	junta tórica EPDM espesor 3mm int.ø 150mm UE 1 pzs		
Para modelos:	FE-W, FX, GX, HX, HX-30, HX-30E, HX-30ES, HX-30S, HX-40, HX-40E, HX-40ES, HX-40S, HX-60-EHL, HX-E, HX-ES, HX-S		

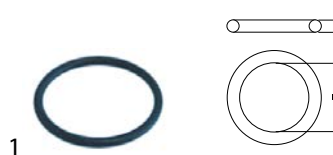

1

código	510563	referencia	276903-9
descripción	junta tórica EPDM espesor 3mm int.ø 28mm UE 1 pzs		
Para modelos:	AM-12E, AM-12EC, AM-12EF, AM-12ER, FUX, UW-100, UW-105, UW-120, UW-125, UW-135, UW-135H, UW-200, UW-205		

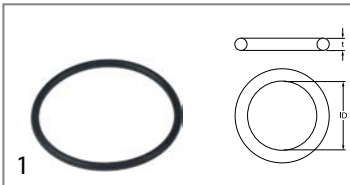

código	518113	referencia	00-276903-017 276903-17
descripción	junta tórica EPDM espesor 3mm int.ø 46mm UE 1 pzs		
Para modelos:	FE-W, FX, GX, HX, HX-30, HX-30E, HX-30ES, HX-30S, HX-40, HX-40E, HX-40ES, HX-40S, HX-60-EHL, HX-E, HX-ES, HX-S		

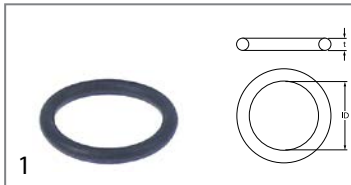

código	517087	referencia	67500-11
descripción	junta tórica EPDM espesor 3.53mm int.ø 23.4mm UE 1 pzs		
Para modelos:	AMX, AMX-E, AMX-ER, AMX-R, AUX, AUX_, AUX-E, AUX-ER, AUX-R, CN, CNA, CNB, CNR, CR, CR-F, CSA, ECOMAX-800, FTN, UX-30, UX-30B, UX-30E, UX-30EB, UX-30ES, UX-30ESB, UX-30S, UX-30SB, UX-60, UX-60B, UX-60E, UX-60EB		

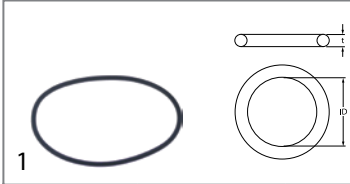

código	510427	referencia	775465-11
descripción	junta tórica EPDM espesor 3mm int.ø 83mm UE 1 pzs		
Para modelos:	AM900, AMS900, FX, GC, GC31, GC32, GC41, GC42, GX		



código	512501	referencia	00-884505-002 884505-2
descripción	junta tórica EPDM espesor 3.53mm int.ø 24.99mm UE 1 pzs		
Para modelos:	CN, CNA, CNB, CN-Protronic, CNR, CN-Smartronic, CP-Protronic, CSA, CS-Easytronic, ECOMAX-800, FTN		

ø3,53mm

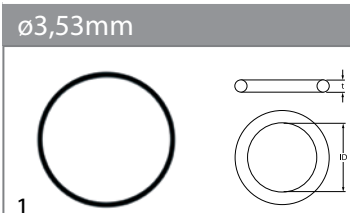

código	510009	referencia	139321-52
descripción	junta tórica EPDM espesor 3.53mm int.ø 101.2mm UE 1 pzs		
Para modelos:	GE-400, GW-600, GW-600S, GW-601, GW-601S		



código	511937	referencia	67500-12
descripción	junta tórica EPDM espesor 3.53mm int.ø 28.17mm UE 1 pzs		
Para modelos:	AM-700, AM900, AMS900, AMX-900, AMXR-900, AMXS-900, ECO-MAX-600, ECOMAX-650, ECW, HE, HE600-HL, HE-P, HX, HX-30, HX-30E, HX-30ES, HX-30S, HX-40, HX-40E, HX-40ES, HX-40S, HX-60-EHL, HX-E, HX-ES, HX-S		

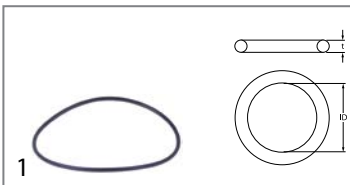

código	532537	referencia	139321-469
descripción	junta tórica EPDM espesor 3.53mm int.ø 113.9mm UE 1 pzs		
Para modelos:	CHF45, EF-40		

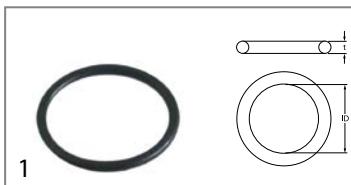

código	506015	referencia	139321-738 371450-64 456052
descripción	junta tórica EPDM espesor 3.53mm int.ø 39.69mm UE 1 pzs		
Para modelos:	CLG-25-NA, ECOMAX-400S-12, GF-60, GF-60S		

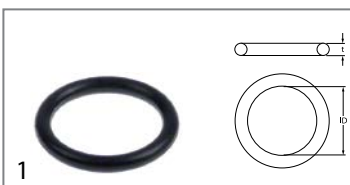

código	511322	referencia	67500-72
descripción	junta tórica EPDM espesor 3.53mm int.ø 20.22mm UE 1 pzs		
Para modelos:	103G, 203G, 2226, 303G, ACW, AM-12E, AM-12EC, AM-12EF, AM-12ER, AM-600, AM-600C, AM-600CR, AM-600R, CN, CNA, CNB, CNR, CR, CR-F, CSA, CX, ECOMAX-800, EWB-S, FTN, FTT, UW-100, UW-105, UW-135, UW-135H, UWX		

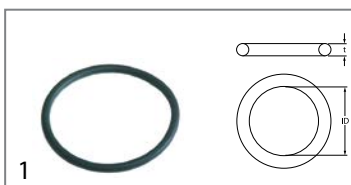

código	505180	referencia	00-233982-001 00-276903-021 233982-1 276903-21
descripción	junta tórica EPDM espesor 3.53mm int.ø 47.22mm UE 1 pzs		
Para modelos:	CO-0611E, CO-1011E, CO-2011E, CS-0611E, CS-0612E-A, CS-1011E, CS-1012E-A, CS-1022E-A, CS-2011E, CS-2012E-A, CS-2022E-A, CSD-0611E, CSD-0612E-A, CSD-1011E, CSD-1012E-A, CSD-1022E-A, CSD-2011E, CSD-2012E-A, CSD-2022E-A, FX, GX, HX, HX-30, HX-30E, HX-30ES, HX-30S, HX-40, HX-40E, HX-40ES, HX-40S, HX-E, HX-ES, HX-S		

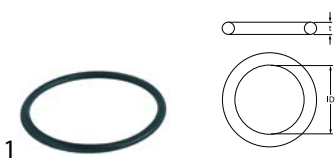

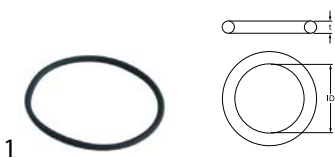

código	532118	referencia	MRTCU700565
descripción	junta tórica EPDM espesor 3.53mm int.ø 55.56mm UE 10 pzs		



código	532603	referencia	139321-1041
descripción	junta tórica EPDM espesor 3.53mm int.ø 69.85mm UE 1 pzs		

ø4,00mm



código	502076	referencia	00-276903-002 276903-2
descripción	junta tórica EPDM espesor 4mm int.ø 12mm UE 1 pzs		
Para modelos:	AM-600, AM-600C, AM-600CR, AM-600R, UW-105, UW-135, UW-135H		

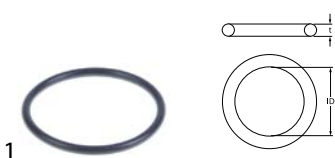

código	521035	referencia	00-276903-028 276903-28
descripción	junta tórica EPDM espesor 4mm int.ø 137mm UE 1 pzs		
Para modelos:	AM-10, AM-11, AM-141, AM-700, AM900, AM900-10N, AM900-90, AMS900, AMS900-10N, AMX, AMX-10HL, AMX-90, AMX-900, AMX-E, AMX-ER, AMXR, AMX-R, AMXR-900, AMXS, AMXS-900, AMXT, AMXTS, AMXX, AMXX-1300, AMXXR, AMXXR-1300, AMXXS, AMXXS-1300, AMXXT, AUP, AUP-90, AUPS, AUX, AUX_, AUX-E, AUX-ER, AUX-R, AUXX, AUXX-1300, AUXXL, AUXXL-11N, AUXXLS-11N, AUXXR, AUXXR-1300, AUXXS, AUXXS-1300, AUXXT, AUXXTS, CN, CNA...(Otros modelos se puede ver en la tienda web)		

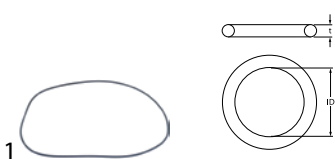

código	532663	referencia	276903-27
descripción	junta tórica EPDM espesor 4mm int.ø 305mm UE 1 pzs		
Para modelos:	AMX, AMX-E, AMX-ER, AMX-R, AUX, AUX_, AUX-E, AUX-ER, AUX-R, CN, CNA, CNB, CNR, CR, CR-F, CSA, ECOMAX-800, FTN, UX-30, UX-30B, UX-30E, UX-30EB, UX-30ES, UX-30ESB, UX-30S, UX-30SB, UX-60, UX-60B, UX-60E, UX-60EB		

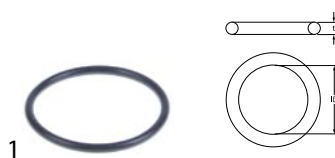

código	521033	referencia	00-276903-029 276903-29
descripción	junta tórica EPDM espesor 4mm int.ø 50mm UE 1 pzs		
Para modelos:	AM-10, AM-11, AM-141, AM900-10N, AM900-90, AMS900-10N, AMX, AMX-10HL, AMX-90, AMX-E, AMX-ER, AMXR, AMX-R, AMXS, AMXT, AMXTS, AMXX, AMXX-1300, AMXXR, AMXXR-1300, AMXXS, AMXXS-1300, AMXXT, AUP, AUP-90, AUPS, AUX, AUX_, AUX-E, AUX-ER, AUX-R, AUXX, AUXX-1300, AUXXL, AUXXL-11N, AUXXLS-11N, AUXXR, AUXXR-1300, AUXXS, AUXXS-1300, AUXXT, AUXXTS, ECOMAX-602-10, ECOMAX-602-11, ECOMAX-602S-11, ECOMAX-612-10, ECO-MAX-612S-10, UX-30, UX-30B, UX-30E...(Otros modelos se puede ver en la tienda web)		



código	502250	referencia	00-276903-031 276903-31
descripción	junta tórica EPDM espesor 4mm int.ø 74mm UE 1 pzs		
Para modelos:	AMX, AMX-E, AMX-ER, AMX-R, AUX, AUX_, AUX-E, AUX-ER, AUX-R, CN, CNA, CNB, CNR, CR, CR-F, CSA, ECOMAX-800, ECW, FTN, UX-30, UX-30B, UX-30E, UX-30EB, UX-30EH, UX-30ES, UX-30ESB, UX-30ESH, UX-30H, UX-30-McDonalds, UX-30S, UX-30SB, UX-30SH, UX-60, UX-60B, UX-60E, UX-60EB, UX-60EH, UX-60EHB, UX-60H, UX-60HB, UXD-30		

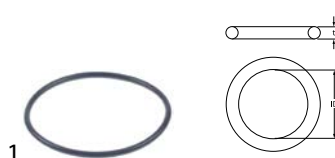

código	532666	referencia	276903-10
descripción	junta tórica EPDM espesor 4mm int.ø 75mm UE 1 pzs		
Para modelos:	AM-12E, AM-12EC, AM-12EF, AM-12ER, AM-600, AM-600C, AM-600CR, AM-600R, UW-100, UW-105		

ø5,34mm

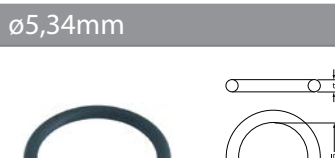

código	505092	referencia	233982-6
descripción	junta tórica EPDM espesor 5.34mm int.ø 43.82mm UE 1 pzs		
Para modelos:	CS-0612E-A, CS-1012E-A, CS-2012E-A, CSD-0612E-A, CSD-1012E-A, CSD-2012E-A		

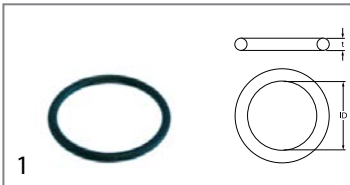

código	510409	referencia	00-276903-053 00-67500-016 00-67500-118 276903-53 670500-118 67500-16
descripción	junta tórica EPDM espesor 5.34mm int.ø 56.52mm UE 1 pzs		
Para modelos:	CR-F, CX, ECW, EWB-S, FTN, FTT, FTX, FUX, ML-104674, ML-104683, ML-104686, UW-135, UW-135H, UWX, UX-60, UX-60B, UX-60E, UX-60EB, UX-60EH, UX-60EHB, UX-60H, UX-60HB, UXT, UXTH, UXTHL, UXTHLS, UXTHS, UXTL, UXTLH, UXTLHS, UXTLS, UXTS, V1401		

otros



código	532664	referencia	276903-18
descripción	junta tórica EPDM espesor 3.5mm int.ø 103mm UE 1 pzs		
Para modelos:	FE-W, FX, GX, HX, HX-30, HX-30E, HX-30ES, HX-30S, HX-40, HX-40E, HX-40ES, HX-40S, HX-60-EHL, HX-E, HX-ES, HX-S		



código	532667	referencia	276903-26
descripción	junta tórica EPDM espesor 3.5mm int.ø 14mm UE 1 pzs		
Para modelos:	AM-700, AM900, AMS900, AMX, AMX-900, AMX-E, AMX-ER, AMX-R, AMXR-900, AMXS-900, AMXX-1300, AMXXR-1300, AMXXS-1300, AMXXT, AUX, AUX_, AUX-E, AUX-ER, AUX-R, AUXX-1300, AUXXL, AUXXR-1300, AUXXS-1300, AUXXT, ECOMAX-600, ECOMAX-650, HE, HE600-HL, HE-P, HX, HX-30, HX-30E, HX-30ES, HX-30S, HX-40, HX-40E, HX-40ES, HX-40S, HX-60-EHL, HX-E, HX-ES, HX-S, UX-30, UX-30B, UX-30E, UX-30EB, UX-30EH, UX-30ES, UX-30ESB, UX-30ESH...(Otros modelos se puede ver en la tienda web)		

Viton

ø1.50mm



código	521034	referencia	00-276903-055 276903-55
descripción	junta tórica Viton espesor 1.5mm int.ø 6mm UE 1 pzs		
Para modelos:	AM-10, AM-11, AM-141, AM900-10N, AM900-90, AMS900-10N, AMX, AMX-10HL, AMX-90, AMXR, AMXS, AMXT, AMXTS, AMXX, AMXXR, AMXXS, AUP, AUP-90, AUPS, AUX, AUXXL-11N, AUXXLS-11N, AUXXR, AUXXS, AUXXT, AUXXTS, ECOMAX-602-10, ECOMAX-602-11, ECOMAX-602S-11, ECOMAX-612-10, ECOMAX-612S-10		

ø2,00mm

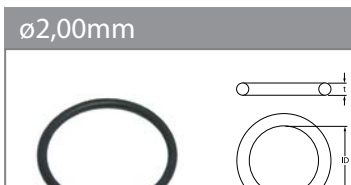

código	521031	referencia	00-276903-050 276903-50
descripción	junta tórica Viton espesor 2mm int.ø 24mm UE 1 pzs		
Para modelos:	AMX, AMX-10HL, AMX-90, AMXR, AMXS, AMXT, AMXTS, AMXX, AMXXR, AMXXS, AUP, AUP-90, AUPS, AUX, AUXXL-11N, AUXXLS-11N, AUXXR, AUXXS, AUXXT, AUXXTS, ECOMAX-402, ECOMAX-502, ECOMAX-602-11, ECOMAX-602S-11, ECOMAX-612-10, ECOMAX-612S-10, FP, FX, FX-McDonalds, GP, GX		

ø3,00mm

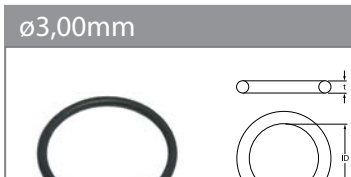

código	521032	referencia	00-276903-056 276903-56
descripción	junta tórica Viton espesor 3mm int.ø 25mm UE 1 pzs		
Para modelos:	AM-10, AM-11, AM-141, AM900-10N, AM900-90, AMS900-10N, AMX, AMX-10HL, AMX-90, AMXR, AMXS, AMXT, AMXTS, AMXX, AMXXR, AMXXS, AUP, AUP-90, AUPS, AUX, AUXXL-11N, AUXXLS-11N, AUXXR, AUXXS, AUXXT, AUXXTS, CP-Protronic, ECOMAX-602-10, ECOMAX-602-11, ECOMAX-602S-11, ECOMAX-612-10, ECOMAX-612S-10		

ø5,34mm

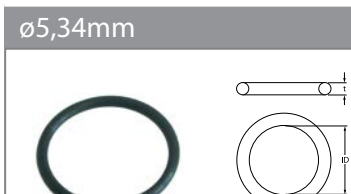

código	521030	referencia	01-240135-011 01-240135-11
descripción	junta tórica Viton espesor 5.34mm int.ø 47mm UE 1 pzs		
Para modelos:	AM-10, AM-11, AM-141, AM900-10N, AM900-90, AMS900-10N, AMX, AMX-10HL, AMX-90, AMXR, AMXS, AMXT, AMXTS, AMXX, AMXXR, AMXXS, AUP, AUP-90, AUPS, AUX, AUXXL-11N, AUXXLS-11N, AUXXR, AUXXS, AUXXT, AUXXTS, ECOMAX-402, ECOMAX-502, ECOMAX-602-10, ECOMAX-602-11, ECOMAX-602S-11, ECOMAX-612-10, ECOMAX-612S-10, FP, FX, FX-McDonalds, GP, GX		

otros



código	510149	referencia	226988
descripción	junta tórica goma espesor 6.3mm int.ø 45mm UE 1 pzs		
Para modelos:	AM-12E, AM-12EC, AM-12EF, AM-12ER, AM-600, AM-600C, AM-600CR, AM-600R, UW-100, UW-105, UW-135, UW-135H		



anillos de junta

juntas de fibra



1

código	529349	referencia	139321-21
descripción	junta plana FIBER ø ext. 22mm int.ø 16.5mm espesor 2mm para rosca 3/8" UE 1 pzs		
Para modelos:	GE-400, GW-600, GW-600S, GW-601, GW-601S		



1

código	518393	referencia	139321-173
descripción	junta plana FIBER ø ext. 24mm int.ø 17mm espesor 2mm UE 1 pzs		
Para modelos:	GF-60S, GW-600, GW-600S, GW-601, GW-601S		



1

código	524900	referencia	168611-3 300084-1
descripción	junta plana FIBER ø ext. 30mm int.ø 21mm espesor 1.6mm UE 1 pzs		
Para modelos:	201G, 301G, AM-12E, AM-12EC, AM-12EF, AM-12ER, AM-600, AM-600C, AM-600CR, AM-600R, CM1E, CN, CNA, CNB, CNR, CO-2011E, CR, CR-F, CS-2011E, CSA, CSD-2011E, ECOMAX-800, FE-W, FTN, FTT, FTX, FX, GX, HX, HX-30, HX-30E, HX-30ES, HX-30S, HX-40, HX-40E, HX-40ES, HX-40S, HX-60-EHL, HX-E, HX-ES, HX-S, UW-105, UW-120, UW-125, UW-135, UW-135H, UW-200, UW-205, UWX, UX-60...(Otros modelos se puede ver en la tienda web)		



1

código	524898	referencia	168611-11
descripción	junta plana FIBER ø ext. 35mm int.ø 22mm espesor 2mm UE 1 pzs		
Para modelos:	AMX-ER, AMX-R, AUX-ER, AUX-R, CN, CNB, CX, ECW, UW-120, UW-125, UW-200, UW-205, UWX		

juntas de goma



1

código	518060	referencia	139321-913
descripción	junta goma ø ext. 132mm int.ø 122mm espesor 5mm		
Para modelos:	CHH-50, CHH-60D, CHH-70D, EH-60, EH-70		



1

código	507495	referencia	00-775305-001 172513 775305-1
descripción	junta ø ext. 34mm int.ø 25.5mm espesor 2.5mm UE 1 pzs		
Para modelos:	AM-10, AM-11, AM-141, AM-700, AM900, AM900-10N, AM900-90, AMS900, AMS900-10N, AMX, AMX-10HL, AMX-90, AMX-900, AMX-E, AMX-ER, AMXR, AMX-R, AMXR-900, AMXS, AMXS-900, AMXT, AMXTS, AMXX, AMXX-1300, AMXXR, AMXXR-1300, AMXXS, AMXXS-1300, AMXXT, AUP, AUP-90, AUPS, AUX, AUX_, AUX-E, AUX-ER, AUX-R, AUXX, AUXX-1300, AUXXL, AUXXL-11N, AUXXLS-11N, AUXXR, AUXXR-1300, AUXXS, AUXXS-1300, AUXXT, AUXXTS, CM1E, CNA...(Otros modelos se puede ver en la tienda web)		



1

código	517403	referencia	00-172986-035 172986-35
descripción	junta plana EPDM ø ext. 71mm int.ø 61mm espesor 1.5mm UE 1 pzs		
Para modelos:	AM-10, AM-11, AM-141, AM900-10N, AM900-90, AMS900-10N, AMX, AMX-10HL, AMX-90, AMXR, AMXS, AMXT, AMXTS, AMXX, AMXXR, AMXXS, AUP, AUP-90, AUPS, AUX, AUXXL-11N, AUXXLS-11N, AUXXR, AUXXS, AUXXT, AUXXTS, ECOMAX-602-10, ECOMAX-602-11, ECOMAX-602S-11, ECOMAX-612-10, ECOMAX-612S-10		



1

código	511657	referencia	324594
descripción	junta plana goma ø ext. 12mm int.ø 6.3mm espesor 2.5mm para tubo de lavado UE 1 pzs para HOBART		
Para modelos:	AM-700, AM900, AMS900, AMX, AMX-900, AMX-E, AMX-ER, AMX-R, AMXR-900, AMXS-900, AMXX-1300, AMXXR-1300, AMXXS-1300, AMXXT, AUX, AUX_, AUX-E, AUX-ER, AUX-R, AUXX-1300, AUXXL, AUXXR-1300, AUXXS-1300, AUXXT, ECOMAX-600, ECOMAX-650, HX, HX-30, HX-30E, HX-30ES, HX-30S, HX-40, HX-40E, HX-40ES, HX-40S, HX-60-EHL, HX-E, HX-ES, HX-S, UX-30, UX-30B, UX-30E, UX-30EB, UX-30EH, UX-30ES, UX-30ESB, UX-30ESH, UX-30H, UX-30-McDonalds, UX-30S...(Otros modelos se puede ver en la tienda web)		



1

código	511656	referencia	00-172986-018 172986-18
descripción	junta plana goma ø ext. 13mm int.ø 7.5mm espesor 0.5mm UE 1 pzs		
Para modelos:	CX, FM-400H, FM-400U, FM-500, FM-500H, FTT, UW-105, UW-120, UW-125, UW-135, UW-135H, UW-200, UW-205, UW-55, UWX		





1

código	524055	referencia	229323
descripción	junta plana goma ø ext. 18mm int.ø 12mm espesor 2mm UE 1 pzs		
Para modelos:	CX, UWX		



			
1			
código	505397	referencia	437083
descripción	junta plana goma ø ext. 32mm int.ø 19.5mm espesor 1.5mm UE 1 pzs		
Para modelos:	H-60		

			
1			
código	519119	referencia	00-172986-026 172986-26
descripción	junta plana goma ø ext. 58mm int.ø 42mm espesor 3mm UE 1 pzs		
Para modelos:	CN, CNA, CNB, CNR, CR, CR-F, CSA, ECOMAX-800, ECW, FTN		

			
1			
código	524881	referencia	172 986-33
descripción	junta plana goma ø ext. 60mm int.ø 48mm espesor 3mm UE 1 pzs		
Para modelos:	AM-700, AM900, AMS900, AMX-900, AMXR-900, AMXS-900, ECO-MAX-600		

			
1			
código	511962	referencia	172986-15
descripción	junta plana goma ø ext. 62mm int.ø 44mm espesor 0.9mm UE 1 pzs		
Para modelos:	AM-600, AM-600C, AM-600CR, AM-600R, FM-400H, FM-400U, FM-500, FM-500H, FTX, FUX, UW-105, UW-120, UW-135, UW-135H, UW-200, UW-55, UWX		

			
1			
código	511651	referencia	00-172986-022 172986-22
descripción	junta plana goma ø ext. 71mm int.ø 59mm espesor 2mm para soporte de brazo de lavado UE 1 pzs		
Para modelos:	AMX, AMX-E, AMX-ER, AMX-R, AMXX-1300, AMXXR-1300, AMXXS-1300, AMXXT, AUX, AUX_, AUX-E, AUX-ER, AUX-R, AUXX-1300, AUXXL, AUXXR-1300, AUXXS-1300, AUXXT, CR, ECOMAX-700, UX, UX-30, UX-30B, UX-30E, UX-30EB, UX-30EH, UX-30ES, UX-30ESB, UX-30ESH, UX-30H, UX-30-McDonalds, UX-30S, UX-30SB, UX-30SH, UX-60, UX-60B, UX-60E, UX-60EB, UX-60EH, UX-60EHB, UX-60H, UX-60HB, UXD-30, UXL, UXLS, UXS, UXT, UXTH, UXTHL, UXTHLS...(Otros modelos se puede ver en la tienda web)		

juntas de plástico

			
1			
código	510633	referencia	324521
descripción	junta espumado ø ext. 93mm int.ø 85mm espesor 3mm UE 1 pzs		
Para modelos:	FX, GX, HX-30ES, HX-30S, HX-40ES, HX-40S, HX-ES, HX-S, UX-30ES, UX-30ESB, UX-30ESH, UX-30-McDonalds, UX-30S, UX-30SB, UX-30SH		

			
1			
código	511963	referencia	119038-1
descripción	junta plana plástico ø ext. 175mm int.ø 136mm espesor 0.125mm por brida UE 1 pzs		
Para modelos:	AM-12E, AM-12EC, AM-12EF, AM-12ER, AM-600, AM-600C, AM-600CR, AM-600R, UW-100, UW-105		

juntas de cobre

DIN-7603-A

			
1			
código	560508	referencia	WA-E-5-29
descripción	junta plana cobre ø ext. 16mm int.ø 8.3mm espesor 1mm UE 1 pzs		
Para modelos:	104G, 201G, 204G, 301G, 304G, GF-120, UW-100, UW-120, UW-125, UW-200, UW-205		

juntas de PTFE

			
1			
código	518119	referencia	00-774072-001 774072-1
descripción	anillo deslizante PTFE ø ext. 19mm int.ø 14.5mm espesor 0.5mm para brazo de aclarado UE 1 pzs para HOBART		
Para modelos:	AM-10, AM-11, AM-141, AM-700, AM900, AM900-10N, AM900-90, AMS900, AMS900-10N, AMX, AMX-10HL, AMX-90, AMX-900, AMX-E, AMX-ER, AMXR, AMX-R, AMXR-900, AMXS, AMXS-900, AMXT, AMXTS, AMXX, AMXX-1300, AMXXR, AMXXR-1300, AMXXS, AMXXS-1300, AMXXT, AUP, AUP-90, AUPS, AUX, AUX_, AUX-E, AUX-ER, AUX-R, AUXX, AUXX-1300, AUXXL, AUXXL-11N, AUXXLS-11N, AUXXR, AUXXR-1300, AUXXS, AUXXS-1300, AUXXT, AUXXTS, ECOMAX-402, ECOMAX-502...(Otros modelos se puede ver en la tienda web)		

			
1			
código	518120	referencia	00-774072-002 774072-2
descripción	anillo deslizante PTFE ø ext. 21mm int.ø 16mm espesor 0.5mm para brazo de aclarado UE 1 pzs		
Para modelos:	AM-10, AM-11, AM-141, AM-700, AM900, AM900-10N, AM900-90, AMS900, AMS900-10N, AMX, AMX-10HL, AMX-90, AMX-900, AMX-E, AMX-ER, AMXR, AMX-R, AMXR-900, AMXS, AMXS-900, AMXT, AMXTS, AMXX, AMXX-1300, AMXXR, AMXXR-1300, AMXXS, AMXXS-1300, AMXXT, AUP, AUP-90, AUPS, AUX, AUX_, AUX-E, AUX-ER, AUX-R, AUXX, AUXX-1300, AUXXL, AUXXL-11N, AUXXLS-11N, AUXXR, AUXXR-1300, AUXXS, AUXXS-1300, AUXXT, AUXXTS, ECOMAX-402, ECOMAX-502...(Otros modelos se puede ver en la tienda web)		



			
1			
código	511678	referencia	00-774072-007 774072-7
descripción	anillo deslizante PTFE ø ext. 24mm int.ø 13mm espesor 1mm para brazo de aclarado UE 1 pzs		
Para modelos:	AM-10, AM-11, AM-141, AMX, AMX-10HL, AMX-90, AMXR, AMXS, AMXX, AMXXR, AMXXS, AUP, AUP-90, AUPS, AUX, AUXR, AUXS, ECOMAX-402, ECOMAX-502, ECOMAX-602-10, ECOMAX-602-11, ECOMAX-602S-11, ECOMAX-612-10, ECOMAX-612S-10, FP, FX, FX-McDonalds, GP, GX		

			
1			
código	518346	referencia	437090
descripción	junta plana PTFE ø ext. 22mm int.ø 9.2mm espesor 1mm UE 1 pzs núm. Ref. 437090 para COLGED		
Para modelos:	H-60		

			
1			
código	518180	referencia	303018
descripción	junta plana PTFE ø ext. 40mm int.ø 35mm espesor 3mm UE 1 pzs núm. Ref. 303018/371450-166 para COLGED, HOBART		
Para modelos:	CLG-25, CLG-25-NA, ECOMAX-400-12, ECOMAX-400S-12		

juntas especiales

juntas de puerta para lavavajillas

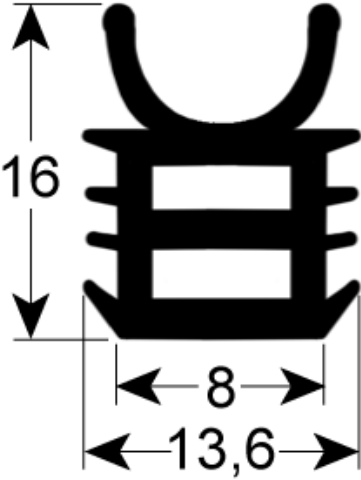
			
1			
código	518182	referencia	01-240077-001 01-240077-1
descripción	junta de puerta L 564mm An 493mm UE 1 para lavavajillas 3 lados para HOBART		
Para modelos:	FP, FX, FX-McDonalds, GP, GX		

			
1			
código	518614	referencia	774063-1
descripción	junta de puerta L 565mm An 427mm pos. de montaje arriba para lavavajillas 3 lados		
Para modelos:	FE, FE-W		

otros

			
1			
código	524903	referencia	119054
descripción	junta L 147mm An 89mm para carcasa de bomba goma ø 70mm H 2mm		
Para modelos:	AM-12E, AM-12EC, AM-12EF, AM-12ER		

			
1			
código	524902	referencia	119051
descripción	junta L 58mm An 26mm para carcasa de bomba FIBER H 2mm		
Para modelos:	AM-12E, AM-12EC, AM-12EF, AM-12ER, AM-600, AM-600C, AM-600CR, AM-600R, UW-100, UW-105		

			
1			
código	524904	referencia	296709
descripción	junta L 99mm An 78mm para carcasa de bomba goma H 6mm		
Para modelos:	ACW, CX, FTT, FTX, FUX, UW-135, UW-135H, UW		

			
1			
código	524899	referencia	371450-47
descripción	junta para captador de suciedad L 71mm An 38mm espesor 1mm goma dist. del agujero 59mm		
Para modelos:	GF-60, GF-60S		



1

código	524925	referencia	323930-2
descripción	junta para cojinete int.ø 12mm H 23mm L 30mm An 12mm pos. de montaje derecho		
Para modelos:	FE, FE-W		



1

código	524926	referencia	323930-1
descripción	junta para cojinete int.ø 12mm H 23mm L 30mm An 12mm pos. de montaje izquierdo		
Para modelos:	FE, FE-W		



1

código	511938	referencia	226556
descripción	junta para HOBART altura exterior 10mm ø ext. 70mm int.ø 45mm para salida		
Para modelos:	ACW, AM-12E, AM-12EC, AM-12EF, AM-12ER, CX, ECW, FM-30, FM-30U, FTT, FTX, FUX, UW-100, UWX		



1

código	524687	referencia	140300 227752
descripción	junta para HOBART para dosificadoras L 60mm An 48mm espesor 1.55mm dist. del agujero 48mm		
Para modelos:	CM1E, FX, GX, WM2E		



1

código	524906	referencia	323785-101
descripción	junta por pileta de desagüe ø 14mm		
Para modelos:	FX, GX		

técnica de accionamiento y rodamientos de bolas

rodamientos de bolas

cojinetes a bolas 2RS



1

código	523525	referencia	BB-015-08 BB15-8
descripción	rodamiento de bolas radial tipo 6005-2RS árbol ø 25mm ø ext. 47mm An 12mm con arandelas de junta cojinete ranurado DIN 625-1		
Para modelos:	2712, 2712C, 6430, 6430C, 6430CT, 6430T, 6460, 6460C, 6460CT, 6460M, 6460MT, 6460T, HL300, HL300AUS, HL300C, HL300CE, M802, ML-104483, ML-104484, ML-104674, ML-104683, ML-104686, ML-104687, ML-104694, ML-104696, ML-134118, ML-134185, ML-134188, V1401		



1

código	523501	referencia	602266
descripción	rodamiento de bolas radial tipo 608-2RS árbol ø 8mm ø ext. 22mm An 7mm con arandelas de junta cojinete ranurado DIN 625-1		
Para modelos:	G10R, G5R, UW-135, UW-135H, UW-55		



1

código	523509	referencia	139321-661
descripción	rodamiento de bolas radial tipo 6201-2RS árbol ø 12mm ø ext. 32mm An 10mm con arandelas de junta cojinete ranurado DIN 625-1		
Para modelos:	CHF45, EF-40		



1

código	523511	referencia	603273 BB-20-18
descripción	rodamiento de bolas radial tipo 6203-2RS árbol ø 17mm ø ext. 40mm An 12mm con arandelas de junta cojinete ranurado DIN 625-1		



1

código	523513	referencia	BB-17-39
descripción	rodamiento de bolas radial tipo 6205-2RS árbol ø 25mm ø ext. 52mm An 15mm con arandelas de junta cojinete ranurado DIN 625-1		
Para modelos:	ML-104674, ML-104683, ML-104686, V1401		



1

código	523027	referencia	BB-7-39
descripción	rodamiento de bolas radial tipo 6207-2RS árbol ø 35mm ø ext. 72mm An 17mm con arandelas de junta DIN 625-1		
Para modelos:	H600, H-600, H-600T, H800, M802, ML-104687, ML-104694, ML-104696		

muelles

resortes de compresión



1

código	511966	referencia	119229
descripción	resorte de compresión ø 23mm L 22mm espesor de hilo 1.5mm		
Para modelos:	AM-12E, AM-12EC, AM-12EF, AM-12ER, AM-600, AM-600C, AM-600CR, AM-600R, UW-100, UW-105, UW-120, UW-125, UW-135, UW-135H, UW-200, UW-205		



1

código	519539	referencia	12757-E
descripción	resorte de compresión ø 36mm espesor de hilo 3.5mm espirales 3 para mixer		

resortes de gas

resortes de gas



1

código	701241	referencia	01-240229-001 01-240229-1
descripción	resorte de gas 50N elevación 205mm D1 ø 15mm D2 ø 6mm dist. del agujero 425mm agujero ø 5/6mm L 433mm		
Para modelos:	FP, FX, FX-McDonalds, GP, GX		

resortes enrollados

resortes enrollados



1

código	519618	referencia	01-245278-6
descripción	resorte enrollado 0.53kg An 55mm int.ø 10.5mm longitud de lengüeta 28mm		



1

código	519496	referencia	774749-6
descripción	resorte enrollado An 40mm int.ø 10.5mm longitud de lengüeta 52mm		
Para modelos:	CN, CNA, CNB, CNR, CR, FTN		



1

código	517409	referencia	774749-3
descripción	resorte enrollado An 40mm int.ø 10.5mm longitud de lengüeta 54mm		
Para modelos:	CSA, FTN		



1

código	519515	referencia	229277
descripción	resorte enrollado An 40mm int.ø 35mm longitud de lengüeta 23mm		
Para modelos:	CX, FTT, FTX, FUX		



1

código	520590	referencia	01-245278-7
descripción	resorte enrollado An 55mm int.ø 11mm longitud de lengüeta 30mm		

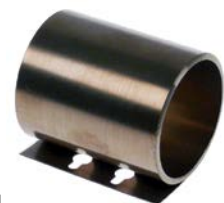

1

código	694272	referencia	299110 378591
descripción	resorte enrollado An 65mm int.ø 48mm longitud de lengüeta 24mm		
Para modelos:	UW-100, UW-105, UW-120, UW-125, UW-200, UW-205		



1

código	519514	referencia	774749-5
descripción	resorte enrollado completo An 40mm int.ø 10.5mm longitud de lengüeta 49mm		
Para modelos:	CN, CNA, CNB, CNR, CR, FTN		



1

código	519492	referencia	774749-2
descripción	resorte enrollado completo An 40mm int.ø 10.5mm longitud de lengüeta 54mm		
Para modelos:	CN, CNA, CNB, CNR, CR, CR-F, FTN		

accesorios

pernos



1

código	694271	referencia	602812
descripción	perno ø 10mm L 95mm		
Para modelos:	UW-105, UW-120, UW-125, UW-200, UW-205		

rollos



1

código	694270	referencia	299109
descripción	rollo ø 43mm An 75mm		
Para modelos:	UW-105, UW-120, UW-125, UW-200, UW-205		

resortes de tracción



1

código	503504	referencia	00-378622-001 378622-1
descripción	muelle de tracción		
Para modelos:	FX		



1

código	518260	referencia	371450-28
descripción	muelle de tracción ø 10mm longitud total 145mm espesor de hilo 1mm		
Para modelos:	GF-60, GF-60S		



1	
código	503503 referencia 227855
descripción	muelle de tracción ø 13mm longitud total 147mm espesor de hilo 1.5mm
Para modelos:	CM1E, FE, FE-W, FM-30U, FM-400U, FM-500, FX, GX, UW-55, WM2E

1	
código	504424 referencia 00-324773-000
descripción	muelle de tracción ø 20mm longitud total 245mm espesor de hilo 2.5mm para puerta UE 1 pzs
Para modelos:	UX-30, UX-30E, UX-30ES, UX-30-McDonalds, UX-30S, UX-60, UX-60E, UXD-30, UXL, UXLS

1	
código	511965 referencia 119079-2
descripción	resorte para mecanismos de capota espesor de hilo 5.5mm ø 50mm longitud total 385mm
Para modelos:	AM-12EC, AM-600C, AM-600CR, AMX, AMX-E, AMX-ER, AMX-R, AUX, AUX_, AUX-E, AUX-ER, AUX-R, FM-30, FM-400H, FM-500H, HE, HE600-HL, HE-P, HX, HX-30, HX-30E, HX-30ES, HX-30S, HX-40, HX-40E, HX-40ES, HX-40S, HX-60-EHL, HX-E, HX-ES, HX-S, UX-30EH, UX-30ESH, UX-30H, UX-30-McDonalds, UX-30SH

manómetros

1	
código	542445 referencia 00-229583-002 229583-2
descripción	manómetro ø 62mm margen de presión 0-1,6bar empalme 1/4"

dosificadores

bombas dosificadoras

SAIER

versión empotrada

sin regulación

1	
código	361835 referencia 01-240195-002 01-240195-2 028999 AH98299-H0017-2
descripción	dosificador sin regulación 3l/h 230VAC detergente tubo ø 6x4mm tipo de tubo Santoprene 4,9(5,4)W longitud del cable 750mm versión empotrada contrapresión 0.1bar 50/60Hz
Para modelos:	FP, FX-McDonalds, GP

piezas de repuesto

1	
código	361947 referencia 01-240195-011 01-240195-11 01-515268-11
descripción	kit de servicio SAIER abrillantador tipo de tubo silicona tubo ø 6x4mm con soporte
Para modelos:	FP, FX-McDonalds, GP

1	
código	361946 referencia 01-240195-012 01-240195-12 01-515268-12 883860-12
descripción	kit de servicio SAIER detergente tipo de tubo Santoprene tubo ø 6x4mm con soporte
Para modelos:	FP, FX-McDonalds, GP

SEKO

versión empotrada

sin regulación

1	
código	361150 ¹ referencia 00-775556-011 775556-11
descripción	dosificador SEKO sin regulación 0.4l/h 230VAC abrillantador tubo ø 4x6mm tipo de tubo D tubo Sekobril altura de aspiración 1.5m horizontal/vertical tipo PG medidas 67x95x52mm
Para modelos:	ECOMAX-402, ECOMAX-502, FX, FX-McDonalds, GX
repuestos para	361150
	código 361135 referencia 00-775608-001 775608-1
	tubo flexible para bomba SEKO abrillantador tubo ø 3x8mm tubo ø 4x6mm tipo de tubo D tubo Sekobril
	código 361136 referencia —
	enrollador manguera para dosificadoras agujero ø 4,8x4mm
	código 361562 referencia —
	cubierta de bomba para dosificadoras amarillo
	código 361866 referencia 00-775507-001 775507-1
	tuerca de racor para empalme de tubo ø 17mm
accesorios para	361150
	código 361144 referencia —
	kit de montaje abrillantador tipo de tubo 4x6mm longitud de tubo 2m tubo de PVC/nylon filtro de recipiente/válvula de retención transparente

¹con accesorios
Continúa en la página siguiente



accesorios para	361150		
	código	570123	referencia
			01-246301-001 01-246301-1
tubo flexible de PVC int.ø 4mm ø ext. 6mm L 3.5m grosor de la pared 1mm T máx 60°C transparente			



código	361867	referencia	00-883828-001 883828-1
descripción	dosificador SEKO sin regulación 0.4l/h 230VAC abrillantador tubo ø 4x6mm tipo de tubo D tubo Sekobril altura de aspiración 1.5m tipo NPG 0.4 8W longitud del cable 45mm versión empotrada contrapresión 1bar		
Para modelos:	AM-10, AM-11, AM-141, AM900-10N, AM900-90, AMS900-10N, AMX, AMX-10HL, AMX-90, AMXR, AMXS, AMXT, AMXTS, AMXX, AMXXR, AMXXS, AUXX, AUXXL-11N, AUXXLS-11N, AUXXR, AUXXS, AUXXT, AUXXTS, ECOMAX-602-10, ECOMAX-602-11, ECOMAX-602S-11, ECOMAX-612-10, ECOMAX-612S-10		
repuestos para	361867		
	código	361135	referencia
			00-775608-001 775608-1
tubo flexible para bomba SEKO abrillantador tubo ø 3x8mm tubo ø 4x6mm tipo de tubo D tubo Sekobril			



código	361869	referencia	00-883828-002 883828-2
descripción	dosificador SEKO sin regulación 3l/h 230VAC detergente tubo ø 4x6mm tipo de tubo K tubo Santoprene altura de aspiración 1.5m tipo NPG 3		
Para modelos:	AM-11, AM900-10N, AM900-90, AMS900-10N, AMX, AMX-10HL, AMX-90, AMXR, AMXS, AMXT, AMXTS, AMXX, AMXXR, AMXXS, AUXX, AUXXL-11N, AUXXLS-11N, AUXXR, AUXXS, AUXXT, AUXXTS, ECOMAX-602-11, ECOMAX-602S-11, ECOMAX-612-10, ECOMAX-612S-10		
repuestos para	361869		
	código	361815	referencia
			00-775608-002 775608-2
tubo flexible para bomba detergente tubo ø 6x10mm tubo ø 4x6mm tipo de tubo K tubo Santoprene tipo SEKO			



código	361868	referencia	00-775556-012 775556-12
descripción	dosificador SEKO sin regulación 3l/h 230VAC detergente tubo ø 4x6mm tipo de tubo K tubo Santoprene altura de aspiración 1.5m tipo PG 8W		
Para modelos:	ECOMAX-402, ECOMAX-502, FX, FX-McDonalds, GX		
repuestos para	361868		
	código	361815	referencia
			00-775608-002 775608-2
tubo flexible para bomba detergente tubo ø 6x10mm tubo ø 4x6mm tipo de tubo K tubo Santoprene tipo SEKO			

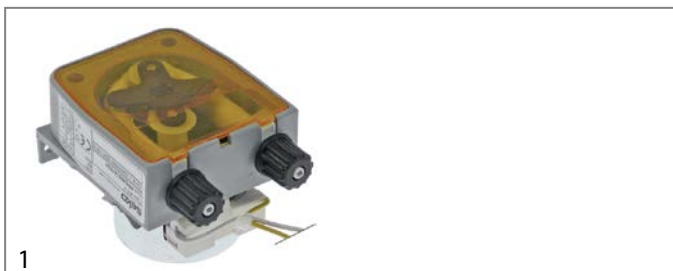

código	361896	referencia	775556-2 897931
descripción	dosificador SEKO sin regulación 3l/h 230VAC detergente tubo ø 4x6mm tipo de tubo K tubo Santoprene altura de aspiración 1.5m tipo PG 8W longitud del cable 430mm versión empotrada Kit CODE PPG0003A1024		
Para modelos:	AM-700, AM900, AMS900, AMX-900, AMXR-900, AMXS-900, AMXX-1300, AMXXR-1300, AMXXS-1300, AMXXT, AUXX-1300, AUXXL, AUXXR-1300, AUXXS-1300, AUXXT, ECOMAX-600, ECOMAX-650, ECOMAX-700, FX, GC, GC11, GC12, GC31, GC32, GC41, GC42, GX, UX, UXL, UXLS, UXS, UXT, UXTH, UXTHL, UXTHLS, UXTHS, UXTL, UXTLH, UXTLHS, UXTLS, UXTS		

piezas de repuesto

	código	362005	referencia
			00-775608-003 775608-3
tubo flexible de dosificación SEKO abrillantador tubo ø 6,25x10,55mm longitud de tubo 135mm tubo ø 4x6mm tipo de tubo M tubo Sekobril			



SEKO

1

código	361815	referencia	00-775608-002 775608-2
descripción	tubo flexible para bomba detergente tubo ø 6x10mm tubo ø 4x6mm tipo de tubo K tubo Santoprene tipo SEKO		
Para modelos:	AM-11, AM900-10N, AM900-90, AMS900-10N, AMX, AMX-10HL, AMX-90, AMXR, AMXS, AMXT, AMXTS, AMXX, AMXXR, AMXXS, AUXX, AUXXL-11N, AUXXLS-11N, AUXXR, AUXXS, AUXXT, AUXXTS, ECOMAX-402, ECOMAX-502, ECOMAX-602-11, ECOMAX-602S-11, ECOMAX-612-10, ECOMAX-612S-10, FX, FX-McDonalds, GX		

2

código	361135	referencia	00-775608-001 775608-1
descripción	tubo flexible para bomba SEKO abrillantador tubo ø 3x8mm tubo ø 4x6mm tipo de tubo D tubo Sekobril		
Para modelos:	AM-10, AM-11, AM-141, AM900-10N, AM900-90, AMS900-10N, AMX, AMX-10HL, AMX-90, AMXR, AMXS, AMXT, AMXTS, AMXX, AMXXR, AMXXS, AUXX, AUXXL-11N, AUXXLS-11N, AUXXR, AUXXS, AUXXT, AUXXTS, ECOMAX-402, ECOMAX-502, ECOMAX-602-10, ECOMAX-602-11, ECOMAX-602S-11, ECOMAX-612-10, ECOMAX-612S-10, FX, FX-McDonalds, GX		
repuestos para	361135		
	código	361866	referencia
			00-775507-001 775507-1
	tuerca de racor para empalme de tubo ø 17mm		

diversos

versión empotrada

1

código	361828	referencia	00-323772-002 00-324232-002 323772-2 324232-2
descripción	dosificador HOBART 230VAC tubo ø 6mm CODE C-323 772-2		
Para modelos:	AMX, AMX-E, AMX-ER, AMX-R, AUX, AUX_, AUX-E, AUX-ER, AUX-R, FE-W, FX, GX, HX, HX-30, HX-30E, HX-30ES, HX-30S, HX-40, HX-40E, HX-40ES, HX-40S, HX-60-EHL, HX-E, HX-ES, HX-S, UX-30, UX-30B, UX-30E, UX-30EB, UX-30EH, UX-30ES, UX-30ESB, UX-30ESH, UX-30H, UX-30-McDonalds, UX-30S, UX-30SB, UX-30SH, UX-60, UX-60B, UX-60E, UX-60EB, UX-60EH, UX-60EHB, UX-60H, UX-60HB		
repuestos para	361828		
	código	361832	referencia
			324356-2
	tubo de silicona abrillantador silicona beige		

bombas de pistón

dosificadores

1

código	361838	referencia	378625-1 378625-1P
descripción	dosificador tipo TTE 200-240V detergente entrada 5.5mm salida 5.5mm HOBART		
Para modelos:	AMX, AMX-E, AMX-ER, AMX-R, AUX, AUX_, AUX-E, AUX-ER, AUX-R, FE-W, FX, GE-400, GF-60, GF-60S, GX, HX, HX-60-EHL, HX-E, HX-ES, HX-S, UX-30, UX-30B, UX-30E, UX-30EB, UX-30EH, UX-30ES, UX-30ESB, UX-30ESH, UX-30H, UX-30-McDonalds, UX-30S, UX-30SB, UX-30SH		

1

código	361895	referencia	378625-1P + Zubeh,r 378630
descripción	dosificador tipo TTE kit de servicio 200-240V detergente entrada 5.5mm salida 5.5mm		
Para modelos:	FX, GX		
repuestos para	361895		
	código	361838	referencia
			378625-1 378625-1P
	dosificador tipo TTE 200-240V detergente entrada 5.5mm salida 5.5mm HOBART		

bombas de membrana

autoaspirantes con presión secundaria

1

código	361362	referencia	987023 E987023 E999266
descripción	dosificador abrillantador empalme presión ø 6mm empalme de presión 6		
Para modelos:	CLG-25, CLG-25-NA, ECOMAX-400-12, ECOMAX-400S-12, ECOMAX-500, ECOMAX-601		
repuestos para	361362		
	código	361363	referencia
			—
	membrana		
	código	510298	referencia
			—
	válvula labial dosificador apto para DB2/DS5		

tecnología del agua y de bebida



accesorios

filtros de recipientes con válvula de retención



1

código	361839	referencia	227441-1
descripción	filtro de recipiente con válvula antirretorno inox tubo \varnothing 6mm \varnothing 20mm L 55mm para dosificadoras		
Para modelos:	AM-12E, AM-12EC, AM-12EF, AM-12ER, AMX, AMX-E, AMX-ER, AMX-R, AUX, AUX-E, AUX-ER, AUX-R, ECOMAX-600, ECOMAX-700, ECW, FE, FE-W, FX, GE-400, GX, HE, HE600-HL, HX, HX-60-EHL, HX-E, HX-ES, HX-S, UX-30, UX-30B, UX-30E, UX-30EB, UX-30EH, UX-30ES, UX-30ESB, UX-30ESH, UX-30H, UX-30-McDonalds, UX-30S, UX-30SB, UX-30SH, UX-60, UX-60B, UX-60E, UX-60EB, UX-60EH, UX-60EHB, UX-60H, UX-60HB		

tubos flexibles

tubos flexibles de PVC



1

código	570126	referencia	01-246301-010 01-246301-10
descripción	tubo flexible de PVC int. \varnothing 4mm \varnothing ext. 6mm L 0.28m grosor de la pared 1mm T máx 60°C transparente		
Para modelos:	AMX, AMX-10HL, AMX-90, AMXR, AMXS, AMXX, AMXXR, AMXXS, AUP, AUP-90, AUPS, AUX, AUXR, AUXS, ECOMAX-402, ECOMAX-502		



1

código	570124	referencia	01-246301-008 01-246301-8
descripción	tubo flexible de PVC int. \varnothing 4mm \varnothing ext. 6mm L 0.5m grosor de la pared 1mm T máx 60°C transparente		
Para modelos:	AM-11, AM900-10N, AM900-90, AMS900-10N, AMX, AMX-10HL, AMX-90, AMXR, AMXS, AMXT, AMXTS, AMXX, AMXXR, AMXXS, AUP, AUP-90, AUPS, AUX, AUXL-11N, AUXLS-11N, AUXR, AUXS, AUXXT, AUXXTS, ECOMAX-602-11, ECOMAX-602S-11, ECOMAX-612-10, ECOMAX-612S-10		

código	520090	referencia	00-898252-002 00-898252-005 898252-2 898252-5	
descripción	tubo flexible de PVC int. \varnothing 4mm \varnothing ext. 6mm L 2m grosor de la pared 1mm T máx 60°C transparente			
Para modelos:	AM-10, AM-11, AM-141, AM-700, AM900, AM900-10N, AM900-90, AMS900, AMS900-10N, AMX, AMX-10HL, AMX-90, AMX-900, AMXR, AMXR-900, AMXS, AMXS-900, AMXT, AMXTS, AMXX, AMXX-1300, AMXXR, AMXXR-1300, AMXXS, AMXXS-1300, AMXXT, AUP, AUP-90, AUPS, AUX, AUX-1300, AUXL, AUXL-11N, AUXLS-11N, AUXR, AUXR-1300, AUXS, AUXS-1300, AUXXT, AUXXTS, ECOMAX-600, ECOMAX-602-10, ECOMAX-602-11, ECOMAX-602S-11, ECOMAX-612-10, ECOMAX-612S-10, ECOMAX-650, ECOMAX-700, GC, GC11...(Otros modelos se puede ver en la tienda web)			
accesorios para	520090			
	código	361058	referencia	—
				filtro de recipiente con válvula antirretorno inox tubo \varnothing 4x6mm \varnothing 20mm L 56mm
	código	361066	referencia	—
				filtro de recipiente recto inox tubo \varnothing 4x6mm L 37mm válvula de retención válvula de bola
	código	361106	referencia	—
				filtro de recipiente con pesa y válvula de retención inox tubo \varnothing 4x6mm \varnothing 21mm L 51mm válvula de retención válvula labial
	código	361141	referencia	139321-594
				filtro de recipiente con pesa cerámica tubo \varnothing 4mm
	código	361230	referencia	—
				filtro de recipiente con pesa acero inoxidable tubo \varnothing 4x6mm
	código	361462	referencia	—
				filtro de recipiente con pesa inox tubo \varnothing 4x6mm
	código	361728	referencia	—
				filtro de recipiente con 4m 4x6 tubo flexible inox tubo \varnothing 4x6mm longitud de tubo 4000mm

código	570123	referencia	01-246301-001 01-246301-1
descripción	tubo flexible de PVC int. \varnothing 4mm \varnothing ext. 6mm L 3.5m grosor de la pared 1mm T máx 60°C transparente		
Para modelos:	ECOMAX-402, ECOMAX-502, FP, FX, FX-McDonalds, GP, GX, UX, UXL, UXLS, UXS, UXT, UXTL, UXTLS, UXTS		

1

código	570127	referencia	01-246301-011 01-246301-11 01-515410-011
descripción	tubo flexible de PVC int.ø 4mm ø ext. 6mm L 4m grosor de la pared 1mm T máx 60°C transparente		
Para modelos:	AM-10, AM-11, AM-141, AM900-10N, AM900-90, AMS900-10N, AMX, AMX-10HL, AMX-90, AMXR, AMXS, AMXT, AMXTS, AMXX, AMXXR, AMXXS, AUP, AUP-90, AUPS, AUXX, AUXXL-11N, AUXXLS-11N, AUXXR, AUXXS, AUXXT, AUXXTS, ECOMAX-602-10, ECOMAX-602-11, ECOMAX-602S-11, ECOMAX-612-10, ECOMAX-612S-10		

caños de pared



1

código	361865	referencia	00-883676-001 883676-1
descripción	caño de pared acero inoxidable M10x1 tubo ø 5mm		
Para modelos:	AM-11, AM900-10N, AM900-90, AMS900-10N, AMX, AMX-10HL, AMX-90, AMXR, AMXS, AMXT, AMXTS, AMXX, AMXXR, AMXXS, AUP, AUP-90, AUPS, AUXX, AUXXL-11N, AUXXLS-11N, AUXXR, AUXXS, AUXXT, AUXXTS, ECOMAX-402, ECOMAX-502, ECOMAX-602-11, ECOMAX-602S-11, ECOMAX-612-10, ECOMAX-612S-10, FP, FX, FX-McDonalds, GP, GX		

diversos



1

código	520579	referencia	01-246210-001 01-246210-1
descripción	marca para tubo flexible de dosificación azul int.ø 8mm ø ext. 10mm L 40mm		
Para modelos:	AM-10, AM-11, AM-141, AM900-10N, AM900-90, AMS900-10N, AMX, AMX-10HL, AMX-90, AMXR, AMXS, AMXT, AMXTS, AMXX, AMXXR, AMXXS, AUP, AUP-90, AUPS, AUXX, AUXXL-11N, AUXXLS-11N, AUXXR, AUXXS, AUXXT, AUXXTS, ECOMAX-402, ECOMAX-502, ECOMAX-602-10, ECOMAX-602-11, ECOMAX-602S-11, ECOMAX-612-10, ECOMAX-612S-10, FX, FX-McDonalds, GX, UX, UXL, UXLS, UXS, UXT, UXTL, UXTLS, UXTS		

tubos flexibles

tubos flexibles de entrada

tubos flexibles inoxidables

tubos flexibles universales



1



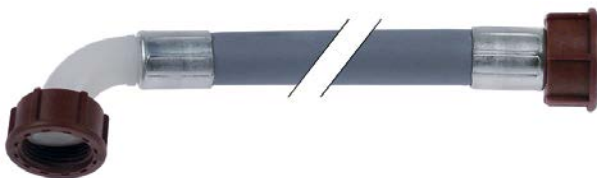

código	520578	referencia	01-240316-001 01-240316-1
descripción	latiguillo flexible trenza inox recto-curvado DN10 empalme 1: 3/4" empalme 2: 3/4" L 2000mm con junta integrada homologación DVGW p de trabajo 10bar presión de prueba 32bar p de reventamiento 95bar		
Para modelos:	AM900-10N, AM900-90, AMS900-10N, AMX, AMX-10HL, AMX-90, AMX-900, AMXR, AMXR-900, AMXS, AMXS-900, AMXT, AMXTS, AMXX, AMXX-1300, AMXXR, AMXXR-1300, AMXXS, AMXXS-1300, AMXXT, AUP, AUP-90, AUPS, AUXX, AUXX-1300, AUXXL-11N, AUXXLS-11N, AUXXR, AUXXR-1300, AUXXS, AUXXS-1300, AUXXT, AUXXTS, ECOMAX-402, ECOMAX-502, ECOMAX-602-11, ECOMAX-602S-11, ECOMAX-612-10, ECOMAX-612S-10, FP, FX, FX-McDonalds, GP, GX, UX, UXL, UXLS, UXS, UXT, UXTH... (Otros modelos se puede ver en la tienda web)		

tubos flexibles de entrada de PVC



1

código	520010	referencia	E143170	
descripción	tubo flexible de entrada PVC recto-curvado DN13 empalmes 3/4" L 1500mm p de trabajo 10bar p de reventamiento 32bar T máx 90°C azul homologación VDE cierre plana			
accesorios para	520010			
	código	520053	referencia	—
		filtro empalme 3/4" D1 ø 26mm D2 ø 15mm UE 10 pzs goma espesor 8mm		
	código	520054	referencia	—
		junta plana goma ø ext. 23.5mm int.ø 14mm espesor 2.3mm UE 10 pzs		



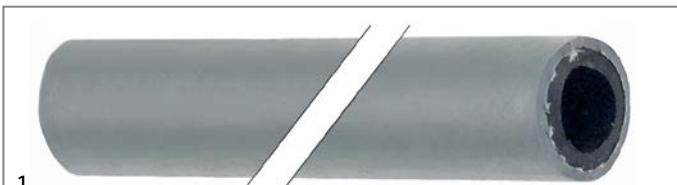

1

código	520011	referencia	139321-1030 139321-1034
descripción	tubo flexible de entrada PVC recto-curvado DN13 empalmes 3/4" L 2000mm p de trabajo 10bar p de reventamiento 32bar T máx 90°C homologación VDE cierre plana		



1

código	520015	referencia	00-775559-007 00-775559-008 00-775559-013 00-775559-016 139321-125 139321-611 775559-13 775559-16 775559-7 775559-8
descripción	tubo flexible de entrada int.ø 10mm ø ext. 17mm L 5m p de trabajo 20bar p de reventamiento 60bar T máx 95°C gris UE 5m		
Para modelos:	AM-10, AM-11, AM-141, AM-700, AM900, AM900-10N, AM900-90, AMS900, AMS900-10N, AMX, AMX-10HL, AMX-90, AMX-900, AMXR, AMXR-900, AMXS, AMXS-900, AMXT, AMXTS, AMXX, AMXX-1300, AMXXR, AMXXR-1300, AMXXS, AMXXS-1300, AMXXT, AUP, AUP-90, AUPS, AUXX, AUXX-1300, AUXXL, AUXXL-11N, AUXXLS-11N, AUXXR, AUXXR-1300, AUXXS, AUXXS-1300, AUXXT, AUXXTS, CHF45, CHH-70D, ECOMAX-600, ECOMAX-602-10, ECOMAX-602-11, ECOMAX-602S-11, ECOMAX-612-10, ECOMAX-612S-10, EF-40, EH-70...(Otros modelos se puede ver en la tienda web)		
accesorios para	520015		
	código	504377	referencia 01-240159-001 01-240159-1
	empalme de tubos boquilla ø 23mm longitud boquilla 25mm longitud total 55mm para llenado de agua		

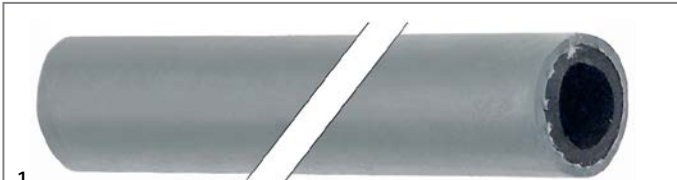

1

código	520016	referencia	143010
descripción	tubo flexible de entrada int.ø 13mm ø ext. 20mm L 40m p de trabajo 20bar p de reventamiento 60bar T máx 95°C gris UE 40m		

tubos de salida

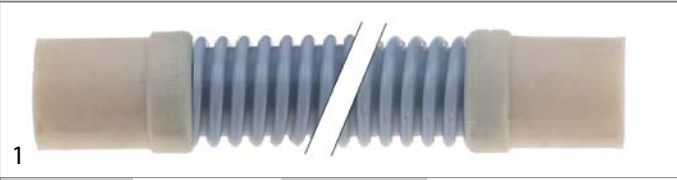

1

código	530298	referencia	00-324045-000
descripción	manguera de desagüe DN19 L 2100mm A ø interno 19mm A ø externo 25mm B ø interno 19mm B ø externo 25mm tubo ø ext. 24mm		
Para modelos:	AM900, AMS900, AMX-900, AMX-ER, AMX-R, AMXR-900, AMXS-900, AMXX-1300, AMXXR-1300, AMXXS-1300, AMXXT, AUX-ER, AUX-R, AUXX-1300, AUXXL, AUXXR-1300, AUXXS-1300, AUXXT, ECOMAX-402, ECOMAX-502, ECOMAX-650, FE-W, FX, GC, GC11, GC12, GC31, GC32, GC41, GC42, GX, HX, HX-30, HX-30E, HX-30ES, HX-30S, HX-40, HX-40E, HX-40ES, HX-40S, HX-60-EHL, HX-E, HX-ES, HX-S, UX, UXL, UXLS, UXS, UXT, UXTH...(Otros modelos se puede ver en la tienda web)		

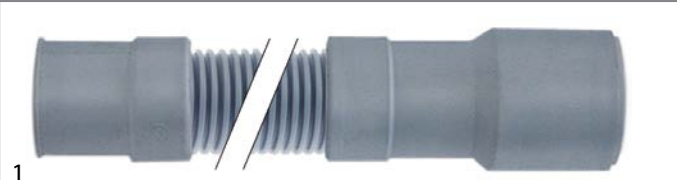

1

código	530570	referencia	00-323801-001 323801-1
descripción	manguera de desagüe DN21 L 2000mm A ø interno 21mm A ø externo 25mm B ø interno 20/29mm B ø externo 27/35mm tubo ø ext. 25mm		
Para modelos:	AM-10, AM-11, AM-141, AM-700, ECOMAX-402, ECOMAX-502, ECOMAX-600, ECOMAX-602-10, ECOMAX-602-11, ECOMAX-650, ECOMAX-700, FE, HE, HE600-HL, HE-P		

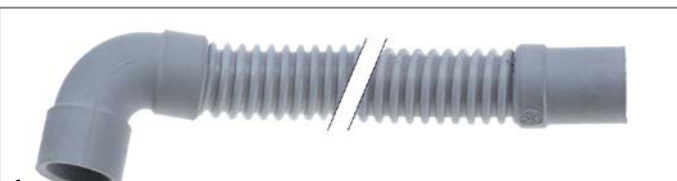

1

código	530299	referencia	00-883961-001 00-883961-002 01-243347-001 01-243347-1 883961-1 883961-2
descripción	manguera de desagüe DN19 L 2000mm ø int. recta 19mm ø ext. recto 25mm dim.ext. codo 21mm ø ext. codo 27mm tubo ø ext. 25mm		
Para modelos:	AM-700, AM900-10N, AM900-90, AMS900-10N, AMX, AMX-10HL, AMX-90, AMX-900, AMXR, AMXR-900, AMXS, AMXS-900, AMXT, AMXTS, AMXX, AMXX-1300, AMXXR, AMXXR-1300, AMXXS, AMXXS-1300, AMXXT, AUP, AUP-90, AUPS, AUXX, AUXX-1300, AUXXL-11N, AUXXLS-11N, AUXXR, AUXXR-1300, AUXXS, AUXXS-1300, AUXXT, AUXXTS, ECOMAX-600, ECOMAX-602S-11, ECOMAX-612-10, ECOMAX-612S-10, ECOMAX-700, FP, FX, FX-McDonalds, GP, GX, UX, UXL, UXLS, UXS, UXT, UXTH...(Otros modelos se puede ver en la tienda web)		

tecnología del agua y de bebida

código	518103	referencia	139321-911
descripción	manguera de desagüe DN32 L 2000mm ø int. recta 31mm ø ext. recto 35mm dim.ext. codo 51mm ø ext. codo 58mm tubo ø ext. 38mm polipropileno		
Para modelos:	CHH-50, CHH-60D, CHH-70D, EH-60, EH-70		



código	520383	referencia	H.775601
descripción	tubo flexible de PVC int.ø 4mm ø ext. 6mm L 2m grosor de la pared 1mm T máx 60°C azul		
Para modelos:	H-60		
accesorios para	520383		
	código	361058	referencia —
	filtro de recipiente con válvula antirretorno inox tubo ø 4x6mm ø 20mm L 56mm		
	código	361066	referencia —
	filtro de recipiente recto inox tubo ø 4x6mm L 37mm válvula de retención válvula de bola		
	código	361106	referencia —
	filtro de recipiente con pesa y válvula de retención inox tubo ø 4x6mm ø 21mm L 51mm válvula de retención válvula labial		
	código	361141	referencia 139321-594
	filtro de recipiente con pesa cerámica tubo ø 4mm		
	código	361230	referencia —
	filtro de recipiente con pesa acero inoxidable tubo ø 4x6mm		
	código	361462	referencia —
	filtro de recipiente con pesa inox tubo ø 4x6mm		
	código	361728	referencia —
	filtro de recipiente con 4m 4x6 tubo flexible inox tubo ø 4x6mm longitud de tubo 4000mm		

tubos flexibles industriales

tubos flexibles de PVC

tubos de PVC sin tejido



código	570000	referencia	00-775611-004 775611-4
descripción	tubo flexible de PVC int.ø 10mm ø ext. 14mm L 1.1m grosor de la pared 2mm T máx 60°C transparente		
Para modelos:	ECOMAX-502, UXTH, UXTHS, UXTLH, UXTLHS		



código	570126	referencia	01-246301-010 01-246301-10
descripción	tubo flexible de PVC int.ø 4mm ø ext. 6mm L 0.28m grosor de la pared 1mm T máx 60°C transparente		
Para modelos:	AMX, AMX-10HL, AMX-90, AMXR, AMXS, AMXX, AMXXR, AMXXS, AUP, AUP-90, AUPS, AUXX, AUXXR, AUXXS, ECOMAX-402, ECOMAX-502		





código	570124	referencia	01-246301-008 01-246301-8
descripción	tubo flexible de PVC int.ø 4mm ø ext. 6mm L 0.5m grosor de la pared 1mm T máx 60°C transparente		
Para modelos:	AM-11, AM900-10N, AM900-90, AMS900-10N, AMX, AMX-10HL, AMX-90, AMXR, AMXS, AMXT, AMXTS, AMXX, AMXXR, AMXXS, AUP, AUP-90, AUPS, AUXX, AUXXL-11N, AUXXLS-11N, AUXXR, AUXXS, AUXXT, AUXXTS, ECOMAX-602-11, ECOMAX-602S-11, ECOMAX-612-10, ECOMAX-612S-10		





código	520090	referencia	00-898252-002 00-898252-005 898252-2 898252-5
descripción	tubo flexible de PVC int.ø 4mm ø ext. 6mm L 2m grosor de la pared 1mm T máx 60°C transparente		
Para modelos:	AM-10, AM-11, AM-141, AM-700, AM900, AM900-10N, AM900-90, AMS900, AMS900-10N, AMX, AMX-10HL, AMX-90, AMX-900, AMXR, AMXR-900, AMXS, AMXS-900, AMXT, AMXTS, AMXX, AMXX-1300, AMXXR, AMXXR-1300, AMXXS, AMXXS-1300, AMXXT, AUP, AUP-90, AUPS, AUXX, AUXX-1300, AUXXL, AUXXL-11N, AUXXLS-11N, AUXXR, AUXXR-1300, AUXXS, AUXXS-1300, AUXXT, AUXXTS, ECOMAX-600, ECOMAX-602-10, ECOMAX-602-11, ECOMAX-602S-11, ECOMAX-612-10, ECOMAX-612S-10, ECOMAX-650, ECOMAX-700, GC, GC11...(Otros modelos se puede ver en la tienda web)		
accesorios para	520090		
	código	361058	referencia —
	filtro de recipiente con válvula antirretorno inox tubo ø 4x6mm ø 20mm L 56mm		
	código	361066	referencia —
	filtro de recipiente recto inox tubo ø 4x6mm L 37mm válvula de retención válvula de bola		
	código	361106	referencia —
	filtro de recipiente con pesa y válvula de retención inox tubo ø 4x6mm ø 21mm L 51mm válvula de retención válvula labial		
	código	361141	referencia 139321-594
	filtro de recipiente con pesa cerámica tubo ø 4mm		

Continúa en la página siguiente



accesorios para	520090		
	código	361230	referencia —
	filtro de recipiente con pesa acero inoxidable tubo ø 4x6mm		
	código	361462	referencia —
	filtro de recipiente con pesa inox tubo ø 4x6mm		
	código	361728	referencia —
	filtro de recipiente con 4m 4x6 tubo flexible inox tubo ø 4x6mm longitud de tubo 4000mm		

	código	570123	referencia	01-246301-001 01-246301-1
	descripción	tubo flexible de PVC int.ø 4mm ø ext. 6mm L 3.5m grosor de la pared 1mm T máx 60°C transparente		
Para modelos:	ECOMAX-402, ECOMAX-502, FP, FX, FX-McDonalds, GP, GX, UX, UXL, UXLS, UXS, UXT, UXTL, UXTLS, UXTS			

	código	570127	referencia	01-246301-011 01-246301-11 01-515410-011
	descripción	tubo flexible de PVC int.ø 4mm ø ext. 6mm L 4m grosor de la pared 1mm T máx 60°C transparente		
Para modelos:	AM-10, AM-11, AM-141, AM900-10N, AM900-90, AMS900-10N, AMX, AMX-10HL, AMX-90, AMXR, AMXS, AMXT, AMXTS, AMXX, AMXXR, AMXXS, AUP, AUP-90, AUPS, AUXX, AUXXL-11N, AUXXLS-11N, AUXXR, AUXXS, AUXXT, AUXXTS, ECOMAX-602-10, ECOMAX-602-11, ECOMAX-602S-11, ECOMAX-612-10, ECOMAX-612S-10			

	código	520027	referencia	00-324402-005 00-324402-014 139321-126 324402-14 324402-5
	descripción	tubo flexible de PVC int.ø 4mm ø ext. 7mm L 10m grosor de la pared 1.5mm T máx 60°C transparente		
Para modelos:	CN, CNB, CR, ECOMAX-402, ECOMAX-502, ECW, FTN, GE-400, GF-60, GF-60S, GW-600, GW-600S, GW-601, GW-601S			

	código	520029	referencia	00-165168-001
	descripción	tubo flexible de PVC int.ø 6mm ø ext. 9mm L 10m grosor de la pared 1.5mm T máx 60°C transparente		

tubos de silicona

sin tejido

	código	530821	referencia	00-774080-001 774080-1
	descripción	tubo de silicona int.ø 10mm ø ext. 15mm L 1m grosor de la pared 2.5mm presión de trabajo sin presión presión de reventamiento no definido T máx 200°C transparente Shore 60°		
Para modelos:	AM-10, AM-11, AM-141, AM-700, AM900, AM900-10N, AM900-90, AMS900, AMS900-10N, AMX, AMX-10HL, AMX-90, AMX-900, AMXR, AMXR-900, AMXS, AMXS-900, AMXT, AMXTS, AMXX, AMXX-1300, AMXXR, AMXXR-1300, AMXXS, AMXXS-1300, AMXXT, AUP, AUP-90, AUPS, AUXX, AUXX-1300, AUXXL, AUXXL-11N, AUXXLS-11N, AUXXR, AUXXR-1300, AUXXS, AUXXS-1300, AUXXT, AUXXTS, ECOMAX-402, ECOMAX-502, ECOMAX-600, ECOMAX-602-10, ECOMAX-602-11, ECOMAX-602S-11, ECOMAX-612-10, ECOMAX-612S-10, FP, FX...(Otros modelos se puede ver en la tienda web)			

tubos formados

recto

	código	530278	referencia	00-883776-001 883776-1
	descripción	tubo formado D1 ø 24mm L 765mm para calentador de agua int.ø 17.5mm		
Para modelos:	AM900-10N, AM900-90, AMS900-10N, AMX, AMX-10HL, AMX-90, AMXR, AMXS, AMXT, AMXTS, AMXX, AMXXR, AMXXS, AUP, AUP-90, AUPS, AUXX, AUXXL-11N, AUXXLS-11N, AUXXR, AUXXS, AUXXT, AUXXTS, ECOMAX-602-11, ECOMAX-602S-11, ECOMAX-612-10, ECOMAX-612S-10			

	código	530276	referencia	00-883721-001 883721-1
	descripción	tubo formado D1 ø 25mm D2 ø 17mm L 700mm para bomba de lavado		
Para modelos:	AM900-10N, AM900-90, AMS900-10N, AMX, AMX-10HL, AMX-90, AMXR, AMXS, AMXX, AMXXR, AMXXS, AUP, AUP-90, AUPS, AUXX, AUXXL-11N, AUXXLS-11N, AUXXR, AUXXS, ECOMAX-602-11, ECOMAX-602S-11, ECOMAX-612-10, ECOMAX-612S-10			



			
1			
código	524228	referencia	774060-1
descripción	tubo formado lavavajillas recto núm. Ref. 12127		
Para modelos:	EWB-S, FE, HE, HE600-HL, HE-P		

			
1			
código	530290	referencia	00-883775-001 883775-1
descripción	tubo formado ø tubo 26mm int. ø tubo 19mm L 655mm ø empalme 23.5mm		
Para modelos:	AM900-10N, AM900-90, AMS900-10N, AMX, AMX-10HL, AMX-90, AMXR, AMXS, AMXT, AMXTS, AMXX, AMXXR, AMXXS, AUP, AUP-90, AUPS, AUXX, AUXXL-11N, AUXXLS-11N, AUXXR, AUXXS, AUXXT, AUXXTS, ECOMAX-602-11, ECOMAX-602S-11, ECOMAX-612-10, ECOMAX-612S-10		

			
1			
código	508402	referencia	00-883680-001 883680-1
descripción	tubo formado ø tubo 32mm int. ø tubo 26mm L 85mm		
Para modelos:	AM900-10N, AM900-90, AMS900-10N, AMX, AMX-10HL, AMX-90, AMXR, AMXS, AMXT, AMXTS, AMXX, AMXXR, AMXXS, AUP, AUP-90, AUPS, AUXX, AUXXL-11N, AUXXLS-11N, AUXXR, AUXXS, AUXXT, AUXXTS, ECOMAX-602-11, ECOMAX-602S-11, ECOMAX-612-10, ECOMAX-612S-10		

<h3>forma L</h3>			
			
1			
código	507494	referencia	00-898247-002 898247-2
descripción	tubo formado terminal ø ext. 19mm altura interior 13mm ø DE2 19mm medida interior 13mm L 485mm para tubo de lavado		
Para modelos:	AM-10, AM-11, AM-141, AM900-10N, AM900-90, AMS900-10N, AMX, AMX-10HL, AMX-90, AMXR, AMXS, AMXT, AMXTS, AMXX, AMXXR, AMXXS, AUP, AUP-90, AUPS, AUXX, AUXXL-11N, AUXXLS-11N, AUXXR, AUXXS, AUXXT, AUXXTS, ECOMAX-602-10, ECOMAX-602-11, ECOMAX-602S-11, ECOMAX-612-10, ECOMAX-612S-10, UXTH, UXTHL, UXTHLS, UXTHS, UXTLH, UXTLHS		

			
1			
código	507492	referencia	00-898247-009 898247-9
descripción	tubo formado terminal ø ext. 20mm altura interior 13mm ø DE2 19mm medida interior 12mm L 755mm		
Para modelos:	AM-10, AM-11, AM-141, AM900-10N, AM900-90, AMS900-10N, AMX, AMX-10HL, AMX-90, AMXR, AMXS, AMXT, AMXTS, AMXX, AMXXR, AMXXS, AUP, AUP-90, AUPS, AUXX, AUXXL-11N, AUXXLS-11N, AUXXR, AUXXS, AUXXT, AUXXTS, ECOMAX-502, ECOMAX-602-10, ECOMAX-602-11, ECOMAX-602S-11, ECOMAX-612-10, ECOMAX-612S-10		

			
1			
código	507493	referencia	00-883524-001 883524-1
descripción	tubo formado terminal ø ext. 36.5mm altura interior 29mm ø DE2 30mm medida interior 22mm L 520mm tanque de desagüe - bomba de desagüe L-Form		
Para modelos:	AM900-10N, AM900-90, AMS900-10N, AMX, AMX-10HL, AMX-90, AMXR, AMXS, ECOMAX-602-11, ECOMAX-612-10, ECOMAX-612S-10		

<h3>forma S</h3>			
			
1			
código	510386	referencia	324199
descripción	tubo formado ø tubo 21mm int. ø tubo 16mm L 195mm UE 1 forma S		
Para modelos:	FX, GX, HX, HX-30, HX-30E, HX-30ES, HX-30S, HX-40, HX-40E, HX-40ES, HX-40S, HX-60-EHL, HX-E, HX-ES, HX-S		

para lavavajillas

<h3>otros</h3>			
			
1			
código	520592	referencia	775552-1 895495 898045-1
descripción	tubo flexible de entrada kit de servicio empalmes 3/4" L 2000mm inox recto-curvado		
Para modelos:	AMX, AMX-900, AMX-E, AMXR-900, AMXS-900, AMXX-1300, AMXXR-1300, AMXXS-1300, AMXXT, AUX, AUX-E, AUX-1300, AUXXL, AUXXR-1300, AUXXS-1300, AUXXT, ECOMAX-650, FX, GX, UX, UXL, UXLS, UXS, UXT, UXTH, UXTHS, UXTL, UXTLH, UXTLHS, UXTLS, UXTS		

			
1			
código	570126	referencia	01-246301-010 01-246301-10
descripción	tubo flexible de PVC int.ø 4mm ø ext. 6mm L 0.28m grosor de la pared 1mm T máx 60°C transparente		
Para modelos:	AMX, AMX-10HL, AMX-90, AMXR, AMXS, AMXX, AMXXR, AMXXS, AUP, AUP-90, AUPS, AUXX, AUXXR, AUXXS, ECOMAX-402, ECOMAX-502		



1

código	570124	referencia	01-246301-008 01-246301-8
descripción	tubo flexible de PVC int.ø 4mm ø ext. 6mm L 0.5m grosor de la pared 1mm T máx 60°C transparente		
Para modelos:	AM-11, AM900-10N, AM900-90, AMS900-10N, AMX, AMX-10HL, AMX-90, AMXR, AMXS, AMXT, AMXTS, AMXX, AMXXR, AMXXS, AUP, AUP-90, AUPS, AUXX, AUXXL-11N, AUXXLS-11N, AUXXR, AUXXS, AUXXT, AUXXTS, ECOMAX-602-11, ECOMAX-602S-11, ECOMAX-612-10, ECOMAX-612S-10		

guarniciones, empalmes para mangueras y tubos

empalmes de tubo

específico del fabricante



1

código	520591	referencia	139321-379
descripción	empalme de tubo rosca 1/4" acodado boquilla ø 12mm longitud boquilla 17mm longitud total 38mm rosca L 12mm latón		
Para modelos:	GE-400, GF-60, GF-60S, GW-600, GW-600S, GW-601, GW-601S		



1

código	504377	referencia	01-240159-001 01-240159-1
descripción	empalme de tubos boquilla ø 23mm longitud boquilla 25mm longitud total 55mm para llenado de agua		
Para modelos:	AM-10, AM-11, AM-141, AM900-10N, AM900-90, AMS900-10N, AMX, AMX-10HL, AMX-90, AMXR, AMXS, AMXT, AMXTS, AMXX, AMXXR, AMXXS, AUP, AUP-90, AUPS, AUXX, AUXXL-11N, AUXXLS-11N, AUXXR, AUXXS, AUXXT, AUXXTS, ECOMAX-602-10, ECOMAX-602-11, ECOMAX-602S-11, ECOMAX-612-10, ECOMAX-612S-10, FP, FX, FX-McDonalds, GP, GX		



1

código	511679	referencia	00-324071-000
descripción	pieza T empalme 17.5mm plástico L 80mm An 40mm empalme 1: 13.5mm empalme 2: 13.5mm para HOBART		
Para modelos:	AM-10, AM-11, AM-141, AM900-10N, AM900-90, AMS900-10N, AMX, AMX-10HL, AMX-90, AMXR, AMXS, AMXT, AMXTS, AMXX, AMXXR, AMXXS, AUP, AUP-90, AUPS, AUXX, AUXXL-11N, AUXXLS-11N, AUXXR, AUXXS, AUXXT, AUXXTS, ECOMAX-402, ECOMAX-602-10, ECOMAX-602-11, ECOMAX-602S-11, ECOMAX-612-10, ECOMAX-612S-10, ECOMAX-700, FE, FP, FX, FX-McDonalds, GC, GC11, GC12, GC31, GC32, GP, GX, UX, UXL, UXLS, UXS, UXT, UXTH...(Otros modelos se puede ver en la tienda web)		

accesorios para 511679



código	520573	referencia	00-324510-202 324510-202
abrazadera de tubo ø 20mm espesor de hilo 2mm UE 1 pzs			

válvulas y caños de pared

válvulas de flotador

válvulas de flotador



1

código	518118	referencia	897665-1
descripción	válvula de flotador entrada 3/4" salida 13.5mm reducción entrada A 3.5l/min reducción salidal/min margen de presión 0,3-10bar MÜLLER tipo 21.010.115 para contenedor agua reducción entrada A azul oscuro reducción salida		
Para modelos:	CNA, CNB, CNR, CSA, FTN		

descalcificadores

diversos accesorios



1

código	530174	referencia	00-775918-050 775918-150 775918-50
descripción	tapa Kit para descalcificador		
Para modelos:	ECOMAX-402, ECOMAX-502, ECOMAX-602S-11, ECOMAX-612S-10		

componentes para el circuito agua

filtros de entrada



1

código	520261	referencia	E927078
descripción	filtro de entrada rosca 1/2" H - 1/2" H longitud 58mm latón rojo luz de malla 0.4mm		



material auxiliar

abrazaderas

abrazaderas de tubo

DIN 3017 - W2



1

código	520114	referencia	423008
descripción	abrazadera de tubo ø 20-32mm ancho 9mm UE 10 pzs DIN 3017		

abrazaderas de alambre doble



1

código	520573	referencia	00-324510-202
descripción	abrazadera de tubo ø 20mm espesor de hilo 2mm UE 1 pzs		
Para modelos:	AMX, AMX-E, AMX-ER, AMX-R, AUX, AUX_, AUX-E, AUX-ER, AUX-R, ECOMAX-402, ECOMAX-502, ECOMAX-700, FE, FE-W, FP, FX, FX-McDonalds, GC41, GC42, GP, GX, HE, HE600-HL, HE-P, HX, HX-30, HX-30E, HX-30ES, HX-30S, HX-40, HX-40E, HX-40ES, HX-40S, HX-60-EHL, HX-E, HX-ES, HX-S, UX, UX-30, UX-30B, UX-30E, UX-30EB, UX-30EH, UX-30ES, UX-30ESB, UX-30ESH, UX-30H, UX-30-McDonalds, UX-30S, UX-30SB... (Otros modelos se puede ver en la tienda web)		



1

código	520577	referencia	00-324510-242
descripción	abrazadera de tubo ø 24mm espesor de hilo 2mm UE 1 pzs		
Para modelos:	AMX, AMX-E, AMX-ER, AMX-R, AMXX-1300, AMXXR-1300, AMXXS-1300, AUX, AUX_, AUX-E, AUX-ER, AUX-R, AUXX-1300, AUXXR-1300, AUXXS-1300, CN, CNA, CNB, CNR, CR, ECOMAX-402, ECOMAX-502, ECOMAX-700, FE, FE-W, FP, FX, FX-McDonalds, GC, GC11, GC12, GC31, GC32, GC41, GC42, GP, GX, HE-P, HX, HX-30, HX-30E, HX-30ES, HX-30S, HX-40, HX-40E, HX-40ES, HX-40S, HX-60-EHL, HX-E, HX-ES... (Otros modelos se puede ver en la tienda web)		



1

código	520574	referencia	00-324510-327
descripción	abrazadera de tubo ø 32mm espesor de hilo 3mm UE 1 pzs		
Para modelos:	AMX, AMX-900, AMX-E, AMX-ER, AMX-R, AMXR-900, AMXS-900, AMXX-1300, AMXXR-1300, AMXXS-1300, AMXXT, AUX, AUX-E, AUX-ER, AUX-R, AUXX-1300, AUXXL, AUXXR-1300, AUXXS-1300, AUXXT, ECOMAX-502, ECOMAX-650, ECOMAX-700, FE, FP, FX, FX-McDonalds, GP, GX, UX, UXD-30, UXL, Uxls, UXS, UXT, UXTH, UXTHL, UXTHLS, UXTHS, UXTL, UXTLH, UXTLHS, UXTLS, UXTS		



1

código	513268	referencia	00-303340-008 00-324510-068 139321-580 303340-8 324510-68
descripción	abrazadera de tubo ø 8-10mm espesor de hilo 1mm UE 1 pzs		
Para modelos:	AM-10, AM-11, AM-141, AM-700, AM900, AM900-10N, AM900-90, AMS900, AMS900-10N, AMX, AMX-10HL, AMX-90, AMX-900, AMXR, AMXR-900, AMXS, AMXS-900, AMXT, AMXTS, AMXX, AMXX-1300, AMXXR, AMXXR-1300, AMXXS, AMXXS-1300, AMXXT, AUP, AUP-90, AUPS, AUXX, AUXX-1300, AUXXL, AUXXL-11N, AUXXLS-11N, AUXXR, AUXXR-1300, AUXXS, AUXXS-1300, AUXXT, AUXXTS, CHF45, ECOMAX-600, ECOMAX-602-10, ECOMAX-602-11, ECOMAX-602S-11, ECOMAX-612-10, ECOMAX-612S-10, ECOMAX-650, ECOMAX-700, EF-40... (Otros modelos se puede ver en la tienda web)		

abrazaderas de alambre doble con tornillo



1

código	505281	referencia	00-323945-015 323945-15
descripción	abrazadera de tubo ø 15mm acero zincado UE 20 pzs		
Para modelos:	AM-10, AM-11, AM-141, AM-700, AM900, AM900-10N, AM900-90, AMS900, AMS900-10N, AMX, AMX-10HL, AMX-90, AMX-900, AMXR, AMXR-900, AMXS, AMXS-900, AMXT, AMXTS, AMXX, AMXX-1300, AMXXR, AMXXR-1300, AMXXS, AMXXS-1300, AMXXT, AUP, AUP-90, AUPS, AUXX, AUXX-1300, AUXXL, AUXXL-11N, AUXXLS-11N, AUXXR, AUXXR-1300, AUXXS, AUXXS-1300, AUXXT, AUXXTS, ECOMAX-402, ECOMAX-502, ECOMAX-600, ECOMAX-602-10, ECOMAX-602-11, ECOMAX-602S-11, ECOMAX-612-10, ECOMAX-612S-10, FP, FX... (Otros modelos se puede ver en la tienda web)		



1

código	505282	referencia	00-323945-016 323945-16
descripción	abrazadera de tubo ø 16mm acero zincado UE 20 pzs		
Para modelos:	AM-700, AM900, AMS900, AMX, AMX-900, AMX-E, AMX-ER, AMX-R, AMXR-900, AMXS-900, AMXX-1300, AMXXR-1300, AMXXS-1300, AMXXT, AUX, AUX-E, AUX-ER, AUX-R, AUXX-1300, AUXXL, AUXXR-1300, AUXXS-1300, AUXXT, ECOMAX-402, ECOMAX-502, ECOMAX-600, ECOMAX-650, GC, UX, UXL, Uxls, UXS, UXT, UXTH, UXTHL, UXTHLS, UXTHS, UXTL, UXTLH, UXTLHS, UXTLS, UXTS		



1

código	505283	referencia	00-323945-018 323945-18
descripción	abrazadera de tubo ø 18mm acero zincado UE 20 pzs		
Para modelos:	AM-10, AM-11, AM-141, AM-700, AM900, AM900-10N, AM900-90, AMS900, AMS900-10N, AMX, AMX-10HL, AMX-90, AMX-900, AMX-E, AMX-ER, AMXR, AMX-R, AMXR-900, AMXS, AMXS-900, AMXT, AMXTS, AMXX, AMXX-1300, AMXXR, AMXXR-1300, AMXXS, AMXXS-1300, AMXXT, AUP, AUP-90, AUPS, AUX, AUX-E, AUX-ER, AUX-R, AUXX, AUXX-1300, AUXXL-11N, AUXXLS-11N, AUXXR, AUXXR-1300, AUXXS, AUXXS-1300, AUXXT, AUXXTS, ECOMAX-402, ECOMAX-502, ECOMAX-600, ECOMAX-602-10...(Otros modelos se puede ver en la tienda web)		



1

código	505286	referencia	00-323945-029 323945-29
descripción	abrazadera de tubo ø 29mm acero zincado UE 20 pzs		
Para modelos:	AM900-10N, AM900-90, AMS900-10N, AMX, AMX-10HL, AMX-90, AMX-E, AMX-ER, AMXR, AMX-R, AMXS, AMXT, AMXTS, AMXX, AMXX-1300, AMXXR, AMXXR-1300, AMXXS, AMXXS-1300, AMXXT, AUP, AUP-90, AUPS, AUX, AUX-E, AUX-ER, AUX-R, AUXX, AUXX-1300, AUXXL, AUXXL-11N, AUXXLS-11N, AUXXR, AUXXR-1300, AUXXS, AUXXS-1300, AUXXT, AUXXTS, CR, CR-F, ECOMAX-602-11, ECOMAX-602S-11, ECOMAX-612-10, ECOMAX-612S-10, ECOMAX-700, FE, GC, GC11, GC12, GC31...(Otros modelos se puede ver en la tienda web)		



1

código	505284	referencia	00-323945-019 00-323945-021 323945-19 -alt- 323945-21
descripción	abrazadera de tubo ø 21mm acero zincado UE 20 pzs		
Para modelos:	AM-10, AM-11, AM-141, AM-700, AM900-10N, AM900-90, AMS900-10N, AMX, AMX-10HL, AMX-90, AMX-E, AMX-ER, AMXR, AMX-R, AMXS, AMXT, AMXTS, AMXX, AMXX-1300, AMXXR, AMXXR-1300, AMXXS, AMXXS-1300, AMXXT, AUP, AUP-90, AUPS, AUX, AUX-E, AUX-ER, AUX-R, AUXX, AUXX-1300, AUXXL, AUXXL-11N, AUXXLS-11N, AUXXR, AUXXR-1300, AUXXS, AUXXS-1300, AUXXT, AUXXTS, ECOMAX-402, ECOMAX-502, ECOMAX-600, ECOMAX-602-10, ECOMAX-602-11, ECOMAX-602S-11, ECOMAX-612-10, ECOMAX-612S-10...(Otros modelos se puede ver en la tienda web)		



1

código	505287	referencia	00-323945-033 323945-33
descripción	abrazadera de tubo ø 33mm acero zincado UE 20 pzs		
Para modelos:	AM-700, AM900, AM900-10N, AM900-90, AMS900, AMS900-10N, AMX, AMX-10HL, AMX-90, AMX-900, AMXR, AMXR-900, AMXS, AMXS-900, AMXX, AMXXR, AMXXS, AUP, AUP-90, AUPS, AUXX, AUXXL-11N, AUXXLS-11N, AUXXR, AUXXS, CN-Protronic, CN-Smartronic, CP-Protronic, CR-F, ECOMAX-402, ECOMAX-502, ECOMAX-600, ECOMAX-602-11, ECOMAX-612-10, ECOMAX-612S-10, ECOMAX-650, ECOMAX-700, FX, GC31, GC32, GC41, GC42, GX		



1

código	505285	referencia	00-323945-025 323945-25
descripción	abrazadera de tubo ø 25mm acero zincado UE 20 pzs		
Para modelos:	AM-10, AM-11, AM-141, AM-700, AM900, AM900-10N, AM900-90, AMS900, AMS900-10N, AMX, AMX-10HL, AMX-90, AMX-900, AMX-E, AMX-ER, AMXR, AMX-R, AMXR-900, AMXS, AMXS-900, AMXT, AMXTS, AMXX, AMXX-1300, AMXXR, AMXXR-1300, AMXXS, AMXXS-1300, AMXXT, AUP, AUP-90, AUPS, AUX, AUX-E, AUX-ER, AUX-R, AUXX, AUXX-1300, AUXXL, AUXXL-11N, AUXXLS-11N, AUXXR, AUXXR-1300, AUXXS, AUXXS-1300, AUXXT, AUXXTS, ECOMAX-402, ECOMAX-502, ECOMAX-600...(Otros modelos se puede ver en la tienda web)		



1

código	505293	referencia	00-323945-035 323945-35
descripción	abrazadera de tubo ø 34-38mm acero zincado UE 20 pzs		
Para modelos:	AM900-10N, AM900-90, AMS900-10N, AMX, AMX-10HL, AMX-90, AMXR, AMXS, AMXT, AMXTS, AMXX, AMXXR, AMXXS, AUP, AUP-90, AUPS, AUXX, AUXXL-11N, AUXXLS-11N, AUXXR, AUXXS, AUXXT, AUXXTS, CR, CR-F, ECOMAX-402, ECOMAX-502, ECOMAX-602-11, ECOMAX-602S-11, ECOMAX-612-10, ECOMAX-612S-10, ECOMAX-650		



			
1			
código	505290	referencia	00-323945-037 323945-37
descripción	abrazadera de tubo ø 37mm acero zincado UE 10 pzs		
Para modelos:	AM-700, AM900, AMS900, AMX-900, AMXR-900, AMXS-900, AMXT, AMXTS, AMXX-1300, AMXXR-1300, AMXXS-1300, AMXXT, AUXX-1300, AUXXL, AUXXR-1300, AUXXS-1300, AUXXT, AUXXTS, CR, ECOMAX-402, ECOMAX-502, ECOMAX-600, ECOMAX-700, FP, FX, FX-McDonalds, GC41, GC42, GP, GX, UX, UXL, UXLS, UXS, UXT, UXTX, UXTXL, UXTLS, UXTHS, UXTL, UXTLH, UXTLHS, UXTLS, UXTS		

			
1			
código	505292	referencia	00-323945-064 323945-64
descripción	abrazadera de tubo ø 64-68mm acero zincado UE 10 pzs		
Para modelos:	AM-10, AM-11, AM-141, AM900-10N, AM900-90, AMS900-10N, AMX, AMX-10HL, AMX-90, AMXR, AMXS, AMXT, AMXTS, AUXXT, AUXXTS, CN-Protronic, CN-Smartronic, CP-Protronic, CS-Easytronic, ECOMAX-602-10, ECOMAX-602-11, ECOMAX-602S-11, ECOMAX-612-10, ECOMAX-612S-10, ECOMAX-700, UX, UXL, UXLS, UXS, UXT, UXTL, UXTLS, UXTS		

			
1			
código	505294	referencia	00-323945-053 323945-53
descripción	abrazadera de tubo ø 53mm acero zincado UE 10 pzs		
Para modelos:	CN-Protronic, CN-Smartronic, CP-Protronic, CSA, CS-Easytronic, ECOMAX-402, ECOMAX-502, FE, GC, GC11, GC12, GC31, GC32, GC41, GC42, HE, HE600-HL, HE-P, UX-30, UX-30B, UX-30E, UX-30EB, UX-30EH, UX-30ES, UX-30ESB, UX-30ESH, UX-30H, UX-30-McDonalds, UX-30S, UX-30SB, UX-30SH, UX-60, UX-60B, UX-60E, UX-60EB, UX-60EH, UX-60EHB, UX-60H, UX-60HB		

			
1			
código	505291	referencia	00-323945-056 323945-56
descripción	abrazadera de tubo ø 56mm acero zincado UE 10 pzs		
Para modelos:	AM-700, AM900, AMS900, AMX-900, AMXR-900, AMXS-900, CR, ECOMAX-402, ECOMAX-502, ECOMAX-600, ECOMAX-650, FE, HE, HE600-HL, HE-P		

			
1			
código	505289	referencia	00-323945-060 323945-60
descripción	abrazadera de tubo ø 60mm acero zincado UE 10 pzs		
Para modelos:	AM-10, AM-11, AM-141, AM900-10N, AM900-90, AMS900-10N, AMX, AMX-10HL, AMX-90, AMXR, AMXS, AMXT, AMXTS, AMXX, AMXXR, AMXXS, AUP, AUP-90, AUPS, AUXX, AUXXL-11N, AUXXLS-11N, AUXXR, AUXXS, AUXXT, AUXXTS, CSA, ECOMAX-602-10, ECOMAX-602-11, ECOMAX-602S-11, ECOMAX-612-10, ECOMAX-612S-10		

sistemas de medición

termómetros

termómetros incorporados

			
1			
código	541969	referencia	228720-2 228720-3
descripción	termómetro medido de montaje 58x25,5mm +30 a +120°C capilar 3000mm sonda ø 8.5mm sonda L 35mm		
Para modelos:	AMX, AMX-R, AUX, AUX-R, CR-F, CSA, ECOMAX-600, ECOMAX-700, ECOMAX-800, ECW, FX, GX, HX-30, HX-30S, HX-40, HX-40S, UW-120, UW-200, UX-30, UX-30B, UX-30S, UX-30SB, UX-60, UX-60B		

material de sujeción

tornillos

tornillos de cabeza avellanada

			
1			
código	560215	referencia	603182
descripción	tornillo de cabeza avellanada rosca M5 L 14mm inox DIN 963/ISO 2009 UE 20 pzs soporte ranura ø cabezal 9.2mm		
Para modelos:	CR, FE, FE-W, FX, GC, GC11, GC12, GC31, GC32, GC41, GC42, GX, HE, HE600-HL, HE-P, HX, HX-30, HX-30E, HX-30ES, HX-30S, HX-40, HX-40E, HX-40ES, HX-40S, HX-60-EHL, HX-E, HX-ES, HX-S, UXD-30		

tecnología del agua y de bebida



tornillos de cabeza plana



1

código	560062	referencia	603455
descripción	tornillo de cabeza plana rosca M4 rosca L 10mm inox DIN 7985/ISO 7045 UE 20 pzs soporte Phillips ø cabezal 8mm espesor cabezal 2mm		
Para modelos:	CO-0611E, CO-1011E, CO-2011E, CS-0611E, CS-1011E, CS-2011E, CSD-0611E, CSD-1011E, CSD-2011E, UW-105		



1

código	560061	referencia	602687
descripción	tornillo de cabeza plana rosca M4 rosca L 6mm inox DIN 7985/ISO 7045 UE 20 pzs soporte Phillips ø cabezal 8mm espesor cabezal 2mm		
Para modelos:	AMX, AMX-E, AMX-ER, AMX-R, AUX, AUX_, AUX-E, AUX-ER, AUX-R, ECOMAX-600, ECOMAX-700, FE, FUX, FX, GX, HE, HE600-HL, HE-P, HX, HX-30, HX-30E, HX-30ES, HX-30S, HX-40, HX-40E, HX-40ES, HX-40S, HX-E, HX-ES, HX-S, UX-30, UX-30B, UX-30E, UX-30EB, UX-30EH, UX-30ES, UX-30ESB, UX-30ESH, UX-30H, UX-30-McDonalds, UX-30S, UX-30SB, UX-30SH, UX-60, UX-60B, UX-60E, UX-60EB, UX-60EH, UX-60EHB, UX-60H...(Otros modelos se puede ver en la tienda web)		

tuercas hexagonales



1

código	550528	referencia	00-609782-000
descripción	tornillo de seguridad rosca M5 EC 8 UE 10 pzs L 8mm ø cabezal 11mm		
Para modelos:	AM-10, AM-11, AM-141, AM900-10N, AM900-90, AMS900-10N, AMX, AMX-10HL, AMX-90, AMXR, AMXS, AMXT, AMXTS, AMXX, AMXXR, AMXXS, AUP, AUP-90, AUPS, AUX, AUXL-11N, AUXLS-11N, AUXXR, AUXXS, AUXXT, AUXXTS, ECOMAX-602-10, ECOMAX-602-11, ECOMAX-602S-11, ECOMAX-612-10, ECOMAX-612S-10		

tornillos prisioneros

DIN 913/ISO 4026



1

código	504733	referencia	VA-261-1
descripción	tornillo prisionero rosca M4 L 5mm acero inoxidable DIN 913 soporte Allen hexagonal EC 2 UE 1 pzs		

tornillos de cabeza moleteada



1

código	510112	referencia	139321-107 139321-873 E454002
descripción	tornillo de cabeza moleteada rosca M10 rosca L 10mm ø 22mm H 4.5mm inox		
Para modelos:	GE-400, GW-600, GW-600S, GW-601, GW-601S		

tuercas

tuercas moleteadas



1

código	518152	referencia	01-240205-001 01-240205-1 324036
descripción	tuerca moleteada rosca M12x1 ø 32mm H 3mm pos. de montaje arriba/abajo inox para brazo de lavado int.ø 11.5mm ø ext. 32mm espesor 3mm		
Para modelos:	AM-10, AM-11, AM-141, AM-700, AM900, AM900-10N, AM900-90, AMS900, AMS900-10N, AMX, AMX-10HL, AMX-90, AMX-900, AMX-E, AMX-ER, AMXR, AMX-R, AMXR-900, AMXS, AMXS-900, AMXT, AMXTS, AMXX, AMXX-1300, AMXXR, AMXXR-1300, AMXXS, AMXXS-1300, AMXXT, AUP, AUP-90, AUPS, AUX, AUX_, AUX-E, AUX-ER, AUX-R, AUX, AUX-1300, AUXL, AUXL-11N, AUXLS-11N, AUXXR, AUXXR-1300, AUXXS, AUXXS-1300, AUXXT, AUXXTS, ECOMAX-402, ECOMAX-502...(Otros modelos se puede ver en la tienda web)		

tuercas hexagonales

DIN 934 / ISO 4032/8673



1

código	511212	referencia	602491
descripción	tuerca hexagonal rosca M6 H 5mm EC 10 inox DIN/ISO DIN 934 / ISO 4032/8673 UE 1 pzs		
Para modelos:	ACW, AM-600, AM-600C, AM-600CR, AM-600R, AMX, AMX-E, AMX-ER, AMX-R, AMXX-1300, AMXXR-1300, AMXXS-1300, AMXXT, AUX, AUX_, AUX-E, AUX-ER, AUX-R, AUX-1300, AUXL, AUXXR-1300, AUXXS-1300, AUXXT, CDC, CNA, CNR, CO-0611E, CO-0612E, CO-1011E, CO-1012E, CO-2011E, CS-0611E, CS-0612E, CS-0612E-A, CS-1011E, CS-1012E, CS-1012E-A, CS-1012G, CS-1022E, CS-1022E-A, CS-2011E, CS-2012E, CS-2022E, CSD-0611E, CSD-0612E, CSD-0612E-A, CSD-1011E, CSD-1012E, CSD-1012E-A, CSD-1013G...(Otros modelos se puede ver en la tienda web)		



DIN 985



1

código	560460	referencia	602504
descripción	tuerca hexagonal rosca M10 H 15mm inox EC 17 autobloqueo UE 1 pzs DIN/ISO 985		
Para modelos:	AM-600, AM-600C, AM-600CR, AM-600R, AM900, AMS900, AMX-900, AMXR-900, AMXS-900, AMXX-1300, AMXXR-1300, AMXXS-1300, AMXXT, AUXX-1300, AUXXR-1300, AUXXS-1300, AUXXT, CDC, CN, CNA, CNB, CNR, CTC, ECOMAX-700, ECW, FTX, FUX, MS-34R, MS-41R, UW-105, UW-120, UW-125, UW-135, UW-135H, UW-200, UW-205, UX, UXL, Uxls, UXS, UXT, UXTH, UXTHL, UXTHLS, UXTHS, UXTL, UXTLH, UXTLHS, UXTLS, UXTS		

otros



1

código	696438	referencia	00-775460-001 775460-1
descripción	tuerca expansible plástico UE 1 pzs para tonillo de chapa		
Para modelos:	AM-10, AM-11, AM-141, AM-700, AM900, AM900-10N, AM900-90, AMS900, AMS900-10N, AMX, AMX-10HL, AMX-90, AMX-900, AMXR, AMXR-900, AMXS, AMXS-900, AMXT, AMXTS, AMXX, AMXX-1300, AMXXR, AMXXR-1300, AMXXS, AMXXS-1300, AMXXT, AUP, AUP-90, AUPS, AUXX, AUXX-1300, AUXXL, AUXXL-11N, AUXXLS-11N, AUXXR, AUXXR-1300, AUXXS, AUXXS-1300, AUXXT, AUXXTS, ECOMAX-600, ECOMAX-602-10, ECOMAX-602-11, ECOMAX-602S-11, ECOMAX-612-10, ECOMAX-612S-10, ECOMAX-650, ECOMAX-700, FP, FX... (Otros modelos se puede ver en la tienda web)		

arandelas

arandelas elásticas



1

código	560121	referencia	371020-562 602308 VC032-09
descripción	arandela grower int.ø 4.2mm ø ext. 8mm inox DIN127 UE 20 pzs para rosca M4		
Para modelos:	AM-600, AM-600C, AM-600CR, AM-600R, AMX, AMX-E, AMX-ER, AMX-R, AUX, AUX_, AUX-E, AUX-ER, AUX-R, CO-0611E, CO-0612E, CO-1011E, CO-1012E, CO-2011E, CS-0423E, CS-0423EK, CS-0523E, CS-0523EK, CS-0611E, CS-0612E, CS-1011E, CS-1012E, CS-1012E-A, CS-1022E, CS-1022E-A, CS-2011E, CS-2012E, CS-2022E, CS-423E, CS-423K, CSD-0611E, CSD-0612E, CSD-0612ET, CSD-1011E, CSD-1012E, CSD-1012E-A, CSD-1012ET, CSD-1013G, CSD-1022E, CSD-1022E-A, CSD-2011E, CSD-2012E, CSD-2012ET, CSD-2013G, CSD-2022E, CSL-0423E... (Otros modelos se puede ver en la tienda web)		



1

código	560122	referencia	140506-28 602306
descripción	arandela grower int.ø 5.2mm ø ext. 9mm inox DIN127 UE 20 pzs para rosca M5		
Para modelos:	AM-600, AM-600C, AM-600CR, AM-600R, CO-0611E, CO-0612E, CO-1011E, CO-1012E, CO-2011E, CS-0611E, CS-0612E, CS-0612E-A, CS-1011E, CS-1012E, CS-1012E-A, CS-1012G, CS-1022E, CS-1022E-A, CS-2011E, CS-2012E, CS-2012G, CS-2022E, CSD-0611E, CSD-0612E, CSD-0612E-A, CSD-1011E, CSD-1012E, CSD-1012E-A, CSD-1013G, CSD-1022E, CSD-1022E-A, CSD-2011E, CSD-2012E, CSD-2013G, CSD-2022E, FE, FE-W, FM-400H, FM-400U, FM-500, FM-500H, FTX, FUX, FX, G10R, G5R, GX, HE-P, HX, HX-30... (Otros modelos se puede ver en la tienda web)		

arandelas

DIN 125A



1

código	560356	referencia	602288
descripción	arandela int.ø 10.5mm ø ext. 20mm espesor 2mm inox UE 1 pzs DIN 125A para rosca M10		
Para modelos:	ACW, AM-600, AM-600C, AM-600CR, AM-600R, AM-700, AM900, AMS900, AMX, AMX-900, AMX-E, AMX-ER, AMX-R, AMXR-900, AMXS-900, AMXX-1300, AMXXR-1300, AMXXS-1300, AMXXT, AUX, AUX_, AUX-E, AUX-ER, AUX-R, AUXX-1300, AUXXL, AUXXR-1300, AUXXS-1300, AUXXT, CDC, CN, CNA, CNB, CNR, CO-2011E, CS-2011E, CSD-2011E, CTC, ECOMAX-600, ECOMAX-650, ECOMAX-700, ECW, FE-W, FTN, FTT, FTX, FUX, FX, GC, GC11... (Otros modelos se puede ver en la tienda web)		

otros



1

código	524117	referencia	602286
descripción	arandela int.ø 6.4mm ø ext. 12mm espesor 1.6mm inox UE 1 pzs		



1

código	692307	referencia	01-240789-001 01-240789-1
descripción	arandela para bisagra int.ø 8mm ø ext. 18mm plástico espesor 1mm UE 1 pzs		
Para modelos:	ECOMAX-502		

sujeciones

abrazaderas

abrazaderas de tubo

DIN 3017 - W2



1

código	520114	referencia	423008
descripción	abrazadera de tubo ø 20-32mm ancho 9mm UE 10 pzs DIN 3017		

abrazaderas de alambre doble



1

código	520573	referencia	00-324510-202
descripción	abrazadera de tubo ø 20mm espesor de hilo 2mm UE 1 pzs		
Para modelos:	AMX, AMX-E, AMX-ER, AMX-R, AUX, AUX_, AUX-E, AUX-ER, AUX-R, ECOMAX-402, ECOMAX-502, ECOMAX-700, FE, FE-W, FP, FX, FX-McDonalds, GC41, GC42, GP, GX, HE, HE600-HL, HE-P, HX, HX-30, HX-30E, HX-30ES, HX-30S, HX-40, HX-40E, HX-40ES, HX-40S, HX-60-EHL, HX-E, HX-ES, HX-S, UX, UX-30, UX-30B, UX-30E, UX-30EB, UX-30EH, UX-30ES, UX-30ESB, UX-30ESH, UX-30H, UX-30-McDonalds, UX-30S, UX-30SB... (Otros modelos se puede ver en la tienda web)		



1

código	520577	referencia	00-324510-242
descripción	abrazadera de tubo ø 24mm espesor de hilo 2mm UE 1 pzs		
Para modelos:	AMX, AMX-E, AMX-ER, AMX-R, AMXX-1300, AMXXR-1300, AMXXS-1300, AUX, AUX_, AUX-E, AUX-ER, AUX-R, AUXX-1300, AUXXR-1300, AUXXS-1300, CN, CNA, CNB, CNR, CR, ECOMAX-402, ECOMAX-502, ECOMAX-700, FE, FE-W, FP, FX, FX-McDonalds, GC, GC11, GC12, GC31, GC32, GC41, GC42, GP, GX, HE-P, HX, HX-30, HX-30E, HX-30ES, HX-30S, HX-40, HX-40E, HX-40ES, HX-40S, HX-60-EHL, HX-E, HX-ES...(Otros modelos se puede ver en la tienda web)		



1

código	520574	referencia	00-324510-327
descripción	abrazadera de tubo ø 32mm espesor de hilo 3mm UE 1 pzs		
Para modelos:	AMX, AMX-900, AMX-E, AMX-ER, AMX-R, AMXR-900, AMXS-900, AMXX-1300, AMXXR-1300, AMXXS-1300, AMXXT, AUX, AUX-E, AUX-ER, AUX-R, AUXX-1300, AUXXL, AUXXR-1300, AUXXS-1300, AUXXT, ECOMAX-502, ECOMAX-650, ECOMAX-700, FE, FP, FX, FX-McDonalds, GP, GX, UX, UXD-30, UXL, UXLS, UXS, UXT, UXTL, UXTLH, UXTLHS, UXTLS, UXTL, UXTLH, UXTLHS, UXTLS, UXTS		



1

código	513268	referencia	00-303340-008 00-324510-068 139321-580 303340-8 324510-68
descripción	abrazadera de tubo ø 8-10mm espesor de hilo 1mm UE 1 pzs		
Para modelos:	AM-10, AM-11, AM-141, AM-700, AM900, AM900-10N, AM900-90, AMS900, AMS900-10N, AMX, AMX-10HL, AMX-90, AMX-900, AMXR, AMXR-900, AMXS, AMXS-900, AMXT, AMXTS, AMXX, AMXX-1300, AMXXR, AMXXR-1300, AMXXS, AMXXS-1300, AMXXT, AUP, AUP-90, AUPS, AUX, AUX-1300, AUXXL, AUXXL-11N, AUXXLS-11N, AUXXR, AUXXR-1300, AUXXS, AUXXS-1300, AUXXT, AUXXTS, CHF45, ECOMAX-600, ECOMAX-602-10, ECOMAX-602-11, ECOMAX-602S-11, ECOMAX-612-10, ECOMAX-612S-10, ECOMAX-650, ECOMAX-700, EF-40...(Otros modelos se puede ver en la tienda web)		

abrazaderas de alambre doble con tornillo



1

código	505281	referencia	00-323945-015 323945-15
descripción	abrazadera de tubo ø 15mm acero zincado UE 20 pzs		
Para modelos:	AM-10, AM-11, AM-141, AM-700, AM900, AM900-10N, AM900-90, AMS900, AMS900-10N, AMX, AMX-10HL, AMX-90, AMX-900, AMXR, AMXR-900, AMXS, AMXS-900, AMXT, AMXTS, AMXX, AMXX-1300, AMXXR, AMXXR-1300, AMXXS, AMXXS-1300, AMXXT, AUP, AUP-90, AUPS, AUX, AUX-1300, AUXXL, AUXXL-11N, AUXXLS-11N, AUXXR, AUXXR-1300, AUXXS, AUXXS-1300, AUXXT, AUXXTS, ECOMAX-402, ECOMAX-502, ECOMAX-600, ECOMAX-602-10, ECOMAX-602-11, ECOMAX-602S-11, ECOMAX-612-10, ECOMAX-612S-10, FP, FX...(Otros modelos se puede ver en la tienda web)		



1

código	505282	referencia	00-323945-016 323945-16
descripción	abrazadera de tubo ø 16mm acero zincado UE 20 pzs		
Para modelos:	AM-700, AM900, AMS900, AMX, AMX-900, AMX-E, AMX-ER, AMX-R, AMXR-900, AMXS-900, AMXX-1300, AMXXR-1300, AMXXS-1300, AMXXT, AUX, AUX-E, AUX-ER, AUX-R, AUXX-1300, AUXXL, AUXXR-1300, AUXXS-1300, AUXXT, ECOMAX-402, ECOMAX-502, ECOMAX-600, ECOMAX-650, GC, UX, UXL, UXLS, UXS, UXT, UXTL, UXTLH, UXTLHS, UXTLS, UXTL, UXTLH, UXTLHS, UXTLS, UXTS		



1

código	505283	referencia	00-323945-018 323945-18
descripción	abrazadera de tubo \varnothing 18mm acero zincado UE 20 pzs		
Para modelos:	AM-10, AM-11, AM-141, AM-700, AM900, AM900-10N, AM900-90, AMS900, AMS900-10N, AMX, AMX-10HL, AMX-90, AMX-900, AMX-E, AMX-ER, AMXR, AMX-R, AMXR-900, AMXS, AMXS-900, AMXT, AMXTS, AMXX, AMXX-1300, AMXXR, AMXXR-1300, AMXXS, AMXXS-1300, AMXXT, AUP, AUP-90, AUPS, AUX, AUX-E, AUX-ER, AUX-R, AUXX, AUXX-1300, AUXXL-11N, AUXXLS-11N, AUXXR, AUXXR-1300, AUXXS, AUXXS-1300, AUXXT, AUXXTS, ECOMAX-402, ECOMAX-502, ECOMAX-600, ECOMAX-602-10...(Otros modelos se puede ver en la tienda web)		



1

código	505286	referencia	00-323945-029 323945-29
descripción	abrazadera de tubo \varnothing 29mm acero zincado UE 20 pzs		
Para modelos:	AM900-10N, AM900-90, AMS900-10N, AMX, AMX-10HL, AMX-90, AMX-E, AMX-ER, AMXR, AMX-R, AMXS, AMXT, AMXTS, AMXX, AMXX-1300, AMXXR, AMXXR-1300, AMXXS, AMXXS-1300, AMXXT, AUP, AUP-90, AUPS, AUX, AUX-E, AUX-ER, AUX-R, AUXX, AUXX-1300, AUXXL, AUXXL-11N, AUXXLS-11N, AUXXR, AUXXR-1300, AUXXS, AUXXS-1300, AUXXT, AUXXTS, CR, CR-F, ECOMAX-602-11, ECOMAX-602S-11, ECOMAX-612-10, ECOMAX-612S-10, ECOMAX-700, FE, GC, GC11, GC12, GC31...(Otros modelos se puede ver en la tienda web)		



1

código	505284	referencia	00-323945-019 00-323945-021 323945-19 -alt- 323945-21
descripción	abrazadera de tubo \varnothing 21mm acero zincado UE 20 pzs		
Para modelos:	AM-10, AM-11, AM-141, AM-700, AM900-10N, AM900-90, AMS900-10N, AMX, AMX-10HL, AMX-90, AMX-E, AMX-ER, AMXR, AMX-R, AMXS, AMXT, AMXTS, AMXX, AMXX-1300, AMXXR, AMXXR-1300, AMXXS, AMXXS-1300, AMXXT, AUP, AUP-90, AUPS, AUX, AUX-E, AUX-ER, AUX-R, AUXX, AUXX-1300, AUXXL, AUXXL-11N, AUXXLS-11N, AUXXR, AUXXR-1300, AUXXS, AUXXS-1300, AUXXT, AUXXTS, ECOMAX-402, ECOMAX-502, ECOMAX-600, ECOMAX-602-10, ECOMAX-602-11, ECOMAX-602S-11, ECOMAX-612-10, ECOMAX-612S-10...(Otros modelos se puede ver en la tienda web)		



1

código	505287	referencia	00-323945-033 323945-33
descripción	abrazadera de tubo \varnothing 33mm acero zincado UE 20 pzs		
Para modelos:	AM-700, AM900, AM900-10N, AM900-90, AMS900, AMS900-10N, AMX, AMX-10HL, AMX-90, AMX-900, AMXR, AMXR-900, AMXS, AMXS-900, AMXX, AMXXR, AMXXS, AUP, AUP-90, AUPS, AUXX, AUXXL-11N, AUXXLS-11N, AUXXR, AUXXS, CN-Protronic, CN-Smarttronic, CP-Protronic, CR-F, ECOMAX-402, ECOMAX-502, ECOMAX-600, ECOMAX-602-11, ECOMAX-612-10, ECOMAX-612S-10, ECOMAX-650, ECOMAX-700, FX, GC31, GC32, GC41, GC42, GX		



1

código	505285	referencia	00-323945-025 323945-25
descripción	abrazadera de tubo \varnothing 25mm acero zincado UE 20 pzs		
Para modelos:	AM-10, AM-11, AM-141, AM-700, AM900, AM900-10N, AM900-90, AMS900, AMS900-10N, AMX, AMX-10HL, AMX-90, AMX-900, AMX-E, AMX-ER, AMXR, AMX-R, AMXR-900, AMXS, AMXS-900, AMXT, AMXTS, AMXX, AMXX-1300, AMXXR, AMXXR-1300, AMXXS, AMXXS-1300, AMXXT, AUP, AUP-90, AUPS, AUX, AUX-E, AUX-ER, AUX-R, AUXX, AUXX-1300, AUXXL, AUXXL-11N, AUXXLS-11N, AUXXR, AUXXR-1300, AUXXS, AUXXS-1300, AUXXT, AUXXTS, ECOMAX-402, ECOMAX-502, ECOMAX-600...(Otros modelos se puede ver en la tienda web)		



1

código	505293	referencia	00-323945-035 323945-35
descripción	abrazadera de tubo \varnothing 34-38mm acero zincado UE 20 pzs		
Para modelos:	AM900-10N, AM900-90, AMS900-10N, AMX, AMX-10HL, AMX-90, AMXR, AMXS, AMXT, AMXTS, AMXX, AMXXR, AMXXS, AUP, AUP-90, AUPS, AUXX, AUXXL-11N, AUXXLS-11N, AUXXR, AUXXS, AUXXT, AUXXTS, CR, CR-F, ECOMAX-402, ECOMAX-502, ECOMAX-602-11, ECOMAX-602S-11, ECOMAX-612-10, ECOMAX-612S-10, ECOMAX-650		



			
código	505290	referencia	00-323945-037 323945-37
descripción	abrazadera de tubo ø 37mm acero zincado UE 10 pzs		
Para modelos:	AM-700, AM900, AMS900, AMX-900, AMXR-900, AMXS-900, AMXT, AMXTS, AMXX-1300, AMXXR-1300, AMXXS-1300, AMXXT, AUXX-1300, AUXXL, AUXXR-1300, AUXXS-1300, AUXXT, AUXXTS, CR, ECOMAX-402, ECOMAX-502, ECOMAX-600, ECOMAX-700, FP, FX, FX-McDonalds, GC41, GC42, GP, GX, UX, UXL, UXLS, UXS, UXT, UXTH, UXTHL, UXTHLS, UXTHS, UXTL, UXTLH, UXTLHS, UXTLS, UXTS		

			
código	505292	referencia	00-323945-064 323945-64
descripción	abrazadera de tubo ø 64-68mm acero zincado UE 10 pzs		
Para modelos:	AM-10, AM-11, AM-141, AM900-10N, AM900-90, AMS900-10N, AMX, AMX-10HL, AMX-90, AMXR, AMXS, AMXT, AMXTS, AUXXT, AUXXTS, CN-Protronic, CN-Smartronic, CP-Protronic, CS-Easytronic, ECOMAX-602-10, ECOMAX-602-11, ECOMAX-602S-11, ECOMAX-612-10, ECOMAX-612S-10, ECOMAX-700, UX, UXL, UXLS, UXS, UXT, UXTL, UXTLS, UXTS		

			
código	505294	referencia	00-323945-053 323945-53
descripción	abrazadera de tubo ø 53mm acero zincado UE 10 pzs		
Para modelos:	CN-Protronic, CN-Smartronic, CP-Protronic, CSA, CS-Easytronic, ECOMAX-402, ECOMAX-502, FE, GC, GC11, GC12, GC31, GC32, GC41, GC42, HE, HE600-HL, HE-P, UX-30, UX-30B, UX-30E, UX-30EB, UX-30EH, UX-30ES, UX-30ESB, UX-30ESH, UX-30H, UX-30-McDonalds, UX-30S, UX-30SB, UX-30SH, UX-60, UX-60B, UX-60E, UX-60EB, UX-60EH, UX-60EHB, UX-60H, UX-60HB		

anillos truarc			
DIN 471			
			
código	507509	referencia	602302 RR-010-13 RR-10-13 RR-E-2-34
descripción	anillo truarc árbol ø 18mm espesor 1.2mm acero inoxidable DIN 471		
Para modelos:	103G, 203G, 2226, 303G, AM-12E, AM-12EC, AM-12EF, AM-12ER, AM15, AM15F, AM15T, AM-600, AM-600C, AM-600CR, AM-600R, C44A, C44AW, C54A, C64A, CS-2012E, CS-2022E, CSD-2012E, CSD-2022E, CX, FTT, FTX, FUX, ML-110025, ML-110976, ML-110977, ML-32614, ML-32615, UW-105, UW-135, UW-135H, UWX		

			
código	505291	referencia	00-323945-056 323945-56
descripción	abrazadera de tubo ø 56mm acero zincado UE 10 pzs		
Para modelos:	AM-700, AM900, AMS900, AMX-900, AMXR-900, AMXS-900, CR, ECOMAX-402, ECOMAX-502, ECOMAX-600, ECOMAX-650, FE, HE, HE600-HL, HE-P		

DIN 6799			
			
código	518557	referencia	602980
descripción	anillo truarc E D1 ø 5mm D2 ø 11mm inox DIN 6799 espesor 0.7mm		

			
código	505289	referencia	00-323945-060 323945-60
descripción	abrazadera de tubo ø 60mm acero zincado UE 10 pzs		
Para modelos:	AM-10, AM-11, AM-141, AM900-10N, AM900-90, AMS900-10N, AMX, AMX-10HL, AMX-90, AMXR, AMXS, AMXT, AMXTS, AMXX, AMXXR, AMXXS, AUP, AUP-90, AUPS, AUXX, AUXXL-11N, AUXXL-11N, AUXXR, AUXXS, AUXXT, AUXXTS, CSA, ECOMAX-602-10, ECOMAX-602-11, ECOMAX-602S-11, ECOMAX-612-10, ECOMAX-612S-10		

DIN 7993			
			
código	697871	referencia	602309 RR-E-2-38
descripción	anillo truarc A D1 ø 14mm D2 ø 12.8mm acero para muelle DIN 7993 espesor 1mm		
Para modelos:	AM-12E, AM-12EC, AM-12EF, AM-12ER, AM-600, AM-600C, AM-600CR, AM-600R, FM-400H, FM-400U, FM-500, FM-500H, UW-105, UW-120, UW-125, UW-135, UW-135H, UW-200, UW-205, UW-55		



chavetas



1

código	694269	referencia	602886
descripción	chaveta ø 2.7mm L 18mm		
Para modelos:	FTX, FUX, UW-105, UW-125, UW-205		

consumibles

fusibles

fusibles finos



1

código	358666	referencia	926283 E926283
descripción	fusible fino medida ø5x20mm 0.315A rápido nominal 250V UE 10 pzs		



1

código	358606	referencia	228010 E228010
descripción	fusible fino medida ø5x20mm 4A retardado nominal 250V UE 10 pzs		

ø6,3x32mm 500V



1

código	358742	referencia	775570-2
descripción	fusible fino medida ø6,3x32mm 0.8A rápido nominal 500V UE 10 pzs		



1

código	358751	referencia	00-775570-001 775570-1
descripción	fusible fino medida ø6,3x32mm 6.3A rápido nominal 500V UE 10 pzs		
Para modelos:	AMX-900, AMXS-900, AMXX-1300, AMXXT, AUXX-1300, AUXXT, ECO-MAX-650, UX, UXL, UMLS, UXS, UXT, UXTH, UXTHL, UXTHLS, UXTHS, UXTL, UXTLS, UXTS		

A			
abrazaderas	89, 94		
abrazaderas de alambre doble	89, 94		
abrazaderas de alambre doble con tornillo	89, 94		
abrazaderas de tubo	89, 94		
accesorios eléctricos	42		
anillos de junta	73		
anillos truarc	96		
aparatos de mando y aviso	15		
arandelas	93		
arandelas elásticas	93		
B			
bombas	31		
bombas de aumento de presión I	38		
bombas de aumento de presión II	40		
bombas de lavado y aclarado	31		
bombas de salida	38		
bombillas incandescentes	17		
C			
cables	42		
cables de cinta plana	42		
cajas de control	42		
caños de pared	83		
chavetas	97		
cierres de enganche	68		
componentes para el circuito agua	88		
condensadores de servicio	40		
condensadores y filtros antiparasitarios	40		
conmutadores de levas	12		
conmutadores giratorios	12		
consumibles	97		
contactores	17		
D			
descalcificadores	88		
dosificadores	79		
E			
electródos	30		
empalmes de tubo	88		
F			
filtros	41		
filtros de entrada	88, 88		
filtros de recipientes	82		
fusibles	41, 97		
fusibles finos	97		
I			
interruptores de flotador	12		
		interruptores de sistema ROLD	11
		interruptores magnéticos	13
		interruptores posicionales	11
		interruptores y pulsadores	10
		interruptores/pulsadores basculantes	10
J			
		juntas de puerta para lavavajillas	75
		juntas para puertas	69
		juntas térmicas	69
		juntas tóricas	69
L			
		lámparas	16
		lámparas de señalización	16
M			
		material de sujeción	91
		microinterruptores	10
		motores para bombas de lavado	37
P			
		pasacables	42, 42
		presostatos	28
R			
		racores para cables	42
		relés	19
		relés de temporización	19
		resistencias	2
		resistencias de inmersión	2
		resistencias planas	8
S			
		sensores	20
		sistemas de medición	91
		sujeciones	94
T			
		temporizadores	17
		temporizadores de programa	17
		temporizadores eléctricos	17
		terminales	42
		termostatos	9
		termostatos de regulación	9
		termostatos de seguridad	9
		termostatos de superficie	9, 9
		termostatos de superficie de seguridad	9
		tornillos	91
		tornillos de cabeza avellanada	91
		tornillos de cabeza moleteada	92
		tornillos de cabeza plana	92
		tornillos prisioneros	92

tubos de salida	84
tubos de silicona	86
tubos flexibles	83
tubos flexibles de entrada	83
tubos flexibles de entrada de PVC	83
tubos flexibles de PVC	85
tubos flexibles industriales	85
tubos flexibles inoxidables	83
tubos flexibles universales	83
tubos formados	86
tuercas	92
tuercas hexagonales	92, 92
tuercas moleteadas	92

V

válvulas de flotador	88
válvulas magnéticas	24
válvulas y caños de pared	88
ventilador axial	30
ventiladores	30