

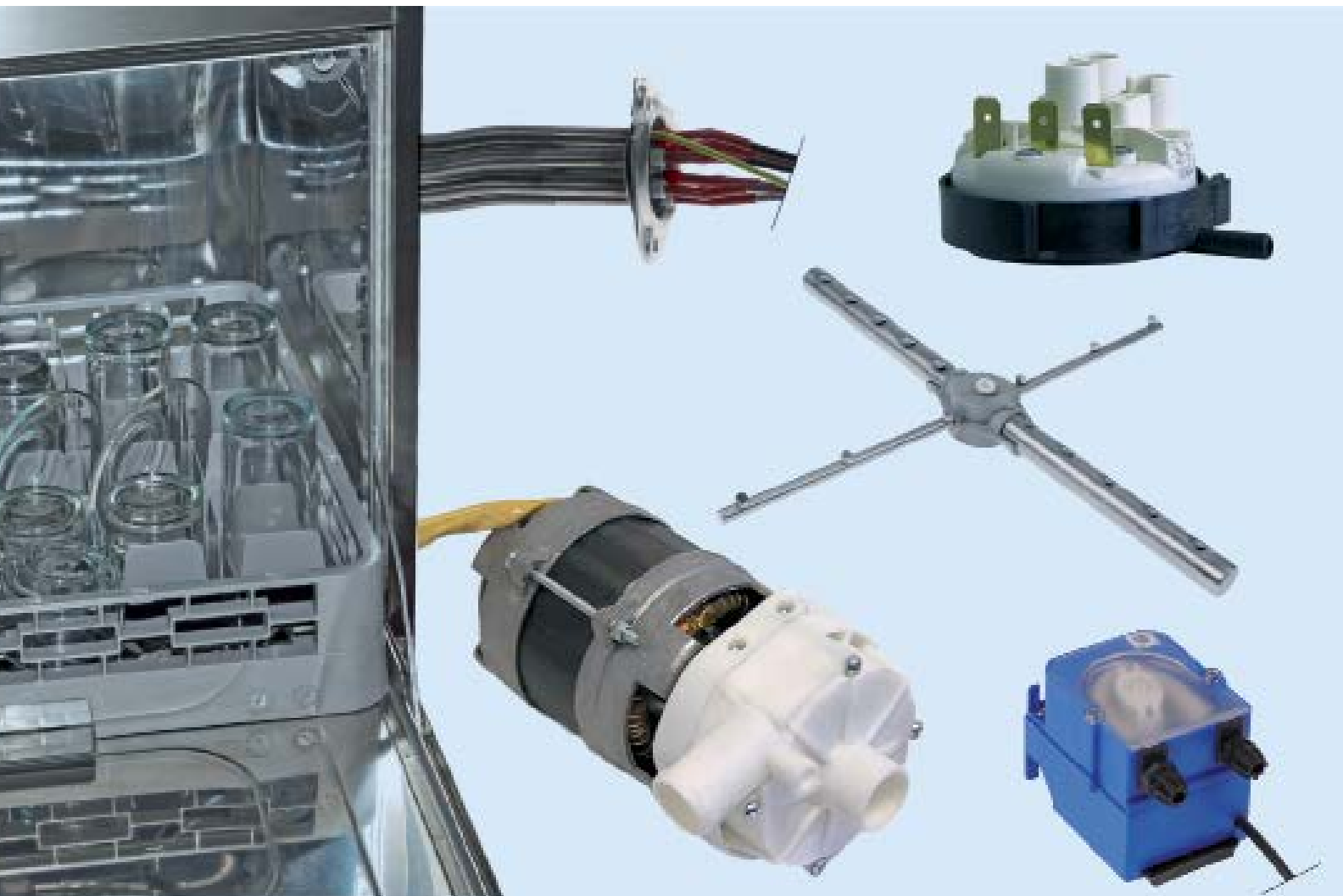

Reparatie-onderdelen voor
Vaatwas



Reparatie-onderdelen passend voor

HOBART

2018

Het complete assortiment vindt u altijd up-to-date in onze webshop



verwarmingselementen

elementen voor vaatwassers (droog)



	bestelnr. 420180	fabrikantnr. 229189-26
omschrijving verwarmingselement 1220W 254V VC 1 L 425mm B 65mm pijp ø 8.4mm aansluiting M4 droog verwarmingselement flensaansluiting flens L 81mm flens B 28mm gat ø 6.6mm		



	bestelnr. 420179	fabrikantnr. 229189-22
omschrijving verwarmingselement 1830W 254V VC 1 L 425mm B 65mm pijp ø 8.4mm aansluiting M4 droog verwarmingselement flensaansluiting flens L 81mm flens B 28mm gat ø 6.6mm		
Voor modellen: CR-F		

	bestelnr. 420178	fabrikantnr. 229189-23
omschrijving verwarmingselement 2440W 254V VC 1 L 425mm B 65mm pijp ø 8.4mm aansluiting M4 droog verwarmingselement flensaansluiting flens L 81mm flens B 28mm gat ø 6.6mm		
Voor modellen: FTX		

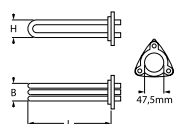
dompelelementen

3-gatsflens ø47,5mm

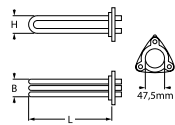
		bestelnr. 420302	fabrikantnr. 01-240761-001 01-240761-002 01-240761-1 240761-2
omschrijving verwarmingselement 6000W 240V inbouw ø 47.5mm VC 3 L 325mm B 33mm H 37mm aantal thermostaathulzen 1 thermostaathuls ø 5mm thermostaathuls lengte 140mm thermostaathuls midden, niet-aangrenzend pijp ø 8.3mm LA 62mm gat ø 10mm aansluiting vlaksteker 6,3mm 3-gatsflens dompel verwarmingselement			
Voor modellen: AM-10, AM-11, AM-141, ECOMAX-402, ECOMAX-502, ECOMAX-602-10			
Toebehoren voor 420302			
	bestelnr. 521030	fabrikantnr. 01-240135-011 01-240135-11 1-240135-11 240135-11	
O-ring Viton materiaaldikte 5.34mm ID ø 47mm vpe 1stuk			

		bestelnr. 416240	fabrikantnr. 139321-1031
omschrijving verwarmingselement 6545W 230/400V inbouw ø 48mm VC 3 L 355mm B 31mm H 37mm aantal thermostaathulzen 1 thermostaathuls ø 7mm themostaathuls lengte 175mm thermostaathuls boven midden niet-aangrenzend pijp ø 6.5mm LA 63mm gat ø 10mm aansluiting M4 3-gatsflens dompel verwarmingselement			
Toebehoren voor 416240			
	bestelnr. 510408	fabrikantnr. —	
O-ring EPDM materiaaldikte 5.34mm ID ø 47mm vpe 1stuk			
	bestelnr. 510562	fabrikantnr. —	
O-ring silicone materiaaldikte 5.34mm ID ø 47mm vpe 1stuk			

		bestelnr. 419005	fabrikantnr. 01-240135-002 01-240135-2 02-240135-001
omschrijving verwarmingselement 7260W 250V inbouw ø 47.5mm VC 3 L 375mm B 31mm H 35mm aantal thermostaathulzen 1 thermostaathuls ø 5mm themostaathuls lengte 220mm thermostaathuls midden, niet-aangrenzend pijp ø 8.5mm aansluiting vlaksteker 6,3mm 3-gatsflens dompel verwarmingselement			
Voor modellen: AM900-10N, AM900-90, AMS900-10N, AMX, AMX-10HL, AMX-90, AMXR, AMXS, AMXT, AMXTS, AMXX, AMXXR, AMXXS, AUP, AUP-90, AUPS, AUXX, AUXXL-11N, AUXXLS-11N, AUXXR, AUXXS, AUXXT, AUXXTS, ECOMAX-602-11, ECOMAX-602S-11, ECOMAX-612-10, ECOMAX-612S-10, FP, FX, FX-McDonalds, GP, GX			
Toebehoren voor 419005			
	bestelnr. 510408	fabrikantnr. —	
O-ring EPDM materiaaldikte 5.34mm ID ø 47mm vpe 1stuk			



1			
bestelnr.	415668	fabrikantnr.	139221-246 139321-246 371450-13
omschrijving	verwarmingselement 2625W 230V inbouw ø 47.5mm VC 1 L 190mm B 41mm H 54mm aantal thermostaathulzen 1 thermostaathuls ø 7mm themostaathuls lengte 170mm thermostaathuls buitenmidden, niet aanliggend pijp ø 6.3mm LA 62mm gat ø 8mm aansluiting M4 3-gatsflens dompel verwarmingselement		
Voor modellen:	GE-400, GF-60, GF-60S, GW-600, GW-600S, GW-601, GW-601S		
Reparatie-onderdelen voor	415668		
		bestelnr.	510408 fabrikantnr. —
	O-ring EPDM materiaaldikte 5.34mm ID ø 47mm vpe 1stuk		
Toebehoren voor	415668		
		bestelnr.	510562 fabrikantnr. —
	O-ring silicone materiaaldikte 5.34mm ID ø 47mm vpe 1stuk		

met drukflens 50 x 26mm

groep 1

1			
bestelnr.	420462	fabrikantnr.	01-240247-001 01-240247-1 01-515292-001 01-515292-1 01-515292-101
omschrijving	service kit 975W 250V flens 26,5x50mm L 168mm B 32mm VC 1 pijp ø 8.5mm H 35mm incl. toebehoren		
Voor modellen:	FP, FX, FX-McDonalds, GP, GX		

1			
bestelnr.	420071	fabrikantnr.	01-240766-001 01-240766-1 01-240766-101
omschrijving	verwarmingselement 2000W 240V VC 1 flens 50x26mm L 320mm B 36mm Hmm drukflens aansluiting vlakstekker 6,3mm pijp ø 8.6mm dompel verwarmingselement		
Voor modellen:	ECOMAX-402, ECOMAX-502		
Toebehoren voor	420071		
		bestelnr.	510387 fabrikantnr. —
	pakking L 46mm B 22mm ømm EPDM voor verwarmingselement voor flens 50x26mm		

1			
bestelnr.	416292	fabrikantnr.	324187-2
omschrijving	verwarmingselement 2700W 230V VC 1 flens 50x26mm L 380mm B 105mm L1 60mm L2 45mm L3 275mm M5 aansluiting vlakstekker 6,3mm pijp ø 8.5mm dompel verwarmingselement		
Voor modellen:	FE-W, FX, GX		
Toebehoren voor	416292		
		bestelnr.	510387 fabrikantnr. —
	pakking L 46mm B 22mm ømm EPDM voor verwarmingselement voor flens 50x26mm		
		bestelnr.	510388 fabrikantnr. —
	tegenflens ømm LAmn gaten ømm L 43mm B 21mm RVS voor verwarmingselement voor flens 50x26mm		

1			
bestelnr.	417517	fabrikantnr.	00-883423-001 883423-1
omschrijving	verwarmingselement 3000W 254V VC 1 flens 50x26mm L 420mm B 70mm L1 58mm L2 70mm L3 320mm drukflens aansluiting vlakstekker 6,3mm horizontaal pijp ø 8.5mm dompel verwarmingselement		
Voor modellen:	AM-10, AM-11, AM-141, AM900-10N, AM900-90, AMS900-10N, AMX, AMX-10HL, AMX-90, AMXR, AMXS, AMXT, AMXTS, AMXX, AMXXR, AMXXS, AUP, AUP-90, AUPS, AUXX, AUXXL-11N, AUXXLS-11N, AUXXR, AUXXS, AUXXT, AUXXTS, ECOMAX-602-10, ECOMAX-602-11, ECOMAX-602S-11, ECOMAX-612-10, ECOMAX-612S-10		

1			
bestelnr.	416293	fabrikantnr.	00-231982-009 231982-9
omschrijving	verwarmingselement 610W 254V VC 1 flens 50x26mm L 370mm B 120mm L1 40mm L2 70mm L3 260mm drukflens aansluiting 6.5 pijp ø 8.5mm dompel verwarmingselement		
Voor modellen:	AMX, AMX-E, AMX-ER, AMX-R, AUX, AUX_, AUX-E, AUX-ER, AUX-R, FE, FX, GX, HE, HE600-HL, HE-P, HX, HX-30, HX-30E, HX-30ES, HX-30S, HX-40, HX-40E, HX-40ES, HX-40S, HX-60-EHL, HX-E, HX-ES, HX-S, UXD-30		
Toebehoren voor	416293		
		bestelnr.	510387 fabrikantnr. —
	pakking L 46mm B 22mm ømm EPDM voor verwarmingselement voor flens 50x26mm		
		bestelnr.	510388 fabrikantnr. —
	tegenflens ømm LAmn gaten ømm L 43mm B 21mm RVS voor verwarmingselement voor flens 50x26mm		



1

bestelnr.	416294	fabrikantnr.	231982-10
omschrijving	verwarmingselement 610W 440V VC 1 flens 50x26mm L 365mm B 120mm L1 35mm L2 60mm L3 270mm drukflens aansluiting vlaksteker 6,3mm pijp ø 8.5mm dompel verwarmingselement		
Voor modellen:	AMX, AMX-E, AMX-ER, AMX-R, AUX, AUX_, AUX-E, AUX-ER, AUX-R, FX, GX, HX, HX-30, HX-30E, HX-30ES, HX-30S, HX-40, HX-40E, HX-40ES, HX-40S, HX-E, HX-ES, HX-S		
Toebehoren voor	416294		
	bestelnr.	510387	fabrikantnr. —
	pakking L 46mm B 22mm ømm EPDM voor verwarmingselement voor flens 50x26mm		
	bestelnr.	510388	fabrikantnr. —
	tegenflens ømm Lamm gaten ømm L 43mm B 21mm RVS voor verwarmingselement voor flens 50x26mm		

1

bestelnr.	420538	fabrikantnr.	E230102
omschrijving	verwarmingselement 1600W 230V VC 1 flens 50x26mm L 305mm B 47mm H 25mm pijp ø 8.5mm aansluiting F6,3		

1

bestelnr.	416234	fabrikantnr.	139321-719
omschrijving	verwarmingselement 600W 230V VC 1 flens 50x26mm L 160mm B 45mm H 27mm pijp ø 8.8mm aansluiting vlaksteker 6,3mm aansluitingslengte 40mm dompel verwarmingselement drukflens		
Voor modellen:	CLG-25		
Toebehoren voor	416234		
	bestelnr.	510387	fabrikantnr. —
	pakking L 46mm B 22mm ømm EPDM voor verwarmingselement voor flens 50x26mm		
	bestelnr.	510388	fabrikantnr. —
	tegenflens ømm Lamm gaten ømm L 43mm B 21mm RVS voor verwarmingselement voor flens 50x26mm		

met expansieflens 40 x 16mm

1

bestelnr.	416283	fabrikantnr.	324646-1
omschrijving	verwarmingselement 1830W 254V flens 40x16mm L 385mm B 36mm aansluiting vlaksteker 6,3mm VC 1 pijp ø 8.5mm dompel verwarmingselement expansieflens		
Voor modellen:	FE, FE-W, FX, GX, HE, HE600-HL, HE-P, HX-60-EHL		

1

bestelnr.	420353	fabrikantnr.	227953-1
omschrijving	verwarmingselement 2000W 220V flens 40x16mm L 335mm B 39mm aansluiting vlaksteker 6,3mm VC 1 pijp ø 8.4mm dompel verwarmingselement drukflens bevestigingsafstand 24mm		
Voor modellen:	CM1E, FM-30, FM-30U, FM-400H, FM-400U, FM-500, FM-500H, UW-55, WM2E		

1

bestelnr.	416284	fabrikantnr.	324646-2
omschrijving	verwarmingselement 2440W 254V flens 40x16mm L 402mm B 34mm aansluiting vlaksteker 6,3mm VC 1 pijp ø 8.5mm dompel verwarmingselement expansieflens		
Voor modellen:	FE, FE-W, FX, GX, HE, HE600-HL, HE-P, HX-60-EHL		

1

bestelnr.	416388	fabrikantnr.	324646-4 D324646-4
omschrijving	verwarmingselement 3000W 230V flens 40x16mm L 410mm B 33mm aansluiting vlaksteker 6,3mm VC 1 pijp ø 8.5mm dompel verwarmingselement expansieflens		
Voor modellen:	FE, FE-W, FX, GX, HE, HE600-HL, HE-P, HX-60-EHL		
Reparatie-onderdelen voor	416388		
	bestelnr.	416464	fabrikantnr. —
	verwarmingselement 2000W 230V L 600mm B 572mm draad 1/4" bevestigingsafstand 563mm aansluitingslengte 45mm pijp ø 8.6mm kabelslengte 643mm VC 1 droog verwarmingselement 2-gatsbevestiging		



bestelnr.	416285	fabrikantnr.	324646-3
omschrijving	verwarmingselement 3050W 254V flens 40x16mm L 400mm B 36mm aansluiting vlaksteker 6,3mm VC 1 pijp ø 8.5mm dompel verwarmingselement expansieflens met temperatuurbeveiliging		
Voor modellen:	FE, FE-W, FX, GX, HE, HE600-HL, HE-P, HX-60-EHL		

met expansieflens 70 x 18mm			
bestelnr.	416287	fabrikantnr.	324644-2
omschrijving	verwarmingselement 2000W 230V VC 1 flens 70x18mm L 388mm B 64mm aansluiting vlaksteker 6,3mm pijp ø 8.5mm dompel verwarmingselement expansieflens		
Voor modellen:	AM-700, CR-F, ECOMAX-600, ECW, UX, UX-30, UX-30B, UX-30E, UX-30EB, UX-30EH, UX-30ES, UX-30ESB, UX-30ESH, UX-30H, UX-30-McDonalds, UX-30S, UX-30SB, UX-30SH, UX-60, UX-60B, UX-60E, UX-60EB, UX-60EH, UX-60EHB, UX-60H, UX-60HB, UXL, UXLS, UXS		

bestelnr.	416239	fabrikantnr.	230100
omschrijving	verwarmingselement 2600W 230V VC 1 flens 70x18mm L 270mm B 65mm aansluiting vlaksteker 6,3mm pijp ø 8.5mm dompel verwarmingselement expansieflens		
Voor modellen:	ECOMAX-400-12, ECOMAX-400S-12		

bestelnr.	416286	fabrikantnr.	324644-1
omschrijving	verwarmingselement 3000W 230V VC 1 flens 70x18mm L 408mm B 65mm aansluiting vlaksteker 6,3mm pijp ø 8.5mm dompel verwarmingselement expansieflens aansluitingslengte 18mm		
Voor modellen:	AMX, AMX-E, AMX-ER, AMX-R, AUX, AUX-E, AUX-ER, AUX-R, CR-F, ECOMAX-700, ECW, UX, UX-30, UX-30B, UX-30E, UX-30EB, UX-30EH, UX-30ES, UX-30ESB, UX-30ESH, UX-30H, UX-30-McDonalds, UX-30S, UX-30SB, UX-30SH, UX-60, UX-60B, UX-60E, UX-60EB, UX-60EH, UX-60EHB, UX-60H, UX-60HB, UXL, UXLS, UXS, UXT, UXTH, UXTHL, UXTHLS, UXTHS, UXTL, UXTLH, UXTLHS, UXTLS, UXTS		

bestelnr.	419162	fabrikantnr.	775464-002 775464-2
omschrijving	verwarmingselement 3000W 240V VC 1 flens 70x18mm L 318mm B 65mm aansluiting vlaksteker 6,3mm pijp ø 8.5mm dompel verwarmingselement expansieflens aansluitingslengte 24mm TD ø 10mm met temperatuurvoeler		
Voor modellen:	AM900, AMS900, FX, GC, GC11, GC12, GC31, GC32, GC41, GC42, GX		
Reparatie-onderdelen voor	419162		
	bestelnr.	fabrikantnr.	402906
	 temperatuurvoeler NTC 10kOhm kabel voeler -40 tot +110°C aansluiting vlaksteker 4,8mm draad voeler ø10x30mm kabellengtem		

bestelnr.	416288	fabrikantnr.	00-324637-002 324637-... 324637-2
omschrijving	verwarmingselement 4000W 230V VC 2 flens 70x18mm L 410mm B 63mm aansluiting F2,8mm / F6,3mm pijp ø 8.5mm dompel verwarmingselement expansieflens aansluitingslengte 30mm		
Voor modellen:	CR-F, UX-30, UX-30B, UX-30E, UX-30EB, UX-30ES, UX-30ESB, UX-30S, UX-30SB, UX-60, UX-60B, UX-60E, UX-60EB, UX-60EH, UX-60EHB, UX-60H, UX-60HB		

bestelnr.	416289	fabrikantnr.	00-324637-001 324637-... 324637-1
omschrijving	verwarmingselement 6000W 230V VC 2 flens 70x18mm L 417mm B 65mm aansluiting vlaksteker 6,3mm pijp ø 9mm dompel verwarmingselement expansieflens aansluitingslengte 35mm		
Voor modellen:	AMX, AMX-E, AMX-ER, AMX-R, AMXX-1300, AMXXT, AUX, AUX-E, AUX-ER, AUX-R, AUXX-1300, AUXXL, AUXXT, CR-F, ECW, UX-60, UX-60B, UX-60E, UX-60EB, UX-60EH, UX-60EHB, UX-60H, UX-60HB, UXT, UXTH, UXTHL, UXTHLS, UXTHS, UXTL, UXTLH, UXTLHS, UXTLS, UXTS		

bestelnr.	419139	fabrikantnr.	775464-1
omschrijving	verwarmingselement 6000W 240V VC 2 flens 70x18mm L 315mm B 62mm aansluiting vlaksteker 6,3mm pijp ø 8.5mm		
Voor modellen:	AM900, AMS900, FX, GC, GC11, GC12, GC31, GC32, GC41, GC42, GX		

bestelnr.	419026	fabrikantnr.	324637-... 324637-3
omschrijving	verwarmingselement 6100W 254V VC 2 flens 70x18mm L 420mm B 63mm aansluiting F6,3 pijp ø 8.5mm dompel verwarmingselement expansieflens aansluitingslengte 30mm		
Voor modellen:	AM-700, AMX-900, AMXR-900, AMXS-900, AMXX-1300, AMXXR-1300, AMXXS-1300, AMXXT, AUXX-1300, AUXXL, AUXXR-1300, AUXXS-1300, AUXXT, CN, CNA, CNB, CNR, CR, CR-F, CSA, ECOMAX-600, ECOMAX-650, ECOMAX-800, ECW, FTN, FTX, UX-30, UX-30B, UX-30E, UX-30EB, UX-30ES, UX-30ESB, UX-30S, UX-30SB, UX-60, UX-60B, UX-60E, UX-60EB, UX-60EH, UX-60EHB, UX-60H, UX-60HB		

bestelnr.	416243	fabrikantnr.	139321-463
omschrijving	verwarmingselement 7600W 230V VC 3 flens 70x18mm L 390mm B 60mm H 13mm aansluiting vlaksteker 6,3mm pijp ø 6.3mm dompel verwarmingselement expansieflens INCOLOY-800		
Voor modellen:	CHF45, EF-40		



met ronde flens ø47.5mm



bestelnr.	416295	fabrikantnr.	226807-1
omschrijving	verwarmingselement 3000W 230V VC 3 inbouw ø 47.5mm L 185mm B 79mm H 30mm L1 35mm L2 150mm B1 23mm B2 34mm rondflens aansluiting vlaksteker 6,3mm dompel verwarmingselement pijp ø 6.5mm		
Voor modellen:	AM-12E, AM-12EC, AM-12EF, AM-12ER, AM-600, AM-600C, AM-600CR, AM-600R, UW-100, UW-105		
Toebehoren voor	416295		
	bestelnr.	510408	fabrikantnr. —
	O-ring EPDM materiaaldikte 5.34mm ID ø 47mm vpe 1stuk		
	bestelnr.	510562	fabrikantnr. —
	O-ring silicone materiaaldikte 5.34mm ID ø 47mm vpe 1stuk		
	bestelnr.	550002	fabrikantnr. —
	spanbeugel H 10mm L 21mm B 10mm gat ø 6.5mm voor verwarmingselement		



bestelnr.	416296	fabrikantnr.	170495-2
omschrijving	verwarmingselement 6000W 230V VC 3 inbouw ø 47.5mm L 230mm B 128mm H 32mm L1 30mm L2 200mm B1 46mm B2 34mm rondflens aansluiting vlaksteker 6,3mm dompel verwarmingselement pijp ø 6.3mm		
Voor modellen:	AM-12E, AM-12EC, AM-12EF, AM-12ER, AM-600, AM-600C, AM-600CR, AM-600R, UW-105		
Toebehoren voor	416296		
	bestelnr.	510408	fabrikantnr. —
	O-ring EPDM materiaaldikte 5.34mm ID ø 47mm vpe 1stuk		
	bestelnr.	510562	fabrikantnr. —
	O-ring silicone materiaaldikte 5.34mm ID ø 47mm vpe 1stuk		
	bestelnr.	550002	fabrikantnr. —
	spanbeugel H 10mm L 21mm B 10mm gat ø 6.5mm voor verwarmingselement		





bestelnr.	416297	fabrikantnr.	173649-1 173649-2
omschrijving	verwarmingselement 7500W 230V VC 3 inbouw ø 47.5mm L 230mm B 123mm H 31mm L1 32mm L2 198mm B1 45mm B2 35mm rondflens aansluiting vlaksteker 6,3mm dompel verwarmingselement pijp ø 6.5mm		
Voor modellen:	AM-600, AM-600C, AM-600CR, AM-600R, UW-105		
Toebehoren voor	416297		
	bestelnr.	510408	fabrikantnr. —
	O-ring EPDM materiaaldikte 5.34mm ID ø 47mm vpe 1stuk		
	bestelnr.	510562	fabrikantnr. —
	O-ring silicone materiaaldikte 5.34mm ID ø 47mm vpe 1stuk		

Toebehoren voor	416297		
	bestelnr.	550002	fabrikantnr. —
	spanbeugel H 10mm L 21mm B 10mm gat ø 6.5mm voor verwarmingselement		



bestelnr.	416298	fabrikantnr.	226506-1 226506-2
omschrijving	verwarmingselement 9000W 230V VC 3 inbouw ø 47.5mm L 230mm B 120mm H 34mm L1 25mm L2 205mm B1 42mm B2 36mm rondflens aansluiting vlaksteker 6,3mm dompel verwarmingselement pijp ø 8.5mm aansluitingslengte 44mm		
Voor modellen:	AM-12E, AM-12EC, AM-12EF, AM-12ER, AM-600, AM-600C, AM-600CR, AM-600R, UW-100, UW-105, UW-135, UW-135H		
Toebehoren voor	416298		
	bestelnr.	510408	fabrikantnr. —
	O-ring EPDM materiaaldikte 5.34mm ID ø 47mm vpe 1stuk		
	bestelnr.	510562	fabrikantnr. —
	O-ring silicone materiaaldikte 5.34mm ID ø 47mm vpe 1stuk		
	bestelnr.	550002	fabrikantnr. —
	spanbeugel H 10mm L 21mm B 10mm gat ø 6.5mm voor verwarmingselement		

met ronde flens (overige)			
bestelnr.	419183	fabrikantnr.	323949-1
omschrijving	verwarmingselement 7320W 254V L 355mm B 35mm H 35mm VC 3 rondflens aansluiting F6,3 dompel verwarmingselement pijp ø 8.5mm		
Voor modellen:	EWB-S, UXT, UXTH, UXTHL, UXTHLS, UXTHS, UXTL, UXTLH, UXTLHS, UXTLS, UXTS		
Toebehoren voor	419183		
	bestelnr.	510409	fabrikantnr. 00-276903-053 00-67500-016 00-67500-118 276903-53 670500-118 67500-118 67500-16
	O-ring EPDM materiaaldikte 5.34mm ID ø 56.52mm vpe 1stuk		





			
bestelnr.	419103	fabrikantnr.	00-229148-001 229148-1 229148-1 (230V) 229148-2
omschrijving	verwarmingselement 9000W 240V L 520mm B 47mm H 41mm VC 3 flens ø 71mm bevestigingsdraad M10 aansluiting M4 pijp ø 8.5mm aansluitingslengte 21mm		
Voor modellen:	CR-F, CX, ECW, FTX, FUX, UW-135, UW-135H, UWX		
Toebehoren voor	419103		
			
bestelnr.	510409	fabrikantnr.	00-276903-053 00-67500-016 00-67500-118 276903-53 670500-118 67500-118 67500-16
O-ring EPDM materiaaldikte 5.34mm ID ø 56.52mm vpe 1stuk			

			
bestelnr.	416300	fabrikantnr.	324206-4
omschrijving	verwarmingselement 4500W 230V VC 3 L 413mm B 45mm H 45mm aantal thermostaathulzen 1 thermostaathuls ø 5mm thermostaathuls lengte 377mm pijp ø 8.5mm LA 45mm gat ø 10mm aansluiting M4 4-gatsflens dompel verwarmingselement flens B 63.5mm flens L 63.5mm		
Voor modellen:	FX, GX, HX, HX-30, HX-30E, HX-30ES, HX-30S, HX-40, HX-40E, HX-40ES, HX-40S, HX-E, HX-ES, HX-S		



			
bestelnr.	416290	fabrikantnr.	324206-5
omschrijving	verwarmingselement 7500W 230V VC 3 inbouw ø 47.5mm L 415mm B 44mm H 44mm aantal thermostaathulzen 1 thermostaathuls ø 5mm thermostaathuls lengte 369mm pijp ø 8.5mm LA 46mm gat ø 10mm aansluiting M4 4-gatsflens dompel verwarmingselement flens B 63.5mm flens L 63.5mm		
Voor modellen:	FX, GX, HX, HX-30, HX-30E, HX-30ES, HX-30S, HX-40, HX-40E, HX-40ES, HX-40S, HX-E, HX-ES, HX-S		
Toebehoren voor	416290		
			
bestelnr.	505180	fabrikantnr.	00-233982-001 00-276903-021 233982-1 276903-21
O-ring EPDM materiaaldikte 3.53mm ID ø 47.22mm vpe 1stuk			



speciale flensen

			
bestelnr.	420351	fabrikantnr.	166151-1 166151-2 38658-1
omschrijving	verwarmingselement 10000W 220/380V VC 3 L 360mm B 127mm flens L 90mm flens B 90mm aansluiting 4-gatsflens spoeltechniek pijp ø 8.5mm H 42mm		
Voor modellen:	UW-120, UW-200		

			
bestelnr.	505180	fabrikantnr.	00-233982-001 00-276903-021 233982-1 276903-21
O-ring EPDM materiaaldikte 3.53mm ID ø 47.22mm vpe 1stuk			

overigen

			
bestelnr.	416299	fabrikantnr.	324206-3 324206-6
omschrijving	verwarmingselement 2200W 230V VC 1 L 420mm B 45mm H 35mm aantal thermostaathulzen 1 thermostaathuls ø 5mm thermostaathuls lengte 365mm pijp ø 8.5mm LA 45mm gat ø 10mm aansluitingslengte 25mm 4-gatsflens dompel verwarmingselement flens B 63mm flens L 63mm		
Voor modellen:	FX, GX, HX, HX-30, HX-30E, HX-30ES, HX-30S, HX-40, HX-40E, HX-40ES, HX-40S, HX-E, HX-ES, HX-S		
Toebehoren voor	416299		
			
bestelnr.	505180	fabrikantnr.	00-233982-001 00-276903-021 233982-1 276903-21
O-ring EPDM materiaaldikte 3.53mm ID ø 47.22mm vpe 1stuk			

			
bestelnr.	416291	fabrikantnr.	324206-7 324206-8
omschrijving	verwarmingselement 9000W 230V VC 3 L 407mm B 42mm H 43mm aantal thermostaathulzen 1 thermostaathuls ø 5mm thermostaathuls lengte 370mm thermostaathuls buitenmidden, niet aanliggend LA 45mm gat ø 10mm aansluiting M4 4-gatsflens dompel verwarmingselement flens B 63.5mm flens L 63.5mm		
Voor modellen:	FX, GX, HX, HX-30, HX-30E, HX-30ES, HX-30S, HX-40, HX-40E, HX-40ES, HX-40S, HX-E, HX-ES, HX-S		
Toebehoren voor	416291		
			
bestelnr.	505180	fabrikantnr.	00-233982-001 00-276903-021 233982-1 276903-21
O-ring EPDM materiaaldikte 3.53mm ID ø 47.22mm vpe 1stuk			



bestelnr.	415010	fabrikantnr.	139321203 371450205
omschrijving	verwarmingselement 2000W 230V VC 1 L 260mm B 125mm H 20mm L1 110mm L2 150mm B1 42mm B2 83mm draad M10x1 bevestigingsafstand 70mm pijp ø 6.5mm aansluiting M4 dompel verwarmingselement 2-gatsbevestiging		
Voor modellen:	GE-400, GW-600, GW-600S, GW-601, GW-601S		
Toebehoren voor	415010		
	bestelnr.	504306	fabrikantnr. —
	pakking fiber OD ø 16mm ID ø 10mm materiaaldikte 2mm vpe 1stuk		
	bestelnr.	510893	fabrikantnr. —
	O-ring EPDM materiaaldikte 2.62mm ID ø 9.92mm vpe 1stuk		
	bestelnr.	520231	fabrikantnr. —
	moer draad M10x1 H 6mm SB 14 verzinkt staal vpe 1stuk		
	bestelnr.	521103	fabrikantnr. —
	moer draad M4 H 3mm SB 7 koper vpe 20stuk		
	bestelnr.	521104	fabrikantnr. —
	onderlegging ID ø 4.3mm OD ø 8mm materiaaldikte 0.5mm koper vpe 20stuk voor draad M4		
	bestelnr.	521129	fabrikantnr. —
	moer draad M10 H 6mm RVS SB 17 vpe 1stuk DIN/ISO DIN 439		
	bestelnr.	560111	fabrikantnr. —
	onderlegging ID ø 4.3mm OD ø 9mm materiaaldikte 0.8mm RVS vpe 20stuk DIN 125A voor draad M4		
	bestelnr.	560131	fabrikantnr. —
	zeskantmoer draad M4 H 3.2mm SB 7 RVS DIN/ISO DIN 934 / ISO 4032/8673 vpe 20stuk		

bestelnr.	415665	fabrikantnr.	E230086
omschrijving	verwarmingselement 2750/3250W 220/240V VC 1 L 380mm B 110mm H 30mm draad M10x1 bevestigingsafstand 75mm pijp ø 6.5mm aansluiting M4 dompel verwarmingselement 2-gatsbevestiging		
Reparatie-onderdelen voor	415665		
	bestelnr.	510893	fabrikantnr. —
	O-ring EPDM materiaaldikte 2.62mm ID ø 9.92mm vpe 1stuk		
Toebehoren voor	415665		
	bestelnr.	510416	fabrikantnr. —
	vlakpakking fiber OD ø 19mm ID ø 10.5mm materiaaldikte 1.5mm voor draad M10 vpe 1stuk		
	bestelnr.	520231	fabrikantnr. —
	moer draad M10x1 H 6mm SB 14 verzinkt staal vpe 1stuk		
	bestelnr.	520876	fabrikantnr. 139321-727
	beschermkap voor verwarmingselement ø 11.5mm H 32mm B 25mm kunststof		

Toebehoren voor	415665		
	bestelnr.	521103	fabrikantnr. —
	moer draad M4 H 3mm SB 7 koper vpe 20stuk		
	bestelnr.	521104	fabrikantnr. —
	onderlegging ID ø 4.3mm OD ø 8mm materiaaldikte 0.5mm koper vpe 20stuk voor draad M4		
	bestelnr.	521129	fabrikantnr. —
	moer draad M10 H 6mm RVS SB 17 vpe 1stuk DIN/ISO DIN 439		
	bestelnr.	560111	fabrikantnr. —
	onderlegging ID ø 4.3mm OD ø 9mm materiaaldikte 0.8mm RVS vpe 20stuk DIN 125A voor draad M4		
	bestelnr.	560131	fabrikantnr. —
	zeskantmoer draad M4 H 3.2mm SB 7 RVS DIN/ISO DIN 934 / ISO 4032/8673 vpe 20stuk		

plakelementen

bestelnr.	420355	fabrikantnr.	775763-1
omschrijving	plakelement L 288mm B 87mm 305W 240V t.max.°C silicone kabellengte 800mm materiaaldikte 1mm aansluiting Faston 6,3mm		
Voor modellen:	GC, GC11, GC12, GC31, GC32		

bestelnr.	420299	fabrikantnr.	898 126-1
omschrijving	plakelement L 360mm B 95mm 545W 230V t.max.°C silicone kabellengte 1750mm materiaaldikte 1mm		
Voor modellen:	AM-700, AM900, AMS900, AMX-900, AMXR-900, AMXS-900, AMXX-1300, AMXXR-1300, AMXXS-1300, AMXXT, AUXX-1300, AUXXL, AUXXR-1300, AUXXS-1300, AUXXT, ECOMAX-650		

bestelnr.	420475	fabrikantnr.	775575-1
omschrijving	plakelement L 370mm B 95mm 390W 230V t.max.°C kabel-lengte 790mm		
Voor modellen:	FX, GX		

toebehoren

asafdichtingen

o-ringen



bestelnr.	510563	fabrikantnr.	276903-9
omschrijving	O-ring EPDM materiaaldikte 3mm ID ø 28mm vpe 1stuk		
Voor modellen:	AM-12E, AM-12EC, AM-12EF, AM-12ER, FUX, UW-100, UW-105, UW-120, UW-125, UW-135, UW-135H, UW-200, UW-205		



bestelnr.	505092	fabrikantnr.	233982-6
omschrijving	O-ring EPDM materiaaldikte 5.34mm ID ø 43.82mm vpe 1stuk		
Voor modellen:	CS-0612E-A, CS-1012E-A, CS-2012E-A, CSD-0612E-A, CSD-1012E-A, CSD-2012E-A		



bestelnr.	510409	fabrikantnr.	00-276903-053 00-67500-016 00-67500-118 276903-53 670500-118 67500-16
omschrijving	O-ring EPDM materiaaldikte 5.34mm ID ø 56.52mm vpe 1stuk		
Voor modellen:	CR-F, CX, ECW, EWB-S, FTN, FTT, FTX, FUX, ML-104674, ML-104683, ML-104686, UW-135, UW-135H, UWX, UX-60, UX-60B, UX-60E, UX-60EB, UX-60EH, UX-60EHB, UX-60H, UX-60HB, UXT, UXTH, UXTHL, UXTHLS, UXTHS, UXTL, UXTLH, UXTLHS, UXTLS, UXTS, V1401		

flenspakkingen



bestelnr.	511655	fabrikantnr.	174529-1
omschrijving	pakking fiber L 64mm B 64mm materiaaldikte 2.3mm gat ø 9mm LA 45mm 4gaten ID ø 46mm		
Voor modellen:	102-G, 104G, 202-G, 204G, 2226, 2227, 302-G, 304G, UW-135, UW-135H		

thermostaten

clixonthermostaten

maximaal clixonthermostaten



bestelnr.	390233	fabrikantnr.	139321-17 139321-923 139321-934 371450-17
omschrijving	maximaalclixon LA 24mm uitschakeltemp. 110°C 1NC 1-polig 16A aansluiting F6,3 2-gatsbevestiging zonder houder		
Voor modellen:	CHF45, CHH-50, CHH-60D, CHH-70D, CLG-25, EF-40, EH-60, EH-70, GE-400, GF-60, GF-60S		
Toebehoren voor	390233		
	bestelnr.	504736	fabrikantnr. —
	houder voor contactthermostaat		
	bestelnr.	550388	fabrikantnr. —
	houder voor contactthermostaat bevestigingsafstand 24.5mm bevestiging ø 3.8		



bestelnr.	390462	fabrikantnr.	226504
omschrijving	maximaalclixon LAMm uitschakeltemp. 105°C 1NC 1-polig 10A aansluiting F6,3 1-gatsbevestiging		
Voor modellen:	AM-12E, AM-12EC, AM-12EF, AM-12ER, AM-600, AM-600C, AM-600CR, AM-600R, CM1E, FM-30, FM-30U, FM-400H, FM-400U, FM-500, FM-500H, UW-100, UW-105, UW-135, UW-135H, UW-55, WM2E		
Toebehoren voor	390462		
	bestelnr.	550388	fabrikantnr. —
	houder voor contactthermostaat bevestigingsafstand 24.5mm bevestiging ø 3.8		



bestelnr.	390318	fabrikantnr.	139321-721
omschrijving	maximaalclixon uitschakeltemp. 95°C 1-polig 2-gatsbevestiging		
Voor modellen:	CLG-25		



clixonthermostaten



1

bestelnr.	390504	fabrikantnr.	236052 E236052
omschrijving	clixonthermostaat LA 23.8mm uitschakeltemp. 90°C 1NO 1-polig 16A 250V aansluiting F6,3 2-gatsbevestiging voeler ø 16mm		

regel- en maximaalthermostaten

EGO

regelthermostaten

Serie 55.13_



1

bestelnr.	390472	fabrikantnr.	886638
omschrijving	thermostaat t.max. 95°C instelbereik 27-95°C 1-polig 1NO 16A voeler ø 4mm voeler L 203mm capillaire 1230mm capillaire pijp geïsoleerd 800mm stopbus as ømm as Lmm aspositie° aspositie rotatiehoek 270°		

maximaal thermostaten

Serie 55.13_



1

bestelnr.	390471	fabrikantnr.	227879
omschrijving	maximaalthermostaat uitschakeltemp. 125°C 1-polig 16A voeler ø 4mm voeler L 128mm capillaire 1130mm capillaire pijp geïsoleerd 800mm stopbus voeler RVS		
Voor modellen:	CR-F, CX, FX, GX, HX, HX-30, HX-30E, HX-30ES, HX-30S, HX-40, HX-40E, HX-40ES, HX-40S, HX-E, HX-ES, HX-S		

serie 55.33_



1



bestelnr.	390470	fabrikantnr.	378791
omschrijving	maximaalthermostaat uitschakeltemp. 100°C 3-polig 20A voeler ø 4mm voeler L 231mm capillaire 870mm capillaire pijp geïsoleerd 800mm stopbus voeler RVS		
Voor modellen:	CDC, CN, CNA, CNB, CNR, CR, CSA, CTC, ECOMAX-700, ECW, FX, GX, UX, UX-30, UX-30B, UX-30E, UX-30EB, UX-30EH, UX-30ES, UX-30ESB, UX-30ESH, UX-30H, UX-30-McDonalds, UX-30S, UX-30SB, UX-30SH, UXL, UXLS, UXS		

CAEM

regelthermostaten



1

bestelnr.	390672	fabrikantnr.	139321-20 E236042	
omschrijving	thermostaat t.max. 53°C instelbereik vast 53°C 1-polig 1CO 16A voeler ø 9.5mm voeler L 30mm capillaire 600mm capil- laire pijp geïsoleerd 540mm stopbus as Lmm inschroefvoe- ler voelerdraad M14x1			
Voor modellen:	GW-600, GW-600S, GW-601, GW-601S			
Reparatie-onderdelen voor	390672			
	bestelnr.	510417	fabrikantnr.	—
	vlakpakking fiber OD ø 20mm ID ø 14mm materiaaldikte 2mm vpe 1stuk			
	bestelnr.	550261	fabrikantnr.	—
	moer draad M14x1 H 4mm SB 19 RVS vpe 1stuk			

bestelnr.	390686	fabrikantnr.	236043 E236043
omschrijving	thermostaat t.max. 83°C instelbereik°C 1-polig 1CO 20A voeler ø 6mm voeler L 90mm capillaire 630mm capillaire pijp geïsoleerd 550mm stopbus as ømm as Lmm aspositie rotatiehoek 270° voelermateriaal koper		
Voor modellen:	CLG-25, CLG-25-NA, ECOMAX-500		

schakelaars en tasters

wipschakelaar/drukschakelaars

30x22mm



bestelnr.	301003	fabrikantnr.	15243565 F15243565
omschrijving	wipschakelaar inbouwmaat 30x22mm groen 2NO 250V 16A verlicht 0-I aansluiting vlaksteker 6,3mm omgevingstemperatuur max. 125/55°C bescherming IP65		
Toebehoren voor	301003		
	bestelnr.	301036	fabrikantnr. —
	beschermkap binnenmaat 30x22mm voor wipschakelaar inbouwmaatmm		

microschakelaars

hendelbediening



bestelnr.	345257	fabrikantnr.	139321-41
omschrijving	microschakelaar met hendel 250V 16A 1CO aansluiting vlaksteker 6,3mm L 29mm L1 33mm omgevingstemperatuur max. 120°C bevestigingsafstand 22mm besturingskracht: 130g hendellengte 31.5mm		
Voor modellen:	GW-600, GW-600S, GW-601, GW-601S		

positieschakelaars

BERNSTEIN



bestelnr.	345921	fabrikantnr.	228795
omschrijving	einschakelaar met rol 1CO 240V 3A L 93mm B 36mm H 33mm bescherming IP65 besturingskracht: 1280g schroefaansluiting M20 bevestigingsafstand 25mm		
Voor modellen:	ACW, AM-12E, AM-12EC, AM-12EF, AM-12ER, AM-600C, AM-600CR, FM-30, UWX		



bestelnr.	347237	fabrikantnr.	302440-1
omschrijving	einschakelaar met rolhendel 1NO/1NC		
Voor modellen:	UW-135, UW-135H		



bestelnr.	347721	fabrikantnr.	00-226916-000
omschrijving	einschakelaar met rolontstopper 1NO/1NC 240V 3A L 93mm B 36mm H 34mm bescherming IP65 besturingskracht: 1200g schroefaansluiting M18 bevestigingsafstand 24,5mm		
Voor modellen:	AM-600, AM-600C, AM-600CR, AM-600R, FTX, FUX, RRB, UW-100, UW-105		



bestelnr.	345922	fabrikantnr.	324195 735221-1
omschrijving	microschakelaar met kniebediening 1NO/1NC 240V 3A L 51mm B 26mm H 21mm bescherming IP30 besturingskracht: 580g schroefaansluiting bevestigingsafstand 15mm AC-15 3A		
Voor modellen:	FE, FE-W, FX, GX		

TELEMECANIQUE (EFA)



bestelnr.	347460	fabrikantnr.	785286-1
omschrijving	einschakelaar met rol 1NO/1NC L 71mm bescherming IP67		
Voor modellen:	CN, CNA, CNB, CNR, CR, CSA, ECOMAX-800		



steuenschakelaar ROLD



1

bestelnr.	347517	fabrikantnr.	E207060 E227060
omschrijving	druktaster ø 21mm zilver editie		



1

bestelnr.	347705	fabrikantnr.	227061 E227061
omschrijving	druktaster ø 21mm zilver met lens editie		
Voor modellen:	CLG-25, CLG-25-NA, ECOMAX-400-12, ECOMAX-400S-12, ECOMAX-500		



1

bestelnr.	346500	fabrikantnr.	E226080
omschrijving	elementhouder inbouwmaat 28,5x77,5mm zwart driedubbele houder		



1

bestelnr.	345605	fabrikantnr.	E208010
omschrijving	schakelement 2CO 250V 16A aansluiting vlaksteker 6,3mm		



1

bestelnr.	345606	fabrikantnr.	139321-455 E226071
omschrijving	tastelement 2CO 250V 16A aansluiting vlaksteker 6,3mm		
Voor modellen:	CLG-25		

vlotterschakelaars

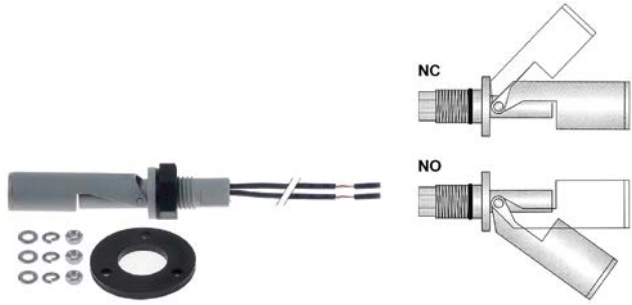

1

bestelnr.	348128	fabrikantnr.	00-896960-000
omschrijving	vlotterschakelaar draad M16x2 ø 18mm L 65mm kabel-lengte 1050mm set 1-polig temp. bestendigheid -20 tot +90°C		



1

bestelnr.	403081	fabrikantnr.	102826 229519 ML102826	
omschrijving	vlotterschakelaar draad 1/4" 1NC/1NO ø 12mm L 65mm inbouw ø 16mm 230V 0.5A kabel kabellengte 100mm			
Voor modellen:	ACW, CN, CNB, CNR, CX, EWB-S, FTN, FTX, FUX, UW-135H, UWX			
Reparatie-onderdelen voor	403081			
	bestelnr.	347433	fabrikantnr.	00-122674 122674
	vlotter met magneet ø 47mm L 33mm Bmm Hmm PVC passend voor HOBART			



1

bestelnr.	403914	fabrikantnr.	271621
omschrijving	vlotterschakelaar draad 1/4" ø 29mm L 100mm inbouw ø 9.5mm gecodeerd kabellengte 240mm voeler L 63mm		

vlotters



1

bestelnr.	347433	fabrikantnr.	00-122674
omschrijving	vlotter met magneet ø 47mm L 33mm Bmm Hmm PVC passend voor HOBART		
Voor modellen:	103G, 203G, 2226, 303G, ACW, AM-12E, AM-12EC, AM-12EF, AM-12ER, AM15, AM15F, AM15T, AM-600, AM-600C, AM-600CR, AM-600R, C44A, C44AW, C54A, C64A, CN, CNA, CNB, CNR, CR, CR-F, CSA, CX, ECOMAX-800, EWB-S, FTN, FTT, FTX, FUX, ML-110025, ML-110976, ML-110977, ML-32614, ML-32615, UW-105, UW-135, UW-135H, UWX		
Toebehoren voor	347433		
	bestelnr.	347927	fabrikantnr. 00-112467 112467
	houder voor magneetschakelaar ID ø 21mm OD ø 28.5mm		

nokenschakelaars

8-schakelstanden

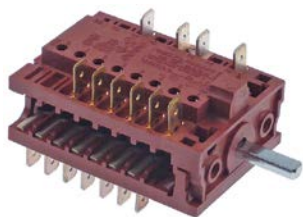

1

bestelnr.	347924	fabrikantnr.	231960-5
omschrijving	nokenschakelaar 8 schakelstanden 13NO schakelvolgorde 0-1-2-3-4-5-6-7 16A as ø 6x4,6mm as L 19mm aansluiting vlakstekker 6,3mm kunststof		
Voor modellen:	AMX, AMX-E, AMX-ER, AMX-R, AUX, AUX_, AUX-E, AUX-ER, AUX-R, FX, GX, UX-30, UX-30B, UX-30H, UX-30-McDonalds, UX-30S, UX-30SB, UX-30SH, UX-60, UX-60B, UX-60H, UX-60HB, UXD-30		

draaischakelaars

KRAUS & NAIMER

draaischakelaars



1

bestelnr.	347506 ¹	fabrikantnr.	785574-6
omschrijving	draaischakelaar 2 0-1 contactset 5 type KG100-DE10F769 400V 100A as L 52mm L1,L2,L3,N,PE aansluiting schroef-aansluiting identificatienummer 53/000100 markering T104/D-A025		



¹incl. knop en tekstlabel

magneetschakelaars

1/4"



1

bestelnr.	347490	fabrikantnr.	226282 226282-2
omschrijving	magneetschakelaar draad 1/4" kabellengte 2000mm L 62.5mm		
Voor modellen:	103G, 203G, 2226, 303G, AM-12E, AM-12EC, AM-12EF, AM-12ER, AM-600, AM-600C, AM-600CR, AM-600R, CNA, CNR, CR, CR-F, CSA, ECOMAX-800, FTT, UW-100, UW-105, UW-135, UW-135H		
Toebehoren voor	347490		
	bestelnr.	347433	fabrikantnr. 00-122674 122674
	vlotter met magneet ø 47mm L 33mm Bmm Hmm PVC passend voor HOBART		
	bestelnr.	347927	fabrikantnr. 00-112467 112467
	houder voor magneetschakelaar ID ø 21mm OD ø 28.5mm		
	bestelnr.	511516	fabrikantnr. —
	O-ring EPDM materiaaldikte 3.53mm ID ø 20.22mm vpe 10stuk		

29x19mm



1

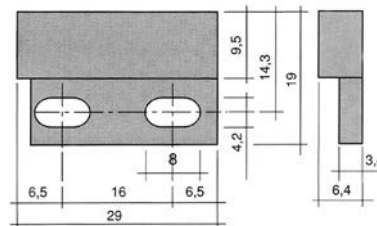

bestelnr.	345117	fabrikantnr.	844951-2
omschrijving	magneetschakelaar L 28.5mm B 19mm 1NO 250V 0.04A P max. 10W aansluiting kabel kabellengte 1000mm		



36x13mm

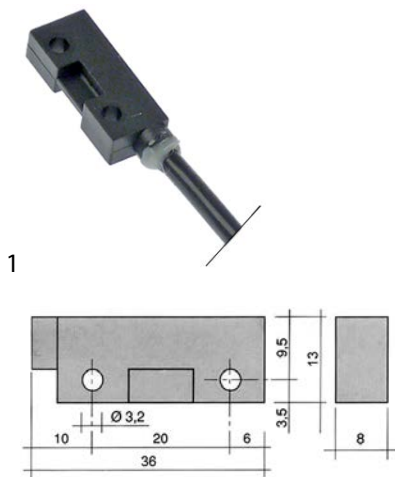

bestelnr.	345118 ¹	fabrikantnr.	139321-344 139321-586 139321-919
omschrijving	magneetschakelaar L 36mm B 13mm 1NO 250V 1A P max. 50W aansluiting kabel kabellengte 980mm		
Voor modellen:	CHF45, CHH-50, CHH-60D, CHH-70D, CLG-25, EF-40, EH-60, EH-70, GE-400, GF-60, GF-60S, GW-600, GW-600S, GW-601, GW-601S, UX, UXL, UXLS, UXS, UXT, UXTH, UXTHL, UXTHLS, UXTHS, UXTL, UXTLH, UXTLHS, UXTLS, UXTS		
Toebehoren voor	345118		
	bestelnr.	345399	fabrikantnr. —
	magneet ø 3.3mm L 40mm H 8mm B 13mm LA 30mm M3		

¹met gecodeerde steekaansluiting

50x19mm

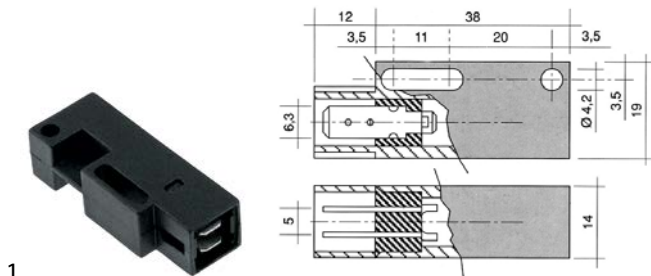

bestelnr.	345821	fabrikantnr.	775491-1
omschrijving	magneetschakelaar L 50mm B 19mm 1NO 250V 1A P max. 50W aansluiting vlakstekker 6,3mm		
Voor modellen:	AM-700, AM900, AMS900, AMX, AMX-900, AMX-E, AMX-ER, AMX-R, AMXR-900, AMXS-900, AMXX-1300, AMXXR-1300, AMXXS-1300, AMXXT, AUX, AUX-E, AUX-ER, AUX-R, AUXX-1300, AUXXL, AUXXR-1300, AUXXS-1300, AUXXT, CNA, CNR, ECOMAX-650, ECOMAX-700, FX, GX, UX-30, UX-30B, UX-30E, UX-30EB, UX-30EH, UX-30ES, UX-30ESB, UX-30ESH, UX-30H, UX-30-McDonalds, UX-30S, UX-30SB, UX-30SH, UXD-30		
Toebehoren voor	345821		
	bestelnr.	519049	fabrikantnr. —
	magneet ømm L 63mm H 10.7mm B 18.8mm LA 52mm M2 gat ø 2mm		

80x30mm



bestelnr.	347925	fabrikantnr.	229517
omschrijving	magneetschakelaar L 80mm B 30mm 1NO 250V 0.2A P max. 100W aansluiting kabel kabellengte 1300mm		
Voor modellen:	CN, CNB, CSA, ECOMAX-800, ECW, FTN, FTT, HX, HX-30, HX-30S, HX-40, HX-40S, HX-E, HX-ES, HX-S, UW-120, UW-200, UX-60EH, UX-60EHB, UX-60H, UX-60HB		



bestelnr.	345918	fabrikantnr.	229517-2
omschrijving	magneetschakelaar L 80mm B 30mm 1NO 250V 0.2A P max. 100W aansluiting kabel kabellengte 4500mm		
Voor modellen:	ECOMAX-600, ECOMAX-700, FTX, FUX, HE, HE600-HL, HE-P, HX-60-EHL		



bestelnr.	345920	fabrikantnr.	297980-4
omschrijving	magneetschakelaar L 80mm B 30mm 1NO 250V 3A aansluiting kabel 100W		
Voor modellen:	AMX, AMX-E, AMX-ER, AMX-R, AUX, AUX_, AUX-E, AUX-ER, AUX-R, UX-30, UX-30B, UX-30E, UX-30EB, UX-30EH, UX-30ES, UX-30ESB, UX-30ESH, UX-30H, UX-30-McDonalds, UX-30S, UX-30SB, UX-30SH, UX-60, UX-60B, UX-60E, UX-60EB, UX-60EH, UX-60EHB, UX-60H, UX-60HB		

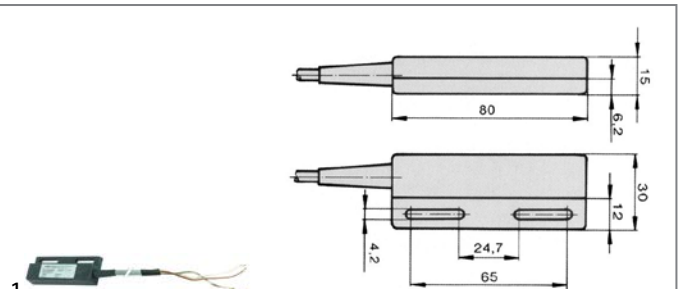

bestelnr.	345919	fabrikantnr.	297980-3
omschrijving	magneetschakelaar L 80mm B 30mm aansluiting kabel		
Voor modellen:	HX, HX-30E, HX-30ES, HX-40E, HX-40ES, HX-E, HX-ES, HX-S		



ø 6mm



1

bestelnr.	347835	fabrikantnr.	01-235338
omschrijving	magneetschakelaar 150V 1A P max. 10W voeler L 29mm 1NO aansluiting 2-aderig kabellengte 1700mm		



1

bestelnr.	347461	fabrikantnr.	01-240288-001 01-240288-1
omschrijving	magneetschakelaar 28V 0.5A P max. 15W voeler L 26mm 1NO aansluiting gecodeerde aansluiting kabellengte 280mm		
Voor modellen:	AM-10, AM-11, AM-141, AM900-10N, AM900-90, AMS900-10N, AMX, AMX-10HL, AMX-90, AMXR, AMXS, AMXT, AMXTS, AMXX, AMXXR, AMXXS, AUP, AUP-90, AUPS, AUX, AUXXL-11N, AUXXLS-11N, AUXXR, AUXXS, AUXXT, AUXXTS, CN-Protronic, CN-Smartronic, CP-Protronic, ECOMAX-402, ECOMAX-502, ECOMAX-602-10, ECOMAX-602-11, ECOMAX-602S-11, ECOMAX-612-10, ECOMAX-612S-10, FP, FX, FX-McDonalds, GP, GX		
Toebehoren voor	347461		
	bestelnr.	524661	fabrikantnr. 00-883838-001 883838-1
houder voor magneetschakelaar L 34.5mm B 26mm H 9mm			

ø 8mm



1

bestelnr.	348194	fabrikantnr.	87711-352
omschrijving	magneetschakelaar 200V 0.5A P max. 10W B 8mm voeler L 30mm 1NO aansluiting gecodeerde aansluiting kabellengte 290mm M8		

toebehoren

magneten



1

bestelnr.	347926	fabrikantnr.	166964 170015
omschrijving	magneet ø 22.5mm Lmm H 11.5mm Bmm ID ø 5.2mm M5		
Voor modellen:	AM-700, AM900, AMS900, AMX, AMX-900, AMX-E, AMX-ER, AMX-R, AMXR-900, AMXS-900, AMXX-1300, AMXXR-1300, AMXXS-1300, AMXXT, AUX, AUX_, AUX-E, AUX-ER, AUX-R, AUXX-1300, AUXXL, AUXXR-1300, AUXXS-1300, AUXXT, CNR, CR-F, CX, ECOMAX-600, ECOMAX-650, ECOMAX-700, FTT, FTX, FUX, HE, HE600-HL, HE-P, HX, HX-30, HX-30E, HX-30ES, HX-30S, HX-40, HX-40E, HX-40ES, HX-40S, HX-60-EHL, HX-E, HX-ES, HX-S, UW-135...(Andere modellen die u kunt zien in de webshop)		



1

bestelnr.	347722	fabrikantnr.	00-774714-001 774714-1
omschrijving	magneet ø 34mm Lmm H 17mm Bmm ID ø 5mm M5 met kap gat ø 5.25mm		
Voor modellen:	CN, CNA, CNB, CN-Protronic, CNR, CN-Smartronic, CP-Protronic, CR, CSA, CS-Easytronic, ECOMAX-800, ECW, FTN, FTX, FUX, UX-30B, UX-30EB, UX-30EH, UX-30ESB, UX-30ESH, UX-30H, UX-30-McDonalds, UX-30SB, UX-30SH, UX-60, UX-60B, UX-60E, UX-60EB, UX-60EH, UX-60EHB, UX-60H, UX-60HB, UXD-30, UXTH, UXTHL, UXTHLS, UXTHS, UXTLH, UXTLHS		

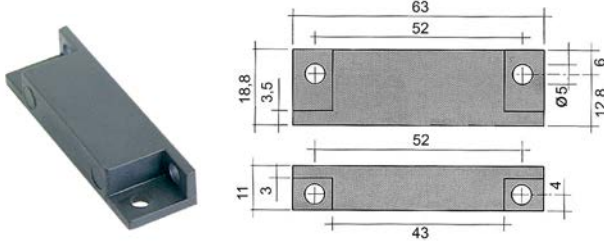

1

bestelnr.	345336	fabrikantnr.	E926014
omschrijving	magneet ø 4.8mm L 63mm H 11mm B 18.8mm LA 51mm M4		



diversen



1

bestelnr.	347927	fabrikantnr.	00-112467
omschrijving	houder voor magneetschakelaar ID ø 21mm OD ø 28.5mm		
Voor modellen:	103G, 203G, 2226, 303G, AM-12E, AM-12EC, AM-12EF, AM-12ER, AM15, AM15F, AM15T, C44A, C44AW, C54A, C64A, CN, CNA, CNB, CNR, CR, CR-F, CSA, CX, ECOMAX-800, EWB-S, FTN, FTT, FTX, FUX, ML-110025, ML-110976, ML-110977, ML-32614, ML-32615, UW-100, UW-105, UWX		



1

bestelnr.	524661	fabrikantnr.	00-883838-001 883838-1
omschrijving	houder voor magneetschakelaar L 34.5mm B 26mm H 9mm		
Voor modellen:	AM-10, AM-11, AM-141, AM900-10N, AM900-90, AMS900-10N, AMX, AMX-10HL, AMX-90, AMXR, AMXS, AMXT, AMXTS, AMXX, AMXXR, AMXXS, AUP, AUP-90, AUPS, AUXX, AUXXL-11N, AUXXLS-11N, AUXXR, AUXXS, AUXXT, AUXXTS, CN-Protronic, CN-Smartronic, CP-Protronic, ECOMAX-402, ECOMAX-502, ECOMAX-602-10, ECOMAX-602-11, ECOMAX-602S-11, ECOMAX-612-10, ECOMAX-612S-10		

systeemschakelaars

MOELLER/EATON

knoppen



1



bestelnr.	346728	fabrikantnr.	887015-71
omschrijving	keuzeschakelaar inbouwmaat ø22mm zwart/wit 330°-0°-30° vergrendeld schakelvolgorde 1-0-2		
Voor modellen:	ECOMAX-800		

SCHLEGEL

schakelaars (compleet)



1

bestelnr.	347923	fabrikantnr.	324267-4 897900	
omschrijving	pulsschakelaar inbouwmaat ø16/24x24mm wit 1NO/1NC schakelvolgorde 0-1 oneindig			
Voor modellen:	ECOMAX-600, ECOMAX-700, FE, HE, HE600-HL, HE-P			
Reparatie-onderdelen voor	347923			
	bestelnr.	359183	fabrikantnr.	—
	tastelement inbouwmaat ø16/24x24mm type drukkend antraciet/transparant vierkant			
	bestelnr.	359194	fabrikantnr.	324267-1 32427-1
	contactblok vergrendeld 1NC/1NO aansluiting vlaksteker 2,8mm verlicht fitting T5.5K type AFL			
	bestelnr.	359796	fabrikantnr.	324265-11
	inlegsymbol wit oneindig			

drukknoppen



1

bestelnr.	359794	fabrikantnr.	324266-1
omschrijving	tastelement inbouwmaat ø16/24x24mm type drukkend zwart/transparant vierkant		
Voor modellen:	ECOMAX-600, ECOMAX-700, ECOMAX-800, FE, FX, GF-60, GF-60S, GX, HE, HE600-HL, HE-P		

inlegsymbolen

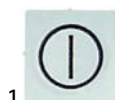

1

bestelnr.	359189	fabrikantnr.	324265-10
omschrijving	inlegsymbol wit aan		
Voor modellen:	ECOMAX-600, ECOMAX-700, HE, HE600-HL, HE-P		

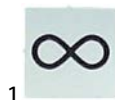

1

bestelnr.	359796	fabrikantnr.	324265-11
omschrijving	inlegsymbol wit oneindig		
Voor modellen:	ECOMAX-600, ECOMAX-700, HE, HE600-HL, HE-P		

			
1			
bestelnr.	359795	fabrikantnr.	00-324265-001 324265-1
omschrijving	inlegsymbool wit uur		
Voor modellen:	ECOMAX-600, ECOMAX-700, FX, GF-60, GF-60S, GX, HE, HE600-HL, HE-P		

			
1			
bestelnr.	359193	fabrikantnr.	324265-12
omschrijving	inlegsymbool wit water		
Voor modellen:	ECOMAX-600, ECOMAX-700, HE, HE600-HL, HE-P		

contactblokken			
			
1			
bestelnr.	359793	fabrikantnr.	324267-5 897901
omschrijving	contactblok drukkend 2NO/2NC aansluiting vlaksteker 2,8mm verlicht fitting T5.5K type ATL2		
Voor modellen:	ECOMAX-600, ECOMAX-700, FE, HE600-HL		

			
1			
bestelnr.	359187	fabrikantnr.	324267-3 897903
omschrijving	contactblok vergrendeld 2NO/2NC aansluiting vlaksteker 2,8mm verlicht fitting T5.5K type AFL2		
Voor modellen:	ECOMAX-600, ECOMAX-700, HE600-HL		

lampen

signaallampen

signaallampen 2-delig (lens en signaallamp)

signaallampkappen

ø12mm (type SDY-3)

			
1			
bestelnr.	359262	fabrikantnr.	E926114
omschrijving	signaallampfitting inbouwmaat ø12mm groen rond vpe 1stuk		

signaalelementen voor fittingtype SRZ / SDK / SDY / SFK			
			
1			
bestelnr.	359130	fabrikantnr.	216006 E216006
omschrijving	signaalelement 230V transparant aansluiting vlaksteker 6,3mm ø 8mm		

signaallampen 3-delig (behuizing, lens en gloeilamp)

verlichtingen

gloeilampen

			
1			
bestelnr.	359608	fabrikantnr.	229167-1
omschrijving	gloeilamp fitting E14 10/15W 230V ø 16mm L 51mm glas L 31mm vpe 1stuk		
Voor modellen:	CX		

lampen voor steek-/schroeffittingen



gloeilampen

voor signaallampen

			
1			
bestelnr.	359608	fabrikantnr.	229167-1
omschrijving	gloeilamp fitting E14 10/15W 230V ø 16mm L 51mm glas L 31mm vpe 1stuk		
Voor modellen:	CX		

timers

programmatimers

				
1				
bestelnr.	360349	fabrikantnr.	139321-226 E238053	
omschrijving	timer CDC 11803 motoren 1 kamers 3 looptijd 150s 230V as ømm as Lmm fabrikant nr. 11803F1BEE000.0010 motortype M48R ATS type 11803F1 / 238046			
Voor modellen:	GW-600, GW-600S, GW-601, GW-601S			
Reparatie-onderdelen voor	360349			
	bestelnr.	360673	fabrikantnr.	—
	 motor set tandwiel ø 6.8mm tanden 15 230V spanning AC 50/60Hz draairichting rechtsom motor ø 48mm H 18.5mm motortype UDS40NE1RNZ165 kabellengte 150mm met houder			









elektrische timers

			
1			
bestelnr.	350201	fabrikantnr.	00-294650-004-1 294650-4-1
omschrijving	tijdschakelaar M006 met bel looptijd 15min spreidingmin 1NO vaste positie ja aandrijving elektrisch as ø 6x4,6mm as L 22mm bevestigingsafstand 28mm bevestigingsdraad M4 aansluiting vlakstekker 4,8mm 115V spanning AC 60Hz 1-polig		
Voor modellen:	A120, H600, H600C, H600D, L800, L800C, L800D, M802, ML-104483, ML-104484, ML-104674, ML-104683, ML-104686, ML-104687, ML-104694, ML-104696, ML-134118, ML-134185, ML-134188, V1401		

MOELLER/EATON

magneetschakelaars

			
1			
bestelnr.	380549	fabrikantnr.	139270-1
omschrijving	relais AC1 20A 230VAC (AC3/400V) 9A/4kW hoofcontact 3NO hulpcontact 1NO aansluiting schroefaansluiting type DILM9 10		
Voor modellen:	AM-12E, AM-12EC, AM-12EF, AM-12ER, H600, H800		
Toebehoren voor	380549		
	bestelnr.	380555	fabrikantnr. —
	hulpcontact contact 2NO/2NC AC15 16A voor magneetschakelaar DILEM aansluiting schroefaansluiting type DILA-XHI22		
	bestelnr.	380556	fabrikantnr. —
	hulpcontact contact 4NO AC15 16A voor magneetschakelaar DILM 7-32 aansluiting schroefaansluiting type DILA-XHI40		
	bestelnr.	380557	fabrikantnr. —
	hulpcontact contact 4NC AC15 16A voor magneetschakelaar DILM 7-32 aansluiting schroefaansluiting type DILA-XHI04		
	bestelnr.	380558	fabrikantnr. —
	hulpcontact contact 3NO/1NC AC15 16A voor magneetschakelaar DILM 7-32 aansluiting schroefaansluiting type DILA-XHI31		
	bestelnr.	380559	fabrikantnr. —
	hulpcontact contact 1NO/3NC AC15 16A voor magneetschakelaar DILM 7-32 aansluiting schroefaansluiting type DILA-XHI13		
	bestelnr.	380568	fabrikantnr. —
	ontstorings RC passend voor DILM 9-12 maximale spanning 110-240V		

magneetschakelaars

GENERAL ELECTRIC (AEG)

magneetschakelaars

			
1			
bestelnr.	380239	fabrikantnr.	00-695507-001
omschrijving	relais AC1 20A 230VAC (AC3/400V) 8,4A/4kW hoofcontact 3NO hulpcontact 1NC aansluiting schroefaansluiting type LS05 01A type AEG LS05 01A type GE MC1A 301A		

			
1			
bestelnr.	380837	fabrikantnr.	695507-11
omschrijving	relais AC1 20A 400VAC (AC3/400V) 9A/4kW hoofcontact 3NO hulpcontact 1NO aansluiting schroefaansluiting type AEG LS0510A type GE MC1A 310A		
Voor modellen:	FE, HE		

hulpcontacten

			
1			
bestelnr.	380242	fabrikantnr.	695508-2 695570-2
omschrijving	hulpcontact contact 1NO/1NC voor magneetschakelaar M+LS05 aansluiting schroefaansluiting AC-12 10A type AEG HS05K 11HS type GE MARN 211		
Voor modellen:	FE, HE, HE600-HL, HE-P		

SIEMENS

magneetschakelaars

			
1			
bestelnr.	380957	fabrikantnr.	E927160
omschrijving	relais AC1 22A 24VAC (AC3/400V) 12A/5,5kW hoofcontact 3NO hulpcontact 1NO aansluiting schroefaansluiting type 3RT10-17-1AB01 50/60Hz		



TELEMECANIQUE (Schneider Electric)

magneetschakelaars



1			
bestelnr.	380962	fabrikantnr.	00-695521-062 695521-62
omschrijving	relais AC1 20A 230VAC (AC3/400V) 9A/4kW hoofdcontact 4NO aansluiting schroefaansluiting type LC1K09004U7		
Voor modellen:	ECOMAX-402, ECOMAX-502		



1			
bestelnr.	380820	fabrikantnr.	00-695527-002
omschrijving	relais AC1 25A 230VAC (AC3/400V) 9A/4kW hoofdcontact 3NO hulpcontact 1NO/1NC aansluiting schroefaansluiting type LC1D0900M7		



1			
bestelnr.	380976	fabrikantnr.	296926-2
omschrijving	relais AC1 32A 230VAC (AC3/400V) 18A/7,5kW hoofdcontact 3NO hulpcontact 1NO/1NC aansluiting schroefaansluiting		

relais

vermogensrelais

met soldeerbevestiging



1			
bestelnr.	380312	fabrikantnr.	00-139321-354 229023
omschrijving	vermogensrelais FINDER 230VAC 10A 3CO aansluiting vlaksteker 4,8mm overslagbevestiging maat 52x32,2x36,5mm fabrikant nr. 60.63.8.230.0000		



1			
bestelnr.	380139	fabrikantnr.	929115
omschrijving	vermogensrelais FINDER 230VAC 16A 2CO aansluiting F6,3 overslagbevestiging maat 68x38,2x35,8mm fabrikant nr. 62.82.8.230.0000		

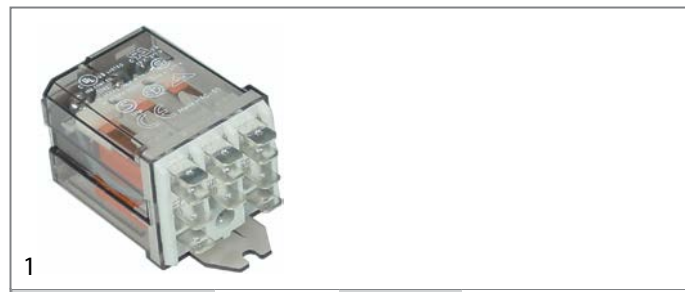

1			
bestelnr.	380403	fabrikantnr.	900073
omschrijving	vermogensrelais FINDER 230VAC 16A 3CO aansluiting F6,3 overslagbevestiging fabrikant nr. 62.83.8.230.0500		



tijdsrelais

tijdsrelais



1

bestelnr.	380625	fabrikantnr.	228180-3
omschrijving	tijdrelais DOLD CD7839.65/100 tijdbereik 0,5-5s 220-240VAC 4A 1NO aansluiting klemaansluiting		
Voor modellen:	FM-30, FM-30U, FX, GX, HX, HX-30, HX-30E, HX-30ES, HX-30S, HX-40, HX-40E, HX-40ES, HX-40S, HX-E, HX-ES, HX-S		



1

bestelnr.	380624	fabrikantnr.	228180-1
omschrijving	tijdrelais DOLD CD7839.65/100 tijdbereik 3-30s 220-240VAC 4A 1NO aansluiting klemaansluiting		
Voor modellen:	CM1E, FM-30, FM-30U, FX, GX, HX, HX-30, HX-30E, HX-30ES, HX-30S, HX-40, HX-40E, HX-40ES, HX-40S, HX-E, HX-ES, HX-S, WM2E		



1

bestelnr.	380960	fabrikantnr.	774103-2
omschrijving	tijdrelais DOLD IK817N.81/200 tijdbereik 0,02s-300h 12-240V AC/DC inbouwmaat DIN-railmm		
Voor modellen:	ECOMAX-600, ECOMAX-700		

voelers

fabrikantspecifieke voelers

voelers



1

bestelnr.	402905	fabrikantnr.	00-775612-001 775612-1	
omschrijving	temperatuurvoeler NTC 10kOhm kabel PVC voeler -40 tot +110°C kabel -10 tot +100°C aansluiting gecodeerde aansluiting draad voeler ø5x35mm kabellengte 0.2m			
Voor modellen:	AM-10, AM-11, AM-141, AM-700, AM900, AM900-10N, AM900-90, AMS900, AMS900-10N, AMX, AMX-10HL, AMX-90, AMX-900, AMXR, AMXR-900, AMXS, AMXS-900, AMXT, AMXTS, AMXX, AMXX-1300, AMXXR, AMXXR-1300, AMXXS, AMXXS-1300, AMXXT, AUP, AUP-90, AUPS, AUXX, AUXX-1300, AUXXL, AUXXL-11N, AUXXL-11N, AUXXR, AUXXR-1300, AUXXS, AUXXS-1300, AUXXT, AUXXTS, CNA, CNB, CN-Protronic, CNR, CN-Smartronic, CP-Protronic, ECOMAX-602-10, ECOMAX-602-11, ECOMAX-602S-11, ECOMAX-612-10... (Andere modellen die u kunt zien in de webshop)			
Toebehoren voor	402905			
	bestelnr.	692218	fabrikantnr.	00-775489-001 775489-1
	voelerklem voor temperatuurvoeler L 35mm B 24mm H 5mm			



1

bestelnr.	402906	fabrikantnr.	775494-1
omschrijving	temperatuurvoeler NTC 10kOhm kabel voeler -40 tot +110°C kabel°C aansluiting vlakstekker 4,8mm draad voeler ø10x30mm kabellengtem		
Voor modellen:	AM900, AMS900, FX, GC, GC11, GC12, GC31, GC32, GC41, GC42, GX		



1

bestelnr.	379907	fabrikantnr.	298543-2
omschrijving	temperatuurvoeler Pt1000 kabel silicone voeler -50 tot +250°C kabel -50 tot +180°C aansluiting vlakstekker 6,3mm draad voeler ø6x50mm kabellengte 1.5m -50 tot +180°C		
Voor modellen:	AM-600, AM-600C, AM-600CR, AM-600R, FM-400H, FM-400U, FM-500, FM-500H, UW-105, UW-135H, UW-55		



1

bestelnr.	378262	fabrikantnr.	298543-1
omschrijving	temperatuurvoeler Pt1000 kabel silicone voeler -50 tot +400°C kabel -50 tot +180°C aansluiting F6,3 draad voeler ø6x50mm kabellengte 2.5m		
Voor modellen:	UW-125, UW-135, UW-135H, UW-205		

1 

bestelnr.	379906	fabrikantnr.	00-378584-000 229512-2
omschrijving	temperatuurvoeler PTC 2kOhm kabel TPE voeler -50 tot +150°C kabel -40 tot +110°C aansluiting gecodeerde aansluiting draad voeler ø4,8x30mm kabellengte 3.5m		
Voor modellen:	AMX-E, AMX-ER, AUX-E, AUX-ER, CN, CX, FE-W, FTN, FTX, FX, GX, HX-30E, HX-30ES, HX-40E, HX-40ES, HX-60-EHL, HX-E, HX-ES, UX-30E, UX-30EB, UX-30EH, UX-30ES, UX-30ESB, UX-30ESH, UX-30-McDonalds, UX-60E, UX-60EB, UX-60EH, UX-60EHB		

toebehoren

bevestigingen

1 

bestelnr.	692218	fabrikantnr.	00-775489-001 775489-1
omschrijving	voelerklem voor temperatuurvoeler L 35mm B 24mm H 5mm		
Voor modellen:	AM-10, AM-11, AM-141, AM-700, AM900, AM900-10N, AM900-90, AMS900, AMS900-10N, AMX, AMX-10HL, AMX-90, AMX-900, AMXR, AMXR-900, AMXS, AMXS-900, AMXT, AMXTS, AMXX, AMXX-1300, AMXXR, AMXXR-1300, AMXXS, AMXXS-1300, AMXXT, AUP, AUP-90, AUPS, AUXX, AUXX-1300, AUXXL, AUXXL-11N, AUXXLS-11N, AUXXR, AUXXR-1300, AUXXS, AUXXS-1300, AUXXT, AUXXTS, CNA, CN-Protronic, CNR, CN-Smartronic, CP-Protronic, CSA, CS-Easytronic, ECOMAX-600, ECOMAX-602-10, ECOMAX-602-11...(Andere modellen die u kunt zien in de webshop)		

elektronica

EPROMS

1 

bestelnr.	403031	fabrikantnr.	897547-17
omschrijving	EPROM		

1 

bestelnr.	403046	fabrikantnr.	775233-3V
omschrijving	EPROM		

1 

bestelnr.	403702	fabrikantnr.	897547-15
omschrijving	EPROM Rev. 1.6 (04.06.2013)		

1 

bestelnr.	403217	fabrikantnr.	897503-2
omschrijving	EPROM type Rev 10.4/5D51 voor vaatwasser passend voor HOBART CODE 897503-2 17.07.07		
Voor modellen:	AM-700, AM900, AMS900, AMX-900, AMXR-900, AMXS-900, AMXX-1300, AMXXR-1300, AMXXS-1300, AMXXT, AUXX-1300, AUXXL, AUXXR-1300, AUXXS-1300, AUXXT, GC 11, GC12, GC31, GC32, GC41, GC42, UX, UXL, UXLS, UXS, UXT, UXTH, UXTHL, UXTHLS, UXTHS, UXTL, UXTLH, UXTLHS, UXTLS, UXTS		

1 

bestelnr.	403218	fabrikantnr.	774142-1 774142-1V
omschrijving	EPROM type Rev 13/6B17 voor vaatwasser passend voor HOBART CODE 774142-1 16.10.01		
Voor modellen:	AMX-E, AMX-ER, AUX-E, AUX-ER, FE-W, FX, HX-30E, HX-30ES, HX-40E, HX-40ES, HX-E, HX-ES, UX-30E, UX-30EB, UX-30EH, UX-30ES, UX-30ESB, UX-30ESH, UX-30-McDonalds, UX-60E, UX-60EB, UX-60EH, UX-60EHB		



1

bestelnr.	403216	fabrikantnr.	897503-1
omschrijving	EPROM type Rev 7.06/403A voor vaatwasser passend voor HOBART CODE 897503-1 24.04.07		
Voor modellen:	FX, GX		



1

bestelnr.	403030	fabrikantnr.	00-897547-006 897547-6
omschrijving	EPROM type REV. L2.3/6101 CODE 897547-6		



1

bestelnr.	403241	fabrikantnr.	139321-688
omschrijving	EPROM type U61E voor vaatwasser CODE 81001-3		
Voor modellen:	CHH-50, CHH-60D, CHH-70D, EH-60, EH-70		

printplaten



1

bestelnr.	403032	fabrikantnr.	00-897560-001 00-897560-002 897560-1 897560-2
omschrijving	bedieningsprint vaatwasser C402(S)/C502(S)/C602(S)-xx L 185mm B 35mm passend voor COOKMAX met scherm knoppen 4		
Voor modellen:	AM-10, AM-11, AM-141, ECOMAX-402, ECOMAX-502, ECOMAX-602-10, ECOMAX-602-11, ECOMAX-602S-11, ECOMAX-612-10, ECOMAX-612S-10		



1

bestelnr.	402904	fabrikantnr.	00-897501-1
omschrijving	bedieningsprintplaat vaatwasser AM/AMX 700/900 passend voor HOBART knoppen 4		
Voor modellen:	AM-700, AM900, AMS900, AMX-900, AMXR-900, AMXS-900, AMXX-1300, AMXXR-1300, AMXXS-1300, AMXXT, AUXX-1300, AUXXL, AUXXR-1300, AUXXS-1300, AUXXT, CNA, CNR, ECOMAX-650, FX, GC, GC11, GC12, GC31, GC32, GC41, GC42, GX, UX, UXL, UXLS, UXS, UXT, UXTH, UXTHL, UXTHLS, UXTHS, UXTL, UXTLH, UXTLHS, UXTLS, UXTS		



1

bestelnr.	403204	fabrikantnr.	00-897545-005 897545-5	
omschrijving	controleprint vaatwasser C502/C602 L 148mm B 126mm zonder EPROM Alleen voor Ecomax			
Toebehoren voor	403204			
	bestelnr.	403030	fabrikantnr.	00-897547-006 897547-6
	EPROM type REV. L2.3/6101 CODE 897547-6			
	bestelnr.	403031	fabrikantnr.	897547-17
	EPROM			



1

bestelnr.	400897	fabrikantnr.	139321-456	
omschrijving	displayprintplaat vaatwasser GS 60			
Voor modellen:	CHF45, CHH-50, CHH-60D, CHH-70D, EF-40, EH-60, EH-70			
Toebehoren voor	400897			
	bestelnr.	403250	fabrikantnr.	139321-684
	vlakbandkabel 10-polig L 3200mm stekertype gecodeerd 2-rijen aantal stekerpolen 10			







1

bestelnr.	403882	fabrikantnr.	01-515340-001 01-515340-1
omschrijving	printplaat passend voor HOBART		



1

bestelnr.	403033	fabrikantnr.	00-897545-001 00-897545-002 00-897545-003 897543-002/00 897545-1 897545-2 897545-3
omschrijving	printplaat sturing L 147mm B 125mm zonder EPROM 230V		
Voor modellen:	AM-10, AM-11, AM-141, AM900-10N, AM900-90, AMS900-10N, AMX, AMX-10HL, AMX-90, AMXR, AMXS, AMXT, AMXTS, AMXX, AMXXR, AMXXS, AUP, AUP-90, AUPS, AUXX, AUXXL-11N, AUXXLS-11N, AUXXR, AUXXS, AUXXT, AUXXTS, ECOMAX-402, ECOMAX-502, ECOMAX-602-10, ECOMAX-602-11, ECOMAX-602S-11, ECOMAX-612-10, ECOMAX-612S-10, FP, FX, FX-McDonalds, GP, GX		
Toebehoren voor	403033		
	bestelnr.	403030	fabrikantnr. 00-897547-006 897547-6
	EPROM type REV. L2.3/6101 CODE 897547-6		
	bestelnr.	403031	fabrikantnr. 897547-17
	EPROM		
	bestelnr.	403702	fabrikantnr. 897547-15
	EPROM Rev. 1.6 (04.06.2013)		



1

bestelnr.	401893	fabrikantnr.	00-087714-028-2 87714-28-2
omschrijving	printplaat tijdsturing passend voor HOBART		
Voor modellen:	C44A, C44AW, C54A		





1

bestelnr.	401895	fabrikantnr.	781142-1
omschrijving	printplaat vaatwasser CR type 5E 5A		



1

bestelnr.	402903	fabrikantnr.	00-897502-001 897502-1 897502-12 897502-2 897502-22
omschrijving	printplaat vaatwasser GX/FX/HX passend voor HOBART zonder EPROM		
Voor modellen:	AM-700, AM900, AMS900, AMX-900, AMXR-900, AMXS-900, AMXX-1300, AMXXR-1300, AMXXS-1300, AMXXT, AUXX-1300, AUXXL, AUXXR-1300, AUXXS-1300, AUXXT, ECOMAX-650, FX, GC, GC11, GC12, GC31, GC32, GC41, GC42, GX, UX, UXL, UXLS, UXS, UXT, UXTH, UXTHL, UXTHLS, UXTHS, UXTL, UXTLH, UXTLHS, UXTLS, UXTS		
Toebehoren voor	402903		
	bestelnr.	403217	fabrikantnr. 897503-2
	EPROM type Rev 10.4/5D51 voor vaatwasser passend voor HOBART CODE 897503-2 17.07.07		



1

bestelnr.	401946	fabrikantnr.	324074-1 324250-1 374391-1 785422-1
omschrijving	printplaat vaatwasser HX		
Voor modellen:	FX, GX, HX, HX-E, HX-ES, HX-S		



bedieningsfoliën

frontfoliën



1

bestelnr.	402321	fabrikantnr.	296979-4
omschrijving	bedieningsfolie		
Voor modellen:	AM-600, AM-600C, AM-600CR, AM-600R, FM-400H, FM-400U, FM-500, FM-500H, UW-105, UW-135, UW-135H, UW-55		



1

bestelnr.	403769	fabrikantnr.	00-897550-001 897550-1
omschrijving	bedieningsfolie spoeltechniek AM900 L 187mm B 45mm		
Voor modellen:	AM900-10N, AM900-90, AMS900-10N, AMX, AMX-10HL, AMX-90, AMXR, AMXS, AMXT, AMXTS, AMXX, AMXXR, AMXXS, FX, FX-McDonalds, GX		



1

bestelnr.	694717	fabrikantnr.	N/A
omschrijving	bedieningsfolie spoeltechniek universele vaatwasser zwart/wit passend voor HOBART L 185mm B 144mm knoppen 3		



1

bestelnr.	698701	fabrikantnr.	00-897500-001 897500-1
omschrijving	bedieningsfolie vaatwasser AMX 900 L 500mm B 41mm		
Voor modellen:	AM900, AMS900, AMX-900, AMXR-900, AMXS-900, AMXX-1300, AMXXR-1300, AMXXS-1300, AMXXT, AUXX-1300, AUXXL, AUXXR-1300, AUXXS-1300, AUXXT, FX, GX, UX, UXL, UXLS, UXS, UXT, UXTH, UXTHL, UXTHLS, UXTHS, UXTL, UXTLH, UXTLHS, UXTLS, UXTS		



1

bestelnr.	403783	fabrikantnr.	41357
omschrijving	frontfolie vaatwasser HOBART/EUROTEC L 144mm B 184mm		

bedieningsfoliën



1

bestelnr.	402918	fabrikantnr.	324202
omschrijving	membraanfolie spoeltechniek GX/FX/HX knoppen 7 passend voor HOBART L 152mm B 52mm		
Voor modellen:	AMX-E, AMX-ER, AUX-E, AUX-ER, FX, HX-30E, HX-40E, HX-E, UX-30E, UX-30EB, UX-30EH, UX-30ES, UX-30ESB, UX-30ESH, UX-30-McDonalds, UX-60E		

magneetventielen

magneetventielen voor water

INTERELEKTRIK

temperatuur medium: 90°C 90°C 60°C
 temperatuur omgeving: 60°C 25°C 60°C
 inschakeltijd: 40% 100% 100%

met reducering



1











bestelnr.	370675	fabrikantnr.	00-883658-001 01-246164-001 01-246164-1 883658-1
omschrijving	magneetventiel enkel recht 230VAC ingang 3/4" uitgang 10,5mm ingang 5l/min t.max. 90°C		
Voor modellen:	AM900-10N, AM900-90, AMS900-10N, AMX, AMX-10HL, AMX-90, AMX-900, AMXR, AMXR-900, AMXS, AMXS-900, AMXT, AMXTS, AMXX, AMXX-1300, AMXXR, AMXXR-1300, AMXXS, AMXXS-1300, AMXXT, AUP, AUP-90, AUPS, AUXX, AUXX-1300, AUXXL-11N, AUXXLS-11N, AUXXR, AUXXR-1300, AUXXS, AUXXS-1300, AUXXT, AUXXTS, ECOMAX-402, ECOMAX-502, ECOMAX-602-11, ECOMAX-602S-11, ECOMAX-612-10, ECOMAX-612S-10, ECOMAX-700, FP, FX, FX-McDonalds, GP, GX, UX, UXL, UXLS, UXS, UXT...(Andere modellen die u kunt zien in de webshop)		

Toebehoren voor	370675		
bestelnr.	520015	fabrikantnr.	00-775559-007 00-775559-008 00-775559-013 00-775559-016 139321-125 139321-611 775559-13 775559-16 775559-7 775559-8
toevoerslang ID ø 10mm OD ø 17mm L 5m werkdruk 20bar plaatdruk 60bar t.max. 95°C grijs VPE 5m			



MÜLLER

temperatuur medium: 90°C
 inschakeltijd: 100%

 <p>1</p>									
bestelnr.	370001 fabrikantnr. 324207-1								
omschrijving	magneetventiel enkel haaks 230VAC ingang 3/4" uitgang 14,5mm DN10 t.max. 90°C inschakeltijd 100% MÜLLER								
Voor modellen:	AM3, AMX, AMX-E, AMX-ER, AMX-R, AUX, AUX_, AUX-E, AUX-ER, AUX-R, FE, FX, GX, HE, HE-P, HX, HX-30, HX-30E, HX-40, HX-40E, HX-60-EHL, HX-E, HX-ES, HX-S, UX-30, UX-30B, UX-30E, UX-30EB, UX-30EH, UX-30H, UX-30-McDonalds, UX-60, UX-60B, UX-60E, UX-60EB, UX-60EH, UX-60EHB, UX-60H, UX-60HB, UXD-30								
Reparatie-onderdelen voor	370001								
	<table border="1"> <tr> <td>bestelnr.</td> <td>370126</td> <td>fabrikantnr.</td> <td>—</td> </tr> <tr> <td colspan="4">magneetventielhuis enkel haaks ingang 3/4" uitgang 14,5mm DN10 t.max. 90°C inschakeltijd 100% MÜLLER kunststof</td> </tr> </table>	bestelnr.	370126	fabrikantnr.	—	magneetventielhuis enkel haaks ingang 3/4" uitgang 14,5mm DN10 t.max. 90°C inschakeltijd 100% MÜLLER kunststof			
bestelnr.	370126	fabrikantnr.	—						
magneetventielhuis enkel haaks ingang 3/4" uitgang 14,5mm DN10 t.max. 90°C inschakeltijd 100% MÜLLER kunststof									
	<table border="1"> <tr> <td>bestelnr.</td> <td>371002</td> <td>fabrikantnr.</td> <td>—</td> </tr> <tr> <td colspan="4">magneetventielhouder MÜLLER flenshouder</td> </tr> </table>	bestelnr.	371002	fabrikantnr.	—	magneetventielhouder MÜLLER flenshouder			
bestelnr.	371002	fabrikantnr.	—						
magneetventielhouder MÜLLER flenshouder									
	<table border="1"> <tr> <td>bestelnr.</td> <td>371009</td> <td>fabrikantnr.</td> <td>—</td> </tr> <tr> <td colspan="4">drukveer voor magneetspoel</td> </tr> </table>	bestelnr.	371009	fabrikantnr.	—	drukveer voor magneetspoel			
bestelnr.	371009	fabrikantnr.	—						
drukveer voor magneetspoel									
	<table border="1"> <tr> <td>bestelnr.</td> <td>371011</td> <td>fabrikantnr.</td> <td>—</td> </tr> <tr> <td colspan="4">onderdelenset membraam met lange ster ster hoogte 8mm MÜLLER</td> </tr> </table>	bestelnr.	371011	fabrikantnr.	—	onderdelenset membraam met lange ster ster hoogte 8mm MÜLLER			
bestelnr.	371011	fabrikantnr.	—						
onderdelenset membraam met lange ster ster hoogte 8mm MÜLLER									
	<table border="1"> <tr> <td>bestelnr.</td> <td>371017</td> <td>fabrikantnr.</td> <td>—</td> </tr> <tr> <td colspan="4">magneetspoel MÜLLER 230VAC aansluiting vlaksteker 6,3mm</td> </tr> </table>	bestelnr.	371017	fabrikantnr.	—	magneetspoel MÜLLER 230VAC aansluiting vlaksteker 6,3mm			
bestelnr.	371017	fabrikantnr.	—						
magneetspoel MÜLLER 230VAC aansluiting vlaksteker 6,3mm									
	<table border="1"> <tr> <td>bestelnr.</td> <td>371122</td> <td>fabrikantnr.</td> <td>—</td> </tr> <tr> <td colspan="4">magneetventielzeef ø 19mm H 10mm passend voor MÜLLER</td> </tr> </table>	bestelnr.	371122	fabrikantnr.	—	magneetventielzeef ø 19mm H 10mm passend voor MÜLLER			
bestelnr.	371122	fabrikantnr.	—						
magneetventielzeef ø 19mm H 10mm passend voor MÜLLER									
	<table border="1"> <tr> <td>bestelnr.</td> <td>501161</td> <td>fabrikantnr.</td> <td>—</td> </tr> <tr> <td colspan="4">bovendeel voor magneetventiel houder voor magneetspoel</td> </tr> </table>	bestelnr.	501161	fabrikantnr.	—	bovendeel voor magneetventiel houder voor magneetspoel			
bestelnr.	501161	fabrikantnr.	—						
bovendeel voor magneetventiel houder voor magneetspoel									
Toebehoren voor	370001								
	<table border="1"> <tr> <td>bestelnr.</td> <td>371010</td> <td>fabrikantnr.</td> <td>—</td> </tr> <tr> <td colspan="4">magneetspoel 230VAC aansluiting met kabel kabellengte 2000mm</td> </tr> </table>	bestelnr.	371010	fabrikantnr.	—	magneetspoel 230VAC aansluiting met kabel kabellengte 2000mm			
bestelnr.	371010	fabrikantnr.	—						
magneetspoel 230VAC aansluiting met kabel kabellengte 2000mm									
	<table border="1"> <tr> <td>bestelnr.</td> <td>371037</td> <td>fabrikantnr.</td> <td>—</td> </tr> <tr> <td colspan="4">magneetspoel 24VAC 50/60Hz aansluiting vlaksteker 6,3mm</td> </tr> </table>	bestelnr.	371037	fabrikantnr.	—	magneetspoel 24VAC 50/60Hz aansluiting vlaksteker 6,3mm			
bestelnr.	371037	fabrikantnr.	—						
magneetspoel 24VAC 50/60Hz aansluiting vlaksteker 6,3mm									
	<table border="1"> <tr> <td>bestelnr.</td> <td>371038</td> <td>fabrikantnr.</td> <td>—</td> </tr> <tr> <td colspan="4">magneetspoel 230VAC aansluiting apparaatsteker</td> </tr> </table>	bestelnr.	371038	fabrikantnr.	—	magneetspoel 230VAC aansluiting apparaatsteker			
bestelnr.	371038	fabrikantnr.	—						
magneetspoel 230VAC aansluiting apparaatsteker									

magneetventielen met reducering

enkel

 <p>1</p>	
bestelnr.	370312 fabrikantnr. 324207-2
omschrijving	magneetventiel enkel haaks 230VAC ingang 3/4" uitgang 14mm ingang 10l/min t.max. 90°C MÜLLER kunststof reducering ingang wit
Voor modellen:	AMX-ER, AMX-R, AUX-ER, AUX-R

 <p>1</p>	
bestelnr.	370645 fabrikantnr. 297808-12
omschrijving	magneetventiel enkel recht 220-240VAC ingang 3/4" uitgang 3/4" ingang 20l/min 10 MÜLLER reducering ingang groen
Voor modellen:	CNB

 <p>1</p>	
bestelnr.	370640 fabrikantnr. 297497
omschrijving	magneetventiel enkel recht 230VAC ingang 3/4" uitgang 14,5mm uitgang 2.5l/min DN10 t.max. 90°C inschakeltijd 100% MÜLLER

tweevoud

 <p>1</p>	
bestelnr.	370331 fabrikantnr. 324208-1
omschrijving	magneetventiel dubbel haaks 230VAC ingang 3/4" uitgang 14mm ingang 10l/min t.max. 90°C MÜLLER kunststof uitgang A 3.5l/min
Voor modellen:	FE-W, FX, GX, HX-30ES, HX-30S, HX-40ES, HX-40S, HX-ES, HX-S, UX-30ES, UX-30ESB, UX-30ESH, UX-30-McDonalds, UX-30S, UX-30SB, UX-30SH

			
1			
bestelnr.	370313	fabrikantnr.	324208-3 324208-5
omschrijving	magneetventiel dubbel haaks 230VAC ingang 3/4" uitgang 4mm ingang 10l/min t.max. 90°C MÜLLER kunststof reducering ingang wit uitgang B 3.5l/min reducering uitgang A donkerblauw		
Voor modellen:	FX, GX, HX-30ES, HX-30S, HX-40ES, HX-40S, HX-ES, HX-S, UX-30ES, UX-30ESB, UX-30ESH, UX-30-McDonalds, UX-30S, UX-30SB, UX-30SH		

ROBERTSHAW/INVENSYS

temperatuur medium: 90°C 90°C 60°C
 temperatuur omgeving: 60°C 25°C 60°C
 inschakeltijd: 40% 100% 100%

magneetventielen met reducering



enkel

			
1			
bestelnr.	374013	fabrikantnr.	775742-1
omschrijving	magneetventiel enkel recht 230VAC ingang 3/4" uitgang 11,5mm 10 Invensys kunststof reducering ingang roze		
Voor modellen:	AM-700, GC, GC11, GC12		

















RPE



			
1			
bestelnr.	370857	fabrikantnr.	00-883658-002 883658-2
omschrijving	magneetventiel enkel recht 230VAC ingang 3/4" uitgang 10,5mm ingang 15l/min t.max. 90°C RPE kunststof		
Voor modellen:	AM-10, AM-11, AM-141, AMX-10HL, ECOMAX-402, ECOMAX-502, ECOMAX-602-10, FP, FX, FX-McDonalds, GP, GX, UX, UXL, UXLS, UXS, UXT, UXTL, UXTLS, UXTS		

TP

			
1			
bestelnr.	370025	fabrikantnr.	139321-1
omschrijving	magneetventiel drievoudig recht 230VAC ingang 3/4" uitgang 11,5mm DN10 TP		
Reparatie-onderdelen voor	370025		
	bestelnr.	371013	fabrikantnr. —
magneetspoel TP 230VAC 50/60Hz			

Toebehoren voor	370025		
	bestelnr.	371220	fabrikantnr. —
reducer TP doorstroomsnelheid 3l/min rood tolerantie ±15%			
	bestelnr.	371221	fabrikantnr. —
reducer TP doorstroomsnelheid 5.5l/min geel tolerantie ±15%			
	bestelnr.	371222	fabrikantnr. —
reducer TP doorstroomsnelheid 6l/min grijs tolerantie ±15%			
	bestelnr.	371223	fabrikantnr. —
reducer TP doorstroomsnelheid 10l/min wit tolerantie ±15%			
	bestelnr.	371224	fabrikantnr. —
reducer TP doorstroomsnelheid 12l/min brons tolerantie ±15%			
	bestelnr.	371225	fabrikantnr. —
reducer TP doorstroomsnelheid 16l/min lichtbruin tolerantie ±15%			
	bestelnr.	371226	fabrikantnr. —
reducer TP doorstroomsnelheid 20l/min rood tolerantie ±15%			
	bestelnr.	371230	fabrikantnr. —
reducer TP doorstroomsnelheid 0.25l/min rood tolerantie ±25%			
	bestelnr.	371231	fabrikantnr. —
reducer TP doorstroomsnelheid 0.35l/min violet tolerantie ±25%			
	bestelnr.	371232	fabrikantnr. —
reducer TP doorstroomsnelheid 0.5l/min oranje tolerantie ±25%			
	bestelnr.	371233	fabrikantnr. —
reducer TP doorstroomsnelheid 0.8l/min wit tolerantie ±25%			
	bestelnr.	371234	fabrikantnr. —
reducer TP doorstroomsnelheid 1l/min lichtblauw tolerantie ±25%			
	bestelnr.	371235	fabrikantnr. —
reducer TP doorstroomsnelheid 1.2l/min bruin tolerantie ±25%			
	bestelnr.	371236	fabrikantnr. —
reducer TP doorstroomsnelheid 1.5l/min lichtbruin tolerantie ±25%			
	bestelnr.	371237	fabrikantnr. —
reducer TP doorstroomsnelheid 2.5l/min geel tolerantie ±25%			
	bestelnr.	371238	fabrikantnr. —
reducer TP doorstroomsnelheid 3.4l/min donkergroen tolerantie ±25%			
	bestelnr.	371239	fabrikantnr. —
reducer TP doorstroomsnelheid 5l/min zwart tolerantie ±25%			
	bestelnr.	371240	fabrikantnr. —
reducer TP doorstroomsnelheid 8l/min blauw tolerantie ±20%			

			
1			
bestelnr.	370111	fabrikantnr.	E927001
omschrijving	magneetventiel dubbel recht 24VAC ingang 3/4" uitgang 11,5mm DN10 TP		
Reparatie-onderdelen voor	370111		
	bestelnr.	371035	fabrikantnr. —
	magneetspoel 24VAC		
Toebehoren voor	370111		
	bestelnr.	371220	fabrikantnr. —
	reducer TP doorstroomsnelheid 3l/min rood tolerantie ±15%		
	bestelnr.	371221	fabrikantnr. —
	reducer TP doorstroomsnelheid 5.5l/min geel tolerantie ±15%		
	bestelnr.	371222	fabrikantnr. —
	reducer TP doorstroomsnelheid 6l/min grijs tolerantie ±15%		
	bestelnr.	371223	fabrikantnr. —
	reducer TP doorstroomsnelheid 10l/min wit tolerantie ±15%		
	bestelnr.	371224	fabrikantnr. —
	reducer TP doorstroomsnelheid 12l/min brons tolerantie ±15%		
	bestelnr.	371225	fabrikantnr. —
	reducer TP doorstroomsnelheid 16l/min lichtbruin tolerantie ±15%		
	bestelnr.	371226	fabrikantnr. —
	reducer TP doorstroomsnelheid 20l/min rood tolerantie ±15%		
	bestelnr.	371230	fabrikantnr. —
	reducer TP doorstroomsnelheid 0.25l/min rood tolerantie ±25%		
	bestelnr.	371231	fabrikantnr. —
	reducer TP doorstroomsnelheid 0.35l/min violet tolerantie ±25%		
	bestelnr.	371232	fabrikantnr. —
	reducer TP doorstroomsnelheid 0.5l/min oranje tolerantie ±25%		
	bestelnr.	371233	fabrikantnr. —
	reducer TP doorstroomsnelheid 0.8l/min wit tolerantie ±25%		
	bestelnr.	371234	fabrikantnr. —
	reducer TP doorstroomsnelheid 1l/min lichtblauw tolerantie ±25%		
	bestelnr.	371235	fabrikantnr. —
	reducer TP doorstroomsnelheid 1.2l/min bruin tolerantie ±25%		
	bestelnr.	371236	fabrikantnr. —
	reducer TP doorstroomsnelheid 1.5l/min lichtbruin tolerantie ±25%		
	bestelnr.	371237	fabrikantnr. —
	reducer TP doorstroomsnelheid 2.5l/min geel tolerantie ±25%		

Toebehoren voor	370111		
	bestelnr.	371238	fabrikantnr. —
	reducer TP doorstroomsnelheid 3.4l/min donkergroen tolerantie ±25%		
	bestelnr.	371239	fabrikantnr. —
	reducer TP doorstroomsnelheid 5l/min zwart tolerantie ±25%		
	bestelnr.	371240	fabrikantnr. —
	reducer TP doorstroomsnelheid 8l/min blauw tolerantie ±20%		

magneetventielen met reducering

			
1			
bestelnr.	370245	fabrikantnr.	E927242
omschrijving	magneetventiel enkel recht 24VAC ingang 3/4" uitgang 11,5mm ingang 16l/min t.max. 90°C TP kunststof reducering ingang lichtbruin		

diversen

			
1			
bestelnr.	370641	fabrikantnr.	00-775897-001 775897-1
omschrijving	magneetventiel 220-240VAC uitgang 10mm kunststof ingang 10mm		
Voor modellen:	ECOMAX-402, ECOMAX-502, ECOMAX-602S-11, ECOMAX-612S-10, FX, FX-McDonalds		



metaal

ASCO

2-wegs



1

bestelnr.	370121	fabrikantnr.	173863
omschrijving	magneetventiel 2-weg 230VAC aansluiting 1/2" L 70mm nominale breedte 16mm steekbus DIN -20 tot +85°C Asco serie 210 (geforceerd verstuurd) spoeltype 400425-217 membraam NBR (water) p max. 9bar ventielset A		
Voor modellen:	102-G, 103G, 104G, 201G, 202-G, 203G, 204G, 205G, 2222, 2226, 2227, 2228, 301G, 302-G, 303G, 304G, 304T, 305G, AM-12E, AM-12EC, AM-12EF, AM-12ER, AM-600CR, AM-600R, UW-135, UW-135H		

magneetventielen stoom (water)

2-wegs



1

bestelnr.	370263	fabrikantnr.	00-168909-001 168909-1 2967951-1
omschrijving	magneetventiel 2-weg 230VAC ingang 3/4" uitgang 3/4" aansluiting 3/4" L 72mm nominale breedte 19mm steekbus DIN -20 tot +184°C Asco serie 222 (geforceerd gestuurd) spoeltype 400426-117 membraam PTFE (water/stoom) p max. 9bar ventielset H		
Voor modellen:	AM-600, AM-600C, AM-600CR, AM-600R, AMX, AMX-E, AMX-ER, AMX-R, AUX-, AUX-E, AUX-ER, AUX-R, UW-100, UW-105, UW-135, UW-135H, UX-30, UX-30B, UX-30E, UX-30EB, UX-30ES, UX-30ESB, UX-30S, UX-30SB, UX-60, UX-60B, UX-60E, UX-60EB		

reparatieonderdelen en toebehoren

sets



1

bestelnr.	371110	fabrikantnr.	173863-11
omschrijving	ventielinzet type A grootte 1/2" servicekit		
Voor modellen:	2226, 2227, AM-12E, AM-12EC, AM-12EF, AM-12ER, AM-600, AM-600C, AM-600CR, AM-600R		



1

bestelnr.	371143	fabrikantnr.	228894-1 228894-11
omschrijving	ventielinzet voor magneetventiel met toebehoren		

afvoerventielen



1

bestelnr.	370642	fabrikantnr.	00-774683-001 774683-1
omschrijving	afvoermagneetventiel 230V 50/60Hz enkel ingang 40mm uitgang 40mm 26 1-weg		
Voor modellen:	CN, CNA, CNB, CNR, CSA, EWB-S, FTN		



1

bestelnr.	370621	fabrikantnr.	323785-1 323785-11 378562-1
omschrijving	afvoermagneetventiel 230V 50Hz enkel ingang 17mm uitgang 17mm 11.5		
Voor modellen:	FE-W, FX, GX, HX, HX-30, HX-30E, HX-30ES, HX-30S, HX-40, HX-40E, HX-40ES, HX-40S, HX-60-EHL, HX-E, HX-ES, HX-S, UX-30ES, UX-30ESB, UX-30ESH, UX-30-McDonalds, UX-30S, UX-30SB, UX-30SH		



1

bestelnr.	370720	fabrikantnr.	323592-1
omschrijving	afvoermagneetventiel recht 230V 50/60Hz enkel ingang 17mm uitgang 19mm 10 kunststof		
Voor modellen:	AMX-ER, AMX-R, AUX-ER, AUX-R, CN, CNA, CNB, CNR, CR, CSA, FTN		



 <p>1</p>			
bestelnr.	370721	fabrikantnr.	323785-12 323785-2
omschrijving	afvoermagneetventiel recht 240V 50Hz enkel ingang 17mm uitgang 19mm 10 kunststof		
Voor modellen:	FE-W, FX, GX, HX, HX-30, HX-30E, HX-30ES, HX-30S, HX-40, HX-40E, HX-40ES, HX-40S, HX-60-EHL, HX-E, HX-ES, HX-S, UX-30ES, UX-30ESB, UX-30ESH, UX-30-McDonalds, UX-30S, UX-30SB, UX-30SH		

pressostaten

voor spoeltechniek

∅58mm met vlaksteker 6,3mm

met horizontale aansluiting

 <p>1</p>			
bestelnr.	541003	fabrikantnr.	139321-23 139321-833
omschrijving	pressostaat drukbereik 55/35mbar aansluiting 6mm ∅ 58mm drukaansluiting horizontaal spoeltechniek drukaansluiting ∅ 6mm		
Voor modellen:	GE-400, GF-60, GF-60S, GW-600, GW-600S, GW-601, GW-601S		

∅79mm met gecodeerde steker

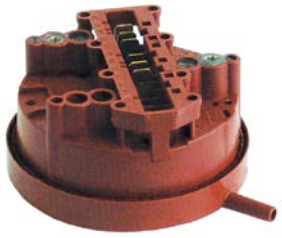
 <p>1</p>			
bestelnr.	541321	fabrikantnr.	231981-2 231981-6
omschrijving	pressostaat 2 drukbereiken drukbereik 35/20 80/60mbar aansluiting 6mm ∅ 79mm drukaansluiting horizontaal spoeltechniek passend voor HOBART drukaansluiting ∅ 6mm		
Voor modellen:	AMX, AMX-R, AUX, AUX_, AUX-R, CN, CNB, FTN, UX-30, UX-30B, UX-30H, UX-30-McDonalds, UX-30S, UX-30SB, UX-30SH, UX-60, UX-60B, UXD-30		

 <p>1</p>			
bestelnr.	541318 ¹	fabrikantnr.	378758-2 378758-6
omschrijving	pressostaat 2 drukbereiken drukbereik 35/25 80/60mbar aansluiting 6mm ∅ 79mm met goudcontact voor elektronische machines drukaansluiting horizontaal spoeltechniek passend voor HOBART drukaansluiting ∅ 6mm		
Voor modellen:	AMX-E, AMX-ER, AUX-E, AUX-ER, CN, CNB, FTN, UX-30E, UX-30EB, UX-30EH, UX-30ES, UX-30ESB, UX-30ESH, UX-30-McDonalds, UX-60E, UX-60EB		

¹met goudcontact voor elektronische sturingen

 <p>1</p>			
bestelnr.	541902 ¹	fabrikantnr.	378760-002 378760-2
omschrijving	pressostaat 3 drukbereiken drukbereik 145/120 230/200 280/250mbar aansluiting 6mm ∅ 79mm drukaansluiting horizontaal met goudcontact voor elektronische machines spoeltechniek		
Voor modellen:	CR, CR-F		

¹met goudcontact voor elektronische sturingen

 <p>1</p>			
bestelnr.	541904	fabrikantnr.	378758-8
omschrijving	pressostaat 3 drukbereiken drukbereik 145/120 260/230 385/350mbar aansluiting 6mm ∅ 79mm drukaansluiting horizontaal spoeltechniek drukaansluiting ∅ 6mm		
Voor modellen:	UX-30E, UX-30EB, UX-30EH, UX-30ES, UX-30ESB, UX-30ESH, UX-30-McDonalds		

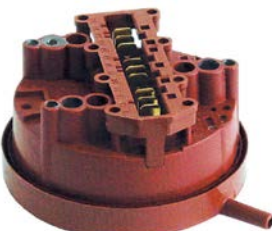

			
1			
bestelnr.	542151	fabrikantnr.	378760-6
omschrijving	pressostaat 3 drukbereiken drukbereik 40/25 57/37 125/105mbar aansluiting 6mm ø 78mm drukaansluiting horizontaal spoeltechniek drukaansluiting ø 6mm		
Voor modellen:	FX, GX		

			
1			
bestelnr.	541317 ¹	fabrikantnr.	378760-1 378760-3
omschrijving	pressostaat 3 drukbereiken drukbereik 40/25 57/42 125/105mbar aansluiting 6mm ø 79mm drukaansluiting horizontaal spoeltechniek passend voor HOBART		
Voor modellen:	AMX, AMX-R, AUX, AUX_, AUX-R, UXD-30		

¹met goudcontact voor elektronische sturingen

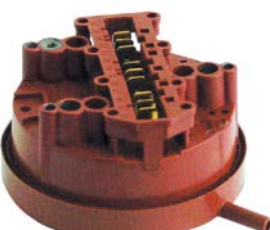
			
1			
bestelnr.	541320	fabrikantnr.	231981-1
omschrijving	pressostaat 3 drukbereiken drukbereik 40/25 57/37 125/105mbar aansluiting 6mm ø 79mm drukaansluiting horizontaal spoeltechniek passend voor HOBART drukaansluiting ø 6mm		
Voor modellen:	AM3, CR-F, FE, FX, GX, HE, HE600-HL, HE-P, HX, HX-30, HX-30E, HX-30S, HX-40, HX-40E, HX-40S, HX-S		

			
1			
bestelnr.	541782 ¹	fabrikantnr.	00-378758-005 378758-5
omschrijving	pressostaat 3 drukbereiken drukbereik 40/25 92/77 160/140mbar aansluiting 6mm ø 79mm drukaansluiting horizontaal met goudcontact voor elektronische machines spoeltechniek passend voor HOBART drukaansluiting ø 6mm		
Voor modellen:	AM-700, AM900, AMS900, AMX-900, AMXR-900, AMXS-900, AMXX-1300, AMXXR-1300, AMXXS-1300, AMXXT, AUXX-1300, AUXXL, AUXXR-1300, AUXXS-1300, AUXXT, ECOMAX-600, ECOMAX-650, ECOMAX-700, FE-W, UX, UX-30E, UX-30EB, UX-30EH, UX-30ES, UX-30ESB, UX-30ESH, UX-30-McDonalds, UX-60E, UX-60EB, UXL, UXLS, UXS, UXT, UXTH, UXTHL, UXTHLS, UXTHS, UXTL, UXTLH, UXTLHS, UXTLS, UXTS		

¹met goudcontact voor elektronische sturingen

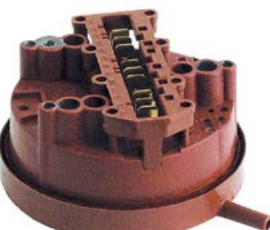
			
1			
bestelnr.	542136 ¹	fabrikantnr.	00-378758-001 378758-1
omschrijving	pressostaat 3 drukbereiken drukbereik 40/25 57/37 125/105mbar aansluiting 6mm ø 79mm drukaansluiting horizontaal spoeltechniek passend voor HOBART drukaansluiting ø 6mm		
Voor modellen:	FX, HX-30E, HX-30ES, HX-40E, HX-40ES, HX-60-EHL, HX-E, HX-ES		

¹met goudcontact voor elektronische sturingen

			
1			
bestelnr.	541319	fabrikantnr.	231981-3
omschrijving	pressostaat drukbereik 35/20mbar aansluiting 6mm ø 79mm drukaansluiting horizontaal spoeltechniek passend voor HOBART drukaansluiting ø 6mm		
Voor modellen:	FX, GX, HX, HX-30, HX-30E, HX-30S, HX-40, HX-40E, HX-40S, HX-S		

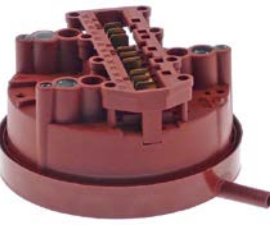
			
1			
bestelnr.	541316 ¹	fabrikantnr.	378758-4
omschrijving	pressostaat 3 drukbereiken drukbereik 40/25 57/42 125/105mbar aansluiting 6mm ø 79mm drukaansluiting horizontaal met goudcontact voor elektronische machines spoeltechniek		
Voor modellen:	AMX-E, AMX-ER, AUX-E, AUX-ER, FX, GX		

¹met goudcontact voor elektronische sturingen



			
1			
bestelnr.	541315 ¹	fabrikantnr.	378758-3
omschrijving	pressostaat drukbereik 35/20mbar aansluiting gecodeerde aansluiting ø 79mm drukaansluiting horizontaal met goudcontact voor elektronische machines speltechniek passend voor HOBART drukaansluiting ø 6mm		
Voor modellen:	FX, GC41, GC42, GX, HX-30E, HX-30ES, HX-40E, HX-40ES, HX-60-EHL, HX-E, HX-ES		

¹met goudcontact voor elektronische sturingen

drukkenders			
			
1			
bestelnr.	541149	fabrikantnr.	00-775866-202 775866-1
omschrijving	drukkender drukbereik 0-30mbar uitgangsspanning 0,5-3,5VDC ingangsspanning 5VDC max. 200mbar		
Voor modellen:	GC11, GC12, GC31, GC32, GC41, GC42		

			
1			
bestelnr.	541786	fabrikantnr.	00-775866-002 775866-02 775866-2
omschrijving	drukkender drukbereik 0-50mbar uitgangsspanning 0,5-3,5VDC ingangsspanning 5VDC max. 200mbar		
Voor modellen:	AM-10, AM-11, AM-141, AM900-10N, AM900-90, AMS900-10N, AMX, AMX-10HL, AMX-90, AMXR, AMXS, AMXT, AMXTS, AMXX, AMXXR, AMXXS, AUP, AUP-90, AUPS, AUXX, AUXXL-11N, AUXXLS-11N, AUXXR, AUXXS, AUXXT, AUXXTS, ECOMAX-402, ECOMAX-502, ECOMAX-602-10, ECOMAX-602-11, ECOMAX-602S-11, ECOMAX-612-10, ECOMAX-612S-10, FP, FX, FX-McDonalds, GP, GX		
Toebehoren voor	541786		
			00-324402-005 00-324402-014 139321-126 324402-14 324402-5
		bestelnr.	520027
		fabrikantnr.	
	PVC slang ID ø 4mm OD ø 7mm L 10m dikte 1.5mm t.max. 60°C transparant		

elektroden

			
1			
bestelnr.	361374	fabrikantnr.	299956-4
omschrijving	geleidbaarheids elektrode met draad		
Voor modellen:	AM-600, AM-600C, AM-600CR, AM-600R, FM-400H, FM-400U, FM-500, FM-500H, UW-105, UW-135, UW-135H, UW-55		

ventilatoren

axiaalventilatoren

Import

			
1			
bestelnr.	601080 ¹	fabrikantnr.	00-230324-001
omschrijving	axiaalventilator L 119mm B 119mm H 38mm 230VAC 50/60Hz 23/20W lager kogellager aansluiting vlaksteker 2,8mm metaal ADDA ventilatorblad ø 110mm temp. bestendigheids 70°C		
Toebehoren voor	601080		
		bestelnr.	550898
		fabrikantnr.	—
		bestelnr.	692519
		fabrikantnr.	—
	beschermrooster L 120mm B 120mm kunststof		

¹met kogellager



pompen







was- en naspoelpompen

FIR

pompen







1

bestelnr.	500598	fabrikantnr.	139321-490 E929167
omschrijving	pomp ingang ø 30mm uitgang ø 26mm type 5213E2450 230V 50Hz fasen 1 0.22kW 0.1PS L 190mm rotatierichting links condensator 5µF FIR		
Voor modellen:	CHH-50, CHH-60D, CHH-70D, EH-60, EH-70		
Reparatie-onderdelen voor	500598		
	bestelnr.	365017	fabrikantnr. 00-226568-009 01-235398 01-235399 139321-941 226568-9
	bedrijfscondensator capaciteit 5µF 450V bekercondensator tolerantie 5% 50/60Hz omgevingstemperatuur max. -25 tot +85°C ø 28mm L 54mm dubbele aansluiting M8 kunststof aansluiting vlaksteker 6,3mm 16.10.08 bescherming		
	bestelnr.	502265	fabrikantnr. 139321-976
	pompdeksel ingang ø 30mm uitgang ø 26mm ID ø 89mm binnenhoogte 35mm		
	bestelnr.	510695	fabrikantnr. —
	glijring dichting hoogte tegenring 5.5mm RVS/keramisch/EPDM ID ø 11mm		
	bestelnr.	521203	fabrikantnr. —
	pompschoep ø 72mm H 18mm draad M7 schacht ø 11mm schachtlengte 32mm messen 3		
	bestelnr.	532718	fabrikantnr. —
	O-ring EPDM materiaaldikte 4mm ID ø 80mm vpe 1stuk		
	bestelnr.	699372	fabrikantnr. —
	flens voor pomp met afdekking type 5213 L 103mm B 103mm H 69mm		







1

bestelnr.	499151	fabrikantnr.	01-240783-001 01-240783-1
omschrijving	pomp ingang ø 45mm uitgang ø 40mm type 3910.1421 230V 50Hz fasen 1 0.37kW 0.5PS L 190mm rotatierichting rechts condensator 10µF FIR		
Voor modellen:	ECOMAX-502		
Reparatie-onderdelen voor	499151		
	bestelnr.	365015	fabrikantnr. 00-226568-010 226568-10
	bedrijfscondensator capaciteit 10µF 400V bekercondensator tolerantie 5%Hz omgevingstemperatuur max. -25 tot +85°C ø 35.5mm L 59mm dubbele aansluiting M8 kunststof aansluiting vlaksteker 6,3mm bescherming		
	bestelnr.	510508	fabrikantnr. —
	pompdeksel FIR ingang ø 45mm uitgang ø 40mm pomptype PU 0,5/3911 draairichting rechts ø 160mm ID ø 125mm binnenhoogte 25mm		
	bestelnr.	510607	fabrikantnr. —
	pompschoep ø 85mm H 29mm asafname ø 9x8mm rotatierichting rechts messen 6		
	bestelnr.	510692	fabrikantnr. —
	glijring dichting voor schacht ø 11mm schuifring buiten ø 24mm schuifring H 13mm tegenring inbouw ø 26mm hoogte tegenring 8mm tegenring binnen ø 14mm RVS/keramisch/EPDM		
	bestelnr.	521702	fabrikantnr. —
	pompdeksel pakking materiaaldikte 3,5x4,5mm vpe 1stuk		



1

bestelnr.	500400	fabrikantnr.	774047-1
omschrijving	pomp ingang ø 45mm uitgang ø 40mm type 4255.1600 230V 50Hz fasen 1 0.55kW 0.75PS L 215mm rotatierichting rechts condensator 12.5µF FIR		
Voor modellen:	FE, HE, HE600-HL, HE-P		
Reparatie-onderdelen voor	500400		
	bestelnr.	365014	fabrikantnr. —
	bedrijfscondensator capaciteit 12.5µF 450V bekercondensator tolerantie 5%Hz omgevingstemperatuur max. -25 tot +85°C ø 35mm L 70mm dubbele aansluiting M8 kunststof aansluiting vlaksteker 6,3mm 45S.C3DS.12,5 bescherming		
	bestelnr.	510692	fabrikantnr. —
	glijring dichting voor schacht ø 11mm schuifring buiten ø 24mm schuifring H 13mm tegenring inbouw ø 26mm hoogte tegenring 8mm tegenring binnen ø 14mm RVS/keramisch/EPDM		
	bestelnr.	521210	fabrikantnr. —
	pompschoep ø 96mm H 30mm asafname ø 9/8mm afname ø 16mm messen 6		
	bestelnr.	521506	fabrikantnr. —
	pompdeksel FIR ingang ø 45mm uitgang ø 40mm draairichting rechts ø 160mm ID ø 125mm binnenhoopte 25mm		
	bestelnr.	521702	fabrikantnr. —
	pompdeksel pakking materiaaldikte 3,5x4,5mm vpe 1stuk		



1

bestelnr.	499356	fabrikantnr.	231936-1 775506-1 895499
omschrijving	pomp type 1314A1910 220/240V 50Hz fasen 1 0.55kW condensator 12.5µF FIR		
Voor modellen:	FE-W, FX, GX, HX, HX-30, HX-30E, HX-30ES, HX-30S, HX-40, HX-40E, HX-40ES, HX-40S, HX-60-EHL, HX-E, HX-ES, HX-S		
Toebehoren voor	499356		
	bestelnr.	511692	fabrikantnr. 139321-12 323894-12 734530-12 735530-12 896974
	glijring dichting set voor schacht ø 12mm OD ø 24mm H 15mm hoogte tegenring 8mm		



HANNING

pompen







1

bestelnr.	499094	fabrikantnr.	324913-1 324913-1V
omschrijving	pomp 220-240V ingang ø 28mm uitgang ø 26mm 50Hz type UP60-343 HANNING L 191mm rotatierichting links doorstroomsnelheid 110l/min p max. 0.48bar 0.22kW condensator 5µF fasen 1		
Voor modellen:	AMX, AMX-900, AMX-E, AMX-ER, AMX-R, AMXR-900, AMXS-900, AMXX-1300, AMXXR-1300, AMXXS-1300, AMXXT, AUX, AUX_, AUX-E, AUX-ER, AUX-R, AUXX-1300, AUXXL, AUXXR-1300, AUXXS-1300, AUXXT, UX, UX-30, UX-30B, UX-30E, UX-30EB, UX-30EH, UX-30H, UX-30-McDonalds, UX-60, UX-60B, UX-60E, UX-60EB, UX-60EH, UX-60EHB, UX-60H, UX-60HB, UXL, UXLS, UXS, UXT, UXTH, UXTHL, UXTHLS, UXTHS, UXTL, UXTLH, UXTLHS, UXTLS, UXTS		



1



bestelnr.	499147	fabrikantnr.	00-775854-001 775854-1
omschrijving	pomp ingang ø 28mm uitgang ø 26mm type UP30-324RU 220-240V 50Hz fasen 1 0.14kW L 170mm rotatierichting links condensator 4µF HANNING		
Voor modellen:	AM900-10N, AM900-90, AMS900-10N, AMX, AMX-10HL, AMX-90, AMXR, AMXS, AMXT, AMXTS, AMXX, AMXXR, AMXXS, AUP, AUP-90, AUPS, AUXX, AUXXL-11N, AUXXLS-11N, AUXXR, AUXXS, AUXXT, AUXXTS, ECOMAX-402, ECOMAX-502, ECOMAX-602-11, ECOMAX-602S-11, ECOMAX-612-10, ECOMAX-612S-10, FX, FX-McDonalds, GC41, GC42		
Reparatie-onderdelen voor	499147		
	bestelnr.	365031	fabrikantnr. 00-226568-002 226568-2
	bedrijfscondensator capaciteit 4µF 450V bekercondensator tolerantie 5% 50/60Hz omgevingstemperatuur max. -25 tot +85°C ø 31mm L 58mm dubbele aansluiting M8 kunststof aansluiting vlaksteker 6,3mm bescherming		

Reparatie-onderdelen voor	499147		
	bestelnr.	507558	fabrikantnr. —
	glijring dichting voor schacht ø 7mm hoogte tegenring 5mm ID ø 6.75mm OD ø 20mm inbouw ø tegenring 18,5/ glijring 20mm		
	bestelnr.	532644	fabrikantnr. —
	O-ring EPDM materiaaldikte 3mm ID ø 78mm vpe 1stuk		
Toebehoren voor	499147		
	bestelnr.	507498	fabrikantnr. 00-883837-001 883837-1
	beschermplaat voor waspomp passend voor HOBART L 300mm B 200mm		







1

bestelnr.	499213	fabrikantnr.	01-240234-101
omschrijving	pomp ingang ø 28mm uitgang ø 26mm type UP30-439Ru. 220-240V 50Hz fasen 1 0.14kW L 160mm rotatierichting links condensator 4µF HANNING		







1

bestelnr.	500534	fabrikantnr.	00-324093-021 324093-21
omschrijving	pomp ingang ø 28mm uitgang ø 26mm type UP60-184 230V 50Hz fasen 1 0.27kW 0.37PS L 190mm rotatierichting links condensator 5µF HANNING p max. 0.77bar Qmax. 160l/min		
Voor modellen:	AM3, AMX, AMX-900, AMX-E, AMX-ER, AMX-R, AMXR-900, AMXS-900, AMXX-1300, AMXXR-1300, AMXXS-1300, AMXXT, AUX, AUX_, AUX-E, AUX-ER, AUX-R, AUXX-1300, AUXXL, AUXXR-1300, AUXXS-1300, AUXXT, ECOMAX-402, ECOMAX-650, ECOMAX-700, UX, UXL, UXLs, UXS, UXT, UXTH, UXTHL, UXTHLS, UXTS, UXTL, UXTLH, UXTLHS, UXTLS, UXTS		
Reparatie-onderdelen voor	500534		
	bestelnr.	365017	fabrikantnr. 00-226568-009 01-235398 01-235399 139321-941 226568-9
	bedrijfscondensator capaciteit 5µF 450V bekercondensator tolerantie 5% 50/60Hz omgevingstemperatuur max. -25 tot +85°C ø 28mm L 54mm dubbele aansluiting M8 kunststof aansluiting vlakstekker 6,3mm 16.10.08 bescherming		
	bestelnr.	507558	fabrikantnr. —
	glijring dichting voor schacht ø 7mm hoogte tegenring 5mm ID ø 6.75mm OD ø 20mm inbouw ø tegenring 18,5/ glijring 20mm		
	bestelnr.	532644	fabrikantnr. —
	O-ring EPDM materiaaldikte 3mm ID ø 78mm vpe 1stuk		



1

bestelnr.	499068	fabrikantnr.	324093-1V
omschrijving	pomp ingang ø 28mm uitgang ø 26mm type UP60-313 230V 50Hz fasen 1 0.25kW 0.34PS L 190mm rotatierichting links condensator 5µF HANNING		
Reparatie-onderdelen voor	499068		
	bestelnr.	365017	fabrikantnr. 00-226568-009 01-235398 01-235399 139321-941 226568-9
	bedrijfscondensator capaciteit 5µF 450V bekercondensator tolerantie 5% 50/60Hz omgevingstemperatuur max. -25 tot +85°C ø 28mm L 54mm dubbele aansluiting M8 kunststof aansluiting vlakstekker 6,3mm 16.10.08 bescherming		
	bestelnr.	507558	fabrikantnr. —
	glijring dichting voor schacht ø 7mm hoogte tegenring 5mm ID ø 6.75mm OD ø 20mm inbouw ø tegenring 18,5/ glijring 20mm		
	bestelnr.	532644	fabrikantnr. —
	O-ring EPDM materiaaldikte 3mm ID ø 78mm vpe 1stuk		



1

bestelnr.	499149	fabrikantnr.	00-324093-021V 324093-21V
omschrijving	pomp ingang ø 28mm uitgang ø 26mm type UP60-315RU 220-240V 50Hz fasen 1 0.25kW L 185mm rotatierichting links condensator 5µF HANNING landen UK		
Reparatie-onderdelen voor	499149		
	bestelnr.	365017	fabrikantnr. 00-226568-009 01-235398 01-235399 139321-941 226568-9
	bedrijfscondensator capaciteit 5µF 450V bekercondensator tolerantie 5% 50/60Hz omgevingstemperatuur max. -25 tot +85°C ø 28mm L 54mm dubbele aansluiting M8 kunststof aansluiting vlakstekker 6,3mm 16.10.08 bescherming		
	bestelnr.	507558	fabrikantnr. —
	glijring dichting voor schacht ø 7mm hoogte tegenring 5mm ID ø 6.75mm OD ø 20mm inbouw ø tegenring 18,5/ glijring 20mm		



Tabel wordt vervolgd op de volgende pagina



Reparatie-onderdelen voor 499149			
	bestelnr.	532644	fabrikantnr. —
O-ring EPDM materiaaldikte 3mm ID ø 78mm vpe 1stuk			



bestelnr.	499284	fabrikantnr.	324914-1 324914-1V
omschrijving	pomp ingang ø 28mm uitgang ø 26mm type UP60-321 Ru. 220-240V 50Hz fasen 1 0.27kW L 190mm rotatierichting rechts condensator 5µF HANNING		
Voor modellen:	UX-30, UX-30B, UX-30E, UX-30EB, UX-30EH, UX-30ES, UX-30ESB, UX-30ESH, UX-30H, UX-30-McDonalds, UX-30S, UX-30SB, UX-30SH, UX-60, UX-60B, UX-60E, UX-60EB, UX-60EH, UX-60EHB, UX-60H, UX-60HB		

Reparatie-onderdelen voor 499284			
	bestelnr.	365017	fabrikantnr. 00-226568-009 01-235398 01-235399 139321-941 226568-9
bedrijfscondensator capaciteit 5µF 450V bekercondensator tolerantie 5% 50/60Hz omgevingstemperatuur max. -25 tot +85°C ø 28mm L 54mm dubbele aansluiting M8 kunststof aansluiting vlaksteker 6,3mm 16.10.08 bescherming			
	bestelnr.	507558	fabrikantnr. —
glijring dichting voor schacht ø 7mm hoogte tegenring 5mm ID ø 6.75mm OD ø 20mm inbouw ø tegenring 18,5/ glijring 20mm			
	bestelnr.	532644	fabrikantnr. —
O-ring EPDM materiaaldikte 3mm ID ø 78mm vpe 1stuk			



bestelnr.	499112	fabrikantnr.	774908-108 774908-108V
omschrijving	pomp ingang ø 32,5mm uitgang ø 1" type UP60-341 Ru 220-240/380-415V 50/60Hz 0.16kW HANNING zonder ventilatorblad p max. 0.68bar Qmax. 160l/min		



bestelnr.	499000	fabrikantnr.	781237 781237-1 781237-1V
omschrijving	pomp ingang ø 32mm uitgang ø 1" type UP60-334 230V 50Hz fasen 1 0.24kW L 250mm rotatierichting links condensator 5µF HANNING p max. 0.35bar Qmax. 85l/min		
Voor modellen:	CN, CNA, CNB, CNR, CR, CR-F, CSA, FTN		



1

bestelnr.	499040	fabrikantnr.	781237-2
omschrijving	pomp ingang ø 32mm uitgang ø 1" type UP60-335 230V 50Hz fasen 1 0.27kW L 250mm rotatierichting links condensator 5µF HANNING p max. 0.68bar Qmax. 160l/min		
Voor modellen:	CNA, CNB, CNR, CR-F, CSA, FTN		





1

bestelnr.	499092	fabrikantnr.	775465-1 897929
omschrijving	pomp ingang ø uitgang ø 26mm type 220-240V 50Hz fasen 1 0.1kW L 135mm condensator 4µF p max. 0.55bar HANNING flens ø 92mm doorstroomsnelheid 45l/min		
Voor modellen:	AM900, AMS900, FX, GC, GC31, GC32, GC41, GC42, GX		
Toebehoren voor	499092		
	bestelnr.	fabrikantnr.	510427 775465-11
	O-ring EPDM materiaaldikte 3mm ID ø 83mm vpe 1stuk		

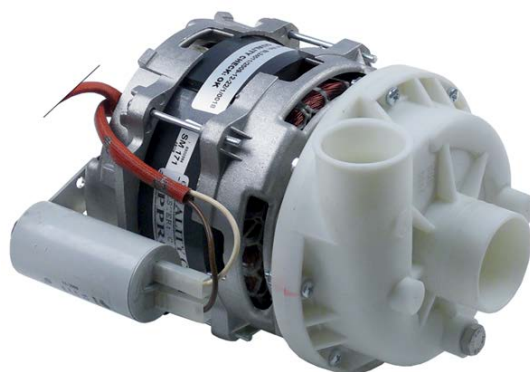

LGB









1

bestelnr.	499150	fabrikantnr.	00-883833-001 883833-1
omschrijving	pomp ingang ø 45mm uitgang ø 40mm type ZF220SX 230V 50Hz fasen 1 0.4kW L 190mm rotatierichting rechts condensator 12.5µF LGB		
Voor modellen:	AM-10, AM-11, AM-141, ECOMAX-602-10, ECOMAX-602-11, ECOMAX-602S-11		
Reparatie-onderdelen voor	499150		
	bestelnr.	fabrikantnr.	521036 00-883833-010 883833-10
	service kit voor pomp type ZF220SX HOBART 50Hz ventilatorblad, pompdekselpakking, glijringpakking		
Toebehoren voor	499150		
	bestelnr.	fabrikantnr.	365014 —
	bedrijfscondensator capaciteit 12.5µF 450V bekercondensator tolerantie 5%Hz omgevingstemperatuur max. -25 tot +85°C ø 35mm L 70mm dubbele aansluiting M8 kunststof aansluiting vlaksteker 6,3mm 45S.C3DS.12,5 bescherming		



bestelnr.	500543	fabrikantnr.	130126 139321-512 E130126
omschrijving	pomp ingang ø 50mm uitgang ø 50mm type ZF400VSX 230V 50Hz fasen 1 0.85kW 1.2PS L 245mm rotatierichting rechts condensator 16µF LGB		
Voor modellen:	ECOMAX-500		
Reparatie-onderdelen voor	500543		
	bestelnr.	365021	fabrikantnr. 00-226568-013 139321-448 139321-884 226568-13
	bedrijfscondensator capaciteit 16µF 425V bekercondensator tolerantie 5% 50/60Hz omgevingstemperatuur max. -25 tot +85°C ø 35mm L 73mm enkel M8 kunststof aansluiting vlaksteker 6,3mm 416.10.99 bescherming		
	bestelnr.	509020	fabrikantnr. 139321-509
	pomschoep ø 104mm H 25mm M8L		
	bestelnr.	510703	fabrikantnr. 139321-446
	glijring dichting voor schacht ø 13mm schuifring H 13mm hoogte tegenring 5.5mm RVS/keramisch/EPDM OD ø 26mm		
	bestelnr.	521548	fabrikantnr. 139321-889
	pompdeksel LGB ingang ø 50mm uitgang ø 50mm		
	bestelnr.	521734	fabrikantnr. 139321-887
	pompdekseldeel		
	bestelnr.	532623	fabrikantnr. —
	O-ring EPDM materiaaldikte 2.62mm ID ø 120.32mm vpe 1stuk		



bestelnr.	500361	fabrikantnr.	139321-548 139321-963
omschrijving	pomp ingang ø 60mm uitgang ø 49mm type ZF400SX 230V 50Hz fasen 1 0.8kW 1PS L 210mm rotatierichting rechts condensator 16µF LGB		
Voor modellen:	CHH-50		
Reparatie-onderdelen voor	500361		
	bestelnr.	365021	fabrikantnr. 00-226568-013 139321-448 139321-884 226568-13
	bedrijfscondensator capaciteit 16µF 425V bekercondensator tolerantie 5% 50/60Hz omgevingstemperatuur max. -25 tot +85°C ø 35mm L 73mm enkel M8 kunststof aansluiting vlaksteker 6,3mm 416.10.99 bescherming		
	bestelnr.	509020	fabrikantnr. 139321-509
	pomschoep ø 104mm H 25mm M8L		
	bestelnr.	510703	fabrikantnr. 139321-446
	glijring dichting voor schacht ø 13mm schuifring H 13mm hoogte tegenring 5.5mm RVS/keramisch/EPDM OD ø 26mm		
	bestelnr.	521547	fabrikantnr. —
	pompdeksel LGB ingang ø 60mm uitgang ø 50mm hulpdruk M8 draairichting rechts ø 160mm ID ø 127mm binnenhoogte 36mm		
	bestelnr.	521736	fabrikantnr. —
	pompdekseldeel onderdeel		
	bestelnr.	532623	fabrikantnr. —
	O-ring EPDM materiaaldikte 2.62mm ID ø 120.32mm vpe 1stuk		
Toebehoren voor	500361		
	bestelnr.	513264	fabrikantnr. —
	bevestigingshaak voor waspomp		



1

bestelnr.	499114	fabrikantnr.	898253-1
omschrijving	pomp ingang ø 60mm uitgang ø 50mm 220-240V 50Hz fasen 1 0.7kW L 245mm rotatierichting rechts condensator 16µF		
Voor modellen:	AM-700, AM900, AMS900, AMX-900, AMXR-900, AMXS-900, ECOMAX-600, ECOMAX-650		
Reparatie-onderdelen voor	499114		
	bestelnr.	365021	fabrikantnr. 139321-448 139321-884 226568-13
			00-226568-013
	bedrijfscondensator capaciteit 16µF 425V bekercondensator tolerantie 5% 50/60Hz omgevingstemperatuur max. -25 tot +85°C ø 35mm L 73mm enkel M8 kunststof aansluiting vlaksteker 6,3mm 416.10.99 bescherming		
	bestelnr.	509020	fabrikantnr. 139321-509
	pompschoep ø 104mm H 25mm M8L		
	bestelnr.	510703	fabrikantnr. 139321-446
	glijring dichting voor schacht ø 13mm schuifring H 13mm hoogte tegenring 5.5mm RVS/keramisch/EPDM OD ø 26mm		
	bestelnr.	521049	fabrikantnr. 898253-10
	service kit voor pomp type ZF400VSX LGB ven.blad, 2x o-ring, glijringpakking, condensator capaciteit 16µF		
	bestelnr.	521547	fabrikantnr. —
	pompeksel LGB ingang ø 60mm uitgang ø 50mm hulpdruk M8 draairichting rechts ø 160mm ID ø 127mm binnenhoogte 36mm		
	bestelnr.	532623	fabrikantnr. —
	O-ring EPDM materiaaldikte 2.62mm ID ø 120.32mm vpe 1stuk		

OLYMPIA

pompen



1

bestelnr.	500535	fabrikantnr.	371450-2
omschrijving	pomp ingang ø uitgang ø 27mm type T70 230V 50Hz fasen 1 0.3kW 0.4PS L 130mm rotatierichting rechts condensator 6.3µF OLYMPIA		
Voor modellen:	GF-60, GF-60S		
Reparatie-onderdelen voor	500535		
	bestelnr.	365012	fabrikantnr. 206009
	bedrijfscondensator capaciteit 6.3µF 450V bekercondensator tolerantie 5% 50Hz omgevingstemperatuur max. -25 tot +85°C ø 30mm L 61mm M8 kunststof aansluiting vlaksteker 6,3mm bescherming		
	bestelnr.	510556	fabrikantnr. —
	O-ring EPDM materiaaldikte 1.78mm ID ø 94.97mm vpe 1stuk pomptype T110		
	bestelnr.	510693	fabrikantnr. 139321-12
	glijring dichting voor schacht ø 12mm schuifring buiten ø 24mm schuifring H 15.5mm schuifring binnen ø 11mm tegenring inbouw ø 24mm hoogte tegenring 8mm tegenring binnen ø 13.5mm RVS/keramisch/EPDM		
	bestelnr.	521254	fabrikantnr. —
	pompschoep ø 81mm H 11mm draad M8L schacht ø 12mm schachtlengte 28mm messen 6		

waspompmotoren



1



bestelnr.	499106	fabrikantnr.	324818-34
omschrijving	pompmotor type 1326 1500W 220-240/380-415V 50/60Hz fasen 3 L 330mm B 200mm H 240mm 1400/1700U/min schacht ø 22/25mm		
Voor modellen:	CR-F		



drukverhogingspompen I



1

bestelnr.	500359	fabrikantnr.	139321-651 139321-661
omschrijving	pomp ingang ø 12 uitgang ø 12 type PPL46DX 230V 50Hz 0.33kW condensator 10µF LGB		
Voor modellen:	CHF45, CLG-25, EF-40		
Reparatie-onderdelen voor	500359		
	bestelnr.	698663	fabrikantnr. —
	pompschoep ø 60mm H 12mm met groef asafname ø 12mm B 60mm passend voor LGB		
Toebehoren voor	500359		
	bestelnr.	365015	fabrikantnr. 00-226568-010 226568-10
	bedrijfscondensator capaciteit 10µF 400V bekercondensator tolerantie 5%Hz omgevingstemperatuur max. -25 tot +85°C ø 35.5mm L 59mm dubbele aansluiting M8 kunststof aansluiting vlakstekker 6,3mm bescherming		



1

bestelnr.	500358	fabrikantnr.	139321-1085
omschrijving	pomp ingang ø 3/8" uitgang ø 3/8" type PS46 230V 50Hz 0.45kW ø 100mm L 200mm condensator 10µF LGB		
Reparatie-onderdelen voor	500358		
	bestelnr.	510713	fabrikantnr. —
	loopring voor schacht ø 12mm OD ø 24mm H 16mm		
	bestelnr.	510723	fabrikantnr. —
	tegenring H 8mm OD ø 26mm ID ø 13.5mm voor glijringpakking		
	bestelnr.	698400	fabrikantnr. —
	pompeksel pakking pomptype PS46 materiaaldikte 2mm ID ø 66mm vpe 1stuk		
Toebehoren voor	500358		
	bestelnr.	365015	fabrikantnr. 00-226568-010 226568-10
	bedrijfscondensator capaciteit 10µF 400V bekercondensator tolerantie 5%Hz omgevingstemperatuur max. -25 tot +85°C ø 35.5mm L 59mm dubbele aansluiting M8 kunststof aansluiting vlakstekker 6,3mm bescherming		
	bestelnr.	511279	fabrikantnr. —
	slangaansluiting koper recht draad 3/8" slang ø 12mm vpe 1stuk		
	bestelnr.	520202	fabrikantnr. —
	slangaansluiting messing vernikkeld recht draad 3/8" slang ø 12mm vpe 1stuk		

Toebehoren voor	500358		
	bestelnr.	520677	fabrikantnr. —
	slangaansluiting koper recht draad 3/8" slang ø 13mm vpe 1stuk		

afvoerpompen

ASKOLL



1

bestelnr.	500210	fabrikantnr.	E130123
omschrijving	afvoerpomp 230V 40W		



1

bestelnr.	501541	fabrikantnr.	139321-1110
omschrijving	afvoerpomp 40W 220-240V ingang ø 30mm uitgang ø 22mm 50Hz ASKOLL type M231 XP		
Voor modellen:	CHH-50, CHH-60D, CHH-70D, EH-60, EH-70		



1

bestelnr.	500346	fabrikantnr.	130105
omschrijving	afvoerpomp ingang ø 30mm uitgang ø 22mm 230V 40W 50Hz ASKOLL type M231 XP met houder		

GRE



1

bestelnr.	500212	fabrikantnr.	371450-1
omschrijving	afvoerpomp ingang ømm uitgang ømm 100W 230V 50Hz GRE zonder deksel		
Voor modellen:	GF-60, GF-60S		

HANNING



1

bestelnr.	502290	fabrikantnr.	00-775854-003 775854-3
omschrijving	afvoerpomp 140-160W 220-240V ingang ø 28mm uitgang ø 26mm 50-60Hz type UP30-420 HANNING aansluiting gecodeerde aansluiting p max. 0.65bar Qmax. 115l/min		
Voor modellen:	AMXR, AMXXR, AUXXR		



1

bestelnr.	499319	fabrikantnr.	01-240010-001 01-240010-1
omschrijving	afvoerpomp 65W 230V ingang ømm uitgang ømm 50Hz type BE20B2-083 HANNING zonder deksel		
Voor modellen:	FP, FX, FX-McDonalds, GP, GX		



1

bestelnr.	499148	fabrikantnr.	00-165653-001 00-883993-001 165653-1 883993-1
omschrijving	afvoerpomp 80W 220-240V ingang ø 24mm uitgang ø 24mm 50Hz type BE22B3-197 HANNING rotatierichting rechts		
Voor modellen:	AM-600, AM-600C, AM-600CR, AM-600R, AM-700, AM900, AM900-10N, AM900-90, AMS900, AMS900-10N, AMX, AMX-10HL, AMX-90, AMXR, AMXS, AMXT, AMXTS, AMXX, AMXXR, AMXXS, AUP, AUP-90, AUPS, AUXX, AUXXL-11N, AUXXLS-11N, AUXXR, AUXXS, AUXXT, AUXXTS, ECOMAX-600, ECOMAX-602S-11, ECOMAX-612-10, ECOMAX-612S-10, ECOMAX-650, ECOMAX-700, FE, FM-30U, GC, GC11, GC12, GC31, GC32, GC41, GC42, HE, HE600-HL, HE-P, UW-105, UW-55		

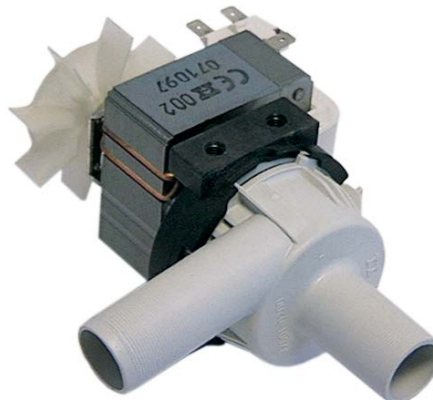

1

bestelnr.	500042	fabrikantnr.	165653-1 old version
omschrijving	afvoerpomp 80W 230V ingang ø 24mm uitgang ø 24mm 50Hz type KD22B3-679 HANNING		
Reparatie-onderdelen voor	500042		
	bestelnr.	fabrikantnr.	—
	ventilatorblad asafname ø 5mm ø 62mm H 14mm		



bestelnr.	499094	fabrikantnr.	324913-1 324913-1V
omschrijving	pomp 220-240V ingang ø 28mm uitgang ø 26mm 50Hz type UP60-343 HANNING L 191mm rotatierichting links doorstroomsnelheid 110l/min p max. 0.48bar 0.22kW condensator 5µF fasen 1		
Voor modellen:	AMX, AMX-900, AMX-E, AMX-ER, AMX-R, AMXR-900, AMXS-900, AMXX-1300, AMXXR-1300, AMXXS-1300, AMXXT, AUX, AUX_, AUX-E, AUX-ER, AUX-R, AUXX-1300, AUXXL, AUXXR-1300, AUXXS-1300, AUXXT, UX, UX-30, UX-30B, UX-30E, UX-30EB, UX-30EH, UX-30H, UX-30-McDonalds, UX-60, UX-60B, UX-60E, UX-60EB, UX-60EH, UX-60EHB, UX-60H, UX-60HB, UXL, UXLs, UXS, UXT, UXTH, UXTHL, UXTHLS, UXTHS, UXTL, UXTLH, UXTLHS, UXTLS, UXTS		

Reparatie-onderdelen voor 499094

	bestelnr.	365017	fabrikantnr.	00-226568-009 01-235398 01-235399 139321-941 226568-9
				bedrijfscondensator capaciteit 5µF 450V bekercondensator tolerantie 5% 50/60Hz omgevingstemperatuur max. -25 tot +85°C ø 28mm L 54mm dubbele aansluiting M8 kunststof aansluiting vlakstekker 6,3mm 16.10.08 bescherming

drukverhogingspompen II

toebehoren



bestelnr.	365015	fabrikantnr.	00-226568-010 226568-10
omschrijving	bedrijfscondensator capaciteit 10µF 400V bekercondensator tolerantie 5%Hz omgevingstemperatuur max. -25 tot +85°C ø 35.5mm L 59mm dubbele aansluiting M8 kunststof aansluiting vlakstekker 6,3mm bescherming		



bestelnr.	365017	fabrikantnr.	00-226568-009 01-235398 01-235399 139321-941 226568-9
omschrijving	bedrijfscondensator capaciteit 5µF 450V bekercondensator tolerantie 5% 50/60Hz omgevingstemperatuur max. -25 tot +85°C ø 28mm L 54mm dubbele aansluiting M8 kunststof aansluiting vlakstekker 6,3mm 16.10.08 bescherming		
Voor modellen:	AMX, AMX-900, AMX-E, AMX-ER, AMX-R, AMXR-900, AMXS-900, AMXX-1300, AMXXR-1300, AMXXS-1300, AMXXT, AUX, AUX_, AUX-E, AUX-ER, AUX-R, AUXX-1300, AUXXL, AUXXR-1300, AUXXS-1300, AUXXT, CHH-70D, ECOMAX-402, ECOMAX-650, ECOMAX-700, EH-70, FE, FE-W, FX, GX, HX-30, HX-30E, HX-30ES, HX-30S, HX-40, HX-40E, HX-40ES, HX-40S, UX, UX-30, UX-30B, UX-30E, UX-30EB, UX-30EH, UX-30ES, UX-30ESB, UX-30H, UX-30-McDonalds, UX-30S, UX-30SB... (Andere modellen die u kunt zien in de webshop)		

toebehoren

pompdekselpakkingen



bestelnr.	524923	fabrikantnr.	00-119038-00003 00-135127-004 119038-3 135127-4
omschrijving	pompdeksel pakking Tesnit BA-50 materiaaldikte 1mm ID ø 135mm vpe 1stuk		
Voor modellen:	AM-12E, AM-12EC, AM-12EF, AM-12ER, AM-600, AM-600C, AM-600CR, AM-600R, UW-100, UW-105, UW-120, UW-125, UW-200, UW-205		

condensatoren & ontstoringsfilters

bedrijfscondensatoren

kunststof



bestelnr.	365015	fabrikantnr.	00-226568-010 226568-10
omschrijving	bedrijfscondensator capaciteit 10µF 400V bekercondensator tolerantie 5%Hz omgevingstemperatuur max. -25 tot +85°C ø 35.5mm L 59mm dubbele aansluiting M8 kunststof aansluiting vlakstekker 6,3mm bescherming		



			
1			
bestelnr.	365021	fabrikantnr.	00-226568-013 139321-448 139321-884 226568-13
omschrijving	bedrijfscondensator capaciteit 16µF 425V bekercondensator tolerantie 5% 50/60Hz omgevingstemperatuur max. -25 tot +85°C ø 35mm L 73mm enkel M8 kunststof aansluiting vlaksteker 6,3mm 416.10.99 bescherming		
Voor modellen:	AM-700, AM900, AM900-10N, AM900-90, AMS900, AMS900-10N, AMX, AMX-10HL, AMX-90, AMX-900, AMXR, AMXR-900, AMXS, AMXS-900, AMXT, AMXTS, CHF45, ECOMAX-600, ECOMAX-612-10, ECOMAX-612S-10, ECOMAX-650, EF-40		

			
1			
bestelnr.	365031	fabrikantnr.	00-226568-002 226568-2
omschrijving	bedrijfscondensator capaciteit 4µF 450V bekercondensator tolerantie 5% 50/60Hz omgevingstemperatuur max. -25 tot +85°C ø 31mm L 58mm dubbele aansluiting M8 kunststof aansluiting vlaksteker 6,3mm bescherming		

			
1			
bestelnr.	365017	fabrikantnr.	00-226568-009 01-235398 01-235399 139321-941 226568-9
omschrijving	bedrijfscondensator capaciteit 5µF 450V bekercondensator tolerantie 5% 50/60Hz omgevingstemperatuur max. -25 tot +85°C ø 28mm L 54mm dubbele aansluiting M8 kunststof aansluiting vlaksteker 6,3mm 16.10.08 bescherming		
Voor modellen:	AMX, AMX-900, AMX-E, AMX-ER, AMX-R, AMXR-900, AMXS-900, AMXX-1300, AMXXR-1300, AMXXS-1300, AMXXT, AUX, AUX_, AUX-E, AUX-ER, AUX-R, AUXX-1300, AUXXL, AUXXR-1300, AUXXS-1300, AUXXT, CHH-70D, ECOMAX-402, ECOMAX-650, ECOMAX-700, EH-70, FE, FE-W, FX, GX, HX-30, HX-30E, HX-30ES, HX-30S, HX-40, HX-40E, HX-40ES, HX-40S, UX, UX-30, UX-30B, UX-30E, UX-30EB, UX-30EH, UX-30ES, UX-30ESB, UX-30H, UX-30-McDonalds, UX-30S, UX-30SB... (Andere modellen die u kunt zien in de webshop)		

			
1			
bestelnr.	365167	fabrikantnr.	226568-3
omschrijving	condensator capaciteit 6µF 450V bekercondensator tolerantie 5% 50Hz omgevingstemperatuur max. -25 tot +85°C ø 30mm L 58mm M8 kunststof aansluiting vlaksteker 6,3mm		
Voor modellen:	FE, G10R, G5R, HE-P, HX, HX-60-EHL, HX-E, HX-ES, HX-S, UX-30, UX-30B, UX-30E, UX-30EB, UX-30EH, UX-30ES, UX-30ESB, UX-30ESH, UX-30H, UX-30-McDonalds, UX-30S, UX-30SB, UX-30SH, UX-60, UX-60B, UX-60E, UX-60EB, UX-60EH, UX-60EHB, UX-60H, UX-60HB		

filters

ontstoringsfilters

			
1			
bestelnr.	365044	fabrikantnr.	926144 E926144
omschrijving	ontstoringsfilter type FC701Y2F 250V 50-60Hz geleider 2 met PE aansluiting kabel 200mm L 42mm ø 23mm Hmm Bmm kunststof vpe 1stuk		

zekeringen

glaszekeringen

			
1			
bestelnr.	358666	fabrikantnr.	926283 E926283
omschrijving	fijnzekering grootte ø5x20mm 0.315A snel maximale spanning 250V vpe 10stuk		

			
1			
bestelnr.	358606	fabrikantnr.	228010 E228010
omschrijving	fijnzekering grootte ø5x20mm 4A traag maximale spanning 250V vpe 10stuk		

			
1			
bestelnr.	358742	fabrikantnr.	775570-2
omschrijving	fijnzekering grootte ø6,3x32mm 0.8A snel maximale spanning 500V vpe 10stuk		

			
1			
bestelnr.	358751	fabrikantnr.	00-775570-001 775570-1
omschrijving	fijnzekering grootte ø6,3x32mm 6.3A snel maximale spanning 500V vpe 10stuk		
Voor modellen:	AMX-900, AMXS-900, AMXX-1300, AMXXT, AUXX-1300, AUXXT, ECOMAX-650, UX, UXL, UXLS, UXS, UXT, UXTH, UXTHL, UXTHLS, UXTHS, UXTL, UXTLS, UXTS		



glaszekeringhouders

			
1			
bestelnr.	358026	fabrikantnr.	00-775548-001 775548-1
omschrijving	zekeringhouder passende zekering ø6,3x32mm 10A maximale spanning 800V L 61mm B 10mm H 65mm doorsnede 4mm ²		
Voor modellen:	AMX-900, AMXS-900, AMXX-1300, AMXXT, AUXX-1300, AUXXT, ECOMAX-402, ECOMAX-502, ECOMAX-650, UX, UXL, UXLS, UXS, UXT, UXTH, UXTHL, UXTHLS, UXTHS, UXTL, UXTLS, UXTS		

			
1			
bestelnr.	524663	fabrikantnr.	00-695661-005 695661-5
omschrijving	kabelwartel draad M32 kabel ø 21mm inbouw ø 32mm vpe 1stuk kunststof SB 42		
Voor modellen:	AM-10, AM-11, AM-141, AM-700, AM900-10N, AM900-90, AMS900-10N, AMX, AMX-10HL, AMX-90, AMX-900, AMXR, AMXR-900, AMXS, AMXS-900, AMXT, AMXTS, AMXX, AMXX-1300, AMXXR, AMXXR-1300, AMXXS, AMXXS-1300, AMXXT, AUP, AUP-90, AUPS, AUXX, AUXX-1300, AUXXL, AUXXL-11N, AUXXLS-11N, AUXXR, AUXXR-1300, AUXXS, AUXXS-1300, AUXXT, AUXXTS, ECOMAX-600, ECOMAX-602-10, ECOMAX-602-11, ECOMAX-602S-11, ECOMAX-612-10, ECOMAX-612S-10, ECOMAX-650, ECOMAX-700, UX, UXL, UXLS, UXS...(Andere modellen die u kunt zien in de webshop)		

elektra toebehoren

kabels

toebehoren

kabeldoorvoeringen

kabeldoorvoeringen

			
1			
bestelnr.	551102	fabrikantnr.	00-227748-001 227748-1
omschrijving	kabeldoorvoer tule ID ø 10mm inbouw ø 12mm neopreen -30 tot +120°C vpe 1stuk		
Voor modellen:	AM-10, AM-11, AM-141, AM-600, AM-600C, AM-600CR, AM-600R, AM900-10N, AM900-90, AMS900-10N, AMX, AMX-10HL, AMX-90, AMX-E, AMX-ER, AMXR, AMX-R, AMXS, AMXT, AMXTS, AMXX, AMXXR, AMXXS, AUP, AUP-90, AUPS, AUX, AUX_, AUX-E, AUX-ER, AUX-R, AUXX, AUXXL-11N, AUXXLS-11N, AUXXR, AUXXS, AUXXT, AUXXTS, CN-Protronic, CN-Smartronic, CP-Protronic, CS-Easytronic, CX, ECOMAX-602-10, ECOMAX-602-11, ECOMAX-602S-11, ECOMAX-612-10, ECOMAX-612S-10, FM-30, FM-30U...(Andere modellen die u kunt zien in de webshop)		

vlakbandkabels

groep 1

			
1			
bestelnr.	402970	fabrikantnr.	139321-1011
omschrijving	vlakbandkabel 10-polig L 1200mm stekertype 2-rijen gecodeerd VPE 1m		

klemmen

aansluitklemmen met schroef-steekcontacten

			
1			
bestelnr.	550411	fabrikantnr.	139321-582 774055-1
omschrijving	netaansluitingsklem 6-polig max. 40A max. spanning 450V aansluiting ø6mm ² / F6,3 temp. bestendigheid 150°C doorsnede 6mm ²		
Voor modellen:	AMX-900, AMXS-900, AMXX-1300, AMXXT, AUXX-1300, AUXXT, CHF45, CHH-50, CHH-60D, CHH-70D, ECOMAX-650, EF-40, EH-60, EH-70, FE, FE-W, FX, GC, GC11, GC12, GC31, GC32, GC41, GC42, GX, HE, HE600-HL, HE-P, UX, UXL, UXLS, UXS, UXT, UXTH, UXTHL, UXTHLS, UXTHS, UXTL, UXTLS, UXTS		

kabelschroefnippels

schroefnippels

			
1			
bestelnr.	524662	fabrikantnr.	00-695661-004 695661-4
omschrijving	kabelwartel draad M25 kabel ø 16mm inbouw ø 25mm vpe 1stuk kunststof SB 33		
Voor modellen:	ECOMAX-402, ECOMAX-502		

schakelkasten

			
1			
bestelnr.	524664	fabrikantnr.	00-229169-007 229169-7
omschrijving	pakking voor schakeldoos L 415mm B 12mm sponsrubber		
Voor modellen:	AM-10, AM-11, AM-141, AM900-10N, AM900-90, AMS900-10N, AMX, AMX-10HL, AMX-90, AMXR, AMXS, AMXT, AMXTS, AMXX, AMXXR, AMXXS, AUP, AUP-90, AUPS, AUXX, AUXXL-11N, AUXXLS-11N, AUXXR, AUXXS, AUXXT, AUXXTS, ECOMAX-602-10, ECOMAX-602-11, ECOMAX-602S-11, ECOMAX-612-10, ECOMAX-612S-10, RRB		



elektronische componenten

Inverter

			
1			
bestelnr.	402902	fabrikantnr.	916894
omschrijving	omvormer 200-240V passend voor HOBART		

apparaatspecifieke bouwdeelen

broeigroepen

zeefhouder pakkingen

o-ringen

			
1			
bestelnr.	510409	fabrikantnr.	00-276903-053 00-67500-016 00-67500-118 276903-53 670500-118 67500-16
omschrijving	O-ring EPDM materiaaldikte 5.34mm ID ø 56.52mm vpe 1stuk		
Voor modellen:	CR-F, CX, ECW, EWB-S, FTN, FTT, FTX, FUX, ML-104674, ML-104683, ML-104686, UW-135, UW-135H, UWX, UX-60, UX-60B, UX-60E, UX-60EB, UX-60EH, UX-60EHB, UX-60H, UX-60HB, UXT, UXTH, UXTHL, UXTHLS, UXTHS, UXTL, UXTLH, UXTLHS, UXTLS, UXTS, V1401		

voor vaatwassers

afvoer-/toevoercomponenten

HOBART

afvoer-/toevoerlichamen

			
1			
bestelnr.	517404	fabrikantnr.	00-323802-001 323802-1
omschrijving	aanzuigdeel OD ø 105mm H 110mm ID ø 75mm slang ø 31mm		
Voor modellen:	CR, CR-F, ECOMAX-402, ECOMAX-502, FE, GC, GC11, GC12, GC31, GC32, GC41, GC42, HE, HE600-HL, HE-P		

			
1			
bestelnr.	518064	fabrikantnr.	139321-912
omschrijving	aanzuigdeel OD ø 140mm ID ø 102mm slang ø 50/60mm		
Voor modellen:	CHH-50, CHH-60D, CHH-70D, EH-60, EH-70		

			
1			
bestelnr.	524907	fabrikantnr.	297986-1
omschrijving	afvoerventiel draad 1¼" OD ø 64.5mm ID ø 41mm		
Voor modellen:	AM-600, AM-600C, AM-600CR, AM-600R, FM-400H, FM-400U, FM-500, FM-500H, UW-105, UW-135, UW-135H, UW-55		

			
1			
bestelnr.	518187	fabrikantnr.	139321-652
omschrijving	afvoerventiel draad 3/4" ID ø 22mm		
Voor modellen:	CHF45, CHH-70D, CLG-25, EF-40, EH-70		

			
1			
bestelnr.	518065	fabrikantnr.	139321-914
omschrijving	filterhouder H 140mm ø 140mm		
Voor modellen:	CHH-50, CHH-60D, CHH-70D, EH-60, EH-70		

			
1			
bestelnr.	511677	fabrikantnr.	00-324053-000 00-886639-000
omschrijving	flens met pakking OD ø 107mm ID ø 70mm voor pomp		
Voor modellen:	CN-Protronic, CN-Smartronic, CP-Protronic, CR-F, CS-Easytronic, ECOMAX-402, ECOMAX-502, FE-W, FX, GC, GC11, GC12, GC31, GC32, GC41, GC42, GX, HX, HX-30, HX-30E, HX-30ES, HX-30S, HX-40, HX-40E, HX-40ES, HX-40S, HX-60-EHL, HX-E, HX-ES, HX-S		



1

bestelnr.	507496	fabrikantnr.	00-324056-000
omschrijving	pakking OD ø 100mm ID ø 80mm		
Voor modellen:	CN, CNA, CNB, CN-Protronic, CNR, CN-Smartronic, CP-Protronic, CR, CR-F, CS-Easytronic, ECOMAX-402, ECOMAX-502, FE, FE-W, FTN, FX, GC, GC11, GC12, GC31, GC32, GC41, GC42, GX, HE, HE600-HL, HE-P, HX, HX-30, HX-30E, HX-30ES, HX-30S, HX-40, HX-40E, HX-40ES, HX-40S, HX-60-EHL, HX-E, HX-ES, HX-S, UX-60, UX-60B, UX-60E, UX-60EB		



1

bestelnr.	518060	fabrikantnr.	139321-913
omschrijving	pakking rubber OD ø 132mm ID ø 122mm materiaaldikte 5mm		
Voor modellen:	CHH-50, CHH-60D, CHH-70D, EH-60, EH-70		



1

bestelnr.	524906	fabrikantnr.	323785-101
omschrijving	pakking voor afvoerventiel ø 14mm		
Voor modellen:	FX, GX		



1

bestelnr.	511962	fabrikantnr.	172986-15
omschrijving	vlakpakking rubber OD ø 62mm ID ø 44mm materiaaldikte 0.9mm vpe 1stuk		
Voor modellen:	AM-600, AM-600C, AM-600CR, AM-600R, FM-400H, FM-400U, FM-500, FM-500H, FTX, FUX, UW-105, UW-120, UW-135, UW-135H, UW-200, UW-55, UWX		

filters



1

bestelnr.	510647	fabrikantnr.	323893-1
omschrijving	aanzuigfilter ø 163mm H 112mm gat ø 33mm		
Voor modellen:	FE, HE, HE-P		



1

bestelnr.	517584	fabrikantnr.	00-324768-000
omschrijving	filter ø 138mm H 86mm		
Voor modellen:	AMX, AMX-900, AMX-E, AMX-ER, AMX-R, AMXR-900, AMXS-900, AMXX-1300, AMXXR-1300, AMXXS-1300, AMXXT, AUX, AUX_, AUX-E, AUX-ER, AUX-R, AUXX-1300, AUXXL, AUXXR-1300, AUXXS-1300, AUXXT, UX, UX-30, UX-30B, UX-30E, UX-30EB, UX-30EH, UX-30ES, UX-30ESB, UX-30ESH, UX-30H, UX-30-McDonalds, UX-30S, UX-30SB, UX-30SH, UX-60, UX-60B, UX-60E, UX-60EB, UX-60EH, UX-60EHB, UX-60H, UX-60HB, UXD-30, UXL, UXLS, UXS, UXT, UXTH, UXTHL... (Andere modellen die u kunt zien in de webshop)		



1

bestelnr.	517581	fabrikantnr.	229400
omschrijving	rechthoekfilter voor vaatwasser H 312mm RVS L 435mm B 85mm		
Voor modellen:	ACW, CX, FTT, FTX, UW-135, UW-135H		



1

bestelnr.	524830	fabrikantnr.	01-240630-003 01-240630-3
omschrijving	rondfilter ø 136mm H 47mm		



1

bestelnr.	510041	fabrikantnr.	139321-51
omschrijving	rondfilter ø 136mm H 75mm		
Voor modellen:	GE-400, GW-600, GW-600S, GW-601, GW-601S		



1

bestelnr.	530788	fabrikantnr.	00-883582-001 01-297817-1 8123 883582-1
omschrijving	rondfilter ø 154mm H 116mm voor model AMX/AUX met ring		
Voor modellen:	AMX, AMX-10HL, AMX-90, AMXR, AMXS, AMXT, AMXTS, AMXX, AMXXR, AMXXS, AUP, AUP-90, AUPS, AUXX, AUXXL-11N, AUXXS-11N, AUXXR, AUXXS, AUXXT, AUXXTS		





1

bestelnr.	524897	fabrikantnr.	883733-1
omschrijving	rondfilter ø 160mm H 35mm		



1

bestelnr.	524681	fabrikantnr.	324179
omschrijving	rondfilter ø 161mm H 155mm		
Voor modellen:	FE-W, FX, GX, HX, HX-30, HX-30E, HX-30ES, HX-30S, HX-40, HX-40E, HX-40ES, HX-40S, HX-60-EHL, HX-E, HX-ES, HX-S		



1

bestelnr.	502217	fabrikantnr.	01-240630-001 01-240630-002 01-240630-1 01-240630-2
omschrijving	rondfilter ø 32.5mm H 49mm		
Voor modellen:	ECOMAX-402, ECOMAX-502		



1

bestelnr.	517586	fabrikantnr.	01-240051-004 01-240051-4
omschrijving	vlakfilter H 43mm L 525mm B 220mm		
Voor modellen:	FX, FX-McDonalds, GX		



1

bestelnr.	507499	fabrikantnr.	00-898189-001 898189-1
omschrijving	vlakfilter L 523mm B 253mm H 15mm		
Voor modellen:	AM-10, AM-11, AM-141, AM-700, AM900, AM900-10N, AM900-90, AMS900, AMS900-10N, ECOMAX-600, ECOMAX-602-10, ECOMAX-602-11, ECOMAX-602S-11, ECOMAX-612-10, ECOMAX-612S-10, ECOMAX-650		

overlooppijpen



1

bestelnr.	698632	fabrikantnr.	324231
omschrijving	klep voor overlooppijp ø 55mm H 13mm		
Voor modellen:	AMX, AMX-900, AMX-E, AMX-ER, AMX-R, AMXR-900, AMXS-900, AMXX-1300, AMXXR-1300, AMXXS-1300, AMXXT, AUX, AUX_, AUX-E, AUX-ER, AUX-R, AUX-1300, AUXXL, AUXXR-1300, AUXXS-1300, AUXXT, CR, CR-F, FE-W, FX, GX, HX, HX-30, HX-30E, HX-30ES, HX-30S, HX-40, HX-40E, HX-40ES, HX-40S, HX-60-EHL, HX-E, HX-ES, HX-S, UX, UX-30, UX-30B, UX-30E, UX-30EB, UX-30EH, UX-30ES, UX-30ESB, UX-30ESH, UX-30H, UX-30-McDonalds...(Andere modellen die u kunt zien in de webshop)		



1

bestelnr.	528919	fabrikantnr.	139321-49
omschrijving	O-ring EPDM materiaaldikte 2.62mm ID ø 20.24mm vpe 1stuk		
Voor modellen:	GE-400, GW-600, GW-600S, GW-601, GW-601S		



1

bestelnr.	510409	fabrikantnr.	00-276903-053 00-67500-016 00-67500-118 276903-53 670500-118 67500-16
omschrijving	O-ring EPDM materiaaldikte 5.34mm ID ø 56.52mm vpe 1stuk		
Voor modellen:	CR-F, CX, ECW, EWB-S, FTN, FTT, FTX, FUX, ML-104674, ML-104683, ML-104686, UW-135, UW-135H, UWX, UX-60, UX-60B, UX-60E, UX-60EB, UX-60EH, UX-60EHB, UX-60H, UX-60HB, UXT, UXTL, UXTLH, UXTLHS, UXTLS, UXTS, V1401		



1

bestelnr.	517580	fabrikantnr.	01-240629-001 01-240629-1 01-240744-001 01-240744-1 01-240744-2
omschrijving	overlooppijp L 160mm ø 90mm		
Voor modellen:	ECOMAX-402, ECOMAX-502		

1

bestelnr.	510038	fabrikantnr.	139321-157
omschrijving	overlooppijp L 190mm ø 25mm		
Voor modellen:	GE-400, GW-600, GW-600S, GW-601, GW-601S		
Toebehoren voor	510038		
	bestelnr.	fabrikantnr.	139321-49
	O-ring EPDM materiaaldikte 2.62mm ID ø 20.24mm vpe 1stuk		



1

bestelnr.	524480	fabrikantnr.	323999-1
omschrijving	overlooppijp L 250mm ø 32mm		
Voor modellen:	CR, CR-F, FE, HE, HE600-HL, HE-P		



1

bestelnr.	524660	fabrikantnr.	00-883737-001 883737-1
omschrijving	overlooppijp L 270mm ø 32mm		
Voor modellen:	AM-10, AM-11, AM-141, ECOMAX-602-10, ECOMAX-602-11, ECOMAX-602S-11, ECOMAX-612-10, ECOMAX-612S-10		



1

bestelnr.	517574	fabrikantnr.	323534-4
omschrijving	overlooppijp L 305mm met filter ø 155mm pijp ø 56mm kunststof ID ø 28mm		
Voor modellen:	AMX-900, AMXR-900, AMXS-900		





1

bestelnr.	517579	fabrikantnr.	898185-1
omschrijving	overlooppijp L 323mm ø 86mm pijp ø 35mm kunststof ID ø 24mm		
Voor modellen:	AM-700, ECOMAX-600, ECOMAX-650		



1

bestelnr.	524682	fabrikantnr.	230346 230346-1 230346-1V
omschrijving	overlooppijp L 370mm ø 109mm		
Voor modellen:	CX, UW-135, UW-135H		
Toebehoren voor	524682		
	bestelnr.	fabrikantnr.	—
	O-ring EPDM materiaaldikte 5.34mm ID ø 37.47mm vpe 1stuk		



1

bestelnr.	517576	fabrikantnr.	323534-3
omschrijving	overlooppijp L 405mm met filter ø 155mm pijp ø 36mm ID ø 28mm		
Voor modellen:	AMXX-1300, AMXXR-1300, AMXXS-1300, AMXXT, AUXX-1300, AUXXL, AUXXR-1300, AUXXS-1300, AUXXT		





1

bestelnr.	517582	fabrikantnr.	229426-3 229426-3V
omschrijving	overlooppijp L 410mm ø 109mm		
Voor modellen:	AM-12E, AM-12EC, AM-12EF, AM-12ER, AM-600, AM-600C, AM-600CR, AM-600R, UW-100, UW-105, UWX		



			
1			
bestelnr.	517578	fabrikantnr.	323534-1 774412-1
omschrijving	overlooppijp L 458mm met filter ø 155mm pijp ø 36mm ID ø 28mm		
Voor modellen:	AMX, AMX-E, AMX-ER, AMX-R, AUX, AUX_, AUX-E, AUX-ER, AUX-R, UXD-30		

			
1			
bestelnr.	524921	fabrikantnr.	323534-2 324666-2
omschrijving	overlooppijp L 460mm met filter ø 150mm pijp ø 36mm kunststof ID ø 28mm		
Voor modellen:	CR, CR-F, UX-30, UX-30B, UX-30E, UX-30EB, UX-30EH, UX-30ES, UX-30ESB, UX-30ESH, UX-30H, UX-30-McDonalds, UX-30S, UX-30SB, UX-30SH, UX-60, UX-60B, UX-60E, UX-60EB, UX-60EH, UX-60EHB, UX-60H, UX-60HB, UXT, UXTH, UXTHL, UXTHLS, UXTHS, UXTL, UXTLS, UXTS		

			
1			
bestelnr.	517577	fabrikantnr.	323534-6
omschrijving	overlooppijp L 467mm met filter ø 155mm pijp ø 36mm kunststof ID ø 28mm		
Voor modellen:	UXT, UXTH, UXTHS, UXTL, UXTLH, UXTLHS, UXTLS, UXTS		

containers

containerdeksels

			
1			
bestelnr.	524685	fabrikantnr.	227883
omschrijving	deksel ø 29mm voor doseercontainer passend voor HOBART		
Voor modellen:	CM1E, FX, GX, WM2E		

			
1			
bestelnr.	542091	fabrikantnr.	00-775530-050 775530-50
omschrijving	deksel ø 85mm voor zoutcontainer passend voor HOBART H 18mm ID ø 58mm		
Voor modellen:	AM900, AM900-10N, AM900-90, AMS900, AMS900-10N, AMX, AMX-10HL, AMX-90, AMX-900, AMXR, AMXR-900, AMXS, AMXS-900, AMXT, AMXTS, AMXX, AMXX-1300, AMXXR, AMXXR-1300, AMXXS, AMXXS-1300, AMXXT, AUP, AUP-90, AUPS, AUXX, AUXX-1300, AUXXL, AUXXL-11N, AUXXLS-11N, AUXXR, AUXXR-1300, AUXXS, AUXXS-1300, AUXXT, AUXXTS, FP, FX, FX-McDonalds, GP, GX, UX, UXL, UXLS, UXS, UXT, UXTH, UXTHL, UXTHLS, UXTHS...(Andere modellen die u kunt zien in de webshop)		

doseercontainers

			
1			
bestelnr.	361893	fabrikantnr.	231969
omschrijving	container L 335mm B 105mm H 25mm voor glansspol-middel		
Voor modellen:	FX, GX		

			
1			
bestelnr.	361881	fabrikantnr.	231969-1 231969-2
omschrijving	container set L 335mm B 105mm H 25mm voor glansspol-middel		
Voor modellen:	FX, GX		





boilers

boiler voor vaatwasser



1

bestelnr.	504375	fabrikantnr.	01-240791-001 01-240791-1
omschrijving	boiler ø 133mm L 420mm flens 3-gatsflens flens ø 47.5mm		
Voor modellen:	AM-10, AM-11, AM-141, ECOMAX-502, ECOMAX-602-10		
Toebehoren voor	504375		
	bestelnr.	fabrikantnr.	00-774512-001 774512-1
	plug voor afvoer ø 10mm L 18mm		
	bestelnr.	fabrikantnr.	00-774080-001 774080-1
	siliconeslang ID ø 10mm OD ø 15mm L 1m dikte 2.5mm werkdruk drukvrij barstdruk niet gedefinieerd t.max. 200°C transparant Shore 60°		

toebehoren



1

bestelnr.	524908	fabrikantnr.	00-774808-001 774808-1
omschrijving	blindstop voor boiler L 69mm B 17mm		
Voor modellen:	AM-700, AMX-900, AMXR-900, AMXS-900, AMXX-1300, AMXXR-1300, AMXXS-1300, AMXXT, AUXX-1300, AUXXL, AUXXR-1300, AUXXS-1300, AUXXT, CN, CNA, CNB, CN-Protronic, CNR, CN-Smartronic, CP-Protronic, CR, CR-F, CSA, CS-Easytronic, ECOMAX-600, ECOMAX-650, ECOMAX-700, ECOMAX-800, ECW, FTN, FTX, UX, UXL, UXLS, UXS, UXT, UXTH, UXTHL, UXTHLS, UXTHS, UXTL, UXTLH, UXTLHS, UXTLS, UXTS		



1

bestelnr.	511654	fabrikantnr.	230994
omschrijving	boilerpakking D1 ø 260mm D2 ø 215mm materiaaldikte 2mm 10gaten rubber passend voor HOBART		
Voor modellen:	ACW, CR-F, CX, FTN, FTT, FTX, FUX, UWX		



1

bestelnr.	518121	fabrikantnr.	226894-1
omschrijving	boilerpakking ø 249mm ID ø 235mm dikte 7mm		
Voor modellen:	AM-12E, AM-12EC, AM-12EF, AM-12ER, AM-600, AM-600C, AM-600CR, AM-600R, UW-100, UW-105, UW-135, UW-135H		



1

bestelnr.	524905	fabrikantnr.	228602
omschrijving	pakking voor boiler ø 145mm L 187mm B 174mm dikte 7mm gat ø 7mm		
Voor modellen:	FM-30, FM-30U, FM-400H, FM-400U, FM-500, FM-500H, UW-55		



1

bestelnr.	504379	fabrikantnr.	00-774512-001 774512-1
omschrijving	plug voor afvoer ø 10mm L 18mm		
Voor modellen:	AM-10, AM-11, AM-141, AM-700, AM900, AM900-10N, AM900-90, AMS900, AMS900-10N, AMX, AMX-10HL, AMX-90, AMX-900, AMXR, AMXR-900, AMXS, AMXS-900, AMXT, AMXTS, AMXX, AMXX-1300, AMXXR, AMXXR-1300, AMXXS, AMXXS-1300, AMXXT, AUP, AUP-90, AUPS, AUXX, AUXX-1300, AUXXL, AUXXL-11N, AUXXLS-11N, AUXXR, AUXXR-1300, AUXXS, AUXXS-1300, AUXXT, AUXXTS, ECOMAX-402, ECOMAX-502, ECOMAX-600, ECOMAX-602-10, ECOMAX-602-11, ECOMAX-602S-11, ECOMAX-612-10, ECOMAX-612S-10, FP, FX...(Andere modellen die u kunt zien in de webshop)		



1

bestelnr.	530821	fabrikantnr.	00-774080-001 774080-1
omschrijving	siliconeslang ID ø 10mm OD ø 15mm L 1m dikte 2.5mm werkdruk drukvrij barstdruk niet gedefinieerd t.max. 200°C transparant Shore 60°		
Voor modellen:	AM-10, AM-11, AM-141, AM-700, AM900, AM900-10N, AM900-90, AMS900, AMS900-10N, AMX, AMX-10HL, AMX-90, AMX-900, AMXR, AMXR-900, AMXS, AMXS-900, AMXT, AMXTS, AMXX, AMXX-1300, AMXXR, AMXXR-1300, AMXXS, AMXXS-1300, AMXXT, AUP, AUP-90, AUPS, AUXX, AUXX-1300, AUXXL, AUXXL-11N, AUXXLS-11N, AUXXR, AUXXR-1300, AUXXS, AUXXS-1300, AUXXT, AUXXTS, ECOMAX-402, ECOMAX-502, ECOMAX-600, ECOMAX-602-10, ECOMAX-602-11, ECOMAX-602S-11, ECOMAX-612-10, ECOMAX-612S-10, FP, FX...(Andere modellen die u kunt zien in de webshop)		



1

bestelnr.	504378	fabrikantnr.	01-240452-001 01-240452-1
omschrijving	slingaansluiting draad 1/8" draad L 44mm slang ø 5mm		
Voor modellen:	AM-10, AM-11, AM-141, AM900-10N, AM900-90, AMS900-10N, AMX, AMX-10HL, AMX-90, AMXR, AMXS, AMXT, AMXTS, AMXX, AMXXR, AMXXS, AUP, AUP-90, AUPS, AUXX, AUXXL-11N, AUXXLS-11N, AUXXR, AUXXS, AUXXT, AUXXTS, ECOMAX-602-10, ECOMAX-602-11, ECOMAX-602S-11, ECOMAX-612-10, ECOMAX-612S-10		



onthardingspatronen

compleet

			
1			
bestelnr.	530327	fabrikantnr.	00-775918-001 00-775918-010 775918-1
omschrijving	ontharder		
Voor modellen:	ECOMAX-402, ECOMAX-502, ECOMAX-602S-11, ECOMAX-612S-10		
Toebehoren voor	530327		
			
bestelnr.	530174	fabrikantnr.	00-775918-050 775918-150 775918-50
deksel set voor ontharder			

behuizing en membranen

diversen

			
1			
bestelnr.	513070	fabrikantnr.	00-886756-004 886756-4
omschrijving	doorvoering ID ø 14mm OD ø 19mm		
Voor modellen:	AM-10, AM-11, AM-141, AM-700, AM900, AM900-10N, AM900-90, AMS900, AMS900-10N, AMX, AMX-10HL, AMX-90, AMX-900, AMXR, AMXR-900, AMXS, AMXS-900, AMXT, AMXTS, AMXX, AMXX-1300, AMXXR, AMXXR-1300, AMXXS, AMXXS-1300, AMXXT, AUP, AUP-90, AUPS, AUXX, AUXX-1300, AUXXL, AUXXL-11N, AUXXLS-11N, AUXXR, AUXXR-1300, AUXXS, AUXXS-1300, AUXXT, AUXXTS, ECOMAX-402, ECOMAX-502, ECOMAX-602-10, ECOMAX-602-11, ECOMAX-602S-11, ECOMAX-612-10, ECOMAX-612S-10, ECOMAX-650, ECOMAX-700, FP..(Andere modellen die u kunt zien in de webshop)		

			
1			
bestelnr.	513049	fabrikantnr.	00-886756-003 886756-3
omschrijving	doorvoering ID ø 29mm OD ø 38mm		
Voor modellen:	AM-10, AM-11, AM-141, AM-700, AM900-10N, AM900-90, AMS900-10N, AMX, AMX-10HL, AMX-90, AMXR, AMXS, AMXT, AMXTS, AMXX, AMXXR, AMXXS, AUP, AUP-90, AUPS, AUXX, AUXXL-11N, AUXXLS-11N, AUXXR, AUXXS, AUXXT, AUXXTS, ECOMAX-402, ECOMAX-502, ECOMAX-600, ECOMAX-602-10, ECOMAX-602-11, ECOMAX-602S-11, ECOMAX-612-10, ECOMAX-612S-10, ECOMAX-700, GC, GC11, GC12, GC31, GC32, GC41, GC42, UX, UXL, UXLS, UXS, UXT, UXTH, UXTHL...(Andere modellen die u kunt zien in de webshop)		

			
1			
bestelnr.	513048	fabrikantnr.	00-886756-001 886756-1
omschrijving	doorvoering ID ø 41mm OD ø 50mm		
Voor modellen:	AM-10, AM-11, AM-141, AM-700, AM900, AM900-10N, AM900-90, AMS900, AMS900-10N, AMX, AMX-10HL, AMX-90, AMX-900, AMX-E, AMX-ER, AMXR, AMX-R, AMXR-900, AMXS, AMXS-900, AMXT, AMXTS, AMXX, AMXX-1300, AMXXR, AMXXR-1300, AMXXS, AMXXS-1300, AMXXT, AUP, AUP-90, AUPS, AUX, AUX-E, AUX-ER, AUX-R, AUXX, AUXX-1300, AUXXL, AUXXL-11N, AUXXLS-11N, AUXXR, AUXXR-1300, AUXXS, AUXXS-1300, AUXXT, AUXXTS, CN-Protonic, CN-Smartronic, CS-Easytronic...(Andere modellen die u kunt zien in de webshop)		

kapmechanieken voor wasmachines

bouten

			
1			
bestelnr.	502220	fabrikantnr.	00-883965-001 883965-1
omschrijving	schroefdraadstuk OD ø 10mm L 22mm draad M5 set voor looprol		
Voor modellen:	AM-10, AM-11, AM-141, AM900-10N, AM900-90, AMS900-10N, AMX, AMX-10HL, AMX-90, AMXR, AMXS, AMXT, AMXTS, AMXX, AMXXR, AMXXS, AUP, AUP-90, AUPS, AUXX, AUXXL-11N, AUXXLS-11N, AUXXR, AUXXS, AUXXT, AUXXTS, ECOMAX-602-10, ECOMAX-602-11, ECOMAX-602S-11, ECOMAX-612-10, ECOMAX-612S-10		

veerhouders

			
1			
bestelnr.	517405	fabrikantnr.	00-883683-002 883683-2
omschrijving	veerhouder voor kapveer		
Voor modellen:	AM-10, AM-11, AM-141, AM900-10N, AM900-90, AMS900-10N, AMX, AMX-10HL, AMX-90, AMXR, AMXS, AMXX, AMXXR, AMXXS, AUP, AUP-90, AUPS, AUXX, AUXXR, AUXXS, ECOMAX-602-10, ECOMAX-602-11, ECOMAX-602S-11, ECOMAX-612-10, ECOMAX-612S-10		

veren

			
1			
bestelnr.	511965	fabrikantnr.	119079-2
omschrijving	veer voor kapmechaniek draad ø 5.5mm ø 50mm totale lengte 385mm		
Voor modellen:	AM-12EC, AM-600C, AM-600CR, AMX, AMX-E, AMX-ER, AMX-R, AUX, AUX-, AUX-E, AUX-ER, AUX-R, FM-30, FM-400H, FM-500H, HE, HE600-HL, HE-P, HX, HX-30, HX-30E, HX-30ES, HX-30S, HX-40, HX-40E, HX-40ES, HX-40S, HX-60-EHL, HX-E, HX-ES, HX-S, UX-30EH, UX-30ESH, UX-30H, UX-30-McDonalds, UX-30SH		



geleiderails



1

bestelnr.	502224	fabrikantnr.	00-886987-001 886987-1
omschrijving	afstandshouder set voor kap L 79mm B 24mm H 10mm		
Voor modellen:	AM-10, AM-11, AM-141, AM900-10N, AM900-90, AMS900-10N, AMX, AMX-10HL, AMX-90, AMX-900, AMXR, AMXR-900, AMXS, AMXS-900, AMXT, AMXTS, AMXX, AMXX-1300, AMXXR, AMXXR-1300, AMXXS, AMXXS-1300, AMXXT, AUP, AUP-90, AUPS, AUXX, AUXX-1300, AUXXL-11N, AUXXLS-11N, AUXXR, AUXXR-1300, AUXXS, AUXXS-1300, AUXXT, AUXXTS, ECOMAX-602-10, ECOMAX-602-11, ECOMAX-602S-11, ECOMAX-612-10, ECOMAX-612S-10		



1

bestelnr.	502223	fabrikantnr.	01-246900-001 01-246900-1
omschrijving	afstandshouder voor kap L 79mm B 24mm H 10mm		
Voor modellen:	AM-10, AM-11, AM-141, AM900-10N, AM900-90, AMS900-10N, AMX, AMX-10HL, AMX-90, AMX-900, AMXR, AMXR-900, AMXS, AMXS-900, AMXT, AMXTS, AMXX, AMXX-1300, AMXXR, AMXXR-1300, AMXXS, AMXXS-1300, AMXXT, AUP, AUP-90, AUPS, AUXX, AUXX-1300, AUXXL-11N, AUXXLS-11N, AUXXR, AUXXR-1300, AUXXS, AUXXS-1300, AUXXT, AUXXTS, ECOMAX-602-10, ECOMAX-602-11, ECOMAX-602S-11, ECOMAX-612-10, ECOMAX-612S-10		



1

bestelnr.	511681	fabrikantnr.	00-883477-001 01-297717-1 883477-1
omschrijving	geleiding L 480mm inbouwpositie onder voor kap		
Voor modellen:	AM-10, AM-11, AM-141, AM900-10N, AM900-90, AMS900-10N, AMX, AMX-10HL, AMX-90, AMXR, AMXS, AMXX, AMXXR, AMXXS, AUP, AUP-90, AUPS, AUXX, AUXXL-11N, AUXXLS-11N, AUXXR, AUXXS, ECOMAX-602-10, ECOMAX-602-11, ECOMAX-602S-11, ECOMAX-612-10, ECOMAX-612S-10		

kapgreephouders



1

bestelnr.	502222	fabrikantnr.	00-898024-001 898024-1
omschrijving	lager voor kapgreep kunststof L 47mm B 38mm H 20mm		
Voor modellen:	AM-10, AM-11, AM-141, AM900-10N, AM900-90, AMS900-10N, AMX, AMX-10HL, AMX-90, AMXR, AMXS, AMXT, AMXTS, AMXX, AMXXR, AMXXS, AUP, AUP-90, AUPS, AUXX, AUXXL-11N, AUXXLS-11N, AUXXR, AUXXS, AUXXT, AUXXTS, ECOMAX-602-10, ECOMAX-602-11, ECOMAX-602S-11, ECOMAX-612-10, ECOMAX-612S-10		

looprollen



1

bestelnr.	502221	fabrikantnr.	00-898080-001 898080-1
omschrijving	loopwiel ø 29mm voor kapmechaniek set gat ø 10mm		
Voor modellen:	AM-10, AM-11, AM-141, AM-700, AM900, AM900-10N, AM900-90, AMS900, AMS900-10N, AMX, AMX-10HL, AMX-90, AMX-900, AMX-E, AMX-ER, AMXR, AMX-R, AMXR-900, AMXS, AMXS-900, AMXT, AMXTS, AMXX, AMXX-1300, AMXXR, AMXXR-1300, AMXXS, AMXXS-1300, AMXXT, AUP, AUP-90, AUPS, AUX, AUX-E, AUX-ER, AUX-R, AUXX, AUXX-1300, AUXXL, AUXXL-11N, AUXXLS-11N, AUXXR, AUXXR-1300, AUXXS, AUXXS-1300, AUXXT, AUXXTS, ECOMAX-600, ECOMAX-602-10, ECOMAX-602-11...(Andere modellen die u kunt zien in de webshop)		
Toebehoren voor	502221		
bestelnr.	502220	fabrikantnr.	00-883965-001 883965-1
omschrijving	schroefdraadstuk OD ø 10mm L 22mm draad M5 set voor looprol		

diversen



1

bestelnr.	502226	fabrikantnr.	00-228828-000
omschrijving	rubber buffer OD ø 9mm zwart		
Voor modellen:	AM-10, AM-11, AM-141, AM-700, AM900, AM900-10N, AM900-90, AMS900, AMS900-10N, AMX, AMX-10HL, AMX-90, AMX-900, AMX-E, AMX-ER, AMXR, AMX-R, AMXR-900, AMXS, AMXS-900, AMXT, AMXTS, AMXX, AMXX-1300, AMXXR, AMXXR-1300, AMXXS, AMXXS-1300, AMXXT, AUP, AUP-90, AUPS, AUX, AUX-E, AUX-ER, AUX-R, AUXX, AUXX-1300, AUXXL, AUXXL-11N, AUXXLS-11N, AUXXR, AUXXR-1300, AUXXS, AUXXS-1300, AUXXT, AUXXTS, ECOMAX-600, ECOMAX-602-10...(Andere modellen die u kunt zien in de webshop)		



luchtkamers			
luchtkamers			
			
1			
bestelnr.	503162	fabrikantnr.	01-240372-001 01-240372-1
omschrijving	luchtkamer compleet L 77mm B 83mm aansluit ø 24mm slang ø 6mm		
Voor modellen:	AM-10, AM-11, AM-141, AM900-10N, AM900-90, AMS900-10N, AMX, AMX-10HL, AMX-90, AMXR, AMXS, AMXT, AMXTS, AMXX, AMXXR, AMXXS, AUP, AUP-90, AUPS, AUX, AUXXL-11N, AUXXS-11N, AUXXR, AUXXS, AUXXT, AUXXTS, ECOMAX-402, ECOMAX-502, ECOMAX-602-10, ECOMAX-602-11, ECOMAX-602S-11, ECOMAX-612-10, ECOMAX-612S-10, FP, FX, FX-McDonalds, GP, GX		
Toebehoren voor	503162		
			00-324402-005 00-324402-014 139321-126 324402-14 324402-5
	bestelnr.	520027	fabrikantnr.
			139321-126 324402-14 324402-5
	PVC slang ID ø 4mm OD ø 7mm L 10m dikte 1.5mm t.max. 60°C transparant		

			
1			
bestelnr.	517575	fabrikantnr.	324858
omschrijving	luchtkamer L 78mm B 40mm H 66mm slang ø 5mm kunststof		
Voor modellen:	AM3, AMX, AMX-E, AMX-ER, AMX-R, AUX, AUX_, AUX-E, AUX-ER, AUX-R, FE, HE, HE600-HL, HE-P, UXD-30		

			
1			
bestelnr.	510103	fabrikantnr.	139321-47
omschrijving	luchtkamer L 85mm B 20mm H 80mm slang ø 6mm kunststof		
Voor modellen:	AM-700, AM900, AMS900, AMX-900, AMXR-900, AMXS-900, AMXX-1300, AMXXR-1300, AMXXS-1300, AMXXT, AUXX-1300, AUXXL, AUXXR-1300, AUXXS-1300, AUXXT, ECOMAX-600, ECOMAX-650, ECOMAX-700, FE-W, FX, GC, GC11, GC12, GC31, GC32, GC41, GC42, GE-400, GW-600, GW-600S, GW-601, GW-601S, GX, HX, HX-30, HX-30E, HX-30ES, HX-30S, HX-40, HX-40E, HX-40ES, HX-40S, HX-60-EHL, HX-E, HX-ES, HX-S, UX, UX-30, UX-30B, UX-30E...(Andere modellen die u kunt zien in de webshop)		
Reparatie-onderdelen voor	510103		
	bestelnr.	505045	fabrikantnr.
			—
	O-ring EPDM materiaaldikte 1.78mm ID ø 5.28mm vpe 1stuk		
	bestelnr.	505094	fabrikantnr.
			—
	luchtkamer		
	bestelnr.	510016	fabrikantnr.
			139321-180 897923
	oogschroef voor aansluiting glansspoelmiddelcontainer		
	bestelnr.	510105	fabrikantnr.
			139321-202 897923
	slangaansluiting voor luchtontstapping		

			
1			
bestelnr.	510111	fabrikantnr.	139321-550
omschrijving	luchtkamer ø 34mm H 130mm slang ø 6mm kunststof		
Voor modellen:	CHH-50, CHH-60D, CHH-70D, CLG-25, EH-60, EH-70		
Reparatie-onderdelen voor	510111		
	bestelnr.	504618	fabrikantnr.
			—
	O-ring EPDM materiaaldikte 2.62mm ID ø 15.54mm vpe 1stuk		
	bestelnr.	510075	fabrikantnr.
			139321-725
	vlakpakking rubber OD ø 22mm ID ø 13mm materiaaldikte 1.5mm vpe 1stuk		
	bestelnr.	510106	fabrikantnr.
			139321-722
	slangaansluiting voor luchtontstapping		

			
1			
bestelnr.	511993	fabrikantnr.	107013
omschrijving	luchtkamer ø 43mm H 33mm slang ø 6mm kunststof		
Voor modellen:	H-60		

luchtkamertoebereiden			
			
1			
bestelnr.	510105	fabrikantnr.	139321-202 897923
omschrijving	slangaansluiting voor luchtontstapping		
Voor modellen:	AM-700, AM900, AMS900, AMX, AMX-900, AMX-E, AMX-ER, AMX-R, AMXR-900, AMXS-900, AMXX-1300, AMXXR-1300, AMXXS-1300, AMXXT, AUX, AUX_, AUX-E, AUX-ER, AUX-R, AUXX-1300, AUXXL, AUXXR-1300, AUXXS-1300, AUXXT, ECOMAX-600, ECOMAX-650, FE, FE-W, FX, GE-400, GW-600, GW-600S, GW-601, GW-601S, GX, HE, HE600-HL, HE-P, HX, HX-30, HX-30E, HX-30ES, HX-30S, HX-40, HX-40E, HX-40ES, HX-40S, HX-60-EHL, HX-E, HX-ES...(Andere modellen die u kunt zien in de webshop)		
Reparatie-onderdelen voor	510105		
	bestelnr.	510017	fabrikantnr.
			—
	knelschroef		

mechaniek voor doorschuifvaatwassers



1

bestelnr.	524879	fabrikantnr.	302 207-22
omschrijving	glijrail voor deur L 380mm		
Voor modellen:	UX, UXS, UXT, UXTS		



1

bestelnr.	524683	fabrikantnr.	112378-21 302207-4
omschrijving	glijrail voor deur L 870mm B 8mm H 11.5mm passend voor HOBART		
Voor modellen:	CX, FTX, FUX		



1

bestelnr.	524884	fabrikantnr.	00-154791-000
omschrijving	pakking H 35mm ø 66mm ID ø 16mm		
Voor modellen:	CN, CNA, CNB, CN-Protronic, CNR, CN-Smartronic, CP-Protronic, CR, CR-F, CSA, CS-Easytronic, ECOMAX-800		



1

bestelnr.	524526	fabrikantnr.	229319
omschrijving	rol voor transportsysteem L 24.4mm ID ø 7.4mm OD ø 20/25mm passend voor HOBART		
Voor modellen:	FTX		



1

bestelnr.	524527	fabrikantnr.	774643-1
omschrijving	rol voor transportsysteem L 26.2mm ID ø 7.2mm OD ø 20/26mm passend voor HOBART		



1

bestelnr.	524525	fabrikantnr.	229326-1
omschrijving	stang voor transportsysteem L 600mm ø 7mm passend voor HOBART		
Voor modellen:	FTX		

APPARAATSPECIFIEKE BOUWDELEN HOBART



1

bestelnr.	524878	fabrikantnr.	229 102
omschrijving	transportvinger B 70mm H 87mm LA 58.5mm		
Voor modellen:	FTX		

pijpen



1

bestelnr.	513047	fabrikantnr.	00-883512-001 883512-1
omschrijving	pijp 14x2,0mm pijp ø 14mm L 933mm PE-Xb		
Voor modellen:	AM-10, AM-11, AM-141, AM900-10N, AM900-90, AMS900-10N, AMX, AMX-10HL, AMX-90, AMXR, AMXS, AMXT, AMXTS, AMXX, AMXXR, AMXXS, AUP, AUP-90, AUPS, AUXX, AUXXR, AUXXS, AUXXT, AUXXTS, ECOMAX-602-10, ECOMAX-602-11, ECOMAX-602S-11, ECOMAX-612-10, ECOMAX-612S-10		

terugslagkleppen

terugslagkleppen



1

bestelnr.	511672	fabrikantnr.	00-775759-001 775759-1
omschrijving	terugslagventiel		
Voor modellen:	AM-10, AM-11, AM-141, AM-700, AM900-90, AMX-90, AUP-90, CNA, CNB, CNR, CSA, ECOMAX-402, ECOMAX-502, ECOMAX-600, ECOMAX-602-10, ECOMAX-650, ECOMAX-700, ECOMAX-800, FP, FX, FX-McDonalds, GC, GC11, GC12		
Toebehoren voor	511672		



bestelnr.	502228	fabrikantnr.	00-324384-000 324384
moer voor terugslagklep ø 35mm SB 30			



bestelnr.	507495	fabrikantnr.	00-775305-001 172513 775305-1
pakking OD ø 34mm ID ø 25.5mm materiaaldikte 2.5mm vpe 1stuk			





1

bestelnr.	511673	fabrikantnr.	00-883817-001 883817-1
omschrijving	terugslagventiel		
Voor modellen:	AM900-10N, AM900-90, AMS900-10N, AMX, AMX-10HL, AMX-90, AMXR, AMXS, AMXT, AMXTS, AMXX, AMXXR, AMXXS, AUP, AUP-90, AUPS, AUXX, AUXXL-11N, AUXXLS-11N, AUXXR, AUXXS, AUXXT, AUXXTS, ECOMAX-602-11, ECOMAX-602S-11, ECOMAX-612-10, ECOMAX-612S-10		
Reparatie-onderdelen voor	511673		
	bestelnr.	511680	fabrikantnr. 00-324313-002 324313-2
	kogel voor terugslagklep ø 8mm		
Toebehoren voor	511673		
	bestelnr.	511675	fabrikantnr. 00-775531-001 775531-1
	blindstop voor terugslagklep ø 10mm L 26mm rubber		





1

bestelnr.	511674	fabrikantnr.	01-240142-001 01-240142-1
omschrijving	terugslagventiel		
Voor modellen:	ECOMAX-402, ECOMAX-502, FP, FX, FX-McDonalds, GP, GX		
Reparatie-onderdelen voor	511674		
	bestelnr.	511680	fabrikantnr. 00-324313-002 324313-2
	kogel voor terugslagklep ø 8mm		
Toebehoren voor	511674		
	bestelnr.	511675	fabrikantnr. 00-775531-001 775531-1
	blindstop voor terugslagklep ø 10mm L 26mm rubber		



1

bestelnr.	524457	fabrikantnr.	00-775540-001 00-775540-011 01-297510-001 01-297510-002 01-297510-2 01-297695-001 01-297695-1 775540-1 775540-11
omschrijving	terugslagventiel set		
Voor modellen:	AM900, AM900-10N, AM900-90, AMS900, AMS900-10N, AMX, AMX-10HL, AMX-90, AMX-900, AMX-E, AMX-ER, AMXR, AMX-R, AMXR-900, AMXS, AMXS-900, AMXT, AMXTS, AMXX, AMXX-1300, AMXXR, AMXXR-1300, AMXXS, AMXXS-1300, AMXXT, AUP, AUP-90, AUPS, AUX, AUX-E, AUX-ER, AUX-R, AUXX, AUXX-1300, AUXXL, AUXXL-11N, AUXXLS-11N, AUXXR, AUXXR-1300, AUXXS, AUXXS-1300, AUXXT, AUXXTS, ECOMAX-402, ECOMAX-502, ECOMAX-602-11, ECOMAX-602S-11, ECOMAX-612-10, ECOMAX-612S-10, ECOMAX-650...(Andere modellen die u kunt zien in de webshop)		
Reparatie-onderdelen voor	524457		
	bestelnr.	502228	fabrikantnr. 00-324384-000 324384
	moer voor terugslagklep ø 35mm SB 30		
Toebehoren voor	524457		
	bestelnr.	520015	fabrikantnr. 00-775559-007 00-775559-008 00-775559-013 00-775559-016 139321-125 139321-611 775559-13 775559-16 775559-7 775559-8
	toevoerslang ID ø 10mm OD ø 17mm L 5m werkdruk 20bar plaatdruk 60bar t.max. 95°C grijs VPE 5m		



1

bestelnr.	523077	fabrikantnr.	01-297695-2
omschrijving	terugslagventiel set met afdekkap		



		
1		
bestelnr.	524882	fabrikantnr. 324091
omschrijving	terugslagventiel slang ø 12mm	
Voor modellen:	ACW, CR-F, FE, FTN, FTT, FTX, FUX, FX, GX, HE, HE600-HL, HX-30ES, HX-30S, HX-40ES, HX-40S, HX-ES, HX-S, UW-135, UW-135H, UX-30ES, UX-30ESB, UX-30ESH, UX-30-McDonalds, UX-30S, UX-30SB, UX-30SH	

		
1		
bestelnr.	524513	fabrikantnr. 324158 886641
omschrijving	terugslagventiel slang ø 13/18mm	
Voor modellen:	AM3, AMX, AMX-E, AMX-ER, AMX-R, AUX, AUX_, AUX-E, AUX-ER, AUX-R, FX, UX-30, UX-30B, UX-30E, UX-30EB, UX-30EH, UX-30H, UX-30-McDonalds, UX-60, UX-60B, UX-60E, UX-60EB, UX-60EH, UX-60EHB, UX-60H, UX-60HB, UXD-30	

terugslagventielen

		
1		
bestelnr.	517573	fabrikantnr. 146669-1 292909
omschrijving	terugslagventiel draad 1/2" ID	
Voor modellen:	AM-600, AM-600C, AM-600CR, AM-600R, CX, FM-400H, FM-500H, UW-105, UWX	

toebehoren

		
1		
bestelnr.	511675	fabrikantnr. 00-775531-001 775531-1
omschrijving	blindstop voor terugslagklep ø 10mm L 26mm rubber	
Voor modellen:	AM900, AM900-10N, AM900-90, AMS900, AMS900-10N, AMX, AMX-10HL, AMX-90, AMX-900, AMX-E, AMX-ER, AMXR, AMX-R, AMXR-900, AMXS, AMXS-900, AMXT, AMXTS, AMXX, AMXX-1300, AMXXR, AMXXR-1300, AMXXS, AMXXS-1300, AMXXT, AUP, AUP-90, AUPS, AUX, AUX-E, AUX-ER, AUX-R, AUXX, AUXX-1300, AUXXL, AUXXL-11N, AUXXLS-11N, AUXXR, AUXXR-1300, AUXXS, AUXXS-1300, AUXXT, AUXXTS, ECOMAX-402, ECOMAX-502, ECOMAX-602-11, ECOMAX-612-10, ECOMAX-650, FP, FX... (Andere modellen die u kunt zien in de webshop)	

		
1		
bestelnr.	511680	fabrikantnr. 00-324313-002 324313-2
omschrijving	kogel voor terugslagklep ø 8mm	
Voor modellen:	AMX, AMX-E, AMX-ER, AMX-R, AUX, AUX_, AUX-E, AUX-ER, AUX-R, CR, ECOMAX-402, ECOMAX-502, UX-30, UX-30B, UX-30E, UX-30EB, UX-60, UX-60B, UX-60E, UX-60EB	

		
1		
bestelnr.	502228	fabrikantnr. 00-324384-000
omschrijving	moer voor terugslagklep ø 35mm SB 30	
Voor modellen:	AM-10, AM-11, AM-141, AM-600, AM-600C, AM-600CR, AM-600R, AM-700, AM900, AM900-10N, AM900-90, AMS900, AMS900-10N, AMX, AMX-10HL, AMX-90, AMX-900, AMX-E, AMX-ER, AMXR, AMX-R, AMXR-900, AMXS, AMXS-900, AMXT, AMXTS, AMXX, AMXX-1300, AMXXR, AMXXR-1300, AMXXS, AMXXS-1300, AMXXT, AUP, AUP-90, AUPS, AUX, AUX_, AUX-E, AUX-ER, AUX-R, AUXX, AUXX-1300, AUXXL, AUXXL-11N, AUXXLS-11N, AUXXR, AUXXR-1300, AUXXS, AUXXS-1300... (Andere modellen die u kunt zien in de webshop)	

diversen

		
1		
bestelnr.	518129	fabrikantnr. 136763
omschrijving	aslager koper H 32mm D1 ø 38mm D2 ø 32mm ID ø 25.4mm	



			
1			
bestelnr.	530469	fabrikantnr.	325308-1
omschrijving	plug voor spoelarm rubber L 24mm D1 ø 34mm inbouw ø 20mm ID ø 15mm		
Voor modellen:	CNR, CR, ECW		

			
1			
bestelnr.	511676	fabrikantnr.	00-324097-000 00-883281-001 883281-1
omschrijving	waterinloop voor tank kunststof D1 ø 18mm voor HOBART		
Voor modellen:	AM-600, AM-600C, AM-600CR, AM-600R, AM900, AM900-10N, AM900-90, AMS900, AMS900-10N, AMX, AMX-10HL, AMX-90, AMX-900, AMX-E, AMX-ER, AMXR, AMX-R, AMXR-900, AMXS, AMXS-900, AMXT, AMXTS, AMXX, AMXX-1300, AMXXR, AMXXR-1300, AMXXS, AMXXS-1300, AMXXT, AUP, AUP-90, AUPS, AUX, AUX-E, AUX-ER, AUX-R, AUXX, AUXX-1300, AUXXL, AUXXL-11N, AUXXLS-11N, AUXXR, AUXXR-1300, AUXXS, AUXXS-1300, AUXXT, AUXXTS, ECOMAX-602-11, ECOMAX-602S-11, ECOMAX-612-10...(Andere modellen die u kunt zien in de webshop)		

deurmechanieken			
bouten			
			
1			
bestelnr.	502219	fabrikantnr.	01-240151-001 01-240151-1
omschrijving	deuras ø 8mm L 15mm draad M5 RVS		
Voor modellen:	ECOMAX-402, ECOMAX-502, FP, FX, FX-McDonalds, GP, GX		

veren			
rolveren			
			
1			
bestelnr.	519496	fabrikantnr.	774749-6
omschrijving	rolveer B 40mm ID ø 10.5mm noklengte 52mm		
Voor modellen:	CN, CNA, CNB, CNR, CR, FTN		

			
1			
bestelnr.	517409	fabrikantnr.	774749-3
omschrijving	rolveer B 40mm ID ø 10.5mm noklengte 54mm		
Voor modellen:	CSA, FTN		

			
1			
bestelnr.	519515	fabrikantnr.	229277
omschrijving	rolveer B 40mm ID ø 35mm noklengte 23mm		
Voor modellen:	CX, FTT, FTX, FUX		



			
1			
bestelnr.	520590	fabrikantnr.	01-245278-7
omschrijving	rolveer B 55mm ID ø 11mm noklengte 30mm		

			
1			
bestelnr.	694272	fabrikantnr.	299110 378591
omschrijving	rolveer B 65mm ID ø 48mm noklengte 24mm		
Voor modellen:	UW-100, UW-105, UW-120, UW-125, UW-200, UW-205		

			
1			
bestelnr.	519514	fabrikantnr.	774749-5
omschrijving	rolveer compleet B 40mm ID ø 10.5mm noklengte 49mm		
Voor modellen:	CN, CNA, CNB, CNR, CR, FTN		

			
1			
bestelnr.	519492	fabrikantnr.	774749-2
omschrijving	rolveer compleet B 40mm ID ø 10.5mm noklengte 54mm		
Voor modellen:	CN, CNA, CNB, CNR, CR, CR-F, FTN		

trekveren			
			
1			
bestelnr.	504424	fabrikantnr.	00-324773-000
omschrijving	trekveer ø 20mm totale lengte 245mm draad ø 2.5mm voor deur vpe 1stuk		
Voor modellen:	UX-30, UX-30E, UX-30ES, UX-30-McDonalds, UX-30S, UX-60, UX-60E, UXD-30, UXL, UXLS		

stangen			
			
1			
bestelnr.	518362	fabrikantnr.	139321-568
omschrijving	deurstang deurstang		
Voor modellen:	CHF45, EF-40		

geleidingsplaten			
			
1			
bestelnr.	518353	fabrikantnr.	E307005
omschrijving	aanslag kunststof voor deur L 60mm B 12.5mm H 10mm		

scharnieren			
			
1			
bestelnr.	503501	fabrikantnr.	324002-2
omschrijving	deurscharnier scharnier / links inbouwpositie links		
Voor modellen:	FX, GX		

			
1			
bestelnr.	503500	fabrikantnr.	324002-1
omschrijving	deurscharnier scharnier / rechts inbouwpositie rechts		
Voor modellen:	FX, GX		



1

bestelnr.	518547	fabrikantnr.	139321-267
omschrijving	deurscharnier scharnier inbouwpositie links		
Voor modellen:	GE-400, GW-600, GW-600S, GW-601, GW-601S		

lagerscharnieren

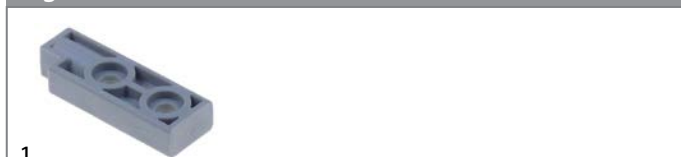

1

bestelnr.	502225	fabrikantnr.	01-294108-001 01-294108-1
omschrijving	Scharnierblok kunststof Dr.G1: M5		
Voor modellen:	ECOMAX-402, ECOMAX-502		
Toebehoren voor	502225		

	bestelnr.	502219	fabrikantnr.	01-240151-001 01-240151-1
	deuras ø 8mm L 15mm draad M5 RVS			

deurgeleiding



1

bestelnr.	698702	fabrikantnr.	325064-4
omschrijving	glijrail L 812mm B 31mm		
Voor modellen:	CN, CNA, CNB, CNR, CR		

deurstoppers



1

bestelnr.	505295	fabrikantnr.	01-240741-001 01-240741-1
omschrijving	deurstopper H 7.5mm L 17mm B 10mm		
Voor modellen:	ECOMAX-402, ECOMAX-502		

deurassen



1

bestelnr.	524883	fabrikantnr.	774495-1
omschrijving	as ø 10mm L 76mm voor vaatwasmachine deur		
Voor modellen:	CN, CNA, CNB, CNR, CR, CR-F, CSA, ECOMAX-800, FTN		

sluitingen



1

bestelnr.	512287	fabrikantnr.	01-240763-001 01-510284-1
omschrijving	deursluiting L 51mm B 35mm H 13mm		
Voor modellen:	ECOMAX-402, ECOMAX-502		



1

bestelnr.	518298	fabrikantnr.	139321-1116
omschrijving	pen deurafsluiting		



1

bestelnr.	701126	fabrikantnr.	324221
omschrijving	snapslot L 33mm met rol draad M12x1,75 voor vaatwasser		
Voor modellen:	ECOMAX-700, FE, FX, GX, UX-30, UX-30E, UX-30ES, UX-30-McDonalds, UX-30S, UX-60, UX-60E		

diversen



1

bestelnr.	698634	fabrikantnr.	324322
omschrijving	afhouder H 30mm L 125mm B 30mm		
Voor modellen:	AMX, AMX-E, AMX-ER, AMX-R, AUX, AUX_, AUX-E, AUX-ER, AUX-R, HE, HE-P, HX, HX-30, HX-30E, HX-30ES, HX-30S, HX-40, HX-40E, HX-40ES, HX-40S, HX-E, HX-ES, HX-S		



1

bestelnr.	503502	fabrikantnr.	228693-1
omschrijving	bus		
Voor modellen:	FE-W, FM-30U, FM-400U, FM-500, FX, GX, HX, HX-30, HX-30E, HX-30ES, HX-30S, HX-40, HX-40E, HX-40ES, HX-40S, HX-60-EHL, HX-E, HX-ES, HX-S, UW-55		

2 mechaniek en apparaattoebehoren



1

bestelnr.	504376	fabrikantnr.	01-240176-001 01-240176-1
omschrijving	glijlager kunststof OD ø 15mm ID ø 8mm D2 ø 10mm		
Voor modellen:	ECOMAX-402, ECOMAX-502, FP, FX, FX-McDonalds, GP, GX		



1

bestelnr.	519524	fabrikantnr.	00-226640-000
omschrijving	handvat voor deurmechaniek PVC ø 23mm L 122mm		
Voor modellen:	AM-10, AM-11, AM-12E, AM-12EC, AM-12ER, AM-141, AM-600, AM-600C, AM-600CR, AM-600R, AMX, AMX-E, AMX-ER, AMX-R, AUX, AUX-E, AUX-ER, AUX-R, ECOMAX-602-10, ECOMAX-602-11, ECOMAX-602S-11, ECOMAX-612-10, ECOMAX-612S-10, FM-400H, FM-500H, HE, HE600-HL, HE-P, HX, HX-60-EHL, HX-E, HX-ES, HX-S, UX-30EH, UX-30ESH, UX-30H, UX-30-McDonalds, UX-30SH		



1

bestelnr.	502218	fabrikantnr.	00-883947-001 883947-1
omschrijving	onderdelenset voor deurmechaniek hendellas voor greepbeugel		
Voor modellen:	AM-10, AM-11, AM-141, AM900-10N, AM900-90, AMS900-10N, AMX, AMX-10HL, AMX-90, AMXR, AMXS, AMXT, AMXTS, AMXX, AMXXR, AMXXS, AUP, AUP-90, AUPS, AUX, AUXR, AUXXS, AUXXT, AUXXTS, ECOMAX-602-10, ECOMAX-602-11, ECOMAX-602S-11, ECOMAX-612-10, ECOMAX-612S-10		



1

bestelnr.	524926	fabrikantnr.	323930-1
omschrijving	pakking voor lager ID ø 12mm H 23mm L 30mm B 12mm inbouwpositie links		
Voor modellen:	FE, FE-W		



1

bestelnr.	524925	fabrikantnr.	323930-2
omschrijving	pakking voor lager ID ø 12mm H 23mm L 30mm B 12mm inbouwpositie rechts		
Voor modellen:	FE, FE-W		



1

bestelnr.	502227	fabrikantnr.	00-883931-001 883931-1
omschrijving	spanner voor trekveer ø 10mm L 285mm draad M10x1,5		
Voor modellen:	AM-10, AM-11, AM-141, AM900-10N, AM900-90, AMS900-10N, AMX, AMX-10HL, AMX-90, AMXR, AMXS, AMXT, AMXTS, AMXX, AMXXR, AMXXS, AUP, AUP-90, AUPS, AUX, AUXL-11N, AUXLS-11N, AUXR, AUXXS, AUXXT, AUXXTS, ECOMAX-602-10, ECOMAX-602-11, ECOMAX-602S-11, ECOMAX-612-10, ECOMAX-612S-10		



1

bestelnr.	524458	fabrikantnr.	324194 886253-1
omschrijving	sponsrubberpakking voor deur L 560mm B 19mm materiaaldikte 4mm		
Voor modellen:	FX, GX		



1

bestelnr.	519523	fabrikantnr.	01-240764-001 01-240764-1
omschrijving	veer voor deursluiting L 45mm B 25mm		
Voor modellen:	ECOMAX-402, ECOMAX-502		

schroefnippels



1

bestelnr.	505288	fabrikantnr.	00-695664-004 695664-4
omschrijving	moer draad M25x1,5 H 6mm SB 30 vpe 1stuk voor kabelwartel		
Voor modellen:	CN-Protronic, CN-Smartronic, CP-Protronic, ECOMAX-402, ECOMAX-502		

gordijnen

gordijnen



1

bestelnr.	533134	fabrikantnr.	229436-4
omschrijving	gordijn B 1095mm H 400mm spoeltechniek		
Voor modellen:	FTX, FUX		



1

bestelnr.	533135	fabrikantnr.	229436-6
omschrijving	gordijn B 1095mm H 643mm spoeltechniek		
Voor modellen:	FTX, FUX		



1

bestelnr.	533131	fabrikantnr.	229436-1
omschrijving	gordijn B 740mm H 400mm spoeltechniek		
Voor modellen:	FTX, FUX		



1

bestelnr.	533139	fabrikantnr.	230781
omschrijving	gordijn B 625mm H 420mm spoeltechniek		
Voor modellen:	CR-F, CX		



1

bestelnr.	533140	fabrikantnr.	325346-4
omschrijving	gordijn B 750mm H 365mm spoeltechniek		
Voor modellen:	FTN		



1

bestelnr.	533138	fabrikantnr.	231602-1
omschrijving	gordijn B 640mm H 380mm spoeltechniek		
Voor modellen:	CX		



1

bestelnr.	533141	fabrikantnr.	325346-8
omschrijving	gordijn B 750mm H 385mm spoeltechniek		
Voor modellen:	FTN		



1

bestelnr.	533148	fabrikantnr.	781284-1
omschrijving	gordijn B 645mm H 290mm spoeltechniek		
Voor modellen:	CN, CNA, CNB, CNR, CR, CSA		

gordijnstangen



1

bestelnr.	533159	fabrikantnr.	231540-5 325360-7
omschrijving	gordijnstang L 655mm ø 8mm		
Voor modellen:	CN, CNA, CNB, CNR, CR, CR-F, CSA, ECOMAX-800		



1

bestelnr.	533150	fabrikantnr.	781067-1
omschrijving	gordijn B 645mm H 430mm spoeltechniek		
Voor modellen:	CN, CNA, CNB, CNR, CR, CSA, ECOMAX-800		



was- en naspoelsystemen



1

bestelnr.	507497	fabrikantnr.	00-883481-001 883481-1
omschrijving	aansluiting wasleiding \varnothing 47mm aansluiting 66x36mm		
Voor modellen:	AM-10, AM-11, AM-141, AM900-10N, AM900-90, AMS900-10N, AMX, AMX-10HL, AMX-90, AMXR, AMXS, AMXT, AMXTS, AMXX, AMXXR, AMXXS, AUP, AUP-90, AUPS, AUX, AUXXL-11N, AUXXLS-11N, AUXXR, AUXXS, AUXXT, AUXXTS, ECOMAX-602-10, ECOMAX-602-11, ECOMAX-602S-11, ECOMAX-612-10, ECOMAX-612S-10		



2

bestelnr.	524922	fabrikantnr.	898263-1
omschrijving	afstelring voor wasarmhouder ID \varnothing 49mm OD \varnothing 70mm H 3mm		
Voor modellen:	AM-700, AM900, AMS900, AMX-900, AMXR-900, AMXS-900, ECOMAX-600, ECOMAX-650		



1

bestelnr.	518114	fabrikantnr.	228643 B228643
omschrijving	bus voor naspoelarm \varnothing 14mm H 21mm		
Voor modellen:	AM-12E, AM-12EC, AM-12EF, AM-12ER, AM-600, AM-600C, AM-600CR, AM-600R, FM-30, FM-300U, FM-30U, FM-400H, FM-400U, FM-500, FM-500H, UW-100, UW-105, UW-120, UW-125, UW-135, UW-135H, UW-200, UW-205, UW-55		



1

bestelnr.	511966	fabrikantnr.	119229
omschrijving	drukveer \varnothing 23mm L 22mm draad \varnothing 1.5mm		
Voor modellen:	AM-12E, AM-12EC, AM-12EF, AM-12ER, AM-600, AM-600C, AM-600CR, AM-600R, UW-100, UW-105, UW-120, UW-125, UW-135, UW-135H, UW-200, UW-205		



1

bestelnr.	518119	fabrikantnr.	00-774072-001 774072-1
omschrijving	glijring PTFE OD \varnothing 19mm ID \varnothing 14.5mm materiaaldikte 0.5mm voor naspoelarm vpe 1stuk passend voor HOBART		
Voor modellen:	AM-10, AM-11, AM-141, AM-700, AM900, AM900-10N, AM900-90, AMS900, AMS900-10N, AMX, AMX-10HL, AMX-90, AMX-900, AMX-E, AMX-ER, AMXR, AMX-R, AMXR-900, AMXS, AMXS-900, AMXT, AMXTS, AMXX, AMXX-1300, AMXXR, AMXXR-1300, AMXXS, AMXXS-1300, AMXXT, AUP, AUP-90, AUPS, AUX, AUX_, AUX-E, AUX-ER, AUX-R, AUXX, AUXX-1300, AUXXL, AUXXL-11N, AUXXLS-11N, AUXXR, AUXXR-1300, AUXXS, AUXXS-1300, AUXXT, AUXXTS, ECOMAX-402, ECOMAX-502...(Andere modellen die u kunt zien in de webshop)		



1

bestelnr.	518120	fabrikantnr.	00-774072-002 774072-2
omschrijving	glijring PTFE OD \varnothing 21mm ID \varnothing 16mm materiaaldikte 0.5mm voor naspoelarm vpe 1stuk		
Voor modellen:	AM-10, AM-11, AM-141, AM-700, AM900, AM900-10N, AM900-90, AMS900, AMS900-10N, AMX, AMX-10HL, AMX-90, AMX-900, AMX-E, AMX-ER, AMXR, AMX-R, AMXR-900, AMXS, AMXS-900, AMXT, AMXTS, AMXX, AMXX-1300, AMXXR, AMXXR-1300, AMXXS, AMXXS-1300, AMXXT, AUP, AUP-90, AUPS, AUX, AUX_, AUX-E, AUX-ER, AUX-R, AUXX, AUXX-1300, AUXXL, AUXXL-11N, AUXXLS-11N, AUXXR, AUXXR-1300, AUXXS, AUXXS-1300, AUXXT, AUXXTS, ECOMAX-402, ECOMAX-502...(Andere modellen die u kunt zien in de webshop)		



1

bestelnr.	511678	fabrikantnr.	00-774072-007 774072-7
omschrijving	glijring PTFE OD \varnothing 24mm ID \varnothing 13mm materiaaldikte 1mm voor naspoelarm vpe 1stuk		
Voor modellen:	AM-10, AM-11, AM-141, AMX, AMX-10HL, AMXR, AMXS, AMXX, AMXXR, AMXXS, AUP, AUP-90, AUPS, AUX, AUXXR, AUXXS, ECOMAX-402, ECOMAX-502, ECOMAX-602-10, ECOMAX-602-11, ECOMAX-602S-11, ECOMAX-612-10, ECOMAX-612S-10, FP, FX, FX-McDonalds, GP, GX		





1

bestelnr.	518127	fabrikantnr.	119227 B119227
omschrijving	glijring voor wasarm inbouwpositie boven/onder OD \varnothing 40mm ID \varnothing 19.4mm materiaaldikte 6.2mm		
Voor modellen:	AM-12E, AM-12EC, AM-12EF, AM-12ER, LM-12E, UW-100, UW-105, UW-120, UW-125, UW-135, UW-135H, UW-200, UW-205		



			
1			
bestelnr.	510112	fabrikantnr.	139321-107 139321-873 E454002
omschrijving	kartelschroef draad M10 draad L 10mm ø 22mm H 4.5mm RVS		
Voor modellen:	GE-400, GW-600, GW-600S, GW-601, GW-601S		

			
1			
bestelnr.	510638	fabrikantnr.	324068
omschrijving	knelring ID ø 41mm OD ø 45mm dikte 3mm		
Voor modellen:	AM-700, AM900, AMS900, AMX-900, AMXR-900, AMXS-900, ECOMAX-600, ECOMAX-650, FE, FE-W, FX, GX, HE, HE600-HL, HE-P, HX, HX-30, HX-30E, HX-30ES, HX-30S, HX-40, HX-40E, HX-40ES, HX-40S, HX-60-EHL, HX-E, HX-ES, HX-S		

			
1			
bestelnr.	694621	fabrikantnr.	324751
omschrijving	knelring ID ø 58.5mm OD ø 64mm dikte 3mm		
Voor modellen:	AMX, AMX-E, AMX-ER, AMX-R, AMXX-1300, AMXXR-1300, AMXXS-1300, AMXXT, AUX, AUX_, AUX-E, AUX-ER, AUX-R, AUXX-1300, AUXXL, AUXXR-1300, AUXXS-1300, AUXXT, ECOMAX-700, UX, UX-30, UX-30B, UX-30E, UX-30EB, UX-30EH, UX-30ES, UX-30ESB, UX-30ESH, UX-30H, UX-30-McDonalds, UX-30S, UX-30SB, UX-30SH, UX-60, UX-60B, UX-60E, UX-60EB, UX-60EH, UX-60EHB, UX-60H, UX-60HB, UXD-30, UXL, UXLS, UXS, UXT, UXTH, UXTHL, UXTHLS, UXTHS...(Andere modellen die u kunt zien in de webshop)		

			
1			
bestelnr.	530468	fabrikantnr.	493414
omschrijving	lagerbus voor naspoelarm inbouwpositie boven/onder ø 15mm ID ø 12mm H 16mm		
Voor modellen:	CNR, CR, CR-F		

			
1			
bestelnr.	517454	fabrikantnr.	308031 E308031
omschrijving	moer voor wasarm OD ø 35mm dikte 11mm kunststof		
Voor modellen:	ECOMAX-601, H-60		

			
1			
bestelnr.	518139	fabrikantnr.	01-240021-001 01-240021-1
omschrijving	moer voor wasarmhouder ø 60mm		
Voor modellen:	ECOMAX-402, ECOMAX-502, FP, FX, FX-McDonalds, GP, GX		

			
1			
bestelnr.	524512	fabrikantnr.	324698-1
omschrijving	moer voor wasarmhouder ø 74mm		
Voor modellen:	AMX, AMX-E, AMX-ER, AMX-R, AMXX-1300, AMXXR-1300, AMXXS-1300, AMXXT, AUX, AUX_, AUX-E, AUX-ER, AUX-R, AUXX-1300, AUXXL, AUXXR-1300, AUXXS-1300, AUXXT, ECOMAX-700, UX, UX-30, UX-30B, UX-30E, UX-30EB, UX-30EH, UX-30ES, UX-30ESB, UX-30ESH, UX-30H, UX-30-McDonalds, UX-30S, UX-30SB, UX-30SH, UX-60, UX-60B, UX-60E, UX-60EB, UX-60EH, UX-60EHB, UX-60H, UX-60HB, UXD-30, UXL, UXLS, UXS, UXT, UXTH, UXTHL, UXTHLS, UXTHS...(Andere modellen die u kunt zien in de webshop)		

			
1			
bestelnr.	518144	fabrikantnr.	00-883496-001 883496-1
omschrijving	moer voor wasarmhouder OD ø 74mm SB 65 gat ø 36mm		
Voor modellen:	AM-10, AM-11, AM-141, AM900-10N, AM900-90, AMS900-10N, AMX, AMX-10HL, AMX-90, AMXR, AMXS, AMXT, AMXTS, ECOMAX-602-10, ECOMAX-602-11, ECOMAX-602S-11, ECOMAX-612-10, ECOMAX-612S-10		

			
1			
bestelnr.	511634	fabrikantnr.	296092
omschrijving	naspoelarmhouder inbouwpositie boven ø 15mm H 42.5mm		
Voor modellen:	AM-12E, AM-12EC, AM-12EF, AM-12ER, AM-600, AM-600C, AM-600CR, AM-600R, UW-100, UW-105, UW-120, UW-125, UW-135, UW-135H, UW-200, UW-205		



			
1			
bestelnr.	518148	fabrikantnr.	01-240097-001 01-240097-1
omschrijving	naspoelpijp ø 17mm L 60mm		
Voor modellen:	ECOMAX-402, ECOMAX-502, FP, FX, FX-McDonalds, GP, GX		

			
1			
bestelnr.	518149	fabrikantnr.	00-883479-002 883479-2
omschrijving	naspoelpijp ø 17mm L 69mm		
Voor modellen:	AM-10, AM-11, AM-141, ECOMAX-602-10, ECOMAX-602-11, ECOMAX-602S-11, ECOMAX-612-10, ECOMAX-612S-10		

			
1			
bestelnr.	510016	fabrikantnr.	139321-180 897923
omschrijving	oogschroef voor aansluiting glansspoelmiddelcontainer		
Voor modellen:	AM-700, AM900, AMS900, AMX, AMX-900, AMX-E, AMX-ER, AMX-R, AMXR-900, AMXS-900, AMXX-1300, AMXXR-1300, AMXXS-1300, AMXXT, AUX, AUX_, AUX-E, AUX-ER, AUX-R, AUXX-1300, AUXXL, AUXXR-1300, AUXXS-1300, AUXXT, ECOMAX-600, ECOMAX-650, FE, FE-W, FX, GE-400, GW-600, GW-600S, GW-601, GW-601S, GX, HE, HE600-HL, HE-P, HX, HX-30, HX-30E, HX-30ES, HX-30S, HX-40, HX-40E, HX-40ES, HX-40S, HX-60-EHL, HX-E, HX-ES...(Andere modellen die u kunt zien in de webshop)		

			
1			
bestelnr.	524901	fabrikantnr.	371450-190
omschrijving	pakking voor pompbehuizing L 45mm B 13mm materiaaldikte 1mm rubber VPE 1m		
Voor modellen:	GF-60, GF-60S		

			
1			
bestelnr.	518116	fabrikantnr.	00-172986-019 172986-19
omschrijving	pakking voor wasarmhouder rubber ø 60mm ID ø 47mm materiaaldikte 1mm		
Voor modellen:	AMX-900, AMXS-900, ECOMAX-402, ECOMAX-502, ECOMAX-650, FE, FE-W, FP, FX, FX-McDonalds, GC, GC11, GC12, GC31, GC32, GC41, GC42, GP, GX, HE, HE600-HL, HE-P, HX, HX-30, HX-30E, HX-30ES, HX-30S, HX-40, HX-40E, HX-40ES, HX-40S, HX-60-EHL, HX-E, HX-ES, HX-S		

			
1			
bestelnr.	524924	fabrikantnr.	226643
omschrijving	pakking voor wasarmhouder Tesnit BA-50 ID ø 22mm L 71mm B 45mm materiaaldikte 2mm		
Voor modellen:	AM-12E, AM-12EC, AM-12EF, AM-12ER, FM-30, FM-30U, FM-400H, FM-400U, FM-500, FM-500H, UW-105, UW-120, UW-125, UW-200, UW-205, UW-55		

			
1			
bestelnr.	524684	fabrikantnr.	885500-1
omschrijving	plug voor wasarm ø 43mm ID ø 27mm		
Voor modellen:	CN, CNA, CNB, CNR, CSA, ECOMAX-800, FTN		

			
1			
bestelnr.	518003	fabrikantnr.	139321-28 139321-872
omschrijving	schroefkap		
Voor modellen:	GE-400, GW-600, GW-600S, GW-601, GW-601S		

			
1			
bestelnr.	511679	fabrikantnr.	00-324071-000
omschrijving	T-stuk aansluiting 17.5mm kunststof L 80mm B 40mm aansluiting 1: 13.5mm aansluiting 2: 13.5mm passend voor HOBART		
Voor modellen:	AM-10, AM-11, AM-141, AM900-10N, AM900-90, AMS900-10N, AMX, AMX-10HL, AMX-90, AMXR, AMXS, AMXT, AMXTS, AMXX, AMXXR, AMXXS, AUP, AUP-90, AUPS, AUX, AUXXL-11N, AUXXLS-11N, AUXXR, AUXXS, AUXXT, AUXXTS, ECOMAX-402, ECOMAX-602-10, ECOMAX-602-11, ECOMAX-602S-11, ECOMAX-612-10, ECOMAX-612S-10, ECOMAX-700, FE, FP, FX, FX-McDonalds, GC, GC11, GC12, GC31, GC32, GP, GX, UX, UXL, UXLS, UXS, UXT, UXTH...(Andere modellen die u kunt zien in de webshop)		

			
Toebehoren voor	511679		
bestelnr.	520573	fabrikantnr.	00-324510-202 324510-202
slangklem ø 20mm draad ø 2mm vpe 1stuk			



			
1			
bestelnr.	517403	fabrikantnr.	00-172986-035 172986-35
omschrijving	vlakpakking EPDM OD ø 71mm ID ø 61mm materiaaldikte 1.5mm vpe 1stuk		
Voor modellen:	AM-10, AM-11, AM-141, AM900-10N, AM900-90, AMS900-10N, AMX, AMX-10HL, AMX-90, AMXR, AMXS, AMXT, AMXTS, AMXX, AMXXR, AMXXS, AUP, AUP-90, AUPS, AUXX, AUXXL-11N, AUXXLS-11N, AUXXR, AUXXS, AUXXT, AUXXTS, ECOMAX-602-10, ECOMAX-602-11, ECOMAX-602S-11, ECOMAX-612-10, ECOMAX-612S-10		



			
1			
bestelnr.	511651	fabrikantnr.	00-172986-022 172986-22
omschrijving	vlakpakking rubber OD ø 71mm ID ø 59mm materiaaldikte 2mm voor wasarmhouder vpe 1stuk		
Voor modellen:	AMX, AMX-E, AMX-ER, AMX-R, AMXX-1300, AMXXR-1300, AMXXS-1300, AMXXT, AUX, AUX-, AUX-E, AUX-ER, AUX-R, AUXX-1300, AUXXL, AUXXR-1300, AUXXS-1300, AUXXT, CR, ECOMAX-700, UX, UX-30, UX-30B, UX-30E, UX-30EB, UX-30EH, UX-30ES, UX-30ESB, UX-30ESH, UX-30H, UX-30-McDonalds, UX-30S, UX-30SB, UX-30SH, UX-60, UX-60B, UX-60E, UX-60EB, UX-60EH, UX-60EHB, UX-60H, UX-60HB, UXD-30, UXL, UXLS, UXS, UXT, UXTH, UXTHL, UXTHLS...(Andere modellen die u kunt zien in de webshop)		

			
1			
bestelnr.	524880	fabrikantnr.	883974-001 883974-1
omschrijving	wasarmlager inbouwpositie boven/onder ø 22mm H 37mm draad 3/4"		

			
1			
bestelnr.	524831	fabrikantnr.	01-510702-1 883974-002 883974-2
omschrijving	wasarmlager inbouwpositie boven/onder ø 22mm H 53mm voor moer draad 3/4"		

				
1				
bestelnr.	518079	fabrikantnr.	734803-1	
omschrijving	wasarmlager voor moer			
Voor modellen:	AM-700, AM900, AMS900, AMX-900, AMXR-900, AMXS-900, ECOMAX-600, ECOMAX-650, FE, FE-W, FX, GX, HE, HE600-HL, HE-P, HX, HX-60-EHL, HX-E, HX-ES, HX-S			
Reparatie-onderdelen voor	518079			
	bestelnr.	510634	fabrikantnr.	324042
	wasarmlager ø 22mm H 39mm			
	bestelnr.	510637	fabrikantnr.	324043
	moer voor wasarmhouder			

			
1			
bestelnr.	518633	fabrikantnr.	139321-643
omschrijving	waspijp		
Voor modellen:	CHF45, EF-40		

				
1				
bestelnr.	511670	fabrikantnr.	00-883529-001 883529-1	
omschrijving	waspijp ø 28x56mm RVS L-vorm L1 685mm L2 275mm			
Voor modellen:	AM-10, AM-11, AM-141, AM900-10N, AM900-90, AMS900-10N, AMX, AMX-10HL, AMX-90, AMXR, AMXS, AMXT, AMXTS, AMXX, AMXXR, AMXXS, AUP, AUP-90, AUPS, AUXX, AUXXR, AUXXS, AUXXT, AUXXTS, ECOMAX-602-10, ECOMAX-602-11, ECOMAX-602S-11, ECOMAX-612-10, ECOMAX-612S-10			
Toebehoren voor	511670			
	bestelnr.	507497	fabrikantnr.	00-883481-001 883481-1
	aansluiting wasleiding ø 47mm aansluiting 66x36mm			

was- en naspoelsystemen (per fabrikant)

HOBART

			
1			
bestelnr.	513145	fabrikantnr.	139321-943
omschrijving	wasarm L 510mm sproeiers 10 inbouw ø 16mm inbouwpositie boven en onder		
Voor modellen:	CHH-50, CHH-60D, CHH-70D, EH-60, EH-70		



bestelnr.	524657	fabrikantnr.	01-294032-001 01-294032-1
omschrijving	wasarm L 390mm sproeiers 7 inbouw ø 17/45mm		
Voor modellen:	ECOMAX-402		
Reparatie-onderdelen voor	524657		
	bestelnr.	524665	fabrikantnr. 01-240028-001 01-240028-1
	blindsproeier voor reiniging M20		
Toebehoren voor	524657		
	bestelnr.	518153	fabrikantnr. 01-294038-001 01-294038-1
	wasarmhouder inbouwpositie boven		



bestelnr.	524645	fabrikantnr.	01-240050-001 01-240050-1
omschrijving	wasarm L 515mm sproeiers 8 inbouw ø 17/45mm inbouwpositie boven/onder		
Voor modellen:	AM-10, AM-11, AM-141, ECOMAX-502, ECOMAX-602-10, ECOMAX-602-11, ECOMAX-602S-11, ECOMAX-612-10, ECOMAX-612S-10, FP, FX, FX-McDonalds, GP, GX		
Reparatie-onderdelen voor	524645		
	bestelnr.	524665	fabrikantnr. 01-240028-001 01-240028-1
	blindsproeier voor reiniging M20		

	bestelnr.	524665	fabrikantnr. 01-240028-001 01-240028-1
	blindsproeier voor reiniging M20		
Voor modellen:	AM-10, AM-11, AM-141, ECOMAX-402, ECOMAX-502, ECOMAX-602-10, ECOMAX-602-11, ECOMAX-602S-11, ECOMAX-612-10, ECOMAX-612S-10, FP, FX, FX-McDonalds, GP, GX		



bestelnr.	517590	fabrikantnr.	00-324691-000 00-324798-002 324798-2
omschrijving	wasarm inbouwpositie boven/onder L 690mm sproeiers 20		
Voor modellen:	ECOMAX-700, UX, UX-30, UX-30B, UX-30E, UX-30EB, UX-30EH, UX-30ES, UX-30ESB, UX-30ESH, UX-30H, UX-30-McDonalds, UX-30S, UX-30SB, UX-30SH, UX-60, UX-60B, UX-60E, UX-60EB, UX-60EH, UX-60EHB, UX-60H, UX-60HB, UXL, UXLS, UXS, UXT, UXTH, UXTHL, UXTHLS, UXTHS, UXTL, UXTLH, UXTLHS, UXTLS, UXTS		



bestelnr.	518629	fabrikantnr.	324039 324444 883472-1
omschrijving	wasarm L 512mm sproeiers 8 inbouw ø 16/45,5mm inbouwpositie boven en onder		
Voor modellen:	AM-700, AM900, AMS900, AMX-900, AMXR-900, AMXS-900, ECOMAX-600, ECOMAX-650, FE, FE-W, FX, HE, HE600-HL, HE-P, HX, HX-30, HX-30E, HX-30ES, HX-30S, HX-40, HX-40E, HX-40ES, HX-40S, HX-60-EHL, HX-E, HX-ES, HX-S		



bestelnr.	517589	fabrikantnr.	00-324614-000 324798-1 883453-1
omschrijving	wasarm L 535mm sproeiers 16		
Voor modellen:	AMX, AMX-E, AMX-ER, AMX-R, AMXX-1300, AMXXR-1300, AMXXS-1300, AMXXT, AUX, AUX_, AUX-E, AUX-ER, AUX-R, AUXX-1300, AUXXL, AUXXR-1300, AUXXS-1300, AUXXT, UXD-30		







bestelnr.	517585	fabrikantnr.	00-324785-000 886610
omschrijving	eindkap voor wasarm ø 28mm H 10mm vpe 4stuk		
Voor modellen:	AMX, AMX-E, AMX-ER, AMX-R, AMXX-1300, AMXXR-1300, AMXXS-1300, AMXXT, AUX, AUX_, AUX-E, AUX-ER, AUX-R, AUXX-1300, AUXXL, AUXXR-1300, AUXXS-1300, AUXXT, ECOMAX-700, UX, UX-30, UX-30B, UX-30E, UX-30EB, UX-30EH, UX-30ES, UX-30ESB, UX-30ESH, UX-30H, UX-30-McDonalds, UX-30S, UX-30SB, UX-30SH, UX-60, UX-60B, UX-60E, UX-60EB, UX-60EH, UX-60EHB, UX-60H, UX-60HB, UXD-30, UXL, UXLS, UXS, UXT, UXTH, UXTHL, UXTHLS, UXTHS...(Andere modellen die u kunt zien in de webshop)		







			
1			
bestelnr.	517588	fabrikantnr.	01-240096-001 01-240096-1 323805 883126
omschrijving	naspoelarm inbouwpositie boven/onder L 520mm sproei-ers 9 draad 1/4"		
Voor modellen:	AM-700, ECOMAX-600, ECOMAX-650, FE, HE, HE600-HL, HE-P		
Reparatie-onderdelen voor	517588		
			
bestelnr.	510636	fabrikantnr.	324172 867429-1 886609
eindkap voor naspoelarm set 4-delig			

			
1			
bestelnr.	517587	fabrikantnr.	00-886898-001 324738 324831 886898-1
omschrijving	naspoelarm inbouwpositie onder L 680mm sproei-ers 11 draad 1/4"		
Voor modellen:	ECOMAX-700, UX, UX-30, UX-30B, UX-30E, UX-30EB, UX-30EH, UX-30ES, UX-30ESB, UX-30ESH, UX-30H, UX-30-McDo-nalds, UX-30S, UX-30SB, UX-30SH, UX-60, UX-60B, UX-60E, UX-60EB, UX-60EH, UX-60EHB, UX-60H, UX-60HB, UXL, UXLS, UXS, UXT, UXTH, UXTHL, UXTHLS, UXTHS, UXTL, UXTLH, UXTLHS, UXTLS, UXTS		

			
1			
bestelnr.	510636	fabrikantnr.	324172 867429-1 886609
omschrijving	eindkap voor naspoelarm set 4-delig		
Voor modellen:	AM-700, AM900, AMS900, AMX, AMX-900, AMX-E, AMX-ER, AMX-R, AMXR-900, AMXS-900, AMXX-1300, AMXXR-1300, AMXXS-1300, AMXXT, AUX, AUX_, AUX-E, AUX-ER, AUX-R, AUXX-1300, AUXXL, AUXXR-1300, AUXXS-1300, AUXXT, ECOMAX-600, ECOMAX-650, ECOMAX-700, FE, FE-W, FX, GX, HE, HE600-HL, HE-P, HX, HX-30, HX-30E, HX-30ES, HX-30S, HX-40, HX-40E, HX-40ES, HX-40S, HX-60-EHL, HX-E, HX-ES, HX-S, UX, UX-30, UX-30B...(Andere modellen die u kunt zien in de webshop)		

			
1			
bestelnr.	524658	fabrikantnr.	01-294029-001 01-294029-1
omschrijving	naspoelarm L 395mm sproei-ers 7 inbouw ø 14mm met naspoelstift		
Voor modellen:	ECOMAX-402		
Reparatie-onderdelen voor	524658		
			
bestelnr.	511678	fabrikantnr.	00-774072-007 774072-7
glijring PTFE OD ø 24mm ID ø 13mm materiaaldikte 1mm voor naspoelarm vpe 1stuk			
			
bestelnr.	518119	fabrikantnr.	00-774072-001 774072-1
glijring PTFE OD ø 19mm ID ø 14.5mm materiaaldikte 0.5mm voor naspoelarm vpe 1stuk passend voor HOBART			
			
bestelnr.	518120	fabrikantnr.	00-774072-002 774072-2
glijring PTFE OD ø 21mm ID ø 16mm materiaaldikte 0.5mm voor naspoelarm vpe 1stuk			

			
1			
bestelnr.	524659	fabrikantnr.	01-240096-003 01-240096-3
omschrijving	naspoelarm L 515mm sproei-ers 8 inbouw ø 16mm met naspoelstift editie FX		
Voor modellen:	AM-10, AM-11, AM-141, ECOMAX-502, ECOMAX-602-10, ECOMAX-602-11, ECOMAX-602S-11, ECOMAX-612-10, ECO-MAX-612S-10, FP, FX, FX-McDonalds, GP, GX		
Reparatie-onderdelen voor	524659		
			
bestelnr.	511678	fabrikantnr.	00-774072-007 774072-7
glijring PTFE OD ø 24mm ID ø 13mm materiaaldikte 1mm voor naspoelarm vpe 1stuk			
			
bestelnr.	518119	fabrikantnr.	00-774072-001 774072-1
glijring PTFE OD ø 19mm ID ø 14.5mm materiaaldikte 0.5mm voor naspoelarm vpe 1stuk passend voor HOBART			
			
bestelnr.	518120	fabrikantnr.	00-774072-002 774072-2
glijring PTFE OD ø 21mm ID ø 16mm materiaaldikte 0.5mm voor naspoelarm vpe 1stuk			
			
bestelnr.	518147	fabrikantnr.	01-240095-001 01-240095-1
naspoelarmas			

Tabel wordt vervolgd op de volgende pagina



Reparatie-onderdelen voor 524659

	bestelnr.	518152	fabrikantnr.	01-240205-001 01-240205-1324036
kartelmoer draad M12x1 ø 32mm H 3mm inbouwpositie boven/onder RVS voor wasarm ID ø 11.5mm OD ø 32mm materiaaldikte 3mm				



1	bestelnr.	503183	fabrikantnr.	01-240096-004 01-240096-4
omschrijving naspoelarm L 520mm inbouwpositie boven/onder sproeiers 8				
Voor modellen: AM900-10N, AM900-90, AMS900-10N, AMX, AMX-10HL, AMX-90, AMXR, AMXS, AMXT, AMXTS, AMXX, AMXXR, AMXXS, AUP, AUP-90, AUPS, AUXX, AUXXL-11N, AUXXLS-11N, AUXXR, AUXXS, AUXXT, AUXXTS				



1	bestelnr.	503161	fabrikantnr.	00-324052-000 00-324445-000 01-240096-002 01-240096-2
omschrijving naspoelarm L 520mm sproeiers 9 inbouw ø 16mm				
Voor modellen: AM900, AMS900, AMX, AMX-900, AMX-E, AMX-ER, AMX-R, AMXR-900, AMXS-900, AMXX-1300, AMXXR-1300, AMXXS-1300, AMXXT, AUX, AUX-, AUX-E, AUX-ER, AUX-R, AUXX-1300, AUXXL, AUXXR-1300, AUXXS-1300, AUXXT, ECOMAX-650, FE, FX, GX, HE-P, HX, HX-30, HX-30E, HX-30ES, HX-30S, HX-40, HX-40E, HX-40ES, HX-40S, HX-60-EHL, HX-E, HX-ES, HX-S, UXD-30				

1		bestelnr.	520498	fabrikantnr.	226816
omschrijving eindkap voor naspoelarm ø 16mm H 11mm					
Voor modellen: AM-12E, AM-12EC, AM-12EF, AM-12ER, AM-600, AM-600C, AM-600CR, AM-600R, FM-30, FM-30U, FM-400H, FM-400U, FM-500, FM-500H, UW-100, UW-105, UW-120, UW-125, UW-135, UW-135H, UW-200, UW-205, UW-55					

1		bestelnr.	510648	fabrikantnr.	226800-3
omschrijving naspoelsproeier					
Voor modellen: CX, FM-500, FM-500H, UW-100, UW-105, UW-120, UW-125, UW-135, UW-135H, UW-200, UW-205, UW-55, UWX					



1		bestelnr.	511656	fabrikantnr.	00-172986-018 172986-18
omschrijving vlakpakking rubber OD ø 13mm ID ø 7.5mm materiaaldikte 0.5mm vpe 1stuk					
Voor modellen: CX, FM-400H, FM-400U, FM-500, FM-500H, FTT, UW-105, UW-120, UW-125, UW-135, UW-135H, UW-200, UW-205, UW-55, UWX					



1	bestelnr.	524829	fabrikantnr.	775762-1
omschrijving was- en naspoelarm inbouwpositie boven/onder wasarm L 395mm naspoelarm L 395mm wassproeier 6 naspoelsproeier 6 inbouw ø 45/17mm				
Voor modellen: GC, GC11, GC12, GC31, GC32, GC41, GC42				





1	bestelnr.	517559	fabrikantnr.	139321-870 E990109
omschrijving wasarm wasarm L 500mm naspoelarm L 495mm wassproeier 9 naspoelsproeier 5				





1		bestelnr.	518419	fabrikantnr.	139321-784 139321-944
omschrijving eindkap voor naspoelarm					
Voor modellen: CHH-70D, CLG-25, EH-70					
Toebehoren voor 518419					
bestelnr. 528485 fabrikantnr. —					
1  O-ring EPDM materiaaldikte 1.78mm ID ø 6.07mm vpe 1stuk					

1		bestelnr.	510010	fabrikantnr.	139321-35
omschrijving wasarmkruis L1 64mm L2 60mm inbouw ø 16.5mm					
Voor modellen: GE-400, GW-600, GW-600S, GW-601, GW-601S					







			
1			
bestelnr.	518117	fabrikantnr.	226800-1
omschrijving	naspoelsproeier \varnothing 7.5mm H 21.5mm		
Voor modellen:	AM-12E, AM-12EC, AM-12EF, AM-12ER, FM-30, FM-30U, UW-100		

			
1			
bestelnr.	518146	fabrikantnr.	00-883467-001 883467-1
omschrijving	wasarmhouder inbouwpositie boven		
Voor modellen:	AM-10, AM-11, AM-141, AM900-10N, AM900-90, AMS900-10N, AMX, AMX-10HL, AMX-90, AMXR, AMXS, AMXT, AMXTS, ECOMAX-602-10, ECOMAX-602-11, ECOMAX-602S-11, ECOMAX-612-10, ECOMAX-612S-10		

				
1				
bestelnr.	518153	fabrikantnr.	01-294038-001 01-294038-1	
omschrijving	wasarmhouder inbouwpositie boven			
Voor modellen:	ECOMAX-402, ECOMAX-502			
Toebehoren voor	518153			
	bestelnr.	518116	fabrikantnr.	00-172986-019 172986-19
pakking voor wasarmhouder rubber \varnothing 60mm ID \varnothing 47mm materiaaldikte 1mm				
	bestelnr.	518139	fabrikantnr.	01-240021-001 01-240021-1
moer voor wasarmhouder \varnothing 60mm				
	bestelnr.	518143	fabrikantnr.	00-775933-003 01-515356-001 01-515356-1 775933-3
glijring voor wasarm OD \varnothing 46mm ID \varnothing 41mm materiaaldikte 3mm				
	bestelnr.	518148	fabrikantnr.	01-240097-001 01-240097-1
naspoelpijp \varnothing 17mm L 60mm				

			
1			
bestelnr.	518115	fabrikantnr.	324268 324480
omschrijving	wasarmhouder inbouwpositie boven set HE, HX passend voor HOBART		
Voor modellen:	AM-700, AM900, AMS900, AMX-900, AMXR-900, AMXS-900, ECOMAX-600, ECOMAX-650, HE, HE600-HL, HE-P, HX, HX-30, HX-30E, HX-30ES, HX-30S, HX-40, HX-40E, HX-40ES, HX-40S, HX-60-EHL, HX-E, HX-ES, HX-S		

				
1				
bestelnr.	518145	fabrikantnr.	00-883488-001 883488-1	
omschrijving	wasarmhouder inbouwpositie onder			
Voor modellen:	AM-10, AM-11, AM-141, AM900-10N, AM900-90, AMS900-10N, AMX, AMX-10HL, AMX-90, AMXR, AMXS, AMXT, AMXTS, AMXX, AMXXR, AMXXS, AUP, AUP-90, AUPS, AUXX, AUXXL-11N, AUXXL-11N, AUXXR, AUXXS, AUXXT, AUXXTS, ECOMAX-602-10, ECOMAX-602-11, ECOMAX-602S-11, ECOMAX-612-10, ECOMAX-612S-10			
Toebehoren voor	518145			
	bestelnr.	517403	fabrikantnr.	00-172986-035 172986-35
vlakpakking EPDM OD \varnothing 71mm ID \varnothing 61mm materiaaldikte 1.5mm vpe 1stuk				
	bestelnr.	518143	fabrikantnr.	00-775933-003 01-515356-001 01-515356-1 775933-3
glijring voor wasarm OD \varnothing 46mm ID \varnothing 41mm materiaaldikte 3mm				
	bestelnr.	518144	fabrikantnr.	00-883496-001 883496-1
moer voor wasarmhouder OD \varnothing 74mm SB 65 gat \varnothing 36mm				

			
1			
bestelnr.	524669	fabrikantnr.	898194-1
omschrijving	wasarmhouder inbouwpositie onder		
Voor modellen:	AM-700, AM900, AMS900, AMX-900, AMXR-900, AMXS-900, ECOMAX-600, ECOMAX-650		

				
1				
bestelnr.	530467	fabrikantnr.	ML102842	
omschrijving	wasarmhouder set H 56mm D1 \varnothing 50mm ID \varnothing 36mm			
Toebehoren voor	530467			
	bestelnr.	530468	fabrikantnr.	493414
lagerbus voor naspoelarm inbouwpositie boven/onder \varnothing 15mm ID \varnothing 12mm H 16mm				



			
bestelnr.	524680	fabrikantnr.	324670 886607
omschrijving	wasarmhouder set inbouwpositie boven ø 62mm H 112mm ID ø 51mm		
Voor modellen:	AMX, AMX-E, AMX-ER, AMX-R, AMXX-1300, AMXXR-1300, AMXXS-1300, AMXXT, AUX, AUX_, AUX-E, AUX-ER, AUX-R, AUXX-1300, AUXXL, AUXXR-1300, AUXXS-1300, AUXXT, UX-30, UX-30B, UX-30E, UX-30EB, UX-30EH, UX-30ES, UX-30ESB, UX-30ESH, UX-30H, UX-30-McDonalds, UX-30S, UX-30SB, UX-30SH, UX-60, UX-60B, UX-60E, UX-60EB, UX-60EH, UX-60EHB, UX-60H, UX-60HB, UXD-30, UXTH, UXTHL, UXTHLS, UXTHS, UXTLH, UXTLHS		

			
bestelnr.	510634	fabrikantnr.	324042
omschrijving	wasarmlager ø 22mm H 39mm		
Voor modellen:	FE, FE-W, FX, GX, HE, HX-30, HX-30E, HX-30ES, HX-30S, HX-40, HX-40E, HX-40ES, HX-40S		
Toebehoren voor	510634	bestelnr.	510637
		fabrikantnr.	324043
	 moer voor wasarmhouder		

			
bestelnr.	505253	fabrikantnr.	324727 324729+324728+324730 734804.1
omschrijving	wasarmlager ø 24mm H 58mm		
Voor modellen:	AMX, AMX-E, AMX-ER, AMX-R, AMXX-1300, AMXXR-1300, AMXXS-1300, AMXXT, AUX, AUX_, AUX-E, AUX-ER, AUX-R, AUXX-1300, AUXXL, AUXXR-1300, AUXXS-1300, AUXXT, ECOMAX-700, UX, UX-30, UX-30B, UX-30E, UX-30EB, UX-30EH, UX-30ES, UX-30ESB, UX-30ESH, UX-30H, UX-30-McDonalds, UX-30S, UX-30SB, UX-30SH, UX-60, UX-60B, UX-60E, UX-60EB, UX-60EH, UX-60EHB, UX-60H, UX-60HB, UXD-30, UXL, UXLS, UXS, UXT, UXTH, UXTHL, UXTHLS, UXTHS...(Andere modellen die u kunt zien in de webshop)		

			
bestelnr.	510635	fabrikantnr.	231893-1
omschrijving	moer voor wasarmhouder		
Voor modellen:	AM-700, AM900, AMS900, AMX-900, AMXR-900, AMXS-900, ECOMAX-600, ECOMAX-650, FE, FE-W, FX, GX, HE, HE600-HL, HE-P, HX, HX-30, HX-30E, HX-30ES, HX-30S, HX-40, HX-40E, HX-40ES, HX-40S, HX-60-EHL, HX-E, HX-ES, HX-S		

			
bestelnr.	510637	fabrikantnr.	324043
omschrijving	moer voor wasarmhouder		
Voor modellen:	FE, FE-W, FX, GX, HE, HX-30, HX-30E, HX-30ES, HX-30S, HX-40, HX-40E, HX-40ES, HX-40S		

			
bestelnr.	511671	fabrikantnr.	01-240631-001 01-240631-1 01-240631-2
omschrijving	moer voor wasarmhouder inbouwpositie onder OD ø 60mm ID ø 36mm H 45mm aansluit ø 42mm		
Voor modellen:	ECOMAX-402		

naspoelassen			
			
bestelnr.	510108	fabrikantnr.	139321-113 E327006
omschrijving	naspoeelarmas		
Voor modellen:	GE-400, GW-600, GW-600S, GW-601, GW-601S		

			
bestelnr.	513159	fabrikantnr.	139321-947
omschrijving	naspoeelarmas		
Voor modellen:	CHH-70D, EH-70		

			
bestelnr.	518147	fabrikantnr.	01-240095-001 01-240095-1
omschrijving	naspoeelarmas		
Voor modellen:	AM-10, AM-11, AM-141, AM900-10N, AM900-90, AMS900-10N, AMX, AMX-10HL, AMX-90, AMXR, AMXS, AMXT, AMXTS, AMXX, AMXXR, AMXXS, AUP, AUP-90, AUPS, AUX, AUXXL-11N, AUXXLS-11N, AUXXR, AUXXS, AUXXT, AUXXTS, ECOMAX-402, ECOMAX-502, ECOMAX-602-10, ECOMAX-602-11, ECOMAX-602S-11, ECOMAX-612-10, ECOMAX-612S-10, FP, FX, FX-McDonalds, GP, GX		



			
1			
bestelnr.	518598	fabrikantnr.	324067
omschrijving	naspoelarmas		
Voor modellen:	AM-700, AM900, AMS900, AMX, AMX-900, AMX-E, AMX-ER, AMX-R, AMXR-900, AMXS-900, AMXX-1300, AMXXT, AUX, AUX_, AUX-E, AUX-ER, AUX-R, AUXX-1300, AUXXL, AUXXT, ECOMAX-600, ECOMAX-650, FE, FE-W, FX, GX, HE, HE600-HL, HE-P, HX, HX-30, HX-30E, HX-30ES, HX-30S, HX-40, HX-40E, HX-40ES, HX-40S, HX-60-EHL, HX-E, HX-ES, HX-S, UXD-30		

			
1			
bestelnr.	524686	fabrikantnr.	324040
omschrijving	naspoelarmas ø 16mm H 59.5mm draad M16x2 draad L 14mm		
Voor modellen:	AM-700, AM900, AMS900, AMX-900, AMXR-900, AMXS-900, ECOMAX-600, ECOMAX-650, FE, FE-W, FX, GX, HE, HE600-HL, HE-P, HX, HX-30, HX-30E, HX-30ES, HX-30S, HX-40, HX-40E, HX-40ES, HX-40S, HX-60-EHL, HX-E, HX-ES, HX-S		

wasleidingen

wasleidingen

			
1			
bestelnr.	513715	fabrikantnr.	115113 139321-866
omschrijving	waspip		
Voor modellen:	ECOMAX-500		
Toebehoren voor	513715		
	bestelnr.	518339	fabrikantnr. 139321-864
	pakking D2 ø 50mm materiaaldikte 2mm met 3 schroefgaten wasarmhouder vergelijkingsnr. 437064 passend voor COLGED gat ø 50mm LA 67mm		
	bestelnr.	518461	fabrikantnr. 139321-865
	flens voor wasarmhouder		

sluitingen

snapsluitingen

fabrikantspecifiek

HOBART

			
1			
bestelnr.	701126	fabrikantnr.	324221
omschrijving	snapslot L 33mm met rol draad M12x1,75 voor vaatwasser		
Voor modellen:	ECOMAX-700, FE, FX, GX, UX-30, UX-30E, UX-30ES, UX-30-McDonalds, UX-30S, UX-60, UX-60E		

scharnieren

deurlagers

			
1			
bestelnr.	701300	fabrikantnr.	01-240709-001 01-240709-1
omschrijving	deurscharnier L 90mm B 19mm H 29mm inbouwpositie links onder materiaaldikte 3mm		
Voor modellen:	ECOMAX-502		

			
1			
bestelnr.	701301	fabrikantnr.	01-240709-002 01-240709-2
omschrijving	deurscharnier L 90mm B 19mm H 29mm inbouwpositie rechts onder materiaaldikte 3mm		
Voor modellen:	ECOMAX-502		

toebehoren

diversen

			
1			
bestelnr.	692307	fabrikantnr.	01-240789-001 01-240789-1
omschrijving	onderlegging voor scharnier ID ø 8mm OD ø 18mm kunststof materiaaldikte 1mm vpe 1stuk		
Voor modellen:	ECOMAX-502		

apparaatvoeten en eindkappen

inschroefvoeten



1

bestelnr.	701101	fabrikantnr.	01-294066-001 01-294066-1
omschrijving	apparaatvoet draad M10 draad L 60mm ø 30mm H 10mm vpe 1stuk passend voor HOBART		
Voor modellen:	ECOMAX-402, ECOMAX-502		



1

bestelnr.	513284	fabrikantnr.	371450-23
omschrijving	apparaatvoet draad M8 draad L 20mm ø 30mm H 12mm vpe 1stuk		
Voor modellen:	GF-60, GF-60S		

korven

vaatwaskorven

staaldraadkorven hoek

gemengde korven



1

bestelnr.	971013 ¹	fabrikantnr.	139321-54
omschrijving	universeelkorf L 382mm B 382mm H 90mm gaas type grofmazig		
Voor modellen:	GW-600, GW-600S, GW-601, GW-601S		

¹grofmazig

glazenkorven



1

bestelnr.	971017	fabrikantnr.	139321-58
omschrijving	glazenkorf L 382mm B 382mm H 170mm aantal rijen 3 rij afstand 120mm		
Voor modellen:	GW-600, GW-600S, GW-601, GW-601S		
Reparatie-onderdelen voor	971017		
	bestelnr.	970001	fabrikantnr. —
	glijhoek draad ø 5mm L 120mm B 120mm H 12mm L-vorm		



1

bestelnr.	971018	fabrikantnr.	139321-57
omschrijving	glazenkorf L 382mm B 382mm H 170mm aantal rijen 4 rij afstand 85mm schuine bodem		
Voor modellen:	GW-600, GW-600S, GW-601, GW-601S		

rubbers

thermische pakkingen

deurrubbers

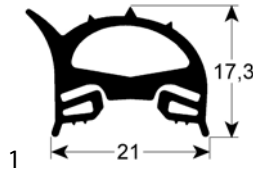

1

bestelnr.	902444	fabrikantnr.	01-235313 1235313 162007
omschrijving	deurrubber profiel 2510 B 670mm L 775mm buitenmaat		

o-ringen

EPDM

ø1,78mm



1

bestelnr.	504574	fabrikantnr.	67500-30
omschrijving	O-ring EPDM materiaaldikte 1.78mm ID ø 9.25mm vpe 1stuk		
Voor modellen:	AM-12E, AM-12EC, AM-12EF, AM-12ER, AM-600, AM-600C, AM-600CR, AM-600R, CM1E, FM-30, FM-30U, FM-400H, FM-400U, FM-500, FM-500H, FX, GX, UW-100, UW-105, UW-120, UW-125, UW-135, UW-135H, UW-200, UW-205, UW-55, WM2E		

ø2,50mm



1

bestelnr.	512500	fabrikantnr.	01-245340-001 01-245340-1
omschrijving	O-ring EPDM materiaaldikte 0.2mm ID ø 20mm vpe 1stuk		
Voor modellen:	CN-Protronic, CN-Smartronic, CP-Protronic, CS-Easytronic		



ø2,62mm

bestelnr.	529412 fabrikantnr. 139321-178
omschrijving	O-ring EPDM materiaaldikte 2.62mm ID ø 10.78mm vpe 1stuk
Voor modellen:	AM-700, AM900, AMS900, AMX, AMX-900, AMX-E, AMX-ER, AMX-R, AMXR-900, AMXS-900, AMXX-1300, AMXXR-1300, AMXXS-1300, AMXXT, AUX, AUX_, AUX-E, AUX-ER, AUX-R, AUXX-1300, AUXXL, AUXXR-1300, AUXXS-1300, AUXXT, ECOMAX-600, ECOMAX-650, FE, FE-W, FX, GE-400, GW-600, GW-600S, GW-601, GW-601S, GX, HE, HE600-HL, HE-P, HX, HX-30, HX-30E, HX-30ES, HX-30S, HX-40, HX-40E, HX-40ES, HX-40S, HX-60-EHL, HX-E, HX-ES...(Andere modellen die u kunt zien in de webshop)

bestelnr.	528919 fabrikantnr. 139321-49
omschrijving	O-ring EPDM materiaaldikte 2.62mm ID ø 20.24mm vpe 1stuk
Voor modellen:	GE-400, GW-600, GW-600S, GW-601, GW-601S

ø3,00mm

bestelnr.	510419 fabrikantnr. 00-276903-019 276903-19
omschrijving	O-ring EPDM materiaaldikte 3mm ID ø 150mm vpe 1stuk
Voor modellen:	FE-W, FX, GX, HX, HX-30, HX-30E, HX-30ES, HX-30S, HX-40, HX-40E, HX-40ES, HX-40S, HX-60-EHL, HX-E, HX-ES, HX-S

bestelnr.	510563 fabrikantnr. 276903-9
omschrijving	O-ring EPDM materiaaldikte 3mm ID ø 28mm vpe 1stuk
Voor modellen:	AM-12E, AM-12EC, AM-12EF, AM-12ER, FUX, UW-100, UW-105, UW-120, UW-125, UW-135, UW-135H, UW-200, UW-205

bestelnr.	518113 fabrikantnr. 00-276903-017 276903-17
omschrijving	O-ring EPDM materiaaldikte 3mm ID ø 46mm vpe 1stuk
Voor modellen:	FE-W, FX, GX, HX, HX-30, HX-30E, HX-30ES, HX-30S, HX-40, HX-40E, HX-40ES, HX-40S, HX-60-EHL, HX-E, HX-ES, HX-S

bestelnr.	510427 fabrikantnr. 775465-11
omschrijving	O-ring EPDM materiaaldikte 3mm ID ø 83mm vpe 1stuk
Voor modellen:	AM900, AMS900, FX, GC, GC31, GC32, GC41, GC42, GX

ø3,53mm

bestelnr.	510009 fabrikantnr. 139321-52
omschrijving	O-ring EPDM materiaaldikte 3.53mm ID ø 101.2mm vpe 1stuk
Voor modellen:	GE-400, GW-600, GW-600S, GW-601, GW-601S

bestelnr.	532537 fabrikantnr. 139321-469
omschrijving	O-ring EPDM materiaaldikte 3.53mm ID ø 113.9mm vpe 1stuk
Voor modellen:	CHF45, EF-40

bestelnr.	511322 fabrikantnr. 67500-72
omschrijving	O-ring EPDM materiaaldikte 3.53mm ID ø 20.22mm vpe 1stuk
Voor modellen:	103G, 203G, 2226, 303G, ACW, AM-12E, AM-12EC, AM-12EF, AM-12ER, AM-600, AM-600C, AM-600CR, AM-600R, CN, CNA, CNB, CNR, CR, CR-F, CSA, CX, ECOMAX-800, EWB-S, FTN, FTT, UW-100, UW-105, UW-135, UW-135H, UW-X

bestelnr.	517087	fabrikantnr.	67500-11
omschrijving	O-ring EPDM materiaaldikte 3.53mm ID ø 23.4mm vpe 1stuk		
Voor modellen:	AMX, AMX-E, AMX-ER, AMX-R, AUX, AUX_, AUX-E, AUX-ER, AUX-R, CN, CNA, CNB, CNR, CR, CR-F, CSA, ECOMAX-800, FTN, UX-30, UX-30B, UX-30E, UX-30EB, UX-30ES, UX-30ESB, UX-30S, UX-30SB, UX-60, UX-60B, UX-60E, UX-60EB		

bestelnr.	512501	fabrikantnr.	00-884505-002 884505-2
omschrijving	O-ring EPDM materiaaldikte 3.53mm ID ø 24.99mm vpe 1stuk		
Voor modellen:	CN, CNA, CNB, CN-Protronic, CNR, CN-Smartronic, CP-Protronic, CSA, CS-Easytronic, ECOMAX-800, FTN		

bestelnr.	511937	fabrikantnr.	67500-12
omschrijving	O-ring EPDM materiaaldikte 3.53mm ID ø 28.17mm vpe 1stuk		
Voor modellen:	AM-700, AM900, AMS900, AMX-900, AMXR-900, AMXS-900, ECOMAX-600, ECOMAX-650, ECW, HE, HE600-HL, HE-P, HX, HX-30, HX-30E, HX-30ES, HX-30S, HX-40, HX-40E, HX-40ES, HX-40S, HX-60-EHL, HX-E, HX-ES, HX-S		

bestelnr.	506015	fabrikantnr.	139321-738 371450-64 456052
omschrijving	O-ring EPDM materiaaldikte 3.53mm ID ø 39.69mm vpe 1stuk		
Voor modellen:	CLG-25-NA, ECOMAX-400S-12, GF-60, GF-60S		

bestelnr.	505180	fabrikantnr.	00-233982-001 00-276903-021 233982-1 276903-21
omschrijving	O-ring EPDM materiaaldikte 3.53mm ID ø 47.22mm vpe 1stuk		
Voor modellen:	CO-0611E, CO-1011E, CO-2011E, CS-0611E, CS-0612E-A, CS-1011E, CS-1012E-A, CS-1022E-A, CS-2011E, CS-2012E-A, CS-2022E-A, CSD-0611E, CSD-0612E-A, CSD-1011E, CSD-1012E-A, CSD-1022E-A, CSD-2011E, CSD-2012E-A, CSD-2022E-A, FX, GX, HX, HX-30, HX-30E, HX-30ES, HX-30S, HX-40, HX-40E, HX-40ES, HX-40S, HX-E, HX-ES, HX-S		

bestelnr.	532118	fabrikantnr.	MRTCU700565
omschrijving	O-ring EPDM materiaaldikte 3.53mm ID ø 55.56mm vpe 10stuk		

bestelnr.	532603	fabrikantnr.	139321-1041
omschrijving	O-ring EPDM materiaaldikte 3.53mm ID ø 69.85mm vpe 1stuk		

ø4,00mm

bestelnr.	502076	fabrikantnr.	00-276903-002 276903-2
omschrijving	O-ring EPDM materiaaldikte 4mm ID ø 12mm vpe 1stuk		
Voor modellen:	AM-600, AM-600C, AM-600CR, AM-600R, UW-105, UW-135, UW-135H		



bestelnr.	521035	fabrikantnr.	00-276903-028 276903-28
omschrijving	O-ring EPDM materiaaldikte 4mm ID ø 137mm vpe 1stuk		
Voor modellen:	AM-10, AM-11, AM-141, AM-700, AM900, AM900-10N, AM900-90, AMS900, AMS900-10N, AMX, AMX-10HL, AMX-90, AMX-900, AMX-E, AMX-ER, AMXR, AMX-R, AMXR-900, AMXS, AMXS-900, AMXT, AMXTS, AMXX, AMXX-1300, AMXXR, AMXXR-1300, AMXXS, AMXXS-1300, AMXXT, AUP, AUP-90, AUPS, AUX, AUX_, AUX-E, AUX-ER, AUX-R, AUXX, AUXX-1300, AUXXL, AUXXL-11N, AUXXLS-11N, AUXXR, AUXXR-1300, AUXXS, AUXXS-1300, AUXXT, AUXXTS, CN, CNA...(Andere modellen die u kunt zien in de webshop)		

bestelnr.	532663	fabrikantnr.	276903-27
omschrijving	O-ring EPDM materiaaldikte 4mm ID ø 305mm vpe 1stuk		
Voor modellen:	AMX, AMX-E, AMX-ER, AMX-R, AUX, AUX_, AUX-E, AUX-ER, AUX-R, CN, CNA, CNB, CNR, CR, CR-F, CSA, ECOMAX-800, FTN, UX-30, UX-30B, UX-30E, UX-30EB, UX-30ES, UX-30ESB, UX-30S, UX-30SB, UX-60, UX-60B, UX-60E, UX-60EB		

bestelnr.	521033	fabrikantnr.	00-276903-029 276903-29
omschrijving	O-ring EPDM materiaaldikte 4mm ID ø 50mm vpe 1stuk		
Voor modellen:	AM-10, AM-11, AM-141, AM900-10N, AM900-90, AMS900-10N, AMX, AMX-10HL, AMX-90, AMX-E, AMX-ER, AMXR, AMX-R, AMXS, AMXT, AMXTS, AMXX, AMXX-1300, AMXXR, AMXXR-1300, AMXXS, AMXXS-1300, AMXXT, AUP, AUP-90, AUPS, AUX, AUX_, AUX-E, AUX-ER, AUX-R, AUXX, AUXX-1300, AUXXL, AUXXL-11N, AUXXLS-11N, AUXXR, AUXXR-1300, AUXXS, AUXXS-1300, AUXXT, AUXXTS, ECOMAX-602-10, ECOMAX-602-11, ECOMAX-602S-11, ECOMAX-612-10, ECOMAX-612S-10, UX-30, UX-30B, UX-30E...(Andere modellen die u kunt zien in de webshop)		

bestelnr.	502250	fabrikantnr.	00-276903-031 276903-31
omschrijving	O-ring EPDM materiaaldikte 4mm ID ø 74mm vpe 1stuk		
Voor modellen:	AMX, AMX-E, AMX-ER, AMX-R, AUX, AUX_, AUX-E, AUX-ER, AUX-R, CN, CNA, CNB, CNR, CR, CR-F, CSA, ECOMAX-800, ECW, FTN, UX-30, UX-30B, UX-30E, UX-30EB, UX-30EH, UX-30ES, UX-30ESB, UX-30ESH, UX-30H, UX-30-McDonalds, UX-30S, UX-30SB, UX-30SH, UX-60, UX-60B, UX-60E, UX-60EB, UX-60EH, UX-60EHB, UX-60H, UX-60HB, UXD-30		

bestelnr.	532666	fabrikantnr.	276903-10
omschrijving	O-ring EPDM materiaaldikte 4mm ID ø 75mm vpe 1stuk		
Voor modellen:	AM-12E, AM-12EC, AM-12EF, AM-12ER, AM-600, AM-600C, AM-600CR, AM-600R, UW-100, UW-105		

ø5,34mm

bestelnr.	505092	fabrikantnr.	233982-6
omschrijving	O-ring EPDM materiaaldikte 5.34mm ID ø 43.82mm vpe 1stuk		
Voor modellen:	CS-0612E-A, CS-1012E-A, CS-2012E-A, CSD-0612E-A, CSD-1012E-A, CSD-2012E-A		

bestelnr.	510409	fabrikantnr.	00-276903-053 00-67500-016 00-67500-118 276903-53 670500-118 67500-16
omschrijving	O-ring EPDM materiaaldikte 5.34mm ID ø 56.52mm vpe 1stuk		
Voor modellen:	CR-F, CX, ECW, EWB-S, FTN, FTT, FTX, FUX, ML-104674, ML-104683, ML-104686, UW-135, UW-135H, UWX, UX-60, UX-60B, UX-60E, UX-60EB, UX-60EH, UX-60EHB, UX-60H, UX-60HB, UXT, UXTH, UXTHL, UXTHLS, UXTHS, UXTL, UXTLH, UXTLHS, UXTLS, UXTS, V1401		

diversen

bestelnr.	532664	fabrikantnr.	276903-18
omschrijving	O-ring EPDM materiaaldikte 3.5mm ID ø 103mm vpe 1stuk		
Voor modellen:	FE-W, FX, GX, HX, HX-30, HX-30E, HX-30ES, HX-30S, HX-40, HX-40E, HX-40ES, HX-40S, HX-60-EHL, HX-E, HX-ES, HX-S		



bestelnr.	532667	fabrikantnr.	276903-26
omschrijving	O-ring EPDM materiaaldikte 3.5mm ID ø 14mm vpe 1stuk		
Voor modellen:	AM-700, AM900, AMS900, AMX, AMX-900, AMX-E, AMX-ER, AMX-R, AMXR-900, AMXS-900, AMXX-1300, AMXXR-1300, AMXXS-1300, AMXXT, AUX, AUX_, AUX-E, AUX-ER, AUX-R, AUXX-1300, AUXXL, AUXXR-1300, AUXXS-1300, AUXXT, ECOMAX-600, ECOMAX-650, HE, HE600-HL, HE-P, HX, HX-30, HX-30E, HX-30ES, HX-30S, HX-40, HX-40E, HX-40ES, HX-40S, HX-60-EHL, HX-E, HX-ES, HX-S, UX-30, UX-30B, UX-30E, UX-30EB, UX-30EH, UX-30ES, UX-30ESB, UX-30ESH...(Andere modellen die u kunt zien in de webshop)		

ø5,34mm

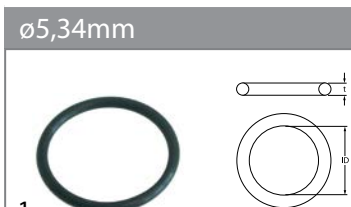

bestelnr.	521030	fabrikantnr.	01-240135-011 01-240135-11
omschrijving	O-ring Viton materiaaldikte 5.34mm ID ø 47mm vpe 1stuk		
Voor modellen:	AM-10, AM-11, AM-141, AM900-10N, AM900-90, AMS900-10N, AMX, AMX-10HL, AMX-90, AMXR, AMXS, AMXT, AMXTS, AMXX, AMXXR, AMXXS, AUP, AUP-90, AUPS, AUXX, AUXXL-11N, AUXXLS-11N, AUXXR, AUXXS, AUXXT, AUXXTS, ECOMAX-402, ECOMAX-502, ECOMAX-602-10, ECOMAX-602-11, ECOMAX-602S-11, ECOMAX-612-10, ECOMAX-612S-10, FP, FX, FX-McDonalds, GP, GX		

Viton

ø1,50mm

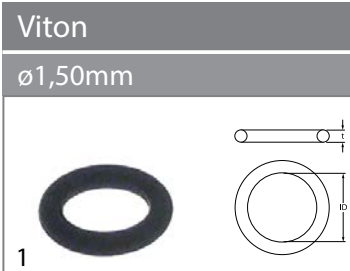

bestelnr.	521034	fabrikantnr.	00-276903-055 276903-55
omschrijving	O-ring Viton materiaaldikte 1.5mm ID ø 6mm vpe 1stuk		
Voor modellen:	AM-10, AM-11, AM-141, AM900-10N, AM900-90, AMS900-10N, AMX, AMX-10HL, AMX-90, AMXR, AMXS, AMXT, AMXTS, AMXX, AMXXR, AMXXS, AUP, AUP-90, AUPS, AUXX, AUXXL-11N, AUXXLS-11N, AUXXR, AUXXS, AUXXT, AUXXTS, ECOMAX-602-10, ECOMAX-602-11, ECOMAX-602S-11, ECOMAX-612-10, ECOMAX-612S-10		

diversen



bestelnr.	510149	fabrikantnr.	226988
omschrijving	O-ring rubber materiaaldikte 6.3mm ID ø 45mm vpe 1stuk		
Voor modellen:	AM-12E, AM-12EC, AM-12EF, AM-12ER, AM-600, AM-600C, AM-600CR, AM-600R, UW-100, UW-105, UW-135, UW-135H		

ø2,00mm

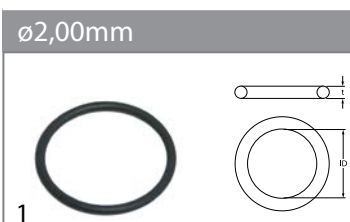

bestelnr.	521031	fabrikantnr.	00-276903-050 276903-50
omschrijving	O-ring Viton materiaaldikte 2mm ID ø 24mm vpe 1stuk		
Voor modellen:	AMX, AMX-10HL, AMX-90, AMXR, AMXS, AMXT, AMXTS, AMXX, AMXXR, AMXXS, AUP, AUP-90, AUPS, AUXX, AUXXL-11N, AUXXLS-11N, AUXXR, AUXXS, AUXXT, AUXXTS, ECOMAX-402, ECOMAX-502, ECOMAX-602-11, ECOMAX-602S-11, ECOMAX-612-10, ECOMAX-612S-10, FP, FX, FX-McDonalds, GP, GX		

asafdichtingen

fiber pakkingen

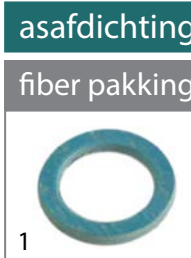

bestelnr.	529349	fabrikantnr.	139321-21
omschrijving	vlakpakking FIBER OD ø 22mm ID ø 16.5mm materiaaldikte 2mm voor draad 3/8" vpe 1stuk		
Voor modellen:	GE-400, GW-600, GW-600S, GW-601, GW-601S		

ø3,00mm

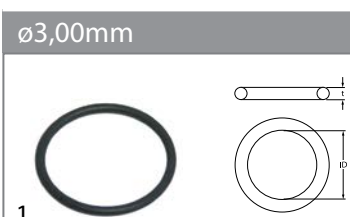



bestelnr.	521032	fabrikantnr.	00-276903-056 276903-56
omschrijving	O-ring Viton materiaaldikte 3mm ID ø 25mm vpe 1stuk		
Voor modellen:	AM-10, AM-11, AM-141, AM900-10N, AM900-90, AMS900-10N, AMX, AMX-10HL, AMX-90, AMXR, AMXS, AMXT, AMXTS, AMXX, AMXXR, AMXXS, AUP, AUP-90, AUPS, AUXX, AUXXL-11N, AUXXLS-11N, AUXXR, AUXXS, AUXXT, AUXXTS, CP-Pro-tronic, ECOMAX-602-10, ECOMAX-602-11, ECOMAX-602S-11, ECOMAX-612-10, ECOMAX-612S-10		



bestelnr.	518393	fabrikantnr.	139321-173
omschrijving	vlakpakking FIBER OD ø 24mm ID ø 17mm materiaaldikte 2mm vpe 1stuk		
Voor modellen:	GF-60S, GW-600, GW-600S, GW-601, GW-601S		



			
1			
bestelnr.	524900	fabrikantnr.	168611-3 300084-1
omschrijving	vlakpakking FIBER OD ø 30mm ID ø 21mm materiaaldikte 1.6mm vpe 1stuk		
Voor modellen:	201G, 301G, AM-12E, AM-12EC, AM-12EF, AM-12ER, AM-600, AM-600C, AM-600CR, AM-600R, CM1E, CN, CNA, CNB, CNR, CO-2011E, CR, CR-F, CS-2011E, CSA, CSD-2011E, ECO-MAX-800, FE-W, FTN, FTT, FTX, FX, GX, HX, HX-30, HX-30E, HX-30ES, HX-30S, HX-40, HX-40E, HX-40ES, HX-40S, HX-60-EHL, HX-E, HX-ES, HX-S, UW-105, UW-120, UW-125, UW-135, UW-135H, UW-200, UW-205, UWX, UX-60...(Andere modellen die u kunt zien in de webshop)		

			
1			
bestelnr.	517403	fabrikantnr.	00-172986-035 172986-35
omschrijving	vlakpakking EPDM OD ø 71mm ID ø 61mm materiaaldikte 1.5mm vpe 1stuk		
Voor modellen:	AM-10, AM-11, AM-141, AM900-10N, AM900-90, AMS900-10N, AMX, AMX-10HL, AMX-90, AMXR, AMXS, AMXT, AMXTS, AMXX, AMXXR, AMXXS, AUP, AUP-90, AUPS, AUXX, AUXXL-11N, AUXXL-11N, AUXXR, AUXXS, AUXXT, AUXXTS, ECOMAX-602-10, ECOMAX-602-11, ECOMAX-602S-11, ECOMAX-612-10, ECOMAX-612S-10		

			
2			
bestelnr.	524898	fabrikantnr.	168611-11
omschrijving	vlakpakking FIBER OD ø 35mm ID ø 22mm materiaaldikte 2mm vpe 1stuk		
Voor modellen:	AMX-ER, AMX-R, AUX-ER, AUX-R, CN, CNB, CX, ECW, UW-120, UW-125, UW-200, UW-205, UWX		

			
1			
bestelnr.	511657	fabrikantnr.	324594
omschrijving	vlakpakking rubber OD ø 12mm ID ø 6.3mm materiaaldikte 2.5mm voor wasleiding vpe 1stuk passend voor HOBART		
Voor modellen:	AM-700, AM900, AMS900, AMX, AMX-900, AMX-E, AMX-ER, AMX-R, AMXR-900, AMXS-900, AMXX-1300, AMXXR-1300, AMXXS-1300, AMXXT, AUX, AUX_, AUX-E, AUX-ER, AUX-R, AUX-1300, AUXXL, AUXXR-1300, AUXXS-1300, AUXXT, ECOMAX-600, ECOMAX-650, HX, HX-30, HX-30E, HX-30ES, HX-30S, HX-40, HX-40E, HX-40ES, HX-40S, HX-60-EHL, HX-E, HX-ES, HX-S, UX-30, UX-30B, UX-30E, UX-30EB, UX-30EH, UX-30ES, UX-30ESB, UX-30ESH, UX-30H, UX-30-McDonalds, UX-30S...(Andere modellen die u kunt zien in de webshop)		

rubber pakkingen			
			
1			
bestelnr.	507495	fabrikantnr.	00-775305-001 172513 775305-1
omschrijving	pakking OD ø 34mm ID ø 25.5mm materiaaldikte 2.5mm vpe 1stuk		
Voor modellen:	AM-10, AM-11, AM-141, AM-700, AM900, AM900-10N, AM900-90, AMS900, AMS900-10N, AMX, AMX-10HL, AMX-90, AMX-900, AMX-E, AMX-ER, AMXR, AMX-R, AMXR-900, AMXS, AMXS-900, AMXT, AMXTS, AMXX, AMXX-1300, AMXXR, AMXXR-1300, AMXXS, AMXXS-1300, AMXXT, AUP, AUP-90, AUPS, AUX, AUX_, AUX-E, AUX-ER, AUX-R, AUXX, AUXX-1300, AUXXL, AUXXL-11N, AUXXL-11N, AUXXR, AUXXR-1300, AUXXS, AUXXS-1300, AUXXT, AUXXTS, CM1E, CNA...(Andere modellen die u kunt zien in de webshop)		

			
1			
bestelnr.	511656	fabrikantnr.	00-172986-018 172986-18
omschrijving	vlakpakking rubber OD ø 13mm ID ø 7.5mm materiaaldikte 0.5mm vpe 1stuk		
Voor modellen:	CX, FM-400H, FM-400U, FM-500, FM-500H, FTT, UW-105, UW-120, UW-125, UW-135, UW-135H, UW-200, UW-205, UW-55, UWX		

			
1			
bestelnr.	518060	fabrikantnr.	139321-913
omschrijving	pakking rubber OD ø 132mm ID ø 122mm materiaaldikte 5mm		
Voor modellen:	CHH-50, CHH-60D, CHH-70D, EH-60, EH-70		

			
1			
bestelnr.	524055	fabrikantnr.	229323
omschrijving	vlakpakking rubber OD ø 18mm ID ø 12mm materiaaldikte 2mm vpe 1stuk		
Voor modellen:	CX, UWX		

			
1			
bestelnr.	505397	fabrikantnr.	437083
omschrijving	vlakpakking rubber OD ø 32mm ID ø 19.5mm materiaaldikte 1.5mm vpe 1stuk		
Voor modellen:	H-60		

			
1			
bestelnr.	519119	fabrikantnr.	00-172986-026 172986-26
omschrijving	vlakpakking rubber OD ø 58mm ID ø 42mm materiaaldikte 3mm vpe 1stuk		
Voor modellen:	CN, CNA, CNB, CNR, CR, CR-F, CSA, ECOMAX-800, ECW, FTN		

			
1			
bestelnr.	524881	fabrikantnr.	172 986-33
omschrijving	vlakpakking rubber OD ø 60mm ID ø 48mm materiaaldikte 3mm vpe 1stuk		
Voor modellen:	AM-700, AM900, AMS900, AMX-900, AMXR-900, AMXS-900, ECOMAX-600		

			
1			
bestelnr.	511962	fabrikantnr.	172986-15
omschrijving	vlakpakking rubber OD ø 62mm ID ø 44mm materiaaldikte 0.9mm vpe 1stuk		
Voor modellen:	AM-600, AM-600C, AM-600CR, AM-600R, FM-400H, FM-400U, FM-500, FM-500H, FTX, FUX, UW-105, UW-120, UW-135, UW-135H, UW-200, UW-55, UWX		

			
1			
bestelnr.	511651	fabrikantnr.	00-172986-022 172986-22
omschrijving	vlakpakking rubber OD ø 71mm ID ø 59mm materiaaldikte 2mm voor wasarmhouder vpe 1stuk		
Voor modellen:	AMX, AMX-E, AMX-ER, AMX-R, AMXX-1300, AMXXR-1300, AMXXS-1300, AMXXT, AUX, AUX_, AUX-E, AUX-ER, AUX-R, AUXX-1300, AUXXL, AUXXR-1300, AUXXS-1300, AUXXT, CR, ECOMAX-700, UX, UX-30, UX-30B, UX-30E, UX-30EB, UX-30EH, UX-30ES, UX-30ESB, UX-30ESH, UX-30H, UX-30-McDonalds, UX-30S, UX-30SB, UX-30SH, UX-60, UX-60B, UX-60E, UX-60EB, UX-60EH, UX-60EHB, UX-60H, UX-60HB, UXD-30, UXL, UXLS, UXS, UXT, UXTH, UXTHL, UXTHLS...(Andere modellen die u kunt zien in de webshop)		

kunststof pakkingen			
			
1			
bestelnr.	510633	fabrikantnr.	324521
omschrijving	pakking geschuimd OD ø 93mm ID ø 85mm materiaaldikte 3mm vpe 1stuk		
Voor modellen:	FX, GX, HX-30ES, HX-30S, HX-40ES, HX-40S, HX-ES, HX-S, UX-30ES, UX-30ESB, UX-30ESH, UX-30-McDonalds, UX-30S, UX-30SB, UX-30SH		

			
1			
bestelnr.	511963	fabrikantnr.	119038-1
omschrijving	vlakpakking kunststof OD ø 175mm ID ø 136mm materiaaldikte 0.125mm voor flens vpe 1stuk		
Voor modellen:	AM-12E, AM-12EC, AM-12EF, AM-12ER, AM-600, AM-600C, AM-600CR, AM-600R, UW-100, UW-105		

koper pakkingen

DIN-7603-A			
			
1			
bestelnr.	560508	fabrikantnr.	WA-E-5-29
omschrijving	vlakpakking koper OD ø 16mm ID ø 8.3mm materiaaldikte 1mm vpe 1stuk		
Voor modellen:	104G, 201G, 204G, 301G, 304G, GF-120, UW-100, UW-120, UW-125, UW-200, UW-205		

PTFE-pakkingen

			
1			
bestelnr.	518119	fabrikantnr.	00-774072-001 774072-1
omschrijving	glijring PTFE OD ø 19mm ID ø 14.5mm materiaaldikte 0.5mm voor naspoelarm vpe 1stuk passend voor HOBART		
Voor modellen:	AM-10, AM-11, AM-141, AM-700, AM900, AM900-10N, AM900-90, AMS900, AMS900-10N, AMX, AMX-10HL, AMX-90, AMX-900, AMX-E, AMX-ER, AMXR, AMX-R, AMXR-900, AMXS, AMXS-900, AMXT, AMXTS, AMXX, AMXX-1300, AMXXR, AMXXR-1300, AMXXS, AMXXS-1300, AMXXT, AUP, AUP-90, AUPS, AUX, AUX_, AUX-E, AUX-ER, AUX-R, AUXX, AUXX-1300, AUXXL, AUXXL-11N, AUXXLS-11N, AUXXR, AUXXR-1300, AUXXS, AUXXS-1300, AUXXT, AUXXTS, ECOMAX-402, ECOMAX-502...(Andere modellen die u kunt zien in de webshop)		

			
1			
bestelnr.	518120	fabrikantnr.	00-774072-002 774072-2
omschrijving	glijring PTFE OD ø 21mm ID ø 16mm materiaaldikte 0.5mm voor naspoelarm vpe 1stuk		
Voor modellen:	AM-10, AM-11, AM-141, AM-700, AM900, AM900-10N, AM900-90, AMS900, AMS900-10N, AMX, AMX-10HL, AMX-90, AMX-900, AMX-E, AMX-ER, AMXR, AMX-R, AMXR-900, AMXS, AMXS-900, AMXT, AMXTS, AMXX, AMXX-1300, AMXXR, AMXXR-1300, AMXXS, AMXXS-1300, AMXXT, AUP, AUP-90, AUPS, AUX, AUX_, AUX-E, AUX-ER, AUX-R, AUXX, AUXX-1300, AUXXL, AUXXL-11N, AUXXLS-11N, AUXXR, AUXXR-1300, AUXXS, AUXXS-1300, AUXXT, AUXXTS, ECOMAX-402, ECOMAX-502...(Andere modellen die u kunt zien in de webshop)		



			
1			
bestelnr.	511678	fabrikantnr.	00-774072-007 774072-7
omschrijving	glijring PTFE OD ø 24mm ID ø 13mm materiaaldikte 1mm voor naspoelarm vpe 1stuk		
Voor modellen:	AM-10, AM-11, AM-141, AMX, AMX-10HL, AMX-90, AMXR, AMXS, AMXX, AMXXR, AMXXS, AUP, AUP-90, AUPS, AUXX, AUXXR, AUXXS, ECOMAX-402, ECOMAX-502, ECOMAX-602-10, ECOMAX-602-11, ECOMAX-602S-11, ECOMAX-612-10, ECOMAX-612S-10, FP, FX, FX-McDonalds, GP, GX		

			
1			
bestelnr.	518346	fabrikantnr.	437090
omschrijving	vlakpakking PTFE OD ø 22mm ID ø 9.2mm materiaaldikte 1mm vpe 1stuk vergelijkingsnr. 437090 passend voor COLGED		
Voor modellen:	H-60		

			
1			
bestelnr.	518180	fabrikantnr.	303018
omschrijving	vlakpakking PTFE OD ø 40mm ID ø 35mm materiaaldikte 3mm vpe 1stuk vergelijkingsnr. 303018/371450-166 passend voor COLGED, HOBART		
Voor modellen:	CLG-25, CLG-25-NA, ECOMAX-400-12, ECOMAX-400S-12		

speciale rubbers

deurrubbers voor vaatwassers

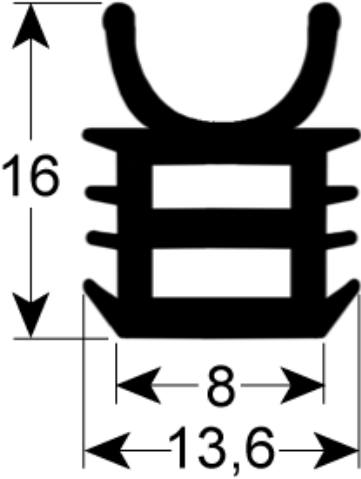
			
1			
bestelnr.	518182	fabrikantnr.	01-240077-001 01-240077-1
omschrijving	deurrubber L 564mm B 493mm VPE 1 voor vaatwasser 3-zijdig passend voor HOBART		
Voor modellen:	FP, FX, FX-McDonalds, GP, GX		

			
1			
bestelnr.	518614	fabrikantnr.	774063-1
omschrijving	deurrubber L 565mm B 427mm inbouwpositie boven voor vaatwasser 3-zijdig		
Voor modellen:	FE, FE-W		

diversen

			
1			
bestelnr.	524903	fabrikantnr.	119054
omschrijving	pakking L 147mm B 89mm voor pompbehuizing rubber ø 70mm H 2mm		
Voor modellen:	AM-12E, AM-12EC, AM-12EF, AM-12ER		

			
1			
bestelnr.	524902	fabrikantnr.	119051
omschrijving	pakking L 58mm B 26mm voor pompbehuizing FIBER H 2mm		
Voor modellen:	AM-12E, AM-12EC, AM-12EF, AM-12ER, AM-600, AM-600C, AM-600CR, AM-600R, UW-100, UW-105		

			
1			
bestelnr.	524904	fabrikantnr.	296709
omschrijving	pakking L 99mm B 78mm voor pompbehuizing rubber H 6mm		
Voor modellen:	ACW, CX, FTT, FTX, FUX, UW-135, UW-135H, UWX		

			
1			
bestelnr.	511938	fabrikantnr.	226556
omschrijving	pakking passend voor HOBART buitenhoogte 10mm OD ø 70mm ID ø 45mm voor afloop		
Voor modellen:	ACW, AM-12E, AM-12EC, AM-12EF, AM-12ER, CX, ECW, FM-30, FM-30U, FTT, FTX, FUX, UW-100, UWX		



			
1			
bestelnr.	524687	fabrikantnr.	140300 227752
omschrijving	pakking passend voor HOBART voor doseerapparaat L 60mm B 48mm materiaaldikte 1.55mm LA 48mm		
Voor modellen:	CM1E, FX, GX, WM2E		

			
1			
bestelnr.	524899	fabrikantnr.	371450-47
omschrijving	pakking voor afvalvanger L 71mm B 38mm materiaaldikte 1mm rubber LA 59mm		
Voor modellen:	GF-60, GF-60S		

			
1			
bestelnr.	524906	fabrikantnr.	323785-101
omschrijving	pakking voor afvoerventiel ø 14mm		
Voor modellen:	FX, GX		

			
1			
bestelnr.	524926	fabrikantnr.	323930-1
omschrijving	pakking voor lager ID ø 12mm H 23mm L 30mm B 12mm inbouwpositie links		
Voor modellen:	FE, FE-W		

			
1			
bestelnr.	524925	fabrikantnr.	323930-2
omschrijving	pakking voor lager ID ø 12mm H 23mm L 30mm B 12mm inbouwpositie rechts		
Voor modellen:	FE, FE-W		

aandrijfstechniek en kogellagers

kogellagers

rolkogellagers 2RS

			
1			
bestelnr.	523525	fabrikantnr.	BB-015-08 BB15-8
omschrijving	groefkogellager type 6005-2RS schacht ø 25mm OD ø 47mm B 12mm met afdichtingsschijven groefkogellager DIN 625-1		
Voor modellen:	2712, 2712C, 6430, 6430C, 6430CT, 6430T, 6460, 6460C, 6460CT, 6460M, 6460MT, 6460T, HL300, HL300AUS, HL300C, HL300CE, M802, ML-104483, ML-104484, ML-104674, ML-104683, ML-104686, ML-104687, ML-104694, ML-104696, ML-134118, ML-134185, ML-134188, V1401		

			
1			
bestelnr.	523501	fabrikantnr.	602266
omschrijving	groefkogellager type 608-2RS schacht ø 8mm OD ø 22mm B 7mm met afdichtingsschijven groefkogellager DIN 625-1		
Voor modellen:	G10R, G5R, UW-135, UW-135H, UW-55		

			
1			
bestelnr.	523509	fabrikantnr.	139321-661
omschrijving	groefkogellager type 6201-2RS schacht ø 12mm OD ø 32mm B 10mm met afdichtingsschijven groefkogellager DIN 625-1		
Voor modellen:	CHF45, EF-40		

			
1			
bestelnr.	523511	fabrikantnr.	603273 BB-20-18
omschrijving	groefkogellager type 6203-2RS schacht ø 17mm OD ø 40mm B 12mm met afdichtingsschijven groefkogellager DIN 625-1		



1

bestelnr.	523513	fabrikantnr.	BB-17-39
omschrijving	groefkogellager type 6205-2RS schacht ø 25mm OD ø 52mm B 15mm met afdichtingsschijven groefkogellager DIN 625-1		
Voor modellen:	ML-104674, ML-104683, ML-104686, V1401		



1

bestelnr.	523027	fabrikantnr.	BB-7-39
omschrijving	groefkogellager type 6207-2RS schacht ø 35mm OD ø 72mm B 17mm met afdichtingsschijven DIN 625-1		
Voor modellen:	H600, H-600, H-600T, H800, M802, ML-104687, ML-104694, ML-104696		

veren

drukveren



1

bestelnr.	511966	fabrikantnr.	119229
omschrijving	drukveer ø 23mm L 22mm draad ø 1.5mm		
Voor modellen:	AM-12E, AM-12EC, AM-12EF, AM-12ER, AM-600, AM-600C, AM-600CR, AM-600R, UW-100, UW-105, UW-120, UW-125, UW-135, UW-135H, UW-200, UW-205		



1

bestelnr.	519539	fabrikantnr.	12757-E
omschrijving	drukveer ø 36mm draad ø 3.5mm windingen 3 voor mixer		

gasdrukveren

gasdrukveren



1

bestelnr.	701241	fabrikantnr.	01-240229-001 01-240229-1
omschrijving	gasdrukveer 50N stam 205mm D1 ø 15mm D2 ø 6mm LA 425mm gat ø 5/6mm L 433mm		
Voor modellen:	FP, FX, FX-McDonalds, GP, GX		

rolveren

rolveren



1

bestelnr.	519618	fabrikantnr.	01-245278-6
omschrijving	rolveer 0.53kg B 55mm ID ø 10.5mm noklengte 28mm		



1

bestelnr.	519496	fabrikantnr.	774749-6
omschrijving	rolveer B 40mm ID ø 10.5mm noklengte 52mm		
Voor modellen:	CN, CNA, CNB, CNR, CR, FTN		



1

bestelnr.	517409	fabrikantnr.	774749-3
omschrijving	rolveer B 40mm ID ø 10.5mm noklengte 54mm		
Voor modellen:	CSA, FTN		



1

bestelnr.	519515	fabrikantnr.	229277
omschrijving	rolveer B 40mm ID ø 35mm noklengte 23mm		
Voor modellen:	CX, FTT, FTX, FUX		



1

bestelnr.	520590	fabrikantnr.	01-245278-7
omschrijving	rolveer B 55mm ID ø 11mm noklengte 30mm		



1

bestelnr.	694272	fabrikantnr.	299110 378591
omschrijving	rolveer B 65mm ID ø 48mm noklengte 24mm		
Voor modellen:	UW-100, UW-105, UW-120, UW-125, UW-200, UW-205		



1

bestelnr.	519514	fabrikantnr.	774749-5
omschrijving	rolveer compleet B 40mm ID ø 10.5mm noklengte 49mm		
Voor modellen:	CN, CNA, CNB, CNR, CR, FTN		



1

bestelnr.	519492	fabrikantnr.	774749-2
omschrijving	rolveer compleet B 40mm ID ø 10.5mm noklengte 54mm		
Voor modellen:	CN, CNA, CNB, CNR, CR, CR-F, FTN		

toebehoren

bouten



1

bestelnr.	694271	fabrikantnr.	602812
omschrijving	bout ø 10mm L 95mm		
Voor modellen:	UW-105, UW-120, UW-125, UW-200, UW-205		

rollen



1

bestelnr.	694270	fabrikantnr.	299109
omschrijving	rol ø 43mm B 75mm		
Voor modellen:	UW-105, UW-120, UW-125, UW-200, UW-205		

trekveren



1

bestelnr.	503504	fabrikantnr.	00-378622-001 378622-1
omschrijving	trekveer		
Voor modellen:	FX		



1

bestelnr.	518260	fabrikantnr.	371450-28
omschrijving	trekveer ø 10mm totale lengte 145mm draad ø 1mm		
Voor modellen:	GF-60, GF-60S		



1



bestelnr.	503503	fabrikantnr.	227855
omschrijving	trekveer ø 13mm totale lengte 147mm draad ø 1.5mm		
Voor modellen:	CM1E, FE, FE-W, FM-30U, FM-400U, FM-500, FX, GX, UW-55, WM2E		



1

bestelnr.	504424	fabrikantnr.	00-324773-000
omschrijving	trekveer ø 20mm totale lengte 245mm draad ø 2.5mm voor deur vpe 1stuk		
Voor modellen:	UX-30, UX-30E, UX-30ES, UX-30-McDonalds, UX-30S, UX-60, UX-60E, UXD-30, UXL, UXLS		



Toebehoren voor 361150	
	bestelnr. 361144 fabrikantnr. —
montageset glansspoelmiddel slangtype 4x6mm slanglengte 2m PVC/nylonslang containerfilter/terugslag- ventiel transparant	
	bestelnr. 570123 fabrikantnr. 01-246301-001 01-246301-1
PVC slang ID ø 4mm OD ø 6mm L 3.5m dikte 1mm t.max. 60°C transparant	



bestelnr.	361867	fabrikantnr.	00-883828-001 883828-1
omschrijving	doseerapparaat SEKO zonder sturing 0.4l/h 230VAC glans- spoelmiddel slang ø 4x6mm slangtype D slang Sekobril aanzuighoogte 1.5m type NPG 0.4 8W kabellengte 45mm inbouwversie tegendruk 1bar		
Voor modellen:	AM-10, AM-11, AM-141, AM900-10N, AM900-90, AMS900- 10N, AMX, AMX-10HL, AMX-90, AMXR, AMXS, AMXT, AMXTS, AMXX, AMXXR, AMXXS, AUXX, AUXXL-11N, AUXXLS- 11N, AUXXR, AUXXS, AUXXT, AUXXTS, ECOMAX-602-10, ECOMAX-602-11, ECOMAX-602S-11, ECOMAX-612-10, ECOMAX-612S-10		
Reparatie-onderdelen voor	361867		
	bestelnr. 361135	fabrikantnr.	00-775608-001 775608-1
pompslang SEKO glansspoelmiddel slang ø 3x8mm slang ø 4x6mm slangtype D slang Sekobril			



bestelnr.	361869	fabrikantnr.	00-883828-002 883828-2
omschrijving	doseerapparaat SEKO zonder sturing 3l/h 230VAC wasmid- del slang ø 4x6mm slangtype K slang Santoprene aanzuig- hoogte 1.5m type NPG 3		
Voor modellen:	AM-11, AM900-10N, AM900-90, AMS900-10N, AMX, AMX- 10HL, AMX-90, AMXR, AMXS, AMXT, AMXTS, AMXX, AMXXR, AMXXS, AUXX, AUXXL-11N, AUXXLS-11N, AUXXR, AUXXS, AUXXT, AUXXTS, ECOMAX-602-11, ECOMAX-602S-11, ECO- MAX-612-10, ECOMAX-612S-10		
Reparatie-onderdelen voor	361869		
	bestelnr. 361815	fabrikantnr.	00-775608-002 775608-2
pompslang wasmiddel slang ø 6x10mm slang ø 4x6mm slangtype K slang Santoprene type SEKO			

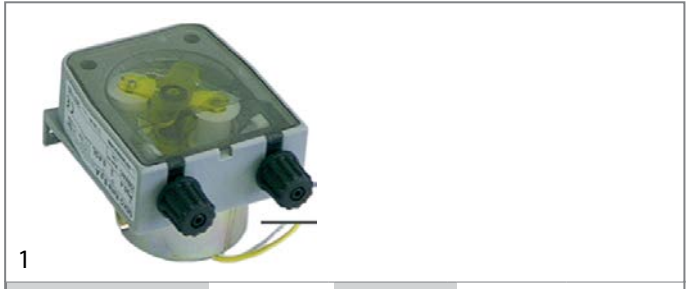

bestelnr.	361868	fabrikantnr.	00-775556-012 775556-12
omschrijving	doseerapparaat SEKO zonder sturing 3l/h 230VAC wasmid- del slang ø 4x6mm slangtype K slang Santoprene aanzuig- hoogte 1.5m type PG 8W		
Voor modellen:	ECOMAX-402, ECOMAX-502, FX, FX-McDonalds, GX		
Reparatie-onderdelen voor	361868		
	bestelnr. 361815	fabrikantnr.	00-775608-002 775608-2
pompslang wasmiddel slang ø 6x10mm slang ø 4x6mm slangtype K slang Santoprene type SEKO			

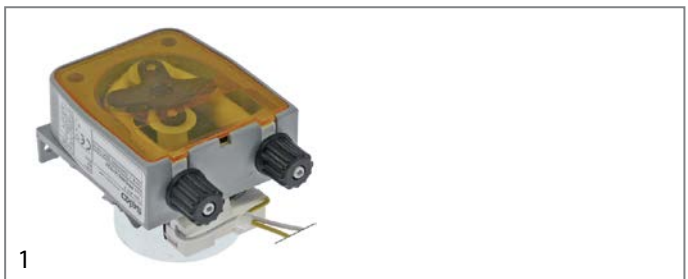



bestelnr.	361896	fabrikantnr.	775556-2 897931
omschrijving	doseerapparaat SEKO zonder sturing 3l/h 230VAC wasmid- del slang ø 4x6mm slangtype K slang Santoprene aanzuig- hoogte 1.5m type PG 8W kabellengte 430mm inbouwversie set CODE PPG0003A1024		
Voor modellen:	AM-700, AM900, AMS900, AMX-900, AMXR-900, AMXS- 900, AMXX-1300, AMXXR-1300, AMXXS-1300, AMXXT, AUXX-1300, AUXXL, AUXXR-1300, AUXXS-1300, AUXXT, ECOMAX-600, ECOMAX-650, ECOMAX-700, FX, GC, GC11, GC12, GC31, GC32, GC41, GC42, GX, UX, UXL, UXLS, UXS, UXT, UXTH, UXTHL, UXTHLS, UXTHS, UXTL, UXTLH, UXTLHS, UXTLS, UXTS		

reparatie-onderdelen

	bestelnr.	362005	fabrikantnr.	00-775608-003 775608-3
omschrijving	doseerslang SEKO glansspoelmiddel slang ø 6,25x10,55mm slanglengte 135mm slang ø 4x6mm slangtype M slang Sekobril			



			
1			
bestelnr.	361135	fabrikantnr.	00-775608-001 775608-1
omschrijving	pomp slang SEKO glansspoelmiddel slang ø 3x8mm slang ø 4x6mm slangtype D slang Sekobril		
Voor modellen:	AM-10, AM-11, AM-141, AM900-10N, AM900-90, AMS900-10N, AMX, AMX-10HL, AMX-90, AMXR, AMXS, AMXT, AMXTS, AMXX, AMXXR, AMXXS, AUXX, AUXXL-11N, AUXXLS-11N, AUXXR, AUXXS, AUXXT, AUXXTS, ECOMAX-402, ECOMAX-502, ECOMAX-602-10, ECOMAX-602-11, ECOMAX-602S-11, ECOMAX-612-10, ECOMAX-612S-10, FX, FX-McDonalds, GX		

			
1			
bestelnr.	361815	fabrikantnr.	00-775608-002 775608-2
omschrijving	pomp slang wasmiddel slang ø 6x10mm slang ø 4x6mm slangtype K slang Santoprene type SEKO		
Voor modellen:	AM-11, AM900-10N, AM900-90, AMS900-10N, AMX, AMX-10HL, AMX-90, AMXR, AMXS, AMXT, AMXTS, AMXX, AMXXR, AMXXS, AUXX, AUXXL-11N, AUXXLS-11N, AUXXR, AUXXS, AUXXT, AUXXTS, ECOMAX-402, ECOMAX-502, ECOMAX-602-11, ECOMAX-602S-11, ECOMAX-612-10, ECOMAX-612S-10, FX, FX-McDonalds, GX		

diversen



inbouwversies

			
1			
bestelnr.	361828	fabrikantnr.	00-323772-002 00-324232-002 323772-2 324232-2
omschrijving	doseerapparaat HOBART 230VAC slang ø 6mm CODE C-323772-2		
Voor modellen:	AMX, AMX-E, AMX-ER, AMX-R, AUX, AUX_, AUX-E, AUX-ER, AUX-R, FE-W, FX, GX, HX, HX-30, HX-30E, HX-30ES, HX-30S, HX-40, HX-40E, HX-40ES, HX-40S, HX-60-EHL, HX-E, HX-ES, HX-S, UX-30, UX-30B, UX-30E, UX-30EB, UX-30EH, UX-30ES, UX-30ESB, UX-30ESH, UX-30H, UX-30-McDonalds, UX-30S, UX-30SB, UX-30SH, UX-60, UX-60B, UX-60E, UX-60EB, UX-60EH, UX-60EHB, UX-60H, UX-60HB		
Reparatie-onderdelen voor	361828		
	bestelnr.	fabrikantnr.	324356-2
	 siliconeslang glansspoelmiddel silicone beige		

zuigerpompen

doseerapparaten

			
1			
bestelnr.	361838	fabrikantnr.	378625-1 378625-1P
omschrijving	doseerapparaat type TTE 200-240V wasmiddel ingang 5.5mm uitgang 5.5mm HOBART		
Voor modellen:	AMX, AMX-E, AMX-ER, AMX-R, AUX, AUX_, AUX-E, AUX-ER, AUX-R, FE-W, FX, GE-400, GF-60, GF-60S, GX, HX, HX-60-EHL, HX-E, HX-ES, HX-S, UX-30, UX-30B, UX-30E, UX-30EB, UX-30EH, UX-30ES, UX-30ESB, UX-30ESH, UX-30H, UX-30-McDonalds, UX-30S, UX-30SB, UX-30SH		

			
1			
bestelnr.	361895	fabrikantnr.	378625-1P + Zubeh_r 378630
omschrijving	doseerapparaat type TTE servicekit 200-240V wasmiddel ingang 5.5mm uitgang 5.5mm		
Voor modellen:	FX, GX		
Reparatie-onderdelen voor	361895		
	bestelnr.	fabrikantnr.	378625-1 378625-1P
	 doseerapparaat type TTE 200-240V wasmiddel ingang 5.5mm uitgang 5.5mm HOBART		

membraampompen

zelfzuigend met hulpdruk

			
1			
bestelnr.	361362	fabrikantnr.	987023 E987023 E999266
omschrijving	doseerapparaat glansspoelmiddel drukaansluiting ø 6mm drukaansluiting 6		
Voor modellen:	CLG-25, CLG-25-NA, ECOMAX-400-12, ECOMAX-400S-12, ECOMAX-500, ECOMAX-601		
Reparatie-onderdelen voor	361362		
	bestelnr.	fabrikantnr.	—
	 membraam		
	bestelnr.	fabrikantnr.	—
	 lippenventiel doseerapparaat passend voor DB2/DS5		



toebehoren

containerfilters met terugslagventiel



1

bestelnr.	361839	fabrikantnr.	227441-1
omschrijving	container filter met terugslagventiel RVS slang ϕ 6mm ϕ 20mm L 55mm voor doseerapparaat		
Voor modellen:	AM-12E, AM-12EC, AM-12EF, AM-12ER, AMX, AMX-E, AMX-ER, AMX-R, AUX, AUX-E, AUX-ER, AUX-R, ECOMAX-600, ECOMAX-700, ECW, FE, FE-W, FX, GE-400, GX, HE, HE600-HL, HX, HX-60-EHL, HX-E, HX-ES, HX-S, UX-30, UX-30B, UX-30E, UX-30EB, UX-30EH, UX-30ES, UX-30ESB, UX-30ESH, UX-30H, UX-30-McDonalds, UX-30S, UX-30SB, UX-30SH, UX-60, UX-60B, UX-60E, UX-60EB, UX-60EH, UX-60EHB, UX-60H, UX-60HB		

slangen

PVC-slangen



1

bestelnr.	570126	fabrikantnr.	01-246301-010 01-246301-10
omschrijving	PVC slang ID ϕ 4mm OD ϕ 6mm L 0.28m dikte 1mm t.max. 60°C transparant		
Voor modellen:	AMX, AMX-10HL, AMX-90, AMXR, AMXS, AMXX, AMXXR, AMXXS, AUP, AUP-90, AUPS, AUX, AUXR, AUXS, ECOMAX-402, ECOMAX-502		



1

bestelnr.	570124	fabrikantnr.	01-246301-008 01-246301-8
omschrijving	PVC slang ID ϕ 4mm OD ϕ 6mm L 0.5m dikte 1mm t.max. 60°C transparant		
Voor modellen:	AM-11, AM900-10N, AM900-90, AMS900-10N, AMX, AMX-10HL, AMX-90, AMXR, AMXS, AMXT, AMXTS, AMXX, AMXXR, AMXXS, AUP, AUP-90, AUPS, AUX, AUXL-11N, AUXLS-11N, AUXXR, AUXXS, AUXXT, AUXXTS, ECOMAX-602-11, ECOMAX-602S-11, ECOMAX-612-10, ECOMAX-612S-10		



1

bestelnr.	520090	fabrikantnr.	00-898252-002 00-898252-005 898252-2 898252-5
omschrijving	PVC slang ID ϕ 4mm OD ϕ 6mm L 2m dikte 1mm t.max. 60°C transparant		
Voor modellen:	AM-10, AM-11, AM-141, AM-700, AM900, AM900-10N, AM900-90, AMS900, AMS900-10N, AMX, AMX-10HL, AMX-90, AMX-900, AMXR, AMXR-900, AMXS, AMXS-900, AMXT, AMXTS, AMXX, AMXX-1300, AMXXR, AMXXR-1300, AMXXS, AMXXS-1300, AMXXT, AUP, AUP-90, AUPS, AUX, AUX-1300, AUXL, AUXL-11N, AUXLS-11N, AUXXR, AUXXR-1300, AUXXS, AUXXS-1300, AUXXT, AUXXTS, ECOMAX-600, ECOMAX-602-10, ECOMAX-602-11, ECOMAX-602S-11, ECOMAX-612-10, ECOMAX-612S-10, ECOMAX-650, ECOMAX-700, GC, GC11...(Andere modellen die u kunt zien in de webshop)		
Toebehoren voor	520090		
	bestelnr.	361058	fabrikantnr. —
	container filter met terugslagventiel RVS slang ϕ 4x6mm ϕ 20mm L 56mm		
	bestelnr.	361066	fabrikantnr. —
	container filter recht RVS slang ϕ 4x6mm L 37mm terugslagventiel kogelventiel		
	bestelnr.	361106	fabrikantnr. —
	container filter met gewicht en terugslagventiel RVS slang ϕ 4x6mm ϕ 21mm L 51mm terugslagventiel lippventiel		
	bestelnr.	361141	fabrikantnr. 139321-594
	container filter met gewicht keramiek slang ϕ 4mm		
	bestelnr.	361230	fabrikantnr. —
	container filter met gewicht roestvrij staal slang ϕ 4x6mm		
	bestelnr.	361462	fabrikantnr. —
	container filter met gewicht RVS slang ϕ 4x6mm		
	bestelnr.	361728	fabrikantnr. —
	container filter met 4m 4x6 slang RVS slang ϕ 4x6mm slanglengte 4000mm		



1

bestelnr.	570123	fabrikantnr.	01-246301-001 01-246301-1
omschrijving	PVC slang ID ϕ 4mm OD ϕ 6mm L 3.5m dikte 1mm t.max. 60°C transparant		
Voor modellen:	ECOMAX-402, ECOMAX-502, FP, FX, FX-McDonalds, GP, GX, UX, UXL, UXLS, UXS, UXT, UXTL, UXTLS, UXTS		

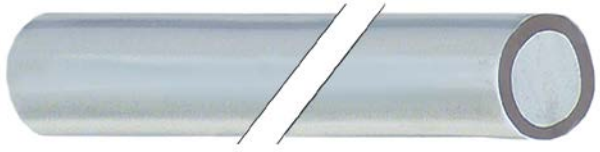

			
1			
bestelnr.	570127	fabrikantnr.	01-246301-011 01-246301-11 01-515410-011
omschrijving	PVC slang ID ø 4mm OD ø 6mm L 4m dikte 1mm t.max. 60°C transparant		
Voor modellen:	AM-10, AM-11, AM-141, AM900-10N, AM900-90, AMS900-10N, AMX, AMX-10HL, AMX-90, AMXR, AMXS, AMXT, AMXTS, AMXX, AMXXR, AMXXS, AUP, AUP-90, AUPS, AUXX, AUXXL-11N, AUXXLS-11N, AUXXR, AUXXS, AUXXT, AUXXTS, ECOMAX-602-10, ECOMAX-602-11, ECOMAX-602S-11, ECOMAX-612-10, ECOMAX-612S-10		

wandinlaten			
			
1			
bestelnr.	361865	fabrikantnr.	00-883676-001 883676-1
omschrijving	wandinlaat RVS M10x1 slang ø 5mm		
Voor modellen:	AM-11, AM900-10N, AM900-90, AMS900-10N, AMX, AMX-10HL, AMX-90, AMXR, AMXS, AMXT, AMXTS, AMXX, AMXXR, AMXXS, AUP, AUP-90, AUPS, AUXX, AUXXL-11N, AUXXLS-11N, AUXXR, AUXXS, AUXXT, AUXXTS, ECOMAX-402, ECOMAX-502, ECOMAX-602-11, ECOMAX-602S-11, ECOMAX-612-10, ECOMAX-612S-10, FP, FX, FX-McDonalds, GP, GX		

diversen			
			
1			
bestelnr.	520579	fabrikantnr.	01-246210-001 01-246210-1
omschrijving	markering voor doseerslang blauw ID ø 8mm OD ø 10mm L 40mm		
Voor modellen:	AM-10, AM-11, AM-141, AM900-10N, AM900-90, AMS900-10N, AMX, AMX-10HL, AMX-90, AMXR, AMXS, AMXT, AMXTS, AMXX, AMXXR, AMXXS, AUP, AUP-90, AUPS, AUXX, AUXXL-11N, AUXXLS-11N, AUXXR, AUXXS, AUXXT, AUXXTS, ECOMAX-402, ECOMAX-502, ECOMAX-602-10, ECOMAX-602-11, ECOMAX-602S-11, ECOMAX-612-10, ECOMAX-612S-10, FX, FX-McDonalds, GX, UX, UXL, UXLS, UXS, UXT, UXTL, UXTLS, UXTS		

slangen

toevoerslangen

RVS flexibele slangen

universele slangen

			
1			
bestelnr.	520578	fabrikantnr.	01-240316-001 01-240316-1
omschrijving	flexibeleslang RVS-omvlochten recht-haaks DN10 aansluiting 1: 3/4" aansluiting 2: 3/4" L 2000mm met geïntegreerde pakking toegelaten DVGW werkdruk 10bar testdruk 32bar plaatdruk 95bar		
Voor modellen:	AM900-10N, AM900-90, AMS900-10N, AMX, AMX-10HL, AMX-90, AMX-900, AMXR, AMXR-900, AMXS, AMXS-900, AMXT, AMXTS, AMXX, AMXX-1300, AMXXR, AMXXR-1300, AMXXS, AMXXS-1300, AMXXT, AUP, AUP-90, AUPS, AUXX, AUXX-1300, AUXXL-11N, AUXXLS-11N, AUXXR, AUXXR-1300, AUXXS, AUXXS-1300, AUXXT, AUXXTS, ECOMAX-402, ECOMAX-502, ECOMAX-602-11, ECOMAX-602S-11, ECOMAX-612-10, ECOMAX-612S-10, FP, FX, FX-McDonalds, GP, GX, UX, UXL, UXLS, UXS, UXT, UXTH...(Andere modellen die u kunt zien in de webshop)		

PVC-toevoerslangen

				
1				
bestelnr.	520010	fabrikantnr.	E143170	
omschrijving	toevoerslang PVC recht-haaks DN13 aansluitingen 3/4" L 1500mm werkdruk 10bar plaatdruk 32bar t.max. 90°C blauw toegelaten VDE vlakafdichtend			
Toebehoren voor	520010			
	bestelnr.	520053	fabrikantnr.	—
zeef aansluiting 3/4" D1 ø 26mm D2 ø 15mm vpe 10stuk rubber materiaaldikte 8mm				
	bestelnr.	520054	fabrikantnr.	—
vlakpakking rubber OD ø 23.5mm ID ø 14mm materiaaldikte 2.3mm vpe 10stuk				



1

bestelnr.	520011	fabrikantnr.	139321-1030 139321-1034
omschrijving	toevoerslang PVC recht-haaks DN13 aansluitingen 3/4" L 2000mm werkdruk 10bar plaatdruk 32bar t.max. 90°C toegelaten VDE vlakafdichtend		

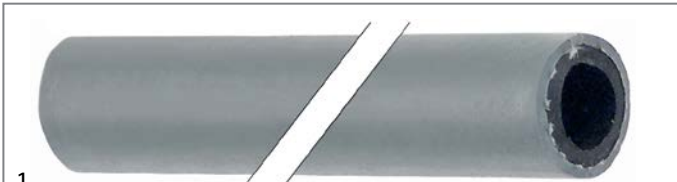

1

bestelnr.	520015	fabrikantnr.	00-775559-007 00-775559-008 00-775559-013 00-775559-016 139321-125 139321-611 775559-13 775559-16 775559-7 775559-8
omschrijving	toevoerslang ID ø 10mm OD ø 17mm L 5m werkdruk 20bar plaatdruk 60bar t.max. 95°C grijs VPE 5m		
Voor modellen:	AM-10, AM-11, AM-141, AM-700, AM900, AM900-10N, AM900-90, AMS900, AMS900-10N, AMX, AMX-10HL, AMX-90, AMX-900, AMXR, AMXR-900, AMXS, AMXS-900, AMXT, AMXTS, AMXX, AMXX-1300, AMXXR, AMXXR-1300, AMXXS, AMXXS-1300, AMXXT, AUP, AUP-90, AUPS, AUXX, AUXX-1300, AUXXL, AUXXL-11N, AUXXLS-11N, AUXXR, AUXXR-1300, AUXXS, AUXXS-1300, AUXXT, AUXXTS, CHF45, CHH-70D, ECOMAX-600, ECOMAX-602-10, ECOMAX-602-11, ECOMAX-602S-11, ECOMAX-612-10, ECOMAX-612S-10, EF-40, EH-70...(Andere modellen die u kunt zien in de webshop)		

bestelnr.	520015	fabrikantnr.	01-240159-001 01-240159-1
omschrijving	slangverbinder tule ø 23mm tule lengte 25mm totale lengte 55mm voor watervulling		



1

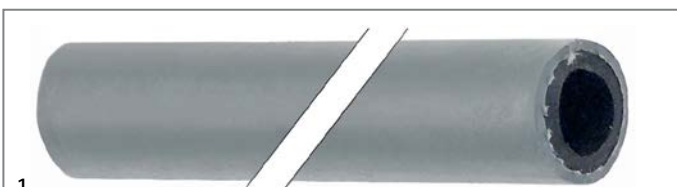

1

bestelnr.	520016	fabrikantnr.	143010
omschrijving	toevoerslang ID ø 13mm OD ø 20mm L 40m werkdruk 20bar plaatdruk 60bar t.max. 95°C grijs VPE 40m		

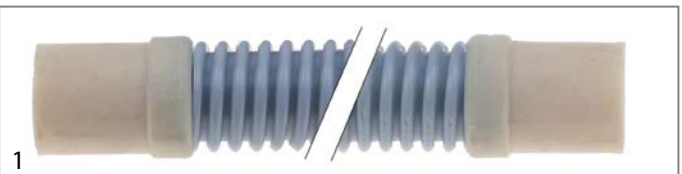
afvoerslangen

1

bestelnr.	530298	fabrikantnr.	00-324045-000
omschrijving	afvoerslang DN19 L 2100mm A ø binnen 19mm A ø buiten 25mm B ø binnen 19mm B ø buiten 25mm slang ø buiten 24mm		
Voor modellen:	AM900, AMS900, AMX-900, AMX-ER, AMX-R, AMXR-900, AMXS-900, AMXX-1300, AMXXR-1300, AMXXS-1300, AMXXT, AUX-ER, AUX-R, AUXX-1300, AUXXL, AUXXR-1300, AUXXS-1300, AUXXT, ECOMAX-402, ECOMAX-502, ECOMAX-650, FE-W, FX, GC, GC11, GC12, GC31, GC32, GC41, GC42, GX, HX, HX-30, HX-30E, HX-30ES, HX-30S, HX-40, HX-40E, HX-40ES, HX-40S, HX-60-EHL, HX-E, HX-ES, HX-S, UX, UXL, UXLS, UXS, UXT, UXTH...(Andere modellen die u kunt zien in de webshop)		

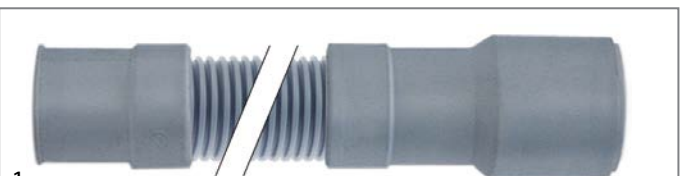

1

bestelnr.	530570	fabrikantnr.	00-323801-001 323801-1
omschrijving	afvoerslang DN21 L 2000mm A ø binnen 21mm A ø buiten 25mm B ø binnen 20/29mm B ø buiten 27/35mm slang ø buiten 25mm		
Voor modellen:	AM-10, AM-11, AM-141, AM-700, ECOMAX-402, ECOMAX-502, ECOMAX-600, ECOMAX-602-10, ECOMAX-602-11, ECOMAX-650, ECOMAX-700, FE, HE, HE600-HL, HE-P		

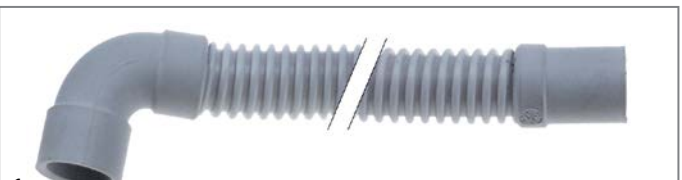

1

bestelnr.	530299	fabrikantnr.	00-883961-001 00-883961-002 01-243347-001 01-243347-1 883961-1 883961-2
omschrijving	afvoerslang DN19 L 2000mm recht ø binnen 19mm recht ø buiten 25mm haaks ø binnen 21mm haaks ø buiten 27mm slang ø buiten 25mm		
Voor modellen:	AM-700, AM900-10N, AM900-90, AMS900-10N, AMX, AMX-10HL, AMX-90, AMX-900, AMXR, AMXR-900, AMXS, AMXS-900, AMXT, AMXTS, AMXX, AMXX-1300, AMXXR, AMXXR-1300, AMXXS, AMXXS-1300, AMXXT, AUP, AUP-90, AUPS, AUXX, AUXX-1300, AUXXL-11N, AUXXLS-11N, AUXXR, AUXXR-1300, AUXXS, AUXXS-1300, AUXXT, AUXXTS, ECOMAX-600, ECOMAX-602S-11, ECOMAX-612-10, ECOMAX-612S-10, ECOMAX-700, FP, FX, FX-McDonalds, GP, GX, UX, UXL, UXLS, UXS, UXT, UXTH...(Andere modellen die u kunt zien in de webshop)		

bestelnr.	518103	fabrikantnr.	139321-911
omschrijving	afvoerslang DN32 L 2000mm recht ø binnen 31mm recht ø buiten 35mm haaks ø binnen 51mm haaks ø buiten 58mm slang ø buiten 38mm polypropyleen		
Voor modellen:	CHH-50, CHH-60D, CHH-70D, EH-60, EH-70		

industrieslangen

PVC-slangen

PVC slang niet geweven



bestelnr.	570000	fabrikantnr.	00-775611-004 775611-4
omschrijving	PVC slang ID ø 10mm OD ø 14mm L 1.1m dikte 2mm t.max. 60°C transparant		
Voor modellen:	ECOMAX-502, UXTH, UXTHS, UXTLH, UXTLHS		



bestelnr.	570126	fabrikantnr.	01-246301-010 01-246301-10
omschrijving	PVC slang ID ø 4mm OD ø 6mm L 0.28m dikte 1mm t.max. 60°C transparant		
Voor modellen:	AMX, AMX-10HL, AMX-90, AMXR, AMXS, AMXX, AMXXR, AMXXS, AUP, AUP-90, AUPS, AUXX, AUXXR, AUXXS, ECOMAX-402, ECOMAX-502		



bestelnr.	570124	fabrikantnr.	01-246301-008 01-246301-8
omschrijving	PVC slang ID ø 4mm OD ø 6mm L 0.5m dikte 1mm t.max. 60°C transparant		
Voor modellen:	AM-11, AM900-10N, AM900-90, AMS900-10N, AMX, AMX-10HL, AMX-90, AMXR, AMXS, AMXT, AMXTS, AMXX, AMXXR, AMXXS, AUP, AUP-90, AUPS, AUXX, AUXXL-11N, AUXXLS-11N, AUXXR, AUXXS, AUXXT, AUXXTS, ECOMAX-602-11, ECOMAX-602S-11, ECOMAX-612-10, ECOMAX-612S-10		





bestelnr.	520383	fabrikantnr.	H.775601
omschrijving	PVC slang ID ø 4mm OD ø 6mm L 2m dikte 1mm t.max. 60°C blauw		
Voor modellen:	H-60		
Toehoren voor	520383		
	bestelnr.	361058	fabrikantnr. —
	container filter met terugslagventiel RVS slang ø 4x6mm ø 20mm L 56mm		
	bestelnr.	361066	fabrikantnr. —
	container filter recht RVS slang ø 4x6mm L 37mm terugslagventiel kogelventiel		
	bestelnr.	361106	fabrikantnr. —
	container filter met gewicht en terugslagventiel RVS slang ø 4x6mm ø 21mm L 51mm terugslagventiel lippventiel		
	bestelnr.	361141	fabrikantnr. 139321-594
	container filter met gewicht keramiek slang ø 4mm		
	bestelnr.	361230	fabrikantnr. —
	container filter met gewicht roestvrij staal slang ø 4x6mm		
	bestelnr.	361462	fabrikantnr. —
	container filter met gewicht RVS slang ø 4x6mm		
	bestelnr.	361728	fabrikantnr. —
	container filter met 4m 4x6 slang RVS slang ø 4x6mm slanglengte 4000mm		



bestelnr.	520090	fabrikantnr.	00-898252-002 00-898252-005 898252-2 898252-5
omschrijving	PVC slang ID ø 4mm OD ø 6mm L 2m dikte 1mm t.max. 60°C transparant		
Voor modellen:	AM-10, AM-11, AM-141, AM-700, AM900, AM900-10N, AM900-90, AMS900, AMS900-10N, AMX, AMX-10HL, AMX-90, AMX-900, AMXR, AMXR-900, AMXS, AMXS-900, AMXT, AMXTS, AMXX, AMXX-1300, AMXXR, AMXXR-1300, AMXXS, AMXXS-1300, AMXXT, AUP, AUP-90, AUPS, AUXX, AUXX-1300, AUXXL, AUXXL-11N, AUXXLS-11N, AUXXR, AUXXR-1300, AUXXS, AUXXS-1300, AUXXT, AUXXTS, ECOMAX-600, ECOMAX-602-10, ECOMAX-602-11, ECOMAX-602S-11, ECOMAX-612-10, ECOMAX-612S-10, ECOMAX-650, ECOMAX-700, GC, GC11...(Andere modellen die u kunt zien in de webshop)		
Toehoren voor	520090		
	bestelnr.	361058	fabrikantnr. —
	container filter met terugslagventiel RVS slang ø 4x6mm ø 20mm L 56mm		
	bestelnr.	361066	fabrikantnr. —
	container filter recht RVS slang ø 4x6mm L 37mm terugslagventiel kogelventiel		
	bestelnr.	361106	fabrikantnr. —
	container filter met gewicht en terugslagventiel RVS slang ø 4x6mm ø 21mm L 51mm terugslagventiel lippventiel		
	bestelnr.	361141	fabrikantnr. 139321-594
	container filter met gewicht keramiek slang ø 4mm		

Tabel wordt vervolgd op de volgende pagina



Toebehoren voor	520090		
	bestelnr.	361230	fabrikantnr. —
	container filter met gewicht roestvrij staal slang \varnothing 4x6mm		
	bestelnr.	361462	fabrikantnr. —
	container filter met gewicht RVS slang \varnothing 4x6mm		
	bestelnr.	361728	fabrikantnr. —
	container filter met 4m 4x6 slang RVS slang \varnothing 4x6mm slanglengte 4000mm		

	1		
bestelnr.	570123	fabrikantnr.	01-246301-001 01-246301-1
omschrijving	PVC slang ID \varnothing 4mm OD \varnothing 6mm L 3.5m dikte 1mm t.max. 60°C transparant		
Voor modellen:	ECOMAX-402, ECOMAX-502, FP, FX, FX-McDonalds, GP, GX, UX, UXL, UXLS, UXS, UXT, UXTL, UXTLS, UXTS		

	1		
bestelnr.	570127	fabrikantnr.	01-246301-011 01-246301-11 01-515410-011
omschrijving	PVC slang ID \varnothing 4mm OD \varnothing 6mm L 4m dikte 1mm t.max. 60°C transparant		
Voor modellen:	AM-10, AM-11, AM-141, AM900-10N, AM900-90, AMS900-10N, AMX, AMX-10HL, AMX-90, AMXR, AMXS, AMXT, AMXTS, AMXX, AMXXR, AMXXS, AUP, AUP-90, AUPS, AUXX, AUXXL-11N, AUXXLS-11N, AUXXR, AUXXS, AUXXT, AUXXTS, ECOMAX-602-10, ECOMAX-602-11, ECOMAX-602S-11, ECOMAX-612-10, ECOMAX-612S-10		

	1		
bestelnr.	520027	fabrikantnr.	00-324402-005 00-324402-014 139321-126 324402-14 324402-5
omschrijving	PVC slang ID \varnothing 4mm OD \varnothing 7mm L 10m dikte 1.5mm t.max. 60°C transparant		
Voor modellen:	CN, CNB, CR, ECOMAX-402, ECOMAX-502, ECW, FTN, GE-400, GF-60, GF-60S, GW-600, GW-600S, GW-601, GW-601S		

	1		
bestelnr.	520029	fabrikantnr.	00-165168-001
omschrijving	PVC slang ID \varnothing 6mm OD \varnothing 9mm L 10m dikte 1.5mm t.max. 60°C transparant		

silicone slangen

zonder weefsel

	1		
bestelnr.	530821	fabrikantnr.	00-774080-001 774080-1
omschrijving	siliconeslang ID \varnothing 10mm OD \varnothing 15mm L 1m dikte 2.5mm werkdruk drukvrij barstdruk niet gedefinieerd t.max. 200°C transparant Shore 60°		
Voor modellen:	AM-10, AM-11, AM-141, AM-700, AM900, AM900-10N, AM900-90, AMS900, AMS900-10N, AMX, AMX-10HL, AMX-90, AMX-900, AMXR, AMXR-900, AMXS, AMXS-900, AMXT, AMXTS, AMXX, AMXX-1300, AMXXR, AMXXR-1300, AMXXS, AMXXS-1300, AMXXT, AUP, AUP-90, AUPS, AUXX, AUXX-1300, AUXXL, AUXXL-11N, AUXXLS-11N, AUXXR, AUXXR-1300, AUXXS, AUXXS-1300, AUXXT, AUXXTS, ECOMAX-402, ECOMAX-502, ECOMAX-600, ECOMAX-602-10, ECOMAX-602-11, ECOMAX-602S-11, ECOMAX-612-10, ECOMAX-612S-10, FP, FX...(Andere modellen die u kunt zien in de webshop)		

vormslangen

recht

	1		
bestelnr.	530278	fabrikantnr.	00-883776-001 883776-1
omschrijving	vormsling D1 \varnothing 24mm L 765mm voor boiler ID \varnothing 17.5mm		
Voor modellen:	AM900-10N, AM900-90, AMS900-10N, AMX, AMX-10HL, AMX-90, AMXR, AMXS, AMXT, AMXTS, AMXX, AMXXR, AMXXS, AUP, AUP-90, AUPS, AUXX, AUXXL-11N, AUXXLS-11N, AUXXR, AUXXS, AUXXT, AUXXTS, ECOMAX-602-11, ECOMAX-602S-11, ECOMAX-612-10, ECOMAX-612S-10		

	1		
bestelnr.	530276	fabrikantnr.	00-883721-001 883721-1
omschrijving	vormsling D1 \varnothing 25mm D2 \varnothing 17mm L 700mm voor waspomp		
Voor modellen:	AM900-10N, AM900-90, AMS900-10N, AMX, AMX-10HL, AMX-90, AMXR, AMXS, AMXX, AMXXR, AMXXS, AUP, AUP-90, AUPS, AUXX, AUXXL-11N, AUXXLS-11N, AUXXR, AUXXS, ECOMAX-602-11, ECOMAX-602S-11, ECOMAX-612-10, ECOMAX-612S-10		



			
1			
bestelnr.	530290	fabrikantnr.	00-883775-001 883775-1
omschrijving	vormslang slang buiten ø 26mm slang binnen ø 19mm L 655mm aansluit ø 23.5mm		
Voor modellen:	AM900-10N, AM900-90, AMS900-10N, AMX, AMX-10HL, AMX-90, AMXR, AMXS, AMXT, AMXTS, AMXX, AMXXR, AMXXS, AUP, AUP-90, AUPS, AUXX, AUXXL-11N, AUXXLS-11N, AUXXR, AUXXS, AUXXT, AUXXTS, ECOMAX-602-11, ECOMAX-602S-11, ECOMAX-612-10, ECOMAX-612S-10		

			
1			
bestelnr.	507492	fabrikantnr.	00-898247-009 898247-9
omschrijving	vormslang eindstuk A buiten ø 20mm eindstuk A binnen ø 13mm eindstuk B buiten ø 19mm eindstuk B binnen ø 12mm L 755mm		
Voor modellen:	AM-10, AM-11, AM-141, AM900-10N, AM900-90, AMS900-10N, AMX, AMX-10HL, AMX-90, AMXR, AMXS, AMXT, AMXTS, AMXX, AMXXR, AMXXS, AUP, AUP-90, AUPS, AUXX, AUXXL-11N, AUXXLS-11N, AUXXR, AUXXS, AUXXT, AUXXTS, ECOMAX-502, ECOMAX-602-10, ECOMAX-602-11, ECOMAX-602S-11, ECOMAX-612-10, ECOMAX-612S-10		

			
1			
bestelnr.	508402	fabrikantnr.	00-883680-001 883680-1
omschrijving	vormslang slang buiten ø 32mm slang binnen ø 26mm L 85mm		
Voor modellen:	AM900-10N, AM900-90, AMS900-10N, AMX, AMX-10HL, AMX-90, AMXR, AMXS, AMXT, AMXTS, AMXX, AMXXR, AMXXS, AUP, AUP-90, AUPS, AUXX, AUXXL-11N, AUXXLS-11N, AUXXR, AUXXS, AUXXT, AUXXTS, ECOMAX-602-11, ECOMAX-602S-11, ECOMAX-612-10, ECOMAX-612S-10		

			
1			
bestelnr.	507493	fabrikantnr.	00-883524-001 883524-1
omschrijving	vormslang eindstuk A buiten ø 36.5mm eindstuk A binnen ø 29mm eindstuk B buiten ø 30mm eindstuk B binnen ø 22mm L 520mm afvoertank - afvoerpomp L-vorm		
Voor modellen:	AM900-10N, AM900-90, AMS900-10N, AMX, AMX-10HL, AMX-90, AMXR, AMXS, ECOMAX-602-11, ECOMAX-612-10, ECOMAX-612S-10		

			
1			
bestelnr.	524228	fabrikantnr.	774060-1
omschrijving	vormslang vaatwasser recht vergelijkingsnr. 12127		
Voor modellen:	EWB-S, FE, HE, HE600-HL, HE-P		

S-vorm			
			
1			
bestelnr.	510386	fabrikantnr.	324199
omschrijving	vormslang slang buiten ø 21mm slang binnen ø 16mm L 195mm VPE 1 S-vorm		
Voor modellen:	FX, GX, HX, HX-30, HX-30E, HX-30ES, HX-30S, HX-40, HX-40E, HX-40ES, HX-40S, HX-60-EHL, HX-E, HX-ES, HX-S		

L-vorm			
			
1			
bestelnr.	507494	fabrikantnr.	00-898247-002 898247-2
omschrijving	vormslang eindstuk A buiten ø 19mm eindstuk A binnen ø 13mm eindstuk B buiten ø 19mm eindstuk B binnen ø 13mm L 485mm voor wasleiding		
Voor modellen:	AM-10, AM-11, AM-141, AM900-10N, AM900-90, AMS900-10N, AMX, AMX-10HL, AMX-90, AMXR, AMXS, AMXT, AMXTS, AMXX, AMXXR, AMXXS, AUP, AUP-90, AUPS, AUXX, AUXXL-11N, AUXXLS-11N, AUXXR, AUXXS, AUXXT, AUXXTS, ECOMAX-602-10, ECOMAX-602-11, ECOMAX-602S-11, ECOMAX-612-10, ECOMAX-612S-10, UXTH, UXTHL, UXTHLS, UXTHS, UXTLH, UXTLHS		

voor vaatwassers			
diversen			
			
1			
bestelnr.	570126	fabrikantnr.	01-246301-010 01-246301-10
omschrijving	PVC slang ID ø 4mm OD ø 6mm L 0.28m dikte 1mm t.max. 60°C transparant		
Voor modellen:	AMX, AMX-10HL, AMX-90, AMXR, AMXS, AMXX, AMXXR, AMXXS, AUP, AUP-90, AUPS, AUXX, AUXXR, AUXXS, ECOMAX-402, ECOMAX-502		



bestelnr.	570124	fabrikantnr.	01-246301-008 01-246301-8
omschrijving	PVC slang ID ø 4mm OD ø 6mm L 0.5m dikte 1mm t.max. 60°C transparant		
Voor modellen:	AM-11, AM900-10N, AM900-90, AMS900-10N, AMX, AMX-10HL, AMX-90, AMXR, AMXS, AMXT, AMXTS, AMXX, AMXXR, AMXXS, AUP, AUP-90, AUPS, AUXX, AUXXL-11N, AUXXLS-11N, AUXXR, AUXXS, AUXXT, AUXXTS, ECOMAX-602-11, ECOMAX-602S-11, ECOMAX-612-10, ECOMAX-612S-10		



bestelnr.	520592	fabrikantnr.	775552-1 895495 898045-1
omschrijving	toevoerslang servicekit aansluitingen 3/4" L 2000mm RVS recht-haaks		
Voor modellen:	AMX, AMX-900, AMX-E, AMXR-900, AMXS-900, AMXX-1300, AMXXR-1300, AMXXS-1300, AMXXT, AUX, AUX-E, AUXX-1300, AUXXL, AUXXR-1300, AUXXS-1300, AUXXT, ECOMAX-650, FX, GX, UX, UXL, UXLS, UXS, UXT, UXTH, UXTHS, UXTL, UXTLH, UXTLHS, UXTLS, UXTS		



bestelnr.	511679	fabrikantnr.	00-324071-000
omschrijving	T-stuk aansluiting 17.5mm kunststof L 80mm B 40mm aansluiting 1: 13.5mm aansluiting 2: 13.5mm passend voor HOBART		
Voor modellen:	AM-10, AM-11, AM-141, AM900-10N, AM900-90, AMS900-10N, AMX, AMX-10HL, AMX-90, AMXR, AMXS, AMXT, AMXTS, AMXX, AMXXR, AMXXS, AUP, AUP-90, AUPS, AUXX, AUXXL-11N, AUXXLS-11N, AUXXR, AUXXS, AUXXT, AUXXTS, ECOMAX-402, ECOMAX-602-10, ECOMAX-602-11, ECOMAX-602S-11, ECOMAX-612-10, ECOMAX-612S-10, ECOMAX-700, FE, FP, FX, FX-McDonalds, GC, GC11, GC12, GC31, GC32, GP, GX, UX, UXL, UXLS, UXS, UXT, UXTH...(Andere modellen die u kunt zien in de webshop)		
Toebehoren voor	511679		
	bestelnr.	fabrikantnr.	00-324510-202 324510-202
	slangklem ø 20mm draad ø 2mm vpe 1stuk		

fittingen, slang- en doorverbinders

slangaansluitingen

fabrikantspecifiek



bestelnr.	520591	fabrikantnr.	139321-379
omschrijving	slangaansluiting draad 1/4" haaks tule ø 12mm tule lengte 17mm totale lengte 38mm draad L 12mm koper		
Voor modellen:	GE-400, GF-60, GF-60S, GW-600, GW-600S, GW-601, GW-601S		



bestelnr.	504377	fabrikantnr.	01-240159-001 01-240159-1
omschrijving	slangverbinder tule ø 23mm tule lengte 25mm totale lengte 55mm voor watervulling		
Voor modellen:	AM-10, AM-11, AM-141, AM900-10N, AM900-90, AMS900-10N, AMX, AMX-10HL, AMX-90, AMXR, AMXS, AMXT, AMXTS, AMXX, AMXXR, AMXXS, AUP, AUP-90, AUPS, AUXX, AUXXL-11N, AUXXLS-11N, AUXXR, AUXXS, AUXXT, AUXXTS, ECOMAX-602-10, ECOMAX-602-11, ECOMAX-602S-11, ECOMAX-612-10, ECOMAX-612S-10, FP, FX, FX-McDonalds, GP, GX		

ventielen en containerinlaten

vlotterventielen

vlotterventielen



bestelnr.	518118	fabrikantnr.	897665-1
omschrijving	vlotter ingang 3/4" uitgang 13.5mm ingang 3.5l/min uitgangl/min drukbereik 0,3-10bar MÜLLER type 21.010.115 voor watercontainer reducering ingang donkerblauw reducering uitgang		
Voor modellen:	CNA, CNB, CNR, CSA, FTN		

waterontharders

diverse toebehoren



bestelnr.	530174	fabrikantnr.	00-775918-050 775918-150 775918-50
omschrijving	deksel set voor ontharder		
Voor modellen:	ECOMAX-402, ECOMAX-502, ECOMAX-602S-11, ECOMAX-612S-10		



watercircuit componenten

toevoerfilters

			
1			
bestelnr.	520261	fabrikantnr.	E927078
omschrijving	toevoerfilter draad 1/2" ID - 1/2" ID totale lengte 58mm brons netbreedte 0.4mm		

hulpmiddelen

klemmen

slangklemmen

DIN 3017 - W2

			
1			
bestelnr.	520114	fabrikantnr.	423008
omschrijving	slangklemmen Edellaal/haal ø 20-32mm breedte 9mm vpe 10stuk DIN 3017		

dubbele slangklemmen

			
1			
bestelnr.	520573	fabrikantnr.	00-324510-202
omschrijving	slangklem ø 20mm draad ø 2mm vpe 1stuk		
Voor modellen:	AMX, AMX-E, AMX-ER, AMX-R, AUX, AUX_, AUX-E, AUX-ER, AUX-R, ECOMAX-402, ECOMAX-502, ECOMAX-700, FE, FE-W, FP, FX, FX-McDonalds, GC41, GC42, GP, GX, HE, HE600-HL, HE-P, HX, HX-30, HX-30E, HX-30ES, HX-30S, HX-40, HX-40E, HX-40ES, HX-40S, HX-60-EHL, HX-E, HX-ES, HX-S, UX, UX-30, UX-30B, UX-30E, UX-30EB, UX-30EH, UX-30ES, UX-30ESB, UX-30ESH, UX-30H, UX-30-McDonalds, UX-30S, UX-30SB... (Andere modellen die u kunt zien in de webshop)		

			
1			
bestelnr.	520577	fabrikantnr.	00-324510-242
omschrijving	slangklem ø 24mm draad ø 2mm vpe 1stuk		
Voor modellen:	AMX, AMX-E, AMX-ER, AMX-R, AMXX-1300, AMXXR-1300, AMXXS-1300, AUX, AUX_, AUX-E, AUX-ER, AUX-R, AUXX-1300, AUXXR-1300, AUXXS-1300, CN, CNA, CNB, CNR, CR, ECOMAX-402, ECOMAX-502, ECOMAX-700, FE, FE-W, FP, FX, FX-McDonalds, GC, GC11, GC12, GC31, GC32, GC41, GC42, GP, GX, HE-P, HX, HX-30, HX-30E, HX-30ES, HX-30S, HX-40, HX-40E, HX-40ES, HX-40S, HX-60-EHL, HX-E, HX-ES... (Andere modellen die u kunt zien in de webshop)		

			
1			
bestelnr.	520574	fabrikantnr.	00-324510-327
omschrijving	slangklem ø 32mm draad ø 3mm vpe 1stuk		
Voor modellen:	AMX, AMX-900, AMX-E, AMX-ER, AMX-R, AMXR-900, AMXS-900, AMXX-1300, AMXXR-1300, AMXXS-1300, AMXXT, AUX, AUX-E, AUX-ER, AUX-R, AUXX-1300, AUXXL, AUXXR-1300, AUXXS-1300, AUXXT, ECOMAX-502, ECOMAX-650, ECOMAX-700, FE, FP, FX, FX-McDonalds, GP, GX, UX, UXD-30, UXL, UXLS, UXS, UXT, UXTH, UXTHL, UXTHLS, UXTHS, UXTL, UXTLH, UXTLHS, UXTLS, UXTS		

			
1			
bestelnr.	513268	fabrikantnr.	00-303340-008 00-324510-068 139321-580 303340-8 324510-68
omschrijving	slangklem ø 8-10mm draad ø 1mm vpe 1stuk		
Voor modellen:	AM-10, AM-11, AM-141, AM-700, AM900, AM900-10N, AM900-90, AMS900, AMS900-10N, AMX, AMX-10HL, AMX-90, AMX-900, AMXR, AMXR-900, AMXS, AMXS-900, AMXT, AMXTS, AMXX, AMXX-1300, AMXXR, AMXXR-1300, AMXXS, AMXXS-1300, AMXXT, AUP, AUP-90, AUPS, AUXX, AUXX-1300, AUXXL, AUXXL-11N, AUXXLS-11N, AUXXR, AUXXR-1300, AUXXS, AUXXS-1300, AUXXT, AUXXTS, CHF45, ECOMAX-600, ECOMAX-602-10, ECOMAX-602-11, ECOMAX-602S-11, ECOMAX-612-10, ECOMAX-612S-10, ECOMAX-650, ECOMAX-700, EF-40... (Andere modellen die u kunt zien in de webshop)		

dubbele slangklemmen met schroeven

			
1			
bestelnr.	505281	fabrikantnr.	00-323945-015 323945-15
omschrijving	slangklemmen ø 15mm verzinkt staal vpe 20stuk		
Voor modellen:	AM-10, AM-11, AM-141, AM-700, AM900, AM900-10N, AM900-90, AMS900, AMS900-10N, AMX, AMX-10HL, AMX-90, AMX-900, AMXR, AMXR-900, AMXS, AMXS-900, AMXT, AMXTS, AMXX, AMXX-1300, AMXXR, AMXXR-1300, AMXXS, AMXXS-1300, AMXXT, AUP, AUP-90, AUPS, AUXX, AUXX-1300, AUXXL, AUXXL-11N, AUXXLS-11N, AUXXR, AUXXR-1300, AUXXS, AUXXS-1300, AUXXT, AUXXTS, ECOMAX-402, ECOMAX-502, ECOMAX-600, ECOMAX-602-10, ECOMAX-602-11, ECOMAX-602S-11, ECOMAX-612-10, ECOMAX-612S-10, ECOMAX-612S-10, FP, FX... (Andere modellen die u kunt zien in de webshop)		



bestelnr.	505282	fabrikantnr.	00-323945-016 323945-16
omschrijving	slangklemmen ø 16mm verzinkt staal vpe 20stuk		
Voor modellen:	AM-700, AM900, AMS900, AMX, AMX-900, AMX-E, AMX-ER, AMX-R, AMXR-900, AMXS-900, AMXX-1300, AMXXR-1300, AMXXS-1300, AMXXT, AUX, AUX-E, AUX-ER, AUX-R, AUXX-1300, AUXXL, AUXXR-1300, AUXXS-1300, AUXXT, ECOMAX-402, ECOMAX-502, ECOMAX-600, ECOMAX-650, GC, UX, UXL, UXLS, UXS, UXT, UXTH, UXTHL, UXTHLS, UXTHS, UXTL, UXTLH, UXTLHS, UXTLS, UXTS		



bestelnr.	505285	fabrikantnr.	00-323945-025 323945-25
omschrijving	slangklemmen ø 25mm verzinkt staal vpe 20stuk		
Voor modellen:	AM-10, AM-11, AM-141, AM-700, AM900, AM900-10N, AM900-90, AMS900, AMS900-10N, AMX, AMX-10HL, AMX-90, AMX-900, AMX-E, AMX-ER, AMXR, AMXR-900, AMXR-900, AMXS, AMXS-900, AMXT, AMXTS, AMXX, AMXX-1300, AMXXR, AMXXR-1300, AMXXS, AMXXS-1300, AMXXT, AUP, AUP-90, AUPS, AUX, AUX-E, AUX-ER, AUX-R, AUXX, AUXX-1300, AUXXL, AUXXL-11N, AUXXLS-11N, AUXXR, AUXXR-1300, AUXXS, AUXXS-1300, AUXXT, AUXXTS, ECOMAX-402, ECOMAX-502, ECOMAX-600...(Andere modellen die u kunt zien in de webshop)		



bestelnr.	505283	fabrikantnr.	00-323945-018 323945-18
omschrijving	slangklemmen ø 18mm verzinkt staal vpe 20stuk		
Voor modellen:	AM-10, AM-11, AM-141, AM-700, AM900, AM900-10N, AM900-90, AMS900, AMS900-10N, AMX, AMX-10HL, AMX-90, AMX-900, AMX-E, AMX-ER, AMXR, AMXR-900, AMXS, AMXS-900, AMXT, AMXTS, AMXX, AMXX-1300, AMXXR, AMXXR-1300, AMXXS, AMXXS-1300, AMXXT, AUP, AUP-90, AUPS, AUX, AUX-E, AUX-ER, AUX-R, AUXX, AUXX-1300, AUXXL-11N, AUXXLS-11N, AUXXR, AUXXR-1300, AUXXS, AUXXS-1300, AUXXT, AUXXTS, ECOMAX-402, ECOMAX-502, ECOMAX-600, ECOMAX-602-10...(Andere modellen die u kunt zien in de webshop)		



bestelnr.	505286	fabrikantnr.	00-323945-029 323945-29
omschrijving	slangklemmen ø 29mm verzinkt staal vpe 20stuk		
Voor modellen:	AM900-10N, AM900-90, AMS900-10N, AMX, AMX-10HL, AMX-90, AMX-E, AMX-ER, AMXR, AMXR-900, AMXS, AMXT, AMXTS, AMXX, AMXX-1300, AMXXR, AMXXR-1300, AMXXS, AMXXS-1300, AMXXT, AUP, AUP-90, AUPS, AUX, AUX-E, AUX-ER, AUX-R, AUXX, AUXX-1300, AUXXL, AUXXL-11N, AUXXLS-11N, AUXXR, AUXXR-1300, AUXXS, AUXXS-1300, AUXXT, AUXXTS, CR, CR-F, ECOMAX-602-11, ECOMAX-602S-11, ECOMAX-612-10, ECOMAX-612S-10, ECOMAX-700, FE, GC, GC11, GC12, GC31...(Andere modellen die u kunt zien in de webshop)		



bestelnr.	505284	fabrikantnr.	00-323945-019 00-323945-021 323945-19 -alt- 323945-21
omschrijving	slangklemmen ø 21mm verzinkt staal vpe 20stuk		
Voor modellen:	AM-10, AM-11, AM-141, AM-700, AM900-10N, AM900-90, AMS900-10N, AMX, AMX-10HL, AMX-90, AMX-E, AMX-ER, AMXR, AMXR-900, AMXS, AMXT, AMXTS, AMXX, AMXX-1300, AMXXR, AMXXR-1300, AMXXS, AMXXS-1300, AMXXT, AUP, AUP-90, AUPS, AUX, AUX-E, AUX-ER, AUX-R, AUXX, AUXX-1300, AUXXL, AUXXL-11N, AUXXLS-11N, AUXXR, AUXXR-1300, AUXXS, AUXXS-1300, AUXXT, AUXXTS, ECOMAX-402, ECOMAX-502, ECOMAX-600, ECOMAX-602-10, ECOMAX-602-11, ECOMAX-602S-11, ECOMAX-612-10, ECOMAX-612S-10...(Andere modellen die u kunt zien in de webshop)		



bestelnr.	505287	fabrikantnr.	00-323945-033 323945-33
omschrijving	slangklemmen ø 33mm verzinkt staal vpe 20stuk		
Voor modellen:	AM-700, AM900, AM900-10N, AM900-90, AMS900, AMS900-10N, AMX, AMX-10HL, AMX-90, AMX-900, AMXR, AMXR-900, AMXS, AMXS-900, AMXX, AMXXR, AMXXS, AUP, AUP-90, AUPS, AUX, AUXXL-11N, AUXXLS-11N, AUXXR, AUXXS, CN-Protronic, CN-Smartronic, CP-Protronic, CR-F, ECOMAX-402, ECOMAX-502, ECOMAX-600, ECOMAX-602-11, ECOMAX-612-10, ECOMAX-612S-10, ECOMAX-650, ECOMAX-700, FX, GC31, GC32, GC41, GC42, GX		



1

bestelnr.	505293	fabrikantnr.	00-323945-035 323945-35
omschrijving	slangklemmen ø 34-38mm verzinkt staal vpe 20stuk		
Voor modellen:	AM900-10N, AM900-90, AMS900-10N, AMX, AMX-10HL, AMX-90, AMXR, AMXS, AMXT, AMXTS, AMXX, AMXXR, AMXXS, AUP, AUP-90, AUPS, AUXX, AUXXL-11N, AUXXLS-11N, AUXXR, AUXXS, AUXXT, AUXXTS, CR, CR-F, ECOMAX-402, ECOMAX-502, ECOMAX-602-11, ECOMAX-602S-11, ECOMAX-612-10, ECOMAX-612S-10, ECOMAX-650		



1

bestelnr.	505291	fabrikantnr.	00-323945-056 323945-56
omschrijving	slangklemmen ø 56mm verzinkt staal vpe 10stuk		
Voor modellen:	AM-700, AM900, AMS900, AMX-900, AMXR-900, AMXS-900, CR, ECOMAX-402, ECOMAX-502, ECOMAX-600, ECOMAX-650, FE, HE, HE600-HL, HE-P		



1

bestelnr.	505290	fabrikantnr.	00-323945-037 323945-37
omschrijving	slangklemmen ø 37mm verzinkt staal vpe 10stuk		
Voor modellen:	AM-700, AM900, AMS900, AMX-900, AMXR-900, AMXS-900, AMXT, AMXTS, AMXX-1300, AMXXR-1300, AMXXS-1300, AMXXT, AUXX-1300, AUXXL, AUXXR-1300, AUXXS-1300, AUXXT, AUXXTS, CR, ECOMAX-402, ECOMAX-502, ECOMAX-600, ECOMAX-700, FP, FX, FX-McDonalds, GC41, GC42, GP, GX, UX, UXL, UXLS, UXS, UXT, UXTH, UXTHL, UXTHLS, UXTHS, UXTL, UXTLH, UXTLHS, UXTLS, UXTS		



1

bestelnr.	505289	fabrikantnr.	00-323945-060 323945-60
omschrijving	slangklemmen ø 60mm verzinkt staal vpe 10stuk		
Voor modellen:	AM-10, AM-11, AM-141, AM900-10N, AM900-90, AMS900-10N, AMX, AMX-10HL, AMX-90, AMXR, AMXS, AMXT, AMXTS, AMXX, AMXXR, AMXXS, AUP, AUP-90, AUPS, AUXX, AUXXL-11N, AUXXLS-11N, AUXXR, AUXXS, AUXXT, AUXXTS, CSA, ECOMAX-602-10, ECOMAX-602-11, ECOMAX-602S-11, ECOMAX-612-10, ECOMAX-612S-10		



1

bestelnr.	505294	fabrikantnr.	00-323945-053 323945-53
omschrijving	slangklemmen ø 53mm verzinkt staal vpe 10stuk		
Voor modellen:	CN-Protronic, CN-Smartronic, CP-Protronic, CSA, CS-Easytronic, ECOMAX-402, ECOMAX-502, FE, GC, GC11, GC12, GC31, GC32, GC41, GC42, HE, HE600-HL, HE-P, UX-30, UX-30B, UX-30E, UX-30EB, UX-30EH, UX-30ES, UX-30ESB, UX-30ESH, UX-30H, UX-30-McDonalds, UX-30S, UX-30SB, UX-30SH, UX-60, UX-60B, UX-60E, UX-60EB, UX-60EH, UX-60EHB, UX-60H, UX-60HB		



1

bestelnr.	505292	fabrikantnr.	00-323945-064 323945-64
omschrijving	slangklemmen ø 64-68mm verzinkt staal vpe 10stuk		
Voor modellen:	AM-10, AM-11, AM-141, AM900-10N, AM900-90, AMS900-10N, AMX, AMX-10HL, AMX-90, AMXR, AMXS, AMXT, AMXTS, AUXXT, AUXXTS, CN-Protronic, CN-Smartronic, CP-Protronic, CS-Easytronic, ECOMAX-602-10, ECOMAX-602-11, ECOMAX-602S-11, ECOMAX-612-10, ECOMAX-612S-10, ECOMAX-700, UX, UXL, UXLS, UXS, UXT, UXTL, UXTLS, UXTS		



meettechniek

thermometers

inbouwthermometers



1

bestelnr.	541969	fabrikantnr.	228720-2 228720-3
omschrijving	thermometer inbouwmaat 58x25,5mm +30 tot +120°C capillaire 3000mm voeler ø 8.5mm voeler L 35mm		
Voor modellen:	AMX, AMX-R, AUX_, AUX-R, CR-F, CSA, ECOMAX-600, ECOMAX-700, ECOMAX-800, ECW, FX, GX, HX-30, HX-30S, HX-40, HX-40S, UW-120, UW-200, UX-30, UX-30B, UX-30S, UX-30SB, UX-60, UX-60B		

bevestigingsmaterialen

schroeven

verzonken schroeven



1

bestelnr.	560215	fabrikantnr.	603182
omschrijving	verzonkenkopschroef draad M5 L 14mm RVS DIN 963/ISO 2009 vpe 20stuk opname gleuf kop ø 9.2mm		
Voor modellen:	CR, FE, FE-W, FX, GC, GC11, GC12, GC31, GC32, GC41, GC42, GX, HE, HE600-HL, HE-P, HX, HX-30, HX-30E, HX-30ES, HX-30S, HX-40, HX-40E, HX-40ES, HX-40S, HX-60-EHL, HX-E, HX-ES, HX-S, UXD-30		

schroeven met platte kop



1

bestelnr.	560062	fabrikantnr.	603455
omschrijving	platkopschroef draad M4 draad L 10mm RVS DIN 7985/ISO 7045 vpe 20stuk opname kruiskop kop ø 8mm kopdikte 2mm		
Voor modellen:	CO-0611E, CO-1011E, CO-2011E, CS-0611E, CS-1011E, CS-2011E, CSD-0611E, CSD-1011E, CSD-2011E, UW-105		



1

bestelnr.	560061	fabrikantnr.	602687
omschrijving	platkopschroef draad M4 draad L 6mm RVS DIN 7985/ISO 7045 vpe 20stuk opname kruiskop kop ø 8mm kopdikte 2mm		
Voor modellen:	AMX, AMX-E, AMX-ER, AMX-R, AUX, AUX_, AUX-E, AUX-ER, AUX-R, ECOMAX-600, ECOMAX-700, FE, FUX, FX, GX, HE, HE600-HL, HE-P, HX, HX-30, HX-30E, HX-30ES, HX-30S, HX-40, HX-40E, HX-40ES, HX-40S, HX-E, HX-ES, HX-S, UX-30, UX-30B, UX-30E, UX-30EB, UX-30EH, UX-30ES, UX-30ESB, UX-30ESH, UX-30H, UX-30-McDonalds, UX-30S, UX-30SB, UX-30SH, UX-60, UX-60B, UX-60E, UX-60EB, UX-60EH, UX-60EHB, UX-60H... (Andere modellen die u kunt zien in de webshop)		

zeskantschroeven



1

bestelnr.	550528	fabrikantnr.	00-609782-000
omschrijving	veiligheidsschroef draad M5 SB 8 vpe 10stuk L 8mm kop ø 11mm		
Voor modellen:	AM-10, AM-11, AM-141, AM900-10N, AM900-90, AMS900-10N, AMX, AMX-10HL, AMX-90, AMXR, AMXS, AMXT, AMXTS, AMXX, AMXXR, AMXXS, AUP, AUP-90, AUPS, AUXX, AUXXL-11N, AUXXLS-11N, AUXXR, AUXXS, AUXXT, AUXXTS, ECOMAX-602-10, ECOMAX-602-11, ECOMAX-602S-11, ECOMAX-612-10, ECOMAX-612S-10		

koploze schroeven

DIN 913/ISO 4026 (zeskant en kegelpunt)



1

bestelnr.	504733	fabrikantnr.	VA-261-1
omschrijving	stelschroef draad M4 L 5mm RVS DIN 913 opname interne zeskant SB 2 vpe 1stuk		

kartelschroeven



1

bestelnr.	510112	fabrikantnr.	139321-107 139321-873 E454002
omschrijving	kartelschroef draad M10 draad L 10mm ø 22mm H 4.5mm RVS		
Voor modellen:	GE-400, GW-600, GW-600S, GW-601, GW-601S		



moeren

kartelmoeren



bestelnr.	518152	fabrikantnr.	01-240205-001 01-240205-1 324036
omschrijving	kartelmoer draad M12x1 ø 32mm H 3mm inbouwpositie boven/onder RVS voor wasarm ID ø 11.5mm OD ø 32mm materiaaldikte 3mm		
Voor modellen:	AM-10, AM-11, AM-141, AM-700, AM900, AM900-10N, AM900-90, AMS900, AMS900-10N, AMX, AMX-10HL, AMX-90, AMX-900, AMX-E, AMX-ER, AMXR, AMX-R, AMXR-900, AMXS, AMXS-900, AMXT, AMXTS, AMXX, AMXX-1300, AMXXR, AMXXR-1300, AMXXS, AMXXS-1300, AMXXT, AUP, AUP-90, AUPS, AUX, AUX_, AUX-E, AUX-ER, AUX-R, AUXX, AUXX-1300, AUXXL, AUXXL-11N, AUXXLS-11N, AUXXR, AUXXR-1300, AUXXS, AUXXS-1300, AUXXT, AUXXTS, ECOMAX-402, ECOMAX-502...(Andere modellen die u kunt zien in de webshop)		

zeskantmoeren

DIN 934 / ISO 4032/8673



bestelnr.	511212	fabrikantnr.	602491
omschrijving	zeskantmoer draad M6 H 5mm SB 10 RVS DIN/ISO DIN 934 / ISO 4032/8673 vpe 1stuk		
Voor modellen:	ACW, AM-600, AM-600C, AM-600CR, AM-600R, AMX, AMX-E, AMX-ER, AMX-R, AMXX-1300, AMXXR-1300, AMXXS-1300, AMXXT, AUX, AUX_, AUX-E, AUX-ER, AUX-R, AUXX-1300, AUXXL, AUXXR-1300, AUXXS-1300, AUXXT, CDC, CNA, CNR, CO-0611E, CO-0612E, CO-1011E, CO-1012E, CO-2011E, CS-0611E, CS-0612E, CS-0612E-A, CS-1011E, CS-1012E, CS-1012E-A, CS-1012G, CS-1022E, CS-1022E-A, CS-2011E, CS-2012E, CS-2022E, CSD-0611E, CSD-0612E, CSD-0612E-A, CSD-1011E, CSD-1012E, CSD-1012E-A, CSD-1013G...(Andere modellen die u kunt zien in de webshop)		

DIN 985



bestelnr.	560460	fabrikantnr.	602504
omschrijving	zeskantmoer draad M10 H 15mm RVS SB 17 zelfsluitend vpe 1stuk DIN/ISO 985		
Voor modellen:	AM-600, AM-600C, AM-600CR, AM-600R, AM900, AMS900, AMX-900, AMXR-900, AMXS-900, AMXX-1300, AMXXR-1300, AMXXS-1300, AMXXT, AUXX-1300, AUXXR-1300, AUXXS-1300, AUXXT, CDC, CN, CNA, CNB, CNR, CTC, ECOMAX-700, ECW, FTX, FUX, MS-34R, MS-41R, UW-105, UW-120, UW-125, UW-135, UW-135H, UW-200, UW-205, UX, UXL, Uxls, UXS, UXT, UXTH, UXTHL, UXTHLS, UXTHS, UXTL, UXTLH, UXTLHS, UXTLS, UXTS		

overigen



bestelnr.	696438	fabrikantnr.	00-775460-001 775460-1
omschrijving	spreidingsmoer kunststof vpe 1stuk voor bladschroef		
Voor modellen:	AM-10, AM-11, AM-141, AM-700, AM900, AM900-10N, AM900-90, AMS900, AMS900-10N, AMX, AMX-10HL, AMX-90, AMX-900, AMXR, AMXR-900, AMXS, AMXS-900, AMXT, AMXTS, AMXX, AMXX-1300, AMXXR, AMXXR-1300, AMXXS, AMXXS-1300, AMXXT, AUP, AUP-90, AUPS, AUXX, AUXX-1300, AUXXL, AUXXL-11N, AUXXLS-11N, AUXXR, AUXXR-1300, AUXXS, AUXXS-1300, AUXXT, AUXXTS, ECOMAX-600, ECOMAX-602-10, ECOMAX-602-11, ECOMAX-602S-11, ECOMAX-612-10, ECOMAX-612S-10, ECOMAX-650, ECOMAX-700, FP, FX...(Andere modellen die u kunt zien in de webshop)		

schijven

veerringen



bestelnr.	560121	fabrikantnr.	371020-562 602308 VC032-09
omschrijving	veerring ID ø 4.2mm OD ø 8mm RVS DIN127 vpe 20stuk voor draad M4		
Voor modellen:	AM-600, AM-600C, AM-600CR, AM-600R, AMX, AMX-E, AMX-ER, AMX-R, AUX, AUX_, AUX-E, AUX-ER, AUX-R, CO-0611E, CO-0612E, CO-1011E, CO-1012E, CO-2011E, CS-0423E, CS-0423EK, CS-0523E, CS-0523EK, CS-0611E, CS-0612E, CS-1011E, CS-1012E, CS-1012E-A, CS-1022E, CS-1022E-A, CS-2011E, CS-2012E, CS-2022E, CS-423E, CS-423K, CSD-0611E, CSD-0612E, CSD-0612E-A, CSD-1011E, CSD-1012E, CSD-1012E-A, CSD-1012ET, CSD-1013G, CSD-1022E, CSD-1022E-A, CSD-2011E, CSD-2012E, CSD-2012ET, CSD-2013G, CSD-2022E, CSL-0423E...(Andere modellen die u kunt zien in de webshop)		



bestelnr.	560122	fabrikantnr.	140506-28 602306
omschrijving	veerring ID ø 5.2mm OD ø 9mm RVS DIN127 vpe 20stuk voor draad M5		
Voor modellen:	AM-600, AM-600C, AM-600CR, AM-600R, CO-0611E, CO-0612E, CO-1011E, CO-1012E, CO-2011E, CS-0611E, CS-0612E, CS-0612E-A, CS-1011E, CS-1012E, CS-1012E-A, CS-1012G, CS-1022E, CS-1022E-A, CS-2011E, CS-2012E, CS-2012G, CS-2022E, CSD-0611E, CSD-0612E, CSD-0612E-A, CSD-1011E, CSD-1012E, CSD-1012E-A, CSD-1013G, CSD-1022E, CSD-1022E-A, CSD-2011E, CSD-2012E, CSD-2013G, CSD-2022E, FE, FE-W, FM-400H, FM-400U, FM-500, FM-500H, FTX, FUX, FX, G10R, G5R, GX, HE-P, HX, HX-30...(Andere modellen die u kunt zien in de webshop)		

opvulringen

DIN 125A



1

bestelnr.	560356	fabrikantnr.	602288
omschrijving	onderlegging ID \emptyset 10.5mm OD \emptyset 20mm materiaaldikte 2mm RVS vpe 1stuk DIN 125A voor draad M10		
Voor modellen:	ACW, AM-600, AM-600C, AM-600CR, AM-600R, AM-700, AM900, AMS900, AMX, AMX-900, AMX-E, AMX-ER, AMX-R, AMXR-900, AMXS-900, AMXX-1300, AMXXR-1300, AMXXS-1300, AMXXT, AUX, AUX_, AUX-E, AUX-ER, AUX-R, AUXX-1300, AUXXL, AUXXR-1300, AUXXS-1300, AUXXT, CDC, CN, CNA, CNB, CNR, CO-2011E, CS-2011E, CSD-2011E, CTC, ECOMAX-600, ECOMAX-650, ECOMAX-700, ECW, FE-W, FTN, FTT, FTX, FUX, FX, GC, GC11...(Andere modellen die u kunt zien in de webshop)		

diversen



1

bestelnr.	524117	fabrikantnr.	602286
omschrijving	onderlegging ID \emptyset 6.4mm OD \emptyset 12mm materiaaldikte 1.6mm RVS vpe 1stuk		



1

bestelnr.	692307	fabrikantnr.	01-240789-001 01-240789-1
omschrijving	onderlegging voor scharnier ID \emptyset 8mm OD \emptyset 18mm kunststof materiaaldikte 1mm vpe 1stuk		
Voor modellen:	ECOMAX-502		

bevestigingen

klemmen

slangklemmen

DIN 3017 - W2



1

bestelnr.	520114	fabrikantnr.	423008
omschrijving	slangklemmen Edelstaal/staal \emptyset 20-32mm breedte 9mm vpe 10stuk DIN 3017		

dubbele slangklemmen



1

bestelnr.	520573	fabrikantnr.	00-324510-202
omschrijving	slangklem \emptyset 20mm draad \emptyset 2mm vpe 1stuk		
Voor modellen:	AMX, AMX-E, AMX-ER, AMX-R, AUX, AUX_, AUX-E, AUX-ER, AUX-R, ECOMAX-402, ECOMAX-502, ECOMAX-700, FE, FE-W, FP, FX, FX-McDonalds, GC41, GC42, GP, GX, HE, HE600-HL, HE-P, HX, HX-30, HX-30E, HX-30ES, HX-30S, HX-40, HX-40E, HX-40ES, HX-40S, HX-60-EHL, HX-E, HX-ES, HX-S, UX, UX-30, UX-30B, UX-30E, UX-30EB, UX-30EH, UX-30ES, UX-30ESB, UX-30ESH, UX-30H, UX-30-McDonalds, UX-30S, UX-30SB...(Andere modellen die u kunt zien in de webshop)		



1

bestelnr.	520577	fabrikantnr.	00-324510-242
omschrijving	slangklem \emptyset 24mm draad \emptyset 2mm vpe 1stuk		
Voor modellen:	AMX, AMX-E, AMX-ER, AMX-R, AMXX-1300, AMXXR-1300, AMXXS-1300, AUX, AUX_, AUX-E, AUX-ER, AUX-R, AUXX-1300, AUXXR-1300, AUXXS-1300, CN, CNA, CNB, CNR, CR, ECOMAX-402, ECOMAX-502, ECOMAX-700, FE, FE-W, FP, FX, FX-McDonalds, GC, GC11, GC12, GC31, GC32, GC41, GC42, GP, GX, HE-P, HX, HX-30, HX-30E, HX-30ES, HX-30S, HX-40, HX-40E, HX-40ES, HX-40S, HX-60-EHL, HX-E, HX-ES...(Andere modellen die u kunt zien in de webshop)		



1

bestelnr.	520574	fabrikantnr.	00-324510-327
omschrijving	slangklem \emptyset 32mm draad \emptyset 3mm vpe 1stuk		
Voor modellen:	AMX, AMX-900, AMX-E, AMX-ER, AMX-R, AMXR-900, AMXS-900, AMXX-1300, AMXXR-1300, AMXXS-1300, AMXXT, AUX, AUX-E, AUX-ER, AUX-R, AUXX-1300, AUXXL, AUXXR-1300, AUXXS-1300, AUXXT, ECOMAX-502, ECOMAX-650, ECOMAX-700, FE, FP, FX, FX-McDonalds, GP, GX, UX, UXD-30, UXL, UXLS, UXS, UXT, UXTH, UXTHL, UXTHLS, UXTHS, UXTL, UXTLH, UXTLHS, UXTLS, UXTS		



			
1			
bestelnr.	513268	fabrikantnr.	00-303340-008 00-324510-068 139321-580 303340-8 324510-68
omschrijving	slangklem ø 8-10mm draad ø 1mm vpe 1stuk		
Voor modellen:	AM-10, AM-11, AM-141, AM-700, AM900, AM900-10N, AM900-90, AMS900, AMS900-10N, AMX, AMX-10HL, AMX-90, AMX-900, AMXR, AMXR-900, AMXS, AMXS-900, AMXT, AMXTS, AMXX, AMXX-1300, AMXXR, AMXXR-1300, AMXXS, AMXXS-1300, AMXXT, AUP, AUP-90, AUPS, AUXX, AUXX-1300, AUXXL, AUXXL-11N, AUXXLS-11N, AUXXR, AUXXR-1300, AUXXS, AUXXS-1300, AUXXT, AUXXTS, CHF45, ECOMAX-600, ECOMAX-602-10, ECOMAX-602-11, ECOMAX-602S-11, ECOMAX-612-10, ECOMAX-612S-10, ECOMAX-650, ECOMAX-700, EF-40...(Andere modellen die u kunt zien in de webshop)		

			
1			
bestelnr.	505283	fabrikantnr.	00-323945-018 323945-18
omschrijving	slangklemmen ø 18mm verzinkt staal vpe 20stuk		
Voor modellen:	AM-10, AM-11, AM-141, AM-700, AM900, AM900-10N, AM900-90, AMS900, AMS900-10N, AMX, AMX-10HL, AMX-90, AMX-900, AMX-E, AMX-ER, AMXR, AMX-R, AMXR-900, AMXS, AMXS-900, AMXT, AMXTS, AMXX, AMXX-1300, AMXXR, AMXXR-1300, AMXXS, AMXXS-1300, AMXXT, AUP, AUP-90, AUPS, AUX, AUX-E, AUX-ER, AUX-R, AUXX, AUXX-1300, AUXXL-11N, AUXXLS-11N, AUXXR, AUXXR-1300, AUXXS, AUXXS-1300, AUXXT, AUXXTS, ECOMAX-402, ECOMAX-502, ECOMAX-600, ECOMAX-602-10...(Andere modellen die u kunt zien in de webshop)		

dubbele slangklemmen met schroeven

			
1			
bestelnr.	505281	fabrikantnr.	00-323945-015 323945-15
omschrijving	slangklemmen ø 15mm verzinkt staal vpe 20stuk		
Voor modellen:	AM-10, AM-11, AM-141, AM-700, AM900, AM900-10N, AM900-90, AMS900, AMS900-10N, AMX, AMX-10HL, AMX-90, AMX-900, AMXR, AMXR-900, AMXS, AMXS-900, AMXT, AMXTS, AMXX, AMXX-1300, AMXXR, AMXXR-1300, AMXXS, AMXXS-1300, AMXXT, AUP, AUP-90, AUPS, AUXX, AUXX-1300, AUXXL, AUXXL-11N, AUXXLS-11N, AUXXR, AUXXR-1300, AUXXS, AUXXS-1300, AUXXT, AUXXTS, ECOMAX-402, ECOMAX-502, ECOMAX-600, ECOMAX-602-10, ECOMAX-602-11, ECOMAX-602S-11, ECOMAX-612-10, ECOMAX-612S-10, FP, FX...(Andere modellen die u kunt zien in de webshop)		

			
1			
bestelnr.	505284	fabrikantnr.	00-323945-019 00-323945-021 323945-19 -alt- 323945-21
omschrijving	slangklemmen ø 21mm verzinkt staal vpe 20stuk		
Voor modellen:	AM-10, AM-11, AM-141, AM-700, AM900-10N, AM900-90, AMS900-10N, AMX, AMX-10HL, AMX-90, AMX-E, AMX-ER, AMXR, AMX-R, AMXS, AMXT, AMXTS, AMXX, AMXX-1300, AMXXR, AMXXR-1300, AMXXS, AMXXS-1300, AMXXT, AUP, AUP-90, AUPS, AUX, AUX-E, AUX-ER, AUX-R, AUXX, AUXX-1300, AUXXL, AUXXL-11N, AUXXLS-11N, AUXXR, AUXXR-1300, AUXXS, AUXXS-1300, AUXXT, AUXXTS, ECOMAX-402, ECOMAX-502, ECOMAX-600, ECOMAX-602-10, ECOMAX-602-11, ECOMAX-602S-11, ECOMAX-612-10, ECOMAX-612S-10...(Andere modellen die u kunt zien in de webshop)		

			
1			
bestelnr.	505282	fabrikantnr.	00-323945-016 323945-16
omschrijving	slangklemmen ø 16mm verzinkt staal vpe 20stuk		
Voor modellen:	AM-700, AM900, AMS900, AMX, AMX-900, AMX-E, AMX-ER, AMX-R, AMXR-900, AMXS-900, AMXX-1300, AMXXR-1300, AMXXS-1300, AMXXT, AUX, AUX-E, AUX-ER, AUX-R, AUXX-1300, AUXXL, AUXXR-1300, AUXXS-1300, AUXXT, ECOMAX-402, ECOMAX-502, ECOMAX-600, ECOMAX-650, GC, UX, UXL, Uxls, UXS, UXT, UXTH, UXTHL, UXTHLS, UXTHS, UXTL, UXTLH, UXTLHS, UXTLS, UXTS		



			
1			
bestelnr.	505285	fabrikantnr.	00-323945-025 323945-25
omschrijving	slangklemmen ø 25mm verzinkt staal vpe 20stuk		
Voor modellen:	AM-10, AM-11, AM-141, AM-700, AM900, AM900-10N, AM900-90, AMS900, AMS900-10N, AMX, AMX-10HL, AMX-90, AMX-900, AMX-E, AMX-ER, AMXR, AMX-R, AMXR-900, AMXS, AMXS-900, AMXT, AMXTS, AMXX, AMXX-1300, AMXXR, AMXXR-1300, AMXXS, AMXXS-1300, AMXXT, AUP, AUP-90, AUPS, AUX, AUX-E, AUX-ER, AUX-R, AUXX, AUXX-1300, AUXXL, AUXXL-11N, AUXXLS-11N, AUXXR, AUXXR-1300, AUXXS, AUXXS-1300, AUXXT, AUXXTS, ECOMAX-402, ECOMAX-502, ECOMAX-600...(Andere modellen die u kunt zien in de webshop)		

			
2			
bestelnr.	505286	fabrikantnr.	00-323945-029 323945-29
omschrijving	slangklemmen ø 29mm verzinkt staal vpe 20stuk		
Voor modellen:	AM900-10N, AM900-90, AMS900-10N, AMX, AMX-10HL, AMX-90, AMX-E, AMX-ER, AMXR, AMX-R, AMXS, AMXT, AMXTS, AMXX, AMXX-1300, AMXXR, AMXXR-1300, AMXXS, AMXXS-1300, AMXXT, AUP, AUP-90, AUPS, AUX, AUX-E, AUX-ER, AUX-R, AUXX, AUXX-1300, AUXXL, AUXXL-11N, AUXXLS-11N, AUXXR, AUXXR-1300, AUXXS, AUXXS-1300, AUXXT, AUXXTS, CR, CR-F, ECOMAX-602-11, ECOMAX-602S-11, ECOMAX-612-10, ECOMAX-612S-10, ECOMAX-700, FE, GC, GC11, GC12, GC31...(Andere modellen die u kunt zien in de webshop)		

			
1			
bestelnr.	505287	fabrikantnr.	00-323945-033 323945-33
omschrijving	slangklemmen ø 33mm verzinkt staal vpe 20stuk		
Voor modellen:	AM-700, AM900, AM900-10N, AM900-90, AMS900, AMS900-10N, AMX, AMX-10HL, AMX-90, AMX-900, AMXR, AMXR-900, AMXS, AMXS-900, AMXX, AMXXR, AMXXS, AUP, AUP-90, AUPS, AUX, AUXXL-11N, AUXXLS-11N, AUXXR, AUXXS, CN-Protronic, CN-Smartronic, CP-Protronic, CR-F, ECOMAX-402, ECOMAX-502, ECOMAX-600, ECOMAX-602-11, ECOMAX-612-10, ECOMAX-612S-10, ECOMAX-650, ECOMAX-700, FX, GC31, GC32, GC41, GC42, GX		

			
1			
bestelnr.	505293	fabrikantnr.	00-323945-035 323945-35
omschrijving	slangklemmen ø 34-38mm verzinkt staal vpe 20stuk		
Voor modellen:	AM900-10N, AM900-90, AMS900-10N, AMX, AMX-10HL, AMX-90, AMXR, AMXS, AMXT, AMXTS, AMXX, AMXXR, AMXXS, AUP, AUP-90, AUPS, AUX, AUXXL-11N, AUXXLS-11N, AUXXR, AUXXS, AUXXT, AUXXTS, CR, CR-F, ECOMAX-402, ECOMAX-502, ECOMAX-602-11, ECOMAX-602S-11, ECOMAX-612-10, ECOMAX-612S-10, ECOMAX-650		

			
1			
bestelnr.	505290	fabrikantnr.	00-323945-037 323945-37
omschrijving	slangklemmen ø 37mm verzinkt staal vpe 10stuk		
Voor modellen:	AM-700, AM900, AMS900, AMX-900, AMXR-900, AMXS-900, AMXT, AMXTS, AMXX-1300, AMXXR-1300, AMXXS-1300, AMXXT, AUXX-1300, AUXXL, AUXXR-1300, AUXXS-1300, AUXXT, AUXXTS, CR, ECOMAX-402, ECOMAX-502, ECOMAX-600, ECOMAX-700, FP, FX, FX-McDonalds, GC41, GC42, GP, GX, UX, UXL, UXLs, UXS, UXT, UXTH, UXTHL, UXTHLS, UXTHS, UXTL, UXTLH, UXTLHS, UXTLS, UXTS		

			
1			
bestelnr.	505294	fabrikantnr.	00-323945-053 323945-53
omschrijving	slangklemmen ø 53mm verzinkt staal vpe 10stuk		
Voor modellen:	CN-Protronic, CN-Smartronic, CP-Protronic, CSA, CS-Easytronic, ECOMAX-402, ECOMAX-502, FE, GC, GC11, GC12, GC31, GC32, GC41, GC42, HE, HE600-HL, HE-P, UX-30, UX-30B, UX-30E, UX-30EB, UX-30EH, UX-30ES, UX-30ESB, UX-30ESH, UX-30H, UX-30-McDonalds, UX-30S, UX-30SB, UX-30SH, UX-60, UX-60B, UX-60E, UX-60EB, UX-60EH, UX-60EHB, UX-60H, UX-60HB		



			
1			
bestelnr.	505291	fabrikantnr.	00-323945-056 323945-56
omschrijving	slangklemmen ø 56mm verzinkt staal vpe 10stuk		
Voor modellen:	AM-700, AM900, AMS900, AMX-900, AMXR-900, AMXS-900, CR, ECOMAX-402, ECOMAX-502, ECOMAX-600, ECOMAX-650, FE, HE, HE600-HL, HE-P		

			
1			
bestelnr.	505289	fabrikantnr.	00-323945-060 323945-60
omschrijving	slangklemmen ø 60mm verzinkt staal vpe 10stuk		
Voor modellen:	AM-10, AM-11, AM-141, AM900-10N, AM900-90, AMS900-10N, AMX, AMX-10HL, AMX-90, AMXR, AMXS, AMXT, AMXTS, AMXX, AMXXR, AMXXS, AUP, AUP-90, AUPS, AUXX, AUXXL-11N, AUXXLS-11N, AUXXR, AUXXS, AUXXT, AUXXTS, CSA, ECOMAX-602-10, ECOMAX-602-11, ECOMAX-602S-11, ECOMAX-612-10, ECOMAX-612S-10		

			
1			
bestelnr.	505292	fabrikantnr.	00-323945-064 323945-64
omschrijving	slangklemmen ø 64-68mm verzinkt staal vpe 10stuk		
Voor modellen:	AM-10, AM-11, AM-141, AM900-10N, AM900-90, AMS900-10N, AMX, AMX-10HL, AMX-90, AMXR, AMXS, AMXT, AMXTS, AUXXT, AUXXTS, CN-Protronic, CN-Smartronic, CP-Protronic, CS-Easytronic, ECOMAX-602-10, ECOMAX-602-11, ECOMAX-602S-11, ECOMAX-612-10, ECOMAX-612S-10, ECOMAX-700, UX, UXL, UXLS, UXS, UXT, UXTL, UXTLS, UXTS		

borgringen			
DIN 471			
			
1			
bestelnr.	507509	fabrikantnr.	602302 RR-010-13 RR-10-13 RR-E-2-34
omschrijving	zekering schacht ø 18mm materiaaldikte 1.2mm RVS DIN 471		
Voor modellen:	103G, 203G, 2226, 303G, AM-12E, AM-12EC, AM-12EF, AM-12ER, AM15, AM15F, AM15T, AM-600, AM-600C, AM-600CR, AM-600R, C44A, C44AW, C54A, C64A, CS-2012E, CS-2022E, CSD-2012E, CSD-2022E, CX, FTT, FTX, FUX, ML-110025, ML-110976, ML-110977, ML-32614, ML-32615, UW-105, UW-135, UW-135H, UWX		

DIN 6799			
			
1			
bestelnr.	518557	fabrikantnr.	602980
omschrijving	zekering E D1 ø 5mm D2 ø 11mm RVS DIN 6799 dikte 0.7mm		

DIN 7993			
			
1			
bestelnr.	697871	fabrikantnr.	602309 RR-E-2-38
omschrijving	zekering A D1 ø 14mm D2 ø 12.8mm veerstaal DIN 7993 dikte 1mm		
Voor modellen:	AM-12E, AM-12EC, AM-12EF, AM-12ER, AM-600, AM-600C, AM-600CR, AM-600R, FM-400H, FM-400U, FM-500, FM-500H, UW-105, UW-120, UW-125, UW-135, UW-135H, UW-200, UW-205, UW-55		

splitpennen			
			
1			
bestelnr.	694269	fabrikantnr.	602886
omschrijving	splitpen ø 2.7mm L 18mm		
Voor modellen:	FTX, FUX, UW-105, UW-125, UW-205		



verbruiksmaterialen

zekeringen

glaszekeringen



1

bestelnr.	358666	fabrikantnr.	926283 E926283
omschrijving	fijnzekering grootte ϕ 5x20mm 0.315A snel maximale spanning 250V vpe 10stuk		



1

bestelnr.	358606	fabrikantnr.	228010 E228010
omschrijving	fijnzekering grootte ϕ 5x20mm 4A traag maximale spanning 250V vpe 10stuk		

 ϕ 6,3x32mm 500V

1

bestelnr.	358742	fabrikantnr.	775570-2
omschrijving	fijnzekering grootte ϕ 6,3x32mm 0.8A snel maximale spanning 500V vpe 10stuk		



1

bestelnr.	358751	fabrikantnr.	00-775570-001 775570-1
omschrijving	fijnzekering grootte ϕ 6,3x32mm 6.3A snel maximale spanning 500V vpe 10stuk		
Voor modellen:	AMX-900, AMXS-900, AMXX-1300, AMXXT, AUXX-1300, AUXXT, ECOMAX-650, UX, UXL, UXLS, UXS, UXT, UXTH, UXTHL, UXTHLS, UXTHS, UXTL, UXTLS, UXTS		

A		L	
afvoerpompen	40	lampen	17
afvoerslangen	88	M	
asafdichtingen	76	magneetschakelaars	13, 18
axiaalventilatoren	31	magneetventielen	24
B		maximaal clixonthermostaten	9
bedrijfscondensatoren	42	maximaal thermostaten	10
bevestigingen	98	meettechniek	96
bevestigingsmaterialen	96	microschakelaars	11
borgringen	101	moeren	97
C		N	
clixonthermostaten	9, 10	nokkenschakelaars	13
condensatoren & ontstoringsfilters	42	O	
containerfilter	86	opvullingen	98
D		o-ringen	72
deurrubbers	72	P	
deurrubbers voor vaatwassers	79	plakelementen	8
domepelementen	2	pompen	32
doseerapparaten	83	positieschakelaars	11
draaischakelaars	13	pressostaten	29
drukverhogingspompen I	40	programmatimers	17
drukverhogingspompen II	42	PVC-slangen	89
dubbele slangklemmen	93, 98	PVC-toevoerslangen	87
dubbele slangklemmen met schroeven	93, 99	R	
E		regelthermostaten	10
elektra toebehoren	44	relais	19
elektrische timers	18	RVS flexibele slangen	87
elektroden	31	S	
F		schakelaars en tasters	11
filters	43	schakelkasten	44
G		schroeven	96
glaszekeringen	102	schroeven met platte kop	96
gloeilampen	17	signaallampen	17
I		silicone slangen	90
industrieslangen	89	slangaansluitingen	92
K		slangen	87
kabeldoorvoeringen	44, 44	slangklemmen	93, 98
kabels	44	snapsluitingen	71
kabelschroefnippels	44	splitpennen	101
kartelmoeren	97	systeemschakelaar ROLD	12
kartelschroeven	96	systeemschakelaars	16
klemmen	44, 93, 98	T	
koploze schroeven	96	thermische pakkingen	72
		thermostaten	9
		tijdsrelais	20

timers	17
toevoerfilters	93, 93
toevoerslangen	87

U

universele slangen	87
--------------------	----

V

veerringen	97
ventielen en containerinlaten	92
ventilatoren	31
verbruiksmaterialen	102
verwarmingselementen	2
verzonken schroeven	96
vlakbandkabels	44
vloterschakelaars	12
vlotterventielen	92
voelers	20
vormslangen	90

W

wandinlaten	87
was- en naspoelpompen	32
waspompmotoren	39
watercircuit componenten	93
waterontharders	92
wipschakelaar/drukschakelaars	11

Z

zekeringen	43, 102
zeskantmoeren	97
zeskantschroeven	96