

# Dosiergeräte

# 4

Schlauchpumpendosiergeräte.....	122
Kolbenpumpen.....	132
Membranpumpen.....	133
Elektronikregler.....	137
Zubehör.....	138



# Dosiergeräte

## Schlauchpumpendosiergeräte

ASF/THOMAS

Einbauversion

ohne Steuerung



Abb.	GEV-Nr.	FDM (l/h)	Versorgung	Anwendung	SA $\phi$ (mm)	Schlauch	Typ
1	361248	2	230 VAC	Reiniger	4x7	Silikon	SR25
1	361249	4	230 VAC	Reiniger	4x7	Silikon	SR25
1	361271	6	230 VAC	Reiniger	5x8	Silikon	SR25
2	361968	4	12VDC	Klarspüler	2,5x5,7	Silikon	SR10/50
2	361324	4	12VDC	Reiniger	2x5,2	Pharmed	SR10/50
2	361917	6	12VDC	Klarspüler	2,5x1,6	Silikon	SR10/50



Abb.	GEV-Nr.	FDM (l/h)	Versorgung	Anwendung	SA $\phi$ (mm)	Schlauch	Typ
3	361330	4	12VDC	Klarspüler	2x5,2	Silikon	SR10/50

### Ersatzteile

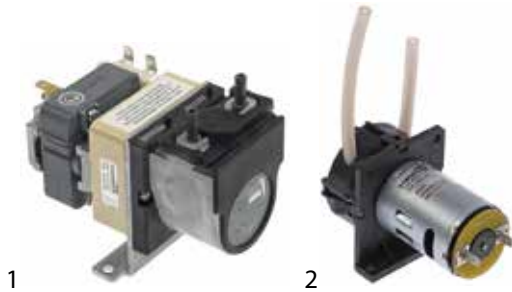

Abb.	GEV-Nr.	Beschreibung	Typ	Anwendung	SA $\phi$ (mm)	Schlauchtyp
1	361295	Pumpenschlauch	SR10/50	Klarspüler	2,5x1,6	Silikon
1	361294	Pumpenschlauch	SR10/50	Klarspüler	2x5,2	Silikon



Abb.	GEV-Nr.	Beschreibung	Typ	Anwendung	SA $\phi$ (mm)	Schlauchtyp
2	361297	Pumpenschlauch	SR10/50	Reiniger	2,4x1,6	Pharmed
2	361296	Pumpenschlauch	SR10/50	Reiniger	2x1,6	Pharmed



Abb.	GEV-Nr.	Beschreibung	Typ	Anwendung	SA $\phi$ (mm)	Schlauchtyp
3	361333	Pumpenschlauch	SR25	Reiniger	4x1,5	Silikon



Abb.	GEV-Nr.	Beschreibung	Typ	Anwendung	SA $\phi$ (mm)	Schlauchtyp
4	361334	Pumpenschlauch	SR25	Reiniger	5x8	Silikon



Abb.	GEV-Nr.	Beschreibung	Typ	FDM (l/h)
1	361470	Schlauchroller	SR25	12
1	361469	Schlauchroller	SR25	2/4/6



Abb.	GEV-Nr.	Beschreibung	Typ	Anwendung	Schlauchtyp	FDM (l/h)
1	361293	Pumpenkopf	SR10/50	Klarspüler	Silikon	6
2	361328	Pumpenkopf	SR10/50	Reiniger	Pharmed	6
3	361335	Schlauchführung	SR25	für Reiniger	-	-

## BORES

Aufputzversion

mit Zeitsteuerung



Abb.	GEV-Nr.	FDM (l/h)	Versorgung	Anwendung	SA $\phi$ (mm)	Schlauch	Typ
1	361588	1	230 VAC	Klarspüler	4x6	Silikon	Mybo
2	361592	3,3	230 VAC	Reiniger	4x6	Santoprene	PDM3.3



Abb.	GEV-Nr.	FDM (l/h)	Versorgung	Anwendung	SA $\phi$ (mm)	Schlauch	Typ
3	361380	4	24 VAC	Reiniger	4x6	Santoprene	Mybo

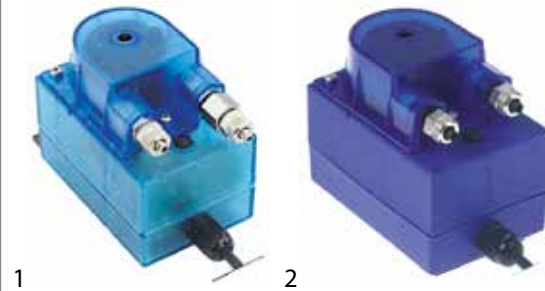

## ohne Steuerung



Abb.	GEV-Nr.	FDM (l/h)	Versorgung	Anwendung	SAø (mm)	Schlauch	Typ
1	361397	2	230 VAC	Reiniger	4x6	Santoprene	Protho
2	361382	4	24 VAC	Reiniger	4x6	Santoprene	Mybo

## mit Frequenzsteuerung

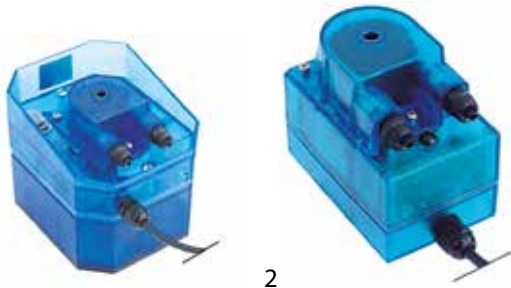

Abb.	GEV-Nr.	FDM (l/h)	Versorgung	Anwendung	SAø (mm)	Schlauch	Typ
1	361406 <sup>1</sup>	1	230 VAC	Klarspüler	4x6	Silikon	Mybo
2	361580 <sup>1</sup>	1	230 VAC	Klarspüler	4x6	Silikon	Mybo

<sup>1</sup>mit integriertem Rückschlagventil

## Einbauversion

### Doppelanlagen

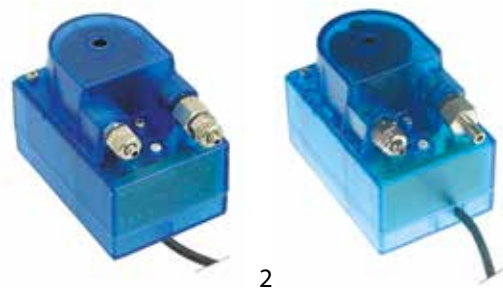

Abb.	GEV-Nr.	FDM (l/h)	Versorgung	Anwendung	SAø (mm)	Schlauch	Typ
1	361577 <sup>1</sup>	0,16/0,07	230VAC	Reiniger/Klarspüler	4x6	Santoprene	Perios

<sup>1</sup>mit integriertem Rückschlagventil



Abb.	GEV-Nr.	FDM (l/h)	Versorgung	Anwendung	SAø (mm)	Schlauch	Typ
3	361405	3,3	230 VAC	Reiniger	4x6	Santoprene	Mybo

## ohne Steuerung



## mit Durchflussmengensteuerung



Abb.	GEV-Nr.	FDM (l/h)	Versorgung	Anwendung	SAø (mm)	Schlauch	Typ
1	361816	0,39	230 VAC	Klarspüler	4x6	Silikon	Perios
2	361027	0,72	230 VAC	Reiniger	4x6	Santoprene	Perios

Abb.	GEV-Nr.	FDM (l/h)	Versorgung	Anwendung	SAø (mm)	Schlauchtyp	Typ
1	361743	0,4	230 VAC	Klarspüler	4x6	Silikon	PB0.2P
2	361283 <sup>1</sup>	0,4	230 VAC	Klarspüler	4x6	Silikon	Protho
2	361280	1,5	230 VAC	Reiniger	4x6	Santoprene	Protho
2	361281	2	230 VAC	Reiniger	4x6	Santoprene	Protho
2	361282	3,3	230 VAC	Reiniger	4x6	Santoprene	Protho

<sup>1</sup>mit integriertem Rückschlagventil



Abb.	GEV-Nr.	Beschreibung
1	361409	Pumpenkopf Pumpentyp PROTHO/MYBO Schlauchtyp Santoprene Reiniger Schlauch ø 7x10mm
2	361410 <sup>1</sup>	Pumpenkopf Pumpentyp PROTHO/MYBO Schlauchtyp Silikon Klarspüler Schlauch ø 3x7mm
3	361234	Abdeckung Pumpentyp PROTHO/MYBO
4	361223	Elektronikregler BORES 230V Anschluss Flachstecker 6,3mm

<sup>1</sup>mit integriertem Rückschlagventil

Abb.	GEV-Nr.	FDM (l/h)	Versorgung	Anwendung	SAø (mm)	Schlauchtyp	Typ
3	361408 <sup>1</sup>	1	230 VAC	Klarspüler	4x6	Silikon	Mybo
4	361407	3,3	230 VAC	Reiniger	4x6	Santoprene	Mybo

## GERMAC

### Aufputzversion

### Doppelanlagen



**Technische Daten:**  
Anwendung Reiniger/Klarspüler

Abb.	GEV-Nr.	FDM (l/h)	Versorgung	SAø (mm)	Typ
1	361773	3-5/0,6-1,2	230 VAC	6	G705

### mit Frequenz-/Drehzahlregelung



Abb.	GEV-Nr.	FDM (l/h)	Versorgung	Anwendung	SAø (mm)	Schlauch	Typ
1	361277	9	230 VAC	Reiniger	4x6	TP	G53

### mit Frequenz-/Leitwertsteuerung



Abb.	GEV-Nr.	FDM (l/h)	Versorgung	Anwendung	SAø (mm)	Schlauch	Typ
1	361279	14	230 VAC	Reiniger	4x6	TP	G55

## Ersatzteile

1 

Abb.	GEV-Nr.	Beschreibung	Typ	Anwendung	SAø (mm)	Schlauchtyp
1	361127	Pumpenschlauch	Perios	Klarspüler	3x6	Silikon

2 

Abb.	GEV-Nr.	Beschreibung	Typ	Anwendung	SAø (mm)	Schlauchtyp
2	361129	Pumpenschlauch	Perios	Klarspüler	3x6	Silikon

3 

Abb.	GEV-Nr.	Beschreibung	Typ	Anwendung	SAø (mm)	Schlauchtyp
3	361128	Pumpenschlauch	Perios	Reiniger	4x7	Santoprene

4 

Abb.	GEV-Nr.	Beschreibung	Typ	Anwendung	SAø (mm)	Schlauchtyp
4	361130	Pumpenschlauch	Perios	Reiniger	4x7	Santoprene

5 

Abb.	GEV-Nr.	Beschreibung	Typ	Anwendung	SAø (mm)	Schlauchtyp
5	361291	Pumpenschlauch	PROTHO/MYBO	Klarspüler	2x6	Silikon

6 

Abb.	GEV-Nr.	Beschreibung	Typ	Anwendung	SAø (mm)	Schlauchtyp
6	361290	Pumpenschlauch	PROTHO/MYBO	Reiniger	7x10	Santoprene



**mit Frequenzsteuerung**

1

Abb.	GEV-Nr.	FDM (l/h)	Versorgung	Anwendung	SAø (mm)	Schlauch	Typ
1	361275	3	230 VAC	Reiniger	4x6	TP	G43

**ohne Steuerung**

1 2

Abb.	GEV-Nr.	FDM (l/h)	Versorgung	Anwendung	SAø (mm)	Schlauch	Typ
1	361466	0,6	230 VAC	Klarspüler	4x6	Silikon	G80
2	361020	0,8	230 VAC	Reiniger	4x6	TP	G80
2	361021	1,5	230 VAC	Reiniger	4x6	TP	G150
2	361022	2	230 VAC	Reiniger	4x6	TP	G200

**Einbauversion**

**mit Frequenzsteuerung**

1 2

Abb.	GEV-Nr.	FDM (l/h)	Versorgung	Anwendung	SAø (mm)	Schlauch	Typ
1	361266	0,6	230 VAC	Klarspüler	4x6	Silikon	G82
2	361518	0,7	230 VAC	Klarspüler	4x6	Silikon	G302

**Ersatzteile**

1 2

Abb.	GEV-Nr.	Beschreibung
1	361557	Steuerplatine Typ G300/G302/G305 GERMAC
2	361556	Steuerplatine Typ G82/G152/G202/G252 GERMAC

3 4

Abb.	GEV-Nr.	FDM (l/h)	Versorgung	Anwendung	SAø (mm)	Schlauch	Typ
3	361472	0,8	230 VAC	Reiniger	4x6	TP	G82
3	361619	1,5	230 VAC	Reiniger	4x6	TP	G152
3	361267	2	230 VAC	Reiniger	4x6	TP	G202
3	361620	2,5	230 VAC	Reiniger	4x6	TP	G252
4	361268	3	230 VAC	Reiniger	4x6	TP	G300
4	361517	5,5	230 VAC	Reiniger	4x6	TP	G305

1

Abb.	GEV-Nr.	Beschreibung	Schlauchtyp	SAø (mm)	für Modell
1	361822	Pumpenschlauch	Silikon	4	DC035DP/DC070DP

2

Abb.	GEV-Nr.	Beschreibung	Schlauchtyp	SAø (mm)	für Modell
2	361555	Pumpenschlauch	Silikon	4x6	G42/G302
2	361060	Pumpenschlauch	Silikon	4x6	G80/G82/G600

5

Abb.	GEV-Nr.	FDM (l/h)	Versorgung	Anwendung	SAø (mm)	Schlauch	Typ
5	361862	3	230 VAC	Reiniger	4x6	TP	G300E

3

Abb.	GEV-Nr.	Beschreibung	Schlauchtyp	SAø (mm)	für Modell
3	361554	Pumpenschlauch	TP	5x8	G200/G250/G252
3	361467	Pumpenschlauch	TP	6x10	G43/G45/G53/G54/G55/G300/G305



1

Abb.	GEV-Nr.	Beschreibung	passend für
1	361589	Schlauchroller	G42/43/45/53/54/55/300/302/305/705
1	361263	Schlauchroller	G80/82/150/152/200/202/250/252/600

## GIADOS

### Einbauversion

#### mit Frequenzsteuerung



1

2

Abb.	GEV-Nr.	FDM (l/h)	Versorgung	Anwendung	SAø (mm)	Schlauch	Typ
1	361525 <sup>1</sup>	0,4	230VAC	Klarspüler	4x6	Silikon	6449
2	361930 <sup>1</sup>	1,5	230VAC	Reiniger	4x6	Santoprene	6671
2	361931 <sup>1</sup>	3	230VAC	Reiniger	4x6	Santoprene	6223

<sup>1</sup>inkl. Ansaug- und Förderschlauch

#### ohne Steuerung



1

2

Abb.	GEV-Nr.	FDM (l/h)	Versorgung	Anwendung	SAø (mm)	Schlauch	Typ
1	361935 <sup>1</sup>	0,4	230VAC	Klarspüler	4x6	Silikon	5633
2	361933 <sup>1</sup>	1,5	230VAC	Reiniger	4x6	Santoprene	1206
2	361934 <sup>1</sup>	3	230VAC	Reiniger	4x6	Santoprene	4880

<sup>1</sup>inkl. Ansaug- und Förderschlauch

## Ersatzteile



1

Abb.	GEV-Nr.	Beschreibung	Anwendung	Schlauchtyp	SAø (mm)
1	361527	Pumpenschlauch	Klarspüler	Silikon	4x6



2

Abb.	GEV-Nr.	Beschreibung	Anwendung	Schlauchtyp	SAø (mm)
2	361526	Pumpenschlauch	Reiniger	Santoprene	4x6

## MICRODOS

### Aufputzversion

#### mit Drehzahlsteuerung



1

2

Abb.	GEV-Nr.	FDM (l/h)	Versorgung	Anwendung	SAø (mm)	Schlauch	Typ
1	361749	1	24 VAC	Klarspüler	4x6	Silikon	MP2-R
1	361956 <sup>1</sup>	1	24 VAC	Klarspüler	4x6	Silikon	MP2-R
1	361748	1	230 VAC	Klarspüler	4x6	Silikon	MP2-R
1	361962 <sup>1</sup>	1	230 VAC	Klarspüler	4x6	Silikon	MP2-R
1	361775	4	24 VAC	Reiniger	4x6	Santoprene	MP2-R
1	361957 <sup>1</sup>	4	24 VAC	Reiniger	4x6	Santoprene	MP2-R
1	361774	4	230 VAC	Reiniger	4x6	Santoprene	MP2-R
1	361963 <sup>1</sup>	4	230 VAC	Reiniger	4x6	Santoprene	MP2-R
1	361777	7	24 VAC	Reiniger	4x6	Santoprene	MP2-R
1	361776	7	230 VAC	Reiniger	4x6	Santoprene	MP2-R
1	361964 <sup>1</sup>	7	230 VAC	Reiniger	4x6	Santoprene	MP2-R
2	361786 <sup>1</sup>	1	230 VAC	Klarspüler	6	Silikon	MP2-R
2	361598	7	230 VAC	Reiniger	6	Santoprene	MP2-R
2	361787	18	230 VAC	Reiniger	8	Santoprene	MP2-R

<sup>1</sup>mit Zubehör

#### mit Leitwertsteuerung



Pos.	GEV-Nr.	FDM (l/h)	Versorgung	Anwendung	SAø (mm)	Schlauch	Typ
1	361788 <sup>1</sup>	6	230 VAC	Reiniger	4x6	Santoprene	MP2-C1
2	361789	9	230 VAC	Reiniger	4x6	Santoprene	MP2-C1
3	361965 <sup>2</sup>	9	230 VAC	Reiniger	4x6	Santoprene	MP2-C1

<sup>1</sup>inkl. Leitwertelektrode <sup>2</sup>mit Zubehör



mit Zeitsteuerung



Abb.	GEV-Nr.	FDM (l/h)	Versorgung	Anwendung	SAø (mm)	Schlauch	Typ
1	361785	0,5	24VAC	Klarspüler	4x6	Silikon	MP2-1T
1	361784	0,5	230 VAC	Klarspüler	4x6	Silikon	MP2-1T
1	361961 <sup>1</sup>	0,5	230 VAC	Klarspüler	4x6	Silikon	MP2-1T

ohne Steuerung



Abb.	GEV-Nr.	FDM (l/h)	Versorgung	Anwendung	SAø (mm)	Schlauch	Typ
1	361778	0,5	230 VAC	Klarspüler	4x6	Silikon	MP2-B
1	361958 <sup>1</sup>	0,5	230 VAC	Klarspüler	4x6	Silikon	MP2-B
1	361780	1,5	230 VAC	Reiniger	4x6	Santoprene	MP2-B
1	361959 <sup>1</sup>	1,5	230 VAC	Reiniger	4x6	Santoprene	MP2-B
1	361782	3	230 VAC	Reiniger	4x6	Santoprene	MP2-B
1	361960 <sup>1</sup>	3	230 VAC	Reiniger	4x6	Santoprene	MP2-B

<sup>1</sup>mit Zubehör

Einbauversion

mit Drehzahlsteuerung



Pos.	GEV-Nr.	FDM (l/h)	Versorgung	Anwendung	SAø (mm)	Schlauch	Typ
1	361747	3	24 VAC	Reiniger	4x6	Santoprene	MP3-BT
2	361618	3	230 VAC	Reiniger	4x6	Santoprene	MP3-BT

mit Frequenzsteuerung



Abb.	GEV-Nr.	FDM (l/h)	Versorgung	Anwendung	SAø (mm)	Schlauch	Typ
1	361746	1,5	24 VAC	Reiniger	4x6	Santoprene	MP3-BT
1	361617	1,5	230 VAC	Reiniger	4x6	Santoprene	MP3-BT
2	361803	4	230VAC	Reiniger	4x6	Santoprene	MP3-T

mit Zeitsteuerung



Abb.	GEV-Nr.	FDM (l/h)	Versorgung	Anwendung	SAø (mm)	Schlauch	Typ
1	361613	0,5	230 VAC	Klarspüler	4x6	Silikon	MP3-B1T
1	361614	1	230 VAC	Klarspüler	4x6	Silikon	MP3-B1T
2	361793	0,5	230 VAC	Klarspüler	4x6	Silikon	MP3-T
2	361000	3	230 VAC	Reiniger	4x6	Santoprene	MP3-T



Abb.	GEV-Nr.	FDM (l/h)	Versorgung	Anwendung	SAø (mm)	Schlauch	Typ
3	361915	1	230 VAC	Klarspüler	4x6	Silikon	MP3-T

ohne Steuerung

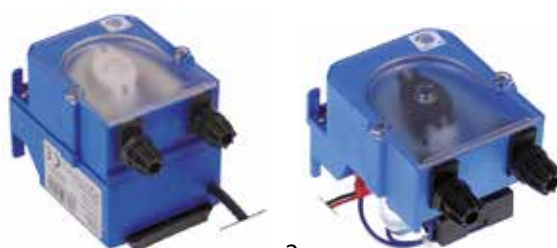

Abb.	GEV-Nr.	FDM (l/h)	Versorgung	Anwendung	SAø (mm)	Schlauch	Typ
1	361599	0,5	24 VAC	Klarspüler	4x6	Silikon	MP3
1	361097	0,5	230 VAC	Klarspüler	4x6	Silikon	MP3
1	361600	1,5	24 VAC	Reiniger	4x6	Santoprene	MP3
1	361098	1,5	230 VAC	Reiniger	4x6	Santoprene	MP3
1	361745	3	24 VAC	Reiniger	4x6	Santoprene	MP3
1	361685	3	230 VAC	Reiniger	4x6	Santoprene	MP3

**Ersatzteile**

Abb.	GEV-Nr.	Beschreibung	Anwendung	SA $\varnothing$ (mm)	Schlauchtyp
1	361595	Pumpenschlauch	Klarspüler	6	Silikon



Abb.	GEV-Nr.	Beschreibung	Anwendung	SA $\varnothing$ (mm)	Schlauchtyp
2	361487	Pumpenschlauch	Klarspüler	4x6	Silikon
2	361808	Pumpenschlauch	Klarspüler	4x6	Silikon



Abb.	GEV-Nr.	Beschreibung	Anwendung	SA $\varnothing$ (mm)	Schlauchtyp
3	361936	Pumpenschlauch	Reiniger	5	Santoprene
3	361807	Pumpenschlauch	Reiniger	6	Santoprene
3	361809	Pumpenschlauch	Reiniger	8	Santoprene



Abb.	GEV-Nr.	Beschreibung	Anwendung	SA $\varnothing$ (mm)	Schlauchtyp
4	361549	Pumpenschlauch	Reiniger	6	Santoprene



Abb.	GEV-Nr.	Beschreibung	Anwendung	SA $\varnothing$ (mm)	Schlauchtyp
5	361284	Pumpenschlauch	Reiniger	4x6	Santoprene



Abb.	GEV-Nr.	Beschreibung	Anwendung	Schlauchtyp
1	361515	Schlauchroller	Klarspüler	Silikon
2	361514	Schlauchroller	Reiniger	Santoprene

**SAIER**
**Aufputzversion**
**mit Drehzahl-/Zeitsteuerung**

Abb.	GEV-Nr.	FDM (l/h)	Versorgung	Anwendung	SA $\varnothing$ (mm)	Typ
1	361664	0,6	230 VAC	Klarspüler	5x8	COMPACT K
1	361663	4,5	230 VAC	Reiniger	5x8	COMPACT R
2	361660	6,0	230 VAC	Reiniger	6x2/6x3	DSP 2010 mcs

**mit Leitwert-/Drehzahl-/Zeitsteuerung**

**Technische Daten:**  
Schlauchanschluss  
6x2/6x3mm

Abb.	GEV-Nr.	FDM (l/h)	Versorgung	Anwendung	Typ
1	361658	10	230 VAC	Reiniger	DSP 9905 mcs

**Technische Daten:**  
Schlauchanschluss  
6x2/6x3mm

Abb.	GEV-Nr.	FDM (l/h)	Versorgung	Anwendung	Typ
2	361919	bis 9,0	230 VAC	Klarspüler	Concept 2105 mcs
2	361918	bis 9,0	230 VAC	Reiniger	Concept 2105 mcs

**mit Leitwertsteuerung**

Abb.	GEV-Nr.	FDM (l/h)	Versorgung	Anwendung	SA $\varnothing$ (mm)	Typ
1	361662	6	230 VAC	Reiniger	5x8	COMPACT L PLUS
2	361659	10	230 VAC	Reiniger	6x2/6x3	DSP9630 mcs





3

Abb.	GEV-Nr.	FDM (l/h)	Versorgung	Anwendung	SAø (mm)	Typ
3	361920	bis 9,0	230 VAC	Reiniger	6x2/6x3	Concept 2114 mcs

**Einbauversion**  
ohne Steuerung



1 2

Abb.	GEV-Nr.	FDM (l/h)	Versorgung	Anwendung	SAø (mm)	Typ
1	361830 <sup>1</sup>	10	230 VAC	Reiniger	6,3	DSP9911/10-E
2	361329	10	230 VAC	Reiniger	5x8	DSP9911E

<sup>1</sup>mit Zubehör

**Ersatzteile**



1

Abb.	GEV-Nr.	Beschreibung	Anwendung	SAø (mm)
1	361670	Pumpenschlauch	Klarspüler	3,2x6,4
1	361673	Pumpenschlauch	Klarspüler	4,8x9,6



2

Abb.	GEV-Nr.	Beschreibung	Anwendung	SAø (mm)
2	361332	Pumpenschlauch	Reiniger	4,8x8mm



3

Abb.	GEV-Nr.	Beschreibung	Anwendung	SAø (mm)
3	361674	Pumpenschlauch	Reiniger	5x8



1 2

Abb.	GEV-Nr.	Beschreibung	SAø (mm)
1	361671	Schlauchhalter	4,8
2	361676	Schlauchhalter	3,2-5x1,5



1

Abb.	GEV-Nr.	Beschreibung
1	361672	Schlauchroller



1 2

Abb.	GEV-Nr.	Beschreibung	Anwendung	SAø (mm)
1	361947	Servicekit	Klarspüler	6x4
2	361946	Servicekit	Reiniger	6x4

**Zubehör**



1 2 3 4

Abb.	GEV-Nr.	Beschreibung
1	361669	Leitwertelektrode 3/8" Einbau ø 17mm
2	361921	Leitwertelektrode Bohrung ø 17mm
3	361678	Rückschlagventil Eingang 5x8mm Ausgang 1/8" L 70mm
4	361677	Wanneneinlauf M10 Edelstahl Schlauch ø 5mm

**SEKO**

**Aufputzversion**

**Doppelanlagen**



1 2

Abb.	GEV-Nr.	FDM (l/h)	Versorgung	Anwendung	SAø (mm)	Schlauchtyp
1	361220	7	24/230VAC	Reiniger/Klarspüler	4x6	D/K
2	361442 <sup>1</sup>	1-4	24/230VAC	Reiniger/Klarspüler	4x6	D/K

<sup>1</sup>mit Zubehör



mit Drehzahlsteuerung



Abb.	GEV-Nr.	FDM (l/h)	Versorgung	Anwendung	SAø (mm)	Schlauchtyp	Schlauch	Typ
1	361163 <sup>1</sup>	0,15-1	230 VAC	Klarspüler	4x6	D	Sekobril	PR
1	361434 <sup>1</sup>	0,6-4	24 VAC	Reiniger	4x6	K	Santoprene	PR
1	361156 <sup>1</sup>	0,6-4	230 VAC	Reiniger	4x6	K	Santoprene	PR
1	361435 <sup>1</sup>	1-7	24 VAC	Reiniger	4x6	K	Santoprene	PR
1	361157	1-7	230 VAC	Reiniger	4x6	K	Santoprene	PR
1	361907 <sup>1</sup>	1-7	230 VAC	Reiniger	4x6	K	Santoprene	PR
2	361246	0,5-1	230 VAC	Klarspüler	6	C	Sekobril	PR
2	361247	1-7	230 VAC	Reiniger	6	I	Santoprene	PR
2	361436 <sup>1</sup>	3-18	230 VAC	Reiniger	8	J	Santoprene	PR

mit Leitwertsteuerung



Abb.	GEV-Nr.	FDM (l/h)	Versorgung	Anwendung	SAø (mm)	Schlauchtyp	Schlauch	Typ
1	361161 <sup>1</sup>	6	230 VAC	Reiniger	4x6	K	Santoprene	PA
1	361162 <sup>1</sup>	9	230 VAC	Reiniger	4x6	K	Santoprene	PA

<sup>1</sup>mit Zubehör

mit Zeitsteuerung



Abb.	GEV-Nr.	FDM (l/h)	Versorgung	Anwendung	SAø (mm)	Schlauchtyp	Schlauch	Typ
1	361437 <sup>1</sup>	0,4	24 VAC	Klarspüler	4x6	D	Sekobril	PM
1	361158 <sup>1</sup>	0,4	230 VAC	Klarspüler	4x6	D	Sekobril	PM
1	361770 <sup>2</sup>	6	230 VAC	Reiniger	4x6	K	Santoprene	PM
2	361160 <sup>1</sup>	6	230 VAC	Reiniger	4x6	K	Santoprene	PS
2	361214 <sup>1</sup>	10	230 VAC	Reiniger	4x6	K	Santoprene	PS

<sup>1</sup>mit Zubehör <sup>2</sup>inkl. Ansaug- und Förderschlauch

ohne Steuerung



Abb.	GEV-Nr.	FDM (l/h)	Versorgung	Anwendung	SAø (mm)	Schlauchtyp	Schlauch	Typ
1	361430 <sup>1</sup>	0,4	24 VAC	Klarspüler	4x6	D	Sekobril	PE
1	361153 <sup>1</sup>	0,4	230 VAC	Klarspüler	4x6	D	Sekobril	PE
1	361431 <sup>1</sup>	1,5	24 VAC	Reiniger	4x6	K	Santoprene	PE
1	361154 <sup>1</sup>	1,5	230 VAC	Reiniger	4x6	K	Santoprene	PE
1	361155 <sup>1</sup>	3	230 VAC	Reiniger	4x6	K	Santoprene	PE
2	361823	18	230 VAC	Reiniger	6,5	I	Santoprene	PE 18

<sup>1</sup>mit Zubehör

Einbauversion

mit Frequenzsteuerung



Abb.	GEV-Nr.	FDM (l/h)	Versorgung	Anwendung	SAø (mm)	Schlauchtyp	Schlauch	Typ
1	361949	0,4	230 VAC	Klarspüler	4x6	E	Sekobril	NBR 0.4
2	361948	3	230 VAC	Reiniger	4x6	H	Santoprene	NBR 3



Abb.	GEV-Nr.	FDM (l/h)	Versorgung	Anwendung	SAø (mm)	Schlauchtyp	Schlauch	Typ
3	361767 <sup>1</sup>	3	230 VAC	Reiniger	4x6	K	Santoprene	NBR 3
4	361923	0,1-3	230 VAC	Reiniger	6	I	Santoprene	PBR

<sup>1</sup>inkl. Ansaug- und Förderschlauch



Abb.	GEV-Nr.	FDM (l/h)	Versorgung	Anwendung	SAø (mm)	Schlauchtyp	Schlauch	Typ
5	361215	0,3-3,0	230 VAC	Reiniger	4x6	K	Santoprene	PBR



mit Zeitsteuerung



Abb.	GEV-Nr.	FDM (l/h)	Versorgung	Anwendung	SAø (mm)	Schlauchtyp	Schlauch	Typ
1	361768 <sup>1</sup>	0,4	230 VAC	Klarspüler	4x6	D	Sekobril	NBM 0.4
2	361211 <sup>1</sup>	0,4	230 VAC	Klarspüler	4x6	D	Sekobril	PBM

<sup>1</sup>mit Zubehör



Abb.	GEV-Nr.	FDM (l/h)	Versorgung	Anwendung	SAø (mm)	Schlauchtyp	Schlauch	Typ
3	361887	0,7	230 VAC	Klarspüler	6	C	Sekobril	PBM
4	361250 <sup>1</sup>	0,7	230 VAC	Klarspüler	4x6	B	Sekobril	PBM

<sup>1</sup>mit Zubehör

ohne Steuerung



Abb.	GEV-Nr.	FDM (l/h)	Versorgung	Anwendung	SAø (mm)	Schlauchtyp	Schlauch	Typ
1	361867	0,4	230 VAC	Klarspüler	4x6	D	Sekobril	NPG 0.4
1	361929 <sup>1</sup>	0,4	230 VAC	Klarspüler	4x6	E	Sekobril	NPG 0.4
1	361902	3	230 VAC	Reiniger	4x6	H	Santoprene	NPG 3
1	361954	3	230 VAC	Reiniger	4x6	K	Santoprene	NPG 3
2	361150 <sup>1</sup>	0,4	230 VAC	Klarspüler	4x6	D	Sekobril	PG
2	361151 <sup>1</sup>	1,5	230 VAC	Reiniger	4x6	K	Santoprene	PG
2	361484 <sup>1</sup>	3	24 VAC	Reiniger	4x6	K	Santoprene	PG
2	361152 <sup>2</sup>	3	230 VAC	Reiniger	4x6	K	Santoprene	PG
2	361868	3	230 VAC	Reiniger	4x6	K	Santoprene	PG

<sup>1</sup>mit Zubehör



Abb.	GEV-Nr.	FDM (l/h)	Versorgung	Anwendung	SAø (mm)	Schlauchtyp	Schlauch	Typ
3	361772 <sup>1</sup>	0,4	230 VAC	Klarspüler	4x6	D	Sekobril	PG
3	361771 <sup>1</sup>	3	230 VAC	Reiniger	6	K	Santoprene	PG
4	361322 <sup>1</sup>	1	24VDC	Klarspüler	6	B	Sekobril	PP
4	361884 <sup>1</sup>	1,25	24VDC	Klarspüler	6	A	Sekobril	PP
4	361321 <sup>1</sup>	7	24VDC	Reiniger	6	I	Santoprene	PP

<sup>1</sup>mit Zubehör

Ersatzteile

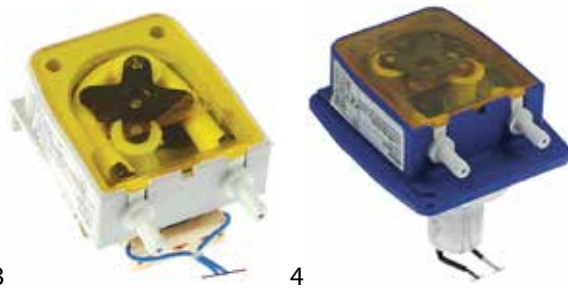

Abb.	GEV-Nr.	Beschreibung	Anwendung	Schlauch ø (mm)	SAø (mm)	Schlauchtyp	Schlauch
1	361239	Pumpenschlauch	Klarspüler	3x7	6	A	Sekobril



Abb.	GEV-Nr.	Beschreibung	Anwendung	Schlauch ø (mm)	SAø (mm)	Schlauchtyp	Schlauch
2	361882	Pumpenschlauch	Klarspüler	3x7,4	6	B	Sekobril



Abb.	GEV-Nr.	Beschreibung	Anwendung	Schlauch ø (mm)	SAø (mm)	Schlauchtyp	Schlauch
3	361890	Pumpenschlauch	Klarspüler	3x8	6	C	Sekobril



Abb.	GEV-Nr.	Beschreibung	Anwendung	Schlauch ø (mm)	SAø (mm)	Schlauchtyp	Schlauch
4	361925 <sup>1</sup>	Pumpenschlauch	Klarspüler	3x8	6	E	Sekobril

<sup>1</sup>mit Rückflussverhinderer



Abb.	GEV-Nr.	Beschreibung	Anwendung	Schlauch ø (mm)	SAø (mm)	Schlauchtyp	Schlauch
5	361135	Pumpenschlauch	Klarspüler	3x8	4x6	D	Sekobril



Abb.	GEV-Nr.	Beschreibung	Anwendung	Schlauch ø (mm)	SAø (mm)	Schlauchtyp	Schlauch
6	698710 <sup>1</sup>	Dosierschlauch	Klarspüler	5x10	4x6	F	Sekobril

<sup>1</sup>mit Rückflussverhinderer



7

Abb.	GEV-Nr.	Beschreibung	Anwendung	Schlauch ø (mm)	SAø (mm)	Schlauchtyp	Schlauch
7	698711	Dosierschlauch	Klarspüler	6x10	4x6	G	Sekobril



8

Abb.	GEV-Nr.	Beschreibung	Anwendung	Schlauch ø (mm)	SAø (mm)	Schlauchtyp	Schlauch
8	698712	Dosierschlauch	Reiniger	4x8,6mm	4x6	H	Santoprene



9

Abb.	GEV-Nr.	Beschreibung	Anwendung	Schlauch ø (mm)	SAø (mm)	Schlauchtyp	Schlauch
9	361238	Pumpenschlauch	Reiniger	6x10	6	I	Santoprene



10

Abb.	GEV-Nr.	Beschreibung	Anwendung	Schlauch ø (mm)	SAø (mm)	Schlauchtyp	Schlauch
10	361445	Pumpenschlauch	Reiniger	6x10	10	J	Santoprene



11

Abb.	GEV-Nr.	Beschreibung	Anwendung	Schlauch ø (mm)	SAø (mm)	Schlauchtyp	Schlauch
11	361815	Pumpenschlauch	Reiniger	6x10	4x6	K	Santoprene



1

Abb.	GEV-Nr.	Beschreibung
1	361136	Schlauchroller für Dosiergerät Loch ø 4,8x4mm

## Kolbenpumpen

### Dosiergeräte



1 2

Abb.	GEV-Nr.	Typ	Spng. (V)	Anwendung	Eingang (mm)	Ausgang (mm)
1	361941	14825-645	230	Reiniger	7	9
2	361260	BR3	230	Reiniger	6	6



3 4

Abb.	GEV-Nr.	Typ	Spng. (V)	Anwendung	Eingang (mm)	Ausgang (mm)
3	361597	DB	115-230	Klarspüler	6	6
4	361596	DT	115-230	Reiniger	6	6



5 6

Abb.	GEV-Nr.	Typ	Spng. (V)	Anwendung	Eingang (mm)	Ausgang (mm)
5	361800	EKP-R/E	230	Reiniger	8x12	8x12
6	361235 <sup>1</sup>	ELT 20	180-260	Klarspüler/Reiniger	6	6

<sup>1</sup>mit Zubehör



7

Abb.	GEV-Nr.	Typ	Spng. (V)	Anwendung	Eingang (mm)	Ausgang (mm)
7	361838	TTE	200-240	Reiniger	5,5	5,5

### mit Magnetspule



1

**Technische Daten:**  
Spannung 230V  
Einschaltdauer 25%

Abb.	GEV-Nr.	Eingang (mm)	Ausgang (mm)	Anwendung	Typ
1	361004	5	5	Klarspüler	DB2



2

**Technische Daten:**  
Spannung 230V  
Einschaltdauer 25%

Abb.	GEV-Nr.	Eingang (mm)	Ausgang (mm)	Anwendung	Typ
2	361013	4x6	5	Klarspüler	EKP-M



Ersatzteile



Abb.	GEV-Nr.	Beschreibung
1	361113	Magnetspule 230 VAC für Typ DB2
2	361482	Magnetspule 230 VAC für Typ EKP-M



Abb.	GEV-Nr.	Beschreibung
1	361047	Druck-/Saugventil passend für EKP-R
2	510298	Lippenventil Dosiergerät passend für DB2/DS5
3	361655	O-Ring passend für EKP-R
4	361366	Platine Spülmaschine 11F passend für DB2 Typ DB2/EV1/EKP-M



Abb.	GEV-Nr.	Beschreibung
5	361654	Schlauchtülle passend für EKP-R
6	361653	Schneidring passend für EKP-R
7	361652	Überwurfmutter passend für EKP-R G1: 3/8"

Membranpumpen

elektrisch gesteuert

Delta



Abb.	GEV-Nr.	Spng. (V)	Einschaltdauer (%)	Typ	Ventil
1	361003	220	25	EL-1	Lippenventil
2	361861	220	25	ELT 10	mit Kolben
3	361001	220	100	DELTA	Lippenventil
3	361023 <sup>1</sup>	230	100	DELTA	Lippen/CNS-Ventil

<sup>1</sup>Lippenventil CNS

Ersatzteile



Abb.	GEV-Nr.	Beschreibung
1	361319	Dichtung Gummi ID ø 9mm AD ø 14,5mm Materialstärke 1mm Typ DELTA
2	361950	Lippenventil DELTA
3	361122	Lippenventil Typ DELTA
4	361123	Membran Typ DELTA
5	361188	Scheibe Typ DELTA



Abb.	GEV-Nr.	Beschreibung
6	361169	Schlauchanschluss Typ DELTA
7	361168	Ventil Typ DELTA

selbstsaugend

LANG



Abb.	GEV-Nr.	Typ	Anwendung	Druckans. (mm)	Sauganschluss ø (mm)
1	361221	N6	Klarspüler	gerade, 4x6	6x8
2	361009	N6	Klarspüler	gerade, 4x6	gerade, 4x6



Abb.	GEV-Nr.	Typ	Anwendung	Druckans. (mm)	Sauganschluss ø (mm)
3	361575	N6	Klarspüler	gerade, 4x6	gewinkelt, 6
4	361817	N6	Klarspüler	gerade, 4x6	gewinkelt, 6



Abb.	GEV-Nr.	Typ	Anwendung	Druckans. (mm)	Sauganschluss ø (mm)
5	361008 <sup>1</sup>	N6	Klarspüler	gewinkelt, 4x6	gerade, 4x6
6	361032	N6	Klarspüler	gewinkelt, 4x6	gewinkelt, 4x6

<sup>1</sup>mit Zubehör

Abb.	GEV-Nr.	Typ	Anwendung	Druckans. (mm)	Sauganschluss ø (mm)
7	361916	N6	Klarspüler	gewinkelt, 6	gewinkelt, 6
8	361056	N6	Klarspüler	VA-Stahl	gerade, 4x6

### Ersatzteile

Abb.	GEV-Nr.	Beschreibung
1	361317	Dichtscheibe für Typ N6
2	361079	Feder für Typ N5/N6 für Kugel
3	361310	Halter für Typ N6 Kugelführung
4	361309	Kugel für Typ N5/N6

Abb.	GEV-Nr.	Beschreibung
5	361311	O-Ring EPDM Materialstärke 2mm ID ø 6mm
6	361314	Ventilring für Typ N6 Halterung für O-Ring

### Zubehör

Abb.	GEV-Nr.	Beschreibung
1	361476	Schlauchanschluss Einschraubwinkel
2	361318	Schlauchanschluss G1: 3/8" EP Pumpenausgang
3	361081	Schlauchanschluss G1: M16x1,5 Schlauch ø 4mm
4	361473	Schlauchanschluss gewinkelt Schlauch ø 6mm

Abb.	GEV-Nr.	Beschreibung
5	361086	Schlauchanschluss mit Überwurfmutter
6	361316	Schlauchanschluss mit Überwurfmutter G1: 3/8"
7	101286	Schneidring ID ø 6mm VPE 1 Stück
7	102586	Schneidring ID ø 6mm VPE 10 Stück
8	361083	Überwurfmutter G1: M10x1 für Schlauch 6mm

Abb.	GEV-Nr.	Beschreibung
9	361072	Überwurfschraube CNS G1: M10x1
10	361475	Verschraubung Druckanschluss CNS G1: 3/8" AG
11	361313	Verschraubung Federadapter
12	361076	Verstärkungsrohr L 18mm Materialstärke 0,5mm

### SEKO

Abb.	GEV-Nr.	Typ	Anwendung	Fördermenge	Druckans. (mm)	Sauganschluss ø (mm)
1	361217	DIB3E	Klarspüler	0-3cm³ je Hub	4x6	4x6
2	361594	DIB3E	Klarspüler	0-3cm³ je Hub	4x6	4x6

Abb.	GEV-Nr.	Typ	Anwendung	Fördermenge	Druckans. (mm)	Sauganschluss ø (mm)
3	361837 <sup>1</sup>	DIB5E	Klarspüler	0-5cm³ je Hub	4x6	6
4	361038 <sup>1</sup>	DIB5E	Klarspüler	0-5cm³ je Hub	4x6	4x6

<sup>1</sup>Hilfsdruckanschluss geschlossen

Abb.	GEV-Nr.	Typ	Anwendung	Fördermenge	Druckans. (mm)	Sauganschluss ø (mm)
5	361364 <sup>1</sup>	DIB5E	Klarspüler	0-5cm³ je Hub	4x6	4x6

<sup>1</sup>Hilfsdruckanschluss geschlossen

Ersatzteile



Abb.	GEV-Nr.	Beschreibung
1	361481	Lippenventil für Typ DIB3P/DIB5P DIB3E/DIB5E
2	361307	Membran Dosiergerät ø 68mm Loch ø 6mm für Typ DIB3P/DIB5P
3	361306	Membran für Typ DIB3E/DIB5E ø 49mm Loch ø 5mm
4	361304	O-Ring für Typ DIB3E/DIB5E EPDM ID ø 11,1mm Materialstärke 1,78mm VPE 1 Stück



Abb.	GEV-Nr.	Beschreibung
5	361301	Schlauchanschluss für Typ DIB3E/DIB5E
6	361302	Ventilbuchse für Typ DIB3E/DIB5E
7	361305	Ventilscheibe für Typ DIB3E/DIB5E DIB3P/DIB5P

Zubehör



Abb.	GEV-Nr.	Beschreibung
1	361240	Schlauchanschluss 1 Weg Schlauch ø 6mm Kunststoff
1	361241	Schlauchanschluss 1 Weg Schlauch ø 9mm Kunststoff

Diverse



Abb.	GEV-Nr.	Anwendung	Eingang (mm)	Ausgang (mm)	Druckans. (mm)	Sauganschluss ø (mm)
1	361731	Klarspüler	4	8	8	4
2	361370	Klarspüler	4x6	4x6	4x6	4x6



Abb.	GEV-Nr.	Anwendung	Eingang (mm)	Ausgang (mm)	Druckans. (mm)	Sauganschluss ø (mm)
3	361002	Klarspüler	6x8	4x6	4x6	6x8
4	361015	Klarspüler	6x8	4x6	4x6	6x8

Ersatzteile



Abb.	GEV-Nr.	Beschreibung
1	510847	Dichtung Glanzmitteldosierung ID ø 22mm AD ø 32mm
2	510916	Filter für Dosiergerät
3	510870	Filterhalter für Dosiergerät
4	510298	Lippenventil Dosiergerät passend für DB2/DS5



Abb.	GEV-Nr.	Beschreibung
5	361132	Membran Dosiergerät
6	361307	Membran Dosiergerät ø 68mm Loch ø 6mm
7	510297	Membran für Dosiergerät AD ø 83mm
8	361459	Schlauchanschluss ø 6mm für Dosiergerät



Abb.	GEV-Nr.	Beschreibung
9	510229	T-Stück Dosiergerät ø 28mm L 70mm
10	510338	Überwurfmutter Dosiergerät Gewinde 1/2" ø 32mm

selbstsaugend mit Hilfsdruck

DIHR



Abb.	GEV-Nr.	Eingang (mm)	Ausgang (mm)	Sauganschluss ø (mm)	Hilfsdruck (mm)
1	361744	4	8	4	10
2	361912	5	8	5	10

ELETTROBAR



Abb.	GEV-Nr.	Anwendung	Druckans. (mm)
1	361362	Klarspüler	6



1 2

Abb.	GEV-Nr.	Beschreibung
1	510298	Lippenventil Dosiergerät passend für DB2/DS5
2	361363	Membran

### GERMAC

#### Typ 1000



1 2 3

Abb.	GEV-Nr.	Eingang	Ausgang	Hilfsdruck	Rückschlagkugel	Feder (mm)	CODE
1	361485	4x6mm	M10x1	M12x1	CNS	1	VNR/A
1	361016	4x6mm	M10x1	M12x1	PTFE	1	VNR/A1
1	361520	4x6mm	M10x1	M12x1	PTFE	1,2	VNR/A2
2	361017	4x6mm	M10x1	M12x1	PTFE	1	VNR/U1
2	361529	4x6mm	M10x1	M12x1	PTFE	1,2	VNR/U2
3	361528	4x6mm	8mm	M12x1	PTFE	1	VNR/D



4 5

Abb.	GEV-Nr.	Eingang	Ausgang	Hilfsdruck	Rückschlagkugel	Feder (mm)	CODE
4	361519	4x6mm	M10x1	11mm	PTFE	1	VNR/A3
5	361486	4x6mm	M10x1	11mm	PTFE	1	VNR/U3

#### Typ 2000



1 2 3

Abb.	GEV-Nr.	Eingang	Ausgang	Hilfsdruck	Rückschlagkugel	Feder (mm)	CODE
1	361531	4x6mm	M10x1	M12x1	CNS	1	VNR/A
1	361532	4x6mm	M10x1	M12x1	PTFE	1	VNR/A1
1	361533	4x6mm	M10x1	M12x1	PTFE	1,2	VNR/A2
2	361537	4x6mm	M10x1	M12x1	PTFE	1	VNR/U1
2	361548	4x6mm	M10x1	M12x1	PTFE	1,2	VNR/U2
3	361547	4x6mm	8mm	M12x1	PTFE	1	VNR/D1



4 5 6

Abb.	GEV-Nr.	Eingang	Ausgang	Hilfsdruck	Rückschlagkugel	Feder (mm)	CODE
4	361534	4x6mm	M10x1	11mm	PTFE	1	VNR/A3
5	361535	4x6mm	M10x1	11mm	PTFE	1	VNR/U3
6	361536	4x6mm	8mm	11mm	PTFE	1	VNR/D3

#### Typ 2001



1 2 3

Abb.	GEV-Nr.	Eingang	Ausgang	Hilfsdruck	Rückschlagkugel	Feder (mm)	CODE
1	361538	4x6mm	M10x1	M12x1	CNS	1	VNR/A
1	361539	4x6mm	M10x1	M12x1	PTFE	1	VNR/A1
1	361540	4x6mm	M10x1	M12x1	PTFE	1,2	VNR/A2
2	361541	4x6mm	M10x1	M12x1	PTFE	1	VNR/U1
2	361542	4x6mm	M10x1	M12x1	PTFE	1,2	VNR/U2
3	361543	4x6mm	8mm	M12x1	PTFE	1	VNR/D1



4 5 6

Abb.	GEV-Nr.	Eingang	Ausgang	Hilfsdruck	Rückschlagkugel	Feder (mm)	CODE
4	361544	4x6mm	M10x1	11mm	PTFE	1	VNR/A3
5	361545	4x6mm	M10x1	11mm	PTFE	1	VNR/U3
6	361546	4x6mm	8mm	11mm	PTFE	1	VNR/D3

#### Ersatzteile



1 2 3 4

Abb.	GEV-Nr.	Beschreibung
1	361705	Dichtung für Schlauchnippel M12x1
2	361551	Druckfeder Drahtstärke $\varnothing$ 1mm
3	510298	Lippenventil Dosiergerät passend für DB2/DS5
4	361553	Membran EPDM



5 6 7 8

Abb.	GEV-Nr.	Beschreibung
5	510296	Membran Silikon
6	361700	Schlauchanschluss drehbar Schlauch $\varnothing$ 4x6mm
7	361703	Schlauchanschluss Gewinde M10x1 Messing
8	361701	Schlauchanschluss Gewinde M10x1 Tülle $\varnothing$ 7,5mm



9 10 11

Abb.	GEV-Nr.	Beschreibung
9	361704	Schlauchanschluss Messing gerade Gewinde M12x1
10	361702	Schlauchanschluss Messing Schlauch $\varnothing$ 4x6mm
11	361550	Schlauchanschluss Schlauch $\varnothing$ 4x6mm





GIADOS



1

Abb.	GEV-Nr.	Anwendung	Druckans. (mm)	Sauganschluss ø (mm)	Hilfsdruck (mm)
1	361883	Klarspüler	4x6	4x6	12

HOONVED



1

2

Abb.	GEV-Nr.	Anwendung	Druckans. (mm)	Sauganschluss ø (mm)	Hilfsdruck (mm)
1	361908	Klarspüler	7	5	10
1	361387	Klarspüler	8	4	10
2	361010	Klarspüler	4x6	4	10



1

2

Abb.	GEV-Nr.	Beschreibung
1	361383	Lippenventil Klarspüler
2	361384	Membran Klarspüler

OMNIWASH



1

Abb.	GEV-Nr.	Anwendung	Druckans. (mm)	Sauganschluss ø (mm)	Hilfsdruck (mm)
1	361054	Klarspüler	6	6	10



1

2

Abb.	GEV-Nr.	Beschreibung
1	361348	Lippenventil Klarspüler
2	361308	Membran Klarspüler

SEKO



1

**Technische Daten:**  
Hilfsdruckanschluss 10mm

Abb.	GEV-Nr.	Typ	Anwendung	FDM (l/h)	Sauganschluss ø (mm)
1	361218	DIB3P	Klarspüler	0-3cm³ je Hub	4x6



2

**Technische Daten:**  
Hilfsdruckanschluss 10mm

Abb.	GEV-Nr.	Typ	Anwendung	FDM (l/h)	Sauganschluss ø (mm)
2	361039	DIB5P	Klarspüler	0-5cm³ je Hub	4x6



1

2

3

4

Abb.	GEV-Nr.	Beschreibung	für Typ
1	361306	Membran	DIB3E/DIB5E
2	361304	O-Ring	DIB3E/DIB5E
3	361301	Schlauchanschluss	DIB3E/DIB5E
4	361302	Ventilbuchse	DIB3E/DIB5E



5

6

7

Abb.	GEV-Nr.	Beschreibung	für Typ
5	361305	Ventilscheibe	DIB3E/DIB5E
6	361481	Lippenventil	DIB3P/DIB5P
7	361307	Membran	DIB3P/DIB5P

Elektronikregler



1

2

Abb.	GEV-Nr.	Spng. (V)	Abb.	GEV-Nr.	Spng. (V)
1	361223	230	2	361261	230

**Zubehör**
**Behälterfilter**

Abb.	GEV-Nr.	SAø (mm)	Abb.	GEV-Nr.	SAø (mm)	Abb.	GEV-Nr.	SAø (mm)
1	361062	4	2	361251	4	3	513043	4



Abb.	GEV-Nr.	SAø (mm)	Abb.	GEV-Nr.	SAø (mm)	Abb.	GEV-Nr.	SAø (mm)
1	361141	4	2	361829	5	3	361230	4x6



Abb.	GEV-Nr.	SAø (mm)
4	361462	4x6

**Behälterfilter mit Rückschlagventil**

Abb.	GEV-Nr.	SAø (mm)	L (mm)	Abb.	GEV-Nr.	SAø (mm)	L (mm)
1	361106	4x6	51	3	361888	4x6	56
2	361058	4x6	56				



Abb.	GEV-Nr.	SAø (mm)	L (mm)
4	361411	8x10	45

**Filterbeschwerer**

Abb.	GEV-Nr.	ID ø (mm)	Außen-ø	Abb.	GEV-Nr.	ID ø (mm)	Außen-ø
1	361657	6	15	1	361229	6	20

**Elektroden Leitwersteuerung**

Abb.	GEV-Nr.	Einbau ø (mm)	Abb.	GEV-Nr.	Einbau ø (mm)	Abb.	GEV-Nr.	Einbau ø (mm)
1	361068	12	2	361274	17	3	361669	17



Abb.	GEV-Nr.	Einbau ø (mm)	Abb.	GEV-Nr.	Einbau ø (mm)
4	361149	21	5	361414	22

**Rückschlagventile**

Abb.	GEV-Nr.	Eingang (mm)	Ausgang	L (mm)
1	361899	-	-	9
2	361886	-	-	12,7
3	361898	6	6mm	48
4	361578	6	4x6mm	40



Abb.	GEV-Nr.	Eingang (mm)	Ausgang	L (mm)
5	361489	6	4x6mm	50
6	361488	4x6	1/8"	40
7	361147	4x6	1/8"	50
8	361821	4x6	1/4"	45



Abb.	GEV-Nr.	Eingang (mm)	Ausgang	L (mm)
9	508326	4x6	M10x1 IG	56
10	361678	5x8	1/8"	70

### Sauglanzen



Abb.	GEV-Nr.	L (mm)	Ausführung	SAø (mm)	KL (mm)
1	361911	165	NC	4,5	1750
1	361582	345	NC	6x8	1500
1	361581	345	NO	6x8	1500
1	361583	355	NC	6x8	1500
1	698713	380	mit Stecker	5	1500
1	361262	445	NO	6x8	1500



Abb.	GEV-Nr.	L (mm)	Rohr ø (mm)	SAø (mm)	KL (mm)
1	361118	415	10	4x6	-

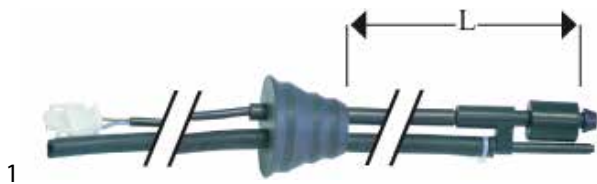

Abb.	GEV-Nr.	L (mm)	Rohr ø (mm)	SAø (mm)	KL (mm)
1	361164	500	21	4x6	-
1	361165	500	21	4x6	2500



Abb.	GEV-Nr.	L (mm)	Rohr ø (mm)	SAø (mm)	KL (mm)
1	361904	425	25	5/7	3000
1	361889	425	25	6x8	3000



Abb.	GEV-Nr.	L (mm)	Rohr ø (mm)	KL (mm)
1	361790	430	6	-



Abb.	GEV-Nr.	L (mm)	Rohr ø (mm)	SAø (mm)	Abb.	GEV-Nr.	L (mm)	Rohr ø (mm)	SAø (mm)
1	361412	450	10	JG 6	1	361413	450	10	JG 10

### Schläuche

#### Santoprenschläuche



Pos.	GEV-Nr.	ID ø (mm)	AD ø (mm)	Shore (°)	VPE (m)
1	361631	2,4	5,6	64	5
2	361632	3	5	64	5
3	361633	3,2	6,4	64	5
4	361634	4	6	64	5
5	361635	4	7	64	5
6	361636	4	8	64	5
7	361637	5	8	64	5
8	361638	6	9	64	5
9	361639	6	10	64	5
10	361549	6	10,5	55	1
11	361640	7	10	64	5

#### Silikonschläuche



Pos.	GEV-Nr.	ID ø (mm)	AD ø (mm)	L (m)	T.max. (°C)	Shore A (°)
1	361601	2	5,2	5	200	55
2	570601	2	5,2	100	200	55
3	361602	2,5	5,7	5	200	55
4	570602	2,5	5,7	100	200	55
5	361603	3	5	5	200	55
6	570603	3	5	100	200	55
7	361604	3	6	5	200	55
8	570604	3	6	100	200	55
9	361605	3	7	5	200	55
10	570605	3	7	100	200	55
11	520242	4	7	5	200	55
12	570606	4	7	100	200	55
13	361607	4	7,2	5	200	55
14	361608	4	8	5	200	55
15	570608	4	8	100	200	55
16	570611 <sup>1</sup>	5	8	-	200	55
17	361609	5	8	5	200	55
18	570609	5	8	100	200	55
19	361610	5	9	5	200	55
20	570550	6	10	100	200	55

<sup>1</sup>Meterware

#### PVC-Schläuche



Pos.	GEV-Nr.	ID ø (mm)	AD ø (mm)	L (m)	Pos.	GEV-Nr.	ID ø (mm)	AD ø (mm)	L (m)
1	520090	4	6	2	3	570127	4	6	4
2	570123	4	6	3,5					

## Schlauchverbinder



Abb.	GEV-Nr.	Ausführung	Schlauch ø (mm)	Abb.	GEV-Nr.	Ausführung	Schlauch ø (mm)
1	361494	2 Wege	4-4	1	361496	2 Wege	8-8
1	361497	2 Wege	4-6	1	361679	2 Wege	10-10
1	361498	2 Wege	4-8	1	361680	2 Wege	12-12
1	361495	2 Wege	6-6	1	361681	2 Wege	13-13
1	361499	2 Wege	6-8	1	361682	2 Wege	19-19

## Schlauchverschraubungen

### Kunststoff



Abb.	GEV-Nr.	Schlauch ø (mm)	Ausführung	Abb.	GEV-Nr.	Schlauch ø (mm)	Ausführung
1	361094	4x6-4x6	gerade	1	361095	6x8-6x8	gerade
1	361096	4x6-6x8	gerade				



Abb.	GEV-Nr.	Schlauch ø (mm)	Anschluss	Abb.	GEV-Nr.	Schlauch ø (mm)	Anschluss
1	361099	4	M10x1	3	361240	6	M10x1
1	361100	6	M10x1	3	361241	9	M10x1
2	361101	4	M10x1	4	361566	8	M15x1,5
2	361102	6	M10x1				



Abb.	GEV-Nr.	Schlauch ø (mm)	Anschluss	Abb.	GEV-Nr.	Schlauch ø (mm)	Anschluss
5	361845	10	3/8"	7	361091	6x8	M10x1
6	361493	6x8	1/8"	8	361700	4x6	M10x1
7	361090	4x6	M10x1				

### Metall



Abb.	GEV-Nr.	Schlauch ø (mm)	Abb.	GEV-Nr.	Schlauch ø (mm)
1	361176	4x6	2	361509	6x8
1	361508	6x8	3	361180	4x6
2	361177	4x6	3	361510	6x8



Abb.	GEV-Nr.	Schlauch ø (mm)	G	Abb.	GEV-Nr.	Schlauch ø (mm)	G
1	361253	6	1/8"	3	361175	4/6	3/8"
2	361170	4/6	1/8"	3	361503	6/8	1/8"
2	361171	4/6	1/4"	3	361504	6/8	1/4"
2	361172	4/6	3/8"	4	361178	4/6	1/8"
2	361500	6/8	1/8"	4	361179	4/6	1/4"
2	361501	6/8	1/4"	4	361506	6/8	1/8"
3	361173	4/6	1/8"	4	361507	6/8	1/4"
3	361174	4/6	1/4"				



Abb.	GEV-Nr.	G	SW	Material	Abb.	GEV-Nr.	G	SW	Material
1	361181	1/8"	14	MsNi	1	361183	3/8"	20	MsNi
1	361182	1/4"	17	MsNi	1	361184	1/2"	24	MsNi

## T-Stücke

### mit Rückschlagventil



Abb.	GEV-Nr.	Ausführung	SAø (mm)
1	361103	mit Rückschlagventil	10-4-6
2	361415	mit Rückschlagventil	13-4-6

### ohne Rückschlagventil



Abb.	GEV-Nr.	Ausführung	SAø (mm)	Abb.	GEV-Nr.	Ausführung	SAø (mm)
1	361491	3 Wege	12-6-12	1	519217	3-Wege	12-9-12
1	516082	3 Wege	12-7-12	2	361107	3-Wege	11-4-11
1	361490	3 Wege	10-8-10	3	508123	3-Wege	13-5-13
1	361492	3 Wege	12-8-12	4	361189	3-Wege	12-12

Wanneneinläufe



Abb.	GEV-Nr.	Material	Befestigungsart	SAø (mm)
1	510816	Edelstahl	M10	4
2	361677	Edelstahl	M10	5
3	361855	Edelstahl	M10	4/5/6
3	361856	Edelstahl	M12	4/5/6
4	361656	Edelstahl	M10x1,5	4



Abb.	GEV-Nr.	Material	Befestigungsart	SAø (mm)
5	508301	Kunststoff	M9x1,5	4
6	361858	Kunststoff	M10	5,5
7	361057	Kunststoff	M10	4x6
8	361105	Kunststoff	M10	4x6

Montagesätze



Abb.	1
GEV-Nr.	361144
Einsatzgebiet	Klarspüler
Schlauchtyp	4x6mm
Schlauchlänge (m)	2
Material	PVC/Nylonschlauch
Lieferumfang	Behälterfilter/Rückschlagventil



Abb.	2
GEV-Nr.	361891
Einsatzgebiet	Reiniger
Schlauchtyp	4x6mm
Schlauchlänge (m)	2
Material	PVC
Lieferumfang	2x Schlauch/Behälterfilter/Wanneneinlauf



Abb.	3
GEV-Nr.	361142
Einsatzgebiet	Reiniger
Schlauchtyp	4x6mm
Schlauchlänge (m)	2
Material	PVC
Lieferumfang	2x Schlauch/Behälterfilter/Wanneneinlauf



Abb.	4
GEV-Nr.	361222 <sup>1</sup>
Einsatzgebiet	Reiniger
Schlauchtyp	4x6mm
Schlauchlänge (m)	2
Material	PVC
Lieferumfang	2x Schlauch/Behälterfilter/Wanneneinlauf

<sup>1</sup>mit Schlauchanschluss



Abb.	5
GEV-Nr.	361143
Einsatzgebiet	Reiniger
Schlauchtyp	4x6mm
Schlauchlänge (m)	2
Material	PVC
Lieferumfang	2x Schlauch/Behälterfilter/Wanneneinlauf/Elektrode



Abb.	6
GEV-Nr.	361511
Einsatzgebiet	Reiniger
Schlauchtyp	6x9mm
Schlauchlänge (m)	2
Material	PVC
Lieferumfang	2x Schlauch/Behälterfilter/Wanneneinlauf



Abb.	7
GEV-Nr.	361942
Einsatzgebiet	Reiniger/Klarspüler
Schlauchtyp	6x9mm
Schlauchlänge (m)	2x2
Material	PVC
Lieferumfang	inkl. Behälterverschraubung und Behälterfilter

**GEV**

Home | Ein

WEBSHOP

Angebot Ihr Konto Anfragen

SERVICE KATALOGE HERSTELLER PRODUKTBEREICHE UNTERNEHMEN

Ersatzteile finden mit der  
**EXPRESS-SUCHE**

Suchbegriff eingeben

**SCHNELLSTE FREITEXTSUCHE  
DER BRANCHE**