



# Fittinge, Schlauch- und Rohrverbinder

# 6

Schlauchverbinder.	156
Wassersteckdosen.	157
Fittinge.	158
Schlauchanschlüsse.	162
Kupplungen.	164
Rohrsteckverbinder.	164

# Fittege, Schlauch- und Rohrverbinder

## Schlauchverbinder

ohne Verschraubung



1

**Technische Daten:**  
Material Kunststoff

Abb.	GEV-Nr.	Schlauch ø (mm)	Abb.	GEV-Nr.	Schlauch ø (mm)
1	361494	4-4	1	361496	8-8
1	361497	4-6	1	361679	10-10
1	361498	4-8	1	361680	12-12
1	361495	6-6	1	361681	13-13
1	361499	6-8	1	361682	19-19



2

**Technische Daten:**  
Material Kunststoff

Abb.	GEV-Nr.	Schlauch ø (mm)
2	515148	8/10/13/19/25



1

**Technische Daten:**  
Material Kunststoff

Abb.	GEV-Nr.	SAø (mm)	Abb.	GEV-Nr.	SAø (mm)	Abb.	GEV-Nr.	SAø (mm)
1	361683	10-10	1	501212	13-13	1	695873	17-17
1	361684	12-12	1	526673	15-15	1	361042	19-19



1

**Technische Daten:**  
Material Kunststoff

Abb.	GEV-Nr.	SAø (mm)	Abb.	GEV-Nr.	SAø (mm)
1	501488	5-5-5	1	504583	12-12-12
1	501341	6-6-6	1	505088	12-12-12
1	541109	8-6-8	1	501040	13-13-13
1	501210	10-10-10	1	501211	19-19-19
1	517166	10-10-10			



1

**Technische Daten:**  
Material Kunststoff

Abb.	GEV-Nr.	SAø (mm)	Abb.	GEV-Nr.	SAø (mm)
1	507174	4-4-4	1	518347	10-10-10
1	504302	10-6-10	1	519216	12-12-12
1	510843	10-6-10	1	510842	13-13-13
1	361491	12-6-12	1	698507	13-13-13
1	516082	12-7-12	1	510685	14-23-14
1	361490	10-8-10	1	695187	17-17-17
1	361492	12-8-12	1	695343	19-19-19
1	519217	12-9-12			



1

**Technische Daten:**  
Material Kunststoff

Abb.	GEV-Nr.	SAø (mm)
1	516103	12-12-12-12



1

**Technische Daten:**  
Material Messing

Abb.	GEV-Nr.	SAø (mm)	Abb.	GEV-Nr.	SAø (mm)
1	540498	13-13	1	540499	19-19



1

**Technische Daten:**  
Material CNS

Abb.	GEV-Nr.	SAø (mm)	Abb.	GEV-Nr.	SAø (mm)
1	504836	4-4	1	504801	7-13,5
1	504855	4-7	1	504804	10-10
1	504837	4,5-4,5	1	504803	10-13,5
1	504800	7-7	1	504824	13-13
1	504802	7-10			



1

**Technische Daten:**  
Material CNS

Abb.	GEV-Nr.	SAø (mm)	Abb.	GEV-Nr.	SAø (mm)
1	504805	7-7	1	504807	13,5-13,5
1	504806	10-10			



1

**Technische Daten:**  
Material CNS

Abb.	GEV-Nr.	SAø (mm)	Abb.	GEV-Nr.	SAø (mm)
1	504808	7-7	1	504810	13,5-13,5
1	504809	10-10			



1

**Technische Daten:**  
Material CNS

Abb.	GEV-Nr.	SAø (mm)	Abb.	GEV-Nr.	SAø (mm)
1	504811	7-7-7	1	504832	13,5-10-13,5
1	504812	10-7-10	1	504814	13-13-13
1	504830	7-10-7	1	504842	13-7/16"UNF-13
1	504813	10-10-10			



2

**Technische Daten:**  
Material CNS

Abb.	GEV-Nr.	SAø (mm)	Abb.	GEV-Nr.	SAø (mm)
2	504843	7-7-7	2	504845	12,5-12,5-12,5
2	504844	10-10-10			



1

**Technische Daten:**  
Material CNS

Abb.	GEV-Nr.	SAø (mm)	Abb.	GEV-Nr.	SAø (mm)
1	504815	4-4-4	1	504817	10-10-10
1	504854	5-5-5	1	504821	13-10-13
1	504816	7-7-7	1	524187	11-11-11
1	504819	10-7-10	1	504820	10-13-10
1	504831	13,5-7-13,5	1	504829	13-13-13
1	504818	7-10-7			



1

**Technische Daten:**  
Material CNS

Abb.	GEV-Nr.	SAø (mm)
1	504822	7-7-7-7
1	504834	7-10-7-10
1	504823	10-10-10-10
1	504835	10-13,5-10-13,5
1	504582	11-11-11-11
1	504833	13,5-13,5-13,5-13,5

mit Verschraubung



1

**Technische Daten:**  
Material Messing vernickelt

Abb.	GEV-Nr.	Schlauch ø (mm)	Abb.	GEV-Nr.	Schlauch ø (mm)
1	361176	4x6	1	361508	6x8



2

**Technische Daten:**  
Material Messing vernickelt

Abb.	GEV-Nr.	Schlauch ø (mm)	Abb.	GEV-Nr.	Schlauch ø (mm)
2	361177	4x6	2	361509	6x8



1

**Technische Daten:**  
Material Messing vernickelt

Abb.	GEV-Nr.	Schlauch ø (mm)	Abb.	GEV-Nr.	Schlauch ø (mm)
1	361180	4x6	1	361510	6x8

**Wassersteckdosen**



1

2

Abb.	GEV-Nr.	Beschreibung
1	591454	Kupplung Edelstahl Gewinde 1/2" VPE 1 Stück
2	591453	Nippel Edelstahl Gewinde 1/2" Schlauch ø 13mm VPE 1 Stück



3

Abb.	GEV-Nr.	Beschreibung
3	591452	Wassersteckdose Edelstahl komplett Gewinde 1/2" Schlauch ø 13mm VPE 1 Stück



2

**Technische Daten:**  
Material CNS

Abb.	GEV-Nr.	Anschluss
2	540525 <sup>1</sup>	1/2" - 1/2"

<sup>1</sup>drehbar

## Fittinge

### Doppelnippel



1

**Technische Daten:**  
Material Messing

Abb.	GEV-Nr.	Anschluss	Abb.	GEV-Nr.	Anschluss
1	520661	1/8" - 1/8"	1	520218	3/8" - 3/4"
1	520680	1/8" - 1/4"	1	520664	1/2" - 1/2"
1	520681	1/8" - 3/8"	1	520685	1/2" - 3/4"
1	520662	1/4" - 1/4"	1	520169	3/4" - 3/4"
1	520682	1/4" - 3/8"	1	520170	3/4" - 1"
1	520663	3/8" - 3/8"	1	520171	1" - 1"



1

**Technische Daten:**  
Material Kunststoff

Abb.	GEV-Nr.	Anschluss	Abb.	GEV-Nr.	Anschluss
1	520063	1/2" - 1/2"	1	520064	3/4" - 3/4"
1	520374	1/2" - 1/2"			

### Reduzierungen



1

**Technische Daten:**  
Material Messing

Abb.	GEV-Nr.	IG	AG	Abb.	GEV-Nr.	IG	AG
1	520692	1/8"	1/4"	1	520698	3/8"	1/2"
1	520690	1/4"	1/8"	1	529733	3/8"	1/2"
1	527207	1/4"	1/8"	1	520696	1/2"	3/8"
1	520694	1/4"	3/8"	1	520699	1/2"	1/2"
1	520691	3/8"	1/8"	1	520697	3/4"	3/8"
1	520693	3/8"	1/4"	1	520700	3/4"	1/2"
1	520695	3/8"	3/8"				



1

**Technische Daten:**  
Material Messing vernickelt

Abb.	GEV-Nr.	Anschluss	Abb.	GEV-Nr.	Anschluss
1	520160	1/8" - 1/8"	1	520165	1/4" - 1/2"
1	520161	1/8" - 1/4"	1	520166	3/8" - 3/8"
1	520162	1/8" - 3/8"	1	520167	3/8" - 1/2"
1	520163	1/4" - 1/4"	1	520168	1/2" - 1/2"
1	520164	1/4" - 3/8"	1	520208	1/2" - 3/4"



2

**Technische Daten:**  
Material Messing

Abb.	GEV-Nr.	IG	AG	Abb.	GEV-Nr.	IG	AG
2	520879	1/2"	3/4"	2	520880	1"	1 1/4"
2	520183	3/4"	1"	2	520211	1 1/2"	2"



1

**Technische Daten:**  
Material CNS

Abb.	GEV-Nr.	Anschluss	Abb.	GEV-Nr.	Anschluss
1	506013	1/4" - 3/8"	1	542150	1/2" - 3/4"
1	542149	1/2" - 1/2"	1	520887	3/4" - 3/4"
1	520874	1/2" - 3/4"			



**1**

**Technische Daten:**  
Material Messing vernickelt

Abb.	GEV-Nr.	IG	AG	Abb.	GEV-Nr.	IG	AG
1	520184	1/8"	1/8"	1	520188	3/8"	3/8"
1	520185	1/4"	1/8"	1	520189	1/2"	3/8"
1	520186	1/4"	1/4"	1	520190	1/2"	1/2"
1	520187	3/8"	1/4"				

**2**

**Technische Daten:**  
Material Messing vernickelt

Abb.	GEV-Nr.	IG	AG	Abb.	GEV-Nr.	IG	AG
2	520177	1/8"	1/4"	2	520181	3/8"	1/2"
2	520178	1/8"	3/8"	2	520209	3/8"	3/4"
2	520179	1/4"	3/8"	2	520182	1/2"	3/4"
2	520180	1/4"	1/2"				

**1**

**Technische Daten:**  
Material CNS

Abb.	GEV-Nr.	IG	AG
1	542146	1/2"	3/4"

**2**

**Technische Daten:**  
Material CNS

Abb.	GEV-Nr.	IG	AG
2	540524 <sup>1</sup>	1/2"	1/2"

<sup>1</sup>drehbar

### Muffen

**1**

**Technische Daten:**  
Material Messing vernickelt

Abb.	GEV-Nr.	Anschluss	Abb.	GEV-Nr.	Anschluss
1	520172	1/8" - 1/8"	1	520173	1/4" - 1/4"
1	520207	1/8" - 1/4"	1	520192	1/4" - 3/8"
1	520191	1/8" - 3/8"			

Abb.	GEV-Nr.	Anschluss	Abb.	GEV-Nr.	Anschluss
1	520193	1/4" - 1/2"	1	520175	1/2" - 1/2"
1	520174	3/8" - 3/8"	1	520176	3/4" - 3/4"
1	520194	3/8" - 1/2"			

### Winkelstücke

**1**

**Technische Daten:**  
Material Messing

Abb.	GEV-Nr.	G
1	541675	1/2" AG - 1/2" IG

**2**

**Technische Daten:**  
Material Messing

Abb.	GEV-Nr.	G
2	510464	1/4" IG - 3/8" IG

**3**

**Technische Daten:**  
Material Messing

Abb.	GEV-Nr.	G
3	531261	1/2" AG - 1/2" AG

**4**

**Technische Daten:**  
Material Messing

Abb.	GEV-Nr.	G
4	541924	1/2" IG - 1/2" IG

**1**

**Technische Daten:**  
Material Messing verchromt

Abb.	GEV-Nr.	G
1	541493	1/2" IG - 1/2" AG

**2**

**Technische Daten:**  
Material Messing verchromt

Abb.	GEV-Nr.	G
2	540020	1/2" IG - 1/2" IG

		<b>Technische Daten:</b> Material Messing vernickelt
<b>1</b>		
Abb.	GEV-Nr.	G
1	520816	1/8" AG - 1/8" AG
1	501162 <sup>1</sup>	1/4" AG - 1/4" AG
1	520817	1/4" AG - 1/4" AG
1	520818	3/8" AG - 3/8" AG
1	520819	1/2" AG - 1/2" AG

<sup>1</sup>inkl. je 1x Schneidring 10mm und Überwurfmutter

		<b>Technische Daten:</b> Material Messing vernickelt
<b>2</b>		
Abb.	GEV-Nr.	G
2	520824	1/8" AG - 1/8" IG
2	520827	1/2" AG - 1/2" IG
2	520825	1/4" AG - 1/4" IG
2	520826	3/8" AG - 3/8" IG

		<b>Technische Daten:</b> Material Messing vernickelt
<b>3</b>		
Abb.	GEV-Nr.	G
3	520820	1/8" IG - 1/8" IG
3	520821	1/4" IG - 1/4" IG
3	520822	3/8" IG - 3/8" IG
3	520823	1/2" IG - 1/2" IG

		<b>Technische Daten:</b> Material Edelstahl
<b>1</b>		
Abb.	GEV-Nr.	G
1	511951	3/8" IG - 3/8" IG

		<b>Technische Daten:</b> Material Tempereguss verzinkt
<b>1</b>		
Abb.	GEV-Nr.	G
1	541496	1/2" AG - 3/4" IG
1	541494	3/4" AG - 3/4" IG

		<b>Technische Daten:</b> Material Kunststoff
<b>1</b>		
Abb.	GEV-Nr.	G
1	520051	3/4" IG - 3/4" AG

**T-Stücke**
**Messing**

		<b>Technische Daten:</b> Material Messing	
<b>1</b>			
Abb.	GEV-Nr.	G	L (mm)
1	520918	1/8" AG - 1/8" AG - 1/8" AG	32
1	520711	3/8" AG - 3/8" AG - 3/8" AG	52

**Messing vernickelt**

		<b>Technische Daten:</b> Material Messing vernickelt	
<b>1</b>			
Abb.	GEV-Nr.	G	L (mm)
1	520386	1/8" AG - 1/8" AG - 1/8" AG	39
1	520343	1/4" AG - 1/4" AG - 1/4" AG	49
1	520344	3/8" AG - 3/8" AG - 3/8" AG	54
1	520345	1/2" AG - 1/2" AG - 1/2" AG	64
1	520358	3/4" AG - 3/4" AG - 3/4" AG	64

		<b>Technische Daten:</b> Material Messing vernickelt	
<b>2</b>			
Abb.	GEV-Nr.	G	L (mm)
2	520804	1/8" AG - 1/8" AG - 1/8" IG	37
2	520805	1/4" AG - 1/4" AG - 1/4" IG	47,5
2	520806	3/8" AG - 3/8" AG - 3/8" IG	52,5
2	520807	1/2" AG - 1/2" AG - 1/2" IG	61,5





**3**

**Technische Daten:**  
Material Messing vernickelt

Abb.	GEV-Nr.	G	L (mm)
3	520800	1/8" AG - 1/8" IG - 1/8" AG	35
3	520801	1/4" AG - 1/4" IG - 1/4" AG	46
3	520802	3/8" AG - 3/8" IG - 3/8" AG	51
3	520803	1/2" AG - 1/2" IG - 1/2" AG	59



**4**

**Technische Daten:**  
Material Messing vernickelt

Abb.	GEV-Nr.	G	L (mm)
4	520812	1/8" AG - 1/8" IG - 1/8" IG	37
4	520813	1/4" AG - 1/4" IG - 1/4" IG	47,5
4	520814	3/8" AG - 3/8" IG - 3/8" IG	52,5
4	520815	1/2" AG - 1/2" IG - 1/2" IG	61,5



**5**

**Technische Daten:**  
Material Messing vernickelt

Abb.	GEV-Nr.	G	L (mm)
5	520808	1/8" IG - 1/8" AG - 1/8" IG	39
5	520809	1/4" IG - 1/4" AG - 1/4" IG	49
5	520810	3/8" IG - 3/8" AG - 3/8" IG	54
5	520811	1/2" IG - 1/2" AG - 1/2" IG	64



**6**

**Technische Daten:**  
Material Messing vernickelt

Abb.	GEV-Nr.	G	L (mm)
6	520385	1/8" IG - 1/8" IG - 1/8" IG	35
6	520340	1/4" IG - 1/4" IG - 1/4" IG	46
6	520341	3/8" IG - 3/8" IG - 3/8" IG	51,5
6	520342	1/2" IG - 1/2" IG - 1/2" IG	59

**Edelstahl**



**1**

**Technische Daten:**  
Material Edelstahl

Abb.	GEV-Nr.	G	L (mm)
1	520710	1/4" AG - 1/4" AG - 1/4" AG	49
1	520712	1/2" AG - 1/2" AG - 1/2" AG	62

**Y-Stücke**



**1**

Abb.	GEV-Nr.	G	Material
1	520052	3/4" IG - 3/4" AG - 3/4" AG	Kunststoff

**Kreuzstücke**



**1**      **2**

**Technische Daten:**  
Material Messing vernickelt

Abb.	GEV-Nr.	G	L (mm)
1	520832	1x 1/8" AG - 3x 1/8" IG	37x39
1	520833	1x 1/4" AG - 3x 1/4" IG	48,5x49
1	520834	1x 3/8" AG + 3x 3/8" IG	54x56
1	520835	1x 1/2" AG - 3x 1/2" IG	61x64
2	520828	4x 1/8" IG	39x39
2	520829	4x 1/4" IG	49x49
2	520830	4x 3/8" IG	56x56
2	520831	4x 1/2" IG	64x64

**Rohrverschraubungen**

**Winkelstücke**



**1**      **2**

Abb.	GEV-Nr.	G	Rohr ø (mm)	Material
1	698714	1/2"	12	Messing
2	520348	5/8"	15	Edelstahl
2	520349	M23x1,5	16	Edelstahl

**T-Stücke**

**1**

**Technische Daten:**  
Material Edelstahl

Abb.	GEV-Nr.	G	Rohr ø (mm)	Abb.	GEV-Nr.	G	Rohr ø (mm)
1	520346	5/8"	15	1	520347	M23x1,5	16

**Verlängerungen**

**1**

Abb.	GEV-Nr.	G	L (mm)	Material
1	541925	1/2" IG - 1/2" AG	40	Messing
1	541926	3/4" IG - 3/4" AG	30	Messing
2	541927	3/4" IG - 3/4" AG	40	Messing verchromt

**Schlauchanschlüsse**
**Kunststoff**

**1**

**Technische Daten:**  
Material Kunststoff

Abb.	GEV-Nr.	G	SAø (mm)	VPE (Stück)	Abb.	GEV-Nr.	G	SAø (mm)	VPE (Stück)
1	361688	1/8"	4	1	1	361698	3/8"	12	1
1	361690	1/8"	6	1	1	361697	1/2"	8	1
1	361694	1/8"	8	1	1	361750	1/2"	12	1
1	361689	1/4"	4	1	1	520050	3/4"	10	1
1	361691	1/4"	6	1	1	361751	3/4"	19	1
1	361695	1/4"	8	1	1	361099	M10x1	4	1
1	361692	3/8"	6	1	1	361100	M10x1	6	1
1	361696	3/8"	8	1	1	361693	M10x1	8	1



**2**

**Technische Daten:**  
Material Kunststoff

Abb.	GEV-Nr.	G	SAø (mm)	VPE (Stück)	Abb.	GEV-Nr.	G	SAø (mm)	VPE (Stück)
2	520056	3/4"	11	5	2	506122	1 1/4"	31	1
2	520057	3/4"	13	5					



**1**

**Technische Daten:**  
Material Kunststoff

Abb.	GEV-Nr.	G	SAø (mm)	VPE (Stück)	Abb.	GEV-Nr.	G	SAø (mm)	VPE (Stück)
1	361752	1/8"	4	1	1	361760 <sup>1</sup>	3/8"	8	1
1	361754	1/8"	6	1	1	506125	3/8"	12	1
1	361758	1/8"	8	1	1	361761	1/2"	8	1
1	361753	1/4"	4	1	1	361686	1/2"	12	1
1	361755	1/4"	6	1	1	361762	3/4"	19	1
1	361735	1/4"	7	1	1	361101	M10x1	4	1
1	361759	1/4"	8	1	1	361102	M10x1	6	1
1	519277	1/4"	10	1	1	361757	M10x1	8	1
1	361756	3/8"	6	1					

<sup>1</sup>inkl. Ansaug- und Förderschlauch

**2**

**Technische Daten:**  
Material Kunststoff

Abb.	GEV-Nr.	G	SAø (mm)	VPE (Stück)	Abb.	GEV-Nr.	G	SAø (mm)	VPE (Stück)
2	520058	3/4"	11	5	2	520059	3/4"	13	5
2	528985 <sup>1</sup>	3/4"	13	1					

<sup>1</sup>inkl. Gummi Flachdichtung

**Messing**

**1**

Abb.	GEV-Nr.	G	SAø (mm)	VPE (Stück)	Abb.	GEV-Nr.	G	SAø (mm)	VPE (Stück)
1	520333	1/8"	7	1	1	520866	3/4"	30	1
1	103228	3/8"	10	1	1	511278	M8	6	1
1	511279	3/8"	12	1	1	361704	M12x1	11	1
1	520677	3/8"	13	1	1	520877	M14x1	11	1
1	103229	1/2"	10	1	2	512431	1/2"	10	1
1	520676	1/2"	12	1	2	512432	1/2"	12	1
1	540473	1/2"	13	1	2	520673	1/2"	14	1
1	511280	1/2"	14	1	3	512433	1/2"	10	1
1	505323	3/4"	10	1	3	512434	1/2"	12	1
1	540474	3/4"	19	1					



**4**

Abb.	GEV-Nr.	G	SAø (mm)	VPE (Stück)	Abb.	GEV-Nr.	G	SAø (mm)	VPE (Stück)
4	540510	3/4"	13	1	4	540511	3/4"	19	1







Abb.	GEV-Nr.	G	SAø (mm)	VPE (Stück)
1	513253	1/4"	12	1

Messing vernickelt



Abb.	GEV-Nr.	G	SAø (mm)	VPE (Stück)
1	520159	1/8"	6	1
1	520195	1/8"	7	1
1	520197	1/8"	8	1
1	520198	1/8"	9	1
1	520908	1/4"	5	1
1	520196	1/4"	7	1
1	520199	1/4"	9	1
1	520201	1/4"	12	1

Abb.	GEV-Nr.	G	SAø (mm)	VPE (Stück)
1	520200	3/8"	9	1
1	520202	3/8"	12	1
1	520204	3/8"	17	1
1	520203	1/2"	12	1
1	520205	1/2"	17	1
1	520206	3/4"	20	1
2	530230	3/4"	12	1



Abb.	GEV-Nr.	G	Schlauch ø (mm)	VPE (Stück)
1	361170	1/8"	4/6	1
1	361500	1/8"	6/8	1
1	361171	1/4"	4/6	1
1	361501	1/4"	6/8	1
1	361172	3/8"	4/6	1
2	361173	1/8"	4/6	1
2	361503	1/8"	6/8	1
2	361174	1/4"	4/6	1
2	361504	1/4"	6/8	1



Abb.	GEV-Nr.	G	SAø (mm)	VPE (Stück)
1	520248	1/8"	6	1
2	519239	1/4"	11	1
3	517108	3/8" AG - M10x1 IG	12	1



Abb.	GEV-Nr.	G	Schlauch ø (mm)	VPE (Stück)
1	361178	1/8"	4/6	1
1	361506	1/8"	6/8	1
1	361179	1/4"	4/6	1
1	361507	1/4"	6/8	1
2	520247	1/8"	4/6	1

Edelstahl



Abb.	GEV-Nr.	Ausführung	G	SAø (mm)	VPE (Stück)
1	542143	gerade	1/2"	10	1
1	542142	gerade	1/2"	13	1
1	501121	gerade	1/2"	19	1
2	542145	gerade	1/2"	10	1
2	540512	gerade	1/2"	13	1
2	542144	gerade	1/2"	13	1
3	540477 <sup>1</sup>	drehbar	1/2"	13	1

<sup>1</sup>drehbar



Abb.	GEV-Nr.	Ausführung	G	SAø (mm)	VPE (Stück)
4	540513 <sup>1</sup>	mit Überwurfmutter	1/2"	13	1
5	542956	drehbar	1/2"	13	1
5	542957	drehbar	1/2"	19	1

<sup>1</sup>drehbar



Abb.	GEV-Nr.	Ausführung	G	SAø (mm)	VPE (Stück)
1	504828	gewinkelt	3/8"	9	1
2	542141	gewinkelt	1/2"	11	1

Kupplungen

Messing verchromt



Abb.	GEV-Nr.	Beschreibung	Typ	Anschluss
1	540515	Kupplungsstecker	DN13	1/2" (ø13mm)
1	541987	Kupplungsstecker	DN13	3/4" (ø19mm)
2	540484	Kupplungsstecker	DN13	1/2" AG
2	540514	Kupplungsstecker	DN13	3/4" AG
3	540486	Kupplungsstecker	DN13	1/2" IG
3	540487	Kupplungsstecker	DN13	3/4" IG



Abb.	GEV-Nr.	Beschreibung	Typ	Anschluss
1	540485	Kupplungsbuchse	DN13	1/2" (ø13mm)
1	540643	Kupplungsbuchse	DN13	3/4" (ø19mm)
2	540641	Kupplungsbuchse	DN13	1/2" AG
2	540642	Kupplungsbuchse	DN13	3/4" AG
3	540516	Kupplungsbuchse	DN13	1/2" IG
3	540640	Kupplungsbuchse	DN13	3/4" IG

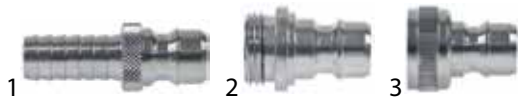

Abb.	GEV-Nr.	Beschreibung	Typ	Anschluss
1	540488	Kupplungsstecker	DN19	1/2" AG
2	540518	Kupplungsstecker	DN19	3/4" (ø19mm)
3	541988	Kupplungsstecker	DN19	3/4" AG



Abb.	GEV-Nr.	Beschreibung	Typ	Anschluss
1	540489	Kupplungsbuchse	DN19	3/4" (ø19mm)
2	541989	Kupplungsbuchse	DN19	3/4" AG
3	540519	Kupplungsbuchse	DN19	3/4" IG

Edelstahl



Abb.	GEV-Nr.	Beschreibung	Typ	Anschluss
1	540520	Kupplungsstecker	DN13	3/8" AG
1	540521	Kupplungsstecker	DN13	1/2" AG
2	542140	Kupplungsstecker	DN13	1/2" (ø13mm)
3	540522	Kupplungsstecker	DN13	1/2" IG



Abb.	GEV-Nr.	Beschreibung	Typ	Anschluss
1	542139	Kupplungsbuchse	DN13	1/2" (ø13mm)
2	540523	Kupplungsbuchse	DN13	1/2" AG
3	540479	Kupplungsbuchse	DN13	1/2" IG

Rohrsteckverbinder

JOHN GUEST



Abb.	GEV-Nr.	Stutzen ø	Tülle ø	Abb.	GEV-Nr.	Stutzen ø	Tülle ø
1	440679	5/16"	1/4"	1	440685	3/8"	1/2"
1	440680	5/16"	5/16"	1	440686	1/2"	3/8"
1	440681	5/16"	3/8"	1	440687	1/2"	1/2"
1	440682	3/8"	1/4"	1	440688 <sup>1</sup>	1/2"	1/2"
1	440683	3/8"	5/16"	1	440678	8mm	6mm
1	440684	3/8"	3/8"	1	440022	8mm	10mm

<sup>1</sup> lange Ausführung



Abb.	GEV-Nr.	Stutzen ø	Tülle ø	Abb.	GEV-Nr.	Stutzen ø	Tülle ø
1	440689	5/16"	1/4"	1	440690	3/8"	5/16"



Abb.	GEV-Nr.	Rohranschluss	Tülle ø	Abb.	GEV-Nr.	Rohranschluss	Tülle ø
1	440624	3/16"	5/16"	2	440630	3/8"	5/16"
1	440625	3/16"	3/8"	2	440631	1/2"	3/8"
1	440626	1/4"	3/8"	3	440020	ø6mm	8mm
1	440627	5/16"	3/8"	3	440019	ø6mm	10mm
1	440628	3/8"	1/2"	3	440015	ø8mm	10mm
1	440629	3/8"	15mm				



Abb.	GEV-Nr.	Rohranschluss	Tülle ø	Abb.	GEV-Nr.	Rohranschluss	Tülle ø
1	440666	1/4"	1/4"	1	440669	3/8"	3/8"
1	440667	5/16"	5/16"	1	440670	1/2"	1/2"
1	440668	5/16"	3/8"	2	440021	ø6mm	6mm

Tabellenfortsetzung auf der nächsten Seite



3

Abb.	GEV-Nr.	Rohranschluss	Tülle ø	Abb.	GEV-Nr.	Rohranschluss	Tülle ø
2	440671	ø8mm	8mm	2	440673	ø15mm	15mm
2	520359	ø10mm	10mm	3	440885	ø 8mm	8mm
2	440672	ø12mm	12mm				



1

Abb.	GEV-Nr.	Rohranschluss
1	440674	5/16" - 5/16" - 5/16"
1	440677	5/16" - 3/8" - 5/16"
1	440675	3/8" - 3/8" - 3/8"
1	440676	1/2" - 1/2" - 1/2"



1 2

Abb.	GEV-Nr.	Rohranschluss	Abb.	GEV-Nr.	Rohranschluss
1	440651	3/16" - 5/16"	1	440617 <sup>2</sup>	ø8mm - ø8mm
1	440613	1/4" - 1/4"	2	440646	ø4mm - ø6mm
1	440652	1/4" - 5/16"	2	440607	ø6mm - ø6mm
1	440653	1/4" - 3/8"	2	440647	ø6mm - ø8mm
1	440614	5/16" - 5/16"	2	520497	ø8mm - ø8mm
1	440654	5/16" - 3/8"	2	440619 <sup>1</sup>	ø8mm - ø8mm
1	440658 <sup>1</sup>	5/16" - 3/8"	2	440648	ø8mm - ø10mm
1	440615	3/8" - 3/8"	2	520493	ø8mm - ø10mm
1	440618 <sup>2</sup>	3/8" - 3/8"	2	440649	ø8mm - ø12mm
1	440656	3/8" - 1/2"	2	520492	ø10mm - ø10mm
1	440655	1/2" - 5/16"	2	440610	ø12mm - ø12mm
1	440616	1/2" - 1/2"	2	440611	ø15mm - ø15mm
1	440657	1/2" - ø15mm			

<sup>1</sup>beidseitig für Edelstahlrohre <sup>2</sup>einsseitig für Edelstahlrohre



1 2

Abb.	GEV-Nr.	Rohranschluss
1	440584	1/4" - 1/4" - 1/4"
1	440585	5/16" - 5/16" - 5/16"
1	440586	3/8" - 3/8" - 3/8"
1	440588	1/2" - 3/8" - 1/2"
1	440587	1/2" - 1/2" - 1/2"
2	440589	ø15mm - 3/8" - ø15mm
2	440579	ø4mm - ø4mm - ø4mm
2	440580	ø6mm - ø6mm - ø6mm
2	520363	ø10mm - ø10mm - ø10mm
2	440583	ø12mm - ø12mm - ø12mm



1 2

Abb.	GEV-Nr.	Rohranschluss	Abb.	GEV-Nr.	Rohranschluss
1	440597	3/16" - 3/16"	1	440665	3/8" - 1/2"
1	440661	3/16" - 5/16"	1	440664	1/2" - 5/16"
1	440598	1/4" - 1/4"	1	440601	1/2" - 1/2"
1	440662	1/4" - 5/16"	2	440590	ø4mm - ø4mm
1	440604 <sup>1</sup>	1/4" - 3/8"	2	440591	ø6mm - ø6mm
1	440599	5/16" - 5/16"	2	440659	ø6mm - ø8mm
1	440602 <sup>1</sup>	5/16" - 5/16"	2	440592	ø8mm - ø8mm
1	440606 <sup>2</sup>	5/16" - 5/16"	2	440660	ø8mm - ø12mm
1	440663	5/16" - 3/8"	2	520494	ø10mm - ø10mm
1	440605 <sup>1</sup>	5/16" - 3/8"	2	440594	ø12mm - ø12mm
1	440600	3/8" - 3/8"	2	440595	ø15mm - ø15mm
1	440603 <sup>1</sup>	3/8" - 3/8"			

<sup>1</sup>einsseitig für Edelstahlrohre <sup>2</sup>beidseitig für Edelstahlrohre



1 2

Abb.	GEV-Nr.	Rohranschluss	Abb.	GEV-Nr.	Rohranschluss
1	440716	1/2" - 1/2"	2	440715	ø15mm - ø15mm



1

Abb.	GEV-Nr.	Rohranschluss
1	440712	3/8" - 3x 3/8"



1 2 3

Abb.	GEV-Nr.	G	Stutzen ø	Abb.	GEV-Nr.	G	Stutzen ø
1	520495	1/8" BSP	8mm	2	440621	1/4" BSP	3/8"
1	440620	3/8" BSP	15mm	2	440622	3/8" BSP	3/8"
1	440608	1/2" BSP	10mm	3	440623	1/2" NPTF	1/2"



Abb.	GEV-Nr.	G	Rohranschluss
1	440561	1/8" BSP	ø8mm
1	440562	1/4" BSP	ø8mm
1	440564	1/4" BSP	ø10mm
1	440563	3/8" BSP	ø8mm
1	440565	3/8" BSP	ø10mm
1	440566	3/8" BSP	ø12mm
2	440567	1/4" BSP	1/4"
2	440568	1/4" BSP	3/8"
3	440555	1/4" BSPT	5/16"
3	440557	1/4" BSPT	3/8"
3	440556	3/8" BSPT	5/16"
3	440558	3/8" BSPT	3/8"
3	440559	3/8" BSPT	1/2"
3	440560	1/2" BSPT	1/2"



Abb.	GEV-Nr.	G	Rohranschluss
4	440550	1/4" BSPT	ø6mm
4	440551	1/4" BSPT	ø8mm
4	440552	1/4" BSPT	ø10mm
4	440553	3/8" BSPT	ø8mm
4	440554	3/8" BSPT	ø10mm
5	440578 <sup>1</sup>	1/4" MFL	5/16"
5	440577	3/8" MFL	3/8"
5	440576	1/2" MFL	3/8"
5	440575 <sup>2</sup>	1/2" MFL	ø8mm
6	440569	1/4" NPTF	1/4"
6	440571	1/4" NPTF	5/16"
6	440573	1/4" NPTF	3/8"
6	440570	3/8" NPTF	1/4"
6	440572	3/8" NPTF	5/16"
6	440574	3/8" NPTF	3/8"

<sup>1</sup>für Edelstahlrohre <sup>2</sup>konisch dichtend



Abb.	GEV-Nr.	G	Rohranschluss
7	440014	1/2" BSP	ø8mm - ø8mm



Abb.	GEV-Nr.	G	Rohranschluss
1	440636	1/4" BSP	ø6mm
1	440637	1/4" BSP	ø8mm
1	440639	1/4" BSP	ø10mm
1	440638	3/8" BSP	ø8mm
2	440640	1/4" BSPT	1/4"
2	440641	1/4" BSPT	5/16"
2	440643	1/4" BSPT	3/8"
2	440642	3/8" BSPT	5/16"
2	440644	3/8" BSPT	3/8"
3	440645	1/4" NPTF	3/8"

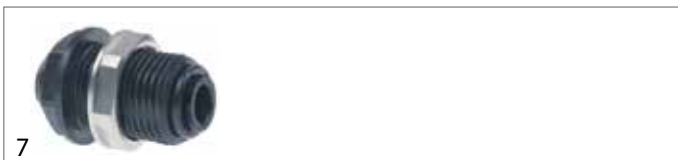

Abb.	GEV-Nr.	G	Rohranschluss	Abdichtung
1	520501	1/4" BSP	ø6mm	flachdichtend
1	440692	1/4" BSP	ø8mm	flachdichtend
1	440693	3/8" BSP	ø8mm	flachdichtend
2	440697	3/8" BSP	3/8"	flachdichtend
2	440694	1/2" BSP	5/16"	flachdichtend
2	440698	1/2" BSP	3/8"	flachdichtend
2	440695	5/8" BSP	5/16"	flachdichtend
2	440699	5/8" BSP	3/8"	flachdichtend
2	440701	5/8" BSP	1/2"	flachdichtend
3	440709	7/16" UNF (1/4" FFL)	5/16"	konisch
3	440710	7/16" UNF (1/4" FFL)	3/8"	konisch
3	520452	7/16" UNS	5/16"	konisch
3	440706	1/2"-16 UNS	5/16"	konisch
3	440707	1/2"-16 UNS	3/8"	konisch
3	440708	1/2"-16 UNS	1/2"	konisch



Abb.	GEV-Nr.	G	Rohranschluss	Abdichtung
4	440704	1/2" BSP	3/8"	konisch
4	440703	5/8" BSP	5/16"	mit Ansatz
4	440702	5/8" BSP	3/8"	mit Ansatz
4	440705	5/8" BSP	1/2"	mit Ansatz
5	440734 <sup>1</sup>	3/4" BSP	ø8mm	mit Ansatz

<sup>1</sup>mit Messinginsatz



Abb.	GEV-Nr.	Beschreibung	VPE (Stück)
1	440700	Einsatz John Guest für Rohraußen- $\varnothing$ (A) 8" VPE 1 Stück	1
2	440733	Klemmleiste John Guest für Rohraußen- $\varnothing$ (A) 1/2" VPE 1 Stück	1
2	440732	Klemmleiste John Guest für Rohraußen- $\varnothing$ (A) 3/8" VPE 1 Stück	1
3	440742	Schutzkappe John Guest für Rohraußen- $\varnothing$ (A) 3/8" VPE 1 Stück blau	1
3	440743	Schutzkappe John Guest VPE 1 Stück blau für Rohraußen- $\varnothing$ (A) 8mm	1

Abb.	GEV-Nr.	Beschreibung	VPE (Stück)
4	440740	Sicherungsring John Guest für Rohraußen- $\varnothing$ (A) 1/2" VPE 10 Stück	10
4	440738	Sicherungsring John Guest für Rohraußen- $\varnothing$ (A) 1/4" VPE 10 Stück	10
4	440739	Sicherungsring John Guest für Rohraußen- $\varnothing$ (A) 3/8" VPE 10 Stück	10
4	440735	Sicherungsring John Guest VPE 10 Stück für Rohraußen- $\varnothing$ (A) 8mm	10
5	440741	Sicherungsring John Guest VPE 1 Stück für Rohraußen- $\varnothing$ (A) 15mm	1
6	440744	Spanner Set John Guest VPE 1 Stück	1

Abb.	GEV-Nr.	Beschreibung	VPE (Stück)
7	440745	Spanner Speedfitting John Guest VPE 1 Stück	1
8	440635	Verschlussstopfen John Guest Stutzen-Außen- $\varnothing$ 1/2" VPE 1 Stück	1
8	440634	Verschlussstopfen John Guest Stutzen-Außen- $\varnothing$ 3/8" VPE 1 Stück	1
8	440633	Verschlussstopfen John Guest Stutzen-Außen- $\varnothing$ 5/16" VPE 1 Stück	1
9	440632	Verschlussstopfen John Guest Stutzen-Außen- $\varnothing$ 8" VPE 1 Stück	1

**DMfit**

Abb.	GEV-Nr.	Rohranschluss	Tülle $\varnothing$	Abb.	GEV-Nr.	Rohranschluss	Tülle $\varnothing$
1	440864	5/16"	5/16"	2	440865	$\varnothing$ 12mm	12mm

Abb.	GEV-Nr.	Rohranschluss	Abb.	GEV-Nr.	Rohranschluss
1	440844	1/4" - 1/4"	2	440857	$\varnothing$ 8mm - $\varnothing$ 10mm
1	440860	1/4" - 5/16"	2	440858	$\varnothing$ 8mm - $\varnothing$ 12mm
1	440861	1/4" - 3/8"	2	440840	$\varnothing$ 10mm - $\varnothing$ 10mm
1	440845	5/16" - 5/16"	2	440841	$\varnothing$ 12mm - $\varnothing$ 12mm
1	440862	5/16" - 3/8"	2	440859	$\varnothing$ 12mm - $\varnothing$ 16mm
1	440846	3/8" - 3/8"	2	440842	$\varnothing$ 15mm - $\varnothing$ 15mm
2	440855	$\varnothing$ 4mm - $\varnothing$ 6mm	2	440843	$\varnothing$ 16mm - $\varnothing$ 16mm
2	440838	$\varnothing$ 6mm - $\varnothing$ 6mm	2	440013	$\varnothing$ 18mm - $\varnothing$ 18mm
2	440856	$\varnothing$ 6mm - $\varnothing$ 8mm	3	440884 <sup>1</sup>	$\varnothing$ 6mm - $\varnothing$ 6mm
2	440839	$\varnothing$ 8mm - $\varnothing$ 8mm	3	520301 <sup>2</sup>	$\varnothing$ 6mm - $\varnothing$ 10mm

<sup>1</sup>Gewindegröße M16x1 <sup>2</sup>Gewindegröße M20x1,5

Abb.	GEV-Nr.	Rohranschluss	Abb.	GEV-Nr.	Rohranschluss
1	440834	3/16" - 3/16"	2	440830	$\varnothing$ 8mm - $\varnothing$ 8mm
1	440835	1/4" - 1/4"	2	440863	$\varnothing$ 8mm - $\varnothing$ 12mm
1	440836	5/16" - 5/16"	2	440831	$\varnothing$ 10mm - $\varnothing$ 10mm
1	440837	3/8" - 3/8"	2	440832	$\varnothing$ 12mm - $\varnothing$ 12mm
2	440828	$\varnothing$ 4mm - $\varnothing$ 4mm	2	440833	$\varnothing$ 16mm - $\varnothing$ 16mm
2	440829	$\varnothing$ 6mm - $\varnothing$ 6mm			

Abb.	GEV-Nr.	Rohranschluss
1	440825	1/4" - 1/4" - 1/4"
1	440826	5/16" - 5/16" - 5/16"
1	440827	3/8" - 3/8" - 3/8"
2	440820	$\varnothing$ 4mm - $\varnothing$ 4mm - $\varnothing$ 4mm
2	440821	$\varnothing$ 6mm - $\varnothing$ 6mm - $\varnothing$ 6mm
2	440822	$\varnothing$ 8mm - $\varnothing$ 8mm - $\varnothing$ 8mm
2	440823	$\varnothing$ 10mm - $\varnothing$ 10mm - $\varnothing$ 10mm
2	440824	$\varnothing$ 12mm - $\varnothing$ 12mm - $\varnothing$ 12mm

Abb.	GEV-Nr.	Rohranschluss
1	440866	5/16" - 5/16" - 5/16"





1

Abb.	GEV-Nr.	Rohranschluss	Abb.	GEV-Nr.	Rohranschluss
1	440874	ø12mm - ø12mm	1	440875	ø16mm - ø16mm



1 2 3

Abb.	GEV-Nr.	G	Rohranschluss
1	440814	1/4" BSP	1/4"
1	440815	1/4" BSP	3/8"
1	440810	3/8" BSP	5/16"
2	440809	1/4" BSP	ø8mm
2	440811	1/4" BSP	ø10mm
2	440812	3/8" BSP	ø10mm
2	440813	3/8" BSP	ø12mm
3	440805	1/4" BSPT	5/16"
3	440807	1/4" BSPT	3/8"
3	440806	3/8" BSPT	5/16"
3	440808	3/8" BSPT	3/8"



4 5

Abb.	GEV-Nr.	G	Rohranschluss
4	440800	1/4" BSPT	ø6mm
4	440801	1/4" BSPT	ø8mm
4	440802	1/4" BSPT	ø10mm
4	440803	3/8" BSPT	ø8mm
4	440804	3/8" BSPT	ø10mm
5	440817	1/4" NPTF	5/16"
5	440816	3/8" NPTF	1/4"
5	440818	3/8" NPTF	5/16"
5	440819	3/8" NPTF	3/8"



1 2

Abb.	GEV-Nr.	G	Rohranschluss
1	440847	1/4" BSP	ø6mm
1	440848	1/4" BSP	ø8mm
1	440850	1/4" BSP	ø10mm
1	440849	3/8" BSP	ø8mm
2	440851	1/4" BSPT	1/4"
2	440852	1/4" BSPT	5/16"
2	440853	3/8" BSPT	5/16"
2	440854	3/8" BSPT	3/8"



1 2 3

Abb.	GEV-Nr.	G	Rohranschluss	Abdichtung
1	440867	1/4" BSP	ø6mm	flachdichtend
1	440868	5/8" BSP	ø12mm	flachdichtend
2	440870	3/8" BSP	3/8"	flachdichtend
2	440871	1/2" BSP	3/8"	flachdichtend
2	440869	5/8" BSP	5/16"	flachdichtend
2	440872	5/8" BSP	3/8"	flachdichtend
2	440873	5/8" BSP	3/8"	mit Ansatz
3	440876	3/4" BSP	ø8mm	flachdichtend

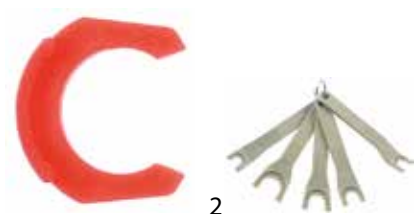

1 2

Abb.	GEV-Nr.	Beschreibung	VPE (Stück)
1	440882	Sicherungsring DMfit für Rohraußen-ø (A) 1/2" VPE 10 Stück	10
1	440880	Sicherungsring DMfit für Rohraußen-ø (A) 1/4" VPE 10 Stück	10
1	440878	Sicherungsring DMfit für Rohraußen-ø (A) 12" VPE 10 Stück	10
1	440879	Sicherungsring DMfit für Rohraußen-ø (A) 16" VPE 10 Stück	10
1	440881	Sicherungsring DMfit für Rohraußen-ø (A) 3/8" VPE 10 Stück	10
1	440877	Sicherungsring DMfit für Rohraußen-ø (A) 8" VPE 10 Stück	10
2	440883	Spanner DMfit VPE 1 Stück Set	1

Passendes Teil nicht gefunden?



[www.gev-online.de](http://www.gev-online.de)  
[www.gev-online.ch](http://www.gev-online.ch)  
[www.gev.at](http://www.gev.at)

**Noch mehr Ersatzteile  
finden Sie im GEV-Webshop**