



ascaso
COMPLEMENTS
& Tools for
Coffee Lovers
2019

Índice alfabético / Alphabetical index

ACAIA® (básculas)	71	ACAIA® (scales)	71
Accesorios café	66	AeroPress® (brewers / filters)	54
Adaptadores tolva lata	50	Aprons	69
AeroPress® (cafetera / filtros)	54	Ascaso cups	7
Aros desbroce	37	Barista briefcases	2
Básculas	70	Bartending	84
Bases inox para portafiltro - prensa café	24	Bonavita® (cone / jugs / kettles)	63
Bases prensa café	21	Bottomless filterholders	29
Batidores cappuccino	66	Can hopper adaptors	50
Bayetas	77	Cappuccino mixers	66
Bonavita® (cono / jarra / hervidores)	63	Capsule filterholders (direct extraction)	26
Cajones marro	34	Capsule filterholders (Lavazza Blue)	28
Cata (cuchara / bandeja / bol)	69	Capsule filterholders (super creamy)	27
Cepillos limpieza	75	Chemex® (jugs / filters)	55
Chemex® (jarras / filtros)	55	Cleaning brushes	75
Coctelería	84	Cleaning cloth	77
Cucharas	67	Cleaning products	78
Delantales	69	Clearing rings	37
Duchas y filtros teflonados	42	Cocoa duster	66
Espolvoreadores de cacao	66	Coffee accessories	66
Espresso Brewing (Cafeteras de filtro)	56	Coffee levelers	22
Espumadoras de leche	11	Conic burrs	47
Fresas cónicas	47	Crystal glass silkscreened	68
Fresas planas	43	Digital professional toaster	48
Hario® (cafeteras sifón / calentador halógeno)	62	Espresso Brewing (filter brewers)	56
Hario® (jarras / filtros / soportes / hervidores)	58	Filterholders	26
Herramientas	69	Filterholders with thermomanometer	31
Hervidores de agua	64	Flat burrs	43
IMS Competition Series (Duchas y filtros)	40	French-press	52
Jarras de leche	8	Hand grinders	68
Jarras y filtros Queen · Animo · Bonamat	51	Hario® (jugs / filters / supports / kettles)	58
Lapices latte art	66	Hario® (siphon brewers / halogen heater)	62
Lava jarras	11	IMS Competition Series (Shower and filters)	40
Llaveros	69	Jugs and filters Queen · Animo · Bonamat	51
Maletines barista	2	Jugs washers	11
Mandos vapor - agua estándar	33	Kettles	64
Mangos portafiltro estándar	32	Key chains	69
Molinos manuales	68	Knockbox	34
Niveladores de café	22	Latte art pens	66
Portafiltros	26	Milk frothers	11
Portafiltros cápsulas (extracción directa)	26	Milk jugs	8
Portafiltros cápsulas (Lavazza Blue)	28	Monodose filterholders	28
Portafiltros cápsulas (super crema)	27	Pressure gauge filterholders	30
Portafiltros con termomanómetro	31	Pro-fondi (Filterholder electric cleaner)	39
Portafiltros medidores de presión	30	Push tamper	22
Portafiltros monodosis	28	Refractometers	72
Portafiltros sin fondo	29	Scales	70
Prensas café	12	Silicone tamper - filterholder rugs	25
Prensas francesas	52	Siphons	65
Productos de limpieza	78	Spoons	67
Pro-fondi (Limpiador eléctrico portafiltros)	39	Stainless steel filterholder - tamper bases	24
Push (Pulsadores prensa café)	22	Standard filterholder handles	32
Refractómetros	72	Standard hopper	49
Sifones	65	Standard steam - water knobs	33
Tapetes silicona prensa café - portafiltro	25	Tamper bases	21
Tazas Ascaso	7	Tampers	12
Té (Accesorios)	86	Tasting (spoon / try / bowl)	69
Termómetros	73	Tea (Accessories)	86
Termos	64	Teflon showers and filters	42
Toddy (Cafeteras)	53	Thermometers	73
Tolva estándar	49	Thermos	64
Tostador profesional digital	48	Toddy brewers	53
Vasos de cristal serigrafiados	68	Tools	69

Maletines barista / Barista briefcases

Kit espresso test / Espresso test kit



V.3690

Kit Espresso Profesional
Professional Espresso Kit

Maletines barista / Barista briefcases

Kit espresso test / Espresso test kit



V.3565
Báscula Tangent 102
Tangent scale 102



C..256
Cacillo ciego goma
Rubber blind filter



F..156
Cacillo ciego inox
Stainless steel blind filter



V...26
Cepillo ducha
Brush for filter



V..590
Cepillo fresas
Brush grinding blades



V..645
Cepillo limpieza molino
Grinding brush



V..520
Cuchara plástico 7 g
Plastic spoon 7 g



V..681
Punzón goma porta
Gasket holder bradawl



HE.159
Destornillador estrella
Phillips screwdriver



HE.149
Destornillador plano
Screwdriver



V..100
Detergente grupo
10 sobres 20 g
Group detergent
10 bags 20 g



V.3543
Espolvoreador decoración
Cocoa duster



V..721
Jarra inox 0,4 L
Stainless steel jug 0,4 L



V..174
Kit comprobador
dureza agua
Water hardness check kit



V.3689
Kit comprobador
presión 3/8" ajustable
Adjustable pressure
check kit 3/8"



V.7845
Lápices decoradores
cappuccino (3 piezas)
Decorator pencils
(3 pieces)



V.1916
Prensa café aluminio
53/57 mm
Aluminium coffee tamper
53/57 mm



V..408
Termómetro analógico
0-100 °C
Analogic thermometer
0-100 °C



V..855
Vaso espresso test 30 ml
Espresso test glass 30 ml

Maletines barista / Barista briefcases

4 accesorios / 4 accessories



V.8543

CÓDIGO CODE	DESCRIPCIÓN / DESCRIPTION
V.6170	Jarra inox 0,50 L / Stainless steel jug 0,50 L
V.6169	Jarra inox 0,35 L / Stainless steel jug 0,35 L
V..408	Termómetro analógico 0-100 °C / Analogic thermometer 0-100 °C
V.7907	Prensa café aluminio Ø 58 mm / Aluminium tamper Ø 58 mm



V.6170



V.6169



V..408



V.7907

5 accesorios / 5 accessories



V.8544

CÓDIGO CODE	DESCRIPCIÓN / DESCRIPTION
V.3573	Jarra inox 0,75 L / Stainless steel jug 0,75 L
V.7972	Jarra cremera 0,07 L / Creamer jug 0,07 L
V..408	Termómetro analógico 0-100 °C / Analogic thermometer 0-100 °C
V.6945	Espolvoreador cacao / Cocoa duster
V.7907	Prensa café aluminio Ø 58 mm / Aluminium tamper Ø 58 mm



V.3573



V.7972



V..408



V.6945



V.7907

Maletines barista / Barista briefcases

7 accesorios / 7 accessories



V.8545

CÓDIGO CODE	DESCRIPCIÓN / DESCRIPTION
V.6170	Jarra inox 0,50 L / Stainless steel jug 0,50 L
V.6169	Jarra inox 0,35 L / Stainless steel jug 0,35 L
V..408	Termómetro analógico 0-100 °C / Analogic thermometer 0-100 °C
AC.501	Lápiz decorador azul / Blue decorator pencil
V.6945	Espolvoreador cacao / Cocoa duster
V.6360	Prensa café madera Ø 58 mm / Wooden tamper Ø 58 mm
V.6368	Base metal prensa café Ø 71 mm / Metal tamper base Ø 71 mm



V.6170



V.6169



V..408



AC.501



V.6945



V.6360



V.6368



V.8546

CÓDIGO CODE	DESCRIPCIÓN / DESCRIPTION
V.3573	Jarra inox 0,75 L / Stainless steel jug 0,75 L
V.6170	Jarra inox 0,50 L / Stainless steel jug 0,50 L
V..408	Termómetro analógico 0-100 °C / Analogic thermometer 0-100 °C
AC.501	Lápiz decorador azul / Blue decorator pencil
V.6945	Espolvoreador cacao / Cocoa duster
V.6360	Prensa café madera Ø 58 mm / Wooden tamper Ø 58 mm
V.6368	Base metal prensa café Ø 71 mm / Metal tamper base Ø 71 mm



V.3573



V.6170



V..408



AC.501



V.6945



V.6360



V.6368

Maletines barista / Barista Briefcases

4 accesorios / 4 accessories



V.7457

CÓDIGO CODE	DESCRIPCIÓN / DESCRIPTION
V.3573	Jarra inox 0,75 L / Stainless steel jug 0,75 L
V..408	Termómetro analógico 0-100 °C / Analogic thermometer 0-100 °C
V.6945	Espolvoreador cacao / Cocoa duster
V.7907	Prensa café aluminio Ø 58 mm / Aluminium tamper Ø 58 mm



V.3573



V..408



V.6945



V.7907

5 accesorios / 5 accessories



V.7880

CÓDIGO CODE	DESCRIPCIÓN / DESCRIPTION
V.6170	Jarra inox 0,50 L / Stainless steel jug 0,50 L
V..408	Termómetro analógico 0-100 °C / Analogic thermometer 0-100 °C
AC..80	Cuchara cata / Tasting spoon
V...26	Cepillo ducha / Shower brush
V.7912	Prensa café madera negro Ø 58 mm / Black wooden tamper Ø 58 mm



V.6170



V..408



AC..80



V...26



V.7912

Maletines barista / Barista Briefcases



CÓDIGO CODE	DESCRIPCIÓN / DESCRIPTION
TZ...1	Taza espresso + plato (2 uds.) / Espresso cup + dish (2 u.)
V..721	Jarra 0,40 L / Jug 0,40 L
V.1916	Prensa café aluminio Ø 53/57 mm / Aluminium tamper Ø 53/57 mm
V.3579	Cuchara ASCASO (2 uds.) / ASCASO spoon (2 u.)
V.3543	Espolvoreador cacao / Cocoa duster

V.3578



TZ...1



V..721



V.1916



V.3579



V.3543

Tazas y cucharas Ascaso / Ascaso cups and spoons



V.5978

Juego 12 cucharas
Set 12 Spoons



TZ...2

Taza cappuccino + plato
Cappuccino cup + dish



V.3504

Juego 6 cucharas
Set 6 Spoons



V.3502

Juego espresso 6 tazas + 6 platos
Set espresso 6 cups + 6 dishes



V.6777

Juego espresso LOVE 6 tazas + 6 platos
Set espresso LOVE 6 cups + 6 dishes

V.3503
Juego cappuccino 6 tazas + 6 platos
Set cappuccino 6 cups + 6 dishes

V.6778
Juego cappuccino LOVE 6 tazas + 6 platos
Set cappuccino LOVE 6 cups + 6 dishes

Jarras de leche / Milk jugs

Inox / **Stainless Steel**

Grosor 0,60 mm / **Thickness 0,60 mm**



V..714
0,15 L



V..721
0,40 L



V..715
0,60 L



V..716
0,90 L



V..717
1,60 L



V.5979
0,20 L



V.3567
0,30 L



V.3568
0,45 L



V.3569
0,65 L



V.3570
0,80 L



V.3571
1,10 L



Teflonadas / **Teflon**

Grosor 0,70 mm / **Thickness 0,70 mm**



V.7959
0,35 L



V.7960
0,60 L



V.7901
0,35 L



V.7946
0,60 L



V.7965
0,35 L



V.7966
0,60 L

Resistencia térmica máx. 290 °C / Head resistance max. 290 °C

Estabilidad criogénica -270 °C / Cryogenic stability -270 °C

Resistencia química: El Teflón no se ve afectado por los agentes químicos más usuales.

Chemical resistance: Teflon is not affected by the most common chemical agents.

Jarras de leche / Milk jugs

Inox / Stainless Steel

Grosor 1,30 mm / Thickness 1,30 mm



V.6168
0,25 L

V.6169
0,35 L

V.6170
0,50 L

V.3573
0,75 L

V.3574
1 L

V.6167
1,50 L

Negra / Black

Blanca / White



V.7975
0,35 L

V.7967
0,50 L

V.7968
0,75 L

V.7974
0,35 L

V.7969
0,50 L

V.7970
0,75 L



Tu marca / Your brand

Podemos incluir su logo grabado en láser.
We can include your logo by laser engraving.

Consúltenos / Contact Us

Jarras de leche / Milk jugs

Inox / Stainless Steel

Grosor 1,30 mm / Thickness 1,30 mm

Verde / Green



V.8286
0,35 L



V.8287
0,50 L



V.8288
0,75 L

Naranja / Orange



V.8280
0,35 L



V.8281
0,50 L



V.8282
0,75 L

Roja / Red



V.8283
0,35 L



V.8284
0,50 L



V.8285
0,75 L



Modelo Tulip / Tulip model

Jarra inox /
Stainless steel jug



V.8289
0,50 L



V.8290
0,50 L



V.8278
0,50 L



V.7972
0,07 L

Termómetro adhesivo / Thermo-label



V.7805

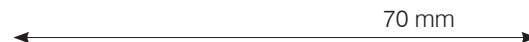
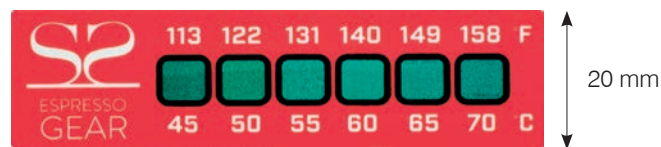

ATTENTO es un termómetro que se adhiere a las jarras de leche. Sus ranuras de cristal líquido indican la temperatura exacta cambiando del negro al verde. Reacción muy rápida. Duradero y de calidad profesional. Apto para lavavajillas. Peso 3 g.

The ATTENTO is a fast temp-label that your frothing pitcher. The label has liquid crystal slots which indicate the accurate temperature by becoming bright green. In comparison to digital or analogic thermometers, the liquid crystal shows temperature at the precise moment when the target temperature is reached. Weight 3 g.

Lava jarras / Jugs washers



V...12



V...14

CÓDIGO / CODE	POSICIÓN / POSITION	AGUJERO DE MONTAJE / MOUNTING HOLE	MEDIDAS / MEASURES
V...12	Sobremesa / Over Counter	-	174x160x129 mm
V...14	Encastre / Under Counter	141x153 mm	174x160x69 mm

Espumadoras de leche / Milk Frothers



V...15



V...16

CÓDIGO / CODE	VOLTAJE / VOLTAGE	POTENCIA / POWER	CAPACIDAD / CAPACITY	MEDIDAS / MEASURES
V...15	230V 50Hz	600 W	0,25 L	125x150x170 mm
V...16	230V 50Hz	600 W	0,45 L	125x180x180 mm

Prensas café / Coffee tampers

Tabla dimensiones prensas / Tampers size table

DIÁMETRO / DIAMETER	53	54	57	58	DIÁMETRO / DIAMETER	53	54	57	58
ASCASO				•	ISOMAC				•
ASTORIA CTS05 (PLUS4YOU)	•				LA MARZOCCO DOPPIO				•
ASTORIA CTS03				•	LA NUOVA ERA			•	
ASTRA			•		LELIT			•	
AURORA-BRUGNETTI				•	MAGISTER			•	•
BEZZERA				•	NUOVA SIMONELLI				•
BFC-ROYAL				•	LA PAVONI				•
BRASILIA				•	PROMAC			•	•
CARIMALI				•	RANCILIO			•	•
CASADIO				•	RENEKA			•	
CIMBALI			•		SAN MARCO	•			
CONTI SACOME				•	SANREMO			•	•
CREM EXPOBAR				•	LA SCALA-NORD EST				•
DALLA CORTE		•			LA SPAZIALE	•			
ECM-ROCKET				•	SV SAB ITALIA				•
ELEKTRA				•	SYNESSO				•
FAEMA FUTURMAT				•	UNIC			•	
FIAMMA				•	VFA EXPRESS			•	•
FRACINO				•	VIBIEMME			•	•
GAGGIA				•	VICTORIA ARDUINO			•	•
GRIMAC-FIORENZATO				•	VISACREM			•	•
GRUPPO IZZO	•				WEGA				•
IBERITAL			•		WEGA CONCEPT	•			

¿Qué medida de prensa necesito? What tamper measure I need?

Para saber el tamaño de prensa adecuado para su portafiltro debe medir el interior del cacillo, a la medida obtenida se le restará 1mm, el resultado obtenido será el ideal para el diámetro de prensa que debe usar.

Correctly sized, an espresso coffee tamper should be slightly smaller than the inside diameter of the filter basket. Measure the exact inside diameter of the basket and deduct 1mm. The result is the ideal tamper size.

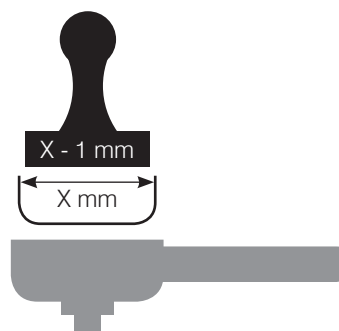

Prensas café / Coffee tampers

Dinamométricos / Dynamometrics

El prensa café dinamométrico es una nueva herramienta, de mecanismo muy sencillo, que se utiliza para solventar problemas de variabilidad e irregularidad en el prensado del café molido en el portafiltro.

Ventajas:

1. Presión y uniformidad en el prensado.
2. Decece la operación de regulación del molido.
3. Café más constante en la taza.

The coffee tamper dynamometric is a new tool of a very simple mechanism, used to solve variability problems and irregularities on the coffee pressing in the filter holder.

Advantages:

1. Pression and smoothness on the coffee pressing.
2. Decrease the operation of the grinding regulation.
3. Coffee more constant in the cup.



V.2532
Ø 51/57 mm



V.1844
Ø 57 mm
11 Kg



V.1966
Ø 53 mm
15-21 Kg



V.1967
Ø 58 mm
15-21 Kg

Prensas café / Coffee tampers

Aluminio + base inox con cerdas naturales limpia bordes
 Aluminium + stainless steel base with natural bristles to clean borders



V...25
 Ø 53 mm
V...27
 Ø 57 mm
V...28
 Ø 58 mm



V...33
 Ø 53 mm
V...35
 Ø 57 mm
V...36
 Ø 58 mm



V...37
 Ø 53 mm
V...47
 Ø 57 mm
V...65
 Ø 58 mm

Básicos / Basics



BASE
INOX

V..620
 Madera (base inox)
 Wood (stainless
 steel base)
 Ø 57 mm



BASE
INOX

V.7839
 Madera negra
 (base inox)
 Black wood
 (stainless steel base)
 Ø 57 mm



V.7878
 Inox
 Stainless steel
 Ø 58 mm



V.1916
 Aluminio pulido
 Polished aluminium
 Ø 53/57 mm



Nylon / Nylon
V..521
 Ø 40/56 mm
V...17
 Ø 50/57 mm
V...66
 Ø 53/58 mm

Tu marca / Your brand

Podemos incluir su logo grabado en láser.
 We can include your logo by laser engraving.

Consúltenos / Contact Us



Prensas café / Coffee tampers

Madera + base inox / Wood + stainless steel base



V.7913
Ø 53 mm
V.7912
Ø 58 mm



V.7909
Ø 53 mm
V.3360
Ø 57 mm
V.7908
Ø 58 mm



V.7917
Ø 53 mm
V.3359
Ø 57 mm
V.7916
Ø 58 mm



V.7921
Ø 53 mm
V.3361
Ø 57 mm
V.7920
Ø 58 mm

Base abombada / Convex base

V.7914
Ø 58 mm

V.7910
Ø 58 mm

V.7918
Ø 58 mm

V.7922
Ø 58 mm



V...71
Ø 53 mm
V...72
Ø 57 mm
V...73
Ø 58 mm



V.7926
Ø 53 mm
V.3365
Ø 57 mm
V.7925
Ø 58 mm



V.7930
Ø 53 mm
V.3363
Ø 57 mm
V.7929
Ø 58 mm



V.7934
Ø 53 mm
V.3364
Ø 57 mm
V.7933
Ø 58 mm

Base abombada / Convex base

V.3362
Ø 58 mm

V.7927
Ø 58 mm

V.7931
Ø 58 mm

V.7935
Ø 58 mm

Prensas café / Coffee tampers

Madera + base inox / Wood + stainless steel base



V.6362 Ø 49 mm
V.6361 Ø 52 mm
V.8001 Ø 53 mm
V.6363 Ø 54 mm
V.8002 Ø 57 mm
V.6360 Ø 58 mm



V.8291 Ø 49 mm
V.8292 Ø 52 mm
V.8293 Ø 53 mm
V.8294 Ø 54 mm
V.8295 Ø 57 mm
V.8296 Ø 58 mm



V.8298 Ø 49 mm
V.8299 Ø 52 mm
V.8300 Ø 53 mm
V.8301 Ø 54 mm
V.8302 Ø 57 mm
V.8303 Ø 58 mm



V.7924 Ø 58 mm

Base abombada / Convex base

V.6364 Ø 58 mm

V.8297 Ø 58 mm

V.8304 Ø 58 mm

V.7945 Ø 58 mm

Aluminio / Aluminium



V.8305
Ø 58 mm



V.1391
Ø 58 mm



V.7903 Ø 58 mm

V.7904 Ø 58 mm
Base abombada
Convex base



V.7884 Ø 53/58 mm



V.7907 Ø 58 mm

Rainbow (resina poliéster + inox)
Rainbow (Polyester Resin + stainless steel)

Kit / Kit



V.8308
Ø 58 mm



V.8309
Ø 58 mm



V.8310
Ø 58 mm



V.8311 (Kit)
Mango madera /
Handle wood
V.408 Termómetro /
Thermometer

Base Ø 49 mm
Base Ø 52 mm
Base Ø 53 mm
Base Ø 57 mm
Base Ø 58 mm



Prensas café / Coffee tampers

Mangos Elegance / Elegance handles



V.8148
Madera haya
Beech wood



V.8149
Madera roble
Oak wood



V.8150
Madera nogal
Walnut wood



V.8151
Madera arce
Maple wood

Mangos Pop / Pop handles



V.8155
Aluminio negro
Black aluminium



V.8156
Aluminio rojo
Red aluminium



V.8157
Aluminio rosa
Pink aluminium



V.8158
Aluminio blanco
White aluminium

Mangos Technic (presión ajustable 8-21 kg.) Technic handles (adjustable pressure 8-21 kg.)



V.8144
Aluminio negro
Black aluminium



V.8145
Aluminio gris
Gray aluminium



V.8146
Aluminio plata
Silver aluminium



V.8147
Aluminio rojo
Red aluminium

Prensas café / Coffee tampers

Bases prensas café inox / Stainless steel coffee tampers bases (Elegance / Pop / Technic)

Modelo Knock / Knock model



CÓDIGO CODE	Ø mm	CÓDIGO CODE	Ø mm
V.8159	47	V.8166	57
V.8160	49	V.8167	58
V.8161	51	V.8168	53*
V.8162	53	V.8169	55*
V.8163	54	V.8170	57*
V.8164	55	V.8171	58*
V.8165	56		

Modelo básico / Basic model



CÓDIGO CODE	Ø mm	CÓDIGO CODE	Ø mm
V.8174	48	V.8182	56
V.8175	49	V.8183	57
V.8176	50	V.8184	58
V.8177	51	V.8185	53*
V.8179	53	V.8186	57*
V.8180	54	V.8187	58*
V.8181	55		

* Base abombada / Convex base

Mangos Classic / Classic handles



V.8190
Madera nogal
Walnut wood



V.8191
Madera nogal
Walnut wood

Bases prensas café / Coffee tampers bases (Classic)

Aluminio / Aluminium



CÓDIGO CODE	Ø mm
V.8207	48
V.8209	55
V.8210	56
V.8211	58

Inox / Stainless steel



CÓDIGO CODE	Ø mm
V.8212	48
V.8214	53
V.8216	55
V.8217	56
V.8218	57
V.8219	58

Prensas café / Coffee tampers

Modelo Barista / Barista model



CÓDIGO CODE	Ø mm
V.7812	53
V.7811	57
V.7809	58

Para uso profesional. Base hueca (para un menor peso) en acero inox. Peso 250 g. El prensa café Barista completo se sirve con el mango negro. Para cambiarlo de color adquiera un mango de recambio.

The Barista tamper is made for professional use. The Barista is the only die cast, hollow base stainless steel tamper on the market. It is perfectly balanced and has a comfortable weight of about 250 g. Complete Barista tamper is served with black handle. For change color buy a spare handle.

Mangos intercambiables Barista / Barista Interchangeable handles

Madera / Wood

Nylon / Nylon



V.7819
Madera roble
Oak wood



V.7820
Negro
Black



V.7821
Azul
Blue



V.7822
Marrón
Brown



V.7823
Verde
Green



V.7824
Terciopelo rojo
Red velvet



V.7825
Naranja
Orange



V.7826
Rosa
Pink



V.7827
Rojo
Red



PARA MODIFICAR LA ALTURA (sólo modelo BARISTA)
Sacar la arandela extensora para reducir la altura del prensa café.

TO MODIFY HEIGHT (just BARISTA model)
Remove the spreader washer to reduce tamper height.



1. Desatornillar el mango en sentido contrario a las agujas del reloj.
Unscrew the handle a counter clockwise.
2. Acoplar el mango en el mismo sentido de las agujas del reloj.
Assemble the handle lockwise.



Modelo Luce / Luce model

CÓDIGO CODE	Ø mm
V.7816	53
V.7815	57
V.7814	58

Excelente tamper, combinación de nylon y acero inox. La base se separa del cuerpo, pudiendo cambiar multitud de colores. Peso 160gr.

Mostly recycled nylon, but also top notch hand polished stainless steel. Build your own. The stainless steel bottom is separate from the plastic handle, and can be exchanged as you please. Weight 160gr.

Mangos intercambiables de nylon Luce / Luce interchangeable nylon handles

Sólo son compatibles con las bases de Ø 57/58 mm. / Only suitable with bases with Ø 57/58 mm.



V.7828
Negro / Black



V.7829
Azul / Blue



V.7830
Marrón / Brown



V.7831
Verde / Green



V.7832
Rosa / Pink



V.7833
Rojo / Red



Modelo Primo / Primo model

CÓDIGO CODE	Ø mm
V.7818	58

El más alto de la gama. Como el modelo BARISTA tiene la base hueca de aceo inox. Con marcas en bronce, su aspecto es de la máxima calidad. Peso 360 g.

Just like the BARISTA, the Primo has a hollow base for perfect balance but weighs a bit more (450 g). It is, of course, made from hand polished stainless steel. The brass marking signals that this is a pro tamper for the selective espresso connoisseur. A true piece of craftsmanship! Weight 360 g.

Bases prensa café / Tamper bases



V.7938 Ø 55 mm
V.7937 Ø 60 mm
 Madera natural marrón
 Natural brown wood



V.7940 Ø 55 mm
V.7939 Ø 60 mm
 Madera nogal marrón
 Walnut brown wood



V.7942 Ø 55 mm
V.7941 Ø 60 mm
 Madera roja
 Red wood



V.7944 Ø 55 mm
V.7943 Ø 60 mm
 Madera negra
 Black wood



V.6367
 Madera abombada
 Convex wood
 Ø 58 mm



V.6368
 Aluminio con goma
 Aluminium with rubber
 Ø 71 mm



V.1392
 Madera natural
 Natural wood
 Ø 58 mm



V.6369
 Silicona
 Silicone
 Ø 71 mm



V...76
 Madera haya negra
 Black beech wood
 Ø 80 mm



Base ajustable / Adjustable base

Permite controlar la fuerza en el prensado. Al hacer un click indica que hemos efectuado la fuerza ajustada (entre 10 y 25 Kg.). Basta quitar la lámina de silicona y ajustar la fuerza con una moneda o un destornillador. De serie viene con dos superficies de silicona de recambio. Medida: 110x20 mm. Peso: 180 gr.

The Clickmat does this by telling you when you have tamped with de correct force. "It just said click!" The design of the product is intuitive as can be, simply remove this silicone tamping sheet from the Clickmat and adjust it to what force it should "click". You can set it between 10 to 25 Kg. The signal gives a distinct "click" when the pressure equals the adjusted weight. It comes with two replacement silicone mates. Size 110x20 mm. Weight: 180 gr.



V.7806



1. CLICK MAT calibra la fuerza del prensado.
CLICK MAT calibrates pressure strenght.

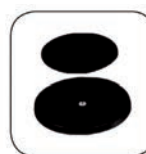

2. Colocar el portafiltro en el centro del CLICK MAT. Prensar el café hasta oír click.
Place filterholder in the center of CLICK MAT. Press coffee until hear click.

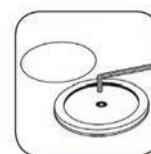

3. Ajustar la fuerza del prensado entre 15-20 Kg. antes de usarlo por primera vez.
Adjust pressure strenght between 15-20 Kg. before first use.

Niveladores de café / Coffee levelers



V.1388 Ø 53 mm
V.1389 Ø 57 mm
V.1390 Ø 58 mm

Características / Features

- Dotado de tres ángulos inclinados que distribuyen uniformemente el café en el filtro / With three inclined angles wich distributes coffee into the filter in an effect.
- Fabricado en acero inoxidable / Made of stainless steel.



Pulsador prensa café / Push tamper

PUSH es vendido, usado y confiado por muchas de las mejores empresas de café en el mundo. Es el tamper de palma original que impactó en los Campeonatos Barista del Mundo 2015.

PUSH is sold, used and trusted by many of the best coffee companies in the world. It is the original palm tamper that caused shock waves at the World Barista Championships in 2015.



V.1014
Negro / Black



V.1018
Azul / Blue



V.1034
Rojo / Red

Otros colores bajo pedido / Other colors on request



Pulsador prensa café / Push tamper



Precisión / Precision

PUSH reduce la canalización y promueve un expreso más equilibrado y extraído uniformemente. El ajuste continuo, con precisión de 0.1 mm, permite una precisión absoluta en variaciones sutiles en las recetas.

PUSH reduces channelling and promotes a more balanced and evenly extracted espresso. Stepless adjustment, accurate to 0.1mm allows for absolute precision across subtle variances in recipes.

Consistencia / Consistency

Una vez configurado, PUSH asegura una presión de apisonamiento constante todas y cada una de las veces.

Once set, PUSH ensures a consistent tamping pressure each and every time.



Ergonómicos / Ergonomics

PUSH es el único tamper desarrollado y probado por expertos en Ergonomía para reducir el riesgo de lesiones. El diseño único del mango le permite aplicar presión con la palma abierta.

PUSH is the only tamper developed with and tested by Ergonomics experts to reduce the risk of injury. The unique handle design allows you to apply pressure with an open palm.

El mando / The handle

Mecanizado en aluminio aeroespacial y anodizado para reducir la corrosión y el desgaste.

Machined from aerospace grade aluminium and beautifully anodised to reduce corrosion and wear.



La base / The base

Mecanizado del acero inoxidable increíblemente preciso diámetro de 58,5mm. Láser marcado con incrementos de 1 mm para una configuración rápida y fácil.

Machined from stainless steel incredibly accurate 58,5mm diameter. Laser marked with 1mm increments for fast and easy setup.

Bases inox portafiltro - prensa café Stainless steel filterholder - tamper bases



concept-art

V.6370

Acero inoxidable con silicona negra
Stainless steel with black silicone
120x180x80 mm



SP
GEAR

V.7947

Acero inoxidable con silicona negra
Stainless steel with black silicone
90x145x60 mm



concept-art

V.3508

Acero inoxidable
Stainless steel
95x155x65 mm



concept-art

V.6375

Acero inoxidable con silicona negra
Stainless steel with black silicone
90x200x70 mm



concept-art

V.6376

Acero inoxidable con silicona negra
Stainless steel with black silicone
90x200x70 mm

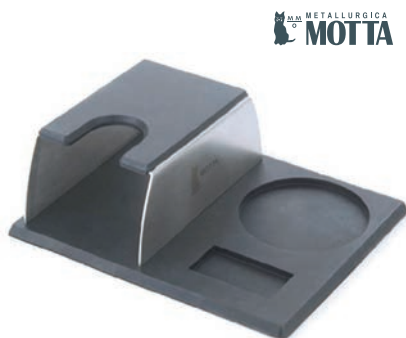

M.M. METALLURGICA
MOTTA

V.6365

Acero inoxidable
Stainless steel
180x120x80 mm



M.M. METALLURGICA
MOTTA

KIT

V.6366

Acero inoxidable
Stainless steel
180x120x80 mm



concept-art

V.6373

Mármol con silicona negra
Marble with black silicone
120x180x80 mm

Bases inox portafiltro Stainless steel filterholder bases



V.3506

Acero inoxidable / Stainless steel
80x115x65 mm



AC.502

Acero inoxidable / Stainless steel
80x11x70 mm



concept-art

V.6374

Acero inoxidable con silicona negra
Stainless steel with black silicone
90x130x60 mm



V.3507

Acero inoxidable / Stainless steel
95x130x65 mm



V...74

Acero inoxidable / Stainless steel
105x65x65 mm

Tapetes silicona prensa café - portafiltro Silicone tamper - filterholder rugs



ESPRESSO
GEAR

V.7807

Silicona negra / Black silicone
Ø 140 mm



ESPRESSO
GEAR

V.8052

Silicona negra / Black silicone
135x150x50 mm



ESPRESSO
GEAR

V.8003

Silicona negra / Black silicone
200x140x50 mm



concept-art

V.8004

Silicona negra / Black silicone
150x135 mm



concept-art

V.8053

Silicona negra / Black silicone
200x150x45 mm



V.1036

Silicona negra / Black silicone
210x150x45 mm

Portafiltros / Filterholders

Portafiltros para cápsulas FAP (extracción directa)
Capsule filterholders FAP (direct extraction)



Simple



Doble



Adaptador portafiltros cápsulas
Capsule filterholder adapter



PM.278



ADAPTABLE / SUITABLE	SIMPLE	DOBLE	ALETAS FINS	SIMPLE	DOBLE
	CÓDIGO CODE	CÓDIGO CODE		CÓDIGO CODE	CÓDIGO CODE
ASCASO BAR / BARISTA (Metal)	PM.278	NO	6,0 mm	NO	NO
ASCASO BAR / BARISTA	V.6161	V.6163	6,5 mm	V.8029	V.2689
ASTORIA	V.6145	V.2673	5,0 mm	V.3228	V.2690
ASTORIA (Plus 4 you / Gloria)	V.7990	V.3219	6,5 mm	V.3230	NO
BEZZERA	V.6145	V.2676	5,0 mm	V.3228	NO
BFC	V.6161	V.6163	6,5 mm	V.8029	V.2689
BIANCHI	V.6161	V.6163	6,5 mm	V.8029	V.2689
BRASILIA B61	V.8030	NO	6,5 mm	V.8029	NO
BRASILIA BE	V.6145	V.2676	5,0 mm	V.3228	NO
BRUGNETTI	V.6144	V.2684	6,5 mm	V.8029	NO
CASADIO	V.6144	V.2684	6,5mm	V.8029	NO
CARIMALI	V.3218	NO	-	V.8029	NO
CIMBALI	V.6147	V.2678	8,0 mm	V.3228	V.2690
CONTI	V.8031	V.2681	-	NO	NO
DALLA CORTE	V.3381	NO	8,0 mm	NO	NO
ELEKTRA	V.6146	V.2677	6,0 mm	NO	V.2690
EXPOBAR	V.6161	V.6163	6,5 mm	V.8029	V.2689
FAEMA	V.6144	V.2684	6,5 mm	V.8029	V.2689
FUTURMAT	V.6144	V.2684	6,5 mm	V.8029	V.2689
GAGGIA ITALIA	V.7992	V.2686	6,5 mm	NO	NO
GRIMAC	V.6161	V.6163	6,5 mm	V.8029	V.2689
LA SCALA	V.6161	V.6163	6,5 mm	V.8029	NO
MAGISTER	V.6146	V.2677	6,0 mm	V.3228	V.2690
MARZOCCO	V.3218	NO	6,5 mm	V.8029	NO
RANCILIO	V.6146	V.2677	6,0 mm	V.3228	V.2690
ROYAL	V.6161	V.6163	6,5 mm	V.8029	V.2689
SAECO	V.7992	NO	6,5 mm	NO	NO
SAN MARCO	V.6019	NO	8,0 mm	V.8039	V.2691
SAN MARCO (Leva / Lever)	V.7988	NO	-	V.3231	NO
SAN REMO	V.6161	V.6163	6,5 mm	V.8029	V.2689
SIMONELLI	V.6022	V.2687	7,0 mm	V.3228	V.2690
SPAZIALE	V.6020	NO	8,4 mm	V.8040	V.2692
SV ITALIA	V.6161	V.6163	6,5 mm	V.8029	V.2689
VIBIEMME	V.6161	V.6163	6,5 mm	V.8029	V.2689
WEGA	V.6161	V.6163	6,5 mm	V.8029	V.2689
WEGA (Concept)	V.7990	V.3219	6,5 mm	V.3230	NO

Portafiltros / Filterholders

Portafiltros para cápsulas FAP (súper crema)
Capsule filterholders FAP (super creamy)



Adaptador portafiltros
cápsulas
Capsule filterholder adapter

ADAPTABLE SUITABLE	SIMPLE	DOBLE	ALETAS FINS	SIMPLE	DOBLE
	CÓDIGO CODE	CÓDIGO CODE		CÓDIGO CODE	CÓDIGO CODE
ASCASO BAR / BARISTA (Metal)	PM.278	NO	6,0 mm	NO	NO
ASCASO BAR / BARISTA	V.3026	V.3203	6,5 mm	V.3224	V.3227
ASTORIA	V.2896	NO	5,0 mm	V.3223	V.3229
ASTORIA (Plus 4 you / Gloria)	V.2897	NO	6,5 mm	V.3222	NO
BEZZERA	V.2899	NO	5,0 mm	V.3223	V.3229
BFC	V.3026	V.3203	6,5 mm	V.3224	V.3227
BIANCHI	V.3026	V.3203	6,5 mm	V.3224	V.3227
BRASILIA B61	V.2898	V.3027	6,5 mm	V.3224	V.3227
BRASILIA BE	V.2899	NO	5,0 mm	V.3223	V.3229
BRUGNETTI	V.2898	V.3027	6,5 mm	V.3224	V.3227
CASADIO	V.2898	V.3027	6,5 mm	NO	NO
CARIMALI	V.2900	NO	-	NO	NO
CIMBALI	V.2901	V.3197	8,0 mm	V.3223	V.3229
CONTI	V.2902	NO	-	NO	NO
DALLA CORTE	V.3220	NO	8,0 mm	V.3225	NO
ELEKTRA	V.2907	V.3200	6,0 mm	NO	NO
EXPOBAR	V.3026	V.3203	6,5 mm	V.3224	V.3227
FAEMA	V.2898	V.3027	6,5 mm	V.3224	V.3227
FUTURMAT	V.2898	V.3027	6,5 mm	V.3224	V.3227
GAGGIA	V.2903	NO	6,5 mm	NO	NO
GRIMAC	V.3026	V.3203	6,5 mm	V.3224	V.3227
LA SCALA	V.3026	V.3203	6,5 mm	V.3224	V.3227
MAGISTER	V.2907	V.3200	6,0 mm	V.3223	V.3229
MARZOCCO	V.2904	V.3198	6,5 mm	V.3223	V.3229
RANCILIO	V.2907	V.3200	6,0 mm	V.3223	V.3229
ROYAL	V.3026	V.3203	6,5 mm	V.3224	V.3227
SAECO	V.2903	NO	6,5 mm	NO	NO
SAN MARCO	V.2908	V.3201	8,0 mm	V.3225	NO
SAN MARCO (Leva / Lever)	V.2911	NO	-	V.3232	NO
SAN REMO	V.3026	V.3203	6,5 mm	V.3224	V.3227
SIMONELLI	V.2905	V.3199	7,0 mm	V.3223	V.3229
SPAZIALE	V.2912	V.3202	8,4 mm	V.3226	NO
SV ITALIA	V.3026	V.3203	6,5 mm	V.3224	V.3227
VIBIEMME	V.3026	V.3203	6,5 mm	V.3224	V.3227
WEGA	V.3026	V.3203	6,5 mm	V.3224	V.3227
WEGA (Concept)	V.2897	NO	6,5 mm	V.3222	NO

Portafiltros / Filterholders

Portafiltros cápsula Lavazza Blue Capsule filterholders Lavazza Blue



V.8555

Prensa perforadora cápsulas
Capsule perforator tamper

CÓDIGO CODE	ADAPTABLE / SUITABLE	ALETAS / FINS
V.8558	ASCASO	6,5 mm
V.8564	ASTORIA	5,0 mm
V.3205	BEZZERA	5,0 mm
V.8558	BFC	6,5 mm
V.8558	BIANCHI	6,5 mm
V.3205	BRASILIA BE	5,0 mm
V.3212	BRUGNETTI	6,5 mm
V.3207	CARIMALI	-
V.3206	CIMBALI	8,0 mm
V.3221	DALLA CORTE	-
V.3213	ELEKTRA	6,0 mm
V.8558	EXPOBAR	6,5 mm
V.3208	FAEMA	6,5 mm
V.3209	GAGGIA	6,5 mm
V.8558	GRIMAC	6,5 mm
V.8558	LA SCALA	6,5 mm
V.3213	MAGISTER	6,0 mm
V.3210	MARZOCCO	6,5 mm
V.3213	RANCILIO	6,0 mm
V.8558	ROYAL	6,5 mm
V.3209	SAECO	6,5 mm
V.3214	SAN MARCO	8,0 mm
V.3215	SAN MARCO SERIE 100	-
V.8558	SAN REMO	6,5 mm
V.3211	SIMONELLI	7,0 mm
V.3216	SPAZIALE	8,4 mm
V.8558	SV ITALIA	6,5 mm
V.8558	VIBIEMME	6,5 mm
V.8558	WEGA	6,5 mm

Portafiltros monodosis / Monodose filterholders



V.2431 (M12)

Mango plástico verde
Green plastic handle



CÓDIGO CODE	ADAPTABLE SUITABLE	ALETAS / FINS
AS.591	ASTORIA	5,0 mm
V.3701	ASTORIA GLORIA	6,5 mm
V.2169	BRUGNETTI	6,5 mm
V.8023	BEZZERA	5,0 mm
V.2169	BRASILIA B61	6,5 mm
V.8022	BRASILIA BE	5,0 mm
V.2168	CIMBALI	8,0 mm
V.2169	CONTI	6,5 mm
V.3702	DALLA CORTE	8,0 mm
EK.268	ELEKTRA NIVOLA	6,0 mm
V.2169	FAEMA	6,5 mm
V.2167	FUTURMAT	6,5 mm
V.2169	FUTURMAT E61	6,5 mm
V.2169	GAGGIA	6,5 mm
V.2170	GAGGIA ITALIA	-
V.2169	MAIRALI	6,5 mm
V.2169	MARZOCCO	6,5 mm
V.2171	NUOVA SIMONELLI	7,0 mm
V.2172	RANCILIO	6,0 mm
V.2173	SAN MARCO	8,0 mm
V.2174	SPAZIALE	8,4 mm
V.2175	VIBIEMME	6,5 mm
V.2176	WEGA	6,5 mm

Portafiltros / Filterholders

Portafiltros sin fondo / Bottomless filterholders



CÓDIGO CODE	ADAPTABLE SUITABLE	ALETAS FINS	CÓDIGO CODE	ADAPTABLE SUITABLE	ALETAS FINS
PM.279	ASCASO BAR / BARISTA	6,4 mm	V.2158	FAEMA	7,2 mm
PM..98	ASCASO HOME (DREAM-ARC-BASIC)	6,0 mm	V.3698	FAEMA (inclinado)	7,0 mm
V.2155	ASTORIA / CMA	6,0 mm	V.2158	FUTURMAT	7,2 mm
V.2158	AURORA	7,2 mm	V.3698	FUTURMAT (inclinado)	7,0 mm
V.3698	AURORA (inclinado)	7,0 mm	V.3539	GAGGIA (19 g)	6,6 mm
V.2877	ASTORIA (PLUS 4 YOU / GLORIA)	6,5 mm	V.2895	GAGGIA (21 g)	6,6 mm
V.3693	BEZZERA	5,5 mm	V.2004	GRIMAC	7,0 mm
V.2161	BFC	6,4 mm	V.7985	LA PAVONI	5,8 mm
V.2156	BRASILIA	5,5 mm	V.1133	LA PAVONI (Ø 52 mm PRE-MILLENIUM)	5,8 mm
V.2158	BRASILIA B61	7,2 mm	V.2751	LA SCALA	6,4 mm
V.3698	BRASILIA B61 (inclinado)	7,0 mm	V.3698	MARZOCCO	7,0 mm
V.2156	BRASILIA BE	6,4 mm	V.2159	RANCILIO	6,2 mm
V.3694	CARIMALI	6,0 mm	V.3700	SAN MARCO	7,0 mm
V.2158	CASADIO	7,2 mm	V.2751	SAN REMO	6,4 mm
V.2157	CIMBALI	5,5 mm	V.3699	SIMONELLI	7,0 mm
V.3696	CONTI	8,0 mm	SP.498	SPAZIALE	6,0 mm
V.7982	DALLA CORTE	9,0 mm	V.2161	SV ITALIA	6,4 mm
V.2158	ELEKTRA	7,2 mm	V.2160	VIBIEMME	6,2 mm
V.3698	ELEKTRA (inclinado)	7,0 mm	V.2161	WEGA	6,4 mm
V.3695	EXPOBAR	6,2 mm			

Accesorio portafiltro Coffee Catcha Coffee Catcha filterholder accessory



V.8054

Este anillo de metal está diseñado para ser puesto en la parte superior de su portafiltro cada vez que se dosifica desde el molino.

- Ahorro del 8% de café en cada dosificación.
- Sirviendo 250 cafés por semana su ahorro será aprox. de 1800 € anuales.

This metal ring is designed to be put on top of your portafilter every time you dose from your grinder.

- Save on average 8% of coffee every time you dose.
- Serving 250 coffees in a week their savings will be approx. € 1800 per year.

Junta portafiltro cápsula / Capsule filterholder gasket



V.8055

Junta portafiltro silicona roja
Red silicone gasket filterholder
50x36x2 mm

Portafiltros / Filterholders

Portafiltros medidores de presión / Pressure gauge filterholders

Portafiltros + manómetro
Filterholders + manometer



CÓDIGO CODE	ADAPTABLE SUITABLE
V.7977	ASTORIA (PLUS 4 YOU)
V.6418	ASTORIA / BEZZERA / BRASILIA
V.6417	ARIETE / AURORA / BRUGNETTI / CONTI / FAEMA (modelos antiguos old models)/ FUTURMAT
V.6420	CARIMALI
V.6419	CIMBALI
V.6426	FAEMA (modelos nuevos new models) / LA SCALA / MARZOCCO / RANCILIO / SAN REMO / SV ITALIA / VBM / WEGA
V.6421	GAGGIA ITALIA
V.6422	NUOVA SIMONELLI
V.6423	PAVONI
V.6424	SAN MARCO
V.6425	SPAZIALE
V.7693	Manómetro Manometer 20 bar / Ø 80 mm / 1/8"

Portafiltros + manómetro + adaptador termómetro
Filterholders + manometer + thermometer adapter



CÓDIGO CODE	ADAPTABLE SUITABLE
V.7885	ASTORIA / BEZZERA / BRASILIA
V.7995	ASTORIA (PLUS 4 YOU)
V.7994	ARIETE / AURORA / BRASILIA B61 / BRUGNETTI / CONTI / FAEMA (modelos antiguos / old models) / FUTURMAT
V.7890	CARIMALI
V.7887	CIMBALI
V.7996	DALLA CORTE
V.7886	FAEMA (modelos nuevos / new models) / LA SCALA / MARZOCCO / SAN REMO / SV ITALIA / VBM / WEGA
V.7891	GAGGIA ITALIA
V.7997	RANCILIO
V.7889	SAN MARCO
V.7888	SIMONELLI
V.7892	SPAZIALE
V.7693	Manómetro Manometer 20 bar / Ø 80 mm / 1/8"

Portafiltros + manómetro + adaptador termómetro + termómetro
Filterholders + manometer + thermometer adapter + thermometer



CÓDIGO CODE	ADAPTABLE SUITABLE
V.6135	ASTORIA / BEZZERA / BRASILIA
V.7978	ASTORIA (PLUS 4 YOU)
V.6134	ARIETE / AURORA / BRASILIA B61 / BRUGNETTI / CONTI / FAEMA (modelos antiguos old models) / FUTURMAT
V.6137	CARIMALI
V.6136	CIMBALI
V.7979	DALLA CORTE
V.6142	FAEMA (modelos nuevos new models) / LA SCALA / MARZOCCO / SAN REMO / SV ITALIA / VBM / WEGA
V.6138	GAGGIA ITALIA
V.7980	RANCILIO
V.6140	SAN MARCO
V.6139	SIMONELLI
V.6141	SPAZIALE
VF.450	Termómetro Thermometer -50/300° C / Ø 3,5x100 mm
V.7693	Manómetro Manometer 20 bar Ø / 80 mm / 1/8"

Portafiltros / Filterholders

Portafiltros con termomanómetro
Filterholders with thermomanometer



CÓDIGO CODE	ADAPTABLE SUITABLE	ALETAS FINS
V.3369	ASCASO	6,5 mm
V.3235	ASTORIA	5,0 mm
V.3234	ASTORIA (PLUS 4 YOU / GLORIA)	6,5 mm
V.3235	BEZZERA	5,0 mm
V.3233	BFC	6,5 mm
V.3233	BRASILIA B61	6,5 mm
V.3235	BRASILIA BE	5,0 mm
V.3237	CARIMALI	-
V.3236	CIMBALI	6,5 mm
V.3233	ELEKTRA	6,5 mm
V.3233	EXPOBAR	6,5 mm
V.3233	FAEMA	6,5 mm
V.3233	FUTURMAT	6,5 mm
V.3238	GAGGIA	6,5 mm
V.3245	MARZOCCO	6,5 mm
V.3233	RANCILIO	6,5 mm
V.3240	SAN MARCO	6,5 mm
V.3233	SAN REMO	6,5 mm
V.3239	SIMONELLI	7,0 mm
V.3244	SPAZIALE	8,4 mm
V.3233	VIBIEMME	6,5 mm
V.3233	WEGA	6,5 mm
V.3234	WEGA (CONCEPT)	6,5 mm

Kits universales / Universal Kits



V.3689

Kit comprobador presión regulable 3/8"
Kit adjustable pressure check 3/8"



V.512

Kit comprobador presión 3/8"
Kit pressure check 3/8"



V.203

Manómetro 25 K Ø 42 mm
Manometer 25 K Ø 42 mm



W.287

Grifo 3/8"
Tap 3/8"



V.418

Rácor comprobador 3/8"
Checking fitting 3/8"

Mangos portafiltro estándar Standard filterholder handles



V.1041 (M10)
V.1043 (M12)
Mango madera arce
Maple wood handle



V.1045 (M10)
V.1046 (M12)
Mango madera nogal
Walnut wood handle



V.1075 (M10)
V.1076 (M12)
Mango madera olivo
Olive wood handle



V.1119 (M10)
V.1121 (M12)
Mango madera arce
Maple wood handle



V.2062 (M10)
V.2153 (M12)
Mango madera nogal
Walnut wood handle



V.1123 (M10)
V.1125 (M12)
Mango madera olivo
Olive wood handle



V.8563 (M10)
V.3193 (M12)
Mango madera nogal
Walnut wood handle



V..959 (M12)
Mango goma negra
Black rubber handle



V.2220 (M10)
V.2429 (M12)
Mango plástico rojo
Red plastic handle



V.1843 (M10)
W..562 (M12)
Mango plástico negro
Black plastic handle



V.3562 (M10)
V.3561 (M12)
Mango plástico negro
Black plastic handle

Tapones mangos / Caps for handles



CSV.48
Tapón negro mango
Handle black cap
19,8x18x9 mm



V.3195
Tapón cromado mango
Handle chromed cap
19,8x18x9 mm

Mandos vapor - agua estándar Standard steam - water knobs

Mando vapor madera nogal
Walnut steam knob



V.3366

Mango grupo madera nogal
Walnut wood group handle



V.3367 (M8)
V.3368 (M10)

Mando grifo madera nogal / Walnut tap knob



V.1380
Sin tapón / Without cap



V.1381
Agua / Water



V.1382
Vapor / Steam



V.1383
Tapón liso / Smooth cap



V.1384
Sin tapón / Without cap
Paso rápido / Quick step
6mm



V.1385
Agua / Water
Paso rápido / Quick step
6mm



V.1386
Vapor / Steam
Paso rápido / Quick step
6mm



V.1387
Tapón liso / Smooth cap
Paso rápido / Quick step
6mm

Cajones marro / Knockbox

Madera + inox / Wood + stainless steel

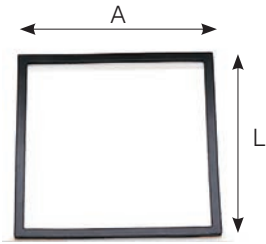

V..703 (AxL) 165x172 mm
V.1414 (AxL) 263x323 mm
 Junta apoyo / Gasket



V..702 Ø 31 / L 135 mm
V.1413 Ø 31 / L 235 mm
 Mango goma cubeta
 Rubber box handle

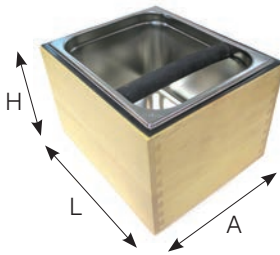

V..954 (AxLxH) 180x190x110 mm
V.1417 (AxLxH) 285x345x220 mm
 Cajón completo / Complete box



V..700 (AxLxH) 180x190x110 mm
V.1415 (AxLxH) 285x345x220 mm
 Base cuadrada madera
 Square wooden base



V..701 (AxLxH) 165x172x110 mm
V.1416 (AxLxH) 263x323x220 mm
 Cubeta inox/ Stainless steel box

Madera + plástico / Wood + plastic



V.6378 115x115x130 mm
 Negro / Black



V.6379 115x115x130 mm
 Marrón oscuro / Dark brown



V.6384 115x115x130 mm

Aluminio + plástico
 Aluminium + plastic



Plástico / Plastic



V.6381 Ø 120x100 mm
 Negro / Black



V.6382 Ø 120x100 mm
 Gris / Gray



V.6383 Ø 120x100 mm
 Rojo / Red

Cajones marro / Knockbox

Inox / Stainless steel



V.821
Ø 195x185 mm



V.822
Goma Barra (V.821)
Rod rubber (V.821)
Ø 31, L 180mm



V.7482
Ø 167x105mm



V.3320
Junta + barra (V.7482)
Joint + rod (V.7482)

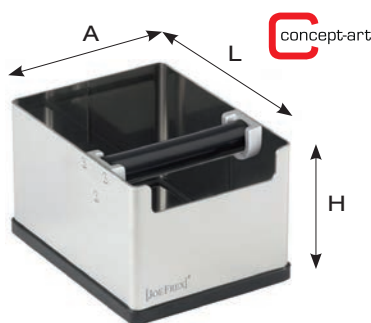

V.6385
(AxLxH) 140x185x120 mm



V.6386
(AxLxH) 160x220x110 mm



V.7808
Ø 110x145 mm



V.7483
Ø 150x150 mm



V.6387
(AxL) 145x145x60 mm
De encaje / To fit



V.6388
(AxL) 304x196x80 mm
De encaje / To fit

Polipropileno / Polypropylene



V.1008
230x228x870 mm



V.1009
Incluye toalla con gancho
Includes towel with hook
230x228x870 mm



Cajones marro / Knockbox

Inox / Stainless steel

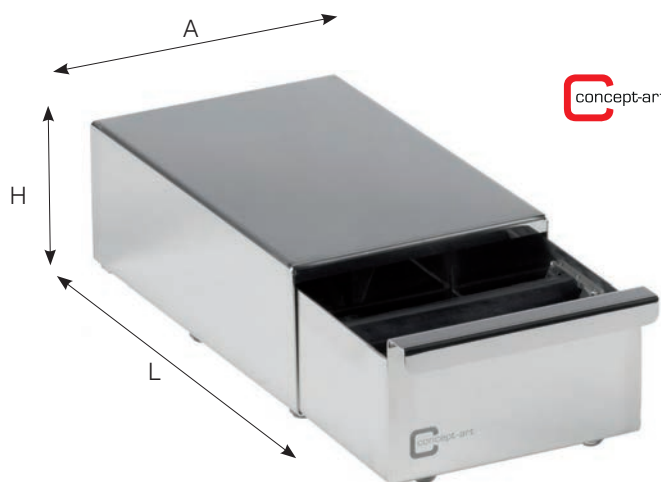

V.6389
(AxLxH) 130x220x80 mm



V.6390
(AxLxH) 195x270x90 mm



V.6391
(AxLxH) 270x300x90 mm



V.6392
(AxLxH) 250x375x85 mm



V.1885
(AxLxH) 372x437x158 mm



Recambio barra picamarro /
Replacement knock rod

V.6394

Ø 30 mm / L 240mm

V.6980

Ø 32 mm / L 240mm

Cajones marro / Knockbox

Inox / Stainless steel

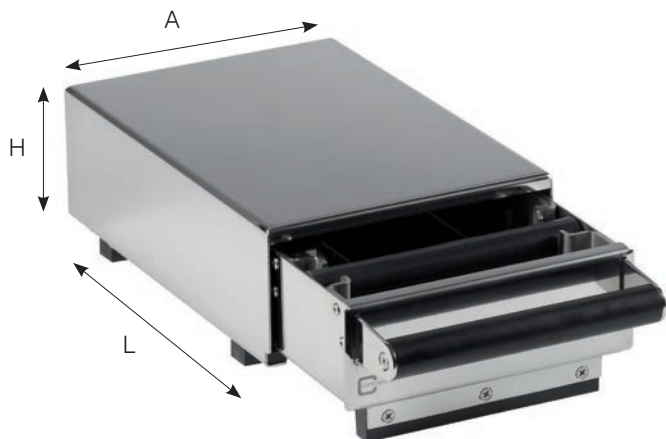

V.8008
(AxLxH) 235x305x105 mm



V.8007
(AxLxH) 280x370x105 mm



V.8006
(AxLxH) 320x450x105 mm



V.8005
(AxLxH) 365x305x105 mm

Aros desbroce / Clearing rings



VF1292
Tapa desbroce Inox
Stainless steel clearing top
Ø 245 mm



CÓDIGO CODE	MATERIAL / MATERIAL	Ø EXTERNO Ø EXTERNAL	Ø AGUJERO ENCASTRE Ø TABLE HOLE
VF1284	Caucho baja densidad negro Black low density rubber	232 mm	195 mm
VF1286	Caucho alta densidad negro Black high density rubber	232 mm	195 mm
VF1288	Silicona negra / Black silicone	232 mm	195 mm
VF1290	Caucho baja densidad negra Black low density rubber	282 mm	235 mm

Cajones marro mueble cafetero Knockbox coffee cupboard



V.3322

Fondo cerrado / Closed bottom

V.3323

Fondo abierto / Open bottom

Medidas agujero mueble

Desk hole measures

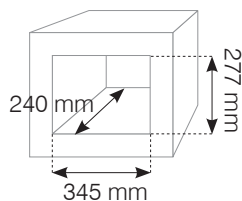

V.3378

Fondo cerrado / Closed bottom

V.3379

Fondo abierto / Open bottom

Medidas agujero mueble

Desk hole measures

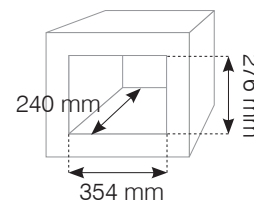

V.3321

Medidas agujero mueble

Desk hole measures

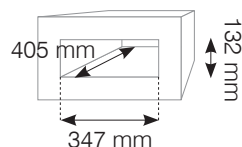

V.3324

Ø 40, L 320 mm

(V.3322 / V.3323 / V.3321 / V.3378 / V.3379)

Barras picamarro estándar / Standard knock rods



CÓDIGO / CODE	Ø mm	L mm
V.7727	35	300
V.7728	35	325
V.7729	35	350
VF..58	35	450
V.6980	32	240
V.6394	30	240
V.3324	40	320
VF..67	37	1000

Limpiador eléctrico Pro-fondi Pro-fondi Electric cleaner



V.3247

Alimentación / Power supply:
In (110/240V - 50/60 Hz)
Out (12 VCC)
Impulsor / Impeller: Ø 53/57/58



V.3248

Ø 53 mm

V.3249

Ø 57/58 mm



V.3250

Ø 53/57/58 mm



Video utilización Pro-fondi
Pro-fondi utilization video

Instalación / Installation

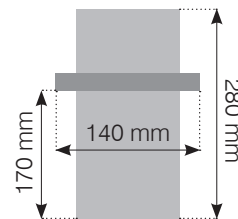
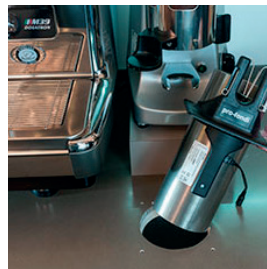
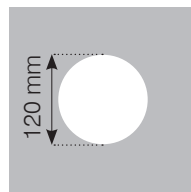

Ventajas / Advantage

- Mayor limpieza mejorando el café obtenido / More cleaning to get better coffee.
- Mantiene la mesa limpia recogiendo la totalidad del pozo de café en el saco de forma higiénica / Preserves the table clean collecting all coffee ground.
- Sin necesidad de limpieza o mantenimiento particulares / No cleaning or maintenance required.
- Evita ruidos con su mecanismo silencioso / Silent mechanism.
- Sistema rápido y eficaz evitando dolores de brazo y espalda / Quick and effective system prevents arm and back pains.
- Protege los filtros y evita la abrasión de los grupos / Protects the filters and prevents abrasion of groups.

Duchas / Showers

Competition Series

Astoria - Bezzera - BFC - Brasilia - Carimali - Casadio - Cimballi - ECM - Elektra - Faema - Fiorenzato - Fracino - Grimac - Reneka - Royal - Sab Italia - San Remo - Scala - Victoria Arduino - Wega

Ascaso - Azkoyen - Bezzera - BFC - Bianchi - Brasilia - Casadio - ECM - Expobar - Faema - Faimac - Fiamma Rst - Fiorenzato - Grimac - Iberital - Italcrem - Kees van der Westen - La Nuova Era - Orchestrale - Promac - Quality Espresso - Reneka - Rocket - Royal - Sab Italia - San Remo - Scala - Slayer - SV Italia - VFA Express - Vibiemme - Victoria Arduino - Wega - **E61 Groups**

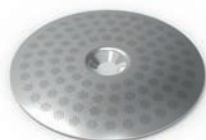

V.1228

Membrana integrada de 200 μ m
Integrated membrane 200 μ m



V.1230

Membrana integrada de 200 μ m
Integrated membrane 200 μ m

Carimali - Marzocco - Slayer - Synesso

Brugnetti Aurora - Simonelli - Victoria Arduino

Bezzera - Magister - Pavoni - Promac - Rancilio

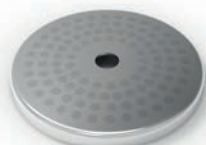

V.1231

Membrana integrada de 200 μ m
Integrated membrane 200 μ m



V.1232

Membrana integrada de 200 μ m
Integrated membrane 200 μ m

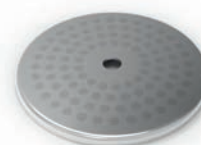

V.1233

Membrana integrada de 200 μ m
Integrated membrane 200 μ m

Astoria- Plus4You - San Marco Leva - Wega Concept

Dalla Corte - Spaziale



V.1234

Membrana integrada de 200 μ m
Integrated membrane 200 μ m



V.1236

Membrana tejida de 200 μ m
Woven membrane 200 μ m



V.1237 (Doble/Double)

Membrana integrada de 200 μ m
Integrated membrane 200 μ m

CÓDIGO CODE	Ø TOTAL Ø TOTAL	μ m	Ø AGUJERO CENTRAL Ø CENTRAL HOLE	ALTO HEIGHT	Nº AGUJEROS Nº HOLES	Ø AGUJEROS Ø HOLES
V.1228	51,5	200	5mm	-	98	3mm
V.1230	60	200	-	17mm	98	3mm
V.1231	56,4	200	7mm	5mm	98	3mm
V.1232	56,5	200	6mm	3,2mm	98	3mm
V.1233	57	200	5,5mm	2,8mm	98	3mm
V.1234	48	200	5mm	-	81	3mm
V.1236	48,4	200	5mm	-	81	3mm
V.1237	48,4	200	10mm	3,8mm	81	3mm

Filtros / Filters

Ascaso - Astoria - Bezzera - BFC - Bianchi - Brasilia - Casadio - Conti - ECM - Elektra - Expobar - Faema - Fiorenzato - Fracino - Futurmat - Grimac- Iberital - Kees van der Westen - Magister - Marzocco - Nuova Era - Orchestrale - Pavoni - Promac - Quality Espresso - Rancilio - Rocket - Royal - Sab Italia - San Remo - Scala - Simonelli - Slayer - SV Italia - Synesso - VFA Express - Vibiemme - Victoria Arduino - Wega - **E61 Groups**



V.1217 (1 taza / cup)



V.1218 (2 tazas / cups)



V.1219 (2 tazas / cups)

Dalla Corte - Gruppo Izzo - San Marco



V.1221 (1 taza / cup)



V.1223 (2 tazas / cups)



V.1224 (3 tazas / cups)

Astoria Plus4You - Spaziale - Wega Concept

E61 Groups



V.1225 (1 taza / cup)



V.1226 (2 tazas / cups)



V.1227 (3 tazas / cups)



V.1220 (2 tazas / cups)

Carimali - Cimbali - Gaggia - Reneka

Sanremo Opera - **E61 Groups**



V.1213 (1 taza / cup)



V.1214 (2 tazas / cups)



V.1210



V.1211

CÓDIGO CODE	CAFÉS COFFEES	CAPACIDAD CAPACITY	Ø TOTAL	Ø PRENSA Ø PRESS	Ø ÁREA PERFORADA Ø PERFORATED AREA	ALTO HEIGHT	Nº AGUJEROS Nº HOLES	Ø AGUJEROS Ø HOLES
V.1210	2	12/18g	70mm	58mm	49mm	24mm	715	0,30mm
V.1211	2	16/20g	70mm	58mm	49mm	26mm	715	0,30mm
V.1213	1	6/9 g	68mm	58mm	30mm	24,5mm	253	0,30mm
V.1214	2	12/18 g	68mm	58mm	44mm	24,5mm	641	0,30mm
V.1217	1	7/9 g	70mm	58mm	30mm	26,5mm	253	0,30mm
V.1218	2	12/18 g	70mm	58mm	44mm	24,5mm	641	0,30mm
V.1219	2	16/20 g	70mm	58mm	44mm	26,5mm	641	0,30mm
V.1220	2	18/22 g	70mm	58mm	49mm	28,5mm	715	0,30mm
V.1221	1	6/9 g	66mm	58mm	30mm	24,5mm	293	0,3mm
V.1223	2	14/18 g	66mm	58mm	44mm	26mm	641	0,3mm
V.1224	3	18/20 g	66mm	54mm	44mm	32mm	641	0,3mm
V.1225	1	7 g	65mm	53mm	30mm	25mm	253	0,3mm
V.1226	2	14 g	65mm	53mm	44mm	27,5mm	641	0,3mm
V.1227	3	18 g	65mm	53mm	44mm	32mm	641	0,3mm

Duchas y filtros teflonados / Teflon showers and filters

Astoria - Bezzera - Brasilia - Faema -
Fiorenzato - Rancilio - **A Leva**



V.1235

Astoria - Brasilia - Cimbali - E91 - Faema
- San Remo



V.1239

BFC Royal - Expobar - Faema - SV Italia
- Vibiemme - Wega



V.1238

Aurora - Marzocco



V.1240

Simonelli



V.1241

Spaziale



V.1242

Astoria - Bezzera - BFC Royal - Brasilia - Elektra - Faema - Rancilio - San Remo - SV Italia - Vibiemme - Wega



V.1208
(1 taza / cup)



V.1209
(2 tazas / cups)

Juntas portafiltros larga duración / Filterholder gaskets long life



F.3959
Exterior / Outside: Ø 73,5mm
Interior / Inside: Ø 57,5mm
Alto / High: 8mm



F.3960
Exterior / Outside: Ø 73,5mm
Interior / Inside: Ø 57,5mm
Alto / High: 9mm

Fresas planas / Flat burrs



Molino Grinder	Código Code	Ø Exterior Ø Out	Ø Interior Ø Inner	Grosor Thickness	Taladros Holes	Giro Turn	Modelos Models
ANFIM	MW3235	50	30	7,5	3	SX	KS
	MW3104	50	30	8,5	3	SX	HAUS / HAUS SELF
	MC...1	54	32	8	3	SX	BEST / SÚPER BEST
	MW..10	64	37,5	9	3	SX	CAIMANO / LUSO / DROGUERIA
	MC...2	75	43	9	3	SX	"SUPER LUSO / SP / CAIMANO SPECIAL 450 TIMER / DROGUERIA COFFEE SHOP / SPECIAL 450 / SUPER CAIMANO / SUPER LUSO"
ARISTARCO	MC...3	54	22	8	3	DX	
	MC..55	58	35	8	3	DX	
	MC..65	64	38	8,5	3	DX	EMA 75 / EMA 80 / SE-N
	MC.141	74	42	9,5	3	DX	EMA 80
	MC.142	85	44	9	3	DX	EMA 80
ASCASO	MC..25	49	30	7,5	3	DX	I1 -2006
	MI..69	53,5	30,5	8	3	DX	I1 +2006
ASTORIA	AS.612	64	38	9	3	DX	SARA
AURORA	MC.133	64	38	9	3	SX	
AZKOYEN	MC.126	64	37	9	3	SX	M01 / M02
BRASILIA	MC...9	50	31	8,5	3	SX	BFD
	MC..68	63	37	9	3	SX	CY / VIP
	MC..78	83	45	10	3	SX	CENTURY
BREGANT	MC..41	50	31	8	3	SX	JUNIOR / ROMA ELECTRONIC
	OB.119	63	36,5	8,5	3	SX	ZERO
	MC..21	64	38	9	3	SX	EB / DSQ / NR900 / NR1400
	OB.121	64	38	9	3	SX	EB / MITO
	MC.158	75	44	9	3	SX	GLOBO / MITO / MITOMAXI
CARIMALI	MC..29	75	43	9	3	SX	
CASADIO ISA	MC.137	53	30	8,5	3	SX	
	MC..27	64	34,5	10	2	SX	MOKABIX
	MC..28	84	45	10,5	3	SX	G84 / MOKABIX
CEADO	MC.166	64	48	12	3	DX	E-37
CIAT	MC.159	108	38	11	3	DX	
	MC.160	108	38	13	3	DX	
	MC.161	123	45	12	3	DX	
CIMBALI DRM	MC.116	54	32	9	3	DX	
	MC.117	64	37	9	3	DX	ALINOX / CADET / JUNIOR
	MC.139	68	43	7,5	3	DX	ALINOX A
COMPAK	K.2054	54	32	8,5	3	DX	K3 / K3 PUSH / K3 TOUCH / K3 SHOP
	K2858C	58	33,3	8,5	3	DX	E5 ESSENTIAL
	K.2058	58,5	33	8,5	3	DX	K3 ELITE
	K..246	60	36	8	3	DX	K5
	K6699C	63,5	38	9	3	DX	E6
	K6899C	63,5	38	9	3	DX	E6 (RED SPEED)
	K...99	64	38	9	3	DX	K6
	K..218	64	38	9	3	DX	K6 (TITANIO)
	K.4080	80	40,5	10	2	SX	R80
K..247	80	41	10	3	DX	K8	

Fresas planas / Flat burrs



Molino Grinder	Código Code	Ø Exterior Ø Out	Ø Interior Ø Inner	Grosor Thickness	Taladros Holes	Giro Turn	Modelos Models
COMPAK	K..245	80	41	10	3	DX	K8 (TITANIUM)
	K4080C	80	41	10	3	SX	R80
	K..812	82,5	48,5	9	3	DX	K8 SILENZIO / A8
	K3812C	83	49	9,5	3	DX	E8 / F8
	K1483C	83	49	9,5	3	DX	E8 / F8 (RED SPEED)
	K.4100	100	45,5	10	3	SX	R100 (ANTIGUO)
	K4100C	100	46	10	3	SX	R100 (+07/2017)
	K.4120	120	62	10	3	SX	R120 (ANTIGUO)
	K4120C	120	62	10	3	SX	R120 (+07/2017)
	K.4140	140	70,5	10	3	SX	R140 (ANTIGUO)
K4140C	140	71	10	3	SX	R140 (+07/2017)	
CUNILL	MG..20	53	30	8,5	3	SX	
	MG..22	53	11/33	6,3	3/0	SX	
	MG..19	59	30/33	9,5	3	SX	
	MG..21	59	30/33	9,5	3/0	SX	BRASIL / CAFÉ TRANQUILO / COLOMBIA / ETIOPIA / FULL METAL / JAMAICA / MARFIL / MEXICO / MICHIGAN INOX -2009 / RUMBA / SPACE / TAURO / UGANDA (ESTÁNDAR / STANDARD)
	MG.800	59	30/33	9,5	3/0	SX	BRASIL / CAFÉ TRANQUILO / COLOMBIA / ETIOPIA / FULL METAL / JAMAICA / MARFIL / MEXICO / MICHIGAN INOX -2009 / RUMBA / SPACE / TAURO / UGANDA (ORIGINAL)
	MG.813	59	30/34	9	3/0	SX	JAMAICA / JAMAICA TRON / KENIA / KENIA TRON / LUXO 400W / TRANQUILO TRON
	MG..38	59	30/36	7,5	3/0	SX	BRASIL / CAFÉ TRANQUILO / COLOMBIA / ETIOPIA / FULL METAL / JAMAICA / MARFIL / MEXICO
	MG.561	64	29,5/34	8,5	3/0	DX	COSTA RICA / HAWAI / MICHIGAN / MOVIE / MOVIE BIMOTOR / NOBEL BIMOTOR / SALSA / TANGO
MG..18	64	34	10	2	SX		
MC..80	65	20/35	8,5	3	SX	COSTA RICA / HAWAI / MICHIGAN / MOVIE / MOVIE BIMOTOR / NOBEL BIMOTOR / SALSA / TANGO	
D.R.M	MC..32	68	43	7,5	3	DX	ALINOX A
DITTING	DITT.1	80	40	9	4	SX	
	DITT.2	90	45	9	4	SX	
	DITT.3	100	50	9	4	SX	
	DITT.4	120	60	9	4	SX	
	DITT.5	140	70	9	4	SX	
DOGE	DG..71	62,5	37,5	9	3	DX	DOGE 63 / SUBITO
	MC..11	63	38	9	3	DX	T-80A / T80E / T80D
	MC..12	83	45	9	3	DX	T-48A
	DG..18	83	45	10	3	SX	DOGE 83
EUREKA	MEK.11	50	29,5	8,5	3	DX	MDM / MDMCA / MDME / MDMEA
	MC.150	60	38	9	3	DX	MDMEA / MONDIAL MDME
	MEK.75	63,5	37,5	8,5	3	DX	MCF
	MC.131	64	37,5	9	3	DX	LUSO MDLCA65 / LUSO MDLCA75 / MDLCA / MDMCA / MONDIAL MDMC
	MC.133	64	38	9	3	SX	
	MC..54	74	37,5	9	3	DX	



Fresas planas / Flat burrs

Molino Grinder	Código Code	Ø Exterior Ø Out	Ø Interior Ø Inner	Grosor Thickness	Taladros Holes	Giro Turn	Modelos Models
EXPOBAR	MEX..8	64	37	8,5	3	DX	C-600
FAEMA	MC..25	49	30	7,5	3	DX	
	MF.506	54	31	8	3	DX	MPN
	MC..37	64	38	9	3	DX	SILVER
	MC.127	75	43	9	3	DX	MD-2000 / MD-3000
FIORENZATO	FI.213	58	33,4	8,5	3	DX	F4 NANO / F4E NANO
	FI.177	63,5	37	8	3	DX	F64E
	FI.178	64	37	8,5	3	DX	F5 / F6 (TITANIUM)
	FI.214	64	37	8,5	3	DX	F64EVO
	FI.355	64	37	8,5	3	DX	F64 EVO (RED SPEED)
	FI.359	64	37	8,5	3	DX	F64E (RED SPEED)
	FI..78	64	37	8	3	DX	F5 / F5D / F6
	FI..79	83	49	9	3	DX	F6 / F6D / F8
	FI.211	83	49	9	3	DX	F83E
	FI.342	83	49	9	3	DX	F83E (RED SPEED)
	FI.382	83	49	9	3	DX	F6 / F6GA
	FUTURMAT	MF.506	54	31	8	3	DX
MF.507		54	31	8	3	SX	FP
MG..21		59	30/33	9,5	3/0	SX	CT1 / CT2 / FUTUR / NEW FUTUR SM
MF.508		62	38	9	3	SX	FM
GAGGIA	MG..20	53	30	8,5	3	SX	
	MG..22	53	11/33	6,3	3/0	SX	
	MC..55	58	35	8	3	DX	
	MG..38	59	30/36	7,5	3/0	SX	
	MG..19	59	33/30	9,5	3	SX	
	MC..65	64	38	8,5	3	DX	
	MC.141	74	42,5	9	3	DX	
	MC..45	84	45	9	3	DX	
GAGGIA BABY	MC..14	50	30	7,5	3	DX	
GAGGIA MILANO	MC.142	85	44	9	3	DX	MD85
GAYC	MC..59	60	33	9,5	3	SX	
MACAP	MCP222	57,5	34	8,5	3	DX	M4 / M4A / M4T / M5 / M5A / M5T / MC4 / MC4A / MC4T / MC5 / MC5A / MC5T
	MCP100	65	38	8,5	3	DX	MC6 / MC7 (2004) / MX / MX900 / MX1400 / MXA / MXP / MXT
	MCP168	70	38	9	3	DX	M9 / M9A / M9P / M7T
	MCP232	73,5	42	9	3	DX	M7 (900)
	MCP113	74	42	9	3	DX	M7 / M7 (1400) / M7A / M7P / M7T / MC7 (2005)
MACDOBAR	MC.143	57	37	6	2	DX	
	MC..18	64	37	8,5	3	DX	
MAHLKÖNIG	MC.147	65	38	8,5	2	SX	K30
MARCFI	MC..76	59	30/33	8	3	DX	
MARKIBAR	MKB..2	64	37	8,5	3	SX	ASPE / QUIMBOA
MAZZER	MC.129	58	33	8,5	3	DX	MINI
	MC..52	63,5	37,5	9	3	DX	JUNIOR
	MAZ200	64	37	8	3	DX	MINI ELECTRONIC
	MC..18	64	37	8,5	3	DX	JOLLY (220V)
	MC.134	64	37	8,5	3	DX	JOLLY (380V)
	MC..19	83	49	9	3	DX	MAJOR (220V)
	MC.135	83	49	9	3	DX	MAJOR (380V)
	MAZ163	83	49	9,6	3	DX	MAJOR (220V)
	MAZ164	83	49	9,6	3	DX	MAJOR (380V)
	MAZ328	83	49	9,6	3	DX	MAJOR / MAJOR ELECTRONICO
	MAZ305	100	55	10	3	SX	DR100 (193S)
	MAZ306	100	55	10	3	SX	DR100 (194S)
	MAZ318	119	60	12	4	SX	ZAR
MAZ317	140	70,5	12	4	SX	ZAR	

Fresas planas / Flat burrs



Molino Grinder	Código Code	Ø Exterior Ø Out	Ø Interior Ø Inner	Grosor Thickness	Taladros Holes	Giro Turn	Modelos Models
MINERVA	MC.136	65	36	10	2	DX	
MINI MOKA	MC..81	39	25	5,5	3	SX	
	MC..25	49	30	7,5	3	DX	
ORTEGA	O..102	60	36	8	3	SX	
	O..101	60	30/36	8	3	SX	
PETRONCINI	MC.165	120	50	10	4	DX/SX	
PLANAS BOSCH	MC..64	61	31/36	8	2	DX	
	MC..62	66,5	26/27	9	3	DX	
QUALITY ESPRESSO	MC.145	64	37	8,5	3	SX	Q9 / XP
QUAMAR	MQ.165	63	38	9	3	DX	M80
	MQ..32	63	38	9,5	3	DX	M1 / M1E / M80 / M80D / M80E
	MQ.107	63	38	9,5	3	DX	M80E / T80 / T80-D
	MQ..40	75	43	10,5	3	DX	M1 / M1E
QUICK MILL	MC..38	54	30	8	3	DX	
	MC..40	66	35	9	3	SX	
QUICK MILL FAMILY	MC..25	49	30	7,5	3	DX	
QUICK MILL OMRE	MC..67	43	25	6,5	3	SX	
	MC..41	50	31	8	3	SX	ROCKY / JACKY / MD40
	MC..42	64	38	9	3	SX	MD50
RANCILIO	MC..43	75	43	10,5	3	SX	MD80
	RO6144	63	37,5	9	3	SX	BELLE EPOQUE / CC 45 / R80 / RR55 / RR65
ROSSI	MC..66	63	38	9	3	SX	RR45 A EDEL / RR45 A / RR45PST / RR45 S
SAECO	MC..67	43	25	7	3	SX	VIA VENEZIA
SAN MARCO	MC..65	64	38	8,5	3	DX	SM90 / SM90 OLD / SM90A / SM90A OLD / SM91 / SM92 / SM96
	MC..79	74	42	9,5	3	DX	
	MC..45	84	46	9	3	DX	SM91 / SM95 / SM95 OLD / SM95A / SM95A OLD / SM96 / SM97
SANTOS	MSA.92	63,5	35,5	9	3	SX	MD55
	MSA326	63,5	35,5	9		SX	MD60
	MC..56	64	38	9	3	SX	6 / 6A / MD40
SIMONELLI	MC..14	50	30	7,5	3	DX	GRINTA
	MC.131	64	37,5	9	3	DX	MASTER / MDL / MDLCA / MDX / MDXA
	MNS.28	74	37	9	3	DX	MYTHOS
	MNS.18	74	37	9	3	DX	MYTHOS (TITANIO)
	MC..54	74	37,5	9	3	DX	
VFA EXPRES	MC..42	64	38	8	3	SX	N-1464
	MC.133	64	38	9	3	SX	AE1464 / AE1464 NEW / N1464 / E1464 / N1464
	MFE..9	84	42	9	3	SX	AN-1084 / AN-0784



Fresas cónicas / Conic burrs

Molino Grinder	Código Code	Ø Exterior Ø Out	Ø Interior Ø Inner	Grosor Thickness	Taladros Holes	Giro Turn	Modelos Models
ASCASO	MC..74	38/29	20/7	17	0	DX	I2
BREGANT	MC..70	68/49	45/13	25	1/4	DX	MITOCONIC
	MC.148	68/49	41/13	25	4	DX	MITOCONIC
CASA	MC..74	38/29	20/7	17	0	DX	CHALLENGE
CASADIO	MC.148	68/49	41/13	25	4	DX	GC98
CASADIO ISA	MC..70	68/49	45/13	25	1/4	DX	GC98
CIMBALINO	MC..74	38/29	20/7	17	0	DX	MINI
COMPAK	K.3068	68/56	49/13	24	1/4	DX	K10
	K.3178	68/56	49/13	24	1/4	DX	K10 (RED SPEED)
DOGE	MC.151	71/49	41/13	25	3	DX	DOGE CONICO
ELEKTRA	MOE..8	68/49	45/33	25	4	DX	NINO
EROS	MC..35	68/49	41/13	25	2 CHAVETA	DX	
	MC.149	68/49	45/13	25	0	DX	
EUREKA	MC..70	68/49	45/13	25	1/4	DX	LUSSO MDLCA-C / OLYMPUS KR
FAEMA	MF.505	68/49	41/11	25	1/4	DX	MC90 / MC99
	MFI.52	68/49	45/33	25	4	SX	MC90
IBERITAL	MC..74	38/29	20/7	17	0	DX	CHALLENGE / MINI
	MCP188	63/40	33/13	23	3T	DX	MX-K, MX-K-A, MX-K-T
MACAP	MC.154	68/49	41/13	25	4	DX	M7-D, M7-K, M7-K-A, M7-K-T
	MCP228	68/49	41/13	25	4	DX	M7-D, M7-K, M7-K-A, M7-K-T
	MC.148	68/49	41/13	25	4	DX	M7-D, M7-K, M7-K-A, M7-K-T
	MC.155	63/40	40/12	23	3	DX	KONY / KONY ELECTRONIC
MAZZER	MC.156	67/44,5	44,5/14	23	3	DX	KONY
	MAZ232	71,49	41/14	25	3	DX	KOLD ELECTRONIC / ROBUR ELECTRONIC
	MAZ129	71/49	41/14	25	3	DX	KOLD / ROBUR (220V)
	MAZ128	83/59	50/14	25	3	DX	KOLD / ROBUR (380V)
ROSSI	MC..74	38/29	20/7	17	0	DX	FM / FM ST
	MC..70	68/49	45/13	25	1/4	DX	MC
	MC.148	68/49	41/13	25	4	DX	MC
SAECO	MC..74	38/29	20/7	17	0	DX	
	MC..75	48/32	20/10	20	0	DX	
	MC.146	48/32	31/21	20	0	SX	
SAN MARCO	MS.108	84/45	50/13	18/9	3	DX	SM91 / SM96 / SMFK / SMLK / SMMK
	MS.107	68/49	40/13	25	4	DX	SMFK / SMMK / SMTK
FIORENZATO	FI.212	71/49	42/13	25	3	DX	F71EK
	FI.345	71/49	42/13	25	3	DX	F71EK (RED SPEED)
COMPAK	K3078C	68/49	42/13	25	3	DX	E10 / F10
	K3178C	68/49	42/13	25	3	DX	E10 / F10 (RED SPEED)

Fresas vending / Vending burrs

Molino Grinder	Código Code	Ø Exterior Ø Out	Ø Interior Ø Inner	Grosor Thickness	Taladros Holes	Giro Turn
BIANCHI - FAEMA	MC...8	54	31	8	3	DX
DUCALE	MC..33	64	38	9	3	SX
I.D.E.A	MC..17	54	31	8	3	DX
RHEA VENDORS	MC..44	63,5	38	9	3	SX
SAECO	MC..67	43	25	7	3	SX
ZANUSSI NORBY	MC..72	63,5	38	9	3	DX

Tostador profesional digital Digital professional toaster



V.3505



V.3325

Cepillo enfriador granos de café
Coffee grains cooler brush

CARACTERÍSTICAS TÉCNICAS / TECHNICAL FEATURES

MEZCLADO / MIXING	Sistema de rotación excéntrica (Calor radiante) / Eccentric rotation system
CALENTAMIENTO / HEATING	Convección / Convection
ENFRIAMIENTO / COOLING	Soplado forzado a temperatura normal (aprox. 10 min) / Forced blowing
RANGO TEMPERATURA / TEMPERATURE RANGE	190-250 °C
CONTROL TEMPERATURA / TEMPERATURE CONTROL	0-250 °C mediante termostato electrónico / Electronic thermostat
POTENCIA / POWER	1000 W
FUENTE ALIMENTACIÓN / ENERGY SOURCE	CA 100 V-110/120/220/230/240 V-50/60 Hz
MATERIALES CÁMARA / CAMERA MATERIALS	Tubo de vidrio termorresistente (pyrex) / Heat-restisting glass tube (pyrex)
CAPACIDAD CÁMARA / CAMERA CAPACITY	300 g máx. 350 g
RUIDO / NOISE	65 dB
DIMENSIONES / SIZE	383x243x229 (490x243x229 con colector pieles) / with skin collector
COLOR / COLOUR	Negro / Black
PESO / WEIGHT	5,5 Kg

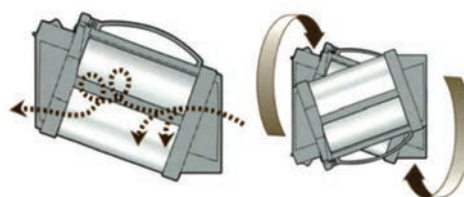

Fácil Uso. La cámara es desmontable. Introducir o sacar los granos de café o su limpieza es fácil.

Control de temperatura. La temperatura de tostado y tiempo es regulable. Ocho niveles de tostado.

Control de tiempo. Tiempo de tostado regulable.

Refrigeración rápida. Después del tostado los granos se enfrían rápidamente mejorando el resultado final.

Seguridad. Medida de seguridad por exceso de temperatura.

Tecnología 3D patentada. Los granos son perfectamente mezclados y tostados.

Control visual. Podemos ver el proceso de tostado.

Tecnología por aire caliente. Uniformidad y tostado completo del grano.

Cámara de tostado rápida.

Capacidad de 50 a 300g.

Baja rumorosidad. Se puede utilizar sin problemas en interiores (65 dB).

Easy-to-use. The camera is detachable. Introduce or take out the coffee beans, as well as its cleaning is easy.

Temperature control. Roasting temperature and time adjustable. Eight toasting levels.

Control of time. Adjustable toasting time.

Fast cooling. After the toasting, beans cool quickly improving the final result.

Security. Security measures for excessive temperatures.

Patented 3D technology. Beans are carefully blended and roasted.

Visual checking. We can see the roasting process.

Warm air technology. Uniformity and complete roast cycle.

Fast roasting camera. Capacity from 50 to 300g.

Low-noise running. Easy to use indoor (65 dB).



Tolva estándar / Standard hopper



Adaptadores tolva estándar V.6277 V.6277 standard hopper adapters



(Para / For V.6277)

CÓDIGO / CODE	ADAPTABLE / SUITABLE	Ø mm	
		INFERIOR / LOWER	SUPERIOR / UPPER
V.6278	MAZZER	57-60	47
V.6279	FAEMA	55	47
V.6280	FIORENZATO	68	47
V.6281	FAEMA SILVER/CIMBALI	54	47
V.6428	OBEL	65,5	47
V.6429	SAN MARCO	67	47
V.6430	GAGGIA	63	47
V.6431	ROSSI	51,5	47

Adaptadores tolva lata Can hopper adaptors



V.6283
Int. Ø 66 mm
Ext. Ø 50 mm



V.6284
Int. Ø 57 mm
Ext. Ø 50 mm



V.6285
Int. Ø 70 mm
Ext. Ø 65 mm



V.6289
Int. Ø 70 mm
Ext. Ø 50 mm



FI.328
Illy / Fiorenzato
Superior / Upper Ø 57 mm
Inferior / Lower Ø 57 mm



V.6288
Tornillo tolva lata
Can hopper screw



V.6286
Superior / Upper Ø 47 mm
Inferior / Lower Ø 51,5 mm



V.6282
Pasador tolva lata
Can hopper hatch
74x46 mm



Jarras y filtros Queen · Animo · Bonamat Queen · Animo · Bonamat jugs and filters

Jarra de cristal Queen / Queen glass jug



V.2436 (1,8 L)

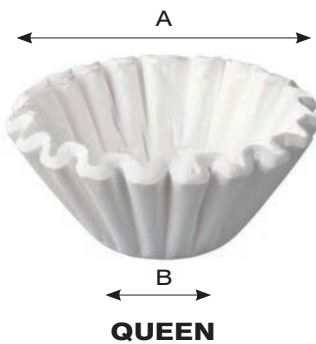

CÓDIGO CODE	DESCRIPCIÓN DESCRIPTION	Ø mm	UNIDADES UNITS
V.2432	Filtro papel máquina Coffee Queen Tower Coffee Queen Tower machine paper filter	523	500
V.2433	Filtro papel máquina Coffee Queen Coffee Queen machine paper filter	90	1000
V.2434		110	1000
V.2435		550	500

Jarras de cristal Animo-Bonamat / Animo-Bonamat glass jug



AC.438 (1,8 L)



ANM104 (1,8 L)



BON105 (1,7 L)

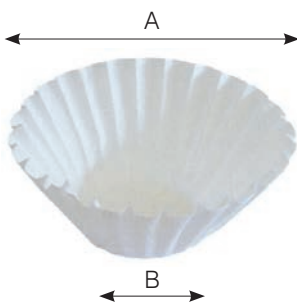

ANIMO-BONAMAT

CÓDIGO CODE	ADAPTABLE SUITABLE	Ø (A/B) mm	UNIDADES UNITS
BON183	BONAMAT: MONDO/MATIC/TH(a)/RLX	245/85	1000
V.1692	BONAMAT: MONDO/MATIC/NOVA Th/RL - Serie	250/90	1000
ANM109	ANIMO: FC-GL/DE5	317/101	500
ANM111	ANIMO: KF 6-GL/B600W/B	350/152	500
BON113	BONAMAT: B5/B5HW/AM112	360/110	250
BON181	BONAMAT: B(HW) / AURORA SERIES	437/152	250
ANM110	ANIMO: FC-GL/DE10/CE/CI 4-10 BONAMAT: B10/B10HW	457/152	500
ANM112	ANIMO: FC-GL/DE20/CE/CI 12-25 BONAMAT: B26/B20HW	533/203	500
BON182	BONAMAT: B(HW) / AURORA SERIES	535/203	250
ANM113	ANIMO: FC-GL/DE40 BONAMAT: B40/B40HW	635/280	500

Prensas francesas / French-press



V.3268 (0,3 L)
Madera olivo + cristal
Olive wood + glass
(2 tazas / 2 cups)
114x80x170 mm



V.3269 (0,6 L)
Madera olivo + cristal
Olive wood + glass
(4 tazas / 4 cups)
133x85x186 mm



V.3270 (0,4 L)
Madera olivo + cristal
Olive wood + glass
(3 tazas / 3 cups)
128x244 mm



V.3339 (0,3 L)
Madera olivo + cristal
Olive wood + glass
(2 tazas / 2 cups)
116x76x160 mm



V.3271 (0,3 L)
Acero inox + cristal
Stainless steel + glass
(2 tazas / 2 cups)
110x87x166 mm



V.3272 (0,6 L)
Acero inox + cristal
Stainless steel + glass
(4 tazas / 4 cups)
193x113x183 mm



Cafeteras Toddy / Toddy brewers

Toddy es una cafetera que produce un concentrado líquido suave, que se utiliza para hacer café caliente o helado. También se puede usar para té. El sistema de preparación en frío Toddy no contiene BPA.

Al permitir tiempo para reemplazar el calor, el proceso de filtración simple de agua fría extrae el verdadero sabor delicioso del café dejando menos acidez: 50-67% menos que los concentrados de café elaborados con métodos convencionales de extracción en caliente.

The Toddy Cold Brew System is a coffee maker that produces a smooth and delicious liquid concentrate used to make steaming hot coffee, and iced and iced blended coffee drinks. It also can be used to brew tea. The Toddy Cold Brew System is BPA free. By allowing time to replace heat, Toddy's deceptively simple cold water filtration process extracts the coffee bean's true delicious flavor yet leaves behind much of acidity - 50-67% less than coffee concentrates brewed by conventional hot-brewed extraction methods.

Toddy Home Cold Brew System



V.1396
(1,5L)



V.1419 (1,5 L)
Jarra de vidrio con tapa
Glass decanter with lid



V.1436
Contenedor con mango
Container with handle



V.1443
Tapa
Lid



V.1395
Filtros café (2 uds)
Coffee Filters (2 u.)



V.1401
Bolsas de filtro de papel (20 uds)
Paper Filter Bags (20 u.)



V.1496
Tapón de goma (2 uds)
Rubber Stopper (2 u.)



V.1614
Manija de contenedor
Container handle

Toddy Commercial Cold Brew System



V.1399
(20L)



V.1398
Grifo salida
Faucet outlet



V.1393
Soporte elevador
Elevator support



V.1394
Colador de cocción
en frío
Cold Brew strainer



V.1397
Bolsas de filtro (50 uds)
Cold Brew filters (50 u.)



V.1592 45L
V.1539 90L
Filtros Pro Series (50 uds)
Pro Series Filters (50 u.)

Cafeteras de filtro AeroPress AeroPress filter brewers

Video utilización AeroPress
AeroPress utilization video

Descripción

- Fabricada en copoliéster, polipropileno y elastómero termoplástico, libres de BPA.
- Instrucciones en español.
- INCLUYE 350 filtros de papel.

La AeroPress es una combinación de cafetera de émbolo o prensa francesa con un filtro de papel que utiliza la presión del aire para elaborar un café con más aceites y menos sedimentos en un tiempo récord. Fácil de trasladar y utilizar en cualquier ocasión.

Simplemente se coloca el café dentro, se vierte el agua caliente y se deja durante unos diez o veinte segundos para que se mezcle bien. Después sólo habrá que utilizar la prensa manual para extraer la bebida.

Description

- Manufactured in copolyester, polypropylene and thermoplastic elastomere, free of BPA.
- Instructions in spanish.
- It INCLUDEE 350 paper filters.

AeroPress is a combination of plunger coffee machine or french press with a paper filter which uses the air to ground a coffee full of more oils and less deposits in the shortest of time. Easy to move and ready to use in any occasion.

We put coffee inside and pour hot water, we leave it for ten or twenty minuts for a perfect blending. Afterwards, we use the hand press to remove the drink.



V.8541

Accesorios / Accessories



V.8542

Filtro papel (350 uds.)
Paper filter (350 u.)



V.8517

Filtro inox 35 micrones
Stainless steel filter
35 micron



V.8518

Filtro inox 150 micrones
Stainless steel filter
150 micron



V.3285

Soporte filtros plástico
Plastic filters support



V.3286

Bolsa protectora
Protective bag

Cafeteras de filtro Chemex Chemex filter brewers



V.8540 (0,44 L)
3 tazas / 3 cups
Ø 117 mm x 195h mm



V.3311 (0,47 L)
3 tazas / 3 cups
Ø 80 mm x 210h mm



V.8538 (0,88 L)
6 tazas / 6 cups
Ø 127 mm x 215h mm



V.3312 (0,87 L)
6 tazas / 6 cups
Ø 120 mm x 220h mm



V.8539 (1,18 L)
8 tazas / 8 cups
Ø 130 mm x 231h mm

Accesorios / Accessories



V.8536
Filtros 3 tazas (100 uds.)
Filters 3 cups (100 u.)



V.8535
Filtros 6-8 tazas (100 uds.)
Filters 6-8 cups (100 u.)



V.8537
Filtros cuadrados 6-8 tazas (100 uds.)
Square filters 6-8 cups (100 u.)



V.2440
Tapa Cristal
Glass cover



V.3284
Tapa silicona
Silicone cover



V.2441 (350 mm)
Cepillo nylon
Nylon brush



V.2442
Filtro inox
Stainless steel filter
Ø 145 mm x 110h mm



V.3347
Filtro inox
Stainless steel filter
Ø 145 mm x 110h mm



Cafeteras de filtro Espresso Brewing / Espresso Brewing filter brewers



V.1296 (0,8L)
Jarra cristal / Glass jug
Ø 130 mm x 130h mm



V.1248 (0,56L)
Jarra cristal / Glass jug
Ø 90 mm x 205h mm
Incluye / Include V.1248 +
V.1255



V.1261
Flor inox para filtros
Stainless steel flower for filters
(V60 - E&B - Chemex - Kinto)



V.1255
Flor inox para filtros
Stainless steel flower for filters
(E&B - Chemex - Kinto)



V.1246
Filtro inox 35 µm
Stainless steel filter 35 µm
Ø 145 mm x 95h mm



V.1247
Filtro inox 35 µm
Stainless steel filter 35 µm
Ø 145 mm x 95h mm



Filtro inox Aeropress / Aeropress inox filters
V.1347 (35 µm)
V.1348 (150 µm)
V.1349 (200 µm)



V.1297
Soporte metal negro
Black metal support



V.1298
Soporte inox
Stainless steel support

Conos filtro estándar / Standard filter cones



V.1135
Cono filtro superfino inox
Stainless steel super fine filter
cone

V.1164
Cono filtro fino inox
Stainless steel fine filter cone



V.1167
Cono doble filtro inox
Stainless steel filter cone

Cafeteras de filtro Hario Hario filter brewers

Jarras para café V60 / V60 Jugs for coffee



V.3287 (0,45 L)
162x114x110 mm



V.3288 (0,7 L)
180x125x133 mm



V.3340 (1 L)
185x137x157 mm



V.2625 (0,3 L)
130x107x99 mm



V.2626 (0,6 L)
145x121x120 mm



V.3341 (0,8 L)
150x129x138 mm



V.3291 (0,36 L)
130x107x106 mm



V.3292 (0,6 L)
137x121x128 mm



V.3342 (0,8 L)
143x132x145 mm



V.3293 (0,4 L)
Madera olivo + cristal
Olive wood + glass
177x118x108 mm



V.3294 (0,6 L)
Madera olivo + cristal
Olive wood + glass
182x128x125 mm



V.3295 (0,24 L)
Madera olivo + cristal
Olive wood + glass
95x168x93 mm



V.3296 (0,48 L)
Madera olivo + cristal
Olive wood + glass
110x195x101 mm

Cafeteras de filtro Hario Hario filter brewers

Conos V60 / V60 cones



Metacrilato / Methacrylate
V.2539

1-2 tazas / 1-2 cups
115x100x82 mm

V.2540
1-4 tazas / 1-4 cups
137x116x102 mm



Cerámica roja / Red ceramics
V.2541

1-2 tazas / 1-2 cups
119x100x80 mm

V.2542
1-4 tazas / 1-4 cups
140x120x102 mm



Cerámica blanca / White ceramics
V.2543

1-2 tazas / 1-2 cups
119x100x80 mm

V.2620
1-4 tazas / 1-4 cups
140x120x102 mm



Cristal / Glass
V.3301

1-2 tazas / 1-2 cups
124x110x78 mm



Cristal / Glass
V.3303

1-2 tazas / 1-2 cups
124x110x78 mm

V.3304
1-4 tazas / 1-4 cups
128x115x95 mm



Cristal + madera / Glass + wood
V.3305

1-2 tazas / 1-2 cups
120x77 mm

V.3306
1-4 tazas / 1-4 cups
120x95 mm



V.3307

Metal / Metal
1-4 tazas / 1-4 cups
145x120x90 mm



V.2621

Metal / Metal
1-4 tazas / 1-4 cups
145x120x90 mm



V.3308

Metal / Metal
1-4 tazas / 1-4 cups
145x120x90 mm



V.2669

Cobre / Copper
1-4 tazas / 1-4 cups
135x120x92 mm

Filtros papel V60 V60 paper filters



V.2511

1-2 tazas (100 uds.)
1-2 cups (100 u.)

V.2538
1-4 tazas (100 uds.)
1-4 cups (100 u.)



Blanco / White

V.3289

1-2 tazas (100 uds.)
1-2 cups (100 u.)

V.3290
1-4 tazas (100 uds.)
1-4 cups (100 u.)

Cucharas / Spoons



V.3334

Inox 12 g
Stainless steel 12 g



V.3335

Cobre 12 g
Copper 12 g

Cafeteras de filtro Hario Hario filter brewers

Soportes V60 y "clever dripper" / V60 Supports & clever dripper



V.2628
Plástico / Plastic
132x140x180 mm



V.3265
Clever dripper con tapa (0,6L)
Clever dripper with lid (0,6L)



V.2627
Báscula con temporizador
Scale with timer
2-200 gr
120x190x29 mm



V.3299
Plástico / Plastic
170x134x160 mm



V.3297
Aluminio / Aluminium
120x136x168 mm



V.3298
Metal + Plástico /
Metal + Plastic
195x140x215 mm

Hervidores de agua V60 / V60 Water kettles



V.2629 (1 L)
295x144x130 mm



V.2623 (1,2 L)
274x144x147 mm



V.2672 (0,7 L)
Cobre / Copper
290x126x145 mm



V.2622 (0,8 L / 1000W)
Eléctrico / Electric
300x156x175 mm



V.3348 (0,8 L / 1000W)
Eléctrico con control de temperatura
Electric with temperature control
300x190x185 mm



V.3300
Termómetro con tapa
Thermometer with cover

Cafeteras de filtro Hario Hario filter brewers

Decantador por goteo V60
V60 Dripping decanter



V.2624 (0,7 L)
135x198 mm

Jarras para café helado V60
V60 Jugs for iced coffee



V.2437 (0,7 L)
180x120x220 mm



V.3343 (0,7 L)
165x120x235 mm

Decantador por goteo para té
Dripping decanter for tea



V.3352 (0,8 L)
170x134x309 mm

Decantador por goteo en frío
Cold dripping decanter



V.3353 (0,78 L)
2-6 tazas / 2-6 cups
150x129x455 mm



V.3370
Filtros V.3353 (50 uds.)
Filters v.3353 (50 u.)

Jarras con filtro para té y café helado
Jugs with filter for tea and iced coffee



V.3344 (0,65 L)
87x84x300 mm



V.3345 (0,6 L)
138x94x208 mm



V.3346 (1 L)
138x94x294 mm

Cafeteras sifón con filtro Siphon brewer with filter



V.3349 (0,24 L)
2 tazas / 2 cups



V.8551 (0,36 L)
3 tazas / 3 cups



V.8552 (0,6 L)
5 tazas / 5 cups



V.3310 (0,6 L)
5 tazas / 5 cups



V.3350
Cristal superior / Upper glass
(V.3349)



V.2534
Cristal superior / Upper glass
(V.8551)



V.2536
Cristal superior / Upper glass
(V.8552)



V.3326
Cristal superior / Upper glass
(V.3310)



V.3351
Cristal inferior / Lower glass
(V.3349)



V.2535
Cristal inferior / Lower glass
(V.8551)



V.2537
Cristal inferior / Lower glass
(V.8552)



V.3327
Cristal inferior / Lower glass
(V.3310)



V.2445
Filtros papel
(100 unidades)
Paper filters (100 units)



V.2444
Filtros tela
(Pack 5 unidades)
Cloth filters (Pack 5 units)



V.2439
Filtro tela completo
Compleat cloth filter



V.2446
Adaptador +
50 filtros de papel
Adaptor + 50 paper filters



V.2438
Pala bambú
Bamboo spade/ful

Cafeteras sifón con filtro Siphon brewer with filter

Calentador halógeno / Halogen heater



V.3309
400W - 230V - 50Hz
215x235x165 mm



V.3380
Bombilla halógena
Halogen bulb
400W



Hervidores de agua y jarras Bonavita Bonavita water kettles and jugs

bonavita



V.3356
1-4 tazas / 1-4 cups
210x170x190 mm



V.3354 (0,6 L)
160x138x132 mm



V.3355 (1 L)
286x146x184 mm



V.3357 (1 L)
1000W - 220/240V - 50/60Hz
279x178x190 mm



V.3358 (1,7 L)
1500W - 220/240V - 50/60Hz
241x178x273 mm

Termos · Hervidores de agua Thermos · Kettles

Jarra termo Luxe
Luxe Thermo jug



CÓDIGO CODE	CAPACIDAD CAPACITY
AC.110	0,6 L
AC.111	1 L
AC.112	1,5 L

Jarra termo policarbonato
Thermo polycarbonate



CÓDIGO CODE	CAPACIDAD CAPACITY
AC.114	0,6 L
AC.115	1,2 L
AC.116	2 L

Tapa aislante con pulsador de apertura. Irrompible. Triple pared aislante, con relleno de poliuretano para mantener las bebidas frías/calientes durante horas. Apto para limpieza en lavavajillas. Identificadores de colores.

Insulating cover with pushbutton. Unbreakable, free of bad smells and stainless. Three insulating walls, with polyurethane filling to keep drinks hot/cold for hours. Suitable for dishwasher cleaning.

Hervidores eléctricos
Electric kettles



AC.200 (1,7 L / 2400 W)



AC.225 (1 L / 1650 W)
AC.226 (1,7 L / 2200 W)

Termo con dosificador
Thermo dispenser

CÓDIGO CODE	CAPACIDAD CAPACITY
AC.117	3 L
AC.118	4 L



Hervidores silbadores / Whistling kettles



AC.378 (2,5 L)



AC.227 (2,5 L)



AC.228 (2,5 L)

Sifones / Siphons

Sifones de espuma / Cream whipper



AC.498 (0,5 L)
AC..19 (1 L)
Sifón espuma / Cream whipper



AC.499 (0,5 L)
AC.503 (1 L)
Sifón espuma multifunción
Isi gourmet whip



AC.504 (0,5 L)
Sifón térmico / Thermo whip

Cápsulas carga de espuma / Cream replacement cartridges



AC..20
Cápsulas carga de espuma (10 unidades)
Cream replacement cartridges (10 units)



AC.507
Cápsulas carga de espuma (24 unidades)
Cream replacement cartridges (24 units)

Sifones de soda / Soda siphon



AC..21 (1 L)
Sifón de soda / Soda siphon



AC..22
Cápsulas carga de soda (10 unidades)
Soda replacement cartridges (10 units)

Accesorios café / Coffee accessories

Espolvoreadores cacao / Cocoa duster



V.1883
Ø 70x96 mm malla
Ø 70x96 mm mesh



V.6945
Ø 57x81 mm
Agujero Ø 1 mm
Hole Ø 1mm



V..718
Ø 70x96 mm
Agujero Ø 2 mm
Hole Ø 2 mm



AC.320
Ø 70x96 mm
Agujero Ø 3 mm
Hole Ø 3 mm



AC.321
Ø 70x96 mm
Agujero Ø 4 mm
Hole Ø 4 mm

Espolvoreadores cacao dibujos / Drawing cocoa duster



V.3543
Ø 68x105 mm

Plantillas cacao / Cocoa templates



V.1880
Estrellas
Stars



V.1881
Pisadas oso
Bear footsteps



V.1882
Flor
Flower

Lápices latte art / Latte art pens



V.7845
Juego 3 utensilios
Set 3 tools



V.7484



V.6395



AC.501



AC.500

Batidores cappuccino / Cappuccino mixers



V.3332
600W

Soporte incluido / Support included



V.3333
600W

Jarra 0,1 L incluida / Jug 0,1 L included



Accesorios café / Coffee accessories

Cucharas / Spoons



V.527
Inox 7 g
Stainless steel 7 g



V.520
Plástico 7 g
Plastic 7 g



V.3261
Inox 16 g
Stainless steel 16 g



V.3204
Inox 7 g con pinza
Stainless steel 7 g with pin



V.3264
Assaggio Inox
Stainless steel assaggio



V.3262
Espresso Inox
Stainless steel espresso



V.3263
Cappuccino Inox
Stainless steel cappuccino



V.3331
Latte macchiato Inox
Stainless steel latte macchiato



V.3579
Espresso Inox
Stainless steel espresso
V.3504 (6 u.)
V.5978 (12 u.)



V.3334
Inox 12 g
Stainless steel 12 g



V.3335
Cobre 12 g
Copper 12 g



V.1753
Espresso Inox
Stainless steel espresso
(6 u.)



V.1754
Cappuccino Inox
Stainless steel cappuccino
(6 u.)



V.1755
Latte macchiato Inox
Stainless steel latte macchiato
(6 u.)

Accesorios café / Coffee accessories

Palas / Shovels



AC.146 (900 g / 280 mm)
AC.147 (1800 g / 350 mm)
Policarbonato
Polycarbonate



AC.145 (170 g / 250 mm)
Policarbonato
Polycarbonate



V.713
(1000 g / 190 mm)
Inox / Stainless steel



V.712
(400 g / 150 mm)
Inox / Stainless steel



V.711
(100 g / 130 mm)
Inox / Stainless steel

Vasos de cristal serigrafiados / Crystal glass silkscreened



V.855
10/20/30/40 ml



V.6273
30/60 ml



V.3329
22/30/44/60 ml



V.3328
22/30/44/60 ml

concept-art



HARIO

V.1205
20/40/60 ml

HARIO

Molinos manuales / Hand grinders



V.3336 (30 g)
167x85x215 mm



V.3266 (30 g)
150x72x220 mm



V.3337 (40 g)
175x75x175 mm



V.3267 (100 g)
172x93x231 mm

Pincho muestra granos de café / Coffee beans sample spike



V.7847

Dispensadores / Dispensers



V.8021
25 ml



V.7883
240 ml

Accesorios café / Coffee accessories

Cuchara cata
Tasting spoon



AC..80
Cata inox
Stainless steel tasting

Bandeja cata
Tasting try



V.3313
Polipropileno 150-200 g
Polypropylene 150-200 g

Bol cata
Tasting Bowl



V.3338
200 ml

Llaveros / Key chains



V.7846
Llavero támara
Tamper key chain
Aluminio / Aluminium



Personalizamos los llaveros
(Consúltenos)

We customize key chains
(Contact Us)



Delantales / Aprons



V.3314
Cuero negro
Black leather



V.3315
Cuero marrón
Brown leather

Herramientas / Tools



V.3257
Conjunto de ganchos para toricas
Hook kit for gaskets



V.3258
Llave universal (tubo vapor / grupos / filtros / juntas / botellas / Ø 8-11-12-13)
Universal key (steam pipes / groups / filters / gaskets / bottles / Ø 8-11-12-13)



V.3259
Espejo / Mirror
Ø 30x165 mm
Máx. L=485 mm



V.3260
Llave sacafiltros
Extractor for filters

Básculas / Scales

Básculas de precisión (100-2000 g)
Precision scales (100-2000 g)



V.600



V.3565
TANGENT 102



V.6397
Báscula de cuchara
Spoon scale



V.3251



V.8000



V.3252



V.2627

CÓDIGO CODE	ESCALA SCALE	CAPACIDAD CAPACITY	MEDIDAS SIZE
V.600	0,1 g	100 g	156x76x16,5 mm
V.3565	0,1 g	100 g	139x69x18 mm
V.6397	0,1 g	300 g	220x50 mm
V.8000	0,1 g	500 g	110x80x20 mm
V.3251	0,1 g	500 g	125x78x18 mm
V.3252	0,15 g	600 g	55x90x20 mm
V.2627	0,1 g - 3 g	500 g - 2 kg	120x190x29 mm



V.3164
Pila botón LR44 1,5V (TANITA)
Battery LR44 1,5V (TANITA)

Básculas (5-10 kg) / Scales (5-10 kg)



AC..40
TANITA Báscula digital / Digital scale TANITA



AC..23
Báscula digital / Digital scale

CÓDIGO CODE	ESCALA SCALE	CAPACIDAD CAPACITY	MEDIDAS SIZE
AC..40	1 g	5 Kg	Ø 160 mm
AC..23	2 g	5 Kg	237x150 mm

Básculas / Scales

Básculas Acaia / Acaia scales



V.3254



V.3255



V.3256

CÓDIGO CODE	ESCALA SCALE	CAPACIDAD CAPACITY	MEDIDAS SIZE
V.3254	0,1 g	2 Kg	105x105x15 mm
V.3255	0,1 g	2 Kg	160x160x32 mm
V.3256	0,1 g	2 Kg	160x160x32 mm



CARACTERÍSTICAS / FEATURES

- Cronómetro - Temporizador / Stopwatch - Timer.
- Alimentación USB con batería de 20-30 h de autonomía.
USB power with battery of 20-30 h of autonomy.
- Almohadilla aislante en dotación / Insulating rubber included.
- Calibración automática / Automatic calibration.
- Conexión Bluetooth para Apps / Bluetooth connection for Apps.
- Compatible con IOS7, Android 4.3 o posteriores.
Compatible with IOS7, Android 4.3 or later.



APLICACIONES / APPS

El paquete completo de aplicaciones Acaia está diseñado para todos los niveles de preparación de café. Todas las aplicaciones son gratuitas y se conectan vía Bluetooth.

The full suite of Acaia apps is designed for every level of coffee brewing. All the apps are free and connect via Bluetooth.

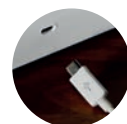

USB

Bluetooth®



Refractómetros / Refractometers

Digitales / Digitals



V.1129
Refractómetro digital
Digital refractometer

Modelo / Model: PAL-COFFEE (BX/TDS)

CARACTERÍSTICAS / FEATURES

- Rango / Range:
Brix : 0 - 25.00%; TDS: 0 - 22.00%;
10 - 100°C.
- Resolución / Resolution:
Brix: 0.01%; TDS: 0.01%; 0.1°C.
- Precisión medición / Measurement Accuracy:
Brix: $\pm 0.10\%$; TDS: $\pm 0.15\%$; $\pm 1^\circ\text{C}$.
- Compensación temperatura / Temperature compensation:
10 - 100°C.
- Temperatura ambiente / Ambient Temperature:
10 - 40°C.
- Volumen mínimo muestra: 0.3ml /
Minimum sample volume: 0.3ml.
- Tiempo medición continua /
Continuous measurement time:
5 - 120 sec.
- Fuente alimentación: 2 pilas
alcalinas AAA / Power supply: 2 AAA
alkaline batteries.
- Duración batería 11.000 mediciones
/ Battery life: 11.000 measurements.
- Grado de protección / IP Code:
IP65.
- Dimensiones / Dimensions:
55(W) x 31(D) x 109(H)mm.
- Peso / Weight: 100g.



V.1204
Refractómetro digital
Digital refractometer

Modelo / Model: MA-871

CARACTERÍSTICAS / FEATURES

- Rango / Range:
0 - 85% Brix / 0 - 80°C (32 - 175 °F).
- Resolución / Resolution:
0.1% Brix / 0.1°C (0.1°F).
- Precisión / Accuracy:
 $\pm 0.2\%$ Brix / $\pm 0.3^\circ\text{C}$ ($\pm 0.5^\circ\text{F}$).
- Tiempo medición / Measuring time:
1,5 sec.
- Volumen mínimo muestra / Minimum
sample volume: 100 μL .
- Compensación automática
temperatura / Automatic temperature
compensation:
10 - 40°C (50 to 104°F).
- Pila / Battery: 1 x 9 V.
- Duración batería: 5000 mediciones /
Battery life: 5000 measurements.
- Dimensiones / Dimensions:
19.2x10.2x6.7 cm.
- Peso / Weight: 420 g.

Óptico / Optical



V.1131
Refractómetro óptico
Optical refractometer

CARACTERÍSTICAS / FEATURES

- Rango / Range:
0 - 18% Brix.
- Resolución / Resolution:
0.1% Brix / 0.1°C.
- Precisión / Accuracy:
0.1% Brix / 0.1°C.
- Compensación automática temperatura /
Automatic temperature compensation:
10-30°C.

Termómetros / Thermometers

Analógicos / Analogic



V.8018
-10 / 100 °C
Sonda / Probe Ø 25x150 mm

V..408
-10 / 100 °C
Sonda / Probe Ø 40x125 mm

V.4211
Clip / Clip

Digitales / Digital



V.3085



VF5691



V..409



V.8139

Respuesta rápida - Negro
Fast answer - Black



VF.450



V.1838

Infrarrojo / Infrared

CÓDIGO CODE	TEMPERATURA TEMPERATURE	MEDIDA SONDA PROBE SIZE	MEDIDA CABLE CABLE LENGTH	SENSIBILIDAD SENSIBILITY	PRECISIÓN ACCURACY	RESPUESTA ANSWER
V.3085	-30 / 120 °C	Ø 3,5x105 mm	No	0,1 °C	± 0,2 °C	-
VF5691	-40 / 200 °C	Ø 3,5x75 mm	No	0,1 °C	± 1 °C	-
V..409	-50 / 200 °C	Ø 3,5x105 mm	No	0,1 °C	± 0,5 °C	-
V.8139	-50 / 200 °C	Ø 3,5x115 mm	No	0,1 °C	± 0,4 °C	3 Segundos
VF.450	-50 / 300 °C	Ø 3,5x100 mm	1 m	0,1 °C	± 1 °C	-
V.1838	-60 / 500 °C	No	No	0,1 °C	± 1 °C	-

Termómetros / Thermometers

Adhesivo / Label



ATTENTO es un termómetro que se adhiere a las jarras de leche. Sus ranuras de cristal líquido indican la temperatura exacta cambiando del negro al verde. Reacción muy rápida. Duradero y de calidad profesional. Apto para lavavajillas. Peso 3 g.

The ATTENTO is a fast temp-label that your frothing pitcher. The label has liquid crystal slots which indicate the accurate temperature by becoming bright green. In comparison to digital or analogic thermometers, the liquid crystal shows temperature at the precise moment when the target temperature is reached. Weight 3 g.

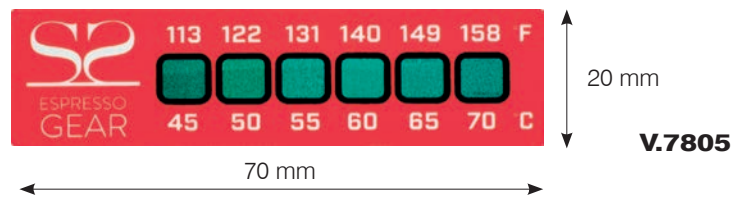

COMO FUNCIONA EL TERMÓMETRO ATTENTO

- Mayor productividad y exactitud.
- Muestra los cambios de temperatura instantáneamente.
- Duración de hasta 10 meses en uso profesional.
- Siempre enganchado a tu jarra evitando descuidos.
- No necesita calibración.
- Apto para lavavajillas.

HOW THE ATTENTO THERMOMETER WORKS

- Total quality control.
- Hygienic use since is not in contact with milk.
- Temperature changes shows instantly.
- Always stick to the pitcher, not in a drawer.
- No need to calibration, always correct.

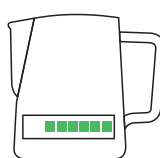
- 

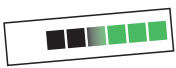
1. Pegar el termómetro en la parte inferior de la jarra, por debajo del nivel de la leche.
Attach thermomometer onto your favourite pitcher. Place it low so that, that is below the milksurface line.
- 

2. A medida que aumenta la temperatura, los cristales líquidos cambiarán a color negro. La reacción es inmediata.
When steaming watch the liquid crystals turning black as temperature increase.
- 

3. A la temperatura deseada, para de calentar la leche.
Stop at your desired temperature.

Temporizador digital con imán / Digital timer with magnet



V.3084
70x50x7 mm



Cepillos limpieza / Cleaning brushes

Limpieza grupos / Groups cleaning

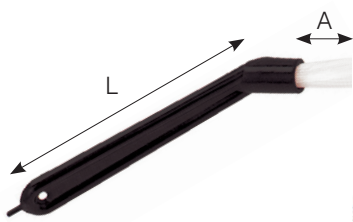

V...26

Plástico con cerdas nylon
Plastic with nylon bristles
(AxL) 45x145 mm



V.1134

Plástico con cerdas nylon
Plastic with nylon bristles
(AxL) 45x115 mm



V.3639

Plástico con cerdas nylon
Plastic with nylon bristles
(AxL) 45x195 mm



V.1013

Plástico con cerdas nylon
Plastic with nylon bristles
(AxL) 45x235 mm



V.3330

Recambio /
Replacement
(V.7842)

V.7842

Aluminio con cerdas nylon
Aluminium with nylon bristles
(AxL) 40x195 mm



V.7713

Plástico con cerdas nylon
Plastic with nylon bristles
(AxL) 45x234 mm



V.7714

3 cabezales nylon
3 nylon heads
(V.7713)



V.8420

Plástico con cerdas nylon
Plastic with nylon bristles
(AxL) 20x235 mm



V.8421

2 cabezales nylon
2 nylon heads
(V.8420)



SP.499

Plástico con cerdas inox
Plastic with stainless steel
bristles
(AxL) 45x280 mm



V.3273

Plástico con cerdas inox
Plastic with stainless steel
bristles
30x45x270 mm



Nylon / Nylon	Ø1 mm	Ø2 mm	L mm
V.8009	53	55	85
V.7843	56	58	85

Enfriador granos de café Coffee grains cooler



V.3325

Limpieza a vapor Steam cleaning



V.7841

L = 180 mm
Con vapor / With steam



V.6396

H = 30 mm



Cepillos limpieza / Cleaning brushes

Limpeza jarras-tubos / Jugs-pipes cleaning

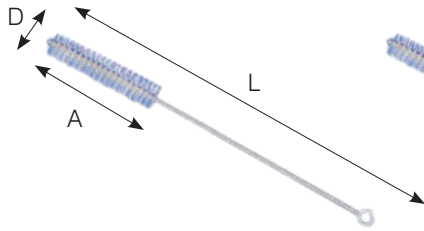

V.1659

Metal con cerdas nylon
Metal with nylon bristles
(DxAxL) Ø 6x100x300 mm

V.1661

Metal con cerdas nylon
Metal with nylon bristles
(DxAxL) Ø 8x100x300 mm

V..856

Metal con cerdas nylon
Metal with nylon bristles
(DxAxL) Ø 15x100x300 mm

V.3276

Metal-plástico con cerdas nylon
Metal-plastic with nylon bristles
(DxAxL) Ø 6,4x40x300 mm



V.1658

Metal con cerdas inox
Metal with stainless steel bristles
(DxAxL) Ø 6x100x300 mm



V.1660

Metal con cerdas inox
Metal with stainless steel bristles
(DxAxL) Ø 8x100x300 mm



GBG.23

Metal con cerdas nylon
Metal with nylon bristles
(DxAxL) Ø 24x110x370 mm



CHA.55

Metal-plástico con cerdas nylon
Metal-plastic with nylon bristles
(DxAxL) Ø 15x100x310 mm



V.3316

Metal-plástico con cerdas nylon
Metal-plastic with nylon bristles
(D) Ø 7,5 mm



V.3317

Metal-plástico con cerdas nylon
Metal-plastic with nylon bristles
(D) Ø 6 mm

Varilla ducha 10TSC Shower rod 10TSC



R.1524

Inox / Stainless steel
Ø 1x190 mm

Limpeza jarras-termos Jugs-thermos cleaning



BON112

Nylon / Nylon
50x105x345 mm



V.8422

Conjunto cepillos limpieza leche
Milk cleaning brushes kit

Cepillos limpieza / Cleaning brushes

Limpieza fresas / Burr cleaning

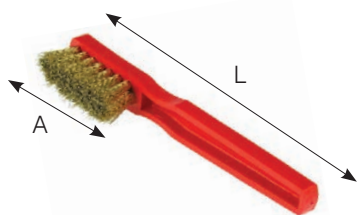

V.590

Plástico con cerdas latón
Plastic with brass bristles
(AxL) 40x132 mm



V.1656

Plástico con cerdas inox
Plastic with stainless steel bristles
(AxL) 40x132 mm



V.1657

Plástico con cerdas nylon
Plastic with nylon bristles
(AxL) 40x132 mm

Limpieza molinos de café / Coffee grinder cleaning



V.645

Madera con cerdas naturales
Wooden with natural bristles
(AxL) 50x210 mm



V.8015

Madera con cerdas naturales
Wooden with natural bristles
(AxL) 45x170 mm



V.3277

Madera con cerdas naturales
Wooden with natural bristles
(AxL) 40x230 mm



V.3274

Madera con cerdas naturales
Wooden with natural bristles
(AxL) 35x170 mm



V.3275

Plástico con cerdas naturales
Plastic with natural bristles
(AxL) 35x170 mm



V.3318

Plástico con cerdas naturales
Plastic with natural bristles
(AxL) 40x132 mm

Bayetas / Cleaning cloth



V.3281

Microfibra / Microfiber
200x200 mm



V.3282

Microfibra / Microfiber
300x300 mm
(4 unidades / 4 units)



V.3283

Con gancho / With hook
300x300 mm



Microfibra / Microfiber
V.1097

Azul / Blue 200x200mm
V.1098

Verde / Green 300x300mm
V.1112
Gris / Grey 300x600mm



V.1113

Microfibra / Microfiber
1 gris / grey 300x600mm
1 verde / green 300x300mm
2 azules / blue 200x200mm

Productos de limpieza / Cleaning products

Detergente para máquinas de café profesionales Professional coffee machine detergent



Polvo / Powder

Elimina los residuos del café en el grupo de erogación y en la electroválvula de descarga. Ideal para el mantenimiento de las máquinas de café y accesorios.

Remove coffee deposits from the brewing group, solenoid valve and water circuit. Ideal for the maintenance of espresso machines and spare parts.



V..100

Detergente grupo 10 sobres 20 g
Group detergent 10 bags 20 g



V..101

Detergente grupo 900 g
Group detergent 900 g

Pastillas / Tabs



V.8013

70 pastillas 0,5 g
70 tabs 0,5 g



V.8014

100 pastillas 1,35 g
100 tabs 1,35 g



V.3692

100 pastillas 1 g
100 tabs 1 g



V..571

60 pastillas 2,5 g
60 tabs 2,5 g



V.7696

100 pastillas 4 g
100 tabs 4 g



V.8060

100 pastillas 1 g
100 tabs 1 g

Kit lavado completo Pully Caff / Complete Pully Caff washing kit

Sistema de limpieza a inmersión para portafiltros, grupos salidas y accesorios máquinas de café.

Immersion cleaning system for filterholders brew group and accessories for coffee machines.



V.8012



4 sobres 20 g
4 bags 20 g
(V..100)



V..142
4 dosis 25 ml
4 doses 25 ml



V...26



2 sobres 15 g
2 bags 15 g
(V.7973)

Productos de limpieza / Cleaning products



Detergente Puly Milk / Puly Milk detergent

Elimina la acumulación de la proteína de la leche. Ideal para el mantenimiento de los cappuccinadores automáticos, tubos para espumar la leche y tubos de acero inoxidable. / Eliminates the accumulation of the protein in milk. Ideal for maintenance of the automatic cappuccinators, frothing pipes and stainless steel pipes.



V..142

4 dosis x 25 ml / 4 dose x 25 ml



V..144

14 dosis x 25 ml + cubeta
14 dose x 25 ml + tank



V..570

1 L

Detergente limpieza fresas Blades cleaning detergent

Elimina la acumulación de café molido entre los dientes de la fresa. Absorbe el aceite del café.
Eliminates the accumulation of ground coffee between the teeth of the blade. Absorbs the coffee oil.



V.2461

430 g



V.7973

10 sobres 15 g / 10 bags 15 g



V..145

1 L

Detergente multiusos Multipurpose detergent

Limpia e higieniza todas las superficies del acero inoxidable, barnizadas, plásticas, vidrio, espejos y cuchillos.
Cleans and hygienize all surfaces of stainless steel, lacquered, plastic, glass, mirrors and knives.

Desincrustantes / Descalings

Desincrustante regenerador profesional para máquinas de café. Elimina los residuos calcáreos. No daña las juntas de goma.
Professional coffee machines regenerator descaling. Removes limestone deposits. Does not damage rubber seals.



V..102

Desincrustante 1 Kg / Descaler 1 Kg



V..147

Desincrustante líquido 2x125 ml
Liquid descaler 2x125 ml



V..666

Desincrustante 10 sobres x 30 g
Máquinas domésticas
Descaler 10 bags x 30 g
Domestic machines

Productos de limpieza / Cleaning products

Detergente grupo / Group detergent



Polvo / Powder

Pastillas / Tabs



V.8133
15 sobres 20 g
15 bags 20 g



V.8132
900 g



V.8134
60 pastillas x 2,5 g
60 tabs x 2,5 g



V.8135
100 pastillas x 1 g
100 tabs x 1 g

Desincrustante / Descaling

Limpiador cappuccino Cappuccino cleaner



V.8136
12 sobres 25 g / 12 bags 25 g



V.8137
1 Kg



V.8138
1 L

Desincrustante: aluminio, cobre, latón, plástico y acero
Descaling: aluminium, copper, brass, plastic and steel



V.2064
Desincrustante aluminio 1 L
Aluminium descaler 1 L



V.2070
Desincrustante acero, cobre, latón y
plástico 1 L
Steel, copper, brass and plastic descaler 1 L



V.2063
Detergente desincrustante
concentrado 1 L
Concentrated descaler detergente 1 L

Limpiador placas electrónicas Electronic boards cleaner

Limpiador inox Stainless steel cleaner



V.2071
200 ml



V..372
500 ml



V.4208
1 L



Cafetto es una empresa líder en soluciones orgánicas y ecológicas eficaces, ofreciendo productos de limpieza para máquinas de café. Sus productos mejoran el rendimiento del equipo y simplifican los procesos de limpieza.

La gama Caffetto ha sido probada rigurosamente para desarrollar los productos de limpieza más eficaces para limpiar y desinfectar sus equipos.

Cafetto is an industry leader in effective organic and eco-friendly solutions, offering cleaning products to improve equipment performance and simplify cleaning processes.

The CAFETTO range has been stringently tested to bring you the most effective products to clean and sanitise your equipment.

Certificaciones / Certifications



Productos de limpieza / Cleaning products

Gama orgánica / Organic range

Detergente para máquinas de café profesionales Professional coffee machine detergent

Polvo / Powder

Pastillas / Tablets

Líquido / Liquid



EVO ESPRESSO CLEANER
V.8401
500 g
V.8402
1 Kg



TEVO TABLETS
V.8403
Mini pastillas 1,5 g (60 pastillas)
Mini tablets 1,5 g (60 tabs)
V.8404
Maxi pastillas 2,5 g (150 pastillas)
Maxi tablets 2,5 g (150 tabs)



MFC GREEN
V.8410
Limpiador leche 1 l / Milk cleaner 1 l
MFC Green elimina el 99,999% de E-Coli,
Salmonela, Listeria y Enterococcus
Green MFC kills 99.999% of E-Coli,
Salmonella, Listeria and Enterococcus

Descalcificador máquinas de café profesionales Professional coffee machine descaler

Líquido / Liquid

Polvo / Powder



LIQUID ORGANIC DESCALER
V.8411
1 L



RESTORE
V.8412
1 Kg

Detergente para molinos / Grinder detergent

Polvo / Powder

100% natural, no contiene gluten. Elimina olores y sabores de café incrustados en las fresas.

100 % natural, and gluten free. Cleans grinder burrs and casings as well as removing flavoured coffee odours.



GRINDER CLEAN
V.8416
Limpiador fresas molino
Burrs cleaner
430 g



Productos de limpieza / Cleaning products

Detergente para máquinas de café superautomáticas Super automatic coffee machine detergent

Pastillas / Tablets



N10 TABLETS
V.8405

50 pastillas / 50 tabs
1 g

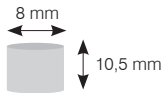

S15 TABLETS
V.8406

100 pastillas / 100 tabs
1,5 g

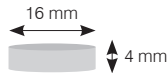

F20 TABLETS
V.8407

100 pastillas / 100 tabs
2 g

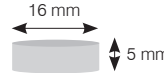

J25 TABLETS
V.8408

80 pastillas / 80 tabs
2,5 g

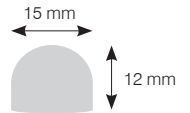

Máquinas de café espresso Espresso coffee machine

Polvo / Powder



ESPRESSO CLEAN
V.3279

1 Kg

Máquinas de filtro Coffee filter machine (BREW)

Pastillas / Tablets



BREW CLEAN
V.8414

100 pastillas 4 g / 100 tabs 4 g

Detergente limpiador de leche Milk cleaner detergent

Polvo / Powder



INVERSO
V.1096

750 g

Detergente para cafeteras de cápsula tipo NESPRESSO® NESPRESSO® capsule coffee machine detergent



V.3280
5 cápsulas
5 capsules
3 g



caffenu



cafetto

V.1127
6 cápsulas
6 capsules
3 g

Coctelería / Bartending

Cocteleras / Shakers



V.7954
Coctelera de cristal
Glass shaker
0,5 L
Ø 90x225 mm



AC.271 (0,35 L)
V..709 (0,5 L)
AC.272 (0,70 L)
Coctelera inox / Stainless steel shaker
0,75 L



V.7955
Coctelera negra
Black shaker
0,5 L
Ø 90x200 mm



V..727
Coctelera inox
Stainless steel shaker
0,70 L

Utensilios coctelería / Bartending tools



AC.217 (L 14 cm)
AC.218 (L 17 cm)
Pinza inox / Stainless steel clamp



V..726
Exprimidor limones inox
Stainless steel lemon squeezer



V.7952
Maza cóctel / Cocktail mace



V..707
Colador cóctel inox
Stainless steel cocktail strainer



V..710
Cuchara cóctel inox
Stainless steel cocktail spoon



V..708
Dosificador licor inox
Stainless steel liquor doser

Kits barman / Barman kits

5 accesorios / 5 accessories



V.7688

CÓDIGO / CODE	DESCRIPCIÓN / DESCRIPTION
V.7687	Coctelera inox+cristal 0,70 L / Stainless steel jug 0,70 L
V.7683	Dosificador cóctel inox 2/4 / Stainless steel cocktail doser 2/4
V.7686	Colador cóctel inox / Stainless steel cocktail stainer
V.7685	Cuchara agitador cóctel inox / Stainless steel cocktail shaker spoon
V.7678	Cuchara para hielo inox / Stainless steel ice spoon



V.7687



V.7683



V.7686



V.7685



V.7678

7 accesorios / 7 accessories



V.7689

CÓDIGO / CODE	DESCRIPCIÓN / DESCRIPTION
V.7687	Coctelera inox+cristal 0,70 L / Stainless steel jug 0,70 L
V.7683	Dosificador cóctel inox 2/4 / Stainless steel cocktail doser 2/4
V.7681	Pinza para hielo inox / Stainless steel ice clamp
V.7686	Colador cóctel inox / Stainless steel cocktail stainer
V.7685	Cuchara agitador cóctel inox / Stainless steel cocktail shaker spoon
V.7952	Maza cóctel / Cocktail mace
V.7682	Abridor de botellas inox / Stainless steel bottle opener



V.7687



V.7683



V.7681



V.7686



V.7685



V.7952



V.7682

Accesorios té / Tea accessories



V.988
Bola filtro té / Tea filter ball
Ø 45 mm



V.991
Bola filtro té / Tea filter ball
Ø 60 mm



AC.519
Pinza filtro té / Tea filter pin
Ø 45 mm



AC.520
Cuchara filtro té / Tea filter spoon
155 mm



V.3319
Filtros bolsas (50 uds.)
Bags filters (50 u.)



AC.529
Colador superfino tetera
Superfine colander
Ø 70 mm H 72 mm

Cajas de madera / Wooden box



V.8562
8 compartimentos / 8 compartments
310x280x90 mm



V.8017
6 compartimentos / 6 compartments
230x155x90 mm



AC..10
4 compartimentos / 4 compartments
335x200x90 mm

Teteras con filtro inox / Teapots with stainless steel filter



V.7741 (0,35 L)
V.7742 (0,80 L)
Modelo Japon / Japon Model



V.7743 (0,30 L)
V.7744 (0,60 L)
Modelo Nipon / Nipon Model



V.7745 (0,40 L)
Modelo Asia / Asia Model



www.ascaso.com



Atención y Servicio: Nuestra Prioridad Customer Support: Our Priority

Comunicación rápida garantizada (de 8,30 a 19,30h sin interrupción)
Rapid response guaranteed (8:30am to 7:30pm continuously)



Teléfono / Phone
93 377 64 11

Consultas, asesoramiento, pedidos, devoluciones...
Todo lo que necesites.

Inquiries, advice, orders, returns ... All you need.



Whats App
679 144 765

Fotografía la pieza y la buscamos por ti.

Send a picture of the part and we'll find it for you.



Fax
93 377 98 03

Mismo servicio que con el teléfono o whats app
Inmediato!

Just the same as phone or whatsapp



Email
consultas@ascaso.com

Este buzón se revisa cada minuto para todo tipo de consultas.

This mailbox is checked every minute for all kinds of queries



Chat
Catálogo Online
Online Catalogue Orders

www.ascaso.com
Consúltanos online y te ayudamos en directo.

We help online.

Pregúntanos y te atenderemos "volando"
Ask us and we will answer you "flying"

Catálogos Online Online Catalogs



Todos nuestros catálogos impresos están en la web, siempre actualizados y disponibles.

Fácil de usar
110.000 códigos en stock
Chat en directo

All our catalogs printed are on the web, always updated and available.

Easy to use
110.000 codes in stock
Live chat

www.ascaso.com



Ascaso Factory S.L.

■ Energía, 39-41 - Poligono Industrial Famadas - 08940 Cornellà - Barcelona - SPAIN

■ Tel.: 93 377 64 11 - Fax: 93 377 98 03 ■ International: Tel.: (34) 93 377 64 11 - Fax: (34) 93 377 98 03

■ www.ascaso.com - ascaso@ascaso.com