



COMPONENTI PER GAS



COMPONENTI ELETTRICI



COMPONENTI PER ACQUA



COMPONENTI MECCANICI



UTENSILI

Ricambi adatti a

BRASILIA

Per la gamma completa sempre aggiornata visitate il nostro internet shop



Catalogo dei produttori

Per ciascun produttore, le parti di ricambio e gli accessori sono elencati in modo chiaro

- ✓ Assortimento completo e tutti i dati degli apparecchi sempre aggiornati nel Internetshop GEV
- ✓ Indice alfabetico alla fine del catalogo

Internetshop GEV Fast ricambi

www.fastricambi.it







- 🔍 Segna articolo come preferito
- 🔍 Procedi al log-in inserendo l'indirizzo mail e la password
- 🔍 Ordine Comfort – carica nel carrello una lista di articoli
- 🔍 Cerca ricambi in Cercafacile senza bisogno del log-in

resistenze







resistenze per macchine da caffè

			
1			
codice	417280	cod. costr.	10432.2.00.08
descrizione	resistenza 1000W 220V Nr. spirali 1 ø 50mm H 60mm B1 45mm H1 20mm H2 40mm interasse di fissaggio 35mm filetto M10x1 spire 4 tubo ø 6.3mm resistenza ad immersione fissaggio a 2 fori attacco Faston maschio 6,3mm		
Per modelli:	205-Exclusive, Bolero, Excelsior-OR, Excelsior-Standard, Gradisca-Res-tyling, Opus, Opus-B03-OR, Opus-OR		

			
1			
codice	417035	cod. costr.	00625.2.00.08
descrizione	resistenza 1200W 230V Nr. spirali 1 ø 55mm H 66mm B1 55mm H1 30mm H2 36mm interasse di fissaggio 42mm filetto 1/4" rame spire 3 tubo ø 8.5mm resistenza ad immersione fissaggio a 2 fori attacco Faston maschio 6,3mm		
Per modelli:	BELLE EPOQUE JUNIOR, CLUB, LADY, MBM GOLF, OFFICE RB2		
accessori per	417035		
	codice	528231	cod. costr. 00839.0.00.02
	O.R. Viton spessore 2.62mm int. ø 12.37mm conf. 1 pz		
	codice	550932	cod. costr. —
	dado filetto 1/2" H 6mm CH 27 inox conf. 1 pz		

			
1			
codice	417081	cod. costr.	01911.2.00.08
descrizione	resistenza 1350W 230V Nr. spirali 1 filetto 1" L 140mm lar. 22mm H 23mm tubo ø 8.5mm attacco 6.3 resistenza ad immersione flangia filettata		
Per modelli:	Roma-Cappuccino		
accessori per	417081		
	codice	510404	cod. costr. —
	guarnizione piana fibra ø est. 44mm int. ø 34mm spessore 2mm conf. 1 pz		
	codice	528018	cod. costr. 18661.0.00.02 18661.2.00.02
	guarnizione piana PTFE ø est. 41mm int. ø 33mm spessore 3mm 1" conf. 1 pz		

			
1			
codice	417034	cod. costr.	05430.0.00.04 05430.2.00.08
descrizione	resistenza 1400W 230V Nr. spirali 1 L 228mm lar. 45mm int. dei fori 68mm fori ø 6.5mm tubo ø 8.5mm attacco M3x0,6 resistenza ad immersione flangia a 2 fori		
Per modelli:	CAPPUCCINO		

			
1			
codice	417173	cod. costr.	02286.2.00.08
descrizione	resistenza 1700W 230V Nr. spirali 3 filetto 1/4" L 135mm lar. 26mm H 29mm tubo ø 8.5mm attacco M3 resistenza ad immersione flangia filettata		
Per modelli:	Belle-Epoque		
accessori per	417173		
	codice	510405	cod. costr. —
	guarnizione piana fibra ø est. 56mm int. ø 42mm spessore 2mm per filettatura 1/4" conf. 1 pz		
	codice	527169	cod. costr. 01263.0.00.03
	dado esagonale filetto M3 H 2.8mm CH 5.5 ottone conf. 1 pz		
	codice	528021	cod. costr. 00826.0.00.02 02286
	guarnizione piana PTFE ø est. 53mm int. ø 42.5mm spessore 3mm conf. 1 pz cod. prod. 12001/02286 adattabile a Astoria/Aurora/Brasilia/Wega		
	codice	560110	cod. costr. —
	rondella di spessore int. ø 3.2mm ø est. 7mm spessore 0.5mm inox conf. 20 pz DIN 125A per filettatura M3		
	codice	560130	cod. costr. —
	dado esagonale filetto M3 H 2.4mm CH 5.5 inox DIN/ISO DIN 934 / ISO 4032/8673 conf. 20 pz		

			
1			
codice	417030	cod. costr.	00614.2.00.02 00614.2.00.08
descrizione	resistenza 1800W 230V Nr. spirali 2 incasso ø 40mm int. dei fori 57mm L 177mm lar. 26mm H 53mm L1 35mm L2 60mm L3 74mm H1 24mm H2 29mm fori ø 10mm tubo ø 8.5mm attacco M6 resistenza ad immersione flangia a 3 fori adattabile a BRASILIA, VIBIEMME		
Per modelli:	100, 105, 105SL, 205, Century, Firenze, Firenze-SL, Firenze-SL-Raised, PORTOFINO		





			
1			
codice	415006	cod. costr.	00613.2.00.08
descrizione	resistenza 1880W 230V Nr. spirali 1 filetto 1/4" L 147mm lar. 35mm H 26mm attacco M4 resistenza ad immersione flangia filettata rame		
ricambi per	415006		
	codice	510405	cod. costr. —
	guarnizione piana fibra ø est. 56mm int. ø 42mm spessore 2mm per filettatura 1/4" conf. 1 pz		



Tabella continua alla prossima pagina





accessori per	415006		
	codice	520232	cod. costr. —
	dado filetto 1¼" H 5mm ottone nichelato CH 47 conf. 1 pz		
	codice	521103	cod. costr. —
	dado filetto M4 H 3mm CH 7 ottone conf. 20 pz		
	codice	521104	cod. costr. —
	rondella piana int. ø 4.3mm ø est. 8mm spessore 0.5mm ottone conf. 20 pz per filettatura M4		
	codice	528021	cod. costr. 00826.0.00.02 02286
	guarnizione piana PTFE ø est. 53mm int. ø 42.5mm spessore 3mm conf. 1 pz cod. prod. 12001/02286 adattabile a Astoria/Aurora/Brasilia/Wega		
	codice	560111	cod. costr. —
	rondella di spessore int. ø 4.3mm ø est. 9mm spessore 0.8mm inox conf. 20 pz DIN 125A per filettatura M4		
	codice	560131	cod. costr. —
	dado esagonale filetto M4 H 3.2mm CH 7 inox DIN/ISO DIN 934 / ISO 4032/8673 conf. 20 pz		



	1		
codice	417032	cod. costr.	00613.2.00.08
descrizione	resistenza 2000W 230V Nr. spirali 1 filetto 1¼" L 170mm lar. 35mm H 33mm tubo ø 8.5mm attacco M6x1 resistenza ad immersione flangia filettata		
Per modelli:	MILLENNIO, PORTOFINO AMERICA		
accessori per	417032		
	codice	510405	cod. costr. —
	guarnizione piana fibra ø est. 56mm int. ø 42mm spessore 2mm per filettatura 1¼" conf. 1 pz		
	codice	528021	cod. costr. 00826.0.00.02 02286
	guarnizione piana PTFE ø est. 53mm int. ø 42.5mm spessore 3mm conf. 1 pz cod. prod. 12001/02286 adattabile a Astoria/Aurora/Brasilia/Wega		



	1		
codice	417196	cod. costr.	00627.2.00.08
descrizione	resistenza 2400W 220V Nr. spirali 2 filetto 1¼" L 230mm lar. 33mm H 23mm attacco M4 resistenza ad immersione flangia filettata		
Per modelli:	Belle-Epoque		
accessori per	417196		
	codice	510405	cod. costr. —
	guarnizione piana fibra ø est. 56mm int. ø 42mm spessore 2mm per filettatura 1¼" conf. 1 pz		
	codice	528021	cod. costr. 00826.0.00.02 02286
	guarnizione piana PTFE ø est. 53mm int. ø 42.5mm spessore 3mm conf. 1 pz cod. prod. 12001/02286 adattabile a Astoria/Aurora/Brasilia/Wega		

	1		
codice	417080	cod. costr.	01378
descrizione	resistenza 2400W 230V Nr. spirali 2 filetto 1¼" L 225mm lar. 24mm H 38mm tubo ø 8mm attacco Faston maschio 6,3mm resistenza ad immersione lunghezza terminali 18mm flangia filettata		
accessori per	417080		
	codice	510405	cod. costr. —
	guarnizione piana fibra ø est. 56mm int. ø 42mm spessore 2mm per filettatura 1¼" conf. 1 pz		
	codice	528021	cod. costr. 00826.0.00.02 02286
	guarnizione piana PTFE ø est. 53mm int. ø 42.5mm spessore 3mm conf. 1 pz cod. prod. 12001/02286 adattabile a Astoria/Aurora/Brasilia/Wega		

	1		
codice	417031	cod. costr.	00615.2.00.08
descrizione	resistenza 3000W 230V Nr. spirali 2 incasso ø 40mm int. dei fori 59mm L 327mm lar. 28mm H 52mm L1 31mm L2 59mm L3 240mm H1 24mm H2 28mm spire 2 fori ø 10mm tubo ø 8.5mm attacco M6x1 resistenza ad immersione flangia a 3 fori adattabile a BRASILIA		
Per modelli:	100, 105, 105SL, 205, 205-Exclusive, Century, Century-Restyling, DeCurtis-CAMME, DeCurtis-DIG, DeCurtis-LEVA, Firenze, Firenze-SL, Firenze-SL-Raised, PORTOFINO, Portofino-Restyling		
accessori per	417031		
	codice	528013	cod. costr. —
	guarnizione int. ø 40mm fibra spessore 4mm fori ø 11mm int. dei fori 57mm per resistenza ricambi per macchine da caffè		

	1		
codice	417033	cod. costr.	04995.2.00.08
descrizione	resistenza 3200W 230V Nr. spirali 2 L 415mm lar. 44mm H 25mm int. dei fori 68mm fori ø 6.5mm tubo ø 8.5mm L1 35mm L2 50mm L3 330mm attacco M3x0,6 fissaggio a 2 fori resistenza ad immersione		

	1		
codice	417095	cod. costr.	01834.2.00.08
descrizione	resistenza 3500W 230V Nr. spirali 2 incasso ø 39mm int. dei fori 57mm L 330mm lar. 34mm H 53mm L1 30mm L2 70mm L3 225mm H1 24mm H2 29mm spire 2 fori ø 11mm tubo ø 8.3mm attacco M6 resistenza ad immersione flangia a 3 fori		
accessori per	417095		
	codice	528013	cod. costr. —
	guarnizione int. ø 40mm fibra spessore 4mm fori ø 11mm int. dei fori 57mm per resistenza ricambi per macchine da caffè		
	codice	528740	cod. costr. 00819.0.00.02
	guarnizione int. ø 44mm PTFE spessore 3.5mm fori ø 9.5mm int. dei fori 58mm adattabile a ITALCREM, VISACREM per resistenza ricambi per macchine da caffè		

			
codice	417446	cod. costr.	00616.2.00.08
descrizione	resistenza 4000W 230V Nr. spirali 2 incasso ø 38.5mm int. dei fori 57mm L 342mm lar. 26mm H 51mm L1 35mm L2 50mm L3 257mm H1 25mm H2 26mm spire 2 fori ø 10mm tubo ø 8mm attacco M6 resistenza ad immersione flangia a 3 fori		
Per modelli:	100, 105, 105SL, 205, 205-Exclusive, Century, Century-Restyling, DeCurtis-CAMME, DeCurtis-DIG, DeCurtis-LEVA, Firenze, Firenze-SL, Firenze-SL-Raised, PORTOFINO, Portofino-Restyling		
accessori per	417446		
	codice	cod. costr.	
	528740	00819.0.00.02	
	guarnizione int. ø 44mm PTFE spessore 3.5mm fori ø 9.5mm int. dei fori 58mm adattabile a ITALCREM, VISACREM per resistenza ricambi per macchine da caffè		

			
codice	417213	cod. costr.	00617.2.00.08
descrizione	resistenza 4000W 230V Nr. spirali 2 incasso ø 40mm int. dei fori 57mm L 485mm lar. 25mm H 53mm L1 30mm L2 60mm L3 385mm H1 24mm H2 29mm spire 2 fori ø 10mm tubo ø 8mm attacco M6 resistenza ad immersione flangia a 3 fori adattabile a BRASILIA, VIBIEMME		
Per modelli:	105, 105SL, 205, Century, Firenze		

			
codice	417086	cod. costr.	04996.2.00.08
descrizione	resistenza 4200W 230V Nr. spirali 2 L 535mm lar. 44mm H 23mm int. dei fori 69mm fori ø 6.5mm tubo ø 8.5mm L1 30mm L2 40mm L3 465mm attacco 1/8" fissaggio a 2 fori resistenza ad immersione H1 13mm H2 10mm		

			
codice	417282	cod. costr.	01835.2.00.08
descrizione	resistenza 5000W 230V Nr. spirali 2 incasso ø 40mm int. dei fori 58mm L 460mm lar. 25mm H 54mm L1 40mm L2 70mm L3 350mm H1 24mm H2 30mm spire 2 fori ø 1mm tubo ø 8.3mm attacco M6 resistenza ad immersione flangia a 3 fori		
Per modelli:	205, 205-Exclusive, Agile, Cadetta, Century, Century-Restyling, DeCurtis-CAMME, DeCurtis-DIG, DeCurtis-LEVA, Excelsior-OR, Excelsior-Standard, Executive, Gradisca, Gradisca-Restyling, Gradisca-Take-Away, Maior, Maior-OR, Maior-Plus, Opus, Opus-B03-OR, Opus-OR, Opus-Sublima, Portofino-Restyling, Roma, Roma-OR, Roma-OR-170		

			
codice	417172	cod. costr.	05391.2.00.08
descrizione	resistenza 5500W 230/400V Nr. spirali 3 incasso ø 40mm int. dei fori 57mm L 460mm lar. 39mm H 58mm L1 35mm L2 65mm L3 360mm H1 28mm H2 30mm spire 3 fori ø 10mm tubo ø 8.5mm attacco M3 resistenza ad immersione flangia a 3 fori adattabile a BRASILIA		
Per modelli:	205, Century-Restyling, Executive, Gradisca, Gradisca-Restyling, Gradisca-Take-Away, Maior, Maior-OR, Maior-Plus, Portofino-Restyling, Roma, Roma-OR, Roma-OR-170		
accessori per	417172		
	codice	cod. costr.	
	527169	01263.0.00.03	
	dado esagonale filetto M3 H 2.8mm CH 5.5 ottone conf. 1 pz		
	codice	cod. costr.	
	560110	—	
	rondella di spessore int. ø 3.2mm ø est. 7mm spessore 0.5mm inox conf. 20 pz DIN 125A per filettatura M3		

accessori per	417172		
	codice	cod. costr.	
	560130	—	
	dado esagonale filetto M3 H 2.4mm CH 5.5 inox DIN/ISO DIN 934 / ISO 4032/8673 conf. 20 pz		

termostati

termostati a contatto

termostati di sicurezza a contatto

			
codice	390370	cod. costr.	12571.2.00.08
descrizione	termostato di sicurezza a contatto int. dei forimm temp. intervento 145°C 1NC 1 poli 16A attacco F6,3 M4		
Per modelli:	205-Exclusive, Bolero, Excelsior-OR, Excelsior-Standard, Gradisca-Restyling, Opus, Opus-B03-OR, Opus-OR		

			
codice	390372	cod. costr.	08703.2.00.08
descrizione	termostato di sicurezza a contatto int. dei forimm temp. intervento 165°C 1NC 1 poli 16A attacco F6,3 M4		
Per modelli:	CAPPUCCINO, CLUB, CP1, CP2, LADY, MBM GOLF, MINIPODS, OFFICE RB2, Opus-Sublima, RB1, RB2, SECS, TOP CLASS		

termostati a contatto

			
codice	390322	cod. costr.	09415.2.00.08
descrizione	termostato a contatto int. dei forimm temp. intervento 100°C 1NC 1 poli 16A attacco F6,3 M4		
Per modelli:	CLUB, LADY, MBM GOLF		

			
codice	390152	cod. costr.	08701.2.00.08
descrizione	termostato a contatto int. dei forimm temp. intervento 107°C 1NC 1 poli 16A attacco F6,3 M4		
Per modelli:	CLUB, LADY, MBM GOLF, SECS, TOP CLASS		

			
codice	375160	cod. costr.	10157.2.00.08
descrizione	termostato a contatto int. dei forimm temp. intervento 110°C 1NC 1 poli 16A attacco F6,3 M4		
Per modelli:	Bolero, CLUB, LADY, MBM GOLF		



			
1			
codice	390129	cod. costr.	06525.2.00.08
descrizione	termostato a contatto int. dei forimm temp. intervento 125°C 1NC 1 poli 16A attacco F6,3 M4		
Per modelli:	MINIPODS		

			
1			
codice	390323	cod. costr.	08702.2.00.08
descrizione	termostato a contatto int. dei forimm temp. intervento 145°C 1NC 1 poli 16A attacco F6,3 M4		
Per modelli:	CLUB, LADY, MBM GOLF		

			
1			
codice	390128	cod. costr.	06524.2.00.08
descrizione	termostato a contatto int. dei forimm temp. intervento 95°C 1NC 1 poli 16A attacco F6,3 M4		
Per modelli:	MINIPODS, TOP CLASS		

termostati di regolazione e di sicurezza

varie



termostati di regolazione

			
1			
codice	390114	cod. costr.	00651.4.00.08
descrizione	termostato t. mass. 110°C campo di lavoro fisso 110°C 1 poli		
Per modelli:	CLUB, LADY, TOP CLASS		

interruttori e pulsanti

interruttori/pulsanti basculanti

19x13mm

			
1			
codice	301068 ¹	cod. costr.	20050.2.00.08
descrizione	interruttore basculante dimensioni di montaggio 19x13mm giallo 2NO 250V 13A luminoso 0-I attacco Faston maschio 4,8mm protezione IP40		
Per modelli:	Excelsior-OR, Excelsior-Standard		
accessori per	301068		
	codice	301064	cod. costr. —
	copristato per pulsante dimensione esterna 23,4x17,4mm dimensione interna 19x13mm H 7.5mm trasparente dimensioni di montaggiomm		

¹luminoso

28x13,5mm			
			
1			
codice	346143	cod. costr.	01919.0.00.08
descrizione	interruttore basculante dimensioni di montaggio 27,4x12,4mm bianco 1NO 250V 10A 0-I attacco Faston maschio 6,3mm temperatura ambiente max. 85°C protezione IP40		
Per modelli:	BFD		

30x22mm			
			
1			
codice	301060	cod. costr.	08474.2.00.08
descrizione	interruttore basculante dimensioni di montaggio 30x22mm rosso 2NO 250V 16A luminoso attacco Faston maschio 6,3mm temperatura ambiente max. 125/55°C protezione IP40		
Per modelli:	Bolero, Maior, Maior-OR, Maior-Plus, Roma, Roma-OR, Roma-OR-170		

			
1			
codice	346047	cod. costr.	07545.2.00.08
descrizione	interruttore basculante dimensioni di montaggio 30x22mm rosso 2NO 250V 16A luminoso saetta attacco Faston maschio 6,3mm temperatura ambiente max. 125/55°C protezione IP40		
Per modelli:	MINIPODS		

			
1			
codice	346049	cod. costr.	06534.2.00.08
descrizione	interruttore basculante dimensioni di montaggio 30x22mm rosso 2NO 250V 16A luminoso tazza attacco Faston maschio 6,3mm temperatura ambiente max. 125/55°C protezione IP40		
Per modelli:	MINIPODS		

			
1			
codice	346046	cod. costr.	07547.2.00.08
descrizione	interruttore basculante dimensioni di montaggio 30x22mm rosso 2NO 250V 16A luminoso vapore attacco Faston maschio 6,3mm temperatura ambiente max. 85°C protezione IP40		
Per modelli:	MINIPODS		

			
1			
codice	301076	cod. costr.	07545
descrizione	pulsante basculante dimensioni di montaggio 30x22mm rosso 2NO 250V 16A luminoso START attacco Faston maschio 6,3mm temperatura ambiente max. 125/55°C protezione IP40 incasso ømm Faston maschio 6,3mm		

con simbolo



1

codice	346142	cod. costr.	03632.2.00.08
descrizione	interruttore basculante dimensioni di montaggio 30x22mm arancione 2NO 250V 16A luminoso 0-I attacco Faston maschio 6,3mm temperatura ambiente max. 85°C protezione IP65 con mascherina		
Per modelli:	MAC64, MAC64-On-Demand, MC, RR45-A, RR45-DEL, RR45-On-Demand, RR45-PST, RR45-S, RR45-SILENT, RR55-AE, RR55-On-Demand, RR65-AE, RR65-SE		
accessori per	346142		
	codice	301036	cod. costr. —
	copritasto dimensione interna 30x22mm per interruttore basculante dimensioni di montaggio		

pulsanti e interruttori a pressione

ø25mm



1

codice	346002	cod. costr.	00661.2.00.08
descrizione	pulsante a pressione incasso ø 25mm rosso 2NO 250V 16A attacco Faston maschio 6,3mm temperatura ambiente max. 85°C protezione IP40		
Per modelli:	BELLE EPOQUE JUNIOR, Belle-Epoque, CLUB, MBM GOLF		



1

codice	345151 ¹	cod. costr.	01975.2.00.08
descrizione	interruttore a pressione incasso ø 25mm arancione 2NO 250V 16A luminoso attacco Faston maschio 6,3mm temperatura ambiente max. 85°C protezione IP40		
Per modelli:	100, 105, 105SL, 205, 205-Exclusive, Cadetta, CAPPUCCINO, Century, Century-Restyling, Executive, Firenze, Firenze-SL, Firenze-SL-Raised, Gradisca, Gradisca-Restyling, Gradisca-Take-Away, Maior, Maior-OR, Maior-Plus, MILLENNIO, PORTOFINO, PORTOFINO AMERICA, Portofino-Restyling, Roma, Roma-Cappuccino, Roma-OR, Roma-OR-170, SECS, TOP CLASS		

¹luminoso

1

codice	345155	cod. costr.	00745.2.00.08
descrizione	interruttore a pressione incasso ø 25mm rosso 2NO 250V 16A luminoso attacco Faston maschio 6,3mm temperatura ambiente max. 85°C protezione IP40		
Per modelli:	LADY		



1

codice	345160 ¹	cod. costr.	00663.2.00.08
descrizione	interruttore a pressione incasso ø 25mm rosso 2NO 250V 16A luminoso attacco Faston maschio 6,3mm temperatura ambiente max. 85°C protezione IP40		
Per modelli:	BELLE EPOQUE JUNIOR, CLUB, MBM GOLF		

¹luminoso

1

codice	345153	cod. costr.	00664.2.00.08
descrizione	interruttore a pressione incasso ø 25mm rosso 2NO/lampada 250V 16A attacco Faston maschio 6,3mm temperatura ambiente max. 85°C protezione IP40		
Per modelli:	LADY		



1

codice	345152 ¹	cod. costr.	01976.2.00.08
descrizione	pulsante a pressione incasso ø 25mm arancione 2NO 250V 16A luminoso attacco Faston maschio 6,3mm temperatura ambiente max. 85°C protezione IP40		
Per modelli:	Belle-Epoque, CAPPUCCINO		

¹luminoso

1

codice	346003	cod. costr.	00660.2.00.08
descrizione	pulsante a pressione incasso ø 25mm rosso 1NO/lampada 250V 16A luminoso attacco Faston maschio 6,3mm temperatura ambiente max. 85°C protezione IP65		
Per modelli:	BELLE EPOQUE JUNIOR, CLUB, MBM GOLF		

microinterruttori

azionamento a leva con rotella

microinterruttori



1

codice	346137	cod. costr.	10275.2.00.08
descrizione	microinterruttore con leva a rullo 250V 5A 1CO attacco contatti a stagnare L 14mm L1 16.5mm temperatura ambiente max. 125°C interasse di fissaggio 9mm tipo SS-5GL2 forza di azionamento: 20g nero lunghezza leva 18mm		
Per modelli:	CP1, CP2, OFFICE RB2		



azionamento a perno



			
1			
codice	345105	cod. costr.	00751.2.00.08
descrizione	microinterruttore con perno 250V 16A 1CO attacco Faston maschio 6,3mm L 28mm temperatura ambiente max. 125°C interasse di fissaggio 22mm tipo SM-51 forza di azionamento: 280g nero		
Per modelli:	MC, RR45-A, RR45-DEL, RR45-S, RR45-SILENT, RR55-AE, RR65-AE		

con pulsante

interruttori con fissaggio ad incastro

			
1			
codice	346139	cod. costr.	10151.2.00.08
descrizione	microinterruttore con perno attacco Faston maschio		

interruttori sistema ROLD

			
1			
codice	347192	cod. costr.	18535.2.00.08
descrizione	elemento di commutazione 2NO 250V 16A attacco Faston maschio 6,3mm		
Per modelli:	Agile, Cadetta, Opus, Opus-B03-OR, Opus-OR, Opus-Sublima		
accessori per	347192		
	codice	347183	cod. costr. —
	tasto incasso ø 14,3mm materiale cromato		

commutatori a rotazione

BREMAS

serie A1700

			
1			
codice	346397	cod. costr.	17213.2.00.08
descrizione	commutatore a rotazione 3 0-1-2 gruppi di contatti 6 tipo CA020V200 400V 20A alb. ø 5x5mm alb. L 23mm alberino quadrato attacco a vite		
Per modelli:	Roma, Roma-OR, Roma-OR-170		
accessori per	346397		
	codice	110619	cod. costr. —
	manopola interruttore marcatura zero t. mass. °C ø 48mm alb. ø 5x5mm parte piana nero		

accessori

			
1			
codice	346399	cod. costr.	17234.2.00.08
descrizione	protezione di gomma ø 50mm alb. ømm trasparente Hm Lmm		
Per modelli:	Executive, Maior, Maior-OR, Maior-Plus, Roma, Roma-OR, Roma-OR-170		

BRETER

commutatori a rotazione

			
1			
codice	345112	cod. costr.	04991.2.00.08
descrizione	commutatore a rotazione 20A alb. L 38mm asse 5x5mm		
Per modelli:	100, 105, 105SL, 205, 205-Exclusive, CAPPUCCINO, Century-Restyling, DeCurtis-CAMME, DeCurtis-DIG, DeCurtis-LEVA, Firenze, Gradisca, Gradisca-Restyling, Gradisca-Take-Away, MILLENNIO, Opus, Opus-B03-OR, Opus-OR, Opus-Sublima, PORTOFINO, PORTOFINO AMERICA, Portofino-Restyling		

accessori

			
1			
codice	111294	cod. costr.	18053.0.00.02
descrizione	manopola alberino 5x5 nero		
Per modelli:	Opus, Opus-B03-OR, Opus-OR, Opus-Sublima		

VM

			
1			
codice	346090	cod. costr.	00675.2.00.08
descrizione	commutatore a rotazione		
Per modelli:	Belle-Epoque, Firenze-SL, Firenze-SL-Raised, Roma, Roma-OR, Roma-OR-170		

			
1			
codice	345111	cod. costr.	00674.2.00.08
descrizione	commutatore a rotazione 16A attacco morsetti a vite 6 poli asse 5x5mm		
Per modelli:	Belle-Epoque, Firenze-SL, Firenze-SL-Raised, Roma, Roma-OR, Roma-OR-170		

varie



1

codice	400034	cod. costr.	01814.2.00.08
descrizione	commutatore a rotazione 6 posizioni di comando attacco Faston maschio		
Per modelli:	Belle-Epoque		

lampade

lampade spia

lampade spia 2 pezzi (gemma più lampada)

gemme

ø10mm (tipo SR-3)



1

codice	359412	cod. costr.	02628.0.00.02
descrizione	gemma giallo		
Per modelli:	105, 105SL, Belle-Epoque, Cadetta, CAPPUCCINO, Century-Restyling, DeCurtis-CAMME, DeCurtis-DIG, DeCurtis-LEVA, Excelsior-OR, Excelsior-Standard, Executive, Firenze-SL, Firenze-SL-Raised, Gradisca-Restyling, Gradisca-Take-Away, Maior, Maior-OR, Maior-Plus, Portofino-Restyling, Roma, Roma-Cappuccino, Roma-OR, Roma-OR-170		



1

codice	359414	cod. costr.	02627.0.00.02
descrizione	gemma portalampe dimensioni di montaggio ø10mm giallo conf. 1 pz		
Per modelli:	105, 105SL, 205-Exclusive, Agile, Belle-Epoque, Bolero, Cadetta, CAPPUCCINO, Century-Restyling, DeCurtis-CAMME, DeCurtis-DIG, DeCurtis-LEVA, Excelsior-OR, Excelsior-Standard, Executive, Firenze-SL, Firenze-SL-Raised, Gradisca-Restyling, Gradisca-Take-Away, LADY, Maior, Maior-OR, Maior-Plus, Opus, Opus-B03-OR, Opus-OR, Opus-Sublima, PORTOFINO, PORTOFINO AM. SUPER, PORTOFINO AMERICA, Portofino-Restyling, Roma, Roma-Cappuccino, Roma-OR, Roma-OR-170, TOP CLASS		

lampade spia per attacco tipo SA / SC / SD / SF / SR



1

codice	359814	cod. costr.	00668.2.00.08
descrizione	lampada spia 230V trasparente attacco cavo 400mm materiale cavo silicone conf. 1 pz		
Per modelli:	105, 105SL, 205-Exclusive, Agile, Belle-Epoque, Bolero, Cadetta, CAPPUCCINO, Century-Restyling, DeCurtis-CAMME, DeCurtis-DIG, DeCurtis-LEVA, Excelsior-OR, Excelsior-Standard, Executive, Firenze-SL, Firenze-SL-Raised, Gradisca-Restyling, Maior, Maior-OR, Maior-Plus, MILLENNIO, Opus, Opus-B03-OR, Opus-OR, Opus-Sublima, PORTOFINO, Portofino-Restyling, Roma, Roma-Cappuccino, Roma-OR, Roma-OR-170		

relè a semiconduttore

CROUZET



1

codice	402294	cod. costr.	19258.2.00.08
descrizione	semiconduttore di potenza CROUZET fasi 1 carico 25A carico 48-660V 90-280 L 58mm lar. 45mm a vite tipo 84137111		
Per modelli:	Excelsior-OR, Excelsior-Standard, Opus, Opus-B03-OR, Opus-OR		

relè

relè di potenza





con contatti maschi

contatto a spina 2,0mm

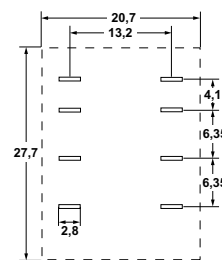

1



codice	380377	cod. costr.	01955.2.00.08	
descrizione	relè di potenza FINDER 220-240VAC 10A 2CO attacco F2 a spina codice costr. 55.32.8.230.0000 94.92.3 250V			
Per modelli:	MAC64, MC			
accessori per	380377			
	codice	380341	cod. costr.	—
	zoccolo di relè 4 poli contatti 12 300V tensione AC 6A Italiana Relè codice costr. ZMD4			
	codice	380378	cod. costr.	—
	zoccolo di relè 2 poli 55/85 dimensioni 70,5x30x27mm 250V tensione AC 10A FINDER codice costr. 94.72			
	codice	380384	cod. costr.	—
	zoccolo di relè 2 poli contatti Faston maschio 2,8mm 250V tensione AC 10A lar. 23mm per			
	codice	380399	cod. costr.	—
	zoccolo di relè 4 poli dimensioni 76,2x27x86,1mm 250V tensione AC 1A FINDER codice costr. 94.94.3			



zoccoli di relè



1

codice	380136	cod. costr.	01920
descrizione	zoccolo di relè 11 poli attacco collegamento a spina rotondo 11 poli dimensioni 65x28x40mm 250V tensione AC 10A Italiana Relè codice costr. ZVE11		
accessori per	380136		
	codice	380805	cod. costr.
	staffa supporto		



1

codice	380137	cod. costr.	01810.2.00.08
descrizione	zoccolo di relè 8 poli attacco collegamento a spina rotondo 8 poli dimensioni 65x28x40mm 380V tensione AC 10A Italiana Relè codice costr. ZVE8		
Per modelli:	100, CAPPUCCINO, Century, Firenze, Gradisca, Gradisca-Take-Away, MILLENNIO, PORTOFINO, PORTOFINO AMERICA		
accessori per	380137		
	codice	380805	cod. costr.
	staffa supporto		

relè livello

GICAR



1

codice	400029	cod. costr.	02259 05441.2.00.08
descrizione	relè di controllo livello 230V tensione AC 11 poli attacco collegamento a spina rotondo 11 poli		



1

codice	400028	cod. costr.	01871.2.00.08
descrizione	relè di controllo livello 230V tensione AC 2NO 8 poli attacco collegamento a spina rotondo 8 poli tipo NRL30/1E-2C/8		
Per modelli:	100, CAPPUCCINO, Century, Firenze, Gradisca, Gradisca-Take-Away, MILLENNIO, PORTOFINO, PORTOFINO AMERICA		

varie



1

codice	400264	cod. costr.	09522.2.00.08
descrizione	relè di controllo livello 230V		
Per modelli:	100, 105, 105SL, 205, 205-Exclusive, Cadetta, CAPPUCCINO, Century, Century-Restyling, DeCurtis-CAMME, DeCurtis-DIG, DeCurtis-LEVA, Executive, Firenze, Firenze-SL, Firenze-SL-Raised, Gradisca, Gradisca-Take-Away, Maior, Maior-OR, Maior-Plus, MILLENNIO, PORTOFINO, Portofino-Restyling, Roma, Roma-OR, Roma-OR-170		



1

codice	400265	cod. costr.	09948.2.00.08
descrizione	relè di controllo livello 230V tensione AC 3A tipo FE-MBC1G		
Per modelli:	Century, Gradisca, Gradisca-Restyling, Gradisca-Take-Away, PORTOFINO		



1

codice	400310	cod. costr.	01878.2.00.08
descrizione	relè di controllo livello 230V tensione AC attacco Faston maschio 6,3mm tipo SMA		
Per modelli:	BELLE EPOQUE JUNIOR, CLUB, LADY, Opus-Sublima		

sonde

sonde personalizzate dal costruttore

sonde



1			
codice	379452	cod. costr.	20553.2.00.08
descrizione	sonda di temperatura NTC cavo fibra di vetro bulbo -40 a +125°C cavo -50 a +350°C attacco spina filetto 1/4" bulbo ø3,5x20mm lunghezza del cavo 0.24m		
Per modelli:	Opus-Sublima		

elettronica

schede elettroniche



1			
codice	400566	cod. costr.	11242.2.00.08 17034.2.00.08
descrizione	scheda di potenza per dosatore aliment. 230V		
Per modelli:	RR45-A, RR45-DEL		



1			
codice	402977	cod. costr.	13420.2.00.08
descrizione	scheda elettronica per macchine del caffè L 113mm lar. 97mm aliment. 230V a 2 gruppi H 38mm		
Per modelli:	105, 105SL, 205, 205-Exclusive, Century, Century-Restyling, De-Curtis-CAMME, DeCurtis-DIG, DeCurtis-LEVA, Firenze, Firenze-SL, Firenze-SL-Raised, Gradisca, Gradisca-Restyling, Gradisca-Take-Away, Portofino-Restyling		



1			
codice	400268	cod. costr.	10438.2.00.08
descrizione	scheda relè		
Per modelli:	Century, Gradisca, Gradisca-Take-Away, PORTOFINO		



1			
codice	400269	cod. costr.	11738.2.00.08
descrizione	scheda relè		
Per modelli:	Century, Gradisca, Gradisca-Take-Away, PORTOFINO		



1			
codice	400561	cod. costr.	10168.2.00.08
descrizione	tastiera elettronica		
Per modelli:	CP1, CP2, OFFICE RB2, RB1, RB2		

unità centrali



1			
codice	402995	cod. costr.	12744.0.00.02
descrizione	coperchio L 138mm lar. 54mm		
Per modelli:	205-Exclusive, Gradisca-Restyling, Opus, Opus-B03-OR, Opus-OR		



1			
codice	402844	cod. costr.	13377.6.00.09
descrizione	scatola elettronica 3-4 gruppi per macchine del caffè 230V		
Per modelli:	205-Exclusive		



1			
codice	400037	cod. costr.	01805.2.00.08
descrizione	scatola elettronica a 1 gruppo per macchine del caffè 230V tipo Cubik		
Per modelli:	Belle-Epoque, Century, PORTOFINO		



1

codice	400266	cod. costr.	09950.2.00.08
descrizione	scatola elettronica a 2 gruppi per macchine del caffè		
Per modelli:	100, 105, 105SL, 205, Century, Gradisca, Gradisca-Take-Away, MILLENNIO, PORTOFINO		



1

codice	400036	cod. costr.	01806.2.00.08
descrizione	scatola elettronica a 2 gruppi per macchine del caffè 230V		
Per modelli:	Belle-Epoque		



1

codice	402275	cod. costr.	13420.2.00.08 + Stückliste
descrizione	scatola elettronica a 2 gruppi per macchine del caffè 230V		



1

codice	402843	cod. costr.	13376.6.00.09
descrizione	scatola elettronica a 2 gruppi per macchine del caffè 230V		
Per modelli:	205-Exclusive		



1

codice	400283	cod. costr.	01807
descrizione	scatola elettronica a 3 gruppi per macchine del caffè		



1

codice	400267	cod. costr.	09952.2.00.08
descrizione	scatola elettronica a 3 gruppi per macchine del caffè 230V tipo FE-MBC		
Per modelli:	100, 105, 105SL, 205, Century, Gradisca, Gradisca-Take-Away, MILLENNIO, PORTOFINO		



1

codice	400284	cod. costr.	04965.2.00.08
descrizione	scatola elettronica a 3 gruppi per macchine del caffè 230V tipo MBAR 3SFF		
Per modelli:	100, Century, Firenze, Firenze-SL, Firenze-SL-Raised, PORTOFINO		



1

codice	402996	cod. costr.	12743.0.00.02
descrizione	scatola elettronica vuota L 125mm lar. 50mm H 106mm		
Per modelli:	Opus, Opus-B03-OR, Opus-OR		



1

codice	402276	cod. costr.	13421.2.00.08
descrizione	scheda elettronica a 3 gruppi per macchine del caffè 230V		
Per modelli:	105, 105SL, 205, 205-Exclusive, Century, Century-Restyling, De-Curtis-CAMME, DeCurtis-DIG, DeCurtis-LEVA, Firenze, Firenze-SL, Firenze-SL-Raised, Gradisca, Gradisca-Restyling, Gradisca-Take-Away, Portofino-Restyling		



1

codice	402269	cod. costr.	21217.2.00.08
descrizione	scatola elettronica a 2 gruppi 230V 50/60Hz tipo 3d5 2GRCT XLC		
Per modelli:	Cadetta		

elettronica di dosaggio

GICAR



1

codice	402266	cod. costr.	16035.2.00.08
descrizione	scatola elettronica a 2 gruppi 230V 50/60Hz tipo 3d5 2GRCT XLC		
Per modelli:	Executive, Maior, Maior-OR, Maior-Plus, Roma, Roma-OR, Roma-OR-170		



1

codice	402270	cod. costr.	21218.2.00.08
descrizione	scatola elettronica a 3 gruppi 230/240V 50/60Hz tipo 3d5 3GRCT XLC (SC)		
Per modelli:	Cadetta		



1

codice	402267	cod. costr.	16036.2.00.08
descrizione	scatola elettronica a 3 gruppi 230V 50/60Hz tipo 3d5 3GRCT XLC		
Per modelli:	Executive, Maior, Maior-OR, Maior-Plus, Roma, Roma-OR, Roma-OR-170		

tastiere

mascherine frontali



1

codice	400562	cod. costr.	10501.0.00.02
descrizione	targhetta per tastiere		
Per modelli:	CP1, CP2, OFFICE RB2, RB1, RB2		



1

codice	403066	cod. costr.	N/A
descrizione	targhetta per tastiere adattabile a BRASILIA L 82.5mm lar. 55mm tasti 6		



tastiere



1			
codice	400039	cod. costr.	04962.2.00.08
descrizione	tastiera		
Per modelli:	Century		



1			
codice	400271	cod. costr.	10138.2.00.08
descrizione	tastiera		
Per modelli:	105, 105SL, 205		



1			
codice	400286	cod. costr.	05475.2.00.08
descrizione	tastiera		



1			
codice	400287	cod. costr.	06556.2.00.08
descrizione	tastiera		
Per modelli:	PORTOFINO, PORTOFINO AMERICA		



1			
codice	400288	cod. costr.	10135.2.00.08
descrizione	tastiera		



1			
codice	400289	cod. costr.	09954.2.00.08
descrizione	tastiera		
Per modelli:	PORTOFINO		



1			
codice	400291	cod. costr.	10136.2.00.08
descrizione	tastiera		
Per modelli:	Gradisca, Gradisca-Take-Away		
ricambi per	400291		



codice	403066	cod. costr.	N/A
targhetta per tastiere adattabile a BRASILIA L 82.5mm lar. 55mm tasti 6			



1			
codice	400346	cod. costr.	08494.2.00.08
descrizione	tastiera		
Per modelli:	PORTOFINO		

			
1			
codice	400347	cod. costr.	01812.2.00.08
descrizione	tastiera		
accessori per	400347		
	codice	400348	cod. costr.
			01494
	pannello per tastiera		

			
1			
codice	402288	cod. costr.	21494.2.00.08
descrizione	tastiera macchina da caffè Executive tasti 5 materiale cromato L 117mm lar. 45mm		
Per modelli:	Executive		

			
1			
codice	402286	cod. costr.	17578.2.00.08
descrizione	tastiera macchina da caffè ROMA tasti 5 L 87mm lar. 59mm		
Per modelli:	Roma, Roma-OR, Roma-OR-170		

			
1			
codice	400227	cod. costr.	12583.2.00.08
descrizione	tastiera macchina da caffè ROMA tasti 6 L 88mm lar. 60mm		
Per modelli:	Roma, Roma-OR, Roma-OR-170		

			
1			
codice	402295	cod. costr.	19424.2.00.08
descrizione	tastiera tasti 1 materiale cromato L 35mm lar. 25mm		
Per modelli:	Agile		

			
1			
codice	402292	cod. costr.	21493.2.00.08
descrizione	tastiera tasti 5 L 88mm lar. 60mm		
Per modelli:	Maior, Maior-OR, Maior-Plus		

			
1			
codice	402287	cod. costr.	19427.2.00.08
descrizione	tastiera tasti 5 materiale cromato L 117mm lar. 45mm		
Per modelli:	Agile, Cadetta		

			
1			
codice	402280	cod. costr.	13123.4.00.08 13123.4.00.09
descrizione	tastiera tasti 6 L 100mm lar. 90mm		
Per modelli:	205-Exclusive, DeCurtis-CAMME, DeCurtis-DIG, DeCurtis-LEVA, Gradisca-Restyling, Portofino-Restyling		

			
1			
codice	400038	cod. costr.	04961.2.00.08
descrizione	tastiera tasti 6 L 85mm lar. 57mm		
Per modelli:	Century		

accessori

			
1			
codice	400348	cod. costr.	01494
descrizione	pannello per tastiera		



elettrovalvole

elettrovalvole per acqua

in metallo

ASCO

ricambi e accessori

O.R.



codice	371095	cod. costr.	00833.0.00.02
descrizione	O.R. Viton spessore 1.78mm int. ø 6.07mm conf. 1 pz		
Per modelli:	100, 105, 105SL, 205, 205-Exclusive, BELLE EPOQUE JUNIOR, Belle-Epoque, Cadetta, CAPPUCCINO, Century, Century-Restyling, CLUB, DeCurtis-CAMME, DeCurtis-DIG, DeCurtis-LEVA, Excelsior-OR, Excelsior-Standard, Executive, Firenze, Firenze-SL, Firenze-SL-Raised, Gradisca, Gradisca-Restyling, Gradisca-Take-Away, LADY, Maior, Maior-OR, Maior-Plus, MBM GOLF, MILLENNIO, MINIPODS, Opus, Opus-B03-OR, Opus-OR, Opus-Sublima, PORTOFINO, PORTOFINO AM. SUPER, PORTOFINO AMERICA, Portofino-Restyling, Roma-Cappuccino, SECS, TOP CLASS		

LUCIFER

ricambi e accessori

corpi valvola



codice	370061	cod. costr.	BF0201
descrizione	corpo elettrovalvola LUCIFER-PARKER 3-vie cono esterno		

M&M

2-vie

serie B-297



codice	370096	cod. costr.	02269.4.00.08	
descrizione	elettrovalvola 2-vie 230VAC attacco 1/8" L 30mm DN 2.5mm morset- tiera femmina compatto -10 a +130°C M&M serie B-297 tipo bobina 2700 membrane FKM (acqua) p max 5bar p min 0bar			
Per modelli:	Agile, CAPPUCCINO			
ricambi per	370096			
	codice	371022	cod. costr.	—
accessori per	370096			
	codice	371091	cod. costr.	—
accessori per	presa tipo spina DIN 43650B lunghezza del cavommm piccolo			



codice	370167	cod. costr.	10446.4.00.08	
descrizione	elettrovalvola 2-vie 24VDC attacco 1/8" L 30mm DN 1.5mm morset- tiera femmina compatto -10 a +130°C M&M serie B-297 tipo bobina 2250 membrane FKM (acqua) p max 22bar p min 0bar			
Per modelli:	CP2, OFFICE RB2, RB2			
accessori per	370167			
	codice	371091	cod. costr.	—
accessori per	presa tipo spina DIN 43650B lunghezza del cavommm piccolo			

OLAB

elettrovalvole

2-vie



codice	370095	cod. costr.	09436.4.00.08
descrizione	elettrovalvola ottone 2-vie 230VAC L 230mm Olab flangia 20x27mm		
Per modelli:	100, 105, 105SL, 205, 205-Exclusive, Belle-Epoque, Cadetta, CAP- PUCCINO, Century, Century-Restyling, DeCurtis-CAMME, DeCur- tis-DIG, DeCurtis-LEVA, Excelsior-OR, Excelsior-Standard, Executive, Firenze, Firenze-SL, Firenze-SL-Raised, Gradisca, Gradisca-Restyling, Gradisca-Take-Away, Maior, Maior-OR, Maior-Plus, MILLENNIO, Opus, Opus-B03-OR, Opus-OR, Opus-Sublima, PORTOFINO, PORTOFINO AM. SUPER, PORTOFINO AMERICA, Portofino-Restyling, Roma-Cappuccino		

PARKER





3-vie

serie VE-128



codice	370057	cod. costr.	01947.2.00.08 01947.4.00.08	
descrizione	elettrovalvola 3-vie 230VAC corpo cono esterno DN 1.2mm morset- tiera femmina DIN -20° a +140°C PARKER serie VE-128 tipo bobina ZB09 membrane rubino p max 10bar ottone flangia 32x32mm			
Per modelli:	105, 105SL, 205, 205-Exclusive, Agile, Belle-Epoque, CAPPUCCI- NO, Century, Century-Restyling, Excelsior-OR, Excelsior-Standard, Executive, Firenze, Firenze-SL, Firenze-SL-Raised, Maior, Maior-OR, Maior-Plus, MILLENNIO, Opus, Opus-B03-OR, Opus-OR, PORTOFINO, PORTOFINO AM. SUPER, PORTOFINO AMERICA, Portofino-Restyling, Roma, Roma-Cappuccino, Roma-OR, Roma-OR-170, SECS, TOP CLASS			
ricambi per	370057			
	codice	370062	cod. costr.	BF0201 BF0401 BF0501
ricambi per	corpo elettrovalvola PARKER 3-vie cono esterno			

Tabella continua alla prossima pagina

ricambi per	370057		
	codice	371029	cod. costr.
	bobina magnetica PARKER 230VAC 9VA tipo bobina ZB09 alloggiamento ø 14mm H 33mm lar. 34mm P 43mm		
accessori per	370057		
	codice	371090	cod. costr.
	presa tipo spina DIN 43650A a vite		
	codice	371095	cod. costr.
	O.R. Viton spessore 1.78mm int. ø 6.07mm conf. 1 pz		
	codice	371100	cod. costr.
	O.R. silicone spessore 1.78mm int. ø 6.07mm conf. 1 pz		

ricambi e accessori

corpi valvola

	1		
codice	370062	cod. costr.	BF0201 BF0401 BF0501
descrizione	corpo elettrovalvola PARKER 3-vie cono esterno		
accessori per	370062		
	codice	371029	cod. costr.
	bobina magnetica PARKER 230VAC 9VA tipo bobina ZB09 alloggiamento ø 14mm H 33mm lar. 34mm P 43mm		
	codice	371030	cod. costr.
	bobina magnetica 24VDC 12VA tipo bobina ZB12 alloggiamento ø 14mm		
	codice	371033	cod. costr.
	bobina magnetica PARKER 230VAC 9VA tipo bobina YB09 con cavo alloggiamento ø 14mm		
	codice	371036	cod. costr.
	bobina magnetica 24VAC 9VA tipo bobina ZB09 alloggiamento ø 14mm		
	codice	371095	cod. costr.
	O.R. Viton spessore 1.78mm int. ø 6.07mm conf. 1 pz		
	codice	371100	cod. costr.
	O.R. silicone spessore 1.78mm int. ø 6.07mm conf. 1 pz		

SIRAI

2-vie

serie L256N



1

codice	370565	cod. costr.	19895.4.00.08 22988.4.00.08
descrizione	elettrovalvola ottone 2-vie 230VAC entrata 1/8" uscita 1/8" attacco 1/8" L 42mm DN 1.6mm -10 a +90°C SIRAI tipo bobina ZA30A membrane NBR p max 25bar p min 0bar		
Per modelli:	Opus-Sublima		
ricambi per	370565		
	codice	371047	cod. costr.
	bobina magnetica 230VAC 14VA SIRAI tipo bobina ZA30A alloggiamento ø 14mm		

3-vie

serie L334-R



1

codice	370563	cod. costr.	16194.4.00.08
descrizione	elettrovalvola 3-vie DN 1.6mm -10° a +170°C p max 13bar 230V tensione AC flangia 32x32mm		
Per modelli:	105, 105SL, Cadetta, Firenze-SL, Firenze-SL-Raised, Opus-Sublima		

Elettrovalvole - accessori



1

codice	371095	cod. costr.	00833.0.00.02
descrizione	O.R. Viton spessore 1.78mm int. ø 6.07mm conf. 1 pz		
Per modelli:	100, 105, 105SL, 205, 205-Exclusive, BELLE EPOQUE JUNIOR, Belle-Epoque, Cadetta, CAPPUCCINO, Century, Century-Restyling, CLUB, DeCurtis-CAMME, DeCurtis-DIG, DeCurtis-LEVA, Excelsior-OR, Excelsior-Standard, Executive, Firenze, Firenze-SL, Firenze-SL-Raised, Gradisca, Gradisca-Restyling, Gradisca-Take-Away, LADY, Maior, Maior-OR, Maior-Plus, MBM GOLF, MILLENNIO, MINIPODS, Opus, Opus-B03-OR, Opus-OR, Opus-Sublima, PORTOFINO, PORTOFINO AM. SUPER, PORTOFINO AMERICA, Portofino-Restyling, Roma-Cappuccino, SECS, TOP CLASS		

pressostati

per macchine da caffè

ø38mm



1

codice	541155	cod. costr.	09935.2.00.08
descrizione	pressostato ø 38mm campo di pressione 1-2,5bar raccordo di mandata verticale 1/4" 16A 250V ricambi per macchine da caffè attacco 1/8" raccordo di mandata 1/8"		
Per modelli:	CAPPUCCINO		



1

codice	541154	cod. costr.	10598.2.00.08
descrizione	pressostato ø 38mm campo di pressione 2-4bar raccordo di mandata verticale prerogolato 2bar 16A 250V ricambi per macchine da caffè attacco 1/8" raccordo di mandata 1/8"		
Per modelli:	CP1, CP2, OFFICE RB2, RB1, RB2		

varie



1

codice	541021	cod. costr.	00630.4.00.08
descrizione	pressostato campo di pressione regolabile 0,5-1,4bar attacco 1/4" 30A 3 poli tipo P302 ricambi per macchine da caffè SIRAI		
Per modelli:	100, 105, 105SL, 205, 205-Exclusive, Agile, Belle-Epoque, CAPPUCINO, Century, Century-Restyling, DeCurtis-CAMME, DeCurtis-DIG, DeCurtis-LEVA, Executive, Firenze, Firenze-SL, Firenze-SL-Raised, Gradisca, Gradisca-Restyling, Gradisca-Take-Away, Maior, Maior-OR, Maior-Plus, MILLENNIO, Opus, Opus-B03-OR, Opus-OR, Opus-Sublima, PORTOFINO, PORTOFINO AMERICA, Portofino-Restyling, Roma, Roma-Cappuccino, Roma-OR, Roma-OR-170		
accessori per	541021		



codice	550262	cod. costr.	—
---------------	--------	--------------------	---

guarnizione piana rame ø est. 20mm int. ø 14mm spessore 2mm



codice	890100	cod. costr.	—
---------------	--------	--------------------	---

nastro in PTFE rotolo lun. 12m lar. 12mm -200 a +260°C certificato DIN-DVGW, KTW termoresistente, elastico per filettatura fine spessore 0.1mm

elettrodi



1

codice	401254	cod. costr.	18749.4.00.08 18749.8.00.08
descrizione	elettrodo di livello 1/4" lungh. totale 74mm bulbo L 47mm lungh. capillare isolato 41mm PTFE isolato attacco ad angolo, faston 6,3mm acciaio inox ø 2.5mm marcatura S		
Per modelli:	Roma-Cappuccino		

contatori volumetrici e sensori della pressione di flusso

contatori volumetrici

GICAR



1

codice	400255	cod. costr.	08729.2.00.08
descrizione	contatore volumetrico filetto 1/8" acciaio inox con LED a spina certificato NSF		
Per modelli:	100, 105, 105SL, 205, 205-Exclusive, CAPPUCINO, Century, Century-Restyling, Firenze, Firenze-SL, Firenze-SL-Raised, Gradisca, Gradisca-Restyling, Gradisca-Take-Away, MILLENNIO, Opus, Opus-B03-OR, Opus-OR, Opus-Sublima, PORTOFINO, PORTOFINO AMERICA, Roma-Cappuccino, TOP CLASS		

accessori per	400255			
	codice	400256	cod. costr.	09013.0.00.08
spina GICAR per contatore volumetrico				

accessori



1

codice	400256	cod. costr.	09013.0.00.08
descrizione	spina GICAR per contatore volumetrico		
Per modelli:	100, 105, 105SL, 205, CAPPUCINO, MILLENNIO, PORTOFINO, PORTOFINO AMERICA		

VENDING



1

codice	400565	cod. costr.	10264.2.00.08
descrizione	contatore volumetrico tubo ø 6mm plastica a spina certificato NSF DIGMESA		
Per modelli:	CP1, CP2, OFFICE RB2, RB1, RB2		

pompe

pompe di aumento pressione II

motori per pompe

raccordo a fascetta



1

codice	500442	cod. costr.	00600.4.00.08
descrizione	motore RPM tipo 11002708 165W 230V 50/60Hz attacco fascetta condensatore 10µF albero ø 13mm		
Per modelli:	105, 105SL, 205, 205-Exclusive, Agile, Cadetta, Century, Century-Restyling, DeCurtis-CAMME, DeCurtis-DIG, DeCurtis-LEVA, Excelsior-OR, Excelsior-Standard, Executive, Firenze, Gradisca, Gradisca-Restyling, Gradisca-Take-Away, Maior, Maior-OR, Maior-Plus, Opus, Opus-B03-OR, Opus-OR, Opus-Sublima, Portofino-Restyling, Roma, Roma-OR, Roma-OR-170		

teste pompe

FLUID-O-TECH



1

codice	499088	cod. costr.	05399.4.00.08
descrizione	testa pompa PA074 FLUID-O-TECH L 82mm 70l/h attacco 3/8" GAS con by-pass ottone raccordo a fascetta alb. ø 10,8x4,8mm certificato NSF		
Per modelli:	105, 105SL, 205, 205-Exclusive, Belle-Epoque, Century, Century-Restyling, Firenze, Firenze-SL, Firenze-SL-Raised, Gradisca, Gradisca-Restyling, Gradisca-Take-Away, Opus, Opus-B03-OR, Opus-OR, Portofino-Restyling		



1

codice	500064	cod. costr.	04321.4.00.08 04321.4.00.09 15382.4.00.08
descrizione	testa pompa PO204 FLUID-O-TECH L 82mm 200l/h attacco 3/8" GAS con by-pass ottone raccordo a fascetta per macchine del caffè alb. ø 4,8x11mm		
Per modelli:	105, 105SL, 205, 205-Exclusive, Agile, Belle-Epoque, Century, Century-Restyling, Firenze, Firenze-SL, Firenze-SL-Raised, Gradisca, Gradisca-Restyling, Gradisca-Take-Away, Opus, Opus-B03-OR, Opus-OR, Portofino-Restyling, Roma, Roma-OR, Roma-OR-170		
accessori per	500064		
	codice	520126	cod. costr. —
	fascetta per motore/pompa		

ROSSI



1

codice	504238	cod. costr.	00604.4.00.08 21212.4.00.08
descrizione	pompa RF140SO9E ROSSI L 82mm 100l/h attacco 3/8" NPT con by-pass ottone raccordo a fascetta per macchine del caffè alb. ø 4,8x11mm		
Per modelli:	100, 105, 105SL, 205, 205-Exclusive, Belle-Epoque, Century, Century-Restyling, DeCurtis-CAMME, DeCurtis-DIG, DeCurtis-LEVA, Excelsior-OR, Excelsior-Standard, Executive, Firenze, Firenze-SL, Firenze-SL-Raised, Gradisca, Gradisca-Restyling, Gradisca-Take-Away, Maior, Maior-OR, Maior-Plus, MILLENNIO, Opus, Opus-B03-OR, Opus-OR, PORTOFINO, Portofino-Restyling		

pompe a vibrazione



Nessuna immagine disponibile

1

codice	501515	cod. costr.	11723.4.00.08
descrizione	pompa a vibrazione tipo EP8 230/240V 26W 50Hz entrata ø 6 uscita ø 1/8" ULKA		

condensatori e filtri antidisturbo

condensatori di rifasamento

in plastica



1

codice	365014	cod. costr.	01897.2.00.08
descrizione	condensatore di rifasamento capacità 12,5µF 450V tolleranza 5%Hz temperatura ambiente max. -25 a +85°C ø 35mm L 70mm M8 plastica attacco Faston maschio 6,3mm 45S.C3DS.12,5 protezione		
Per modelli:	105, 105SL, 205, 205-Exclusive, Agile, Cadetta, Century, Century-Restyling, DeCurtis-CAMME, DeCurtis-DIG, DeCurtis-LEVA, Excelsior-OR, Excelsior-Standard, Executive, Firenze, Firenze-SL, Firenze-SL-Raised, Gradisca, Gradisca-Restyling, Gradisca-Take-Away, Maior, Maior-OR, Maior-Plus, MC, Opus, Opus-B03-OR, Opus-OR, Opus-Sublima, Portofino-Restyling, Roma, Roma-OR, Roma-OR-170, RR45-A, RR45-DEL, RR45-PST, RR45-S, RR45-SILENT, RR55-AE, RR55-On-Demand, RR65-AE, RR65-SE		



1

codice	365021	cod. costr.	05444.2.00.08 09406.2.00.08
descrizione	condensatore di rifasamento capacità 16µF 425V tolleranza 5% 50/60Hz temperatura ambiente max. -25 a +85°C ø 35mm L 73mm singolo M8 plastica attacco Faston maschio 6,3mm 416.10.99 protezione		
Per modelli:	MAC64, MAC64-On-Demand, RR45-A, RR45-DEL, RR45-On-Demand, RR45-SILENT, RR55-On-Demand		



1

codice	365022	cod. costr.	01962.2.00.08
descrizione	condensatore di rifasamento capacità 40µF 400V tolleranza 5%Hz temperatura ambiente max. -25 a +85°C ø 45mm L 95mm M8 plastica attacco Faston maschio 6,3mm protezione		
Per modelli:	105, 105SL, 205, 205-Exclusive, Agile, Cadetta, Century, Century-Restyling, DeCurtis-CAMME, DeCurtis-DIG, DeCurtis-LEVA, Excelsior-OR, Excelsior-Standard, Executive, Firenze, Firenze-SL, Firenze-SL-Raised, Gradisca, Gradisca-Restyling, Gradisca-Take-Away, Maior, Maior-OR, Maior-Plus, MC, Opus, Opus-B03-OR, Opus-OR, Opus-Sublima, Portofino-Restyling, Roma, Roma-OR, Roma-OR-170, RR55-On-Demand		

elettromagneti



1

codice	370170	cod. costr.	11065.2.00.08
descrizione	elettromagnete aliment. 24V tensione AC 50Hz		
Per modelli:	CP1, CP2, OFFICE RB2, RB1, RB2		

accensioni e termocoppie

interruttori di accensione



1

codice	301076	cod. costr.	07545
descrizione	pulsante basculante dimensioni di montaggio 30x22mm rosso 2NO 250V 16A luminoso START attacco Faston maschio 6,3mm temperatura ambiente max. 125/55°C protezione IP40 incasso ømm Faston maschio 6,3mm		

ricambi per apparecchiature specifiche

per macchine da caffè

portafiltri

portafiltri standard

portafiltro senza beccuccio



1

codice	525984	cod. costr.	N/A
descrizione	portafiltro adattabile a AURORA/BRASILIA/FAEMA senza canna fissaggio ø 82,5mm scarico 3/8" int. ø 62mm altezza cuneo 10,5mm posizione cuneo orizzontale numero di cunei 2 leva dritta		



			
1			
codice	525985	cod. costr.	N/A
descrizione	portafiltro adattabile a BRASILIA senza canna fissaggio ø 80mm scarico 3/8" int. ø 62mm altezza cuneo 8.8mm posizione cuneo diagonale numero di cunei 2 leva dritta		

portafiltri corti			
			
1			
codice	529935	cod. costr.	N/A
descrizione	portafiltro fissaggio ø 80mm scarico 3/8" int. ø 62mm maniglia M12x1,75 altezza cuneo 8.8mm posizione cuneo diagonale numero di cunei 2 leva dritta ottone cromato		

			
1			
codice	529041	cod. costr.	02151.0.00.04 04106.0.00.04
descrizione	portafiltro fissaggio ø 82.5mm scarico 3/8" int. ø 62mm maniglia M12x1,75 altezza cuneo 10.5mm posizione cuneo orizzontale numero di cunei 2 leva dritta ottone cromato		
Per modelli:	100, 105, 105SL, 205, Cadetta, Century-Restyling, DeCurtis-CAMME, DeCurtis-DIG, DeCurtis-LEVA, Excelsior-OR, Excelsior-Standard, Firenze, Gradisca, Gradisca-Restyling, Gradisca-Take-Away, MILLENNIO, Portofino-Restyling		

impugnature			
con filetto maschio			
			
1			
codice	529044	cod. costr.	06355.0.00.02
descrizione	maniglia ø 35mm filetto M12x1,75 lungh. fil. 15mm L 120mm nero		
Per modelli:	105, 105SL, Century-Restyling, Firenze		
accessori per	529044		
	codice	531161	cod. costr.
			—
			
	tappo terminale ø 24.6mm incasso ø 22.1mm H 14mm materiale cromato		

tappi terminali			
			
1			
codice	112022	cod. costr.	06364.0.00.02
descrizione	tappo terminale		
Per modelli:	105, 105SL, 205, Agile, Firenze, Firenze-SL, Firenze-SL-Raised, Gradisca-Restyling, Roma, Roma-Cappuccino, Roma-OR, Roma-OR-170		

viti			
			
1			
codice	112021	cod. costr.	02680.0.00.03
descrizione	vite a testa cilindrica filetto M8 L 45mm lungh. fil. 30mm CH 6 acciaio zincato conf. 1 pz DIN 912/ISO 4762		
Per modelli:	205-Exclusive, Agile, Cadetta, DeCurtis-CAMME, DeCurtis-DIG, DeCurtis-LEVA, Gradisca, Gradisca-Restyling, Opus, Opus-B03-OR, Opus-OR, Opus-Sublima, Portofino-Restyling, Roma, Roma-Cappuccino, Roma-OR, Roma-OR-170		

scarichi			
con filetto 3/8"			
			
1			
codice	529005	cod. costr.	08275.0.00.04
descrizione	beccuccio filetto 3/8" 1 via curvo/corto distanza di scaricomm		

			
1			
codice	529003	cod. costr.	00056.0.10.04
descrizione	beccuccio filetto 3/8" 1 via curvo/lungo distanza di scaricomm lungh. fil. 5mm		
Per modelli:	205-Exclusive, CLUB, Gradisca-Restyling, Gradisca-Take-Away, LADY		

			
1			
codice	529002	cod. costr.	00032.0.10.04
descrizione	beccuccio filetto 3/8" 1 via dritto/corto distanza di scaricomm		
Per modelli:	100, 105, 105SL, 205, Belle-Epoque, Century, Century-Restyling, Firenze, Gradisca, MILLENNIO, PORTOFINO, PORTOFINO AM. SUPER, PORTOFINO AMERICA		

			
1			
codice	529008	cod. costr.	00036.4.00.04
descrizione	beccuccio filetto 3/8" 2 vie curvo distanza di scarico 33mm		
Per modelli:	105, 105SL, Agile, BELLE EPOQUE JUNIOR, CAPPUCCINO, CLUB, Firenze-SL, Firenze-SL-Raised, LADY, MBM GOLF, Roma, Roma-OR, Roma-OR-170		



codice	529007	cod. costr.	00031.4.00.04
descrizione	beccuccio filetto 3/8" 2 vie curvo/corto distanza di scarico 45mm		
Per modelli:	100, 105, 105SL, 205, 205-Exclusive, Belle-Epoque, Century, Century-Restyling, Firenze, Gradisca, Gradisca-Restyling, Gradisca-Take-Away, MILLENNIO, PORTOFINO, PORTOFINO AM. SUPER, PORTOFINO AMERICA		

filtri

per 1 tazza



codice	527631	cod. costr.	N/A
descrizione	filtro caffè ø 70mm incasso ø 60.7mm H 17mm tazza 1 quantità di caffè 8g		



codice	529012	cod. costr.	01702.0.40.01
descrizione	filtro caffè ø 70mm incasso ø 60.8mm H 19.5mm tazza 1 quantità di caffè 6g		
Per modelli:	100, 105, 105SL, 205, 205-Exclusive, Agile, Belle-Epoque, Cadetta, CAPPUCCINO, Century, Century-Restyling, Excelsior-OR, Excelsior-Standard, Executive, Firenze, Firenze-SL, Firenze-SL-Raised, Gradisca, Gradisca-Restyling, Gradisca-Take-Away, Maior, Maior-OR, Maior-Plus, MILLENNIO, Opus, Opus-B03-OR, Opus-OR, PORTOFINO, PORTOFINO AM. SUPER, PORTOFINO AMERICA, Portofino-Restyling, Roma, Roma-Cappuccino, Roma-OR, Roma-OR-170		



codice	529011	cod. costr.	00560.0.40.01
descrizione	filtro caffè ø 70mm incasso ø 60mm H 24.5mm tazza 1 quantità di caffè 7g perforazione ø 0.4mm		
Per modelli:	105, 105SL, 205-Exclusive, Agile, Belle-Epoque, Cadetta, Century, Excelsior-OR, Excelsior-Standard, Gradisca, Gradisca-Restyling, Maior, Maior-OR, Maior-Plus, Opus, Opus-B03-OR, Opus-OR, PORTOFINO, PORTOFINO AM. SUPER, PORTOFINO AMERICA, Portofino-Restyling, Roma, Roma-Cappuccino, Roma-OR, Roma-OR-170		

per 2 tazze



codice	529013	cod. costr.	00561.0.40.01
descrizione	filtro caffè ø 70mm incasso ø 60.5mm H 25.5mm tazza 2 quantità di caffè 14g perforazione ø 0,3x0,3mm quadrato		
Per modelli:	105, 105SL, 205-Exclusive, Agile, BELLE EPOQUE JUNIOR, Belle-Epoque, Cadetta, Century, CLUB, Excelsior-OR, Excelsior-Standard, Gradisca, Gradisca-Restyling, LADY, Maior, Maior-OR, Maior-Plus, MBM GOLF, Opus, Opus-B03-OR, Opus-OR, Opus-Sublima, PORTOFINO, PORTOFINO AM. SUPER, PORTOFINO AMERICA, Roma, Roma-Cappuccino, Roma-OR, Roma-OR-170		



codice	529014	cod. costr.	01703.0.40.01
descrizione	filtro caffè ø 70mm incasso ø 60mm H 21mm tazza 2 quantità di caffè 12g perforazione ø 0.3mm rotondo		
Per modelli:	100, 105, 105SL, 205, 205-Exclusive, Agile, Belle-Epoque, Cadetta, CAPPUCCINO, Century, Century-Restyling, Excelsior-OR, Excelsior-Standard, Executive, Firenze, Firenze-SL, Firenze-SL-Raised, Gradisca, Gradisca-Restyling, Gradisca-Take-Away, Maior, Maior-OR, Maior-Plus, MILLENNIO, Opus, Opus-B03-OR, Opus-OR, Opus-Sublima, PORTOFINO, PORTOFINO AM. SUPER, PORTOFINO AMERICA, Portofino-Restyling, Roma, Roma-Cappuccino, Roma-OR, Roma-OR-170		

filtri ciechi



codice	529023	cod. costr.	00564.0.40.01
descrizione	filtro cieco ø 70mm incasso ø 60mm H 18mm		
Per modelli:	105, 105SL, 205, 205-Exclusive, Agile, Belle-Epoque, Cadetta, Century, Century-Restyling, Excelsior-OR, Excelsior-Standard, Executive, Firenze, Firenze-SL, Firenze-SL-Raised, Gradisca, Gradisca-Restyling, Gradisca-Take-Away, Maior, Maior-OR, Maior-Plus, MILLENNIO, Opus, Opus-B03-OR, Opus-OR, Opus-Sublima, PORTOFINO, PORTOFINO AM. SUPER, PORTOFINO AMERICA, Portofino-Restyling, Roma, Roma-Cappuccino, Roma-OR, Roma-OR-170		

molle portafiltro



codice	531240	cod. costr.	0086200003 0223300003
descrizione	molla portafiltro L 62mm lar. 56.5mm filo ø 1mm portafiltro da espresso conf. 20 pz		



			
codice	531243	cod. costr.	N/A
descrizione	molla portafiltro L 70mm lar. 60mm filo ø 1.3mm portafiltro da espresso conf. 20 pz		

gruppi erogatori

setacci doccetta

con alzatina

			
codice	528417	cod. costr.	04214.0.40.01
descrizione	filtro doccetta ø 58mm H 19mm		
Per modelli:	100, 105, 105SL, 205, 205-Exclusive, Cadetta, Century-Restyling, DeCurtis-CAMME, DeCurtis-DIG, DeCurtis-LEVA, Excelsior-OR, Excelsior-Standard, Executive, Firenze, Gradisca, Gradisca-Restyling, Gradisca-Take-Away, Maior, Maior-OR, Maior-Plus, MILLENNIO, Opus, Opus-B03-OR, Opus-OR, Opus-Sublima, Portofino-Restyling		

guarnizioni portafiltro

piane

con intaglio esterno

			
codice	528040	cod. costr.	01393.0.00.02 04408.0.00.02
descrizione	guarnizione portafiltro D1 ø 71mm D2 ø 56.5mm H 8mm con intaglio esterno conf. 1 pz		
Per modelli:	105, 105SL, Agile, Belle-Epoque, CAPPUCCINO, Century, Firenze-SL, Firenze-SL-Raised, PORTOFINO, PORTOFINO AM. SUPER, PORTOFINO AMERICA, Roma, Roma-Cappuccino, Roma-OR, Roma-OR-170		

standard

			
codice	526551	cod. costr.	04367.0.00.02
descrizione	guarnizione portafiltro D1 ø 72.5mm D2 ø 57mm H 8mm conf. 1 pz		
Per modelli:	105, 105SL, 205, 205-Exclusive, Cadetta, Century-Restyling, DeCurtis-CAMME, DeCurtis-DIG, DeCurtis-LEVA, Excelsior-OR, Excelsior-Standard, Executive, Firenze, Gradisca, Gradisca-Restyling, Gradisca-Take-Away, Maior, Maior-OR, Maior-Plus, Opus, Opus-B03-OR, Opus-OR, Opus-Sublima, Portofino-Restyling		

			
codice	526255	cod. costr.	05820.0.00.02
descrizione	guarnizione portafiltro D1 ø 73.6mm D2 ø 58mm H 8.5mm conf. 1 pz		
Per modelli:	Belle-Epoque, Century, Firenze-SL, Firenze-SL-Raised		

con cono

			
codice	528067	cod. costr.	N/A
descrizione	guarnizione portafiltro con cono D1 ø 67mm D2 ø 56.5mm H1 6.4mm H2 4mm conf. 1 pz		

rondelli di guarnizione

			
codice	531251	cod. costr.	—
descrizione	rondella di guarnizione D1 ø 66mm D2 ø 58mm spessore 0.8mm carta conf. 20 pz		

			
codice	528033	cod. costr.	04371.0.00.02
descrizione	rondella di guarnizione D1 ø 71mm D2 ø 58mm spessore 0.8mm carta conf. 1 pz		
Per modelli:	Belle-Epoque, Century, Firenze-SL, Firenze-SL-Raised, PORTOFINO, PORTOFINO AM. SUPER, PORTOFINO AMERICA		

			
codice	528050	cod. costr.	04368.0.00.02
descrizione	rondella di guarnizione D1 ø 73mm D2 ø 59mm spessore 0.5mm carta conf. 1 pz		
Per modelli:	Belle-Epoque, Century, Firenze-SL, Firenze-SL-Raised, PORTOFINO, PORTOFINO AM. SUPER, PORTOFINO AMERICA		



1			
codice	531250	cod. costr.	—
descrizione	rondella di guarnizione D1 ø 73mm D2 ø 59mm spessore 0.5mm carta conf. 20 pz		

gruppi erogatori con elettrovalvola

ugelli



1			
codice	528410	cod. costr.	00046.0.00.04
descrizione	ugello fori ø 0.7mm L 8.5mm filetto M5x0,75 lungh. fil. 4.5mm spessore testa 4mm ottone		
Per modelli:	100, 105, 105SL, 205, Belle-Epoque, Cadetta, CAPPUCCINO, Century, Firenze, Firenze-SL, Firenze-SL-Raised, Gradisca, Gradisca-Restyling, Gradisca-Take-Away, Maior, Maior-OR, Maior-Plus, MILLENNIO, PORTOFINO, PORTOFINO AM. SUPER, PORTOFINO AMERICA, Roma, Roma-Cappuccino, Roma-OR, Roma-OR-170		



1			
codice	526595	cod. costr.	19702.0.00.04
descrizione	ugello fori ø 1mm L 8.5mm filetto M5x0,8 lungh. fil. 4.5mm spessore testa 4mm ottone		
Per modelli:	Agile		

componenti



1			
codice	526566	cod. costr.	12860.4.10.09
descrizione	tubo di scarico 1/8" L 35mm CH 22		
Per modelli:	Excelsior-OR, Excelsior-Standard, Portofino-Restyling		

tubi



1			
codice	526569	cod. costr.	09562.2.10.04
descrizione	tubo di scarico ø 6mm int. ø 4mm F1: 1/8" materiale cromato		
Per modelli:	DeCurtis-CAMME, DeCurtis-DIG, DeCurtis-LEVA, Gradisca, Gradisca-Restyling, Gradisca-Take-Away		

raccordi filettati



1			
codice	526708	cod. costr.	03460.0.10.04
descrizione	tappo filetto 1/8" L 8.5mm ottone cromato		
Per modelli:	105, 105SL, Agile, Cadetta, Century, Firenze-SL, Firenze-SL-Raised, Maior, Maior-OR, Maior-Plus, Roma, Roma-OR, Roma-OR-170		

gruppi erogatori manuali

componenti

unità scarico

valvole di scarico



1			
codice	526002	cod. costr.	09451.4.00.09
descrizione	supporto valvola ø 16mm L 27mm ottone alberino triangolare D1 ø 10mm D2 ø 7mm		
Per modelli:	DeCurtis-CAMME, DeCurtis-DIG, DeCurtis-LEVA, Gradisca		

portaugelli



1			
codice	526783	cod. costr.	12790.0.10.04
descrizione	portaugello filetto M30x1,5 F M16x1,5 F 1 M8 ø 26mm ø int. 1 15mm ø int. 2 17.5mm L 66.5mm lungh. totale 82mm CH 36 ottone cromato		
Per modelli:	205-Exclusive, Century-Restyling, DeCurtis-CAMME, DeCurtis-DIG, DeCurtis-LEVA, Excelsior-OR, Excelsior-Standard, Executive, Gradisca, Maior, Maior-OR, Maior-Plus, Opus, Opus-B03-OR, Opus-OR, Portofino-Restyling		

alberi a camme





1			
codice	527940	cod. costr.	09320.0.00.04
descrizione	albero a camme albero ø 8mm sede albero ø 6.2mm L 86.5mm lar. 20mm H 17mm filetto M6 ottone		
Per modelli:	DeCurtis-CAMME, DeCurtis-DIG, DeCurtis-LEVA, Gradisca		



valvole			
			
1			
codice	526007	cod. costr.	09452.4.00.09
descrizione	valvola gruppo carico L 52.8mm ø est. 16mm alberino triangolare		
Per modelli:	DeCurtis-CAMME, DeCurtis-DIG, DeCurtis-LEVA, Gradisca		

			
1			
codice	526008	cod. costr.	09453.4.00.09
descrizione	valvola gruppo scarico L 54.3mm ø est. 16mm alb. ø 4.5mm ottone		
Per modelli:	DeCurtis-CAMME, DeCurtis-DIG, DeCurtis-LEVA, Gradisca		
accessori per	526008		
	codice	526003	cod. costr. —
	molla a compressione ø 13.8mm L 54.5mm filo ø 1.5mm spire 10 piletta di scarico		
	codice	532550	cod. costr. —
	O.R. NBR 787/70 spessore 2.62mm int. ø 9.13mm conf. 10 pz		

componenti			
ugelli			
con filettatura			
			
1			
codice	528486	cod. costr.	12792.0.00.04
descrizione	ugello foro ø 0.7mm filetto M6x0,75 L 9mm CH 7		
Per modelli:	205-Exclusive, Century-Restyling, DeCurtis-CAMME, DeCurtis-DIG, DeCurtis-LEVA, Excelsior-OR, Excelsior-Standard, Executive, Gradisca, Maior, Maior-OR, Maior-Plus, Opus, Opus-B03-OR, Opus-OR, Portofino-Restyling		

molle			
			
1			
codice	526561	cod. costr.	12941.0.00.03
descrizione	molla a compressione ø 14.3mm L 21mm filo ø 1.8mm		
Per modelli:	DeCurtis-CAMME, DeCurtis-DIG, DeCurtis-LEVA, Gradisca		

raccordi filettati			
			
1			
codice	528407	cod. costr.	02106.0.00.04 02106.0.11.04
descrizione	tappo filettato		
Per modelli:	100, 105, 105SL, 205, 205-Exclusive, Agile, Cadetta, CAPPUCCINO, Century, Excelsior-OR, Excelsior-Standard, Firenze, Firenze-SL, Firenze-SL-Raised, Gradisca, Gradisca-Restyling, Gradisca-Take-Away, Maior, Maior-OR, Maior-Plus, MILLENNIO, Opus, Opus-B03-OR, Opus-OR, Opus-Sublima, PORTOFINO, PORTOFINO AM. SUPER, PORTOFINO AMERICA, Roma, Roma-Cappuccino, Roma-OR, Roma-OR-170		

distributori d'acqua			
distributori d'acqua			
gruppo 2			
			
1			
codice	529081	cod. costr.	04089.0.00.04
descrizione	distributore d'acqua ø 30mm fori ø 1.5mm H 15mm M M10x1 scanalature 6 2.5mm ottone		
Per modelli:	100, 105, 105SL, 205, 205-Exclusive, Cadetta, Century-Restyling, DeCurtis-CAMME, DeCurtis-DIG, DeCurtis-LEVA, Excelsior-OR, Excelsior-Standard, Executive, Firenze, Gradisca, Gradisca-Restyling, Gradisca-Take-Away, Maior, Maior-OR, Maior-Plus, MILLENNIO, Opus, Opus-B03-OR, Opus-OR, Opus-Sublima, Portofino-Restyling		

gruppo 3			
			
1			
codice	528411	cod. costr.	04087.0.00.04
descrizione	distributore d'acqua ø 55mm H 7mm 6 fori ø 1.2mm fissaggio ø 5.1mm ottone		
Per modelli:	105, 105SL, Belle-Epoque, CAPPUCCINO, Century, Firenze-SL, Firenze-SL-Raised, PORTOFINO, PORTOFINO AM. SUPER, PORTOFINO AMERICA, Roma, Roma-Cappuccino, Roma-OR, Roma-OR-170		

			
1			
codice	528414	cod. costr.	00021.0.00.04
descrizione	distributore d'acqua ø 58mm H 7mm 6 fori ø 1.15mm fissaggio ø 5mm ottone		
Per modelli:	BELLE EPOQUE JUNIOR, CLUB, LADY, MBM GOLF		

valvole di sicurezza			
valvole di sicurezza			
3/8"			
			
1			
codice	529879	cod. costr.	12611.4.00.09
descrizione	valvola di sicurezza attacco 3/8" pressione di lavoro 1.6bar certificato CE 0036 piombare		
Per modelli:	105, 105SL, 205, 205-Exclusive, Agile, Belle-Epoque, Cadetta, Century, Century-Restyling, DeCurtis-CAMME, DeCurtis-DIG, DeCurtis-LEVA, Excelsior-OR, Excelsior-Standard, Executive, Firenze, Firenze-SL, Firenze-SL-Raised, Gradisca, Gradisca-Restyling, Gradisca-Take-Away, Maior, Maior-OR, Maior-Plus, Opus, Opus-B03-OR, Opus-OR, Portofino-Restyling, Roma, Roma-Cappuccino, Roma-OR, Roma-OR-170		



1

codice	529312	cod. costr.	01120.4.00.09
descrizione	valvola di sicurezza attacco 3/8" pressione di lavoro 1.8bar		
Per modelli:	100, 105, 105SL, 205, Belle-Epoque, CAPPUCCINO, Century, Firenze, Gradisca, Gradisca-Take-Away, PORTOFINO, PORTOFINO AM. SUPER, PORTOFINO AMERICA, SECS		



1

codice	529338	cod. costr.	01181.4.00.09
descrizione	valvola di sicurezza attacco 3/8" pressione di lavoro 1.8bar certificato TÜV adattabile a BRASILIA		
Per modelli:	MILLENNIO, PORTOFINO, PORTOFINO AM. SUPER, PORTOFINO AMERICA, TOP CLASS		

valvole ad espansione



1

codice	529337	cod. costr.	12845.4.00.09
descrizione	valvola ad espansione F1: 3/8" M F2: 1/4" M L 48mm		
Per modelli:	DeCurtis-CAMME, DeCurtis-DIG, DeCurtis-LEVA, Firenze-SL, Firenze-SL-Raised, Opus-B03-OR, Opus-Sublima, Roma, Roma-OR, Roma-OR-170		

con attacco per tubi



1

codice	529593	cod. costr.	01182.4.00.09
descrizione	valvola ad espansione F1: 1/4" M tubo ø 8mm L 51mm		
Per modelli:	Belle-Epoque, SECS, TOP CLASS		



1

codice	526587	cod. costr.	13533.4.00.09
descrizione	valvola ad espansione F1: 1/4" M tubo ø 9,5mm L 42mm		
Per modelli:	Agile, Firenze-SL, Firenze-SL-Raised, Roma, Roma-OR, Roma-OR-170		

supporti guarnizioni



1

codice	528245	cod. costr.	00153.0.00.04 18406.0.00.04
descrizione	supporto guarnizione D1 ø 7.5mm int. ø 10.5mm L 14mm ottone		
Per modelli:	100, 105, 105SL, 205, 205-Exclusive, Agile, Belle-Epoque, Cadetta, CAPPUCCINO, Century, Century-Restyling, DeCurtis-CAMME, DeCurtis-DIG, DeCurtis-LEVA, Excelsior-OR, Excelsior-Standard, Executive, Firenze, Firenze-SL, Firenze-SL-Raised, Gradisca, Gradisca-Restyling, Gradisca-Take-Away, Maior, Maior-OR, Maior-Plus, MILLENNIO, Opus, Opus-B03-OR, Opus-OR, Opus-Sublima, PORTOFINO, PORTOFINO AMERICA, Portofino-Restyling		

vaschette di scarico

vaschette di scarico



1

codice	526563	cod. costr.	05933.2.06.01
descrizione	vaschetta di scarico ø 60mm H 30mm tubo ø 10mm		
Per modelli:	Roma-Cappuccino		



1

codice	526564	cod. costr.	08229.0.00.02
descrizione	vaschetta di scarico ø 60mm H 46mm fori ø 20mm tubo ø 10mm		
Per modelli:	105, 105SL, 205, 205-Exclusive, Agile, Belle-Epoque, Cadetta, Century, Century-Restyling, DeCurtis-CAMME, DeCurtis-DIG, DeCurtis-LEVA, Excelsior-OR, Excelsior-Standard, Firenze, Firenze-SL, Firenze-SL-Raised, Gradisca, Gradisca-Restyling, Gradisca-Take-Away, Opus, Opus-B03-OR, Opus-OR, Opus-Sublima, Portofino-Restyling, Roma, Roma-OR, Roma-OR-170		

valvole di pressione

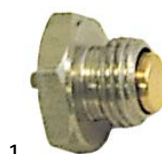

1

codice	529303	cod. costr.	05062.4.00.09
descrizione	valvola antidepressione attacco 1/4" solo vapore		
Per modelli:	100		
ricambi per	529303		
	codice	528687	cod. costr. —
O.R. Viton spessore 1.78mm int. ø 3.69mm conf. 1 pz			



1

codice	529304	cod. costr.	01571.2.00.04
descrizione	valvola antidepressione raccordo 1/4"		
Per modelli:	PORTOFINO AM. SUPER		

boiler			
guarnizioni			
senza fori			
			
1			
codice	528139	cod. costr.	00821.0.00.02
descrizione	guarnizione boiler D1 ø 143mm D2 ø 128mm spessore 3mm graffite adattabile a BRASILIA cod. prod. 00821		
Per modelli:	Century		

accessori			
			
1			
codice	526707	cod. costr.	01246.0.00.03
descrizione	perno filettato per resistenza filetto M8 L 31mm		
Per modelli:	105, 105SL, 205, 205-Exclusive, Cadetta, Century, Century-Restyling, DeCurtis-CAMME, DeCurtis-DIG, DeCurtis-LEVA, Excelsior-OR, Excelsior-Standard, Executive, Firenze, Firenze-SL, Firenze-SL-Raised, Gradisca, Gradisca-Restyling, Gradisca-Take-Away, Maior, Maior-OR, Maior-Plus, Opus, Opus-B03-OR, Opus-OR, Portofino-Restyling		

rubinetti acqua/vapore			
rubinetti acqua/vapore			
rubinetti acqua/vapore			
			
1			
codice	529594	cod. costr.	01169.4.00.09
descrizione	rubinetto per vapore e acqua		
Per modelli:	PORTOFINO		

			
1			
codice	529595	cod. costr.	01153.4.00.09
descrizione	rubinetto per vapore e acqua entrata 1/4" uscita 1/8" adattabile a serie AMERICA		
Per modelli:	105, 105SL, CAPPUCCINO, Firenze-SL, Firenze-SL-Raised		

			
1			
codice	529616	cod. costr.	11927.4.00.09
descrizione	rubinetto per vapore e acqua gomma entrata 1/4" uscita 1/8"		
Per modelli:	105, 105SL, 205, 205-Exclusive, Century, Century-Restyling, Executive, Firenze, Gradisca, Gradisca-Restyling, Gradisca-Take-Away, PORTOFINO, PORTOFINO AM. SUPER, PORTOFINO AMERICA, Portofino-Restyling		

componenti			
alberi			
			
1			
codice	526570	cod. costr.	12046.4.00.09
descrizione	alberino ø 7.8mm D2 ø 17.5mm L 98mm		
Per modelli:	105, 105SL, 205, 205-Exclusive, Century, Century-Restyling, Executive, Firenze, Firenze-SL, Firenze-SL-Raised, Gradisca, Gradisca-Restyling, Gradisca-Take-Away, Portofino-Restyling		

			
1			
codice	526568	cod. costr.	05384.0.00.04
descrizione	alberino per dischi ceramici ø 9mm D2 ø 16mm L 91mm ottone		
Per modelli:	105, 105SL, 205, Century, Firenze, Gradisca, Gradisca-Take-Away		

bussole			
			
1			
codice	529804	cod. costr.	06508.0.00.04
descrizione	boccola		
Per modelli:	205, 205-Exclusive, Agile, Bolero, Cadetta, Excelsior-OR, Excelsior-Standard, Executive, Firenze-SL, Firenze-SL-Raised, Maior, Maior-OR, Maior-Plus, MILLENNIO, OFFICE RB2, Opus, Opus-B03-OR, Opus-OR, Opus-Sublima, PORTOFINO AMERICA, Portofino-Restyling, Roma, Roma-Cappuccino, Roma-OR, Roma-OR-170		

guarnizioni			
			
1			
codice	528244	cod. costr.	00818.0.00.02 18513.0.00.02
descrizione	guarnizione D1 ø 11mm int. ø 4mm spessore 4mm		
Per modelli:	100, 105, 105SL, 205, 205-Exclusive, Agile, Belle-Epoque, Cadetta, CAPPUCCINO, Century, Century-Restyling, DeCurtis-CAMME, DeCurtis-DIG, DeCurtis-LEVA, Excelsior-OR, Excelsior-Standard, Executive, Firenze, Firenze-SL, Firenze-SL-Raised, Gradisca, Gradisca-Restyling, Gradisca-Take-Away, Maior, Maior-OR, Maior-Plus, MILLENNIO, Opus, Opus-B03-OR, Opus-OR, Opus-Sublima, PORTOFINO, PORTOFINO AMERICA, Portofino-Restyling		

			
1			
codice	528280	cod. costr.	01365.0.00.02 16886.0.00.02
descrizione	guarnizione D1 ø 11mm spessore 4mm Viton		
Per modelli:	100, 105, 105SL, 205, Belle-Epoque, CAPPUCCINO, Century, Century-Restyling, DeCurtis-CAMME, DeCurtis-DIG, DeCurtis-LEVA, Firenze, Firenze-SL, Firenze-SL-Raised, Gradisca, Gradisca-Take-Away, MILLENNIO, PORTOFINO, PORTOFINO AM. SUPER, PORTOFINO AMERICA, Portofino-Restyling, Roma-Cappuccino		



1

codice	528283	cod. costr.	12005.0.00.02
descrizione	guarnizione D1 ø 13mm int. ø 4mm spessore 4mm gomma		
Per modelli:	105, 105SL, 205, 205-Exclusive, Century, Century-Restyling, Executive, Firenze, Firenze-SL, Firenze-SL-Raised, Gradisca, Gradisca-Restyling, Gradisca-Take-Away, PORTOFINO, PORTOFINO AM. SUPER, PORTOFINO AMERICA, Portofino-Restyling		



1

codice	526555	cod. costr.	08570.0.00.02
descrizione	guarnizione D1 ø 16mm int. ø 8mm spessore 4mm		
Per modelli:	DeCurtis-CAMME, DeCurtis-DIG, DeCurtis-LEVA, Gradisca		



1

codice	528281	cod. costr.	00825.0.00.02
descrizione	guarnizione D1 ø 6mm spessore 3mm PTFE		
Per modelli:	BELLE EPOQUE JUNIOR, CLUB, LADY, MBM GOLF		

molle



1

codice	529946	cod. costr.	08953.0.00.03
descrizione	molla a compressione ø 14.7mm L 34mm filo ø 2mm		
Per modelli:	DeCurtis-CAMME, DeCurtis-DIG, DeCurtis-LEVA, Gradisca		

corpi del rubinetto



1

codice	526585	cod. costr.	12010.0.00.04
descrizione	corpo del rubinetto F1: 1/8" F2: 1/4" F3: M20x1,5 L 72mm		
Per modelli:	105, 105SL, 205, 205-Exclusive, Century, Century-Restyling, Executive, Firenze, Firenze-SL, Firenze-SL-Raised, Gradisca, Gradisca-Restyling, Gradisca-Take-Away, Portofino-Restyling		

dischi ceramici



1

codice	528274	cod. costr.	05810.0.00.02
descrizione	disco ceramico		
Per modelli:	100, 105, 105SL, 205, Century, Firenze, Gradisca, Gradisca-Take-Away, MILLENNIO, PORTOFINO, PORTOFINO AM. SUPER, PORTOFINO AMERICA		

ghiere



1

codice	528279	cod. costr.	00131.0.12.04
descrizione	ghiera		
Per modelli:	100, 105, 105SL, 205, 205-Exclusive, Century, Century-Restyling, Excelsior-OR, Excelsior-Standard, Executive, Firenze, Firenze-SL, Firenze-SL-Raised, Gradisca, Gradisca-Restyling, Gradisca-Take-Away, MILLENNIO, Opus, Opus-B03-OR, Opus-OR, PORTOFINO, PORTOFINO AM. SUPER, PORTOFINO AMERICA, Portofino-Restyling		



1

codice	528263	cod. costr.	00145.0.00.04 00145.0.14.04
descrizione	ghiera filetto 3/8" int. ø 12.5mm L 21mm CH 22 antracite		
Per modelli:	105, 105SL, Belle-Epoque, CAPPUCCINO		

1

codice	528264	cod. costr.	05363.0.14.04
descrizione	ghiera filetto 3/8" L 22.5mm CH 29 antracite		
Per modelli:	Firenze-SL, Firenze-SL-Raised		

rondelle di spessore



1

codice	528185	cod. costr.	12153.0.00.03
descrizione	disco D1 ø 12mm D2 ø 8.2mm spessore 2mm ottone		
Per modelli:	105, 105SL, 205, 205-Exclusive, Century, Executive, Firenze, Firenze-SL, Firenze-SL-Raised, Gradisca, Gradisca-Restyling, Gradisca-Take-Away, PORTOFINO, PORTOFINO AM. SUPER, PORTOFINO AMERICA, Portofino-Restyling		

raccordi filettati



1

codice	528295	cod. costr.	07202.0.00.04
descrizione	raccordo filettato		
Per modelli:	205, 205-Exclusive, Agile, Bolero, Executive, Firenze-SL, Firenze-SL-Raised, MILLENNIO, OFFICE RB2, Opus-Sublima, PORTOFINO AMERICA, Portofino-Restyling, SECS, TOP CLASS		



1

codice	526584	cod. costr.	05383.0.00.04
descrizione	raccordo filettato F1: 1/2" F2: M25 L 65mm		
Per modelli:	105, 105SL, 205, Century, Firenze, Gradisca, Gradisca-Take-Away		



1

codice	526572	cod. costr.	12013.0.00.04
descrizione	raccordo filettato per rubinetto a vapore L 46mm ø 18mm int. ø 8.5mm CH 24 filetto 1/2"		
Per modelli:	105, 105SL, 205, 205-Exclusive, Century, Century-Restyling, Executive, Firenze, Firenze-SL, Firenze-SL-Raised, Gradisca, Gradisca-Restyling, Gradisca-Take-Away, Portofino-Restyling		

componenti vari



1

codice	528271	cod. costr.	05808.0.00.02
descrizione	boccola		
Per modelli:	100, 105, 105SL, 205, Century, Firenze, Gradisca, Gradisca-Take-Away, MILLENNIO, PORTOFINO, PORTOFINO AM. SUPER, PORTOFINO AMERICA		



1

codice	528275	cod. costr.	05807.0.00.02
descrizione	boccola		
Per modelli:	100, 105, 105SL, 205, Century, Firenze, Gradisca, Gradisca-Take-Away, MILLENNIO, PORTOFINO, PORTOFINO AM. SUPER, PORTOFINO AMERICA		



1

codice	528272	cod. costr.	05811.0.00.02
descrizione	disco		
Per modelli:	100, 105, 105SL, 205, Century, Firenze, Gradisca, Gradisca-Take-Away, MILLENNIO, PORTOFINO, PORTOFINO AM. SUPER, PORTOFINO AMERICA		

tubo per vapore/acqua

tubi per vapore



1

codice	529754	cod. costr.	01599.2.10.04
descrizione	tubo vapore		
Per modelli:	Belle-Epoque		



1

codice	529873	cod. costr.	06512.2.10.04
descrizione	tubo vapore		
Per modelli:	PORTOFINO AMERICA		



1

codice	529758	cod. costr.	11767.2.10.04
descrizione	tubo vapore con snodo sferico/ senza ugello		
Per modelli:	205, Firenze-SL, Firenze-SL-Raised, MILLENNIO		

			
1			
codice	529749	cod. costr.	12060.4.00.09
descrizione	tubo vapore filetto 3/8" L 220mm tubo ø 10mm GRADISCA		
Per modelli:	Gradisca, Gradisca-Restyling, Gradisca-Take-Away		

			
1			
codice	529881	cod. costr.	04657.2.10.04
descrizione	tubo vapore senza ugello		
Per modelli:	Century		

ugelli per tubi per acqua

ugelli per tubi per acqua

			
1			
codice	525095	cod. costr.	04661.0.10.04
descrizione	ugello D1 ø 24mm H 30mm filetto M10x1 ø int. 1.9mm		
Per modelli:	100, 105, 105SL, 205, Cadetta, CAPPUCCINO, Century, Century-Restyling, Firenze, Firenze-SL, Firenze-SL-Raised, Gradisca, Gradisca-Restyling, Gradisca-Take-Away, Maior, Maior-OR, Maior-Plus, MILLENNIO, OFFICE RB2, Opus, Opus-B03-OR, Opus-OR, Opus-Sublima, PORTOFINO, PORTOFINO AM. SUPER, PORTOFINO AMERICA, SECS, TOP CLASS		

componenti

			
1			
codice	529604	cod. costr.	00054.0.00.04
descrizione	parte finale per rompighetti		

rompighetti

			
1			
codice	529608	cod. costr.	05004.4.00.09
descrizione	rompighetto D1 ø 23mm H 15mm filetto M22x1		
Per modelli:	100, 105, 105SL, 205, Cadetta, CAPPUCCINO, Century, Century-Restyling, Firenze, Firenze-SL, Firenze-SL-Raised, Gradisca, Gradisca-Restyling, Gradisca-Take-Away, Maior, Maior-OR, Maior-Plus, MILLENNIO, OFFICE RB2, Opus, Opus-B03-OR, Opus-OR, Opus-Sublima, PORTOFINO, PORTOFINO AM. SUPER, PORTOFINO AMERICA, Roma, Roma-Cappuccino, Roma-OR, Roma-OR-170, SECS, TOP CLASS		

tubi per acqua

			
1			
codice	529597	cod. costr.	00259.2.10.04
descrizione	tubo per acqua		
Per modelli:	CAPPUCCINO, Firenze, PORTOFINO, PORTOFINO AM. SUPER		

			
1			
codice	529888	cod. costr.	04676.2.10.04
descrizione	tubo vapore H 170mm tubo ø 10mm ottone cromato AMERICA		
Per modelli:	105, 105SL		

			
1			
codice	529740	cod. costr.	04676
descrizione	tubo vapore H 180mm tubo ø 10mm ottone cromato		

			
1			
codice	529752	cod. costr.	12062.4.00.09
descrizione	tubo vapore H 200mm		
Per modelli:	105, 105SL, Century-Restyling		

			
1			
codice	529741	cod. costr.	12058.4.00.09
descrizione	tubo vapore H 23.5mm tubo ø 10mm ottone cromato CENTURY		
Per modelli:	Century		

			
1			
codice	529867	cod. costr.	10767.2.10.04
descrizione	tubo vapore senza ugello		
Per modelli:	Gradisca, Gradisca-Take-Away		





			
1			
codice	529600	cod. costr.	01630.2.10.04
descrizione	tubo per acqua		

			
1			
codice	529755	cod. costr.	02533.2.10.04 12061.4.00.09
descrizione	tubo per acqua		
Per modelli:	100, 105, 105SL, PORTOFINO		

			
1			
codice	529874	cod. costr.	02509.2.10.04
descrizione	tubo per acqua		

			
1			
codice	529759	cod. costr.	06511.2.10.04
descrizione	tubo per acqua con snodo sferico		

			
1			
codice	526614	cod. costr.	13519.4.00.09
descrizione	tubo per acqua filetto 3/8" L 75mm CH 22		
Per modelli:	205-Exclusive, Agile, Executive, Portofino-Restyling		

			
1			
codice	529599	cod. costr.	00251 02550 12055.4.00.09
descrizione	tubo per acqua L 120mm ottone cromato		
Per modelli:	CAPPUCCINO, Century-Restyling, Firenze, PORTOFINO, PORTOFINO AM. SUPER		

			
1			
codice	529757	cod. costr.	12059.4.00.09
descrizione	tubo per acqua ø 10mm L 185mm adattabile a GRADISCA		
Per modelli:	Gradisca, Gradisca-Restyling, Gradisca-Take-Away		

			
1			
codice	529817	cod. costr.	06511.2.10.04
descrizione	tubo per acqua ø 10mm L 50mm		
Per modelli:	205, Firenze-SL, Firenze-SL-Raised, MILLENNIO, PORTOFINO AMERICA		

			
1			
codice	529748	cod. costr.	12057.4.00.09
descrizione	tubo per acqua ø 23.5mm L 135mm ottone cromato CENTURY		
Per modelli:	Century		

accessori

bussole

			
1			
codice	528297	cod. costr.	11029.0.00.04
descrizione	boccola		
Per modelli:	Gradisca, Gradisca-Restyling, Gradisca-Take-Away, SECS, TOP CLASS		

guarnizioni

			
1			
codice	528258	cod. costr.	00810.0.00.02
descrizione	guarnizione spessore 1/2,4mm cono esterno		
Per modelli:	100, 105, 105SL, 205, Belle-Epoque, CAPPUCCINO, Century-Restyling, Excelsior-OR, Excelsior-Standard, Firenze, Firenze-SL, Firenze-SL-Raised, Gradisca, Gradisca-Restyling, Gradisca-Take-Away, MILLENNIO, PORTOFINO, PORTOFINO AM. SUPER, Roma-Cappuccino		

			
1			
codice	528259	cod. costr.	01286.0.00.03
descrizione	guarnizione piana int. ø 10mm spessore 1mm		
Per modelli:	100, 105, 105SL, 205, Agile, Belle-Epoque, CAPPUCCINO, Century, Century-Restyling, Excelsior-OR, Excelsior-Standard, Firenze, Firenze-SL, Firenze-SL-Raised, Gradisca, Gradisca-Restyling, Gradisca-Take-Away, MILLENNIO, PORTOFINO, PORTOFINO AM. SUPER, Roma, Roma-Cappuccino, Roma-OR, Roma-OR-170		

			
2			
codice	528231	cod. costr.	00839.0.00.02
descrizione	O.R. Viton spessore 2.62mm int. ø 12.37mm conf. 1 pz		
Per modelli:	100, 105, 105SL, 205, 205-Exclusive, BELLE EPOQUE JUNIOR, CLUB, DeCurtis-CAMME, DeCurtis-DIG, DeCurtis-LEVA, Excelsior-OR, Excelsior-Standard, Gradisca, Gradisca-Restyling, Gradisca-Take-Away, LADY, MBM GOLF, MILLENNIO, Opus, Opus-B03-OR, Opus-OR, Portofino-Restyling		

molle			
			
1			
codice	529704	cod. costr.	07060.0.00.03
descrizione	molla a compressione ø 11.8mm L 16mm filo ø 1.6mm acciaio		
Per modelli:	205, 205-Exclusive, Agile, Bolero, Cadetta, Excelsior-OR, Excelsior-Standard, Executive, Firenze-SL, Firenze-SL-Raised, Gradisca, Gradisca-Restyling, Gradisca-Take-Away, Maior, Maior-OR, Maior-Plus, MILLENNIO, OFFICE RB2, Opus, Opus-OR, Opus-Sublima, PORTOFINO AMERICA, Portofino-Restyling, Roma, Roma-Cappuccino, Roma-OR, Roma-OR-170, SECS, TOP CLASS		

impugnatura tubo			
			
1			
codice	529626	cod. costr.	11972.0.00.02 11972.0.00.04
descrizione	impugnatura tubo		
Per modelli:	205-Exclusive, Cadetta, Gradisca-Restyling, Portofino-Restyling		

			
1			
codice	528625	cod. costr.	15692.0.00.02
descrizione	impugnatura tubo L 35mm gomma int. ø 8mm		
Per modelli:	205-Exclusive, Agile, Cadetta, DeCurtis-CAMME, DeCurtis-DIG, DeCurtis-LEVA, Excelsior-OR, Excelsior-Standard, Executive, Maior, Maior-OR, Maior-Plus, Opus, Opus-B03-OR, Opus-OR, Opus-Sublima, Portofino-Restyling		

rondelle			
			
1			
codice	528268	cod. costr.	00166.0.00.04
descrizione	disco int. ø 5.4mm ø est. 10mm spessore 2mm		
Per modelli:	100, 105, 105SL, 205, 205-Exclusive, Agile, Cadetta, CAPPUCCINO, Century, Century-Restyling, DeCurtis-CAMME, DeCurtis-DIG, DeCurtis-LEVA, Excelsior-OR, Excelsior-Standard, Executive, Firenze, Firenze-SL, Firenze-SL-Raised, Gradisca, Gradisca-Restyling, Gradisca-Take-Away, Maior, Maior-OR, Maior-Plus, MILLENNIO, Opus, Opus-B03-OR, Opus-OR, Opus-Sublima, PORTOFINO, PORTOFINO AMERICA, Portofino-Restyling		

			
1			
codice	529603	cod. costr.	01301.0.00.03
descrizione	rondella di spessore int. ø 17mm ø est. 29.8mm spessore 3mm		
Per modelli:	100, Belle-Epoque		

ghiere			
			
1			
codice	528300	cod. costr.	06509.0.00.04
descrizione	ghiera		
Per modelli:	205, 205-Exclusive, Agile, Bolero, Executive, Firenze-SL, Firenze-SL-Raised, Gradisca, Gradisca-Restyling, Gradisca-Take-Away, Maior, Maior-OR, Maior-Plus, MILLENNIO, OFFICE RB2, Opus-Sublima, PORTOFINO AMERICA, Portofino-Restyling		

microfiltri			
			
1			
codice	528409	cod. costr.	00086.0.00.04
descrizione	microfiltro fibra tubo ø 14mm H 11.5mm		
Per modelli:	100, 105, 105SL, 205, 205-Exclusive, Agile, Belle-Epoque, Cadetta, CAPPUCCINO, Century, Excelsior-OR, Excelsior-Standard, Firenze, Firenze-SL, Firenze-SL-Raised, Gradisca, Gradisca-Restyling, Gradisca-Take-Away, Maior, Maior-OR, Maior-Plus, MILLENNIO, Opus, Opus-B03-OR, Opus-OR, Opus-Sublima, PORTOFINO, PORTOFINO AM. SUPER, PORTOFINO AMERICA, Roma, Roma-Cappuccino, Roma-OR, Roma-OR-170		

			
1			
codice	529979	cod. costr.	12897.0.40.01
descrizione	microfiltro \varnothing 8.8mm H 22mm		
Per modelli:	205-Exclusive, Century-Restyling, DeCurtis-CAMME, DeCurtis-DIG, DeCurtis-LEVA, Excelsior-OR, Excelsior-Standard, Executive, Gradisca, Maior, Maior-OR, Maior-Plus, Opus, Opus-B03-OR, Opus-OR, Portofino-Restyling		

			
1			
codice	528562	cod. costr.	09756.0.00.04
descrizione	microfiltro piano \varnothing 9mm		
Per modelli:	205-Exclusive, Cadetta, Century, Excelsior-OR, Excelsior-Standard, Executive, Gradisca-Restyling, Maior, Maior-OR, Maior-Plus, Opus, Opus-B03-OR, Opus-OR, Opus-Sublima		

valvole di riempimento

valvole di riempimento

			
1			
codice	529590	cod. costr.	02954.6.00.09
descrizione	valvola di riempimento acqua cod. prod. 02954 con elettrovalvola		
Per modelli:	100, 105, 105SL, 205, Century, Century-Restyling, DeCurtis-CAMME, DeCurtis-DIG, DeCurtis-LEVA, Firenze, Firenze-SL, Firenze-SL-Raised, Gradisca, Gradisca-Take-Away, MILLENNIO, PORTOFINO, PORTOFINO AMERICA, Portofino-Restyling		

			
1			
codice	529615	cod. costr.	06267.6.00.09
descrizione	valvola di riempimento acqua cod. prod. 06267 completo tensione AC		
Per modelli:	105, 105SL, Belle-Epoque, CAPPUCCINO, MILLENNIO, PORTOFINO AM. SUPER, PORTOFINO AMERICA		

accessori

guarnizioni

			
1			
codice	527995	cod. costr.	18508.0.00.08 18508.2.00.08
descrizione	guarnizione \varnothing est. 15mm alloggiamento \varnothing 6mm H 5mm H tot. 10mm		

molle

			
1			
codice	526560	cod. costr.	08952.0.00.03
descrizione	molla a compressione \varnothing 14.3mm L 46mm filo \varnothing 1.5mm		
Per modelli:	DeCurtis-CAMME, DeCurtis-DIG, DeCurtis-LEVA, Gradisca		

varie

			
1			
codice	528422	cod. costr.	02227.0.00.03
descrizione	sfera \varnothing 8mm inox		

valvole

			
1			
codice	528247	cod. costr.	00078.0.00.04
descrizione	valvola L 16mm lar. 6mm H 6mm \varnothing est. 12mm ottone		
Per modelli:	100, 105, 105SL, 205, Belle-Epoque, CAPPUCCINO, Century, Century-Restyling, DeCurtis-CAMME, DeCurtis-DIG, DeCurtis-LEVA, Firenze, Firenze-SL, Firenze-SL-Raised, Gradisca, Gradisca-Take-Away, MILLENNIO, PORTOFINO, PORTOFINO AM. SUPER, PORTOFINO AMERICA, Portofino-Restyling, Roma-Cappuccino		

			
1			
codice	528252	cod. costr.	05595.0.00.04
descrizione	valvola L 20mm lar. 6x6mm \varnothing est. 12mm ottone		
Per modelli:	100, 105, 105SL, 205, Belle-Epoque, CAPPUCCINO, Century, Century-Restyling, DeCurtis-CAMME, DeCurtis-DIG, DeCurtis-LEVA, Firenze, Firenze-SL, Firenze-SL-Raised, Gradisca, Gradisca-Take-Away, MILLENNIO, PORTOFINO, PORTOFINO AM. SUPER, PORTOFINO AMERICA, Portofino-Restyling, Roma-Cappuccino		

indicatori livello

indicatori livello

anelli di pressione

			
1			
codice	529396	cod. costr.	00088.0.00.04
descrizione	anello di pressione D1 \varnothing 11.3mm D2 \varnothing 14.6mm spessore 3mm		
Per modelli:	100, 105, 105SL, 205, 205-Exclusive, Agile, Belle-Epoque, Century, Century-Restyling, DeCurtis-CAMME, DeCurtis-DIG, DeCurtis-LEVA, Excelsior-OR, Excelsior-Standard, Firenze, Firenze-SL, Firenze-SL-Raised, Gradisca, Gradisca-Restyling, Gradisca-Take-Away, MILLENNIO, Opus, Opus-B03-OR, Opus-OR, PORTOFINO, PORTOFINO AM. SUPER, PORTOFINO AMERICA, Portofino-Restyling, Roma, Roma-OR, Roma-OR-170		

tappi livello completi



1			
codice	526603	cod. costr.	21161.6.00.09 21161.8.00.09
descrizione	tubo livello acqua con valvola di depressione H 200mm		
Per modelli:	205, 205-Exclusive, Agile, Century, Century-Restyling, Excelsior-OR, Excelsior-Standard, Executive, Firenze, Firenze-SL, Firenze-SL-Raised, Gradisca, Gradisca-Restyling, Gradisca-Take-Away, Maior, Maior-OR, Maior-Plus, Opus, Opus-B03-OR, Opus-OR, Opus-Sublima, Portofino-Restyling, Roma, Roma-OR, Roma-OR-170		

vetro livello



1			
codice	529398	cod. costr.	00787.0.00.02
descrizione	tubo livello acqua ø 11mm H 135mm		
Per modelli:	100, 105, 105SL, 205, 205-Exclusive, Agile, Belle-Epoque, Century, Century-Restyling, DeCurtis-CAMME, DeCurtis-DIG, DeCurtis-LEVA, Excelsior-OR, Excelsior-Standard, Executive, Firenze, Firenze-SL, Firenze-SL-Raised, Gradisca, Gradisca-Restyling, Gradisca-Take-Away, Maior, Maior-OR, Maior-Plus, MILLENNIO, Opus, Opus-B03-OR, Opus-OR, Opus-Sublima, PORTOFINO, PORTOFINO AM. SUPER, PORTOFINO AMERICA, Portofino-Restyling, Roma, Roma-OR, Roma-OR-170		

raccordi filettati

nippli doppi



1			
codice	528294	cod. costr.	10766.0.00.04
descrizione	nipplo doppio F1: 1/8" F2: 3/8" ø int. 1 5mm ø int. 2 12mm L 27mm ottone per tubo vapore		
Per modelli:	Gradisca, Gradisca-Take-Away		

per macinacaffè

macine

macine dritte

standard



1			
codice	527213	cod. costr.	00059.3.00.04
descrizione	coppia macine senso di rotazione sx D1 ø 50mm int. ø 30mm H 8mm dist.denti 2.5mm fori ø 4.5mm foro ø 7.5mm fissaggio ø 40 dritta adattabile a BRASILIA		
Per modelli:	BFD		



1			
codice	526518	cod. costr.	19164.3.00.04
descrizione	coppia macine senso di rotazione sx D1 ø 63.3mm int. ø 38mm H 9mm dist.denti 2.5mm fori ø 5mm foro ø 8.5mm fissaggio ø 50 adattabile a BRASILIA, ROSSI denti 12/60		
Per modelli:	MAC64, MAC64-On-Demand, RR55-On-Demand		



1			
codice	531206	cod. costr.	N/A
descrizione	coppia macine senso di rotazione sx D1 ø 63.3mm int. ø 38mm H 9mm dist.denti 2.5mm fori ø 5mm foro ø 8.5mm fissaggio ø 50 adattabile a BRASILIA, ROSSI denti 16/60		



1			
codice	527202	cod. costr.	00058.2.00.04 00058.3.00.04
descrizione	coppia macine senso di rotazione sx D1 ø 63.3mm int. ø 38mm H 9mm dist.denti 3mm fori ø 5.5mm foro ø 8.5mm fissaggio ø 50 dritta adattabile a BRASILIA, ROSSI cod. prod. 00058/BRASILIA, 4433/ROSSI		
Per modelli:	RR45-A, RR45-DEL, RR45-PST, RR45-S, RR45-SILENT, RR55-AE, RR65-AE, RR65-SE		



1

codice	527215	cod. costr.	N/A
descrizione	coppia macine senso di rotazione sx D1 ø 83mm int. ø 45mm H 10mm dist.denti 3.5mm fori ø 6.5mm foro ø 10.5mm fissaggio ø 65 dritta adattabile a BRASILIA, ROSSI		

macine coniche



1

codice	527200	cod. costr.	11779.3.00.04 11799.3.00.04 17084.3.40.04
descrizione	coppia macine senso di rotazione dx D1 ø 47mm D2 ø 31.5mm H 20mm alb. ø 10mm cod. prod. 11799		
Per modelli:	CP1, CP2, RB1, RB2		



1

codice	527237	cod. costr.	03603.3.00.04
descrizione	coppia macine senso di rotazione dx D1 ø 68mm D2 ø 49mm H 25mm alb. ø 13mm con scanalatura adattabile a ROSSI		
Per modelli:	MC		

supporti rullo macinatore



1

codice	527268	cod. costr.	02077.0.00.04
descrizione	supporto rullo macinatore tipo RR45, CC45 adattabile a ROSSI cod. prod. 4984		
Per modelli:	MAC64, RR45-A, RR45-DEL, RR45-On-Demand, RR45-PST, RR45-S, RR45-SILENT, RR55-AE, RR55-On-Demand, RR65-AE, RR65-SE		

viti



1

codice	560365	cod. costr.	07079.0.00.03 20096.0.00.03
descrizione	vite a testa piatta filetto M4 lungh. fil. 8mm inox DIN 7985/ISO 7045 conf. 1 pz recipiente a croce testa ø 8mm spessore testa 3mm		
Per modelli:	MAC64, MAC64-On-Demand, RR45-A, RR45-DEL, RR45-On-Demand, RR45-PST, RR45-S, RR45-SILENT, RR55-AE, RR55-On-Demand, RR65-AE, RR65-SE		

vaschette per dosatori

coperchi di vasca dosaggio



1

codice	527301	cod. costr.	03191.0.00.02
descrizione	coperchio		
Per modelli:	BFD		



1

codice	527306	cod. costr.	01430.0.00.02
descrizione	coperchio per vasca di dosaggio ø 118mm		
Per modelli:	MC, RR45-A, RR45-DEL, RR45-S, RR45-SILENT, RR55-AE, RR65-AE, RR65-SE		

viti di regolazione



1

codice	527551	cod. costr.	09610.0.00.02
descrizione	vite di regolazione per vasca di dosaggio filetto M8 L 40mm plastica		
Per modelli:	MC, RR45-A, RR45-DEL, RR45-S, RR45-SILENT, RR55-AE, RR65-AE, RR65-SE		

molle

gruppo 1



1

codice	526509	cod. costr.	00897.0.00.03
descrizione	molla a compressione ø 8.5mm L 95mm filo ø 0.8mm dx		
Per modelli:	MAC64, MC, RR45-A, RR45-S, RR45-SILENT, RR55-AE, RR65-AE, RR65-SE		



1

codice	526513	cod. costr.	17684.0.00.03
descrizione	molla a trazione ø 11mm lungh. totale 44mm filo ø 0.9mm L1 35mm per leva		
Per modelli:	MAC64, MC, RR45-A, RR45-S, RR45-SILENT		

cilindri di vetro



1

codice	527305	cod. costr.	01429.0.00.02
descrizione	cilindro di vetro per vasca di dosaggio ø 125mm H 60mm plexiglass		
Per modelli:	MC, RR45-A, RR45-DEL, RR45-S, RR45-SILENT, RR55-AE, RR65-AE, RR65-SE		

pressa caffè

pressa caffè



1

codice	527549	cod. costr.	00797.0.00.02
descrizione	pressacaffè ø 57mm H 98mm plastica		
Per modelli:	MAC64, MAC64-On-Demand, RR45-On-Demand, RR55-On-Demand		

sette pannelli



1

codice	527553	cod. costr.	01772.0.00.01 01772.0.40.01
descrizione	placche di settore inox		
Per modelli:	MC, RR45-A, RR45-DEL, RR45-S, RR45-SILENT, RR55-AE, RR65-AE, RR65-SE		

varie



1

codice	526541	cod. costr.	12472.0.00.01
descrizione	cornice per coperchio L 73.5mm lar. 44mm H 8mm pos. di montaggio inferiore plastica		
Per modelli:	RR45-A, RR45-DEL		

stelle

superiori



1

codice	527552	cod. costr.	01485.0.00.02
descrizione	stella pos. di montaggio superiore ø 112mm H 19mm		
Per modelli:	MC, RR45-A, RR45-DEL, RR45-S, RR45-SILENT, RR55-AE, RR65-AE, RR65-SE		

meccanismo di regolazione

sicura regolazione



1

codice	526536	cod. costr.	01470.0.00.02
descrizione	perno per ghiera di regolazione L 20mm lar. 17mm albero ø 5mm lunghezza albero 26mm		
Per modelli:	RR45-PST, RR45-S, RR55-AE, RR65-AE, RR65-SE		

ghiere di regolazione



1

codice	527402	cod. costr.	11593.0.00.02
descrizione	ghiera di regolazione adattabile a BRASILIA per Office cod. prod. 11593		
Per modelli:	CP1, CP2, OFFICE RB2, RB1, RB2		



1

codice	527400	cod. costr.	10200.0.00.02 20722.0.00.02
descrizione	ghiera di regolazione incasso ø 76mm ø 99mm int. ø 51mm H 34mm adattabile a ROSSI per RR45A cod. prod. 28371		
Per modelli:	RR45-A, RR45-DEL, RR45-On-Demand, RR45-S, RR45-SILENT, RR55-On-Demand		

contenitori per caffè in grani

coperchi di contenitore



1

codice	527327	cod. costr.	N/A
descrizione	coperchio per contenitore per caffè in grani ø 210mm		

contenitori per caffè in grani



1

codice	527355	cod. costr.	13808.4.00.09
descrizione	contenitore completo ø 210mm H 290mm alloggiamento ø 51mm		
Per modelli:	MC, RR65-SE		



1

codice	531179	cod. costr.	N/A
descrizione	contenitore per caffè in grani senza coperchio ø 207mm H 245mm universale		
accessori per	531179		
	codice	527327	cod. costr.
			N/A
	 coperchio per contenitore per caffè in grani ø 210mm		

supporto per portafiltro



1

codice	527891	cod. costr.	00798.0.00.02
descrizione	supporto portafiltro per unità di dosaggio L 71mm lar. 98mm H 25mm plastica		
Per modelli:	RR45-A, RR45-DEL, RR45-On-Demand, RR45-PST, RR45-S, RR45-SILENT		

per macchine automatiche

contenitore d'acqua



1

codice	527309	cod. costr.	10513.0.00.02
descrizione	contenitore per caffè in grani		
Per modelli:	CP1, CP2, OFFICE RB2, RB1, RB2		



1

codice	527307	cod. costr.	10193.0.00.02
descrizione	contenitore dell'acqua adattabile a BRASILIA		
Per modelli:	CP1, CP2, OFFICE RB2, RB1, RB2		



1

codice	527308	cod. costr.	10192.0.00.02
descrizione	coperchio per contenitore acqua		
Per modelli:	CP1, CP2, OFFICE RB2, RB1, RB2		

manopole

manopole personalizzate dal costruttore

BRASILIA



1

codice	111294	cod. costr.	18053.0.00.02
descrizione	manopola alberino 5x5 nero		
Per modelli:	Opus, Opus-B03-OR, Opus-OR, Opus-Sublima		



1

codice	111100	cod. costr.	00772.0.00.02
descrizione	manopola interruttore marcatura zero ø 28mm alb. ø 7mm nero		
Per modelli:	100, 105, 105SL, 205, Belle-Epoque, CLUB, Firenze, MILLENNIO		



1

codice	111774	cod. costr.	17196.0.00.02
descrizione	manopola marcatura zero ø 40mm alb. ø 5x5mm nero		

rubinetti acqua/vapore

segnalini circolari



1

codice	111276	cod. costr.	16885.0.00.02
descrizione	simbolo acqua ø 32mm L 28mm		
Per modelli:	Cadetta, Maior, Maior-OR, Maior-Plus, Roma, Roma-Cappuccino, Roma-OR, Roma-OR-170		



1

codice	111300	cod. costr.	19104.0.00.02
descrizione	simbolo ø 32mm L 28mm		
Per modelli:	Roma, Roma-OR, Roma-OR-170		



1

codice	111275	cod. costr.	16884.0.00.02
descrizione	simbolo vapore ø 32mm L 28mm		
Per modelli:	Cadetta, Maior, Maior-OR, Maior-Plus, Roma, Roma-Cappuccino, Roma-OR, Roma-OR-170		

accessori



1

codice	528762	cod. costr.	12185.0.00.03
descrizione	coppiglia ø 1.8mm L 17mm		
Per modelli:	Maior, Maior-OR, Maior-Plus, MC, Roma, Roma-Cappuccino, Roma-OR, Roma-OR-170, RR45-A, RR45-S, RR45-SILENT, RR55-AE, RR65-AE, RR65-SE		

accessori

adattatori manopole



1

codice	528261	cod. costr.	02088.0.00.04 02088.0.10.04
descrizione	adattatore manopole		
Per modelli:	105, 105SL, Belle-Epoque, CAPPUCCINO		

maniglie e volantini

maniglie a fungo





1

codice	111782	cod. costr.	00781.0.00.02
descrizione	manopola a fungo filetto M6 maniglia ø 25mm L 17mm plastica nero		

pedi e tappi terminali

pedi ad innesto maschio

1			
codice	526537	cod. costr.	18673.0.00.02
descrizione	piede ϕ 29mm H 24mm foro ϕ 5.5mm		
Per modelli:	RR45-A, RR45-DEL, RR45-On-Demand, RR45-S, RR45-SILENT, RR55-On-Demand		

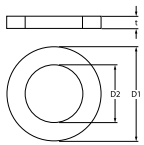
1			
codice	529412	cod. costr.	00838.0.00.02
descrizione	O.R. EPDM spessore 2.62mm int. ϕ 10.78mm conf. 1 pz		
Per modelli:	100, 105, 105SL, 205, 205-Exclusive, Agile, Belle-Epoque, Century, Century-Restyling, DeCurtis-CAMME, DeCurtis-DIG, DeCurtis-LEVA, Excelsior-OR, Excelsior-Standard, Executive, Firenze, Firenze-SL, Firenze-SL-Raised, Gradisca, Gradisca-Restyling, Gradisca-Take-Away, Maior, Maior-OR, Maior-Plus, MILLENNIO, Opus, Opus-B03-OR, Opus-OR, Opus-Sublima, PORTOFINO, PORTOFINO AM. SUPER, PORTOFINO AMERICA, Portofino-Restyling, Roma, Roma-OR, Roma-OR-170		

guarnizioni

O.R.

EPDM

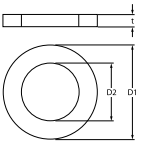
1			
codice	504512	cod. costr.	01389.0.00.02 18511.0.00.02
descrizione	O.R. EPDM spessore 1.78mm int. ϕ 14mm conf. 1 pz		
Per modelli:	100, 105, 105SL, 205, 205-Exclusive, Cadetta, Century, Century-Restyling, DeCurtis-CAMME, DeCurtis-DIG, DeCurtis-LEVA, Excelsior-OR, Excelsior-Standard, Executive, Firenze, Firenze-SL, Firenze-SL-Raised, Gradisca, Gradisca-Restyling, Gradisca-Take-Away, Maior, Maior-OR, Maior-Plus, MILLENNIO, Opus, Opus-B03-OR, Opus-OR, Opus-Sublima, PORTOFINO, PORTOFINO AMERICA, Portofino-Restyling		

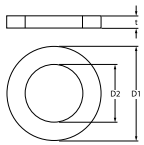
1			
codice	511512	cod. costr.	00800.0.00.02
descrizione	O.R. EPDM spessore 2.62mm int. ϕ 18.72mm conf. 10 pz		
Per modelli:	105, 105SL, 205, 205-Exclusive, Century-Restyling, Excelsior-OR, Excelsior-Standard, Executive, Firenze, Gradisca, Gradisca-Restyling, Gradisca-Take-Away, Maior, Maior-OR, Maior-Plus, Opus, Opus-B03-OR, Opus-OR		

1			
codice	528243	cod. costr.	01390.0.00.02 02107.0.00.04 18512.0.00.02
descrizione	O.R. EPDM spessore 1.78mm int. ϕ 15.6mm conf. 1 pz		
Per modelli:	100, 105, 105SL, 205, 205-Exclusive, Cadetta, Century, Century-Restyling, DeCurtis-CAMME, DeCurtis-DIG, DeCurtis-LEVA, Excelsior-OR, Excelsior-Standard, Executive, Firenze, Firenze-SL, Firenze-SL-Raised, Gradisca, Gradisca-Restyling, Gradisca-Take-Away, Maior, Maior-OR, Maior-Plus, MILLENNIO, Opus, Opus-B03-OR, Opus-OR, Opus-Sublima, PORTOFINO, PORTOFINO AMERICA, Portofino-Restyling		

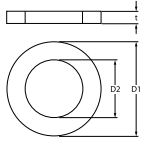
1			
codice	511395	cod. costr.	00843.0.00.02
descrizione	O.R. EPDM spessore 2.62mm int. ϕ 71.12mm conf. 1 pz		
Per modelli:	BELLE EPOQUE JUNIOR, Bolero, CLUB, LADY, MBM GOLF, OFFICE RB2, Opus-Sublima		

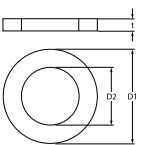
1			
codice	504574	cod. costr.	00851.0.00.02
descrizione	O.R. EPDM spessore 1.78mm int. ϕ 9.25mm conf. 1 pz		
Per modelli:	105, 105SL, Agile, Century, Roma, Roma-Cappuccino, Roma-OR, Roma-OR-170		

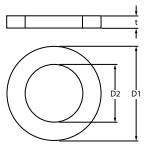
1			
codice	528487	cod. costr.	00837.0.00.02
descrizione	O.R. EPDM spessore 2.62mm int. ϕ 9.19mm conf. 1 pz		
Per modelli:	105, 105SL, 205, 205-Exclusive, Belle-Epoque, Century, Century-Restyling, DeCurtis-CAMME, DeCurtis-DIG, DeCurtis-LEVA, Firenze, Gradisca, Gradisca-Take-Away, Portofino-Restyling		

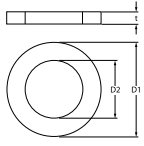
1			
codice	506015	cod. costr.	01368.0.00.02
descrizione	O.R. EPDM spessore 3.53mm int. ϕ 39.69mm conf. 1 pz		
Per modelli:	CAPPUCCINO		

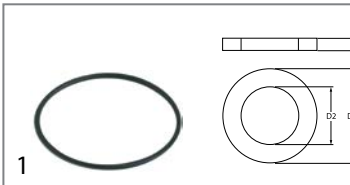

codice	511711	cod. costr.	10179.0.00.02 14117.0.00.02 18330.0.00.02
descrizione	O.R. EPDM spessore 3.53mm int. ø 78.97mm conf. 1 pz		
Per modelli:	205-Exclusive		

silicone

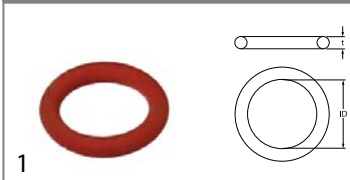

codice	532190	cod. costr.	11970.0.00.02
descrizione	O.R. silicone spessore 1.78mm int. ø 4.48mm conf. 10 pz		
Per modelli:	Gradisca-Take-Away		

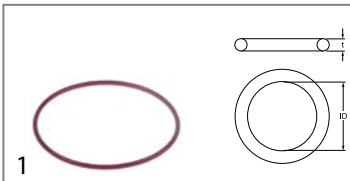

codice	532561	cod. costr.	11428.0.00.02
descrizione	O.R. silicone spessore 2.62mm int. ø 71.12mm conf. 1 pz		
Per modelli:	205-Exclusive, Excelsior-OR, Excelsior-Standard, Gradisca-Restyling, Opus, Opus-B03-OR, Opus-OR		

Viton



codice	528489	cod. costr.	01370.0.00.02
descrizione	O.R. Viton spessore 1.78mm int. ø 12.42mm conf. 1 pz		
Per modelli:	100, 105, 105SL, 205, 205-Exclusive, Agile, Belle-Epoque, Cadetta, Century-Restyling, DeCurtis-CAMME, DeCurtis-DIG, DeCurtis-LEVA, Excelsior-OR, Excelsior-Standard, Executive, Firenze, Firenze-SL, Firenze-SL-Raised, Gradisca, Gradisca-Restyling, Gradisca-Take-Away, Maior, Maior-OR, Maior-Plus, MILLENNIO, OFFICE RB2, Opus-B03-OR, Opus-Sublima, PORTOFINO, PORTOFINO AM. SUPER, PORTOFINO AMERICA, Roma, Roma-OR, Roma-OR-170		

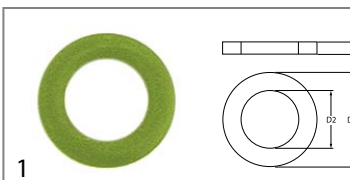

codice	101526	cod. costr.	18509.0.00.02
descrizione	O.R. Viton spessore 1.78mm int. ø 4.48mm conf. 1 pz		
Per modelli:	205-Exclusive, Cadetta, Century, Excelsior-OR, Excelsior-Standard, Executive, Gradisca-Restyling, Maior, Maior-OR, Maior-Plus, Opus, Opus-B03-OR, Opus-OR, Opus-Sublima		



codice	371095	cod. costr.	00833.0.00.02
descrizione	O.R. Viton spessore 1.78mm int. ø 6.07mm conf. 1 pz		
Per modelli:	100, 105, 105SL, 205, 205-Exclusive, BELLE EPOQUE JUNIOR, Belle-Epoque, Cadetta, CAPPUCCINO, Century, Century-Restyling, CLUB, DeCurtis-CAMME, DeCurtis-DIG, DeCurtis-LEVA, Excelsior-OR, Excelsior-Standard, Executive, Firenze, Firenze-SL, Firenze-SL-Raised, Gradisca, Gradisca-Restyling, Gradisca-Take-Away, LADY, Maior, Maior-OR, Maior-Plus, MBM GOLF, MILLENNIO, MINIPODS, Opus, Opus-B03-OR, Opus-OR, Opus-Sublima, PORTOFINO, PORTOFINO AM. SUPER, PORTOFINO AMERICA, Portofino-Restyling, Roma-Cappuccino, SECS, TOP CLASS		

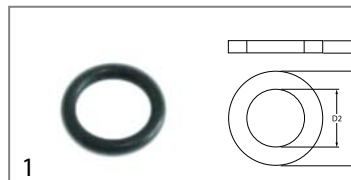

codice	528282	cod. costr.	00835.0.00.02
descrizione	O.R. Viton spessore 1.78mm int. ø 7.66mm conf. 1 pz		
Per modelli:	100, 105, 105SL, 205, BELLE EPOQUE JUNIOR, Century, Century-Restyling, CLUB, DeCurtis-CAMME, DeCurtis-DIG, DeCurtis-LEVA, Firenze-SL, Firenze-SL-Raised, LADY, MBM GOLF, Opus-Sublima, PORTOFINO, Portofino-Restyling		

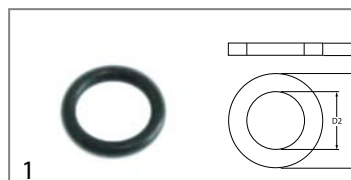

codice	528246	cod. costr.	00836.0.00.02 18510.0.00.02
descrizione	O.R. Viton spessore 1.78mm int. ø 8.73mm conf. 1 pz		
Per modelli:	100, 105, 105SL, 205, 205-Exclusive, Cadetta, Century, Century-Restyling, DeCurtis-CAMME, DeCurtis-DIG, DeCurtis-LEVA, Excelsior-OR, Excelsior-Standard, Executive, Firenze, Firenze-SL, Firenze-SL-Raised, Gradisca, Gradisca-Restyling, Gradisca-Take-Away, Maior, Maior-OR, Maior-Plus, MILLENNIO, Opus, Opus-B03-OR, Opus-OR, Opus-Sublima, PORTOFINO, PORTOFINO AMERICA, Portofino-Restyling		

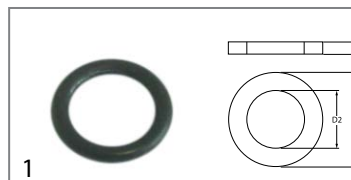

codice	528291	cod. costr.	07001.0.00.02
descrizione	O.R. Viton spessore 2.62mm int. ø 11.91mm conf. 1 pz		
Per modelli:	205, 205-Exclusive, Agile, Bolero, Cadetta, Excelsior-OR, Excelsior-Standard, Executive, Firenze-SL, Firenze-SL-Raised, Gradisca, Gradisca-Restyling, Gradisca-Take-Away, Maior, Maior-OR, Maior-Plus, MILLENNIO, OFFICE RB2, Opus, Opus-B03-OR, Opus-OR, Opus-Sublima, PORTOFINO AMERICA, Portofino-Restyling, Roma, Roma-Cappuccino, Roma-OR, Roma-OR-170, SECS, TOP CLASS		

1			
codice	528231	cod. costr.	00839.0.00.02
descrizione	O.R. Viton spessore 2.62mm int. \varnothing 12.37mm conf. 1 pz		
Per modelli:	100, 105, 105SL, 205, 205-Exclusive, BELLE EPOQUE JUNIOR, CLUB, DeCurtis-CAMME, DeCurtis-DIG, DeCurtis-LEVA, Excelsior-OR, Excelsior-Standard, Gradisca, Gradisca-Restyling, Gradisca-Take-Away, LADY, MBM GOLF, MILLENNIO, Opus, Opus-B03-OR, Opus-OR, Portofino-Restyling		

1			
codice	532456	cod. costr.	18682.0.00.02 18682.0.00.03
descrizione	O.R. Viton spessore 2mm int. \varnothing 16mm conf. 1 pz		
Per modelli:	Agile, Cadetta, Opus-B03-OR		

1			
codice	528647	cod. costr.	00840.0.00.02
descrizione	O.R. Viton spessore 2.62mm int. \varnothing 15.08mm conf. 1 pz		
Per modelli:	105, 105SL, Belle-Epoque, CAPPUCCINO, MILLENNIO, PORTOFINO AM. SUPER, PORTOFINO AMERICA, Roma-Cappuccino		

1			
codice	528240	cod. costr.	01428.0.00.02
descrizione	O.R. Viton spessore 2mm int. \varnothing 4mm conf. 1 pz		
Per modelli:	100, 105, 105SL, 205, Century, Century-Restyling, DeCurtis-CAMME, DeCurtis-DIG, DeCurtis-LEVA, Firenze, Firenze-SL, Firenze-SL-Raised, Gradisca, Gradisca-Take-Away, MILLENNIO, PORTOFINO, PORTOFINO AMERICA, Portofino-Restyling		

1			
codice	528293	cod. costr.	06370.0.00.02
descrizione	O.R. Viton spessore 2.62mm int. \varnothing 15.88mm conf. 1 pz		
Per modelli:	205, 205-Exclusive, Gradisca, Gradisca-Take-Away, Maior, Maior-OR, Maior-Plus, MILLENNIO, PORTOFINO AMERICA, Roma, Roma-Cappuccino, Roma-OR, Roma-OR-170, SECS, TOP CLASS		

1			
codice	528250	cod. costr.	00847.0.00.02
descrizione	O.R. Viton spessore 2mm int. \varnothing 8mm conf. 1 pz		
Per modelli:	105, 105SL, Belle-Epoque, CAPPUCCINO, MILLENNIO, PORTOFINO AM. SUPER, PORTOFINO AMERICA, Roma-Cappuccino		

1			
codice	532560	cod. costr.	12953.0.00.02
descrizione	O.R. Viton spessore 2.62mm int. \varnothing 20.63mm conf. 1 pz		
Per modelli:	DeCurtis-CAMME, DeCurtis-DIG, DeCurtis-LEVA, Gradisca		

1			
codice	528155	cod. costr.	00842.0.00.02
descrizione	O.R. Viton spessore 3.53mm int. \varnothing 32.93mm conf. 1 pz		
Per modelli:	Belle-Epoque		

1			
codice	528413	cod. costr.	03182.0.00.02
descrizione	O.R. Viton spessore 2.62mm int. \varnothing 47.3mm conf. 1 pz		
Per modelli:	105, 105SL, Agile, BELLE EPOQUE JUNIOR, Belle-Epoque, Bolero, CAPPUCCINO, Century, CLUB, LADY, MBM GOLF, PORTOFINO, PORTOFINO AM. SUPER, PORTOFINO AMERICA, Roma, Roma-Cappuccino, Roma-OR, Roma-OR-170		

<h2>anelli di tenuta</h2> <h3>guarnizioni in gomma</h3>			
1			
codice	528254	cod. costr.	00109.0.00.04
descrizione	guarnizione piana \varnothing est. 26mm int. \varnothing 21mm spessore 3mm conf. 1 pz		
Per modelli:	PORTOFINO		

guarnizioni in rame

DIN-7603-A



codice	528233	cod. costr.	01404.0.00.02 21559.0.00.03
descrizione	guarnizione piana rame ø est. 12mm int. ø 8.3mm spessore 1.5mm		
Per modelli:	Agile		



codice	528698	cod. costr.	12152.0.00.03
descrizione	guarnizione piana rame ø est. 24mm int. ø 20mm spessore 1mm		
Per modelli:	105, 105SL, 205, 205-Exclusive, Century, Century-Restyling, Executive, Firenze, Firenze-SL, Firenze-SL-Raised, Gradisca, Gradisca-Restyling, Gradisca-Take-Away, PORTOFINO, PORTOFINO AM. SUPER, PORTOFINO AMERICA, Portofino-Restyling, TOP CLASS		

DIN-7603-C



codice	527164	cod. costr.	01386.0.00.02
descrizione	guarnizione rame ø est. 23mm int. ø 17mm spessore 3mm per filettatura 3/8"		
Per modelli:	100, 105, 105SL, 205, 205-Exclusive, Agile, Belle-Epoque, Cadetta, Century, Century-Restyling, DeCurtis-CAMME, DeCurtis-DIG, DeCurtis-LEVA, Excelsior-OR, Excelsior-Standard, Executive, Firenze, Firenze-SL, Firenze-SL-Raised, Gradisca, Gradisca-Restyling, Gradisca-Take-Away, MILLENNIO, OFFICE RB2, Opus, Opus-B03-OR, Opus-OR, Opus-Sublima, PORTOFINO, PORTOFINO AMERICA, Portofino-Restyling, Roma, Roma-Cappuccino, Roma-OR, Roma-OR-170, SECS, TOP CLASS		

guarnizioni in PTFE



codice	528277	cod. costr.	05809.0.00.02
descrizione	guarnizione PTFE ø est. 15mm int. ø 12.4mm spessore 0.6mm conf. 1 pz		
Per modelli:	100, 105, 105SL, 205, Century, Firenze, Gradisca, Gradisca-Take-Away, MILLENNIO, PORTOFINO, PORTOFINO AM. SUPER, PORTOFINO AMERICA		



codice	526554	cod. costr.	08576.0.00.02
descrizione	guarnizione piana PTFE ø est. 10mm int. ø 6mm spessore 1mm conf. 1 pz		
Per modelli:	DeCurtis-CAMME, DeCurtis-DIG, DeCurtis-LEVA, Gradisca		



codice	526661	cod. costr.	00813.0.00.02
descrizione	guarnizione piana PTFE ø est. 17mm int. ø 13mm spessore 2mm conf. 1 pz		
Per modelli:	100, 105, 105SL, 205, 205-Exclusive, Agile, Belle-Epoque, Century, Century-Restyling, DeCurtis-CAMME, DeCurtis-DIG, DeCurtis-LEVA, Excelsior-OR, Excelsior-Standard, Executive, Firenze, Firenze-SL, Firenze-SL-Raised, Gradisca, Gradisca-Restyling, Gradisca-Take-Away, Maior, Maior-OR, Maior-Plus, MILLENNIO, Opus-B03-OR, Opus-Sublima, PORTOFINO, PORTOFINO AM. SUPER, PORTOFINO AMERICA, Portofino-Restyling, Roma, Roma-OR, Roma-OR-170		



codice	526679	cod. costr.	N/A
descrizione	guarnizione piana PTFE ø est. 18mm int. ø 13mm spessore 2mm conf. 1 pz		



codice	527993	cod. costr.	N/A
descrizione	guarnizione piana PTFE ø est. 18mm int. ø 13mm spessore 2mm conf. 1 pz		



codice	528314	cod. costr.	00820.0.00.02
descrizione	guarnizione piana PTFE ø est. 20mm int. ø 17mm spessore 2mm conf. 1 pz adattabile a Astoria/Azkoyen/Espresso/Wega		
Per modelli:	205-Exclusive, Cadetta, Century, Excelsior-OR, Excelsior-Standard, Executive, Gradisca-Restyling, Maior, Maior-OR, Maior-Plus, Opus, Opus-B03-OR, Opus-OR, Opus-Sublima, Roma-Cappuccino		





codice	527154	cod. costr.	08575.0.00.02
descrizione	guarnizione piana PTFE ø est. 22mm int. ø 16.8mm spessore 2mm conf. 1 pz		
Per modelli:	205-Exclusive, Century-Restyling, DeCurtis-CAMME, DeCurtis-DIG, DeCurtis-LEVA, Excelsior-OR, Excelsior-Standard, Executive, Gradisca, Gradisca-Restyling, Maior, Maior-OR, Maior-Plus, Opus, Opus-B03-OR, Opus-OR, Portofino-Restyling		



codice	528683	cod. costr.	00812.0.00.02
descrizione	guarnizione piana PTFE ø est. 26mm int. ø 21mm spessore 2mm conf. 1 pz adattabile a GAGGIA, SPAZIALE		
Per modelli:	DeCurtis-CAMME, DeCurtis-DIG, DeCurtis-LEVA, Gradisca		



			
1			
codice	526014	cod. costr.	04360.0.00.02
descrizione	guarnizione piana PTFE ø est. 35mm int. ø 30mm spessore 2mm conf. 1 pz		
Per modelli:	105, 105SL, 205, 205-Exclusive, Century-Restyling, DeCurtis-CAMME, DeCurtis-DIG, DeCurtis-LEVA, Excelsior-OR, Excelsior-Standard, Executive, Firenze, Gradisca, Gradisca-Restyling, Gradisca-Take-Away, Maior, Maior-OR, Maior-Plus, Opus, Opus-B03-OR, Opus-OR, Portofino-Restyling		

			
1			
codice	528018	cod. costr.	18661.0.00.02 18661.2.00.02
descrizione	guarnizione piana PTFE ø est. 41mm int. ø 33mm spessore 3mm 1" conf. 1 pz		
Per modelli:	Roma-Cappuccino		

			
1			
codice	528021	cod. costr.	00826.0.00.02 02286
descrizione	guarnizione piana PTFE ø est. 53mm int. ø 42.5mm spessore 3mm conf. 1 pz cod. prod. 12001/02286 adattabile a Astoria/Aurora/Brasilia/Wega		
Per modelli:	Belle-Epoque, DeCurtis-CAMME, DeCurtis-DIG, DeCurtis-LEVA, MILLENNIO, PORTOFINO AM. SUPER, PORTOFINO AMERICA, SECS, TOP CLASS		

guarnizioni speciale

gruppi di guarnizioni

			
1			
codice	528406	cod. costr.	04394.0.00.02
descrizione	guarnizione di gruppo L 79mm lar. 73mm spessore 2mm int. dei fori 55mm adattabile a BRASILIA cod. prod. 04394 fibra		
Per modelli:	100, 105, 105SL, 205, 205-Exclusive, Cadetta, Century-Restyling, DeCurtis-CAMME, DeCurtis-DIG, DeCurtis-LEVA, Excelsior-OR, Excelsior-Standard, Executive, Firenze, Gradisca, Gradisca-Restyling, Gradisca-Take-Away, Maior, Maior-OR, Maior-Plus, MILLENNIO, Opus, Opus-B03-OR, Opus-OR, Portofino-Restyling		

			
1			
codice	528142	cod. costr.	00814.0.00.02
descrizione	guarnizione di gruppo L 76mm lar. 50mm spessore 3mm int. dei fori 60mm adattabile a BEZZERA		
Per modelli:	105, 105SL, Agile, Belle-Epoque, Century, Firenze-SL, Firenze-SL-Raised, PORTOFINO, PORTOFINO AM. SUPER, PORTOFINO AMERICA, Roma, Roma-Cappuccino, Roma-OR, Roma-OR-170		

			
1			
codice	528355	cod. costr.	N/A
descrizione	guarnizione di gruppo L 74mm lar. 74mm spessore 3.5mm adattabile a AZKOYEN		

molle

molle a compressione

			
1			
codice	528237	cod. costr.	00884.0.00.03
descrizione	molla a compressione ø 10.8mm L 29mm filo ø 1.6mm		
Per modelli:	100, 105, 105SL, 205, Belle-Epoque, CAPPUCCINO, Century, Century-Restyling, DeCurtis-CAMME, DeCurtis-DIG, DeCurtis-LEVA, Firenze, Firenze-SL, Firenze-SL-Raised, Gradisca, Gradisca-Take-Away, MILLENNIO, PORTOFINO, PORTOFINO AM. SUPER, PORTOFINO AMERICA, Portofino-Restyling, Roma-Cappuccino		

			
1			
codice	529704	cod. costr.	07060.0.00.03
descrizione	molla a compressione ø 11.8mm L 16mm filo ø 1.6mm acciaio		
Per modelli:	205, 205-Exclusive, Agile, Bolero, Cadetta, Excelsior-OR, Excelsior-Standard, Executive, Firenze-SL, Firenze-SL-Raised, Gradisca, Gradisca-Restyling, Gradisca-Take-Away, Maior, Maior-OR, Maior-Plus, MILLENNIO, OFFICE RB2, Opus, Opus-OR, Opus-Sublima, PORTOFINO AMERICA, Portofino-Restyling, Roma, Roma-Cappuccino, Roma-OR, Roma-OR-170, SECS, TOP CLASS		

			
1			
codice	528284	cod. costr.	10962.0.00.03
descrizione	molla a compressione ø 11mm L 26mm filo ø 1.3mm		
Per modelli:	105, 105SL, 205, 205-Exclusive, Century, Century-Restyling, Executive, Firenze, Firenze-SL, Firenze-SL-Raised, Gradisca, Gradisca-Restyling, Gradisca-Take-Away, PORTOFINO, PORTOFINO AM. SUPER, PORTOFINO AMERICA, Portofino-Restyling		

			
1			
codice	528253	cod. costr.	00866.0.00.03
descrizione	molla a compressione ø 12.5mm L 28mm filo ø 1.6mm		
Per modelli:	PORTOFINO		

			
1			
codice	528493	cod. costr.	17695.0.00.03
descrizione	molla a compressione ø 12.6mm L 30mm filo ø 1.9mm		
Per modelli:	205-Exclusive, Cadetta, Century, Excelsior-OR, Excelsior-Standard, Executive, Gradisca-Restyling, Maior, Maior-OR, Maior-Plus, Opus, Opus-B03-OR, Opus-OR, Opus-Sublima		

			
1			
codice	526561	cod. costr.	12941.0.00.03
descrizione	molla a compressione ø 14.3mm L 21mm filo ø 1.8mm		
Per modelli:	DeCurtis-CAMME, DeCurtis-DIG, DeCurtis-LEVA, Gradisca		

			
1			
codice	526560	cod. costr.	08952.0.00.03
descrizione	molla a compressione ø 14.3mm L 46mm filo ø 1.5mm		
Per modelli:	DeCurtis-CAMME, DeCurtis-DIG, DeCurtis-LEVA, Gradisca		

			
1			
codice	529946	cod. costr.	08953.0.00.03
descrizione	molla a compressione ø 14.7mm L 34mm filo ø 2mm		
Per modelli:	DeCurtis-CAMME, DeCurtis-DIG, DeCurtis-LEVA, Gradisca		

			
1			
codice	528235	cod. costr.	00863.0.00.03
descrizione	molla a compressione ø 5.5mm L 15mm filo ø 0.05mm		

			
1			
codice	528269	cod. costr.	00871.0.00.03
descrizione	molla a compressione ø 7.5mm L 18mm filo ø 1.1mm		
Per modelli:	105, 105SL, Agile, Belle-Epoque, CAPPUCCINO, DeCurtis-CAMME, DeCurtis-DIG, DeCurtis-LEVA, Firenze-SL, Firenze-SL-Raised, Opus-Sublima, SECS, TOP CLASS		

			
1			
codice	528248	cod. costr.	00870.0.00.03
descrizione	molla a compressione ø 7.8mm L 40mm filo ø 0.5mm		
Per modelli:	100, 105, 105SL, 205, 205-Exclusive, Belle-Epoque, Cadetta, CAPPUCCINO, Century, Century-Restyling, DeCurtis-CAMME, DeCurtis-DIG, DeCurtis-LEVA, Excelsior-OR, Excelsior-Standard, Executive, Firenze, Firenze-SL, Firenze-SL-Raised, Gradisca, Gradisca-Restyling, Gradisca-Take-Away, Maior, Maior-OR, Maior-Plus, MILLENNIO, Opus, Opus-B03-OR, Opus-OR, Opus-Sublima, PORTOFINO, PORTOFINO AM. SUPER, PORTOFINO AMERICA, Portofino-Restyling, Roma-Cappuccino		

			
1			
codice	528249	cod. costr.	05538.0.00.03
descrizione	molla a compressione ø 7.8mm L 40mm filo ø 0.5mm		
Per modelli:	105, 105SL, Belle-Epoque, CAPPUCCINO, MILLENNIO, PORTOFINO AM. SUPER, PORTOFINO AMERICA, Roma-Cappuccino		

			
1			
codice	526509	cod. costr.	00897.0.00.03
descrizione	molla a compressione ø 8.5mm L 95mm filo ø 0.8mm dx		
Per modelli:	MAC64, MC, RR45-A, RR45-S, RR45-SILENT, RR55-AE, RR65-AE, RR65-SE		



			
1			
codice	527555	cod. costr.	00898.0.00.03
descrizione	molla a compressione ø 9.9mm L 80mm filo ø 0.8mm		
Per modelli:	MC, RR45-A, RR45-DEL, RR45-PST, RR45-S, RR45-SILENT, RR55-AE, RR65-AE, RR65-SE		

molle a trazione

			
1			
codice	526513	cod. costr.	17684.0.00.03
descrizione	molla a trazione ø 11mm lungh. totale 44mm filo ø 0.9mm L1 35mm per leva		
Per modelli:	MAC64, MC, RR45-A, RR45-S, RR45-SILENT		

accessori caffè

schiumatori

			
1			
codice	525933	cod. costr.	10075.4.00.09
descrizione	cappuccinatore attacco 6mm 90° plastica		
Per modelli:	Agile, Firenze-SL, Firenze-SL-Raised, Gradisca, Roma, Roma-OR, Roma-OR-170		
accessori per	525933		
	codice	531255	cod. costr.
			—
	adattatore filetto 3/8" L 40mm		



manometri

			
1			
codice	541257	cod. costr.	06555.2.00.08
descrizione	manometro scala doppia ø 58mm campo di pressione 0-2,5 / 0-15bar attacco dietro macchina da caffè filetto 1/8"		
Per modelli:	Agile, PORTOFINO, PORTOFINO AMERICA		

			
1			
codice	541256	cod. costr.	00737.2.00.08 04971.2.00.08 05465.2.00.08 05466.2.00.08
descrizione	manometro scala doppia ø 58mm campo di pressione 0-3 / 0-15bar attacco dietro macchina da caffè filetto 1/8"		
Per modelli:	100, 105, 105SL, 205, 205-Exclusive, Century, Century-Restyling, Gradisca, Gradisca-Restyling, Gradisca-Take-Away, MILLENNIO, Portofino-Restyling		

dosatori

accessori

racordi filettati

in metallo

			
1			
codice	361182	cod. costr.	00177.0.00.04
descrizione	dado filetto 1/4" H 5mm ottone nichelato CH 17 conf. 1 pz		
Per modelli:	Agile, Cadetta, Century-Restyling, DeCurtis-CAMME, DeCurtis-DIG, DeCurtis-LEVA, Excelsior-OR, Excelsior-Standard, Executive, Firenze-SL, Firenze-SL-Raised, Gradisca-Restyling, Maior, Maior-OR, Maior-Plus, Opus, Opus-B03-OR, Opus-OR, Opus-Sublima, Roma, Roma-OR, Roma-OR-170		

racordi filettati, connettori per tubi

racordi filettati

nippi doppi

			
1			
codice	520160	cod. costr.	00236.0.00.04
descrizione	nipplo doppio ottone nichelato filetto 1/8" - 1/8" conf. 1 pz		
Per modelli:	105, 105SL, 205, 205-Exclusive, Agile, Belle-Epoque, Bolero, Cadetta, Century, Century-Restyling, DeCurtis-CAMME, DeCurtis-DIG, DeCurtis-LEVA, Excelsior-OR, Excelsior-Standard, Executive, Firenze, Firenze-SL, Firenze-SL-Raised, Gradisca, Gradisca-Restyling, Gradisca-Take-Away, Maior, Maior-OR, Maior-Plus, Opus, Opus-B03-OR, Opus-OR, Opus-Sublima, Portofino-Restyling, Roma, Roma-Cappuccino, Roma-OR, Roma-OR-170		

racordi ad angolo

			
1			
codice	520816	cod. costr.	00217.0.00.04
descrizione	raccordo ad angolo filetto 1/8" M - 1/8" M ottone nichelato		
Per modelli:	105, 105SL, 205-Exclusive, Belle-Epoque, Century, Century-Restyling, DeCurtis-CAMME, DeCurtis-DIG, DeCurtis-LEVA, Excelsior-OR, Excelsior-Standard, Firenze, Firenze-SL, Firenze-SL-Raised, Gradisca-Restyling, Gradisca-Take-Away, Opus, Opus-B03-OR, Opus-OR, Opus-Sublima, Roma-Cappuccino		

componenti di fissaggio

viti

viti autofilettanti

			
1			
codice	560105	cod. costr.	01254.0.00.03
descrizione	viti autofilettanti ø 3.9mm L 25mm inox conf. 20 pz DIN 7981/ISO 7049 testa ø 7.5mm testa ovale		

viti a testa svasata



1

codice	560215	cod. costr.	01242.0.00.03
descrizione	vite a testa svasata filetto M5 L 14mm inox DIN 963/ISO 2009 conf. 20 pz recipiente a taglio testa ø 9.2mm		
Per modelli:	105, 105SL, Agile, Belle-Epoque, Century, Firenze-SL, Firenze-SL-Raised, Roma, Roma-Cappuccino, Roma-OR, Roma-OR-170		

viti a testa piatta



1

codice	560365	cod. costr.	07079.0.00.03 20096.0.00.03
descrizione	vite a testa piatta filetto M4 lungh. fil. 8mm inox DIN 7985/ISO 7045 conf. 1 pz recipiente a croce testa ø 8mm spessore testa 3mm		
Per modelli:	MAC64, MAC64-On-Demand, RR45-A, RR45-DEL, RR45-On-Demand, RR45-PST, RR45-S, RR45-SILENT, RR55-AE, RR55-On-Demand, RR65-AE, RR65-SE		

viti a testa esagonale



1

codice	560204	cod. costr.	01231.0.00.03
descrizione	vite a testa esagonale filetto M8 lungh. fil. 25mm inox CH 13 conf. 1 pz DIN 933 / ISO 4017		
Per modelli:	105, 105SL, Agile, Belle-Epoque, Century, Firenze-SL, Firenze-SL-Raised, Roma, Roma-Cappuccino, Roma-OR, Roma-OR-170		

viti a testa cilindrica

DIN 912/ISO 4762



1

codice	560025	cod. costr.	02688.0.00.03
descrizione	vite a testa cilindrica filetto M4 lungh. fil. 10mm CH 3 inox conf. 20 pz DIN 912/ISO 4762		
Per modelli:	105, 105SL, 205, 205-Exclusive, Belle-Epoque, Cadetta, Century, Century-Restyling, DeCurtis-CAMME, DeCurtis-DIG, DeCurtis-LEVA, Excelsior-OR, Excelsior-Standard, Executive, Firenze, Firenze-SL, Firenze-SL-Raised, Gradisca, Gradisca-Restyling, Gradisca-Take-Away, Maior, Maior-OR, Maior-Plus, Opus, Opus-B03-OR, Opus-OR, Opus-Sublima, Portofino-Restyling		



1

codice	560402	cod. costr.	01247.0.00.03
descrizione	vite a testa cilindrica filetto M5 lungh. fil. 10mm L 15.5mm CH 4 inox conf. 1 pz recipiente esagonale DIN 912/ISO 4762		
Per modelli:	Belle-Epoque, MC, RR45-A, RR45-S, RR45-SILENT, RR55-AE, RR65-AE, RR65-SE		



1

codice	560031	cod. costr.	05545.0.00.03
descrizione	vite a testa cilindrica filetto M6 lungh. fil. 10mm CH 5 inox conf. 20 pz DIN 912/ISO 4762		
Per modelli:	105, 105SL, 205, 205-Exclusive, Cadetta, Century-Restyling, DeCurtis-CAMME, DeCurtis-DIG, DeCurtis-LEVA, Excelsior-OR, Excelsior-Standard, Executive, Firenze, Gradisca, Gradisca-Restyling, Gradisca-Take-Away, Maior, Maior-OR, Maior-Plus, Opus, Opus-B03-OR, Opus-OR, Portofino-Restyling		



1

codice	112021	cod. costr.	02680.0.00.03
descrizione	vite a testa cilindrica filetto M8 L 45mm lungh. fil. 30mm CH 6 acciaio zincato conf. 1 pz DIN 912/ISO 4762		
Per modelli:	205-Exclusive, Agile, Cadetta, DeCurtis-CAMME, DeCurtis-DIG, DeCurtis-LEVA, Gradisca, Gradisca-Restyling, Opus, Opus-B03-OR, Opus-OR, Opus-Sublima, Portofino-Restyling, Roma, Roma-Cappuccino, Roma-OR, Roma-OR-170		

grani

DIN 913/ISO 4026



1

codice	560346	cod. costr.	16518.0.40.04
descrizione	vite senza testa filetto M5 L 6mm inox DIN 913/ISO 4026 recipiente esagono incassato CH 2.5 conf. 20 pz		
Per modelli:	Opus-Sublima		

dadi

dadi esagonali

DIN 985



1

codice	560142	cod. costr.	12188.0.00.03
descrizione	dado esagonale filetto M6 H 6mm inox CH 10 conf. 20 pz DIN/ISO DIN 985 autobloccante		
Per modelli:	MC, RR45-A, RR45-S, RR45-SILENT, RR55-AE, RR65-AE, RR65-SE		

dadi esagonali metrici (senza norma)

			
1			
codice	527169	cod. costr.	01263.0.00.03
descrizione	dado esagonale filetto M3 H 2.8mm CH 5.5 ottone conf. 1 pz		
Per modelli:	105, 105SL, 205, 205-Exclusive, Century, Century-Restyling, Executive, Firenze, Firenze-SL, Firenze-SL-Raised, Gradisca, Gradisca-Restyling, Gradisca-Take-Away, Portofino-Restyling		

dadi esagonali con filetto in pollici

			
1			
codice	361182	cod. costr.	00177.0.00.04
descrizione	dado filetto 1/4" H 5mm ottone nichelato CH 17 conf. 1 pz		
Per modelli:	Agile, Cadetta, Century-Restyling, DeCurtis-CAMME, DeCurtis-DIG, DeCurtis-LEVA, Excelsior-OR, Excelsior-Standard, Executive, Firenze-SL, Firenze-SL-Raised, Gradisca-Restyling, Maior, Maior-OR, Maior-Plus, Opus, Opus-B03-OR, Opus-OR, Opus-Sublima, Roma, Roma-OR, Roma-OR-170		

rondelle

rondelle di spessore

DIN 9021

			
1			
codice	560117	cod. costr.	12187.0.00.03
descrizione	rondella di spessore int. ϕ 6.4mm ϕ est. 18mm spessore 1.5mm inox conf. 20 pz DIN 9021 per filettatura M6		
Per modelli:	MAC64, MC, RR45-A, RR45-S, RR45-SILENT, RR55-AE, RR65-AE, RR65-SE		

varie

			
1			
codice	528268	cod. costr.	00166.0.00.04
descrizione	disco int. ϕ 5.4mm ϕ est. 10mm spessore 2mm		
Per modelli:	100, 105, 105SL, 205, 205-Exclusive, Agile, Cadetta, CAPPUCCINO, Century, Century-Restyling, DeCurtis-CAMME, DeCurtis-DIG, DeCurtis-LEVA, Excelsior-OR, Excelsior-Standard, Executive, Firenze, Firenze-SL, Firenze-SL-Raised, Gradisca, Gradisca-Restyling, Gradisca-Take-Away, Maior, Maior-OR, Maior-Plus, MILLENNIO, Opus, Opus-B03-OR, Opus-OR, Opus-Sublima, PORTOFINO, PORTOFINO AMERICA, Portofino-Restyling		

rondelle dentellate

altri

			
1			
codice	112020	cod. costr.	01291.0.00.03
descrizione	rondella dentata int. ϕ 8.5mm		
Per modelli:	105, 105SL, 205, 205-Exclusive, Agile, Belle-Epoque, Cadetta, DeCurtis-CAMME, DeCurtis-DIG, DeCurtis-LEVA, Firenze, Firenze-SL, Firenze-SL-Raised, Gradisca, Gradisca-Restyling, Opus, Opus-B03-OR, Opus-OR, Opus-Sublima, Portofino-Restyling, Roma, Roma-Cappuccino, Roma-OR, Roma-OR-170		

fissaggi

fissaggi per cablaggi

			
1			
codice	550253	cod. costr.	01468.0.00.02
descrizione	fascetta per cablaggio lar. 3.6mm L 290mm bianco conf. 100 pz nylon		
Per modelli:	BFD		

seeger

DIN 6799

			
1			
codice	516198	cod. costr.	08949.0.00.03
descrizione	seeger E D1 ϕ 6mm D2 ϕ 12mm inox DIN 6799 spessore 0.7mm per albero ϕ 7-9mm		
Per modelli:	MC, RR45-A, RR45-DEL, RR45-S, RR45-SILENT, RR55-AE, RR65-AE, RR65-SE		

coppiglie

			
1			
codice	528762	cod. costr.	12185.0.00.03
descrizione	coppiglia ϕ 1.8mm L 17mm		
Per modelli:	Maior, Maior-OR, Maior-Plus, MC, Roma, Roma-Cappuccino, Roma-OR, Roma-OR-170, RR45-A, RR45-S, RR45-SILENT, RR55-AE, RR65-AE, RR65-SE		

A

anelli di tenuta 41

C

commutatori a rotazione 8
componenti di fissaggio 45
condensatori di rifasamento 20
condensatori e filtri antidisturbo 20
contatori volumetrici 18
coppiglie 47

D

dadi 46
dadi esagonali 46
dosatori 45

E

elettrodi 18
elettromagneti 20
elettrovalvole 16

F

fissaggi 47
fissaggi per cablaggi 47

G

grani 46

I

interruttori di accensione 20
interruttori e pulsanti 6
interruttori sistema ROLD 8
interruttori/pulsanti basculanti 6

L

lampade 9
lampade spia 9

M

microinterruttori 7

N

nippli doppi 45

O

O.R. 39

P

pompe 19
pompe a vibrazione 19
pompe di aumento pressione II 19
pressostati 18

pulsanti e interruttori a pressione 7

R

raccordi filettati 45, 45
relè 9
relè a semiconduttore 9
resistenze 3
resistenze per macchine da caffè 3
rondelle dentellate 47
rondelle di spessore 47

S

schiumatori 44
seeger 47
sonde 11

T

termostati 5
termostati a contatto 5, 5
termostati di sicurezza a contatto 5

V

viti 45
viti a testa cilindrica 46
viti a testa esagonale 46
viti a testa piatta 46
viti a testa svasata 46
viti autofilettanti 45