



**GAS**



**ELEKTRO**



**WASSER**



**MECHANIK**



**WERKZEUG**

Ersatzteile passend für

**CAMURRI**

Das komplette Sortiment finden Sie immer aktuell im GEV-Webshop

# Hersteller-Kataloge

Für jeden Hersteller die wichtigsten Ersatz- und Zubehörteile übersichtlich zusammengestellt



- ✓ **Komplettes Sortiment und alle Gerätedaten immer aktuell im GEV-Webshop**
- ✓ **Alphabetischer Index am Ende des Katalog**

## GEV-Webshop

[www.gev-online.de](http://www.gev-online.de)

[www.gev-online.ch](http://www.gev-online.ch)



- 🔍 Artikel als Favoriten markieren
- 🔍 Einloggen mit E-Mail-Adresse und gewohntem Passwort
- 🔍 Komfort-Bestellung – mehrere Artikel gleichzeitig in den Warenkorb legen
- 🔍 Sofort Artikel suchen ohne Anmeldung

## Heizkörper

### Heizkörper für Kaffeemaschinen



1

<b>GEV-Nr.</b>	417510	<b>Vergl.-Nr.</b>	050N0020 050N0020+050D0050+050C0430
<b>Beschreibung</b>	Heizkörper 1500W 230V HK 1 Gewinde 1" ø 168mm TH ø 7mm THL 110mm Anschluss Flachstecker 6,3mm SW 30 Rohr ø 6,3mm		



1

<b>GEV-Nr.</b>	417513	<b>Vergl.-Nr.</b>	050N0061 050N0061+050D0185
<b>Beschreibung</b>	Heizkörper 2400W 230V HK 3 Einbau ø 42mm LA 48mm L 188mm B 27mm H 30mm Loch ø 7mm TH ø 7mm THL 160mm THA 1 Rohr ø 6,3mm Anschluss Flachstecker 6,3mm 3-Lochflansch passend für CAMURRI		



1

<b>GEV-Nr.</b>	417512	<b>Vergl.-Nr.</b>	050N0040 050N0040+050D0051+050C0435
<b>Beschreibung</b>	Heizkörper 2400W 230V HK 3 Gewinde 1 1/4" L 220mm B 85mm H 60mm Rohr ø 6,3mm Anschluss Flachstecker 6,3mm SW 37		



1

<b>GEV-Nr.</b>	417511	<b>Vergl.-Nr.</b>	050N0012
<b>Beschreibung</b>	Heizkörper 900W 230V HK 1 Gewinde 1" ø 150mm Anschluss Flachstecker 6,3mm SW 30		



1

<b>GEV-Nr.</b>	417509	<b>Vergl.-Nr.</b>	050N0070
<b>Beschreibung</b>	Heizkörper 900W 230V HK 1 L 130mm H 42mm Flansch 26X61mm B 44mm Anschluss Flachstecker 6,3mm Rohr ø 8mm passend für CAMURRI		

## Durchlauferhitzer



1

<b>GEV-Nr.</b>	417506	<b>Vergl.-Nr.</b>	050N0110
<b>Beschreibung</b>	Durchlauferhitzer 1500W 230V ø 75mm H 142mm Anschluss Flachstecker 6,3mm		



1

<b>GEV-Nr.</b>	417508	<b>Vergl.-Nr.</b>	050N0120
<b>Beschreibung</b>	Durchlauferhitzer 1600W 230V ø 112mm H 87mm Anschluss M3		



1

<b>GEV-Nr.</b>	417507	<b>Vergl.-Nr.</b>	050N0140
<b>Beschreibung</b>	Durchlauferhitzer 4000W 230V ø 75mm H 165mm Anschluss M3		



1

<b>GEV-Nr.</b>	417505	<b>Vergl.-Nr.</b>	050N0100
<b>Beschreibung</b>	Durchlauferhitzer 800W 230V ø 80mm H 86mm Anschluss Flachstecker 6,3mm		

## Zubehör

### Flanschdichtungen



1

<b>GEV-Nr.</b>	531113	<b>Vergl.-Nr.</b>	050D0020
<b>Beschreibung</b>	Dichtung Fiber D1 ø 78mm D2 ø 46mm Materialstärke 1.6mm Loch ø 9,5mm LA 53,5mm passend für CAMURRI 3 Löcher		



1

<b>GEV-Nr.</b>	531114	<b>Vergl.-Nr.</b>	050D0030
<b>Beschreibung</b>	Dichtung Fiber D1 ø 81mm D2 ø 46mm Materialstärke 1.6mm Loch ø 7mm LA 45mm passend für CAMURRI 4 Löcher		

## Kochplatten

### rund

#### mit Überfallrand

#### für Haushalt + Großküche



1

<b>GEV-Nr.</b>	490224	<b>Vergl.-Nr.</b>	050N0192
<b>Beschreibung</b>	Kochplatte ø 110mm 600W 230V Anschluss 4 Schaltstellungen mit 8mm Überfallrand		



1

<b>GEV-Nr.</b>	490193	<b>Vergl.-Nr.</b>	050N0192 old version
<b>Beschreibung</b>	Kochplatte ø 110mm 700W 230V Anschluss 4 Schaltstellungen mit 8mm Überfallrand		

## Thermostate

### Anlegethermostate

#### Weitere



1

<b>GEV-Nr.</b>	390743	<b>Vergl.-Nr.</b>	050B0281 050B0281+050C0615+3x050C0701
<b>Beschreibung</b>	Anlegethermostat Lamm Abschalttemp. 300°C 1CO 1-polig 10A 250V Anschluss Flachstecker 6,3mm Schraubbefestigung passend für CAMURRI		

## Regel- und Sicherheitsthermostate

### IMIT / TEMPOMATIC / ARATHERMO

#### Regelthermostate

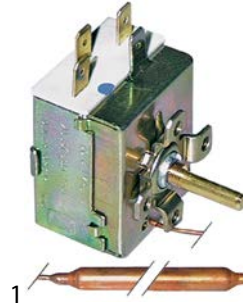

1

<b>GEV-Nr.</b>	390007	<b>Vergl.-Nr.</b>	050B0230
<b>Beschreibung</b>	Thermostat T.max. 120°C Arbeitsbereich 0-120°C 1-polig 1CO 16A Fühler ø 6.5mm Fühler L 95mm Kapillarrohr 1000mm Kapillarrohr isoliertmm Stopfbuchse Achslänge 19mm Achsstellung +135° Drehwinkel 270°		



1

<b>GEV-Nr.</b>	390399	<b>Vergl.-Nr.</b>	050B0231
<b>Beschreibung</b>	Thermostat T.max. 90°C Arbeitsbereich 0-120°C 1-polig 1CO 16A Fühler ø 6.5mm Fühler L 110mm Kapillarrohr 1500mm Kapillarrohr isoliert 1450mm Achse ø 6x4,6mm Achslänge 19mm Achsstellung +135° Drehwinkel 270°		

## Schalter und Taster

### Wippenschalter/-taster

#### 30x22mm



1

<b>GEV-Nr.</b>	301078	<b>Vergl.-Nr.</b>	050B0055
<b>Beschreibung</b>	Wippentaster Einbaumaß 30x22mm schwarz 2NO 250V 16A tastend 0-I Anschluss Flachstecker 6,3mm Umgebungstemperatur max. 85/125°C Schutzart IP40		

**Zubehör für** 301078



<b>GEV-Nr.</b>	301036	<b>Vergl.-Nr.</b>	—
<b>Beschreibung</b>	Schutzhaube Innenmaß 30x22mm für Wippenschalter Einbaumaß-mm		



1

<b>GEV-Nr.</b>	347473	<b>Vergl.-Nr.</b>	050B0005
<b>Beschreibung</b>	Wippenschalter Einbaumaß 30x22mm grün 2NO/Leuchte 230V 16A beleuchtet 0 Anschluss Flachstecker 6,3mm Umgebungstemperatur max. 125/55°C Schutzart IP40		





## Schwimmerschalter

			
1			
<b>GEV-Nr.</b>	347474	<b>Vergl.-Nr.</b>	050E0100 siehe Bemerkung 04.12.2017 siehe Bemerkung 24,02,2015
<b>Beschreibung</b>	Schwimmerschalter Kit Gewinde 1/8" 1NC ø 26mm L 26mm Einbau ø 10mm 230V 0.5A Kabel Kabellänge 600mm		

## Timer

### Zeitschalter mechanisch

				
1				
<b>GEV-Nr.</b>	360499	<b>Vergl.-Nr.</b>	050B0180	
<b>Beschreibung</b>	Zeitschalter MT59 2-polig Laufzeit 60min Antrieb mechanisch 2NO bei 250V 16A Dauerstellung Nein Achse ø 6x4,6mm Achslänge 21mm BA 28mm Anschluss seitlich Abflachung oben			
<b>Zubehör für</b>	360499			
	<b>GEV-Nr.</b>	112029	<b>Vergl.-Nr.</b>	—
	Knebel Nullstrich ø 40mm Achse ø 6x4,6mm Abflachung unten schwarz			
	<b>GEV-Nr.</b>	112589	<b>Vergl.-Nr.</b>	—
	Skalenscheibe Einteilung 60min Dauerstellung 0-290 Drehwinkel Nein ø 60mm			

## Ersatzteile und Zubehör

### Skalenscheiben

			
1			
<b>GEV-Nr.</b>	112647	<b>Vergl.-Nr.</b>	050B0190
<b>Beschreibung</b>	Skalenscheibe Einteilung 60min Drehwinkel 300° passend für CAMURRI		

## Schütze









### LOVATO

#### Leistungsschütze

			
1			
<b>GEV-Nr.</b>	380964	<b>Vergl.-Nr.</b>	050B0380
<b>Beschreibung</b>	Leistungsschütz AC1 20A 230VAC (AC3/400V) 9A/4kW Hauptkontakte 4NO Hilfskontakte Anschluss Schraubanschluss Typ 11BG-09T4A230		

## Magnetventile

### Magnetventile Wasser

TP				
				
1				
<b>GEV-Nr.</b>	370015	<b>Vergl.-Nr.</b>	050E0040	
<b>Beschreibung</b>	Magnetventil 1-fach gewinkelt 230VAC Eingang 3/4" Ausgang 11,5mm DN10 TP			
<b>Zubehör für</b>	370015			
	<b>GEV-Nr.</b>	371220	<b>Vergl.-Nr.</b>	—
	Reduzierung TP Durchflussrate 3l/min rot Toleranz ±15%			
	<b>GEV-Nr.</b>	371221	<b>Vergl.-Nr.</b>	—
	Reduzierung TP Durchflussrate 5.5l/min gelb Toleranz ±15%			
	<b>GEV-Nr.</b>	371222	<b>Vergl.-Nr.</b>	—
	Reduzierung TP Durchflussrate 6l/min grau Toleranz ±15%			
	<b>GEV-Nr.</b>	371223	<b>Vergl.-Nr.</b>	—
	Reduzierung TP Durchflussrate 10l/min weiß Toleranz ±15%			
	<b>GEV-Nr.</b>	371224	<b>Vergl.-Nr.</b>	—
	Reduzierung TP Durchflussrate 12l/min Bronze Toleranz ±15%			
	<b>GEV-Nr.</b>	371225	<b>Vergl.-Nr.</b>	—
	Reduzierung TP Durchflussrate 16l/min hellbraun Toleranz ±15%			
	<b>GEV-Nr.</b>	371226	<b>Vergl.-Nr.</b>	—
	Reduzierung TP Durchflussrate 20l/min rot Toleranz ±15%			
	<b>GEV-Nr.</b>	371230	<b>Vergl.-Nr.</b>	—
	Reduzierung TP Durchflussrate 0.25l/min rot Toleranz ±25%			
	<b>GEV-Nr.</b>	371231	<b>Vergl.-Nr.</b>	—
	Reduzierung TP Durchflussrate 0.35l/min violett Toleranz ±25%			

Tabellenfortsetzung auf der nächsten Seite



<b>Zubehör für</b>	370015		
	<b>GEV-Nr.</b>	371232	<b>Vergl.-Nr.</b> —
	Reduzierung TP Durchflussrate 0.5l/min orange Toleranz ±25%		
	<b>GEV-Nr.</b>	371233	<b>Vergl.-Nr.</b> —
	Reduzierung TP Durchflussrate 0.8l/min weiß Toleranz ±25%		
	<b>GEV-Nr.</b>	371234	<b>Vergl.-Nr.</b> —
	Reduzierung TP Durchflussrate 1l/min hellblau Toleranz ±25%		
	<b>GEV-Nr.</b>	371235	<b>Vergl.-Nr.</b> —
	Reduzierung TP Durchflussrate 1.2l/min braun Toleranz ±25%		
	<b>GEV-Nr.</b>	371236	<b>Vergl.-Nr.</b> —
	Reduzierung TP Durchflussrate 1.5l/min hellbraun Toleranz ±25%		
	<b>GEV-Nr.</b>	371237	<b>Vergl.-Nr.</b> —
	Reduzierung TP Durchflussrate 2.5l/min gelb Toleranz ±25%		
	<b>GEV-Nr.</b>	371238	<b>Vergl.-Nr.</b> —
	Reduzierung TP Durchflussrate 3.4l/min dunkelgrün Toleranz ±25%		
	<b>GEV-Nr.</b>	371239	<b>Vergl.-Nr.</b> —
	Reduzierung TP Durchflussrate 5l/min schwarz Toleranz ±25%		
	<b>GEV-Nr.</b>	371240	<b>Vergl.-Nr.</b> —
	Reduzierung TP Durchflussrate 8l/min blau Toleranz ±20%		

## Motoren

### Getriebemotoren

#### Weitere



1

<b>GEV-Nr.</b>	361833	<b>Vergl.-Nr.</b>	050E0060
<b>Beschreibung</b>	Getriebemotor CROUZET Typ 82524413 5W 230V Spannung AC 50Hz 30U/min Welle ø 6mm L 66mm B 54mm H 65mm		



1

<b>GEV-Nr.</b>	361860	<b>Vergl.-Nr.</b>	050E0060+050E0061+050C0706
<b>Beschreibung</b>	Getriebemotor MECHTEX Typ 11 K 221E 220V 50Hz 30U/min Welle ø 6mm L 100mm B 75mm H 67mm		

			
1			
<b>GEV-Nr.</b>	361834	<b>Vergl.-Nr.</b>	050E0071 050E0071+050E0072+050C0706
<b>Beschreibung</b>	Getriebemotor Typ X0211705 11.5W 230V 50Hz 30U/min Welle ø 6mm L 68mm B 68mm H 70mm		

## Sicherungen

### Feinsicherungen

			
1			
<b>GEV-Nr.</b>	358031	<b>Vergl.-Nr.</b>	050B0343
<b>Beschreibung</b>	Feinsicherung Größe ø10x38mm 10A Nennspannung 500V Typ gG flink VPE 1 Stück		

			
1			
<b>GEV-Nr.</b>	358027	<b>Vergl.-Nr.</b>	050B0342
<b>Beschreibung</b>	Feinsicherung Größe ø10x38mm 16A Nennspannung 500V Typ gG flink VPE 1 Stück		

			
1			
<b>GEV-Nr.</b>	358032	<b>Vergl.-Nr.</b>	050B0341
<b>Beschreibung</b>	Feinsicherung Größe ø10x38mm 25A Nennspannung 500V Typ gG flink VPE 1 Stück		

			
1			
<b>GEV-Nr.</b>	358022	<b>Vergl.-Nr.</b>	050B0344
<b>Beschreibung</b>	Feinsicherung Größe ø10x38mm 4A Nennspannung 500V Typ gG flink VPE 1 Stück		

### Feinsicherungshalter

			
1			
<b>GEV-Nr.</b>	358075	<b>Vergl.-Nr.</b>	050B0340
<b>Beschreibung</b>	Sicherungshalter für für Sicherung ø10x38mm passende Sicherung ø10x38mm 1-polig 32A Nennspannung 690V für DIN-Schiene 35mm Querschnitt 10mm <sup>2</sup> passend für für Sicherung ø10x38mm		



## Elektrozubehör

### Kabel

#### Zubehör

#### Kabeldurchführungen

#### Kabelverschraubungen

#### Verschraubungen



1

<b>GEV-Nr.</b>	551069	<b>Vergl.-Nr.</b>	050B0610
<b>Beschreibung</b>	Kabelverschraubung Gewinde PG11 Kabel ø 10mm Einbau ø 19mm VPE 1 Messing verchromt SW 20		

### Klemmen

#### Anschlussklemmen mit Schraub-Steckkontakten



1

<b>GEV-Nr.</b>	551067	<b>Vergl.-Nr.</b>	050B0401
<b>Beschreibung</b>	Anschlussklemme 3-polig max. 16A max 400V Anschluss ø2,5mm <sup>2</sup> / F6,3 Temp.Best. 150°C Querschnitt 2.5mm <sup>2</sup>		

#### Reihenklemmen

#### WIELAND

#### Reihenklemmen Typ 9700A



1

<b>GEV-Nr.</b>	550372	<b>Vergl.-Nr.</b>	050B0402
<b>Beschreibung</b>	Reihenklemme WIELAND Typ 9700A/6 SL2 S35 0,5-4mm <sup>2</sup> Hutschiene 35mm gelb/grün B 6mm L 48.5mm		

#### Weitere



1

<b>GEV-Nr.</b>	551068	<b>Vergl.-Nr.</b>	050B0408
<b>Beschreibung</b>	Reihenklemme 6mm <sup>2</sup> grün/gelb für DIN-Schiene 35mm 1-polig		

## Gerätespezifische Bauteile

### für Brühmaschinen

#### Ablasshähne

#### Ablasshähne



1

<b>GEV-Nr.</b>	531102	<b>Vergl.-Nr.</b>	050F0010
<b>Beschreibung</b>	Auslaufhahn Rohrlänge 45mm Gewinde 3/4" schwarz passend für CAMURRI		



1

<b>GEV-Nr.</b>	531103	<b>Vergl.-Nr.</b>	050F0030
<b>Beschreibung</b>	Auslaufhahn Rohrlänge 45mm Gewinde 3/4" schwarz/chrom passend für CAMURRI		

#### Einzelteile



1

<b>GEV-Nr.</b>	525433	<b>Vergl.-Nr.</b>	050D0060
<b>Beschreibung</b>	Dichtung für Hahn H 29mm ø 31mm		

#### Wasserhähne

#### Wasserhähne



1

<b>GEV-Nr.</b>	531104	<b>Vergl.-Nr.</b>	050F0110
<b>Beschreibung</b>	Auslaufhahn Eingang 3/4" Ausgang 1/2"		

#### Füllstandsrohre

#### Füllstandsrohre





1

<b>GEV-Nr.</b>	531110	<b>Vergl.-Nr.</b>	050I0030 050I0030 + 050D0165
<b>Beschreibung</b>	Füllstandsrohr AD ø 9mm ID ø 6mm H 180mm für CAMURRI		
<b>Ersatzteile für</b>	531110		



<b>GEV-Nr.</b>	531108	<b>Vergl.-Nr.</b>	050D0165
<b>Beschreibung</b>	O-Ring EPDM Materialstärke 2.5mm ID ø 7.8mm VPE 1 Stück		

1	
<b>GEV-Nr.</b>	531112 <b>Vergl.-Nr.</b> 050I0040
<b>Beschreibung</b>	Füllstandsrohr AD ø 9mm ID ø 6mm H 195mm für CAMURRI

1	
<b>GEV-Nr.</b>	531109 <b>Vergl.-Nr.</b> 050I0050 050I0050 + 050D0165
<b>Beschreibung</b>	Füllstandsrohr AD ø 9mm ID ø 6mm H 250mm für CAMURRI

1	
<b>GEV-Nr.</b>	531107 <b>Vergl.-Nr.</b> 050I0060 050I0060+050D0165
<b>Beschreibung</b>	Füllstandsrohr AD ø 9mm ID ø 6mm H 280mm für CAMURRI

1	
<b>GEV-Nr.</b>	531111 <b>Vergl.-Nr.</b> 050I0070
<b>Beschreibung</b>	Füllstandsrohr AD ø 9mm ID ø 6mm H 350mm für CAMURRI

### Gehäuse und Blenden

#### Gehäuse

1	
<b>GEV-Nr.</b>	531106 <b>Vergl.-Nr.</b> 050P8210
<b>Beschreibung</b>	Seitenteil L 305mm B 47mm H 205mm

### Knebel

#### Zubehör

#### Rosetten

1	
<b>GEV-Nr.</b>	110105 <b>Vergl.-Nr.</b> 050B0240
<b>Beschreibung</b>	Rosette Knebel ø 42mm ø 56mm Nullstrich

### Dichtungen

#### O-Ringe

#### EPDM

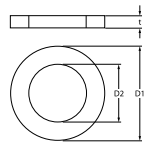
1		
---	---	---

<b>GEV-Nr.</b>	531108 <b>Vergl.-Nr.</b> 050D0165
<b>Beschreibung</b>	O-Ring EPDM Materialstärke 2.5mm ID ø 7.8mm VPE 1 Stück

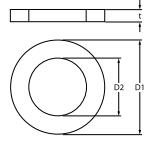
1		
---	---	---

<b>GEV-Nr.</b>	531105 <b>Vergl.-Nr.</b> 050D0169
<b>Beschreibung</b>	O-Ring EPDM Materialstärke 3mm ID ø 16.2mm VPE 1 Stück

### Fittinge, Schlauch- und Rohrverbinder

#### Fittinge

#### Reduzierungen

1	
<b>GEV-Nr.</b>	520209 <b>Vergl.-Nr.</b> 050C0200
<b>Beschreibung</b>	Reduzierung Gewinde 3/4" AG - 3/8" IG Messing vernickelt Gesamtlänge 17.5mm SW 30

### Befestigungsmaterialien

#### Schrauben

#### Senkkopfschrauben

1	
<b>GEV-Nr.</b>	560267 <b>Vergl.-Nr.</b> 050C0595
<b>Beschreibung</b>	Senkkopfschraube Gewinde M5 L 25mm CNS DIN 965/ISO 7046 VPE 1 Stück Aufnahme Kreuzschlitz





Sechskantschrauben			
			
1			
<b>GEV-Nr.</b>	560274	<b>Vergl.-Nr.</b>	050C0615
<b>Beschreibung</b>	Sechskantschraube Gewinde M5 Gewinde L 25mm CNS SW 8 ohne Schaft VPE 20 Stück DIN 933 / ISO 4017		

## Verbrauchsgüter

### Sicherungen

#### Feinsicherungen

##### ø10x38mm 500V

			
1			
<b>GEV-Nr.</b>	358031	<b>Vergl.-Nr.</b>	050B0343
<b>Beschreibung</b>	Feinsicherung Größe ø10x38mm 10A Nennspannung 500V Typ gG flink VPE 1 Stück		

			
1			
<b>GEV-Nr.</b>	358027	<b>Vergl.-Nr.</b>	050B0342
<b>Beschreibung</b>	Feinsicherung Größe ø10x38mm 16A Nennspannung 500V Typ gG flink VPE 1 Stück		

			
1			
<b>GEV-Nr.</b>	358032	<b>Vergl.-Nr.</b>	050B0341
<b>Beschreibung</b>	Feinsicherung Größe ø10x38mm 25A Nennspannung 500V Typ gG flink VPE 1 Stück		

			
1			
<b>GEV-Nr.</b>	358022	<b>Vergl.-Nr.</b>	050B0344
<b>Beschreibung</b>	Feinsicherung Größe ø10x38mm 4A Nennspannung 500V Typ gG flink VPE 1 Stück		



<b>A</b>			
Anlegethermostate	4		
<b>B</b>			
Befestigungsmaterialien	8		
<b>D</b>			
Durchlauferhitzer	3		
<b>E</b>			
Elektrozubehör	7		
<b>F</b>			
Feinsicherungen	9		
Fittinge	8		
<b>H</b>			
Heizkörper	3		
Heizkörper für Kaffeemaschinen	3		
<b>K</b>			
Kabel	7		
Kabeldurchführungen	7		
Kabelverschraubungen	7		
Klemmen	7		
Kochplatten	4		
<b>M</b>			
Magnetventile	5		
Motoren	6		
<b>O</b>			
O-Ringe	8		
<b>R</b>			
Reduzierungen	8		
Regelthermostate	4		
<b>S</b>			
Schalter und Taster	4		
Schrauben	8		
Schütze	5		
Schwimmerschalter	5		
Sechskantschrauben	9		
Senkkopfschrauben	8		
Sicherungen	6,9		
<b>T</b>			
Thermostate	4		
Timer	5		
<b>V</b>			
Verbrauchsgüter	9		
<b>W</b>			
Wippenschalter/-taster	4		
<b>Z</b>			
Zeitschalter mechanisch	5		