



COMPONENTI PER GAS



COMPONENTI ELETTRICI



COMPONENTI PER ACQUA



COMPONENTI MECCANICI



UTENSILI

Ricambi adatti a

CHARVET

Per la gamma completa sempre aggiornata visitate il nostro internet shop



Catalogo dei produttori

Per ciascun produttore, le parti di ricambio e gli accessori sono elencati in modo chiaro

- ✓ Assortimento completo e tutti i dati degli apparecchi sempre aggiornati nel Internetshop GEV
- ✓ Indice alfabetico alla fine del catalogo

Internetshop GEV Fast ricambi

www.fastricambi.it



- 🔍 Segna articolo come preferito
- 🔍 Procedi al log-in inserendo l'indirizzo mail e la password
- 🔍 Ordine Comfort – carica nel carrello una lista di articoli
- 🔍 Cerca ricambi in Cercafacile senza bisogno del log-in

resistenze

resistenze per forni

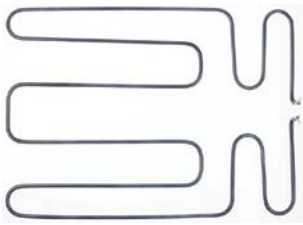

codice	420237	cod. costr.	02062A
descrizione	resistenza 2500W 230V L 600mm lar. 435mm H 29mm lunghezza piastrina 18mm larghezza piastrina 7mm int. dei fori 50mm tubo ø 8.5mm attacco M4 Nr. spirali 1 resistenza a secco fissabile con viti per forno		

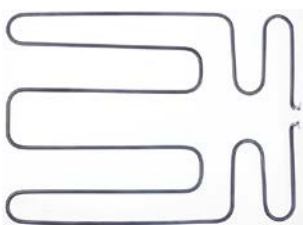

codice	420236	cod. costr.	02063A
descrizione	resistenza 2500W 400V L 600mm lar. 435mm H 29mm lunghezza piastrina 18mm larghezza piastrina 7mm int. dei fori 50mm tubo ø 8.5mm attacco M4 Nr. spirali 1 resistenza a secco fissabile con viti per forno		

resistenze per bagnomaria



codice	420002	cod. costr.	03746A
descrizione	resistenza 2000W 230V Nr. spirali 1 L 383mm L1 20mm lar. 235mm attacco M4 distanza di collegamento 225mm tubo ø 8.5mm resistenza a secco bagnomaria L2 363mm H 15mm		

resistenze per fry top



codice	420001	cod. costr.	03483A
descrizione	resistenza 1000W 230V Nr. spirali 1 L 405mm lar. 60mm Hmm tubo ø 10mm fissaggio a 2 fori attacco M4 filetto M14x1,25 interasse di fissaggio 45mm lunghezza terminali 30mm resistenza a secco		

resistenze per brasiere ribaltabili









codice	420555	cod. costr.	04448A
descrizione	resistenza 3000W 230V L 570mm lar. 90mm H 25mm attacco collegamento a vite Nr. spirali 1 tubo ø 8mm		

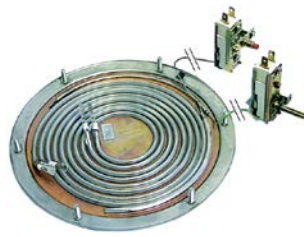

codice	420233	cod. costr.	07668A
descrizione	resistenza 3300W 230V L 565mm lar. 84mm H 118mm attacco M4 resistenza a secco Nr. spirali 1 tubo ø 8.5mm		

piastre riscaldanti sottopiano



codice	415661	cod. costr.	07369A	
descrizione	piastra riscaldante 3000W 230V Nr. spirali 2 ø 196mm termostato di sicurezza 250°C termostato 128°C M5 interasse di fissaggio 180mm			
ricambi per	415661			
	codice	102067	cod. costr.	—
	dado filetto M8x1 H 3mm ottone conf. 1 pz tipo SEF 1			
	codice	375137	cod. costr.	—
	termostato di sicurezza temp. intervento 250°C 1 poli 16A bulbo ø 3.03mm bulbo L 160mm lungh. capillare 880mm isolante sul capillare 800mm premistoppa bulbo inox con bulbo curvo			
	codice	375300	cod. costr.	—
	termostato t. mass. 128°C campo di lavoro 35-128°C 1 poli 1NO 16A bulbo ø 3.1mm bulbo L 174mm lungh. capillare 880mm isolante sul capillare 800mm premistoppa alb. L 23mm posizione alberino inferiore angolo di rotazione 270°			
accessori per	415661			
	codice	520323	cod. costr.	—
	guarnizione int. ø 160mm ø est. 200mm int. dei fori 90/180mm fori ø 7mm silicone per fondo radiante			
	codice	520324	cod. costr.	—
	controflangia int. ø 160mm ø est. 200mm int. dei fori 90/180mm fori ø 7mm inox per fondo radiante			
	codice	551083	cod. costr.	—
	tappo termostato di sicurezza filetto M8x1			

resistenze a barra



codice	418459	cod. costr.	02030A
descrizione	resistenza 1000W 240V attacco M5 L 630mm lar. 38mm H 8mm int. dei fori 650mm fori ø 8mm		

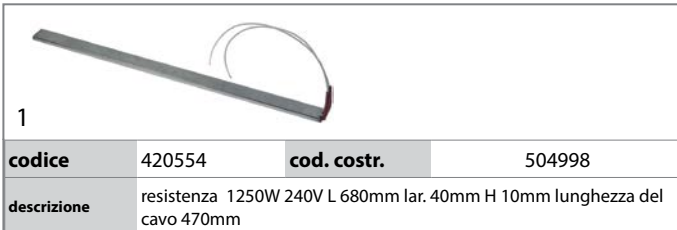

resistenze ad immersione

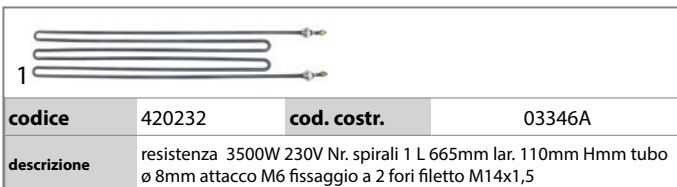
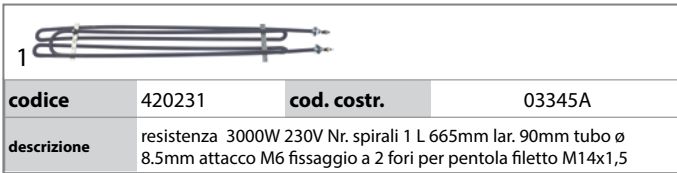

piastre di cottura

quadrate e rettangolari

con bordo da fusione

con collegamenti a vite



ribaltabili



regolatori di energia

EGO

a singolo circuito

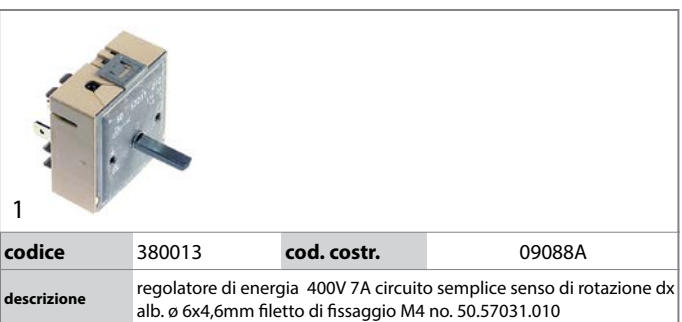

DIAMOND

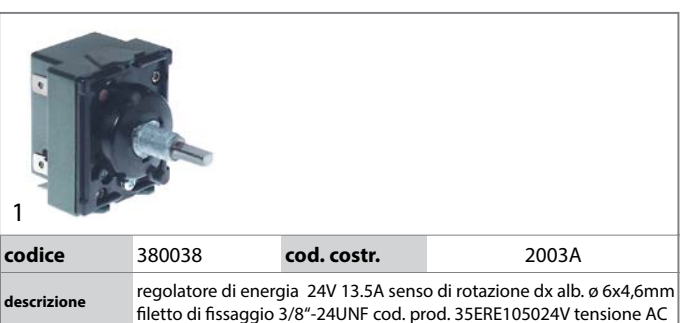



1

codice	380039	cod. costr.	02005A 02006A
descrizione	regolatore di energia 400V 13.5A senso di rotazione dx alb. ø 6x4,6mm filetto di fissaggio 3/8"-24UNF cod. prod. 35ERE104400V		
accessori per	380039		
	codice	361181	cod. costr. —
	dado filetto 1/8" H 4.5mm ottone nichelato CH 14 conf. 1 pz		

termostati

termostati di regolazione e di sicurezza

EGO

termostati di regolazione

serie 55.34_



1

codice	375143	cod. costr.	1995A
descrizione	termostato t. mass. 110°C campo di lavoro 32-110°C 3 poli 3NO 16A bulbo ø 6mm bulbo L 138mm lungh. capillare 1480mm isolante sul capillare 1100mm premistoppa M9x1 alb. ø 6x4,6mm alb. L 23mm posizione alberino superiore angolo di rotazione 270°		



1

codice	375020	cod. costr.	1995A
descrizione	termostato t. mass. 110°C campo di lavoro 32-110°C 3 poli isolante sul capillaremm premistoppa		



1

codice	375038	cod. costr.	01990A
descrizione	termostato t. mass. 300°C campo di lavoro 50-300°C 3 poli 3NO 16A bulbo ø 6mm bulbo L 79mm lungh. capillare 1740mm isolante sul capillare 800mm premistoppa alb. ø 6x4,6mm alb. L 23mm posizione alberino superiore angolo di rotazione 270°		
accessori per	375038		
	codice	110123	cod. costr. —
	manopola termostato t. mass. 300°C ø 50mm alb. ø 6x4,6mm parte piana superiore nero campo di lavoro 50-300°C angolo di rotazione 270°		



1

codice	375026	cod. costr.	01999a
descrizione	termostato t. mass. 350°C campo di lavoro 100-350°C 3 poli 3NO 16A bulbo ø 6mm bulbo L 77mm lungh. capillare 2430mm isolante sul capillare 1100mm premistoppa alb. ø 6x4,6mm alb. L 23mm posizione alberino superiore angolo di rotazione 270°		

termostati di sicurezza

serie 55.32_



1

codice	390813	cod. costr.	40100080
descrizione	termostato di sicurezza temp. intervento 245°C 3 poli 20A bulbo ø 6mm bulbo L 78mm lungh. capillare 1500mm isolante sul capillare 1050mm premistoppa M9x1 bulbo		



serie 55.33_



codice	375796	cod. costr.	02823A
descrizione	termostato di sicurezza temp. intervento 220°C 3 poli 3NC 20A bulbo ø 6mm bulbo L 107mm lungh. capillare 870mm isolante sul capillare 800mm premistoppa bulbo		



codice	390675	cod. costr.	05996A
descrizione	termostato di sicurezza temp. intervento 230°C 3 poli 20A bulbo ø 6mm bulbo L 88mm lungh. capillare 2200mm isolante sul capillare 2000mm premistoppa bulbo		

interruttori e pulsanti

microinterruttori

azionamento a leva



codice	345742	cod. costr.	07676A
descrizione	microinterruttore con leva 250V 16A 1CO attacco Faston maschio 6,3mm L 55mm temperatura ambiente max. 120°C interasse di fissaggio 22mm forza di azionamento: 75g lunghezza leva 46mm		



codice	345363	cod. costr.	07676A
descrizione	microinterruttore con leva 250V 16A 1CO attacco Faston maschio 6,3mm L 56mm temperatura ambiente max. 125°C		



codice	345074	cod. costr.	08233A
descrizione	microinterruttore con leva 250V 16A 1CO attacco Faston maschio 6,3mm temperatura ambiente max. 85°C interasse di fissaggio 25mm tipo C99ZP3 forza di azionamento: 25g lunghezza leva 154mm		

azionamento a leva con rotella

microinterruttori



codice	345041	cod. costr.	504985
descrizione	microinterruttore con leva a rullo 250V 16A 1CO attacco Faston maschio 6,3mm temperatura ambiente max. 85°C nero lunghezza leva 20.5mm		

versione pesante



codice	347718	cod. costr.	07675A
descrizione	microinterruttore con leva a rullo 250V 16A 1CO attacco a vite L 36mm L1 39mm temperatura ambiente max. 85°C interasse di fissaggio 26mm tipo MS-42 forza di azionamento: 50g lunghezza leva 51mm		

interruttori a galleggiante

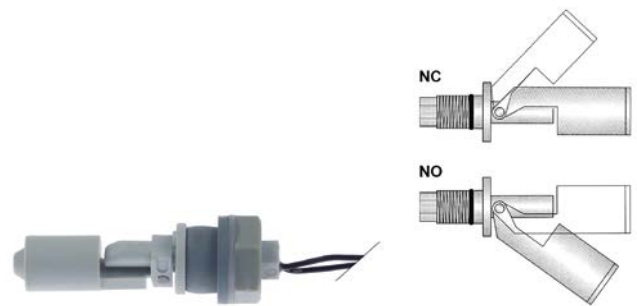



codice	347654	cod. costr.	07504A
descrizione	interruttore a galleggiante filetto M16x2 1NO o 1NC ø 17mm L 70mm incasso ø 16mmVA cavo lunghezza del cavo 500mm		

commutatori a camme

acceso/spento



1

codice	300020	cod. costr.	ELE0085
descrizione	commutatore a camme 4 posizioni di comando 2NO frequenza delle interruzioni 0-1-0-1 16A alb. ø 6x4,6mm alb. L 23mm attacco a vite ceramica		
accessori per	300020		
	codice	110135	cod. costr. —
	rosetta manopola fino a ø 52mm		
	codice	110231	cod. costr. —
	manopola interruttore 0-1-0-1 t. mass.°C ø 50mm alb. ø 6x4,6mm parte piana superiore nero		



1

codice	300021	cod. costr.	ELE0083
descrizione	commutatore a camme 4 posizioni di comando 4NO frequenza delle interruzioni 0-1-0-1 16A alb. ø 6x4,6mm alb. L 23mm attacco a vite ceramica		

4 posizioni



1

codice	300103	cod. costr.	02093A
descrizione	commutatore a camme 4 posizioni di comando 1NO/2CO frequenza delle interruzioni 0-1-2-3 32A alb. ø 6x4,6mm alb. L 23mm attacco a vite ceramica		

comandi e segnalatori

MAFELEC

interruttori completi



1

codice	347743	cod. costr.	03967A
descrizione	tasto dimensioni di montaggio ø22mm 1NO 20A rosso completo		

selettori a leva



1

codice	347744	cod. costr.	02104A
descrizione	selettore a leva dimensioni di montaggio ø22mm 2NO nero frequenza delle interruzioni 0-1 completo		

lampade



1

codice	359607	cod. costr.	2835A
descrizione	lampada al neon attacco Ba9s 380V 2W trasparente ø 10mm L 28mm		
accessori per	359607		

	codice	359060	cod. costr.	—
	portalampada dimensioni di montaggio ø16,2mm attacco E10 attacco a vite			
	codice	359063	cod. costr.	—
	portalampada dimensioni di montaggio ø19,2mm attacco E14 attacco a vite			
	codice	359064	cod. costr.	—
	portalampada dimensioni di montaggio ø22,3mm attacco E14 attacco a vite 250/380V temperatura ambiente 1W 100°C temperatura ambiente 2W 85°C			
	codice	359685	cod. costr.	—
	portalampada dimensioni di montaggio ø16,2mm attacco E10			
	codice	359832	cod. costr.	—
	portalampada dimensioni di montaggio ø16,2mm attacco Ba9s attacco Faston maschio 6,3mm			
	codice	359853	cod. costr.	—
	portalampada dimensioni di montaggio ø18,2mm attacco Ba9s attacco Faston maschio 6,3mm			
	codice	359988	cod. costr.	—
	portalampada dimensioni di montaggio ø30,5mm 250V attacco F6,3 temp. massima 55°C E14			



lampade

lampade spia



lampade spia 3 pezzi (gemma portalamпада, gemma e lampadina)

lampade

lampade ad incandescenza









1

codice	359585	cod. costr.	02141A
descrizione	lampada al neon attacco E10 230V verde ø 10mm L 28mm		
accessori per	359585		
	codice	359060	cod. costr. —
	portalamпада dimensioni di montaggio ø16,2mm attacco E10 attacco a vite		
	codice	359685	cod. costr. —
	portalamпада dimensioni di montaggio ø16,2mm attacco E10		









1

codice	359607	cod. costr.	2835A
descrizione	lampada al neon attacco Ba9s 380V 2W trasparente ø 10mm L 28mm		
accessori per	359607		
	codice	359060	cod. costr. —
	portalamпада dimensioni di montaggio ø16,2mm attacco E10 attacco a vite		
	codice	359063	cod. costr. —
	portalamпада dimensioni di montaggio ø19,2mm attacco E14 attacco a vite		
	codice	359064	cod. costr. —
	portalamпада dimensioni di montaggio ø22,3mm attacco E14 attacco a vite 250/380V temperatura ambiente 1W 100°C temperatura ambiente 2W 85°C		
	codice	359685	cod. costr. —
	portalamпада dimensioni di montaggio ø16,2mm attacco E10		
	codice	359832	cod. costr. —
	portalamпада dimensioni di montaggio ø16,2mm attacco Ba9s attacco Faston maschio 6,3mm		
	codice	359853	cod. costr. —
	portalamпада dimensioni di montaggio ø18,2mm attacco Ba9s attacco Faston maschio 6,3mm		
	codice	359988	cod. costr. —
	portalamпада dimensioni di montaggio ø30,5mm 250V attacco F6,3 temp. massima 55°C E14		



1

codice	359601	cod. costr.	02142A
descrizione	lampada al neon attacco E10 380V trasparente ø 10mm L 28mm vetro		
accessori per	359601		
	codice	359060	cod. costr. —
	portalamпада dimensioni di montaggio ø16,2mm attacco E10 attacco a vite		
	codice	359063	cod. costr. —
	portalamпада dimensioni di montaggio ø19,2mm attacco E14 attacco a vite		
	codice	359064	cod. costr. —
	portalamпада dimensioni di montaggio ø22,3mm attacco E14 attacco a vite 250/380V temperatura ambiente 1W 100°C temperatura ambiente 2W 85°C		
	codice	359685	cod. costr. —
	portalamпада dimensioni di montaggio ø16,2mm attacco E10		
	codice	359832	cod. costr. —
	portalamпада dimensioni di montaggio ø16,2mm attacco Ba9s attacco Faston maschio 6,3mm		
	codice	359853	cod. costr. —
	portalamпада dimensioni di montaggio ø18,2mm attacco Ba9s attacco Faston maschio 6,3mm		
	codice	359988	cod. costr. —
	portalamпада dimensioni di montaggio ø30,5mm 250V attacco F6,3 temp. massima 55°C E14		

lampade spia complete

ø12mm

con attacco a vite



1

codice	359048	cod. costr.	07664A
descrizione	lampada spia ø 12mm 230V giallo attacco Faston maschio 6,3mm		



1



codice	359895	cod. costr.	07139A
descrizione	lampada spia ø 12mm 400V giallo attacco cavo 200mm		





1





codice	359894	cod. costr.	07136A
descrizione	lampada spia ø 12mm 400V rosso attacco cavo 200mm		

lampadine
lampade ad incandescenza

			
1			
codice	359585	cod. costr.	02141A
descrizione	lampada al neon attacco E10 230V verde ø 10mm L 28mm		
accessori per	359585		
	codice	359060	cod. costr. —
	portalampada dimensioni di montaggio ø16,2mm attacco E10 attacco a vite		
	codice	359685	cod. costr. —
	portalampada dimensioni di montaggio ø16,2mm attacco E10		

			
1			
codice	359607	cod. costr.	2835A
descrizione	lampada al neon attacco Ba9s 380V 2W trasparente ø 10mm L 28mm		
accessori per	359607		
	codice	359060	cod. costr. —
	portalampada dimensioni di montaggio ø16,2mm attacco E10 attacco a vite		
	codice	359063	cod. costr. —
	portalampada dimensioni di montaggio ø19,2mm attacco E14 attacco a vite		
	codice	359064	cod. costr. —
	portalampada dimensioni di montaggio ø22,3mm attacco E14 attacco a vite 250/380V temperatura ambiente 1W 100°C temperatura ambiente 2W 85°C		
	codice	359685	cod. costr. —
	portalampada dimensioni di montaggio ø16,2mm attacco E10		
	codice	359832	cod. costr. —
	portalampada dimensioni di montaggio ø16,2mm attacco Ba9s attacco Faston maschio 6,3mm		
	codice	359853	cod. costr. —
	portalampada dimensioni di montaggio ø18,2mm attacco Ba9s attacco Faston maschio 6,3mm		
	codice	359988	cod. costr. —
	portalampada dimensioni di montaggio ø30,5mm 250V attacco F6,3 temp. massima 55°C E14		

			
1			
codice	359601	cod. costr.	02142A
descrizione	lampada al neon attacco E10 380V trasparente ø 10mm L 28mm vetro		
accessori per	359601		
	codice	359060	cod. costr. —
	portalampada dimensioni di montaggio ø16,2mm attacco E10 attacco a vite		
	codice	359063	cod. costr. —
	portalampada dimensioni di montaggio ø19,2mm attacco E14 attacco a vite		

accessori per	359601		
	codice	359064	cod. costr. —
	portalampada dimensioni di montaggio ø22,3mm attacco E14 attacco a vite 250/380V temperatura ambiente 1W 100°C temperatura ambiente 2W 85°C		
	codice	359685	cod. costr. —
	portalampada dimensioni di montaggio ø16,2mm attacco E10		
	codice	359832	cod. costr. —
	portalampada dimensioni di montaggio ø16,2mm attacco Ba9s attacco Faston maschio 6,3mm		
	codice	359853	cod. costr. —
	portalampada dimensioni di montaggio ø18,2mm attacco Ba9s attacco Faston maschio 6,3mm		
	codice	359988	cod. costr. —
	portalampada dimensioni di montaggio ø30,5mm 250V attacco F6,3 temp. massima 55°C E14		

timer
orologi

			
1			
codice	350014	cod. costr.	02167A
descrizione	orologio tempo 15min ø 56mm asse ø 6x4,6mm alb. L 24mm interasse di fissaggio 28mm		

			
1			
codice	350189	cod. costr.	02167A
descrizione	orologio tempo 15min ø 61mm asse ø 6x4,6mm alb. L 24mm interasse di fissaggio 28.5mm		



contattori

ABB

contattori di potenza



1

codice	381011	cod. costr.	07679A
descrizione	contattore di potenza carico nominale AC1 16A 230VAC (AC3/400V) 9A/4kW contatti principali 2NO/2NC contatti ausiliari attacco collegamento a vite tipo B6-22-00		



1

codice	380117	cod. costr.	07667A
descrizione	contattore di potenza carico nominale AC1 25A 230VAC (AC3/400V) 9A/4kW contatti principali 4NO contatti ausiliari attacco collegamento a vite tipo A9-40-00		



1

codice	381122	cod. costr.	00080A
descrizione	contattore di potenza carico nominale AC1 25A 250-500V AC/DC (AC3/400V) 9A/4kW contatti principali 3NO contatti ausiliari 1NO attacco collegamento a vite tipo AF09-30-10-14		

relè

relè di potenza

fissabili con viti



1

codice	380403	cod. costr.	07660A
descrizione	relè di potenza FINDER 230VAC 16A 3CO attacco F6,3 fissabile con viti codice costr. 62.83.8.230.0500		



1

codice	380185	cod. costr.	07661A
descrizione	relè di potenza Italiana Relè 230VAC 30A 1NO attacco F6,3 fissabile con viti dimensioni 36,5x32,2x51,8mm codice costr. A10-230AC-FA		

relè livello

varie



1

codice	380961	cod. costr.	02681A
descrizione	regolatore di livello 1 poli 230V tensione AC tipo CNRVA1 FLT		

sonde

sonde personalizzate dal costruttore

sonde



1

codice	379824	cod. costr.	07666A
descrizione	sonda di temperatura Tc K (NiCr-Ni) cavo Vetrotex bulbo -50 a +1150°C cavo -50 a +350°C attacco bifilare filetto bulbo ø4x65mm lunghezza del cavo 2.35m		

elettrovalvole

elettrovalvole per acqua

ELBI

dritto



codice	373017	cod. costr.	07662A
descrizione	elettrovalvola singolo dritta 230VAC entrata 3/4" uscita 11,5mm DN10 ELBI		
ricambi per	373017		
	codice	370467	cod. costr. —
	filtro per elettrovalvola adattabile a ELBI		

TP



codice	370017	cod. costr.	07662A
descrizione	elettrovalvola singolo dritta 230VAC entrata 3/4" uscita 11,5mm DN10 TP p max 10bar		
ricambi per	370017		
	codice	371013	cod. costr. —
	bobina magnetica TP 230VAC 50/60Hz		

accessori per	370017		
	codice	371220	cod. costr. —
	riduzione TP quota portata 3l/min rosso tolleranza ±15%		
	codice	371221	cod. costr. —
	riduzione TP quota portata 5.5l/min giallo tolleranza ±15%		
	codice	371222	cod. costr. —
	riduzione TP quota portata 6l/min grigio tolleranza ±15%		
	codice	371223	cod. costr. —
	riduzione TP quota portata 10l/min bianco tolleranza ±15%		
	codice	371224	cod. costr. —
	riduzione TP quota portata 12l/min bronzo tolleranza ±15%		
	codice	371225	cod. costr. —
	riduzione TP quota portata 16l/min marrone chiaro tolleranza ±15%		
	codice	371226	cod. costr. —
	riduzione TP quota portata 20l/min rosso tolleranza ±15%		
	codice	371230	cod. costr. —
	riduzione TP quota portata 0.25l/min rosso tolleranza ±25%		

accessori per	370017		
	codice	371231	cod. costr. —
	riduzione TP quota portata 0.35l/min viola tolleranza ±25%		
	codice	371232	cod. costr. —
	riduzione TP quota portata 0.5l/min arancione tolleranza ±25%		
	codice	371233	cod. costr. —
	riduzione TP quota portata 0.8l/min bianco tolleranza ±25%		
	codice	371234	cod. costr. —
	riduzione TP quota portata 1l/min celeste tolleranza ±25%		
	codice	371235	cod. costr. —
	riduzione TP quota portata 1.2l/min marrone tolleranza ±25%		
	codice	371236	cod. costr. —
	riduzione TP quota portata 1.5l/min marrone chiaro tolleranza ±25%		
	codice	371237	cod. costr. —
	riduzione TP quota portata 2.5l/min giallo tolleranza ±25%		
	codice	371238	cod. costr. —
	riduzione TP quota portata 3.4l/min verde scuro tolleranza ±25%		
	codice	371239	cod. costr. —
	riduzione TP quota portata 5l/min nero tolleranza ±25%		
	codice	371240	cod. costr. —
	riduzione TP quota portata 8l/min blu tolleranza ±20%		

in metallo

SIRAI

elettrovalvole per vapore (acqua)

2-vie

serie L153-D



codice	370326	cod. costr.	—
descrizione	elettrovalvola 2-vie 230VAC attacco 1" L 105mm DN 22mm morsetti femmina DIN -10 a +140°C SIRAI serie L153-D tipo bobina Z914A membrane EPDM (vapore/acqua) p max 8bar p min 0.1bar		
ricambi per	370326		
	codice	371161	cod. costr. —
	bobina magnetica 230VAC 27VA SIRAI tipo bobina Z923A alloggiamento ø 16mm 50Hz		

elettrovalvole per la refrigerazione

CASTEL

ricambi e accessori



codice	371090	cod. costr.	—
descrizione	presa tipo spina DIN 43650A a vite		

pressostati

per apparecchi a gas



codice	541051	cod. costr.	07835A
descrizione	pressostato ø 45mm campo di pressione regolabile 10-50mbar raccordo di mandata verticale componenti gas attacco 1/4" raccordo di mandata ø 1/4"mm		

per vapore



codice	541769	cod. costr.	07399A
descrizione	pressostato ø 45mm pentola campo di pressione fino a 1,0bar attacco 1/4" 250V 8A p max 1bar raccordo di mandata 1/4"		



codice	541074	cod. costr.	08030A
descrizione	pressostato ø 45mm pressione di lavoro 0,5bar pressione di reset 0,35bar raccordo di mandata verticale regolazione vapore campo di pressione 0,35/0,51bar attacco 1/8" raccordo di mandata 1/8"		

materiali per collegamenti

cavi

trefoli in rame

fino a 280°C



codice	550588	cod. costr.	02356A
descrizione	trefolo in rame 6mm ² temperatura di esercizio -60 a +280°C conduttore trefolo di rame nichelato isolamento calza in fibra di vetro/silicone conf. 10m marrone t.mass. 350°C nominale 300/500V tensione di prova 2000V		

trefoli in nichel

fino a 350°C



codice	550089	cod. costr.	02353A 02361A
descrizione	trefolo in nichel 4mm ² marrone conf. 10m temperatura di esercizio -60 a +350°C t.mass. 400°C nominale 300/500V tensione di prova 2000V conduttore trefolo in nichel isolamento calza in fibra di vetro/silicone		



codice	550590	cod. costr.	02356A 02364A
descrizione	trefolo in nichel 6mm ² marrone conf. 10m temperatura di esercizio -60 a +350°C t.mass. 400°C nominale 300/500V tensione di prova 2000V conduttore trefolo in nichel isolamento calza in fibra di vetro/silicone		

accessori

tubi di protezione



codice	550035	cod. costr.	02385A
descrizione	guaina protettiva metallica PG21 int. ø 23mm ø est. 27mm acciaio zincato conf. 10m		

accessori per	550035	codice	550308	cod. costr.	—
descrizione	raccordo filettato per tubo di protezione PG21 int. ø 21.7mm ø est. mm ottone nichelato conf. 5 pezzi				

passacavi
pressacavi
raccordi filettati

1
codice 550571 cod. costr. 02404A
descrizione pressacavo filetto PG16 cavo ø 12,0-14,0mm incasso ø 21.5mm ottone nichelato conf. 1 pz



dadi di fissaggio

1
codice 550577 cod. costr. 02407A
descrizione dado filetto PG16 H 3mm CH 26 ottone nichelato conf. 1 pz incasso ømm cavo ømm

rubinetti del gas

PEL

serie 20S

1
codice 101491 cod. costr. 08369A
descrizione rubinetto del gas PEL tipo 20S entrata gas M16x1,5 (tubo ø 10mm) by-pass ø 0.35mm uscita gas M16x1,5 (tubo ø 10/8mm) attacco per termocoppia M9x1 collegamento pilota alb. ø 8x6,5mm alb. L 22/15mm parte piana inferiore
ricambi per 101491
 codice 100408 cod. costr. —
by-pass tipo PEL20/21 foro ø 0.35mm filetto M5x0,5
 codice 101060 cod. costr. 00366A
gruppo magnetico standard L 39mm D1 ø 15.4mm D2 ø 11mm adattabile a PEL20-21/JUNKERS/EGA
 codice 101205 cod. costr. —
cappuccio per rubinetti del gas alb. ø 8x6,5mm alb. L 22/15mm parte piana sopra/sotto adattabile a PEL20
 codice 101231 cod. costr. —
dado termocoppia F1: M9x1 F2: M18x1
accessori per 101491
 codice 101287 cod. costr. —
anello bicono per tubo ø 6mm conf. 1 pz
 codice 101300 cod. costr. —
ghiera filetto M16x1,5 tubo ø 10mm
 codice 101450 cod. costr. —
anello bicono per tubo ø 8mm L 12.7mm conf. 1 pz ø est. 10mm



accessori per 101491
 codice 101451 cod. costr. —
ghiera filetto M16x1,5 tubo ø 8mm
 codice 110081 cod. costr. —
manopola ø 70mm alb. ø 8x6,5mm parte piana universale
 codice 110083 cod. costr. —
segnalino per manopola rubinetto del gas senza pos. pilota argenteo

serie 21S

1
codice 101095 cod. costr. 08366A
descrizione rubinetto del gas PEL tipo 21S entrata gas M16x1,5 (tubo ø 10mm) by-pass ø 0.35mm uscita gas M16x1,5 (tubo ø 10/8mm) attacco per termocoppia M8x1 collegamento pilota M10x1 alb. ø 8x6,5mm alb. L 22/15mm parte piana inferiore
ricambi per 101095
 codice 100408 cod. costr. —
by-pass tipo PEL20/21 foro ø 0.35mm filetto M5x0,5
 codice 101060 cod. costr. 00366A
gruppo magnetico standard L 39mm D1 ø 15.4mm D2 ø 11mm adattabile a PEL20-21/JUNKERS/EGA
 codice 101206 cod. costr. —
cappuccio per rubinetti del gas alb. ø 8x6,5mm alb. L 22/15mm parte piana sopra/sotto adattabile a PEL21
 codice 101230 cod. costr. —
dado termocoppia F1: M8x1 F2: M18x1 alluminio
accessori per 101095
 codice 100908 cod. costr. —
vite bicono filetto M10x1 per tubo ø 4mm conf. 1 pz
 codice 100909 cod. costr. 07011A
vite bicono filetto M10x1 per tubo ø 6mm conf. 1 pz
 codice 101246 cod. costr. —
anello bicono per tubo ø 4mm conf. 1 pz
 codice 101278 cod. costr. —
anello bicono per tubo ø 10mm conf. 1 pz
 codice 101286 cod. costr. 05377A
anello bicono int. ø 6mm conf. 1 pz
 codice 101300 cod. costr. —
ghiera filetto M16x1,5 tubo ø 10mm
 codice 101450 cod. costr. —
anello bicono per tubo ø 8mm L 12.7mm conf. 1 pz ø est. 10mm

Tabella continua alla prossima pagina





accessori per	101095			
	codice	101451	cod. costr.	—
	ghiera filetto M16x1,5 tubo ø 8mm			
	codice	110081	cod. costr.	—
	manopola ø 70mm alb. ø 8x6,5mm parte piana universale			
	codice	112206	cod. costr.	—
	segnalino per manopola argenteo rubinetto del gas PEL21/22/23 t. mass.°C ø est. 63mm int. ø 45.5mm			

serie 22N/O



codice	101443	cod. costr.	00310A	
descrizione	rubinetto del gas PEL tipo 22N/O entrata gas M20x1,5 (tubo ø 12mm) by-pass ø 0.35mm uscita gas M20x1,5 (tubo ø 12/10mm) attacco per termocoppia collegamento pilota M10x1 alb. ø 10x8mm alb. L 25/17mm parte piana inferiore			
ricambi per	101443			
	codice	100259	cod. costr.	—
	by-pass tipo PEL22 foro ø 0.35mm filetto M6x0,5			
	codice	101201	cod. costr.	—
	cappuccio per rubinetti del gas alb. ø 10x8mm alb. L 25/17mm parte piana sopra/sotto adattabile a PEL22			
	codice	101240	cod. costr.	—
	raccordo gas filetto M20x1,5 tubo ø 12/10mm per rubinetti del gas PEL con guarnizione e viti orizzontale			
	codice	101460	cod. costr.	—
	O.R. ø 12.37mm D1 ø 2.62mm adattabile a PEL22			
	codice	101461	cod. costr.	—
	vite kit adattabile a PEL22 conf. 4 pz			
accessori per	101443			
	codice	100908	cod. costr.	—
	vite bicono filetto M10x1 per tubo ø 4mm conf. 1 pz			
	codice	100909	cod. costr.	07011A
	vite bicono filetto M10x1 per tubo ø 6mm conf. 1 pz			
	codice	101246	cod. costr.	—
	anello bicono per tubo ø 4mm conf. 1 pz			
	codice	101248	cod. costr.	07475A
	anello bicono per tubo ø 12mm conf. 1 pz adattabile a PEL			
	codice	101249	cod. costr.	01600A
	anello bicono per tubo ø 10mm conf. 1 pz			
	codice	101250	cod. costr.	07463A
	ghiera filetto M20x1,5 per tubi ø 10mm			

accessori per	101443			
	codice	101251	cod. costr.	07462A
	ghiera filetto M20x1,5 per tubi ø 12mm			
	codice	101286	cod. costr.	05377A
	anello bicono int. ø 6mm conf. 1 pz			

serie 22S/O







codice	101086	cod. costr.	06635A	
descrizione	rubinetto del gas PEL tipo 22S/O entrata gas M20x1,5 (tubo ø 12mm) by-pass ø 0.35mm uscita gas M20x1,5 (tubo ø 12/10mm) attacco per termocoppia M9x1 collegamento pilota M10x1 alb. ø 10x8mm alb. L 25/17mm parte piana inferiore			
ricambi per	101086			
	codice	100259	cod. costr.	—
	by-pass tipo PEL22 foro ø 0.35mm filetto M6x0,5			
	codice	101058	cod. costr.	00325A
	gruppo magnetico L 39mm D1 ø 15.4mm D2 ø 13.5mm adattabile a PEL22/EGA24197 standard			
	codice	101201	cod. costr.	—
	cappuccio per rubinetti del gas alb. ø 10x8mm alb. L 25/17mm parte piana sopra/sotto adattabile a PEL22			
	codice	101231	cod. costr.	—
	dado termocoppia F1: M9x1 F2: M18x1			
	codice	101240	cod. costr.	—
	raccordo gas filetto M20x1,5 tubo ø 12/10mm per rubinetti del gas PEL con guarnizione e viti orizzontale			
	codice	101460	cod. costr.	—
	O.R. ø 12.37mm D1 ø 2.62mm adattabile a PEL22			
	codice	101461	cod. costr.	—
	vite kit adattabile a PEL22 conf. 4 pz			
accessori per	101086			
	codice	100908	cod. costr.	—
	vite bicono filetto M10x1 per tubo ø 4mm conf. 1 pz			
	codice	100909	cod. costr.	07011A
	vite bicono filetto M10x1 per tubo ø 6mm conf. 1 pz			
	codice	101241	cod. costr.	—
	raccordo gas filetto M20x1,5 tubo ø 12/10mm per rubinetti del gas PEL verticale			
	codice	101246	cod. costr.	—
	anello bicono per tubo ø 4mm conf. 1 pz			
	codice	101248	cod. costr.	07475A
	anello bicono per tubo ø 12mm conf. 1 pz adattabile a PEL			
	codice	101249	cod. costr.	01600A
	anello bicono per tubo ø 10mm conf. 1 pz			

Tabella continua alla prossima pagina



accessori per		101086	
	codice	101250	cod. costr. 07463A
	ghiera filetto M20x1,5 per tubi ø 10mm		
	codice	101251	cod. costr. 07462A
	ghiera filetto M20x1,5 per tubi ø 12mm		
	codice	101286	cod. costr. 05377A
	anello bicono int. ø 6mm conf. 1 pz		
	codice	110080	cod. costr. —
	manopola ø 70mm alb. ø 10x8mm parte piana universale		
	codice	112206	cod. costr. —
	segnalino per manopola argenteo rubinetto del gas PEL21/22/23 t. mass.°C ø est. 63mm int. ø 45.5mm		

accessori per		101949	
	codice	101250	cod. costr. 07463A
	ghiera filetto M20x1,5 per tubi ø 10mm		
	codice	101251	cod. costr. 07462A
	ghiera filetto M20x1,5 per tubi ø 12mm		
	codice	101286	cod. costr. 05377A
	anello bicono int. ø 6mm conf. 1 pz		
	codice	110080	cod. costr. —
	manopola ø 70mm alb. ø 10x8mm parte piana universale		
	codice	112206	cod. costr. —
	segnalino per manopola argenteo rubinetto del gas PEL21/22/23 t. mass.°C ø est. 63mm int. ø 45.5mm		

			
1			
codice	101949	cod. costr.	00311A
descrizione	rubinetto del gas PEL tipo 22S/O entrata gas M20x1,5 (tubo ø 12mm) by-pass ø 0mm uscita gas M20x1,5 (tubo ø 12/10mm) attacco per termocoppia M9x1 collegamento pilota M10x1 alb. ø 10x8mm alb. L 25/17mm parte piana inferiore		
ricambi per	101949		
	codice	101058	cod. costr. 00325A
	gruppo magnetico L 39mm D1 ø 15.4mm D2 ø 13.5mm adattabile a PEL22/EGA24197 standard		
	codice	101231	cod. costr. —
	dado termocoppia F1: M9x1 F2: M18x1		
	codice	101235	cod. costr. —
	raccordo gas filetto M20x1,5 tubo ø 12/10mm per rubinetti del gas PEL orizzontale		
	codice	101460	cod. costr. —
	O.R. ø 12.37mm D1 ø 2.62mm adattabile a PEL22		
	codice	101461	cod. costr. —
	vite kit adattabile a PEL22 conf. 4 pz		
accessori per	101949		
	codice	100908	cod. costr. —
	vite bicono filetto M10x1 per tubo ø 4mm conf. 1 pz		
	codice	100909	cod. costr. 07011A
	vite bicono filetto M10x1 per tubo ø 6mm conf. 1 pz		
	codice	101246	cod. costr. —
	anello bicono per tubo ø 4mm conf. 1 pz		
	codice	101248	cod. costr. 07475A
	anello bicono per tubo ø 12mm conf. 1 pz adattabile a PEL		
	codice	101249	cod. costr. 01600A
	anello bicono per tubo ø 10mm conf. 1 pz		

serie 23S/O			
			
1			
codice	101091	cod. costr.	00312A
descrizione	rubinetto del gas PEL tipo 23S/O entrata gas M28x1,5 (tubo ø 20mm) by-pass ø 0.35mm uscita gas M24x1,5 (tubo ø 16mm) attacco per termocoppia M9x1 collegamento pilota M10x1 alb. ø 10x8mm alb. L 35/19mm parte piana superiore		
ricambi per	101091		
	codice	100455	cod. costr. —
	by-pass tipo PEL23/24 foro ø 0.35mm filetto M8x0,5		
	codice	101045	cod. costr. 00394A
	gruppo magnetico F1: M9x1 F2: M22x1 L 46mm ø 18mm adattabile a PEL23S M9x1		
	codice	101244	cod. costr. —
	raccordo gas filetto M24x1,5 tubo ø 12/16mm orizzontale per rubinetti del gas PEL		
	codice	101336	cod. costr. —
	cappuccio per rubinetti del gas alb. ø 10x8mm alb. L 35/17mm parte piana sopra/sotto adattabile a PEL23S		
	codice	101463	cod. costr. —
	vite adattabile a PEL23S conf. 4 pz		
	codice	528455	cod. costr. —
	O.R. Viton spessore 2.62mm int. ø 18.72mm conf. 1 pz		
accessori per	101091		
	codice	100908	cod. costr. —
	vite bicono filetto M10x1 per tubo ø 4mm conf. 1 pz		
	codice	100909	cod. costr. 07011A
	vite bicono filetto M10x1 per tubo ø 6mm conf. 1 pz		
	codice	101246	cod. costr. —
	anello bicono per tubo ø 4mm conf. 1 pz		



Tabella continua alla prossima pagina



accessori per		101091		
	codice	101252	cod. costr.	—
ghiera filetto M24x1,5 per tubi ø 12mm				
	codice	101253	cod. costr.	—
ghiera filetto M24x1,5 PEL per tubi ø 16mm				
	codice	101254	cod. costr.	—
ghiera filetto M28x1,5 tubo ø 20mm				
	codice	101255	cod. costr.	—
anello bicono per tubo ø 12mm conf. 1 pz				
	codice	101256	cod. costr.	—
anello bicono per tubo ø 16mm conf. 1 pz				
	codice	101257	cod. costr.	—
anello bicono per tubo ø 20mm conf. 1 pz				
	codice	101286	cod. costr.	05377A
anello bicono int. ø 6mm conf. 1 pz				
	codice	110080	cod. costr.	—
manopola ø 70mm alb. ø 10x8mm parte piana universale				
	codice	112206	cod. costr.	—
segnalino per manopola argenteo rubinetto del gas PEL21/22/23 t. mass. °C ø est. 63mm int. ø 45.5mm				

PEL 355



1	codice	107227	cod. costr.	08425A
descrizione rubinetto del gas PEL tipo 355 entrata gas M20x1,5 (tubo ø 12mm) by-pass ø 0mm uscita gas M20x1,5 (tubo ø 12/10mm) attacco per termocoppia M9x1 collegamento pilota M10x1 alb. ø 10x8mm alb. L 27/17mm parte piana sx				
ricambi per 107227				
	codice	106819	cod. costr.	—
corpo elettrovalvola				
	codice	371090	cod. costr.	—
presa tipo spina DIN 43650A a vite				
	codice	371157	cod. costr.	—
bobina magnetica t. mass. 125°C 230V alloggiamento ø 13mm 17VA				

STN3R



1	codice	106185	cod. costr.	00273A
descrizione rubinetto del gas STN3R entrata gas flangia del tubo ø20mm by-pass ø 0mm uscita gas 3/8" (tubo ø 12mm) attacco per termocoppia M9x1 collegamento pilota M10x1 alb. ø 7x7mm alb. L 22/6mm parte piana orizzontale				
ricambi per 106185				
	codice	101964	cod. costr.	—
staffa di serraggio				



1	codice	103108	cod. costr.	00549A 05071A
descrizione rubinetto del gas STN3R tipo 300 entrata gas 1/2" F by-pass ø 0mm uscita gas 1/2" F attacco per termocoppia M9x1 collegamento pilota M10x1 alb. ø 10x8mm alb. L 36/19mm parte piana inferiore con accessori incl. adapt. M28x1,5 (tubo ø20mm)				

valvole e rubinetti termostatici

SIT

serie 710 Minisit













1	codice	101131	cod. costr.	00306A
descrizione termostato gas senza cappa, tasto e gomito SIT tipo MINISIT 710 t. mass. 190°C 50-190°C entrata gas 1/2" uscita gas 3/8" attacco per termocoppia M9x1 collegamento pilota M10x1 bulbo ø 5mm bulbo L 98mm lungh. capillare 1200mm tipo di sensore tipo A2 pressostato non presente pressostatobar premistoppa				
ricambi per 101131				
	codice	101053	cod. costr.	—
gruppo magnetico F1: M9x1 F2: M24x1 L 45mm ø 17mm adattabile a Minisit				
	codice	102103	cod. costr.	—
sonda 60-200°C bulbo ø 5mm bulbo L 98mm lungh. capillare 1050mm t. mass. 200°C friggitrice tipo di sensore tipo A2 adattabile a MINISIT 710				

Tabella continua alla prossima pagina



accessori per	101131		
	codice	100809	cod. costr. —
	O.R. EPDM spessore 2mm int. ø 21mm conf. 1 pz		
	codice	100820	cod. costr. —
	bussola premistoppa M M14x1,5 F M10x0,75 bulbo ø max. 6.5mm CH 22		
	codice	100904	cod. costr. —
	vite di serraggio M10x1 per tubo ø 4mm conf. 1 pz		
	codice	100905	cod. costr. —
	vite di serraggio M10x1 per tubo ø 6mm conf. 1 pz		
	codice	101054	cod. costr. —
	gruppo magnetico F1: M10x1 F2: M24x1 L 45mm ø 17mm adattabile a Minisit		
	codice	101136	cod. costr. —
	accenditore piezo-elettrico adattabile a Minisit con mascherina ømm attacco F6,3x0,8		
	codice	101137	cod. costr. —
	mascherina senza accensione piezoelettrica		
	codice	101267	cod. costr. —
	riduzione F 3/8" M 1/2" L 21mm		
	codice	101268	cod. costr. —
	raccordo gas filetto 3/8" ad angolo con O.R. MINISIT 710		
	codice	101269	cod. costr. 00442A
	raccordo gas filetto 1/2" ad angolo con O.R. MINISIT 710		
	codice	101270	cod. costr. —
	raccordo filettato F 3/8" M 3/8" L 28mm		
	codice	101272	cod. costr. —
	raccordo filettato F 1/2" M 3/8" L 57mm		
	codice	101273	cod. costr. —
	anello bicono per tubo ø 12mm L 9.5mm ottone conf. 1 pz adattabile a universale		
	codice	101274	cod. costr. —
	anello bicono per tubo ø 16mm conf. 1 pz		
	codice	101275	cod. costr. —
	vite bicono filetto 1/2" per tubo ø 16mm conf. 1 pz		
	codice	101276	cod. costr. —
	vite bicono filetto 3/8" tubo ø 12mm conf. 1 pz		
	codice	110068	cod. costr. —
	manopola adattabile a Minisit ø 37mm		

	codice	107237	cod. costr.	00306A
	descrizione	termostato gas senza cappa, tasto e gomito SIT tipo MINISIT 710 t. mass. 210°C 70-210°C entrata gas 1/2" uscita gas 3/8" attacco per termocoppia M9x1 collegamento pilota M10x1 bulbo ø 4mm bulbo L 122mm lungh. capillare 1300mm tipo di sensore pressostato non presente pressostatobar premistoppa		
accessori per	107237			
	codice	101137	cod. costr.	—
	mascherina senza accensione piezoelettrica			
	codice	101267	cod. costr.	—
	riduzione F 3/8" M 1/2" L 21mm			
	codice	101268	cod. costr.	—
	raccordo gas filetto 3/8" ad angolo con O.R. MINISIT 710			
	codice	110068	cod. costr.	—
	manopola adattabile a Minisit ø 37mm			

	codice	106931	cod. costr.	00308A
	descrizione	termostato gas SIT tipo MINISIT 710 t. mass. 310°C 70-310°C entrata gas 1/2" uscita gas 3/8" attacco per termocoppia M9x1 collegamento pilota M10x1 bulbo ø 4mm bulbo L 72mm lungh. capillare 1300mm pressostato non presente pressostatobar premistoppa 0710647 gas di accensione 6mm materiale del bulbo acciaio inox		
accessori per	106931			
	codice	101137	cod. costr.	—
	mascherina senza accensione piezoelettrica			
	codice	110068	cod. costr.	—
	manopola adattabile a Minisit ø 37mm			



PEL

serie 24STS



1

codice	107228	cod. costr.	00473A
descrizione	termostato gas PEL tipo 24STS 110-310°C entrata gas flangia by-pass ø 1.1mm uscita gas flangia attacco per termocoppia M9x1 collegamento pilota M10x1 lungh. capillare 1200mm bulbo ø 6mm bulbo L 100mm alb. ø 10x8mm alb. L 27/17mm parte piana superiore		



1

codice	101159	cod. costr.	473A
descrizione	termostato gas PEL tipo 24STS 120-320°C entrata gas flangia by-pass ø 0.35mm uscita gas flangia attacco per termocoppia M9x1 collegamento pilota M10x1 lungh. capillare 1200mm bulbo ø 6mm bulbo L 100mm alb. ø 10x8mm alb. L 27/17mm parte piana superiore		

ricambi per 101159

	codice	100455	cod. costr.	—
	by-pass tipo PEL23/24 foro ø 0.35mm filetto M8x0,5			
	codice	101058	cod. costr.	00325A
	gruppo magnetico L 39mm D1 ø 15.4mm D2 ø 13.5mm adattabile a PEL22/EGA24197 standard			
	codice	106200	cod. costr.	—
	dado filetto M9x1 adattabile a PEL 24/255			

accessori per 101159

	codice	101235	cod. costr.	—
	raccordo gas filetto M20x1,5 tubo ø 12/10mm per rubinetti del gas PEL orizzontale			
	codice	101236	cod. costr.	—
	raccordo gas filetto M20x1,5 tubo ø 12/10mm per rubinetti del gas PEL verticale			
	codice	101240	cod. costr.	—
	raccordo gas filetto M20x1,5 tubo ø 12/10mm per rubinetti del gas PEL con guarnizione e viti orizzontale			
	codice	101241	cod. costr.	—
	raccordo gas filetto M20x1,5 tubo ø 12/10mm per rubinetti del gas PEL verticale			
	codice	101248	cod. costr.	07475A
	anello bicono per tubo ø 12mm conf. 1 pz adattabile a PEL			
	codice	101249	cod. costr.	01600A
	anello bicono per tubo ø 10mm conf. 1 pz			
	codice	101250	cod. costr.	07463A
	ghiera filetto M20x1,5 per tubi ø 10mm			
	codice	101251	cod. costr.	07462A
	ghiera filetto M20x1,5 per tubi ø 12mm			

accessori per	101159			
	codice	101356	cod. costr.	—
	rubinetto del gas PEL tipo 215 entrata gas M16x1,5 (tubo ø 10mm) by-pass ø 0.35mm uscita gas M16x1,5 (tubo ø 10/8mm) attacco per termocoppia M10x1 collegamento pilota M10x1 alb. ø 8x6,5mm alb. L 22/15mm parte piana inferiore			
	codice	101460	cod. costr.	—
	O.R. ø 12.37mm D1 ø 2.62mm adattabile a PEL22			
	codice	101461	cod. costr.	—
	vite kit adattabile a PEL22 conf. 4 pz			
	codice	106165	cod. costr.	—
	guarnizione ø 27mm			
	codice	110079	cod. costr.	—
	segnalino per manopola termostato gas 1-8 argenteo			
	codice	110080	cod. costr.	—
	manopola ø 70mm alb. ø 10x8mm parte piana universale			

ROBERTSHAW



1



codice	580062	cod. costr.	00295A	
descrizione	termostato gas tipo BJW 93-287°C 200-550°F entrata gas flangia (tubo ø 5/16") by-pass ømm uscita gas 3/8" NPT attacco per termocoppia collegamento pilota 5/16" UNEF lungh. capillare 48" - 1220mm bulbo ø 3/16" - 4,7mm bulbo L 11 1/4" - 285mm ROBERTSHAW tubo entrata ø 7/16" tubo uscita ø 7/16"			
accessori per	580062			
	codice	106659	cod. costr.	—
	raccordo gas adattabile a termostato			
	codice	112547	cod. costr.	—
	manopola termostato gas t.mass. 500°F 200-500°F ø 49mm alb. ømm parte piana ROBERTSHAW nero			



STN3R





1

codice	106207	cod. costr.	00303A 104851
descrizione	termostato gas t. mass. 110°C entrata gas 1/2" uscita gas 1/2" bulbo ø 6.5mm bulbo L 200mm lungh. capillare 1200mm STN3R		
ricambi per	106207		
	codice	106211	cod. costr. —
	manopola adattabile a STN3R		
	codice	106212	cod. costr. —
	manopola adattabile a STN3R		





1

codice	106208	cod. costr.	00300A
descrizione	termostato gas t. mass. 200°C entrata gas 1/2" uscita gas 1/2" bulbo ø 6mm bulbo L 120mm lungh. capillare 1200mm STN3R		
ricambi per	106208		
	codice	106211	cod. costr. —
	manopola adattabile a STN3R		
	codice	106212	cod. costr. —
	manopola adattabile a STN3R		



1

codice	106209	cod. costr.	00304A
descrizione	termostato gas t. mass. 300°C entrata gas 1/2" uscita gas 1/2" bulbo ø 6.5mm bulbo L 80mm lungh. capillare 1200mm STN3R		
ricambi per	106209		
	codice	106211	cod. costr. —
	manopola adattabile a STN3R		
	codice	106212	cod. costr. —
	manopola adattabile a STN3R		

accensioni e termocoppie

bruciatori pilota

SIT





serie 100





1

codice	106906	cod. costr.	00177A 07550A 7550P
descrizione	bruciatore pilota SIT tipo serie 100 3-fiamme ugello ø 0.2mm attacco gas 6mm		
ricambi per	106906		
	codice	100245	cod. costr. 01157A 07357A
	ugello per bruciatore pilota gas liquido indice 20 foro ø 0.2mm conf. 1 pz filetto M8x0,75		
	codice	100855	cod. costr. —
	supporto bruciatore pilota tripla		
	codice	100885	cod. costr. —
	bussola miscelazione d'aria per bruciatore pilota conf. 1 pz		
	codice	100916	cod. costr. —
	molla a compressione per bruciatore pilota conf. 1 pz		
	codice	100917	cod. costr. —
	guarnizione per bruciatore pilota conf. 1 pz alluminio		
	codice	100918	cod. costr. —
	vite per bruciatore pilota		
	codice	107162	cod. costr. —
	testina per pilota SIT 3-fiamme Hmm Lmm conf. 1 pz		
	codice	107701	cod. costr. —
	parte inferiore del bruciatore pilota SIT serie 100 ugello ø 0.2mm		
accessori per	106906		
	codice	100245	cod. costr. 01157A 07357A
	ugello per bruciatore pilota gas liquido indice 20 foro ø 0.2mm conf. 1 pz filetto M8x0,75		
	codice	100246	cod. costr. —
	ugello per bruciatore pilota gas naturale foro ø 0.35mm conf. 1 pz filetto M8x0,75		
	codice	100904	cod. costr. —
	vite di serraggio M10x1 per tubo ø 4mm conf. 1 pz		
	codice	100905	cod. costr. —
	vite di serraggio M10x1 per tubo ø 6mm conf. 1 pz		
	codice	102110	cod. costr. —
	tubo gas accensione rame tubo ø 4mm spessore della parete 1mm L 3000mm		

Tabella continua alla prossima pagina

accessori per	106906		
	codice	102111	cod. costr. —
	tubo gas accensione rame tubo ø 6mm spessore della parete 1mm L 3000mm		
	codice	107171	cod. costr. 7357A
	ugello per bruciatore pilota SIT gas naturale/GPL foro ø 0.25mm conf. 1 pz		
	codice	107700	cod. costr. —
	parte inferiore del bruciatore pilota SIT serie 100 ugello ø 0.25mm		
	codice	107702	cod. costr. —
	parte inferiore del bruciatore pilota SIT serie 100 ugello ø 0.35mm		

	codice	107225	cod. costr. 07551A
	bruciatore pilota SIT tipo serie 100 3-fiamme ugello ø 0.4mm attacco gas 6mm		

accessori			
ugelli per bruciatori pilota			
	codice	100245	cod. costr. 01157A 07357A
	ugello per bruciatore pilota gas liquido indice 20 foro ø 0.2mm conf. 1 pz filetto M8x0,75		

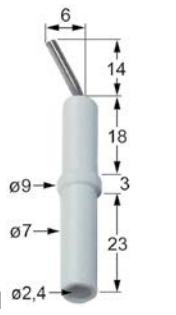

	codice	102972	cod. costr. 06430A
	ugello per bruciatore pilota gas naturale indice 40 foro ø 0.4mm conf. 1 pz		

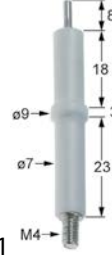
candele di accensione			
	codice	100707	cod. costr. 05315A
	candela accensione D1 ø 7mm D2 ø 9mm attacco ø2,4mm L1 14mm L2 6mm LC1 18mm LC2 3mm LC3 23mm a bloccare conf. 1 pz		

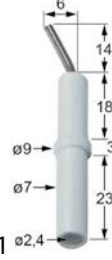
elettrodi			
	codice	102871	cod. costr. 07010A
	candela accensione D1 ø 7mm D2 ø 9mm attacco M4 L1 8mm LC1 18mm LC2 3mm LC3 23mm a bloccare		

	codice	100707	cod. costr. 05315A
	candela accensione D1 ø 7mm D2 ø 9mm attacco ø2,4mm L1 14mm L2 6mm LC1 18mm LC2 3mm LC3 23mm a bloccare conf. 1 pz		

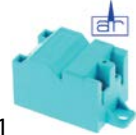
cavi di accensione			
cavi confezionati			
	codice	102163	cod. costr. 03013A
	cavo di accensione lunghezza del cavo 1500mm attacco F2,8mm / ø2,4mm		

generatori			
	codice	101012	cod. costr. 02161A
	trasformatore di accensione uscite 2 230VAC dimensioni 48x32x-32mm interasse di fissaggio 56mm entrata F2,8x0,8 uscita F2,8x0,8 tipo ZIG2 50-60Hz		
	codice	101002	cod. costr. 02161A
	trasformatore di accensione uscite 2 230VAC dimensioni 88x23x-34mm interasse di fissaggio 73mm entrata F6,3x0,8 uscita F2,8x0,8 0.6VA 50/60Hz		



termocoppie

set di termocoppie universali

1

codice 107647 **cod. costr.** 00291A

descrizione set termocoppie SIT 11 pezzi L 900mm

1

codice 102286 **cod. costr.** 5945A

descrizione set termocoppie 8 pezzi L 900mm flessibili

termocoppie lisce

termocoppie lisce standard

ROBERTSHAW

1

codice 102277 **cod. costr.** 286A

descrizione termocoppia ROBERTSHAW ASA 11/32 L 36" - 915mm 7/16"

con corpo ø6(6,5)mm

termocoppie SIT

1

codice 107614 **cod. costr.** 00290A
00296A

descrizione termocoppia SIT M9x1 L 1500mm attacco ad innesto ø6,0(6,5)mm

1

codice 107611 **cod. costr.** 00291A

descrizione termocoppia SIT M9x1 L 850mm attacco ad innesto ø6,0(6,5)mm

accessori

giunti interrotti

1

codice 101265 **cod. costr.** 05690A

descrizione giunto interrotto filetto M9x1

bruciatori principali

Bruciatori tubolari

Bruciatori tubolari

1

codice 109114 **cod. costr.** 30400010
505209

descrizione bruciatore a barra a una fila L 550mm lar.mm ø 39mm Hmm raccordo a flangia brasiera ribaltabile

ugelli del gas

ugelli per bruciatori principali

ugelli del gas 3/8"

1

codice 107500 **cod. costr.** 00191A

descrizione ugello del gas filetto 3/8" CH 17 foro ø 0.5mm





			
1			
codice	106526	cod. costr.	00263A
descrizione	ugello del gas filetto 3/8" CH 17 foro ø 0.6mm		

			
1			
codice	106537	cod. costr.	00199A
descrizione	ugello del gas filetto 3/8" CH 17 foro ø 1.5mm		

			
1			
codice	106527	cod. costr.	00192A
descrizione	ugello del gas filetto 3/8" CH 17 foro ø 0.7mm		

			
1			
codice	106538	cod. costr.	00200A
descrizione	ugello del gas filetto 3/8" CH 17 foro ø 1.6mm		

			
1			
codice	106528	cod. costr.	00264A
descrizione	ugello del gas filetto 3/8" CH 17 foro ø 0.8mm		

			
1			
codice	106539	cod. costr.	00201A
descrizione	ugello del gas filetto 3/8" CH 17 foro ø 1.7mm		

			
1			
codice	106532	cod. costr.	00194A
descrizione	ugello del gas filetto 3/8" CH 17 foro ø 1.1mm		

			
1			
codice	106540	cod. costr.	00202A
descrizione	ugello del gas filetto 3/8" CH 17 foro ø 1.8mm		

			
1			
codice	106534	cod. costr.	00195A
descrizione	ugello del gas filetto 3/8" CH 17 foro ø 1.2mm		

			
1			
codice	106541	cod. costr.	00203A
descrizione	ugello del gas filetto 3/8" CH 17 foro ø 1.9mm		

			
1			
codice	106535	cod. costr.	00197A 07280A
descrizione	ugello del gas filetto 3/8" CH 17 foro ø 1.3mm		

			
1			
codice	106531	cod. costr.	00193A
descrizione	ugello del gas filetto 3/8" CH 17 foro ø 1mm		

			
1			
codice	106536	cod. costr.	00198A
descrizione	ugello del gas filetto 3/8" CH 17 foro ø 1.4mm		

			
1			
codice	106543	cod. costr.	00205A G00205A
descrizione	ugello del gas filetto 3/8" CH 17 foro ø 2.1mm		





			
1			
codice	106544	cod. costr.	00206A
descrizione	ugello del gas filetto 3/8" CH 17 foro ø 2.2mm		

			
1			
codice	106552	cod. costr.	00213A
descrizione	ugello del gas filetto 3/8" CH 17 foro ø 2.9mm		

			
1			
codice	106545	cod. costr.	00207A
descrizione	ugello del gas filetto 3/8" CH 17 foro ø 2.3mm		

			
1			
codice	106542	cod. costr.	00204A
descrizione	ugello del gas filetto 3/8" CH 17 foro ø 2mm		

			
1			
codice	106546	cod. costr.	00208A
descrizione	ugello del gas filetto 3/8" CH 17 foro ø 2.4mm		

			
1			
codice	106554	cod. costr.	00215A
descrizione	ugello del gas filetto 3/8" CH 17 foro ø 3.1mm		

			
1			
codice	106547	cod. costr.	00209A
descrizione	ugello del gas filetto 3/8" CH 17 foro ø 2.5mm		

			
1			
codice	106555	cod. costr.	00216A
descrizione	ugello del gas filetto 3/8" CH 17 foro ø 3.2mm		

			
1			
codice	106548	cod. costr.	00210A
descrizione	ugello del gas filetto 3/8" CH 17 foro ø 2.6mm		

			
1			
codice	106556	cod. costr.	00217A
descrizione	ugello del gas filetto 3/8" CH 17 foro ø 3.3mm		

			
1			
codice	106549	cod. costr.	00211A
descrizione	ugello del gas filetto 3/8" CH 17 foro ø 2.7mm		

			
1			
codice	106557	cod. costr.	00218A
descrizione	ugello del gas filetto 3/8" CH 17 foro ø 3.5mm		

			
1			
codice	106551	cod. costr.	00212A
descrizione	ugello del gas filetto 3/8" CH 17 foro ø 2.8mm		

			
1			
codice	106558	cod. costr.	00219A 00220A
descrizione	ugello del gas filetto 3/8" CH 17 foro ø 3.6mm		



			
1			
codice	106559	cod. costr.	00221A
descrizione	ugello del gas filetto 3/8" CH 17 foro ø 3.8mm		

			
1			
codice	106553	cod. costr.	00214A
descrizione	ugello del gas filetto 3/8" CH 17 foro ø 3mm		

			
1			
codice	107208	cod. costr.	00224A
descrizione	ugello del gas filetto 3/8" CH 17 foro ø 4mm		

ugelli per bruciatori pilota

ugello per bruciatore pilota AB

			
1			
codice	102740	cod. costr.	01157A
descrizione	ugello per bruciatore pilota gas liquido indice 20 foro ø 0.2mm conf. 1 pz		

ugelli per bruciatori pilota AEM

			
1			
codice	106429	cod. costr.	08285A
descrizione	ugello per bruciatore pilota gas naturale foro ø 0.35mm filetto M5x0,75 CH 6		

ugelli per bruciatori pilota SIT

serie 100

			
1			
codice	100245	cod. costr.	01157A 07357A
descrizione	ugello per bruciatore pilota gas liquido indice 20 foro ø 0.2mm conf. 1 pz filetto M8x0,75		

			
1			
codice	102972	cod. costr.	06430A
descrizione	ugello per bruciatore pilota gas naturale indice 40 foro ø 0.4mm conf. 1 pz		

			
1			
codice	107171	cod. costr.	7357A
descrizione	ugello per bruciatore pilota SIT gas naturale/GPL foro ø 0.25mm conf. 1 pz		

ugelli per bruciatori pilota vari



SOLYMAC/CAPIC



			
1			
codice	106429	cod. costr.	08285A
descrizione	ugello per bruciatore pilota gas naturale foro ø 0.35mm filetto M5x0,75 CH 6		

materiali ausiliari gas



raccordi filettati



biconi



			
1			
codice	101286	cod. costr.	05377A
descrizione	anello bicono int. ø 6mm conf. 1 pz		
accessori per	101286		
	codice	100909	cod. costr. 07011A
	vite bicono filetto M10x1 per tubo ø 6mm conf. 1 pz		
	codice	101464	cod. costr. —
	ghiera filetto M12x1 per tubi ø 6mm		

			
1			
codice	101249	cod. costr.	01600A
descrizione	anello bicono per tubo ø 10mm conf. 1 pz		
accessori per	101249		
	codice	101250	cod. costr. 07463A
	ghiera filetto M20x1,5 per tubi ø 10mm		



			
1			
codice	101248	cod. costr.	07475A
descrizione	anello bicono per tubo ø 12mm conf. 1 pz adattabile a PEL		
accessori per	101248		
	codice	101251	cod. costr. 07462A
	ghiera filetto M20x1,5 per tubi ø 12mm		

ghiere			
			
1			
codice	101250	cod. costr.	07463A
descrizione	ghiera filetto M20x1,5 per tubi ø 10mm		
accessori per	101250		
	codice	101249	cod. costr. 01600A
	anello bicono per tubo ø 10mm conf. 1 pz		

			
1			
codice	101251	cod. costr.	07462A
descrizione	ghiera filetto M20x1,5 per tubi ø 12mm		
accessori per	101251		
	codice	101248	cod. costr. 07475A
	anello bicono per tubo ø 12mm conf. 1 pz adattabile a PEL		

raccordi per bicono			
			
1			
codice	100909	cod. costr.	07011A
descrizione	vite bicono filetto M10x1 per tubo ø 6mm conf. 1 pz		
accessori per	100909		
	codice	100898	cod. costr. —
	anello bicono per tubo ø 6mm conf. 1 pz per bruciatore pilota		
	codice	101286	cod. costr. 05377A
	anello bicono int. ø 6mm conf. 1 pz		
	codice	101287	cod. costr. —
	anello bicono per tubo ø 6mm conf. 1 pz		
	codice	101288	cod. costr. —
	anello bicono per tubo ø 6mm L 6mm alluminio conf. 1 pz ø est. 8,5mm		

pressostati

			
1			
codice	541051	cod. costr.	07835A
descrizione	pressostato ø 45mm campo di pressione regolabile 10-50mbar raccordo di mandata verticale componenti gas attacco 1/4" raccordo di mandata ø 1/4"mm		

ricambi per apparecchiature specifiche

per macinacaffè

			
1			
codice	345742	cod. costr.	07676A
descrizione	microinterruttore con leva 250V 16A 1CO attacco Faston maschio 6,3mm L 55mm temperatura ambiente max. 120°C interasse di fissaggio 22mm forza di azionamento: 75g lunghezza leva 46mm		

per brasiere ribaltabili

ricambi e accessori

			
1			
codice	692703	cod. costr.	04256A
descrizione	boccola spessore 5mm int. ø 20mm H 20mm ø est. 30 conf. 1 pz		

per pentole

indicatori livello

accessori



1	codice	541856	cod. costr.	03001A
	descrizione	tubo livello acqua ø 15mm L 160mm spessore 2.5mm vetro		

accessori

borchie



1	codice	111477	cod. costr.	02021A
	descrizione	pannello regolatore di energia 0-100 t. mass.°C ø 88mm alb. ømm parte piana		

chiusure



chiusure montaggio laterale

chiusure a leva

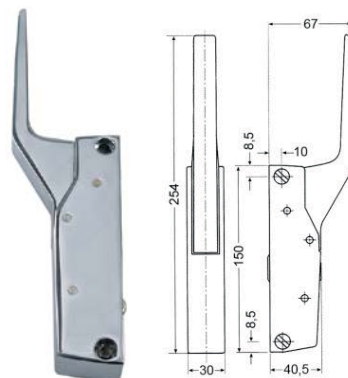
CAFF/FERMOD



1	codice	700060	cod. costr.	04205A
	descrizione	chiusura a leva L 150mm interasse di fissaggio 133mm senza serratura apparecchi termici G 791		

accessori per	700060
	codice 700061 cod. costr. —
	nasello per scrocchetto L 58mm lar. 20mm H 35mm interasse di fissaggio 42mm ottone cromato per apparecchi termici
	codice 700062 cod. costr. —
	protezione per maniglia apparecchi termici

varie



1	codice	511612	cod. costr.	FERM001
	descrizione	chiusura conf. 2 pz		

manopole

manopole universali



1	codice	110232	cod. costr.	08561A
	descrizione	manopola interruttore 4 posizioni t. mass.°C ø 50mm alb. ø 6x4,6mm parte piana superiore nero		

manopole personalizzate dal costruttore

CHARVET



1	codice	111476	cod. costr.	02016A
	descrizione	manopola marcatura zero t. mass.°C ø 46mm alb. ø 6x4,6mm parte piana superiore nero		



1	codice	111477	cod. costr.	02021A
	descrizione	pannello regolatore di energia 0-100 t. mass.°C ø 88mm alb. ømm parte piana		



rubinetteria per cucine







rubinetti di scarico

ottone

rubinetti di scarico





1

codice	541673	cod. costr.	3917A
descrizione	rubinetto di scarico 1 1/2" F con ghiera tenuta conica		
ricambi per	541673		
	codice	540213	cod. costr.
	maniglia int. ø 5mm L 117mm		
	codice	540956	cod. costr.
	guarnizione per rubinetto scarico est. ø tubo 46mm int. ø 38mm H 2mm		
accessori per	541673		
	codice	510404	cod. costr.
	guarnizione piana fibra ø est. 44mm int. ø 34mm spessore 2mm conf. 1 pz		
	codice	890116	cod. costr.
	grasso per rubinetterie FERMIT GLISSA tubetto 60g -20 a +140°C certificato corrisponde alla raccomandazione KTW		
	codice	890118	cod. costr.
	grasso per rubinetterie FERMIT GLISSA scatola 1000g -20 a +140°C certificato corrisponde alla raccomandazione KTW		
	codice	890119	cod. costr.
	grasso per rubinetterie FERMIT GLISSA tubetto 30g -20 a +140°C certificato corrisponde alla raccomandazione KTW		



1

codice	548001	cod. costr.	03917A
descrizione	rubinetto di scarico 1 1/2" F tenuta O.R. pentola attacco con ghiera A 80mm B1 68mm B2 132mm		
ricambi per	548001		
	codice	505092	cod. costr.
	O.R. EPDM spessore 5.34mm int. ø 43.82mm conf. 1 pz		
	codice	540213	cod. costr.
	maniglia int. ø 5mm L 117mm		



1

codice	541872	cod. costr.	07358A
descrizione	rubinetto di scarico valvola a sfera A 68mm B1 33mm B2 85mm filetto 1" F		

guarnizioni

guarnizioni termiche

guarnizioni vetro porta

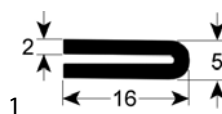

codice	901567	cod. costr.	02286A
descrizione	guarnizione vetro profilo 1879 L 2350mm adattabile a CHARVET conf. 1		

guarnizioni per porte

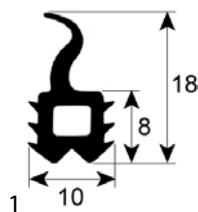

codice	901424	cod. costr.	Join021
descrizione	guarnizione per porta profilo 2711 L 2600mm conf. 1		

O.R.

EPDM

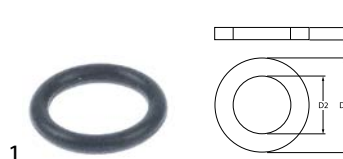

1

codice	501413	cod. costr.	04087A
descrizione	O.R. EPDM spessore 3mm int. ø 14mm conf. 1 pz		

silicone

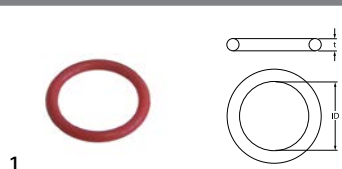

codice	532519	cod. costr.	504952
descrizione	O.R. silicone spessore 5.34mm int. Ø 53.34mm conf. 1 pz		

componenti di fissaggio

dadi

dadi esagonali

dadi esagonali con filettatura Pg



codice	550577	cod. costr.	02407A
descrizione	dado filetto PG16 H 3mm CH 26 ottone nichelato conf. 1 pz incasso Ømm cavo Ømm		

manometri



codice	541579	cod. costr.	0798A
descrizione	manometro Ø 52mm campo di pressione da 0 a 1bar attacco marcatura 0.5 filetto 1/4"		



codice	541062	cod. costr.	07986A
descrizione	manometro Ø 63mm campo di pressione da 0 a 1bar attacco marcatura regolabile pentola filetto 1/4"		
ricambi per	541062		
	codice	541130	cod. costr.
			—
	vetro Ø 58mm spessore 2mm		

dosatori



pompe a diaframma

autopescanti

LANG

accessori



codice	101286	cod. costr.	05377A
descrizione	anello bicono int. Ø 6mm conf. 1 pz		
accessori per	101286		
	codice	100909	cod. costr.
			07011A
	vite bicono filetto M10x1 per tubo Ø 6mm conf. 1 pz		
	codice	101464	cod. costr.
			—
	ghiera filetto M12x1 per tubi Ø 6mm		

B			
bruciatori pilota	19		
bruciatori principali	21		
Bruciatori tubolari	21		
C			
cavi	12		
cavi di accensione	20		
chiusure a leva	26		
chiusure montaggio laterale	26		
comandi e segnalatori	7		
commutatori a camme	7		
componenti di fissaggio	28		
contattori	10		
D			
dadi	28		
dadi esagonali	28		
dosatori	28		
E			
elettrovalvole	11		
G			
generatori	20		
guarnizioni per porte	27		
guarnizioni termiche	27		
guarnizioni vetro porta	27		
I			
interruttori a galleggiante	6		
interruttori e pulsanti	6		
L			
lampade	8		
lampade ad incandescenza	8, 9		
lampade spia	8		
lampade spia complete	8		
M			
materiali per collegamenti	12		
microinterruttori	6		
O			
O.R.	27		
orologi	9		
P			
passacavi	13		
piastre di cottura	4		
piastre riscaldanti sottopiano	3		
pressacavi	13		
pressostati		12, 25	
R			
regolatori di energia		4	
relè		10	
resistenze		3	
resistenze a barra		3	
resistenze ad immersione		4	
resistenze per bagnomaria		3	
resistenze per brasiera ribaltabili		3	
resistenze per forni		3	
resistenze per fry top		3	
rubinetti del gas		13	
S			
sonde		10	
T			
termocoppie		21	
termostati		5	
termostati di regolazione		5	
termostati di sicurezza		5	
timer		9	
trefoli in nichel		12	
trefoli in rame		12	
tubi di protezione		12	
U			
ugelli del gas		21	
V			
valvole e rubinetti termostatici		16	