



COMPONENTES GAS



COMPONENTES ELÉCTRICOS



TECNOLOGÍA DEL AGUA



COMPONENTES MECÁNICOS



HERRAMIENTAS

Repuestos adaptables a

CONTI

Encuentre nuestra gama siempre actualizada en la tienda online de GEV



Catálogo de fabricantes

Las piezas de repuesto y accesorios más importantes de cada fabricante reunidas y ordenadas de manera práctica

- ✓ En la tienda online GEV encontrará el surtido completo y toda la información actualizada de máquinas y aparatos
- ✓ Índice alfabético al final del catálogo

Tienda online GEV

www.gev-online.es
www.gev-online.com



- 🔍 marcar artículos como favoritos
- 🔍 acceso mediante su e-mail y su contraseña habitual
- 🔍 ponga en la cesta de la compra, múltiples artículos a la vez
- 🔍 búsqueda de artículos inmediata sin necesidad conectarse



resistencias

resistencias de máquinas de café

			
código	417254	referencia	411004 411004+408714
descripción	resistencia 2500W 230V espirales 1 rosca 1" L 200mm An 20mm H 20mm tubo ø 8.3mm empalme M4 longitud de empalme 27mm resistencia de inmersión brida roscada EC 30 máquina de café		
Para modelos:	Club		

			
código	417100	referencia	N/A
descripción	resistencia 2800W 230V espirales 3 montaje ø 66mm dist. del agujero 66mm L 245mm An 43mm H 71mm L1 25mm L2 45mm L3 180mm H1 47mm H2 24mm agujero ø 11mm tubo ø 8.3mm empalme conector Faston 6,3mm resistencia de inmersión brida 4 orificios		

			
código	417255	referencia	411431
descripción	resistencia 3400W 230V espirales 1 rosca 1" L 555mm An 20mm H 22mm tubo ø 8.3mm empalme M4 longitud de empalme 27mm resistencia de inmersión brida roscada EC 30 máquina de café		
Para modelos:	Club		

			
código	417763	referencia	425030
descripción	resistencia 3600W 230V espirales 1 rosca 1" L 330mm An 20mm H 22mm tubo ø 8.3mm empalme M4 longitud de empalme 27mm resistencia de inmersión brida roscada EC 30 máquina de café		

			
código	417257	referencia	165800 1658001 165900 1659001
descripción	resistencia 3660/4355W 220/240V espirales 3 montaje ø 67mm dist. del agujero 66.5mm L 425mm An 40mm H 69mm L1 33mm L2 42mm L3 350mm H1 44mm H2 25mm agujero ø 11mm tubo ø 8.5mm empalme M6 resistencia de inmersión brida 4 orificios cobre		
Para modelos:	Classica-PM, Classica-SA, Club, XeosEvolution2		

			
código	417256	referencia	410884
descripción	resistencia 4500W 230V espirales 3 montaje ø 57.5mm dist. del agujero 72mm L 320mm An 37mm H 50mm agujero ø 8mm tubo ø 8.5mm empalme conector Faston 6,3mm resistencia de inmersión brida 3 orificios		
Para modelos:	TwinStar2		
accesorios para	417256		
			
código	526108	referencia	4108841
descripción	junta tórica silicona espesor 6.3mm int.ø 56.5mm UE 1 pzs		

			
código	417101	referencia	N/A
descripción	resistencia 5000W 230V espirales 3 montaje ø 66mm dist. del agujero 64mm L 480mm An 42mm H 68mm L1 25mm L2 40mm L3 410mm H1 47mm H2 21mm agujero ø 11mm empalme M6x1 resistencia de inmersión brida 4 orificios		

cartuchos calentadores

			
código	417283	referencia	411261
descripción	cartucho calentador ø 10mm L 51mm longitud del cable 145mm máquina de café		
Para modelos:	TwinStar2		

accesorios

juntas para bridas

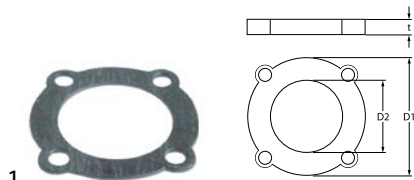
			
código	528437	referencia	N/A
descripción	junta fibra D1 ø 99mm D2 ø 66mm espesor 2mm agujero ø 11mm dist. del agujero 69/65mm para resistencia para CONTI int.ø 66mm		

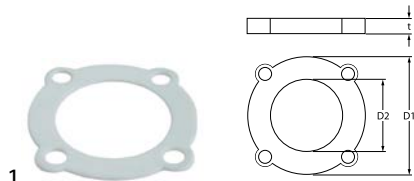
			
código	528438	referencia	N/A
descripción	junta PTFE D1 ø 99mm D2 ø 68mm espesor 2mm agujero ø 12mm dist. del agujero 68mm int.ø 68mm		

termostatos

termostatos de superficie

termostatos de superficie de seguridad

			
código	375493	referencia	410633
descripción	termómetro de superficie de seguridad dist. del agujero 28mm temp. desconexión 230°C 1NC 1 polos 16A empalme F6,3		
Para modelos:	TwinStar2		

			
1			
código	390693	referencia	410634
descripción	termómetro de superficie de seguridad temp. desconexión 160°C 1NC 1 polos 16A empalme F6,3 fijación atornillada rosca M4		
Para modelos:	Club, TwinStar2, XeosEvolution2		

termostatos de superficie

			
1			
código	390128	referencia	411308
descripción	termostato de contacto dist. del agujeromm temp. desconexión 95°C 1NC 1 polos 16A empalme F6,3 M4		
Para modelos:	TwinStar2		

termostatos de control y seguridad

diversos

termostatos de seguridad

			
1			
código	376045	referencia	415526
descripción	termostato de seguridad temp. desconexión 140°C 16A sonda ø 6mm sonda L 112mm capilar 410mm aislamiento del capilar 20mm 400V		

			
1			
código	375496	referencia	4069131 410634+410993
descripción	termostato de seguridad temp. desconexión 150°C margen de trabajo 100°C 1 polos 1NC 20A sonda ø 6mm sonda L 64mm capilar 1020mm		

accesorios

otros



			
1			
código	390776	referencia	410993
descripción	unión roscada para termostato de contacto rosca 3/8" agujero ø M4mm EC 21		
Para modelos:	Club		

interruptores y pulsadores

interruptores/pulsadores basculantes

30x22mm

con inscripción

			
1			
código	301200	referencia	408501
descripción	interruptor basculante medida de montaje 30x22mm negro 2NO 230V 16A 0-1 empalme conector Faston 6,3mm temperatura ambiente máx. 85°C protección IP65 con tapa		
Para modelos:	Club, XeosEvolution2		
accesorios para	301200		
		código	301036
		referencia	—
	cubierta protectora dimensión interior 30x22mm para interruptor basculante medida de montajemm		

otros

			
1			
código	347247	referencia	406956
descripción	interruptor basculante antracita 1NO 250V 10A de empotrar empalme conector		
Para modelos:	Classica-SA		

interruptores pulsantes y pulsadores

30x22mm

			
1			
código	301086	referencia	411429
descripción	interruptor pulsante medida de montaje 30x22mm negro 2NO 250V 12A 0-1 empalme conector Faston 6,3mm temperatura ambiente máx. 85/55°C protección IP54 con collar de protección		
Para modelos:	Classica-SA		



ø25mm			
			
1			
código	347222	referencia	411509
descripción	interruptor pulsante montaje ø 25mm azul 2NO 250V 16A iluminado empalme conector Faston 6,3mm temperatura ambiente máx. 125°C protección IP40		

			
1			
código	359479	referencia	408322 4083221
descripción	lámpara de señalización ø 8mm 230V verde longitud del cable 240mm resis.a la temp. 90°C		
Para modelos:	Club, XeosEvolution2		

interruptores de llave			
			
1			
código	400297	referencia	410989
descripción	interruptor de llave 1 gruppo rosca M12x1 1NO montaje ø 12mm longitud del cable 300mm		
Para modelos:	TwinStar2		

ø12mm con casquillo roscado			
			
1			
código	359026	referencia	411430
descripción	lámpara de señalización ø 12mm 230V rojo empalme conector Faston 6,3mm modelo CM/5		
Para modelos:	Classica-SA		

lámparas

lámparas de señalización

lámparas de señalización completas			
ø 8mm			
			
1			
código	359478	referencia	408323 4083231
descripción	lámpara de señalización ø 8mm 230V rojo longitud del cable 240mm resis.a la temp. 90°C		
Para modelos:	Club, XeosEvolution2		

contactores

ABB

contactores de potencia			
			
1			
código	381017	referencia	405892
descripción	contactor de potencia AC1 30A 230VAC (AC3/400V) 17A/7,5kW contactos principales 4NO contactos auxiliares empalme empalme atornillado tipo A16-40-00		
Para modelos:	Club, TwinStar2, XeosEvolution2		

			
1			
código	359480	referencia	408597
descripción	lámpara de señalización ø 8mm 230V rojo/verde empalme conector longitud del cable 230mm resis.a la temp. 90°C		
Para modelos:	XeosEvolution2		

contactores auxiliares			
			
1			
código	380899	referencia	408932
descripción	contactor auxiliar 230VAC AC1 5A AC15 3A empalme empalme atornillado contactos 2NO/2NC K6-22Z aliment. 220-240V		
Para modelos:	Club		

			
1			
código	359477	referencia	415534
descripción	lámpara de señalización ø 8mm 230V verde empalme conector longitud del cable 240mm resis.a la temp. 90°C		





contactos auxiliares



1

código	381031	referencia	408324
descripción	contacto auxiliar contactos 1NO/1NC AC1 16A AC15 3A empalme empalme atornillado para contactores B6/B7/VB7		
Para modelos:	TwinStar2, XeosEvolution2		

accesorios para	380348			
	código	380505	referencia	—
	zócalo de relé 2CO 40.52 medidas 81,9x15,5x75mm 250V tensión AC 10A FINDER N° fabricante 95.95.3			
	código	381181	referencia	—
	zócalo de relé 2 polos 40.51/40.52/40.61 empalme borne roscado medidas 15,8x78,6mm 250V tensión AC 10A FINDER N° fabricante 95.75			

semiconductores de potencia

CRYDOM



1

código	403540	referencia	466092
descripción	semiconductor de potencia CRYDOM fases 1 carga 25A carga 240V 3-32VDC L 57mm An 45mm atornillado tipo CSW2425G		

otros



1

código	402316	referencia	410626 411850
descripción	semiconductor de potencia unidad para Twin Star 2 2/3 grupos		
Para modelos:	TwinStar2		

relés

relés enchufables/para circuito impreso



1

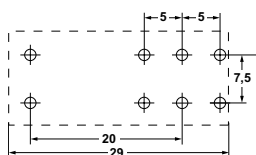

código	380348	referencia	411627	
descripción	relé para circuito impreso 12VDC 1CO a 250 V 16A empalme pins medida reticular 5mm Italiana Relè N° fabricante E61-12DC 95.65/95.75			
accesorios para	380348			
	código	380340	referencia	—
	zócalo de relé medidas 62x36x15mm 250V tensión AC 10A Italiana Relè N° fabricante ZMEM/5			

electrónicas

placas electrónicas



1

código	381315	referencia	410626
descripción	caja de relé para calefacción L 91mm An 56mm apto para CONTI aliment. 3x400V 6 relés alimentación 12Vc.c.		



1

código	402301	referencia	415086
descripción	display L 135mm An 44mm		



1

código	402300	referencia	410900
descripción	display L 159mm An 41mm con carcasa		
Para modelos:	TwinStar2		



1

código	402248	referencia	410877
descripción	display máquina de café L 80mm An 36mm		
Para modelos:	TwinStar2		



1	
código	402310 referencia 415088
descripción	placa electrónica azul LED 2 grupos

1	
código	402311 referencia 415089
descripción	placa electrónica azul LED 3 grupos

1	
código	402317 referencia 415087
descripción	placa electrónica transformador 9V tensión DC alimentación 230Vc.a.

unidades centrales

1	
código	402313 referencia 409837
descripción	unidad central 2 grupos CONTICLUB 220V tipo SDE3X CO3A tensión AC
Para modelos:	Club, XeosEvolution2

1	
código	402312 referencia 410885
descripción	unidad central 2/3 grupos edición 2002 tipo TS2
Para modelos:	TwinStar2

1	
código	402314 referencia 415085
descripción	unidad central 230V tipo 3d5 MAESTRO DELUXE per SLAVE 6T „XEOS“ tensión AC

1	
código	402315 referencia 411901
descripción	unidad central 230V tipo SDE3P CO2A tensión AC

1	
código	402296 referencia 4098374 411576 411900
descripción	unidad central juego edición ESSIKA unidad central SDE3P CO2A semiconductor de potencia cable chapa de sujeción
repuestos para	402296
	código 402062 referencia —
	semiconductor de potencia CELDUC fases 1 carga 25A carga 12-280V 3-32VDC L 59mm An 46mm atornillado tipo SO942460
	código 402315 referencia 411901
	unidad central 230V tipo SDE3P CO2A tensión AC



teclados

unidades de teclado

componentes eléctricos

			
1			
código	402306	referencia	411001
descripción	unidad de teclado agua caliente tazas 1 iluminación amarillo L 51mm An 61mm con LED		
Para modelos:	XeosEvolution2		

			
1			
código	402307	referencia	410887
descripción	unidad de teclado tazas 1 iluminación azul L 51mm An 61mm con LED		
Para modelos:	TwinStar2		

			
1			
código	402308	referencia	411244V
descripción	unidad de teclado tazas 5 azul ESSIKA		

			
1			
código	402303	referencia	410103
descripción	unidad de teclado tazas 5 iluminación amarillo L 187mm An 50mm con LED		
Para modelos:	Club, XeosEvolution2		

			
1			
código	402304	referencia	410813
descripción	unidad de teclado tazas 5 iluminación amarillo/rojo completo		
Para modelos:	Club		

			
1			
código	402302	referencia	410886
descripción	unidad de teclado tazas 5 iluminación azul L 187mm An 50mm con LED		
Para modelos:	TwinStar2		

			
1			
código	402305	referencia	409838 411259
descripción	unidad de teclado tazas 5 L 107mm An 44mm con LED 3dS		

			
1			
código	402309	referencia	411844V
descripción	unidad de teclado tazas 5 negro ESSIKA		

accesorios

			
1			
código	347232	referencia	410874
descripción	conducto luminoso apto para CONTI		
Para modelos:	TwinStar2		

			
1			
código	347233	referencia	405345
descripción	marco para tecla dimensiones exteriores 28mm dimensión interior 21mm negro		
Para modelos:	Club		







			
1			
código	347231	referencia	410640
descripción	tecla apto para CONTI		
Para modelos:	XeosEvolution2		

			
1			
código	347227	referencia	406206
descripción	tecla dimensiones exteriores 23.5mm rojo montaje ø 20.6mm		
Para modelos:	Club		

			
1			
código	347230	referencia	410872
descripción	tecla apto para CONTI gris		
Para modelos:	TwinStar2		

			
1			
código	347234	referencia	405348
descripción	tope de goma para tecla ø 16mm L 13mm		
Para modelos:	Club, TwinStar2, XeosEvolution2		

accesorios para 347230			
	código	347229	referencia 410273
	tecla dimensiones exteriores 12mm dimensión interior 4mm blanco		
	código	347232	referencia 410874
	conducto luminoso apto para CONTI		
	código	402302	referencia 410886
	unidad de teclado tazas 5 iluminación azul L 187mm An 50mm con LED		
	código	526087	referencia 410635
	resorte de compresión ø 10.7mm L 14.5mm espesor de hilo 0.7mm		

válvulas magnéticas

válvulas magnéticas agua

metal

ODE

válvulas magnéticas vapor (agua)

serie 130A

			
1			
código	370557 ¹	referencia	410615
descripción	válvula magnética acero inoxidable 230VAC empalme 1/8" / M22x1 3 vías -10 a 140°C membrana FKM (agua/vapor) 60Hz		
Para modelos:	TwinStar2		

¹carcasa de acero inox

serie 131K

			
1			
código	370556 ¹	referencia	405620 4056201
descripción	válvula magnética acero inoxidable 230VAC empalme M22x1 2 vías conector hembra DIN tipo de bobina BDV08220BW 50-60Hz		
Para modelos:	Classica-SA, Club, TwinStar2, XeosEvolution2		

¹carcasa de acero inox

			
1			
código	347229	referencia	410273
descripción	tecla dimensiones exteriores 12mm dimensión interior 4mm blanco		
Para modelos:	TwinStar2, XeosEvolution2		

			
1			
código	347228	referencia	410782
descripción	tecla dimensiones exteriores 23.5mm gris montaje ø 20.6mm		
Para modelos:	Club		

serie 21A



código	370836	referencia	367910 480347
descripción	válvula magnética latón 2vías 230VAC entrada 1/4" salida 1/4" L 40mm 21A2KE20 DN 2mm tipo de bobina BDP p máx. 22bar p mín. 0bar		
Para modelos:	Club, XeosEvolution2		

serie 4171K



código	370560	referencia	367920
descripción	válvula magnética latón 2vías 220-230V/50-60Hz entrada 1/4" salida 1/4" empalme 1/4" L 44mm ODE-4171-ZA DN 2.5mm conector hembra DIN -10 a 140°C tipo de bobina BDF membrana FKM (agua/vapor) p máx. 14bar p mín. 0bar 60Hz 220V tensión AC		
Para modelos:	Club, TwinStar2		



código	370559	referencia	367910 (old version)
descripción	válvula magnética latón 2vías 230VAC entrada 1/4" salida 1/4" empalme 1/4" L 44mm ODE-4171-F44 DN 2.5mm -10 a 140°C tipo de bobina BDP membrana FKM (agua/vapor) p máx. 14bar p mín. 0bar		

PARKER

diversas válvulas magnéticas



código	370497	referencia	411476
descripción	válvula magnética 2vías 230VAC empalme 1/8" L 30mm DN 1.5mm PARKER latón		
Para modelos:	TwinStar2		

recambios y accesorios

cuerpos de válvula



código	370062	referencia	CON01	
descripción	cuerpo de válvula magnética PARKER 3vías cono exterior			
accesorios para	370062			
	código	371029	referencia	—
	bobina magnética PARKER 230VAC 9VA tipo de bobina ZB09 soporte ø 14mm H 33mm An 34mm P 43mm			
	código	371030	referencia	—
	bobina magnética 24VDC 12VA tipo de bobina ZB12 soporte ø 14mm			
	código	371033	referencia	—
	bobina magnética PARKER 230VAC 9VA tipo de bobina YB09 mit Kabel soporte ø 14mm			
	código	371036	referencia	—
	bobina magnética 24VAC 9VA tipo de bobina ZB09 soporte ø 14mm			
	código	371095	referencia	—
	junta tórica Viton espesor 1.78mm int.ø 6.07mm UE 1 pzs			
	código	371100	referencia	—
	junta tórica silicona espesor 1.78mm int.ø 6.07mm UE 1 pzs			

presostatos

para aparatos de café

ø34mm



código	541699	referencia	4301611 4651611	
descripción	presostato ø 34mm margen de presión 1,5-4bar con tubo de protección NC 15A/NO 9A 250V empalme conector Faston 6,3mm 1CO diferencia 0,1-0,8bar empalme de presión 1/4"			
Para modelos:	TwinStar2			
repuestos para	541699			
	código	541020	referencia	—
	presostato ø 38mm margen de presión 0,5-1,2bar aparatos de café conexión de presión vertical ajustada 1bar 16A 250V empalme 1/4" empalme de presión 1/4" GAS			

ø38mm



código	541700	referencia	4119311
descripción	presostato ø 38mm margen de presión 0,5-1,2bar con tubo de protección conexión de presión vertical 16A 250V temperatura ambiente máx. 125°C empalme de presión 1/4"		



flujómetros y sensores de caudal

flujómetros

GICAR



1

código	400004	referencia	403466
descripción	flujómetro rosca 1/4" acero inoxidable con LED conexión enchufable homologación NSF		
Para modelos:	Club, TwinStar2, XeosEvolution2		
accesorios para	400004		
	código	400256	referencia
			—
	conector GICAR para flujómetro		

bombas

bombas de aumento de presión II

cabezas de bomba

FLUID-O-TECH



1

código	500174	referencia	4057225
descripción	cabezal de bomba PA104 FLUID-O-TECH L 82mm 100l/h empalme 3/8" GAS con bypass latón empalme de abrazadera para máquina de café eje ø 4,8x11mm NSF		
accesorios para	500174		
	código	520126	referencia
			—
	abrazadera para motor/bomba		

fusibles

contactores de protección de línea

ABL SURSUM



1

código	358121	referencia	411020
descripción	contactor de protección de línea 1 polo 25A característica de disparo C nominal 240/415V nominal 25A		
Para modelos:	TwinStar2		

accesorios eléctricos

cables

cables de cinta plana

grupo 1



1

código	400706	referencia	409839
descripción	cable de cinta plana 16 polos L 1100mm tipo de conector FC-16P medida reticular 2.54mm		
Para modelos:	Club, TwinStar2, XeosEvolution2		



1

código	400707	referencia	409840
descripción	cable de cinta plana 16 polos L 1400mm tipo de conector FC-16P medida reticular 2.54mm		
Para modelos:	Club, XeosEvolution2		



1

código	400228	referencia	410629
descripción	cable de cinta plana 16 polos L 600mm tipo de conector FC-16P medida reticular 2.54mm		
Para modelos:	TwinStar2		

componentes específicos

para máquinas de espresso

portafiltro

portafiltros standard

portafiltros completos



1

código	523044	referencia	4056791 4099998
descripción	portafiltro apto para CONTI completo sujeción ø 84mm int.ø 62mm distancia de la boca de salida 8mm altura cuña 8mm cantidad de cuñas 2		
Para modelos:	Classica-PM, Classica-SA, Club, XeosEvolution2		



1

código	526085	referencia	409999 411611 411965
descripción	portafiltro doble int.ø 61.7mm distancia de la boca de salida 48mm		
Para modelos:	Classica-PM, Classica-SA, Club, XeosEvolution2		
accesorios para	526085		
	código	529013	referencia —
	código	529014	referencia —
	código	529023	referencia —
	código	529079	referencia —
	código	529229	referencia —



1

código	526084	referencia	409998 411612 411964
descripción	portafiltro simple sin filtro sujeción ø 83.5mm int.ø 61.7mm altura cuña 11.2mm posición de cuñas horizontal cantidad de cuñas 2		
Para modelos:	Classica-PM, Classica-SA, Club, XeosEvolution2		

filtros

para 1 taza



1

código	527631	referencia	N/A
descripción	filtro de café ø 70mm montaje ø 60.7mm H 17mm tazas 1 cantidad de café 8g		

unidades de infusión

filtros de ducha

con reborde y orificio central



1

código	528472	referencia	355900
descripción	filtro para máquina de café ø 58mm H 11mm agujero ø 6mm		
Para modelos:	Classica-SA, Club, TwinStar2, XeosEvolution2		



juntas pra portafiltro

plano

estándar



1

código	526141	referencia	002710
descripción	junta portafiltro D1 ø 73.3mm D2 ø 57.1mm H 8.3mm NBR 80+5 UE 1 pzs		
Para modelos:	Classica-PM, Classica-SA, Club, XeosEvolution2		



1

código	526140	referencia	002700
descripción	junta portafiltro D1 ø 73.3mm D2 ø 57.1mm H 8mm NBR 80+5 UE 1 pzs		
Para modelos:	TwinStar2		

distanciadores



1

código	531250	referencia	—
descripción	distanciador D1 ø 73mm D2 ø 59mm espesor 0.5mm papel UE 20 pzs		

unidades de infusión con válvula magnética

boquillas



1

código	526131	referencia	411552
descripción	boquilla agujero ø 2mm rosca 1/4" latón		
Para modelos:	XeosEvolution2		

portaboquillas



1

código	528466	referencia	403456
descripción	portaboquillas rosca 1/4" latón EC 17		
Para modelos:	Classica-SA, Club, XeosEvolution2		

piezas sueltas

boquillas

con rosca



1

código	531071	referencia	410704
descripción	boquilla taladro ø 0.7mm rosca M6x1 L 60mm		
Para modelos:	TwinStar2		

arandelas



1

código	526135	referencia	411328
descripción	boquilla taladro ø 0.75mm ø ext. 7.5mm espesor 2mm		
Para modelos:	XeosEvolution2		

tornillos



1

código	560373	referencia	401983
descripción	tornillo de cabeza cilíndrica rosca M4 rosca L 12mm EC 3 inox UE 1 pzs soporte Allen hexagonal DIN 912/ISO 4762		
Para modelos:	Classica-SA, Club, XeosEvolution2		

distribuidores de agua

distribuidores de agua

grupo 2



1

código	526148	referencia	411969
descripción	distribuidor de agua ø 30mm agujero ø 1.2mm H 5.9mm ranuras 6		

grupo 3



1			
código	526114	referencia	4047401
descripción	distribuidor de agua ø 56.4mm H 10.2mm 6 orificios agujero ø 1.5mm rosca M5 sujeción ø 5.3mm taladro ø 8.75mm latón		



1			
código	528471	referencia	404740
descripción	distribuidor de agua ø 56.4mm H 9.2mm 6 orificios agujero ø 1.5mm rosca M5 sujeción ø 5.3mm taladro ø 8.75mm latón MK10		
Para modelos:	Classica-SA, Club, XeosEvolution2		



1			
código	531069	referencia	411968
descripción	distribuidor de agua ø 56.5mm H 12.5mm 4 orificios agujero ø 1mm rosca M5 sujeción ø 5.2mm taladro ø 8.7mm latón		

válvulas de expansión

con racor para tubo flexible



1			
código	526452	referencia	409774
descripción	válvula de expansión G1: 1/4" M tubo ø 9.5mm LC 42mm		
Para modelos:	Classica-PM, Classica-SA, Club, XeosEvolution2		

cubetas de desagüe

unidades de salida



1			
código	526118	referencia	411307
descripción	unidad de desagüe empalmes 4x tubo flexible/1x 3/8" tubo ø 8mm caño 1/2" ESPRESSO		
Para modelos:	TwinStar2		





1			
código	526117	referencia	410983
descripción	unidad de desagüe empalmes 5x tubo flexible/1x 3/8" tubo ø 8mm caño 1/2" MUG		
Para modelos:	TwinStar2		



1			
código	531068	referencia	411775
descripción	unidad de desagüe tubo ø 21mm		

cubetas de desagüe



1	código	526103	referencia	408390
	descripción	cubeta de desagüe juego ø 102mm H 41mm agujero ø 14.5mm apto para XEOS		
	Para modelos:	Classica-PM, Classica-SA, Club, XeosEvolution2		
	repuestos para	526103		
	código	526101	referencia	405386
	descripción	cubeta de desagüe ø 102mm H 41mm agujero ø 14.5mm tubo ø 19mm		
	código	526102	referencia	408160
	descripción	tubo de desagüe empalme 9mm G1: 1/2" plástico		



1	código	526104	referencia	409834
	descripción	cubeta de desagüe juego ø 102mm H 41mm agujero ø 14.5mm apto para XEOS		



1	código	526101	referencia	405386
	descripción	cubeta de desagüe ø 102mm H 41mm agujero ø 14.5mm tubo ø 19mm		
	Para modelos:	Classica-PM, Classica-SA, Club, XeosEvolution2		

tubos



1	código	526102	referencia	408160
	descripción	tubo de desagüe empalme 9mm G1: 1/2" plástico		
	Para modelos:	Classica-PM, Classica-SA, Club, XeosEvolution2		

calentadores de agua

grifos/válvulas de vaciado



1	código	526125	referencia	409147
	descripción	grifo de vaciado para calentador de agua empalme 3/8" latón		
	Para modelos:	XeosEvolution2		

grifos de vapor/agua

grifos de vapor/agua

grifos de vapor/agua



1	código	526124	referencia	430100V
	descripción	vapor/grifo entrada 3/8" M salida 3/8" M		



1	código	528451	referencia	4095901
	descripción	vapor/grifo entrada 3/8" salida M16x1,5 para CONTI		
	Para modelos:	Classica-PM, Classica-SA, Club		

grifos de vapor

grifos de vapor completos



1

código	526110	referencia	410952 430012
descripción	grifo de vapor completo entrada 3/8" salida M16x1,5 vapor		
Para modelos:	TwinStar2		

piezas sueltas

casquillos



1

código	526123	referencia	410703
descripción	casquillo para válvula magnética int.ø 1.7mm H 9.7mm rosca M7x1		
Para modelos:	TwinStar2		



1

código	526122	referencia	406316
descripción	casquillo para válvula magnética int.ø 2.65mm rosca M7x1		
Para modelos:	Classica-SA, TwinStar2		

juntas



1

código	528452	referencia	181100
descripción	disco de obturación D1 ø 14mm espesor 3.5mm goma		
Para modelos:	Classica-PM, Classica-SA, Club, XeosEvolution2		



1

código	526119	referencia	407502
descripción	junta D1 ø 13mm int.ø 5mm espesor 4mm EPDM		
Para modelos:	Classica-PM, Classica-SA, Club, TwinStar2, XeosEvolution2		

cuerpos de grifo



1

código	526134	referencia	405586
descripción	cuerpo de grifo G1: 3/8" G2: 3/8" con válvula magnética 230V		
Para modelos:	XeosEvolution2		



1

código	531152	referencia	470160V
descripción	cuerpo de grifo G1: 3/8" G2: 3/8" con válvula magnética 230V		



1

código	526121	referencia	405618
descripción	cuerpo de grifo G1: 3/8" H G2: 3/8" M		
Para modelos:	XeosEvolution2		

válvulas magnéticas



1

código	370556 ¹	referencia	405620 4056201
descripción	válvula magnética acero inoxidable 230VAC empalme M22x1 2 vías conector hembra DIN tipo de bobina BDV08220BW 50-60Hz		
Para modelos:	Classica-SA, Club, TwinStar2, XeosEvolution2		

¹carcasa de acero inox

tubos de agua



1

código	528460	referencia	410135
descripción	tubo de agua		
Para modelos:	TwinStar2, XeosEvolution2		



1

código	526111	referencia	411930
descripción	tubo de agua rosca M16x1,5 ø 23.5mm L 45mm EC 22		

tornillos de racor



1

código	526120	referencia	409594
descripción	tornillo de racor rosca M22x1,25 int.ø 10mm EC 24		
Para modelos:	Classica-PM, Classica-SA, Club		

accesorios

casquillos



1

código	526146	referencia	401320
descripción	casquillo D1 ø 13.6mm D2 ø 10.7mm H 3.6mm PTFE int.ø 7.05mm		
Para modelos:	Classica-PM, Classica-SA, Club, TwinStar2, XeosEvolution2		

tubos de vapor/agua

tubos de vapor



1

código	526112	referencia	410229 411063 411920
descripción	tubo de vapor rosca M16x1,5 H 140mm tubo ø 10mm		
Para modelos:	TwinStar2, XeosEvolution2		

filtros finos

filtros finos



1

código	528468	referencia	403458
descripción	filtro fino ø 8mm H 13.2mm		
Para modelos:	Classica-SA, Club, XeosEvolution2		



1

código	531070	referencia	410834
descripción	tubo de vapor rosca M16x1,5 H 175mm L 190mm tubo ø 8mm acero inoxidable para CONTI		
Para modelos:	TwinStar2, XeosEvolution2		

válvulas de llenado

válvulas de llenado



1

código	526133	referencia	409790
descripción	válvula de llenado agua con válvula antirretorno entrada 1/4" salida 3/8"		
Para modelos:	Club		



1			
código	528450	referencia	406090
descripción	válvula de llenado agua con válvula magnética		
Para modelos:	Classica-SA		

accesorios

juntas



1			
código	526119	referencia	407502
descripción	junta D1 ø 13mm int.ø 5mm espesor 4mm EPDM		
Para modelos:	Classica-PM, Classica-SA, Club, TwinStar2, XeosEvolution2		

otros



1			
código	528422	referencia	403473
descripción	esfera ø 8mm inox		
Para modelos:	Classica-PM, Classica-SA, Club, TwinStar2, XeosEvolution2		

mirillas de nivel

mirillas de nivel

juntas



1			
código	528444	referencia	233700
descripción	junta D1 ø 17mm int.ø 11mm H 4mm goma		
Para modelos:	Classica-PM, Classica-SA		



1			
código	528441	referencia	004700
descripción	junta goma ø ext. 21mm int.ø 11mm espesor 10mm para tubo de mirilla UE 1 pzs		

anillos de presión



1			
código	528445	referencia	233600
descripción	anillo de presión D1 ø 18mm D2 ø 12.15mm espesor 3mm latón mirilla		
Para modelos:	Classica-PM, Classica-SA		

tubos de mirilla



1			
código	526143	referencia	234000
descripción	tubo nivel de agua ø 11mm H 114.5mm int.ø 8mm rojo		
Para modelos:	Classica-PM, Classica-SA		



1			
código	528442	referencia	405831
descripción	tubo nivel de agua ø 11mm H 145mm MK10		

tubos

tubos



1			
código	526115	referencia	411776
descripción	tubo ø 6mm G1: 1/8" agua fría		

válvulas de retención

completo



1			
código	526127	referencia	409835
descripción	válvula de retención entrada 1/4" M salida 1/4" HL 37.6mm		
Para modelos:	Classica-PM, Classica-SA, Club, XeosEvolution2		



1			
código	526126	referencia	409125
descripción	válvula de retención entrada 1/4" salida 3/8" L 67mm		
Para modelos:	Club, XeosEvolution2		



1			
código	526129	referencia	4030652
descripción	válvula de retención entrada 1/8" salida 1/8" L 54mm		



uniones roscadas

tapas terminales



código	526100	referencia	409832
descripción	tapa terminal rosca 1/2" L 15mm EC 26 plástico con junta		
Para modelos:	Classica-PM, Classica-SA, Club, XeosEvolution2		

empalmes de tubo



código	526116	referencia	409831
descripción	empalme de tubos rosca 1/2" L 53mm tubo ø 15mm con junta		

pomos

grifos de vapor/agua

grifos de vapor/agua



código	111291	referencia	4081561
descripción	pomo ø 47mm eje ø 8.2mm negro		
Para modelos:	Classica-PM, Classica-SA, Club		
repuestos para	111291		
	código	111062	referencia 405615
	muelle de pomo L 20mm An 10mm H 11.5mm		

accesorios



código	111290	referencia	405284
descripción	pomo mando de selección 1/0/flecha ø 47mm eje 6x6		
Para modelos:	Classica-SA		
accesorios para	111290		
	código	111062	referencia 405615
	muelle de pomo L 20mm An 10mm H 11.5mm		



código	111291	referencia	4081561
descripción	pomo ø 47mm eje ø 8.2mm negro		
Para modelos:	Classica-PM, Classica-SA, Club		
repuestos para	111291		
	código	111062	referencia 405615
	muelle de pomo L 20mm An 10mm H 11.5mm		

otros



código	111290	referencia	405284
descripción	pomo mando de selección 1/0/flecha ø 47mm eje 6x6		
Para modelos:	Classica-SA		
accesorios para	111290		
	código	111062	referencia 405615
	muelle de pomo L 20mm An 10mm H 11.5mm		

accesorios

resortes para pomos



código	111062	referencia	405615
descripción	muelle de pomo L 20mm An 10mm H 11.5mm		
Para modelos:	Classica-PM, Classica-SA, Club		



código	526087	referencia	410635
descripción	resorte de compresión ø 10.7mm L 14.5mm espesor de hilo 0.7mm		
Para modelos:	TwinStar2, XeosEvolution2		

manillas y volantes

manillas



código	111078	referencia	405624
descripción	corredera		
Para modelos:	Classica-PM, Classica-SA		



1

código	526099	referencia	410873
descripción	palanca gris		
Para modelos:	TwinStar2		



1

código	526098	referencia	410099
descripción	palanca vapor		
Para modelos:	XeosEvolution2		

accesorios

otros



1

código	526086	referencia	408157
descripción	tapa terminal CONTI redondo rojo ø 23mm		
Para modelos:	Classica-PM, Classica-SA, Club		

juntas

juntas tóricas

EPDM



1

código	526824	referencia	087520
descripción	junta tórica EPDM espesor 1.9mm int.ø 5.7mm UE 1 pzs		
Para modelos:	Classica-PM, Classica-SA, Club, TwinStar2, XeosEvolution2		

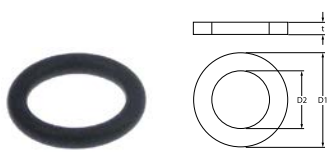

1

código	526107	referencia	055300
descripción	junta tórica EPDM espesor 2.7mm int.ø 12.1mm UE 1 pzs		
Para modelos:	Classica-PM, Classica-SA, Club, TwinStar2, XeosEvolution2		

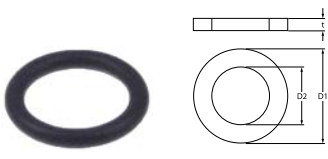

1

código	525109	referencia	061200
descripción	junta tórica EPDM espesor 2.7mm int.ø 13.6mm UE 1 pzs		
Para modelos:	Classica-PM, Classica-SA, Club, TwinStar2, XeosEvolution2		

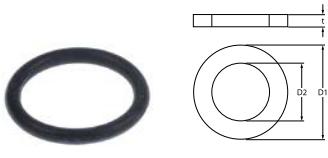

1

código	526109	referencia	411621
descripción	junta tórica EPDM espesor 2.7mm int.ø 18.4mm UE 1 pzs		

silicona

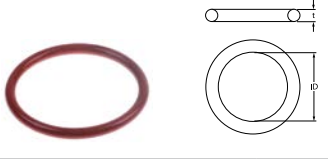

1

código	526108	referencia	4108841
descripción	junta tórica silicona espesor 6.3mm int.ø 56.5mm UE 1 pzs		
Para modelos:	TwinStar2		

Viton

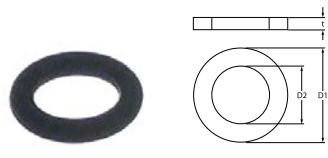

1

código	526105	referencia	405650
descripción	junta tórica Viton espesor 1.5mm int.ø 5mm UE 1 pzs		
Para modelos:	Club, XeosEvolution2		

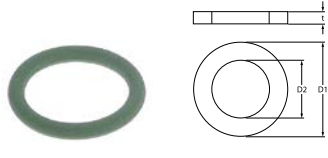

1

código	526142	referencia	409631
descripción	junta tórica Viton espesor 2mm int.ø 12mm UE 1 pzs		
Para modelos:	Classica-PM, Classica-SA, Club, TwinStar2, XeosEvolution2		

anillos de junta

juntas de goma

 <p>1</p>			
código	528441	referencia	004700
descripción	junta goma ø ext. 21mm int.ø 11mm espesor 10mm para tubo de mirilla UE 1 pzs		

juntas de cobre

DIN-7603-A

 <p>1</p>			
código	528197	referencia	406709
descripción	junta plana cobre ø ext. 10mm int.ø 6mm espesor 1mm UE 1 pzs		
Para modelos:	Classica-SA, Club, TwinStar2, XeosEvolution2		

 <p>1</p>			
código	526090	referencia	403475
descripción	junta plana cobre ø ext. 11.7mm int.ø 8.5mm espesor 1.3mm UE 1 pzs		
Para modelos:	Classica-PM, Classica-SA, Club, TwinStar2, XeosEvolution2		

 <p>1</p>			
código	526147	referencia	403459
descripción	junta plana cobre ø ext. 16.7mm int.ø 13.4mm espesor 0.8mm UE 1 pzs		

 <p>1</p>			
código	528467	referencia	403459
descripción	junta plana cobre ø ext. 18.5mm int.ø 13.5mm espesor 1mm		
Para modelos:	Classica-SA, Club, XeosEvolution2		

 <p>1</p>			
código	526092	referencia	403984
descripción	junta plana cobre ø ext. 20.8mm int.ø 17.3mm espesor 1.4mm		
Para modelos:	Club, XeosEvolution2		

 <p>1</p>			
código	526091	referencia	181300
descripción	junta plana cobre ø ext. 21mm int.ø 18.1mm espesor 1.4mm		
Para modelos:	Classica-PM, Classica-SA, Club, XeosEvolution2		

 <p>1</p>			
código	526093	referencia	411795
descripción	junta plana cobre ø ext. 25.8mm int.ø 21.5mm espesor 1.3mm		

<p>juntas de PTFE</p>  <p>1</p>			
código	526094	referencia	403081
descripción	junta plana PTFE ø ext. 17.3mm int.ø 12.2mm espesor 2.3mm UE 1 pzs		
Para modelos:	Classica-SA, Club, XeosEvolution2		

 <p>1</p>			
código	526095	referencia	408714
descripción	junta plana PTFE ø ext. 39.6mm int.ø 34.4mm espesor 2.9mm UE 1 pzs		
Para modelos:	Club, XeosEvolution2		

 <p>1</p>			
código	526096	referencia	410619
descripción	junta plana PTFE ø ext. 63.7mm int.ø 57.7mm espesor 2.5mm UE 1 pzs		
Para modelos:	TwinStar2		

 <p>1</p>			
código	526097	referencia	407709
descripción	junta plana PTFE ø ext. 75.8mm int.ø 68.4mm espesor 3.2mm UE 1 pzs		
Para modelos:	Classica-PM, Classica-SA, Club, XeosEvolution2		

juntas especiales

juntas de grupo



1

código	528465	referencia	N/A
descripción	junta D1 ø 42.5mm espesor 2mm para CONTI		



1

código	528464	referencia	N/A
descripción	junta de grupo D1 ø 90mm D2 ø 49mm espesor 2mm para CONTI		

muelles

resortes de compresión

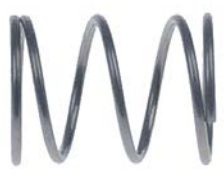

1

código	526087	referencia	410635
descripción	resorte de compresión ø 10.7mm L 14.5mm espesor de hilo 0.7mm		
Para modelos:	TwinStar2, XeosEvolution2		



1

código	526088	referencia	400012
descripción	resorte de compresión ø 12.7mm L 31.4mm espesor de hilo 1.4mm		
Para modelos:	Classica-PM, Classica-SA, TwinStar2, XeosEvolution2		



1

código	526089	referencia	403474
descripción	resorte de compresión ø 4.9mm L 17mm espesor de hilo 0.3mm		
Para modelos:	Club, TwinStar2		

manómetros



1

código	541262	referencia	425013
descripción	manómetro escala doble ø 63mm margen de presión 0-3 / 0-15bar empalme lado posterior rosca 1/8"		



1

código	541702	referencia	4115042
descripción	manómetro ø 40mm margen de presión 0-2,5bar rosca 1/8" marca 0,5-1,2 empalme lado posterior		



1

código	541705	referencia	404325
descripción	manómetro ø 62mm margen de presión 0-3bar empalme abajo marca 0,5-0,8 rosca 1/4"		
Para modelos:	Classica-SA, Club		



1

código	541703	referencia	4077101
descripción	manómetro ø 63mm margen de presión 0-2,5 / 0-16bar empalme lado posterior rosca 1/8" tubo		



1

código	541704	referencia	4108881
descripción	manómetro ø 63mm margen de presión 0-4 / 0-16bar empalme lado posterior rosca 1/8" tubos		



material de sujeción

tornillos

tuercas hexagonales



1

código	560083	referencia	401010
descripción	tornillo de cabeza hexagonal rosca M5 rosca L 10mm inox EC 8 UE 20 pzs DIN 933 / ISO 4017		
Para modelos:	Classica-PM, Classica-SA, Club, TwinStar2, XeosEvolution2		



1

código	560385	referencia	401012
descripción	tornillo de cabeza hexagonal rosca M5 rosca L 12mm inox EC 8 UE 1 pzs DIN 933 / ISO 4017		

tornillos de cabeza cilíndrica

DIN 912/ISO 4762



1

código	560373	referencia	401983
descripción	tornillo de cabeza cilíndrica rosca M4 rosca L 12mm EC 3 inox UE 1 pzs soporte Allen hexagonal DIN 912/ISO 4762		
Para modelos:	Classica-SA, Club, XeosEvolution2		



1

código	560402	referencia	071600
descripción	tornillo de cabeza cilíndrica rosca M5 rosca L 10mm L 15.5mm EC 4 inox UE 1 pzs soporte Allen DIN 912/ISO 4762		
Para modelos:	Classica-SA, Club, TwinStar2, XeosEvolution2		



1

código	560033	referencia	071100
descripción	tornillo de cabeza cilíndrica rosca M6 rosca L 20mm EC 5 inox UE 20 pzs DIN 912/ISO 4762		
Para modelos:	Classica-SA, Club, TwinStar2, XeosEvolution2		



1

código	560225	referencia	407016
descripción	tornillo de cabeza cilíndrica rosca M4 L 30mm rosca L 20mm EC 3 soporte Allen inox UE 1 pzs ø cabezal 7mm espesor cabezal 4mm DIN 912/ISO 4762		
Para modelos:	Classica-PM, Classica-SA, XeosEvolution2		

tuercas

tuercas hexagonales

tuercas hexagonales métricas (sin norma)



1

código	507464	referencia	402103
descripción	tuerca rosca M16x1,5 H 7mm EC 19 latón UE 1 pzs		
Para modelos:	Classica-PM, Classica-SA, Club		

tuercas hexagonales pulgadas



1

código	507463	referencia	407775
descripción	tuerca rosca 1/2" H 9.1mm EC 23 latón		
Para modelos:	Classica-PM, Classica-SA, Club, XeosEvolution2		

arandelas

arandelas

otros



1

código	528445	referencia	233600
descripción	anillo de presión D1 ø 18mm D2 ø 12.15mm espesor 3mm latón mirilla		
Para modelos:	Classica-PM, Classica-SA		

arandelas dentadas

DIN 6798A



1

código	503121	referencia	173600
descripción	arandela dentada int.ø 8.4mm ø ext. 15mm inox UE 1 pzs		

A

accesorios eléctricos	11
anillos de junta	21
arandelas	23
arandelas dentadas	23

B

bombas	11
bombas de aumento de presión II	11

C

cables	11
cables de cinta plana	11
cartuchos calentadores	3
contactores	5

F

flujómetros	11
fusibles	11

I

interruptores de llave	5
interruptores pulsantes y pulsadores	4
interruptores y pulsadores	4
interruptores/pulsadores basculantes	4

J

juntas tóricas	20
----------------	----

L

lámparas	5
lámparas de señalización	5
lámparas de señalización completas	5

M

material de sujeción	23
----------------------	----

P

presostatos	10
-------------	----

R

relés	6
resistencias	3
resistencias de máquinas de café	3

S

semiconductores de potencia	6
-----------------------------	---

T

termostatos	3
termostatos de superficie	3,4
termostatos de superficie de seguridad	3

tornillos	23
tornillos de cabeza cilíndrica	23
tuercas	23
tuercas hexagonales	23, 23

V

válvulas magnéticas	9
---------------------	---