



COMPONENTES GAS



COMPONENTES ELÉCTRICOS



TECNOLOGÍA DEL AGUA



COMPONENTES MECÁNICOS



HERRAMIENTAS

Repuestos adaptables a

FALCON

Encuentre nuestra gama siempre actualizada en la tienda online de GEV



Catálogo de fabricantes

Las piezas de repuesto y accesorios más importantes de cada fabricante reunidas y ordenadas de manera práctica

- ✓ En la tienda online GEV encontrará el surtido completo y toda la información actualizada de máquinas y aparatos
- ✓ Índice alfabético al final del catálogo

Tienda online GEV

www.gev-online.es
www.gev-online.com



- 🔍 marcar artículos como favoritos
- 🔍 acceso mediante su e-mail y su contraseña habitual
- 🔍 ponga en la cesta de la compra, múltiples artículos a la vez
- 🔍 búsqueda de artículos inmediata sin necesidad conectarse

resistencias

resistencias para hornos



código	418872	referencia	539110460
descripción	resistencia 1250W 240V L 370mm An 130mm H 40mm longitud brida 50mm anchura brida 38mm tubo ø 8.5mm longitud de empalme 30mm espirales 1 agujero ø 6mm empalme M4 pos. de montaje abajo espirales 3 brida rectangular resistencia seca horno		
Para modelos:	E350-30		

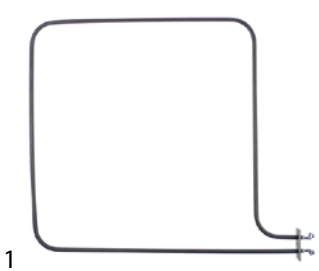

código	418873	referencia	539110450
descripción	resistencia 650W 240V L 505mm An 440mm L1 78mm L2 430mm B1 35mm B2 405mm longitud brida 57mm anchura brida 30mm dist. del agujero 18mm agujero ø 6mm tubo ø 8mm longitud de empalme 28mm empalme M4 espirales 1 brida rectangular resistencia seca horno		
Para modelos:	E350-30		

resistencias para sartenes basculantes



código	418875	referencia	731750420
descripción	resistencia sartén basculante 3200W 240V L 457mm An 185mm H 55mm empalme conector Faston 6,3mm resistencia seca espirales 1 tubo ø 8mm B1 210mm B2 36mm pos. de montaje derecho distancia de empalme 28mm		
Para modelos:	E1962, E1965, E1994, E1995, E2962, E2965, E2995		



código	418874	referencia	731750421
descripción	resistencia sartén basculante 3200W 240V L 457mm An 185mm H 55mm empalme conector Faston 6,3mm resistencia seca espirales 1 tubo ø 8mm B1 210mm B2 36mm pos. de montaje izquierdo distancia de empalme 28mm		
Para modelos:	E1962, E1965, E1994, E1995, E2962, E2965, E2995		

resistencias para salamandras / tostadores









código	415538	referencia	530102644
descripción	resistencia 2200W 230V espirales 1 L 365mm An 178mm empalme conector Faston 6,3mm distancia de empalme 172mm tubo ø 6.3mm resistencia seca H 6.3mm		

resistencias de inmersión

con brida de presión 50 x 26mm





código	415151	referencia	738010810
descripción	resistencia 2500W 230V brida de presión brida 50x26mm L 273mm espirales 1 H 30mm An 130mm L1 144mm L2 129mm empalme M4 resistencia de inmersión		
accesorios para	415151		
	código	510387	referencia —
	junta L 46mm An 22mm ømm EPDM para resistencia para brida 50x26mm		
	código	510388	referencia —
	contrabrida ømm dist. del agujeromm ø perforaciónmm L 43mm An 21mm inox para resistencia para brida 50x26mm		
	código	521103	referencia —
	tuerca rosca M4 H 3mm EC 7 latón UE 20 pzs		
	código	521104	referencia —
	arandela int.ø 4.3mm ø ext. 8mm espesor 0.5mm latón UE 20 pzs para rosca M4		
	código	560111	referencia —
	arandela int.ø 4.3mm ø ext. 9mm espesor 0.8mm inox UE 20 pzs DIN 125A para rosca M4		
	código	560131	referencia —
	tuerca hexagonal rosca M4 H 3.2mm EC 7 inox DIN/ISO DIN 934 / ISO 4032/8673 UE 20 pzs		

con brida redonda \varnothing 57,5mm

código	415849	referencia	730570002
descripción	resistencia 15000W 230V espirales 3 montaje \varnothing 57,5mm L 530mm An 45mm H 30mm brida redonda empalme M4 resistencia de inmersión tubo \varnothing 8,5mm longitud de empalme 15mm \varnothing casquillo portasondas 7mm casquillo portasondas 1 longitud casquillo portasondas 272mm casquillo termostato descentrado, ceñido		
accesorios para	415849		
	código	550002	referencia —
	estribo de fijación H 10mm L 21mm An 10mm agujero \varnothing 6,5mm para resistencia		



código	415848	referencia	730550004
descripción	resistencia 7500W 230V espirales 3 montaje \varnothing 57,5mm L 365mm An 36mm H 50mm brida redonda empalme M4 resistencia de inmersión tubo \varnothing 8,5mm \varnothing casquillo portasondas 7,5mm casquillo portasondas 1 longitud casquillo portasondas 270mm casquillo termostato descentrado, ceñido		
repuestos para	415848		
	código	510409	referencia 730590010
	junta tórica EPDM espesor 5,34mm int. \varnothing 56,52mm UE 1 pzs		
accesorios para	415848		
	código	550002	referencia —
	estribo de fijación H 10mm L 21mm An 10mm agujero \varnothing 6,5mm para resistencia		

resistencias circulación de aire



código	418739	referencia	530742414
descripción	resistencia 10500W 230V espirales 3 int. \varnothing 411mm \varnothing ext. 428mm L 480mm H 110mm L1 52mm B1 99mm H1 18mm H2 92mm longitud brida 130mm anchura brida 54mm dist. del agujero 55mm empalme M5 longitud de empalme 96mm tubo \varnothing 8,5mm resistencia circulación de aire rosca de sujeción M6 brida rectangular con pasador roscado		
accesorios para	418739		
	código	551240	referencia 530749451
	junta L 129mm An 87mm D1 \varnothing 12mm D2 \varnothing 7mm 12 orificios grafito espesor 1mm		



código	415828	referencia	730560000
descripción	resistencia 15000W 230V espirales 3 int. \varnothing 388mm \varnothing ext. 408mm L 428mm H 132mm L1 20mm B1 105mm H1 114mm H2 18mm longitud brida 140mm anchura brida 25mm dist. del agujero 126mm empalme M4 longitud de empalme 65mm tubo \varnothing 8,5mm resistencia circulación de aire agujero \varnothing 6,3mm brida rectangular		







código	419252	referencia	530584126
descripción	resistencia 2000W 230V espirales 1 int. \varnothing 180mm \varnothing ext. 193mm L 258mm H 25mm L1 60mm B1 30mm H1 7mm H2 18mm longitud brida 70mm anchura brida 22mm dist. del agujero 56mm empalme conector Faston 6,3mm longitud de empalme 55mm tubo \varnothing 6,5mm resistencia circulación de aire agujero \varnothing M4mm brida rectangular		

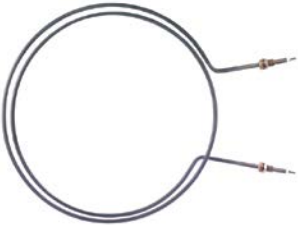

código	418959	referencia	530742422
descripción	resistencia 21600W 230V espirales 6 int. \varnothing 414mm \varnothing ext. 466mm L 522mm H 121,5mm L1 88mm B1 97mm H1 30,5mm H2 91mm longitud brida 130mm anchura brida 88mm empalme M5 longitud de empalme 70mm tubo \varnothing 6,5mm rosca de sujeción M6 brida con perno M6		
accesorios para	418959		
	código	551240	referencia 530749451
	junta L 129mm An 87mm D1 \varnothing 12mm D2 \varnothing 7mm 12 orificios grafito espesor 1mm		



1

código	418766	referencia	530595110
descripción	resistencia 4500W 230V espirales 1 int.ø 380mm ø ext. 405mm L 530mm L1 100mm H 17mm rosca M14x1,5 empalme M4 tubo ø 8.5mm		
repuestos para	418766		
	código	510417	referencia —
	junta plana fibra ø ext. 20mm int.ø 14mm espesor 2mm UE 1 pzs		
accesorios para	418766		
	código	520228	referencia —
	arandela dentada int.ø 15.3mm ø ext. 24mm acero UE 1 pzs para rosca M14		
	código	520230	referencia —
	tuerca rosca M14x1,5 H 5mm EC 19 acero zincado UE 1 pzs		
	código	521101	referencia —
	tuerca rosca M14x1,5 H 5mm EC 19 inox UE 1 pzs		
	código	550262	referencia —
	junta plana cobre ø ext. 20mm int.ø 14mm espesor 2mm		





1



código	415805	referencia	530693383
descripción	resistencia 5700W 230V espirales 3 int.ø 206mm ø ext. 245mm L 290mm H 42mm L1 45mm B1 97mm H1 2mm H2 40mm longitud brida 110mm anchura brida 20mm dist. del agujero 35mm empalme conector Faston 6,3mm longitud de empalme 58mm tubo ø 6.3mm resistencia circulación de aire agujero ø 6.5mm brida rectangular		



1





código	415221	referencia	530332429
descripción	resistencia 1430W 230V espirales 1 L 90mm An 390mm empalme conector Faston 6,3mm tubo ø 6.3mm rosca M10x1 sujeción 2 orificios resistencia seca distancia de sujeción 376mm		
repuestos para	415221		
	código	510416	referencia —
	junta plana fibra ø ext. 19mm int.ø 10.5mm espesor 1.5mm para rosca M10 UE 1 pzs		
accesorios para	415221		
	código	510893	referencia —
	junta tórica EPDM espesor 2.62mm int.ø 9.92mm UE 1 pzs		

accesorios para 415221

	código	520231	referencia —
	tuerca rosca M10x1 H 6mm EC 14 acero zincado UE 1 pzs		
	código	521129	referencia —
	tuerca rosca M10 H 6mm inox EC 17 UE 1 pzs DIN/ISO DIN 439		
	código	528433	referencia —
	junta plana cobre ø ext. 14mm int.ø 10mm espesor 1mm		



1

código	415222	referencia	530576581
descripción	resistencia 2300W 230V espirales 1 L 90mm An 395mm empalme M4 tubo ø 8.5mm rosca M14x1,5 sujeción 2 orificios resistencia seca		
accesorios para	415222		
	código	521103	referencia —
	tuerca rosca M4 H 3mm EC 7 latón UE 20 pzs		
	código	521104	referencia —
	arandela int.ø 4.3mm ø ext. 8mm espesor 0.5mm latón UE 20 pzs para rosca M4		
	código	560111	referencia —
	arandela int.ø 4.3mm ø ext. 9mm espesor 0.8mm inox UE 20 pzs DIN 125A para rosca M4		
	código	560131	referencia —
	tuerca hexagonal rosca M4 H 3.2mm EC 7 inox DIN/ISO DIN 934 / ISO 4032/8673 UE 20 pzs		



1

código	415542	referencia	530318084
descripción	resistencia 2500W 230V espirales 1 L 131mm An 485mm longitud de empalme 20mm empalme M4 tubo ø 8.5mm rosca M14x1,5 sujeción 2 orificios resistencia circulación de aire distancia de sujeción 480mm		
accesorios para	415542		
	código	510417	referencia —
	junta plana fibra ø ext. 20mm int.ø 14mm espesor 2mm UE 1 pzs		
	código	520228	referencia —
	arandela dentada int.ø 15.3mm ø ext. 24mm acero UE 1 pzs para rosca M14		
	código	520230	referencia —
	tuerca rosca M14x1,5 H 5mm EC 19 acero zincado UE 1 pzs		
	código	521101	referencia —
	tuerca rosca M14x1,5 H 5mm EC 19 inox UE 1 pzs		
	código	550262	referencia —
	junta plana cobre ø ext. 20mm int.ø 14mm espesor 2mm		

código	415543	referencia	530318083
descripción	resistencia 4000W 230V espirales 1 L 131mm An 485mm empalme M4 tubo ø 8.5mm rosca M14x1,5 sujeción 2 orificios resistencia seca		



código	490058	referencia	539110360
descripción	placa de cocción ø 180mm 2000W 240V		
Para modelos:	E350-30, E350-33		

placas de cocción

cuadrada y rectangular

otros



código	490199	referencia	703620 730960010
descripción	placa de cocción medidas 560x240mm 240V H 15mm empalme cable rectangular		
Para modelos:	E1100-3HP, E1100-4HP, E2101, E2101EU, E2101EU-OTC, E2102, E2121, E3101-3HP, E3101-4HP, E3101OTC-3HP, E3101OTC-4HP, E3121-3HP, E3121-4HP, E3161-3HP, E3161D		

redondas

con borde integrado

para cocinas domésticas y industriales



código	490183	referencia	735110010 820101 LD1/2
descripción	placa de cocción ø 180mm 1500W 240V empalme 4 bornes de rosca con borde de 8 mm		



código	490016	referencia	730960050
descripción	placa de cocción ø 180mm 2000W 230V empalme 4 bornes de rosca con borde de 8 mm		
Para modelos:	E1100-4HP, E2101, E2101EU, E2102, E2121		

reguladores de energía

EGO

a 1 circuito



código	380015	referencia	530314544
descripción	regulador de energía 230V 13A circuito simple sentido de rotación derecho eje ø 6x4,6mm eje L 23mm rosca de sujeción M4 liberación potencia 6-100% N° 50.57021.010		



código	380019	referencia	737630011 E2512/22 - LD22 R8549
descripción	regulador de energía 240V 13A circuito simple sentido de rotación derecho eje ø 6x4,6mm eje L 23mm rosca de sujeción M4 liberación potencia 6-100% N° 50.57071.010		
Para modelos:	E2512, E3512, E3532		



código	380879	referencia	731750770 E1036 R3799
descripción	regulador de energía 240V 13A sentido de rotación derecho eje ø 5x4mm eje L 14mm rosca de sujeción 1/8"		
Para modelos:	E1962, E1965, E1994, E1995		

termostatos

termostatos de superficie

otros



código	390866	referencia	734310270 R2025
descripción	termostato de seguridad dist. del agujeromm temp. desconexión°C 1NO 1 polosAV empalme conector Faston 6,3mm 3/4"		
Para modelos:	E4063, E4103, E4203		
repuestos para	390866		
	código	375442	referencia 737600711 C601275
	termostato de seguridad capilar 1760mm sonda ø 4mm 1 polos sonda L 100mm 16A aislamiento del capilar 1600mm prensaestopas temp. desconexión 320°C bulbo		

termostatos de control y seguridad

EGO

termostatos de regulación

serie 55.10/19_



código	375477	referencia	731750711
descripción	termóstato T máx 190°C margen de trabajo 48-190°C 1 polos 1NO 16A sonda ø 6mm sonda L 107mm capilar 1470mm aislamiento del capilarmm prensaestopas M9x1 eje ø 6x4,6mm eje L 23mm posición del eje arriba° posición del eje abajo ángulo de rotación 270°		
Para modelos:	E1962, E1965, E1994, E1995, E2962, E2965, E2994, E2995		

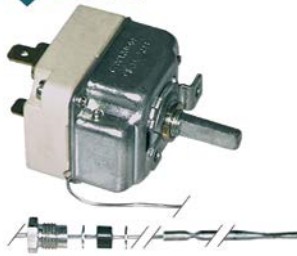

código	375070	referencia	530091634 EL091634
descripción	termóstato T máx 250°C margen de trabajo 55-250°C 1 polos 1CO 16A sonda ø 3.1mm sonda L 226mm capilar 1170mm aislamiento del capilar 1100mm prensaestopas M9x1 eje L 23mm posición del eje arriba ángulo de rotación 270°		

serie 55.13_



código	375677	referencia	737400541 C400541
descripción	termóstato T máx 195°C margen de trabajo 103-195°C 1 polos 1NO 16A sonda ø 4mm sonda L 157mm capilar 2250mm aislamiento del capilar 2020mm prensaestopas eje L 18mm posición del eje arriba ángulo de rotación 270°		



código	390843	referencia	731910500 RZZ451
descripción	termóstato T máx 291°C margen de trabajo 50-291°C 1 polos 1NO 16A sonda ø 3mm sonda L 160mm capilar 980mm aislamiento del capilar 600mm prensaestopas eje ø 6x4,6mm eje L 25mm posición del eje arriba ángulo de rotación 270° interruptor auxiliar 42.02900.000		
Para modelos:	E3800, E720RS1, E720RS2, E720RS3, G3800		



código	375505	referencia	539110370 539113110 R273
descripción	termóstato T máx 320°C margen de trabajo 50-320°C 1 polos 1NO 16A sonda ø 3mm sonda L 160mm capilar 870mm aislamiento del capilarmm prensaestopas eje ø 6x4,6mm eje L 23mm posición del eje arriba ángulo de rotación 270°		
Para modelos:	E3441, E3441R, E3481, E3481R, E350-30, E350-34, E350-35		

E-G-O



código	390862	referencia	732920055 R7091
descripción	termóstato T máx 90°C margen de trabajo 71-90°C 1 polos 1NO 16A sonda ø 3.1mm sonda L 201mm capilar 900mm aislamiento del capilar 120mm prensaestopas eje ø 6x4,6mm eje L 25mm posición del eje arriba ángulo de rotación 40°		
Para modelos:	E7204, E7208, E7211, G7204, G7208, G7211		

E-G-O



código	390833	referencia	731300190
descripción	termóstato T máx 190°C margen de trabajo 130-190°C 1 polos 1NO 16A sonda ø 6mm sonda L 115mm capilar 900mm aislamiento del capilar 120mm prensaestopas M9x1 eje ø 6x4,6mm eje L 25mm posición del eje arriba ángulo de rotación 270°		
Para modelos:	E1830, E1860		

serie 55.18_

E-G-O



código	390703	referencia	539113130 R5887
descripción	termóstato T máx 120°C margen de trabajo 32-110°C 1 polos 1NO 16A sonda ø 6mm sonda L 110mm capilar 870mm aislamiento del capilar 120mm prensaestopas M9x1 eje ø 6x4,6mm eje L 25mm posición del eje arriba ángulo de rotación 270° 240V		
Para modelos:	E3407, E350-42, E350-43, E350-49		

E-G-O

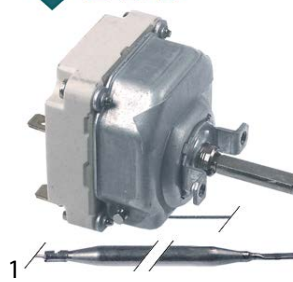

código	375428	referencia	539215840 735010330
descripción	termóstato T máx 190°C margen de trabajo 130-190°C 3 polos 3NO 16A sonda ø 6mm sonda L 219mm capilar 880mm aislamiento del capilar 120mm prensaestopas eje ø 6x4,6mm eje L 23mm posición del eje arriba ángulo de rotación 270°		
Para modelos:	E350-37, E350-38, E350-39		

E-G-O



código	390831	referencia	639052 731320106 R5520
descripción	termóstato T máx 190°C margen de trabajo 130-190°C 1 polos 1NO 16A sonda ø 6mm sonda L 113mm capilar 870mm aislamiento del capilar 120mm prensaestopas M9x1 eje ø 6x4,6mm eje L 25mm posición del eje arriba ángulo de rotación 270°		
Para modelos:	E3830, E3860		

termostatos de seguridad

serie 55.13_

E-G-O

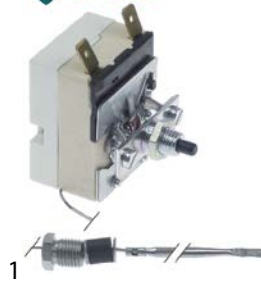

código	390845	referencia	610046 734311090
descripción	termóstato de seguridad temp. desconexión 132°C 1 polos 16A sonda ø 3.1mm sonda L 248mm capilar 830mm aislamiento del capilar 120mm prensaestopas M9x1 bulbo inox unión roscada M12x0,75		
Para modelos:	E4063, E4103, E4203		



código	390895	referencia	55.13519.190
descripción	termostato de seguridad temp. desconexión 60°C 1 polos 1NC 16A sonda ø 6mm sonda L 74mm capilar 520mm aislamiento del capilar 430mm prensaestopas bulbo		



código	375684	referencia	530550025
descripción	termostato de seguridad temp. desconexión 360°C 1 polos 20A sonda ø 11mm sonda L 16mm capilar 900mm aislamiento del capilar 900mm prensaestopas bulbo sonda roscada rosca sonda M14x1		

serie 55.32_



código	390159	referencia	530550024
descripción	termostato de seguridad temp. desconexión 150°C 1 polos 20A sonda ø 6mm sonda L 89mm capilar 900mm aislamiento del capilar 800mm prensaestopas bulbo		

serie 55.33_



código	390830	referencia	539113830 R6303
descripción	termostato de seguridad temp. desconexión 235°C 3 polos 3NC 20A sonda ø 6mm sonda L 108mm capilar 1470mm aislamiento del capilar 1100mm prensaestopas bulbo		
Para modelos:	E350-36, E350-37		



código	390921	referencia	530368679
descripción	termostato de seguridad temp. desconexión 305°C 3 polos 3NC 20A sonda ø 4mm sonda L 128mm capilar 890mm aislamiento del capilar 800mm prensaestopas bulbo		



código	375075	referencia	530336017
descripción	termostato de seguridad temp. desconexión 305°C 3 polos bulbo		



código	375118	referencia	530336027
descripción	termostato de seguridad temp. desconexión 360°C 3 polos 20A sonda ø 15mm sonda L 8mm capilar 1150mm aislamiento del capilar 1100mm prensaestopas bulbo con botón sensor		

serie 56...



código	375442	referencia	737600711 C601275
descripción	termostato de seguridad capilar 1760mm sonda ø 4mm 1 polos sonda L 100mm 16A aislamiento del capilar 1600mm prensaestopas temp. desconexión 320°C bulbo		



código	375688	referencia	536430023 539216220 639057 731320111 731350021 750038 802177 835127
descripción	termostato de seguridad temp. desconexión 230°C 1 polos 1NC 0.5A sonda ø 6mm sonda L 77mm capilar 700mm aislamiento del capilar prensaestopas M9x1 bulbo inox		
Para modelos:	E3830, E3840, E3860, E401, E401F, E402, E402F, E421, E421F, E422, E422F, G2845F, G350-11, G350-12		



código	390832	referencia	600575 731310135
descripción	termostato de seguridad temp. desconexión 230°C 1 polos 1NC 0.5A sonda ø 6mm sonda L 77mm capilar 700mm aislamiento del capilar prensaestopas M9x1 bulbo Kit		
Para modelos:	E1830, E1860		
repuestos para	390832		
código	375688	referencia	536430023 539216220 639057 731320111 731350021 750038 802177 835127
descripción	termostato de seguridad temp. desconexión 230°C 1 polos 1NC 0.5A sonda ø 6mm sonda L 77mm capilar 700mm aislamiento del capilar prensaestopas M9x1 bulbo inox		



código	390829	referencia	537300025 537300060 801499 801768
descripción	termostato de seguridad temp. desconexión 240°C 1 polos 1NC 16A sonda ø 6mm sonda L 77mm capilar 700mm aislamiento del capilar prensaestopas M9x1 bulbo		
Para modelos:	E3407, G1008X, G1830-MK2, G1838X, G1848X, G1860-CE, G1860-MK2, G1865		



código	390828	referencia	535770070 802052
descripción	termostato de seguridad temp. desconexión 245°C 1 polos 1NC 16A sonda ø 6mm sonda L 78mm capilar 700mm aislamiento del capilarmm prensaestopas M9x1 bulbo		
Para modelos:	G2840, G2841, G2842		



código	390860	referencia	535670017 638038
descripción	termostato de seguridad temp. desconexión 245°C 1 polos 1NC 16A sonda ø 6mm sonda L 78mm capilar 750mm aislamiento del capilarmm prensaestopas M9x1 bulbo		
Para modelos:	G3203, G3206, G3830, G3860, G3865		
repuestos para	390860		
	código	390828	referencia 535770070 802052
	termostato de seguridad temp. desconexión 245°C 1 polos 1NC 16A sonda ø 6mm sonda L 78mm capilar 700mm aislamiento del capilarmm prensaestopas M9x1 bulbo		



código	375889	referencia	530504602
descripción	termostato de seguridad temp. desconexión 360°C 1 polos 16A sonda ø 15mm sonda L 6.5mm capilar 1140mm aislamiento del capilar 1100mm prensaestopas bulbo		
accesorios para	375889		
	código	518669	referencia —
	junta PTFE ø ext. 21mm int.ø 15mm espesor 3.5mm		

termostatos de regulación con interruptor auxiliar

serie 55.13_



código	390844	referencia	600048 600406 732910210 732920049 735400230
descripción	termóstato margen de trabajo 50-291°C 1 polos 1NO 16A sonda ø 3mm sonda L 160mm capilar 980mm aislamiento del capilar 600mm prensaestopas eje ø 6x4,6mm eje L 25mm posición del eje arriba ángulo de rotación 270° interruptor auxiliar 42.02900.000		
Para modelos:	E4069EL, E4109EL, E7202E, E7202S, E7204, E7208, E7211, G7204, G7208, G7211		



código	390848	referencia	732910090 802450
descripción	termóstato margen de trabajo 50-291°C 1 polos 1NO 16A sonda ø 3mm sonda L 160mm capilar 980mm aislamiento del capilar 600mm prensaestopas eje ø 6x4,6mm eje L 25mm posición del eje arriba ángulo de rotación 270° interruptor auxiliar 42.02900.000		
Para modelos:	E7202, E7202S		
repuestos para	390848		
	código	301115	referencia 732910481 RZZ277
	conmutador de levas 2 posiciones de conmutación 2NO secuencia de conmutación 0-1 16A eje ø 6x4,6mm eje L 23mm empalme conector Faston 6,3mm		
	código	390843	referencia 731910500 RZZ451
	termostato T máx 291°C margen de trabajo 50-291°C 1 polos 1NO 16A sonda ø 3mm sonda L 160mm capilar 980mm aislamiento del capilar 600mm prensaestopas eje ø 6x4,6mm eje L 25mm posición del eje arriba ángulo de rotación 270° interruptor auxiliar 42.02900.000		

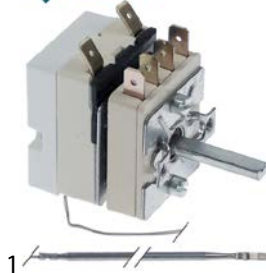

código	390834	referencia	535420006 731050004 G2101 R4753
descripción	termóstato margen de trabajo 50-320°C 1 polos 1NO 16A sonda ø 3mm sonda L 160mm capilar 870mm aislamiento del capilarmm prensaestopas eje ø 6x4,6mm eje L 23mm posición del eje derecho ángulo de rotación 270° interruptor auxiliar 2NO		
Para modelos:	E2101EU-OTC, E2914i, E3101OTC-3HP, E3101OTC-4HP, E3914i, G2101OTC, G3101OTC, G3106		

INVENSYS / ROBERTSHAW

termostatos de regulación



código	390863	referencia	536012313 736009730 G12313 G9730
descripción	termóstato T máx 142°C margen de trabajo 0-142°C 1 polos 1NO 25A sonda ø 13mm sonda L 230mm capilar 1200mm aislamiento del capilarmm prensaestopas 3/8" NPT eje ø 6x4,6mm eje L 24mm posición del eje abajo ángulo de rotación 315° material de bulbo cobre 288°F		



código	390838	referencia	535710029 537320120 R3758
descripción	termóstato T máx 190°C margen de trabajo 90-190°C 1 polos 1NO 0.67A sonda ø 9.5mm sonda L 95mm capilar 900mm aislamiento del capilarmm prensaestopas 1/4" eje ø 6x4,6mm eje L 23mm posición del eje abajo ángulo de rotación 315° temp.máx. 374°F campo de trabajo 195-374 °F		
Para modelos:	G1008X, G1830-MK2, G1838X, G1848X, G1860-MK2, G1865		

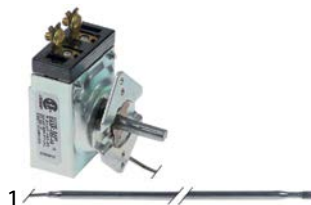

código	390835	referencia	730962080 RKK4A
descripción	termóstato T máx 287°C margen de trabajo 93-287°C 1 polos 1NO 30A sonda ø 4.6mm sonda L 290mm capilar 1200mm aislamiento del capilarmm prensaestopas eje ø 6x4,6mm eje L 23mm posición del eje abajo ángulo de rotación 315° temp.máx. 550°F campo de trabajo 200-550 °F		
Para modelos:	E1100-3HP, E1100-4HP, E2101, E2101EU, E2117, E3101-3HP, E3101-4HP, E3117, E3161-3HP		

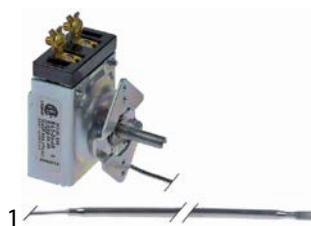

código	390837	referencia	731880190 RKK4
descripción	termóstato T máx 287°C margen de trabajo 93-287°C 1 polos 1NO 30A sonda ø 4.7mm sonda L 290mm capilar 1200mm aislamiento del capilarmm prensaestopas eje ø 6x4,6mm eje L 23mm posición del eje abajo ángulo de rotación 315° campo de trabajo 200-550 °F		

termostatos de seguridad



código	390861	referencia	736094161 G94161
descripción	termóstato de seguridad temp. desconexión 129.5°C margen de trabajo°C 1 polos 1COA sonda ø 6.3mm sonda L 133mm capilar 600mm aislamiento del capilarmm prensaestopas 1/4" NPT eje ømm bulbo inox		

diversos

termostatos de regulación



1

código	390865 ¹	referencia	537350034 600926
descripción	termóstato T máx 190°C margen de trabajo 48-190°C 1 polos 1NOA sonda ø 6mm sonda L 110mm capilar 1445mm aislamiento del capilarmm prensaestopas M9x1 eje ø 6x4,6mm eje L 22mm posición del eje derecho ángulo de rotación 270° material de bulbo inox Kit		

¹con accesorios



1

código	390842 ¹	referencia	531740350 600096
descripción	termostato de contacto T máx 250°C margen de trabajo 100-250°C 1 polos 1NOA sonda ø 4mm sonda L 133mm capilar 1300mm aislamiento del capilar 950mm prensaestopas eje ø 6x4,6mm eje L 23mm posición del eje izquierdo ángulo de rotación 290° Austauschset		
Para modelos:	G1112		

¹con accesorios

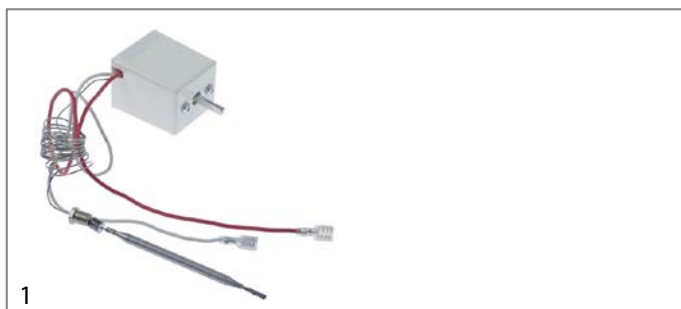

1

código	390864 ¹	referencia	535670014 R5850
descripción	termostato de seguridad temp. desconexión°C 1 polos 1NOA sonda ø 6mm sonda L 110mm capilar 1445mm aislamiento del capilarmm prensaestopas M9x1 eje ø 6x4,6mm bulbo inox margen de ajuste 270°C		
Para modelos:	G3830, G3860, G3865		

¹con accesorios

termostatos de seguridad



1

código	390724	referencia	531750502 701255
descripción	termostato de seguridad temp. desconexión 266°C margen de trabajo°C 1 polos 1NCA sonda ø 6mm sonda L 60mm capilar 880mm aislamiento del capilarmm prensaestopas M9x1 eje ø 6mm material de bulbo inox longitud del cable 900mm Austauschset		
Para modelos:	E2962, E2965, E2994, E2995, G1965, G1995, G2962, G2965, G2994, G2995		



1

código	390840 ¹	referencia	537350030 600919
descripción	termostato de seguridad temp. desconexión°C 1 polos 1NCA sonda ø 6mm sonda L 78mm capilar 700mm aislamiento del capilarmm prensaestopas M9x1 bulbo inox Austauschset		

repuestos para	390840		
-----------------------	--------	--	--

código	390841	referencia	536300036 750080
---------------	--------	-------------------	---------------------

descripción	termostato de seguridad temp. desconexión°C margen de trabajo°C 1 polos 1NCA sonda ø 6mm sonda L 78mm capilar 700mm aislamiento del capilarmm prensaestopas M9x1 bulbo inox		
--------------------	---	--	--

¹con accesorios



1

código	390839 ¹	referencia	537350031 600920
descripción	termostato de seguridad temp. desconexión°C 1 polosA sonda ø 6mm sonda L 78mm capilar 700mm aislamiento del capilarmm prensaestopas M9x1 bulbo inox Austauschset		

repuestos para	390839		
-----------------------	--------	--	--

código	390841	referencia	536300036 750080
---------------	--------	-------------------	---------------------

descripción	termostato de seguridad temp. desconexión°C margen de trabajo°C 1 polos 1NCA sonda ø 6mm sonda L 78mm capilar 700mm aislamiento del capilarmm prensaestopas M9x1 bulbo inox		
--------------------	---	--	--

¹con accesorios



1

código	390841 ¹	referencia	536300036 750080
descripción	termostato de seguridad temp. desconexión°C margen de trabajo°C 1 polos 1NCA sonda ø 6mm sonda L 78mm capilar 700mm aislamiento del capilarmm prensaestopas M9x1 bulbo inox		
Para modelos:	G3840, G401, G401F, G402, G402F		

¹con accesorios



interruptores y pulsadores

accesorios

pedales



1

código	347761	referencia	531860070 700108
descripción	pedal para interruptor de aire comprimido ø 92.5mm longitud de tubo 2150mm tubo ø 3/6mm		
Para modelos:	E1965, E1995, E2965, E2995, G1965, G1995, G2965, G2995		

microinterruptores

universal



1

código	345042	referencia	530570540
descripción	microinterruptor con varilla 250V 16A 1CO empalme conector Faston 6,3mm L 28mm temperatura ambiente máx. 125°C distancia de sujeción 22mm tipo EF83161.3 fuerza de accionamiento: 75g azul/negro		
accesorios para	345042		
	código	referencia	—
	juego de palancas 5 piezas		

accionado por palanca



1

código	347758	referencia	531925260 R7391
descripción	microinterruptor con manilla 250V 5A 1CO empalme con cable L 35mm temperatura ambiente máx. 85°C distancia de sujeción 22mm con cable 500mm tipo V3SY1UL fuerza de accionamiento: 160g longitud de palanca 25mm		
Para modelos:	E7204, E7208, E7211, G7004, G7011, G7204, G7208, G7211		



1

código	345255	referencia	531750540 731750540 RAA20/5
descripción	microinterruptor con manilla 250V 16A 1CO empalme conector Faston 6,3mm L 35mm L1 28mm temperatura ambiente máx. 125°C distancia de sujeción 22mm fuerza de accionamiento: 136g longitud de palanca 27mm		
Para modelos:	E1962, E1965, E1994, E1995, E2962, E2965, E2994, E2995, E3800, G1962, G1965, G1994, G1995, G2962, G2965, G2994, G2995, G3800		

accionados por pistón



1

código	345042	referencia	530570540
descripción	microinterruptor con varilla 250V 16A 1CO empalme conector Faston 6,3mm L 28mm temperatura ambiente máx. 125°C distancia de sujeción 22mm tipo EF83161.3 fuerza de accionamiento: 75g azul/negro		
accesorios para	345042		
	código	referencia	—
	juego de palancas 5 piezas		



1

código	347793	referencia	735011060 R466
descripción	microinterruptor con varilla 250V 16A 1NO empalme conector Faston 6,3mm temperatura ambiente máx. 85°C distancia de sujeción 22mm tipo XGA52-88 fuerza de accionamiento: 280g verde/gris		

M10



1

código	345032	referencia	730580003
descripción	microinterruptor con varilla rosca M10x1 rosca L 12mm 250V 16A 1CO empalme conector Faston 6,3mm carrera 7mm distancia de sujeción 22mm L 28mm temperatura ambiente máx. 125°C tipo SP9603 fuerza de accionamiento: 180g		

M16



1

código	345046	referencia	530092444
descripción	microinterruptor con varilla rosca M16x1 rosca L 25mm 250V 5A 1NC/1NO empalme conector Faston 6,3mm carrera 6mm temperatura ambiente máx. 85°C fuerza de accionamiento: 400g		

comutadores de levas

conect./desc.

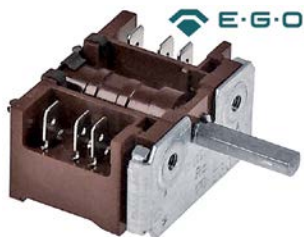

1

código	301115	referencia	732910481 RZZ277
descripción	comutador de levas 2 posiciones de conmutación 2NO secuencia de conmutación 0-1 16A eje ø 6x4,6mm eje L 23mm empalme conector Faston 6,3mm		

4 posiciones





1

código	300022	referencia	537850020 RPP11/1
descripción	comutador de levas 4 posiciones de control 2CO secuencia de conmutación 0-1-2-3 16A eje ø 6x4,6mm eje L 23mm empalme atornillado		

7 posiciones



1

código	300025	referencia	539110400
descripción	comutador de levas 7 posiciones de conmutación 1NO/2CO secuencia de conmutación 0-1-2-3-4-5-6 16A eje ø 6x4,6mm eje L 23mm empalme atornillado 7 posiciones cerámica		
Para modelos:	E350-30, E350-33		
accesorios para	300025		
	código	112172	referencia —
	pomo universal ø 70mm negro sin adaptador/símbolo		
	código	112213	referencia —
	símbolo para pomo plata interruptor 7 posiciones T máx°C ø ext. 63mm int.ø 45.5mm		
	código	112311	referencia —
	adaptador de pomo eje ø 6x4,6mm L 0mm con muelle		



1

código	300271	referencia	539110420
descripción	comutador de levas 7 posiciones de conmutación 1NO/2CO secuencia de conmutación 0-1-2-3-4-5-6 16A eje ø 6x4,6mm eje L 23mm empalme atornillado 7 posiciones cerámica con pomo		
Para modelos:	E350-30, E350-33		

4 posiciones de conmutación

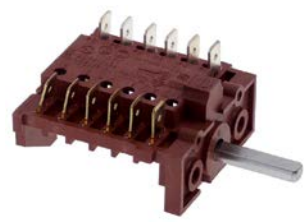

1

código	300057	referencia	530292664
descripción	comutador de levas 4 posiciones de control 6NO secuencia de conmutación 0-1-2-3 16A eje ø 6x4,6mm eje L 23mm empalme conector Faston 6,3mm 6CH/141 plástico		

interruptores de contacto



1

código	346388	referencia	530550040
descripción	interruptor de contacto 1NOVA para horno a vapor combinado L 47mm An 20mm H 30mm		

interruptores magnéticos

27x25mm

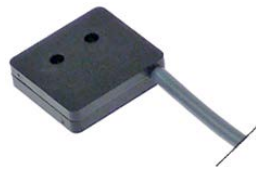

1

código	347759	referencia	735750014 R5337
descripción	interruptor magnético L 27mm An 25mm 1NO 24V 0.4A P máx. 9.6W empalme cable longitud del cable 300mm		
Para modelos:	E2203, E2206, E2207, E3830, E3840, E3860, E401, E401F, E402, E402F, E421F, E422F		

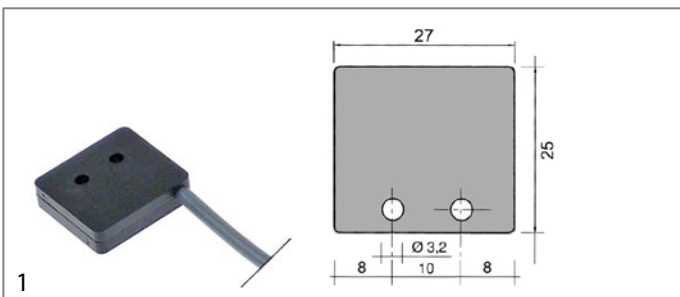

código	347760	referencia	601036 731300240
descripción	interruptor magnético L 27mm An 25mm 1NO 24V 0.4A P máx. 9.6W empalme cable longitud del cable 300mm		
repuestos para	347760		
	código	347759	referencia 735750014 R5337
descripción	interruptor magnético L 27mm An 25mm 1NO 24V 0.4A P máx. 9.6W empalme cable longitud del cable 300mm		

37x16mm

código	347790	referencia	530550041
descripción	interruptor magnético L 37mm An 16mm 1NO 250V empalme cable longitud del cable 1960mm 10W con imán nominal 0.04A		

M12x1

código	345135	referencia	530320048
descripción	interruptor magnético rosca M12x1 1NO 250V 3A P máx. 100W empalme cable longitud del cable 2000mm L 72mm tipo 122		

bloques de contacto

código	359184	referencia	530320024
descripción	bloque de contacto a impulso 1NC/1NO empalme conector Faston 2,8mm casquillo tipo AT		

código	359756	referencia	530320070
descripción	bloque de contacto con enclavamiento 1NO/1NC empalme conector Faston 2,8mm iluminable casquillo T5.5K tipo BFL5		
accesorios para	359756		
	código	359593	referencia —
descripción	bombilla incandescente casquillo T5.5K 60V 0.02A		

codificadores y potenciómetros

código	300263	referencia	530338536
descripción	codificador ángulo de rotación 360° eje ø 6mm eje L 13mm 0.1W		

código	403084	referencia	730580022
descripción	codificador eje L 18mm longitud del cable 200mm eje 6x4,6mm		

lámparas

lámparas de señalización

lámparas de señalización completas

ø 6mm

código	359005	referencia	530332798
descripción	lámpara de señalización ø 6mm 230V amarillo longitud del cable 400mm		

aparatos de mando y aviso

SCHLEGEL

teclas

código	346188	referencia	530320069
descripción	unidad de pulsador medida de montaje ø16/24x24mm tipo a impulso negro/blanco cuadrado		

			
1			
código	359004	referencia	530332771
descripción	lámpara de señalización ø 6mm 230V verde longitud del cable 400mm resis.a la temp. 106°C		

ø10mm

con casquillo roscado

			
1			
código	359524	referencia	539110430 731750480
descripción	lámpara de señalización ø 10mm 230V amarillo empalme conector Faston 6,3mm		
Para modelos:	E1962, E1965, E1994, E1995, E350-30, E350-34, E350-35, E350-36, E350-37, E350-38, E350-39, E350-40, E350-41, E350-42, E350-43, E350-49		

			
1			
código	359237	referencia	539110440 731750490
descripción	lámpara de señalización ø 10mm 230V rojo empalme conector Faston 6,3mm		
Para modelos:	E1962, E1965, E1994, E1995, E350-30, E350-33, E350-34, E350-35, E350-36, E350-37, E350-38, E350-39, E350-40, E350-41, E350-42, E350-43, E350-49		

			
1			
código	357261	referencia	730962010
descripción	lámpara de señalización montaje ø 10mm rojo 230VAC empalme 6,3x0,8 protección IP67 temperatura ambiente máx. 105°C		
Para modelos:	E1100-3HP, E1100-4HP, E3407, E3441, E3441R, E3481, E3481R, E3800, E3862, G3800		

			
1			
código	346883	referencia	730962040
descripción	lámpara de señalización ø 10mm 230V amarillo empalme conector Faston 6,3mm		
Para modelos:	E1100-3HP, E1100-4HP, E3405, E3800, E3862, G3800		

			
1			
código	346881	referencia	537810060 700025 731000008
descripción	lámpara de señalización ø 10mm 230V rojo empalme conector Faston 6,3mm		
Para modelos:	E2101, E2101EU, E2101EU-OTC, E2117, E2121, E2161EU, E2914i, E2962, E2965, E2994, E2995, E3101-3HP, E3101-4HP, E3101OTC-3HP, E3101OTC-4HP, E3117, E3121-3HP, E3121-4HP, E3161-3HP, E3161D, E3913i, E3914i, G2962, G2965, G2994, G2995		

con casquillo enchufable

			
1			
código	359140	referencia	530091642
descripción	lámpara de señalización ø 10mm amarillo 230V empalme conector Faston 6,3mm UE 1 pzs		

lámpade

bombillas incandescentes

para hornos

			
1			
código	359612	referencia	530354252
descripción	bombilla incandescente T máx 300°C casquillo E14 25W 230V ø 25mm L 56mm cristal L 30mm para lámpara de horno tipo Philips		

			
1			
código	359611	referencia	531740340 RGG22/9
descripción	bombilla incandescente T máx 300°C casquillo E14 40W 230V ø 45mm L 75mm cristal L 50mm para lámpara de horno IMPORT		
Para modelos:	E2102, E2112, G1112, G2102, G2112		

otros

			
1			
código	362023	referencia	530581488
descripción	bombilla incandescente casquillo T5.5K 48V 1.2W 0,025A		

lámparas halógenas

para portalámpara G4 / G6,35 / G9

			
1			
código	359596	referencia	530571954 EL571954
descripción	lámpara halógena casquillo G4 12V 10W resis.a la temp. 500°C		

			
código	359599	referencia	530570478
descripción	lámpara halógena casquillo G4 12V 20W resis.a la temp. 500°C		

lámparas tubulares

lámparas infrarrojas

con casquillo tipo Z cerámica

			
código	359539 ¹	referencia	539215170 R3593
descripción	lámpara infrarroja casquillo Z-cerámica L 218mm 240V 500W longitud del cable 205mm con tubo de protección		

¹con vidrio doble

lámparas para hornos

lámparas de horno universales

diámetro de montaje 35,5mm

			
código	359705	referencia	530092339
descripción	cubierta para lámpara de horno r.ø 33.5mm ø 52mm vidrio duro resis.a la temp. 350°C		
accesorios para	359705		
	código	359610	referencia —
	bombilla incandescente T máx 300°C casquillo E14 15W 230V ø 22mm L 47mm cristal L 20mm para lámpara de horno tipo Philips		
	código	359700	referencia —
	junta para horno de pizza fibra de vidrio int.ø 32.5mm ø ext. 55mm espesor 5mm		
	código	359721	referencia 530693421
	junta silicona ø ext. 48mm int.ø 39.5mm espesor 5mm UE 1 pzs		
	código	359837	referencia —
	junta int.ø 33mm ø ext. 46mm espesor 1mm grafito		
	código	359838	referencia —
	junta int.ø 33mm ø ext. 45mm		

			
código	359721	referencia	530693421
descripción	junta silicona ø ext. 48mm int.ø 39.5mm espesor 5mm UE 1 pzs		

55x70mm			
			
código	359375	referencia	730580020
descripción	portalámparas completo sin lámpara casquillo E14 medida de montaje 55x70mm		

lámparas

bombillas incandescentes

			
código	359612	referencia	530354252
descripción	bombilla incandescente T máx 300°C casquillo E14 25W 230V ø 25mm L 56mm cristal L 30mm para lámpara de horno tipo Philips		

			
código	359611	referencia	531740340 RGG22/9
descripción	bombilla incandescente T máx 300°C casquillo E14 40W 230V ø 45mm L 75mm cristal L 50mm para lámpara de horno IMPORT		
Para modelos:	E2102, E2112, G1112, G2102, G2112		

lámparas halógenas

para portalámpara G4 / G6,35 / G9

			
código	359596	referencia	530571954 EL571954
descripción	lámpara halógena casquillo G4 12V 10W resis.a la temp. 500°C		

			
código	359599	referencia	530570478
descripción	lámpara halógena casquillo G4 12V 20W resis.a la temp. 500°C		



casquillos

G4 / G5,3 / G6,35



1

código	359646	referencia	530577294
descripción	portalámparas casquillo G4/G5,3/G6,35 24V ø 17mm H 15mm empalme cable 130mm distancia de sujeción 26mm para lámpara halógena longitud del soporte 31mm longitud del cable 130mm		

temporizadores

temporizadores eléctricos



1

código	350001	referencia	530330006
descripción	temporizador 2CO a 250 V 16A posición permanente presente accionamiento eléctrico eje ø 6x4,6mm eje L 22mm distancia de sujeción 28mm empalme atrás 2 polos tiempo de funcionamiento 120min		

temporizadores mecánicos



1

código	350186	referencia	731910460 804014
descripción	temporizador M2 2 polos tiempo de funcionamiento 120min accionamiento mecánico 2CO a 250 V 16A posición permanente presente eje ø 6x4,6mm eje 6x4,6mm eje L 23mm distancia de sujeción 28mm		
Para modelos:	E7002, E7202S		
accesorios para	350186		
	código	112627	referencia —
	pomo tiempo 120min ø 58mm eje ø 6x4,6mm parte plana abajo		



1

código	350193	referencia	531930460 804012
descripción	temporizador M2 2 polos tiempo de funcionamiento 720min accionamiento mecánico 2CO a 250 V 16A posición permanente no eje ø 6x4,6mm eje 6x4,6mm eje L 22mm distancia de sujeción 28mm rosca de sujeción 28 empalme conector Faston 6,3mm		
Para modelos:	E7004, E7008, E7011, G7004, G7008, G7011		

señalizadores de alarma

zumbadores



1

código	350051	referencia	530348002
descripción	zumbador 230VAC empalme conector Faston 6,3mm atornillado rosca M4 zumbador 62dB		

contactores

BENEDIKT & JÄGER

contactores de potencia



1

código	381161	referencia	535420013 RZZ228
descripción	contactor de potencia AC1 20A 230VAC (AC3/400V) 9A/5kW contactos principales 3NO contactos auxiliares 1NO empalme empalme atornillado tipo K1-09D10		
Para modelos:	G2101OTC		



1

código	381079	referencia	731750850
descripción	contactor de potencia AC1 25A 230VAC (AC3/400V) 16A/7,5kW contactos principales 3NO contactos auxiliares 1NO empalme empalme atornillado tipo K2-16A10230		
Para modelos:	E1962, E1965, E1994, E1995		



1

código	380774	referencia	731750860
descripción	contactor de potencia AC1 32A 230VAC (AC3/400V) 18A/7,5kW contactos principales 3NO contactos auxiliares 1NO empalme empalme atornillado tipo K3-18ND10		
Para modelos:	E2962, E2965, E2994, E2995		



ISKRA (FANAL)

contactores de potencia



código	380214	referencia	530332682
descripción	contactor de potencia AC1 20A 230VAC (AC3/400V) 8,5A/5,5kW contactos principales 3NO contactos auxiliares 1NO empalme empalme atornillado tipo FANAL DSL7 00 tipo ISKRA K07M 00		

MOELLER/EATON

contactores de potencia



código	380550	referencia	530550034
descripción	contactor de potencia AC1 20A 230VAC (AC3/400V) 9A/4kW contactos principales 3NO contactos auxiliares 1NC empalme empalme atornillado tipo DILM9 01		

accesorios para 380550



código	380555	referencia	—
descripción	contacto auxiliar contactos 2NO/2NC AC15 16A para contactores DILEM empalme atornillado tipo DILA-XHI22		



código	380556	referencia	—
descripción	contacto auxiliar contactos 4NO AC15 16A para contactores DILM 7-32 empalme atornillado tipo DILA-XHI40		



código	380557	referencia	—
descripción	contacto auxiliar contactos 4NC AC15 16A para contactores DILM 7-32 empalme atornillado tipo DILA-XHI04		



código	380558	referencia	—
descripción	contacto auxiliar contactos 3NO/1NC AC15 16A para contactores DILM 7-32 empalme atornillado tipo DILA-XHI31		



código	380559	referencia	—
descripción	contacto auxiliar contactos 1NO/3NC AC15 16A para contactores DILM 7-32 empalme atornillado tipo DILA-XHI13		



código	380568	referencia	—
descripción	elemento RC apto para DILM 9-12 nominal 110-240V		



código	381005	referencia	730550008
descripción	contactor de potencia AC1 35A 230VAC (AC3/400V) 17A/7,5kW contactos principales 3NO contactos auxiliares 1NC empalme empalme atornillado tipo DILM 17-01		

contactos auxiliares



código	380565	referencia	730560001
descripción	contacto auxiliar contactos 1NO/1NC AC15 10A para contactores DIL 17-32 empalme atornillado tipo DILM 32-CHI11-5		



código	381007	referencia	730550009
descripción	contacto auxiliar contactos 1NO/1NC AC15 10A para contactores empalme atornillado tipo DILA-XHI11		

SIEMENS

contactores de potencia



código	380652	referencia	530570031
descripción	contactor de potencia AC1 22A 230VAC (AC3/400V) 9A/4kW contactos principales 3NO contactos auxiliares 1NC empalme empalme atornillado tipo 3RT10-16-1AP02		



1

código	380646	referencia	730570003
descripción	contactor de potencia AC1 40A 230VAC (AC3/400V) 17A/7,5kW contactos principales 3NO contactos auxiliares empalme empalme atornillado tipo 3RT10-25-1AL20		

contactos auxiliares



1

código	380647	referencia	530570032
descripción	contacto auxiliar contactos 1NO/1NC AC15 3A para contactores 3RT102 3 RT103 empalme empalme atornillado tipo 3RH1921-1EA11 AC1 10A AC-12 10A		

guardamotores



1

código	382000	referencia	530570034
descripción	guardamotor tipo 3RU1116-1EBO margen de ajuste 2,8-4A (AC3/400V) 1.5kW		

TELEMECANIQUE (Schneider Electric)

contactores de potencia



1

código	380976	referencia	737400797 C400797
descripción	contactor de potencia AC1 32A 230VAC (AC3/400V) 18A/7,5kW contactos principales 3NO contactos auxiliares 1NO/1NC empalme empalme atornillado		

contactos auxiliares



1

código	380987	referencia	530751790
descripción	contacto auxiliar contactos 3NO/1NC AC15 10A para contactores LC1K empalme atornillado tipo LA1KN31		

semiconductores de potencia

CELDUC



1

código	402049	referencia	530752401 EL752401
descripción	semiconductor de potencia CELDUC fases 1 carga 60A carga 24-600V 3-32VDC L 58mm An 45mm atornillado tipo SO965460		
accesorios para	402049		
	código	401564	referencia —
	lámina térmica L 62mm An 45mm para semiconductor de potencia		



relés

relés de potencia

con lengüeta de sujeción



1

código	380950	referencia	600155 731580008 734243005 R6219
descripción	relé SCHRACK 230VAC 25A 2CO empalme F6,3 con abrazadera de montaje a 250 V 25A N° fabricante RM805730 250V 4 polos		
Para modelos:	E2101EU-OTC, E2512, E2914i, E3101OTC-3HP, E3101OTC-4HP, E3512, E3913i, E3914i, G3101OTC		



1

código	380312	referencia	738160210
descripción	relé de potencia FINDER 230VAC 10A 3CO empalme conector Faston 4,8mm lengüeta de sujeción medidas 52x32,2x36,5mm N° fabricante 60.63.8.230.0000		



1

código	381162	referencia	731560340 800644
descripción	relé enchufable 230VAC 30A 2CO empalme conector Faston 6,3mm Kit 250V 2 polos		
Para modelos:	E1532		
repuestos para	381162		
	código	380812	referencia —
	relé de potencia FINDER 230VAC 30A 2CO empalme F6,3 lengüeta de sujeción N° fabricante 66.82.8.230.0000		

relés de temporización

relés de temporización



1

código	380288	referencia	530332615
descripción	relé de temporización ELEKTRON VZE 806 margen de tiempo 60s 24-250 AC/DC 5A empalme cable medida de montaje riel DINmm		

transformadores

transformadores encapsulados

conexiones múltiples



1

código	400251	referencia	530572217
descripción	transformador 44VA		



1

código	402051	referencia	530742775
descripción	transformador primaria 230VAC secundaria 16,5VAC 2x15VA empalme conector Faston 50/60Hz		

con empalme atornillado



1

código	400127	referencia	530560005
descripción	transformador primaria 230VAC secundaria 12VAC 40VA secundaria 3.2A H 63mm L 75mm An 78mm empalme sistema bifilar 50/60Hz moldeado		



PMA



código	400126	referencia	530550038
descripción	transformador primaria 230VAC secundaria 12VAC 20VA secundaria 2.1A empalme atornillado 50Hz		

controladores electrónicos

LAE

controladores de punto de refrigeración

versión empotrada 2 piezas



código	403413	referencia	00-556225
descripción	placa de potencia LAE tipo LF28B253E-1FS medida de montaje 104x91mm aliment. 230V tensión AC NTC salidas de relé 3 NO-20A(6) NO-12A(4) NO-7A(2) NTC NTC DI DI dimensiones frontales 105x63mm profundidad de montaje 45mm protección IP2x -50 a +80°C display		
accesorios para	403413		
	código	referencia	—
	379771		
	código	referencia	—
	379784		
	código	referencia	—
	403459		
	cable de enlace LAE tipo FC06-20M01		

sensores

sensores universales

sondas de temperatura



código	381363	referencia	530550052
descripción	sensor de temperatura termopar K (NiCr-Ni) sonda -50 a 1150°C cable -50 a +180°C longitud de cable 1.5m rosca M10x1 longitud de adaptador 93mm adaptador ø 6mm colores cable argénteo/amarillo sonda L 90/14mm sonda ø 6/3mm		

sensores específicos del fabricante

sensores



código	378320	referencia	536430024 802178
descripción	sensor de temperatura NTC 100kOhm cable fibra de vidrio sonda -40 a +125°C cable -50 a +350°C empalme conector Faston 6,3mm rosca bulbo ø5x100mm longitud de cable 0.35m		
Para modelos:	G2845F		



código	378317	referencia	536300034 750079
descripción	sensor de temperatura NTC 100kOhm cable PTFE sonda -40 a +110°C cable -40 a +250°C empalme de dos hilos rosca M10x1,25 bulbo ø5x128mm longitud de cable 0.35m		
Para modelos:	G3840, G401, G401F, G402, G402F		



código	378318	referencia	731350020 750199
descripción	sensor de temperatura NTC 100kOhm cable PVC sonda -40 a +110°C cable -10 a 100°C empalme de dos hilos rosca bulbo ø5x300mm longitud de cable 1m		
Para modelos:	E3840, E401, E401F, E402, E402F, E421, E421F, E422, E422F		



código	378325	referencia	534510260 R3502
descripción	sensor de temperatura NTC cable Vetrotex sonda -40 a +110°C cable -50 a +350°C empalme de dos hilos rosca 1/8" bulbo ø4,7x90mm longitud de cable 0.5m		
Para modelos:	G1808-CE, G1808-Pre-CE, G1838-CE, G1848-CE, G1848-Pre-CE		



código	378324	referencia	600534 734310370
descripción	sensor de temperatura NTC cable Vetrotex sonda -40 a +110°C cable -50 a +350°C empalme de dos hilos rosca 1/8" bulbo ø5x100mm longitud de cable 0.4m		
Para modelos:	E4063, E4103, E4203		



código	379087	referencia	530570621 EL570621
descripción	sensor de temperatura termopar K (NiCr-Ni) cable silicón sonda -50 a 1150°C cable -50 a +180°C empalme conector Faston 2,8mm rosca bulbo ø1x30mm longitud de cable 1.6m		



			
código	378319	referencia	734510020 R3588
descripción	sensor de temperatura termopar K (NiCr-Ni) cable Vetrotex sonda -50 a 1150°C cable -50 a +350°C empalme de dos hilos rosca M10x1 bulbo ø5x280mm longitud de cable 0.55m		
Para modelos:	E1808, E1838, E1848		

sondas al corazón

			
código	378358	referencia	530747017
descripción	sensor al corazón		

			
código	379592 ¹	referencia	530752363
descripción	sensor al corazón 3 puntos sensor cable PTFE sonda -40 a +250°C cable -40 a +250°C empalme de cinco hilos bulbo ø4x100mm rosca longitud de cable 4.5m asidero ø 12mm longitud de asidero 85mm		

¹sensor multipunto

			
código	379692	referencia	530783668
descripción	sensor al corazón Pt100 cable PTFE sonda -40 a +250°C cable -40 a +250°C empalme de dos hilos bulbo ø4x82mm rosca 1/4" longitud de cable 1.8m asidero ø 12mm longitud de asidero 90mm		

			
código	379510	referencia	530550054
descripción	sensor al corazón termopar K (NiCr-Ni) cable PTFE sonda -40 a +250°C cable -40 a +250°C empalme 6 pin enchufe bulbo ø3,5x90mm rosca longitud de cable 1.1m asidero ømm longitud de asidero 90mm		

			
código	379827	referencia	737601043 C601043
descripción	sensor de temperatura termopar K (NiCr-Ni) cable PTFE sonda -40 a +250°C cable -40 a +250°C empalme de dos hilos bulbo ø5x115/285mm rosca longitud de cable 1.5m asidero ømm longitud de asidero L1 280mm L2 115mm		

electrónicas

convertidores de frecuencia

			
código	403841	referencia	530550035
descripción	convertidor de frecuencia con disipador para horno a vapor combinado L 135mm An 135mm 800W ECS P0010205-0		

rectificadores

			
código	400253	referencia	530570532
descripción	rectificador		

placas electrónicas

			
código	403181	referencia	530742457 EL742457
descripción	kit de modificación horno a vapor combinado Genius T 6-11 10-11 L 155mm An 115mm longitud del cable 60mm display y placa electrónica		



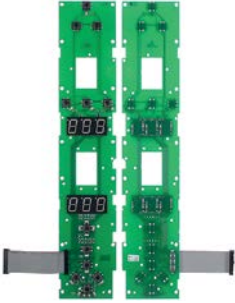

1

código	403142	referencia	536430001 731350002 750035
descripción	placa de control freidora 401/402 L 89mm An 66mm UE 1 pzs		
Para modelos:	E3840, E401, E401F, E402, E402F, E421, E421F, G2845F, G401, G401F		



1

código	403823	referencia	530550132
descripción	placa de teclado para horno a vapor combinado L 443mm An 83mm		



1

código	403145	referencia	535770055 R5213
descripción	placa de display freidora G2840 L 200mm An 90mm longitud del cable 150mm		
Para modelos:	G2840		



1

código	403148	referencia	536060006 802101
descripción	placa electrónica freidora 2840/2841/2842 L 80mm An 140mm		
Para modelos:	G2840, G2841, G2842, G2844F, G2845F		



1

código	402619	referencia	530742465 EL742465
descripción	placa de teclado horno a vapor combinado 1121/2021 L 350mm An 121mm con Display		



1

código	403146	referencia	535770057 801962
descripción	placa electrónica freidora 2840/FFSE98 L 126mm An 126mm		
Para modelos:	G2840		

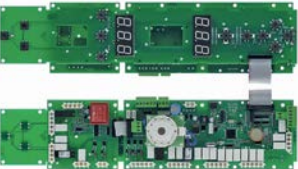

1

código	403821	referencia	530550049
descripción	placa de teclado para horno a vapor combinado		



1

código	403147	referencia	734510160 R3640
descripción	placa electrónica freidora E1808 L 113mm An 100mm		
Para modelos:	E1808, E1838, E1848		



1

código	400016	referencia	530593648
descripción	placa electrónica generador de impulsos para humidificación con escuadra de montaje		



1

código	403179	referencia	530791458 EL791458
descripción	placa electrónica horno a vapor combinado Genius T 6-11 10-11 L 400mm An 155mm		



1

código	401962	referencia	530550044
descripción	placa electrónica horno a vapor combinado HME 611/1011		



1

código	403048	referencia	737214132 C216176
descripción	placa electrónica para freidora L 135mm An 135mm		

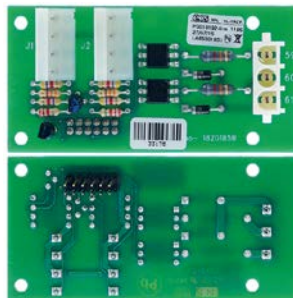

1

código	403828	referencia	530550047
descripción	placa electrónica para horno a vapor combinado L 85mm An 42mm		

válvulas magnéticas

válvulas magnéticas agua

INTERELEKTRIK

temperatura líquido: 90°C 90°C 60°C
temperatura ambiente: 60°C 25°C 60°C
ciclo de trabajo: 40% 100% 100%



1

código	370688	referencia	530754463 EL754463
descripción	válvula magnética 220-240VAC entrada 3/4" salida 13,5mm DN8 T máx 90°C plástico		

MÜLLER

temperatura líquido: 90°C
ciclo de trabajo: 100%



1

código	370002	referencia	734310265 R2027
descripción	válvula magnética simple recto 230VAC entrada 3/4" salida 14,5mm DN10T máx 90°C ciclo de trabajo 100% MÜLLER		
Para modelos:	E4063, E4103		
repuestos para	370002		



código	370127	referencia	—
descripción	cuerpo de válvula magnética simple recto entrada 3/4" salida 14,5mm DN10 T máx 90°C ciclo de trabajo 100% MÜLLER 230V		



código	371002	referencia	—
descripción	soporte de válvula magnética MÜLLER portabridas		









código	371009	referencia	—
descripción	resorte de compresión para solenoide		



código	371011	referencia	—
descripción	kit de piezas de repuesto membrana con estrella larga anchura estrella 8mm MÜLLER		

Continúa en la página siguiente

repuestos para	370002		
	código	371017	referencia —
	bobina magnética MÜLLER 230VAC empalme conector Faston 6,3mm		
	código	371122	referencia 530249688
	filtro de válvula magnética ø 19mm H 10mm apto para MÜLLER		
	código	501161	referencia —
	montura para válvula magnética soporte para solenoides		

accesorios para	370002		
	código	371010	referencia —
	bobina magnética 230VAC empalme con cable longitud del cable 2000mm		
	código	371037	referencia —
	bobina magnética 24VAC 50/60Hz empalme conector Faston 6,3mm		
	código	371038	referencia —
	bobina magnética 230VAC empalme conector		

	código	370715	referencia 735400100 R2920
	descripción válvula magnética simple recto 230VAC entrada 3/4" salida 3/8" DN10 T máx 90°C ciclo de trabajo 100% MÜLLER SVGW plástico		
Para modelos:	E4069EL, E4069TC-TMS, E4109EL, E4109TC-TMS, G4069, G4109		

recambios y accesorios

filtros			
	código	371122	referencia 530249688
	descripción filtro de válvula magnética ø 19mm H 10mm apto para MÜLLER		

RPE			
JOHN GUEST			
	código	374032 ¹	referencia 730550006
	descripción válvula magnética doble recto 230VAC entrada 3/4" salida 10mm DN10 plástico salida A sin membrana (siempre abierto)		

¹salida cilíndrica

	código	370768 ¹	referencia 530550028
	descripción válvula magnética simple recto 230VAC entrada 3/4" salida 10mm reducción entrada A/min reducción salida/min DN10 T máx 90°C ciclo de trabajo 100% RPE		

¹salida cilíndrica

válvulas magnéticas con reducciones			
doble			
	código	374031	referencia 530550029
	descripción válvula magnética doble recto 230VAC entrada 3/4" salida JG 10 reducción entrada A 10-12l/min T máx 90°C RPE plástico reducción entrada A blanco + reductor de salida rojo		

triple			
	código	374014 ¹	referencia 530570030
	descripción válvula magnética triple recto 230VAC entrada 3/4" salida 10mm reducción entrada A 10-12l/min RPE plástico reducción entrada A blanco reducción salida A rojo/verde reducción salida B rojo/verde reducción salida C rojo/verde		

¹salida cilíndrica

	código	374033	referencia 730580007
	descripción válvula magnética triple recto 230VAC entrada 3/4" salida 10mm reducción entrada A 10-12l/min T máx 90°C RPE plástico reducción entrada A blanco salida B sin membrana (siempre abierto)		

metal			
MÜLLER			
2 vías			
	código	370069 ¹	referencia 530374806
	descripción válvula magnética 2vías 230VAC entrada 1/8" F salida 1/8" F L 30mm agua MÜLLER DN10		

¹con tornillo de regulación

válvulas magnéticas gas

diversos



código	370711	referencia	531750320 531930530 701251
descripción	válvula magnética gas 2vías 230VAC entrada 1/2" H salida 1/2" H empalme cable L 69mm BLACK TEKNIGAS homologación IP40 altura total 94mm		
Para modelos:	G1962, G1965, G1994, G1995, G2962, G2965, G2994, G2995, G7004, G7008, G7011, G7204, G7208, G7211		



código	107442	referencia	534510930 RZZ43
descripción	válvula magnética gas 2vías triple 230VAC entrada 1/2" salida 1/2" L 105mm p máx. 0.065bar altura total 145mm		
Para modelos:	G1808-CE, G1808-Pre-CE, G1838-CE, G1848-CE, G1848-Pre-CE		

Válvulas magnéticas - accesorios

filtros



código	371122	referencia	530249688
descripción	filtro de válvula magnética ø 19mm H 10mm apto para MÜLLER		



código	530903	referencia	730580018
descripción	bobina magnética tipo de conector F6,3x0,8 230V para horno a vapor combinado		

válvulas de bola eléctricas



código	403042	referencia	730610000
descripción	válvula de bola entrada 3/4" H salida 3/4" H 230V L 68mm cerrado sin corriente modo operativo eléctrico empalme cable 400mm		



código	403180	referencia	734310960 R2074
descripción	válvula de bola entrada 3/4" NPTF salida 3/4" NPTF 240V L 93mm 50/60Hz latón abierto sin corriente modo operativo eléctrico empalme cable 1000mm 5/6W para tubø 22mm		
Para modelos:	E4063, E4103		

presostatos

para sistemas de gas



código	541073	referencia	530550019
descripción	presostato ø 45mm margen de presión ajustable 5-20mbar conexión de presión vertical sistemas de gas empalme 1/4" empalme presión ø 1/4"mm		

para regulación vapor



código	541074	referencia	730550001
descripción	presostato ø 45mm presión de intervención 0.5bar presión reinicio 0.35bar conexión de presión vertical regulación vapor margen de presión 0,35/0,51bar empalme 1/8" empalme de presión 1/8"		

para hornos a vapor combinado



1

código	541526	referencia	530784028
descripción	presostato p máx. 0.5bar empalme de presión 1/8"		

electródos



1

código	401209	referencia	735400440 R2950
descripción	electrodo de nivel 1/4" longitud total 180mm sonda L 155mm largo del bulbo asilado 70mm aislado con PTFE empalme conector Faston 6,3mm acero inoxidable ø 2.5mm		
Para modelos:	E4069EL, E4069TC-TMS, E4109EL, E4109TC-TMS		



1

código	403183	referencia	536070178 G70178
descripción	electrodo de nivel 3/8" longitud total 162mm sonda L 11mm largo del bulbo asilado 102mm empalme M3 ø 10mm		



1

código	403143	referencia	734310300 R2265
descripción	electrodo de nivel brida 2 orificios longitud total 100mm sonda Lmm largo del bulbo asiladomm sin sonda empalme M6x1 cerámica ø 32mm		
Para modelos:	E4063, E4103, E4203, G4069, G4109		



1

código	403144	referencia	610044 734310310
descripción	electrodo de nivel brida 2 orificios longitud total 215mm sonda L 116mm largo del bulbo asiladomm empalme M6x1		
Para modelos:	E4063, E4103, E4203, G4069, G4109		



1

código	400130	referencia	530550051
descripción	electrodo de nivel M14x1,25 longitud total 220mm sonda L 194mm largo del bulbo asilado 26mm empalme conector Faston 6,3mm ø 2.5mm		

ventiladores

ventilador axial

ebm-papst



1



código	601038 ¹	referencia	534500190 R7272
descripción	ventilador axial L 80mm An 80mm H 38mm 230VAC 50/60Hz 12W cojinete rodamiento de bolas N° fabricante 8556N metal empalme cable 300mm ebm-papst rodete ventilador ø 75mm resis.a la temp. 90°C caudal 50m³/h		
Para modelos:	E3913i, E3914i, G1808-CE, G1808-Pre-CE, G1838-CE, G1848-CE, G1848-Pre-CE		
accesorios para	601038		
	código	691102	referencia —
	rejilla de protección ø 75mm distancia de sujeción 71mm para ventilador axial 80mm		

¹con rodamiento de bolas



importación



código	601080 ¹	referencia	FAN095
descripción	ventilador axial L 119mm An 119mm H 38mm 230VAC 50/60Hz 23/20W cojinete rodamiento de bolas empalme conector Faston 2,8mm metal ADDA rodete ventilador ø 110mm resis.a la temp. 70°C		
accesorios para	601080		
	código	550898	referencia —
	cable de conexión longitud del cable 2000mm empalme F 2,8 distancia de empalme 7.9mm para ventilador axial		
	código	692519	referencia —
	rejilla de protección L 120mm An 120mm plástico		

¹con rodamiento de bolas



código	601081 ¹	referencia	530560003
descripción	ventilador axial L 80mm An 80mm H 38mm 230VAC 50/60Hz 14/13,5W cojinete rodamiento de bolas empalme conector Faston 2,8mm metal ADDA rodete ventilador ø 75mm resis.a la temp. 70°C		
accesorios para	601081		
	código	691102	referencia —
	rejilla de protección ø 75mm distancia de sujeción 71mm para ventilador axial 80mm		

¹con rodamiento de bolas

motores de aire caliente



código	550860	referencia	730580014
descripción	brida para junta ø ext. 35mm ø int. 1 22mm ø int. 2 9mm espesor 8mm latón		



código	550858	referencia	530560015
descripción	brida para motor de ventilador ø ext. 60mm ø int. 1 28.5mm ø int. 2 25mm espesor 4mm latón		



código	510673	referencia	530580600
descripción	brida para motor de ventilador ø ext. 60mm ø int. 1 43mm ø int. 2 29mm espesor 6mm acero inoxidable		



código	550859	referencia	530560016
descripción	contrabrida para motor de ventilador ø ext. 60mm ø int. 1 34mm ø int. 2 25mm espesor 6mm latón		



código	510675	referencia	530373621
descripción	contrabrida para motor de ventilador ø ext. 60mm ø int. 2 30mm espesor 5mm acero inoxidable		



código	511172	referencia	530560025
descripción	junta de árbol int.ø 24mm ø ext. 29mm espesor 3mm		



código	550861	referencia	730580034
descripción	junta radial para motor de ventilador int.ø 7.5mm ø ext. 22mm espesor 7mm		

1

código	500658	referencia	530560002
descripción	motor de ventilador 230/400V fases 3 50/60Hz 0.55kW 1400/1700rev/min velocidades 1 L1 145mm L2 47mm L3 47mm D1 ø 24mm D2 ø 20mm M12I F 2,6-2,3/1,5-1,3A (a 50-60Hz)A Cos(fi) 0.73 a 50 Hz 200-240/415V a 60 Hz 200-240/480V a 50 Hz 1400rev/min a 60 Hz 1700rev/min		
repuestos para	500658		
	código	511172	referencia 530560025
	junta de árbol int.ø 24mm ø ext. 29mm espesor 3mm		
accesorios para	500658		
	código	560449	referencia —
	tornillo de cabeza hexagonal rosca M12x1,5 S rosca L 22mm taladro ø 6.3mm EC 19 longitud total 30mm		
	código	601244	referencia 530560007
	rodete ventilador D1 ø 350mm H1 114mm palas 12 D2 ø 19.5mm D3 ø 23mm H2 45mm		

1

código	500659	referencia	530560023
descripción	motor de ventilador 230V fases 1 50/60Hz 0.55kW 1400/1700rev/min velocidades 1 L1 150mm L2 52mm L3 45mm D1 ø 24mm D2 ø 20mm M12I F 3A condensador apropiado 20µF/450V Cos(fi) 0.9 a 50 Hz 1400rev/min a 60 Hz 1700rev/min tipo 3042A2350		
repuestos para	500659		
	código	511172	referencia 530560025
	junta de árbol int.ø 24mm ø ext. 29mm espesor 3mm		

1

código	500102	referencia	530332410
descripción	motor de ventilador 230-240V fases 1 50Hz 0.09kW 1390rev/min velocidades 1 L1 150mm L2 32mm L3 27mm ø 125mm M10D F 1.1A condensador apropiado 4µF/400V consumo 200W a 50 Hz 1390rev/min tipo L7yzw4B-207 N° X5 D1 ø 17mm D2 ø 14mm		

1

código	601856	referencia	730550005
descripción	motor de ventilador 230V fases 1 50Hz 0.075kW 2650rev/min velocidades 1 L1 85mm L2 30mm L3 23mm L4 12mm D1 ø 8x6mm D2 ø 8mm 0.6A condensador apropiado 5µF/400V		
accesorios para	601856		
	código	365017	referencia —
	condensador de servicio capacidad 5µF 450V tolerancia 5% 50/60Hz temperatura ambiente máx. -25 a + 85°C ø 28mm L 54mm M8 plástico empalme conector Faston 6,3mm 16.10.08 protección		

1

código	601474	referencia	530693286
descripción	motor de ventilador 230V fases 1 50/60Hz 0.03kW 3600rev/min velocidades 1 L1 115mm L2 20mm L3 32mm ø 12mm longitud de la parte plana 23mm 7,5/8 0,35/0,56A condensador apropiado 3µF/400V consumo 75/125W a 50 Hz 3600rev/min tipo L5ow2B-317 N° W9		
accesorios para	601474		
	código	602166	referencia 530693375
	rodete ventilador palas 9 D1 ø 175mm D2 ø 8mm D3 ø 8mm H1 30mm H2 28mm ED 6-23		

1

código	500680	referencia	530550117
descripción	motor de ventilador 230V fases 1 50Hz 0.37kW 2800rev/min velocidades 1 L1 121mm L2 77mm L3 31mm D1 ø 16mm D2 ø 11mm 2.5A Cos(fi) 0.95 a 50 Hz 230V a 50 Hz 2800rev/min tipo 1057.2155		
accesorios para	500680		
	código	601060	referencia —
	rodete ventilador D1 ø 180mm H1 60mm palas 16 D2 ø 11mm D3 ø 16mm H2 30mm		



1

código	601871	referencia	530302821
descripción	motor de ventilador 230V fases 1 50Hz 85kW 2400rev/min velocidades 1 L1 85mm L2 40mm L3 33mm L4 133.5mm rodete ventilador ø 180mm a 50 Hz 230V a 60 Hz 230V a 50 Hz 2600rev/min a 60 Hz 2850rev/min tipo R2E180-AU01-09		



1

código	601244	referencia	530560007
descripción	rodete ventilador D1 ø 350mm H1 114mm palas 12 D2 ø 19.5mm D3 ø 23mm H2 45mm		





1

código	501566	referencia	530550118
descripción	motor de ventilador 230V fases 3 50Hz 0.25kW 2700rev/min L1 122mm L2 77mm L3 30mm D1 ø 15mm D2 ø 8mm M10 1.5A tipo FIR N° 1057.2650		



1

código	602166	referencia	530693375
descripción	rodete ventilador palas 9 D1 ø 175mm D2 ø 8mm D3 ø 8mm H1 30mm H2 28mm ED 6-23		
accesorios para	602166		
	código	601474	referencia 530693286
	motor de ventilador 230V fases 1 50/60Hz 0.03kW 3600rev/min velocidades 1 L1 115mm L2 20mm L3 32mm ø 12mm longitud de la parte plana 23mm 7,5/8 0,35/0,56A condensador apropiado 3µF400V consumo 75/125W a 50 Hz 3600rev/min tipo L5ow2B-317 N° W9		

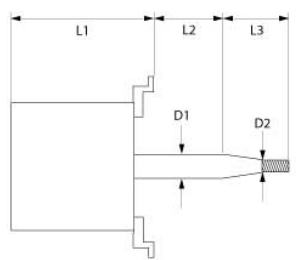
1

código	601864	referencia	530742740
descripción	motor de ventilador 380-415V fases 3 50Hz 0.21kW 700/1400rev/min velocidades 2 L1 160mm L2 25mm L3 40mm D1 ø 17mm D2 ø 13mm M10D F a 50 Hz 700/1400rev/min tipo 3081DH4052		



1

código	602168	referencia	530899992
descripción	rodete ventilador para refrigeración motor ø ext. 180mm H 20mm int.ø 25mm		

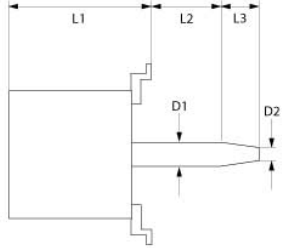
1

código	500170	referencia	530390052
descripción	motor de ventilador fases 3		



1

código	694997	referencia	530782939
descripción	sensor de velocidad para motor de aire caliente longitud del cable 450mm		

ventiladores de aire caliente

ebm-papst

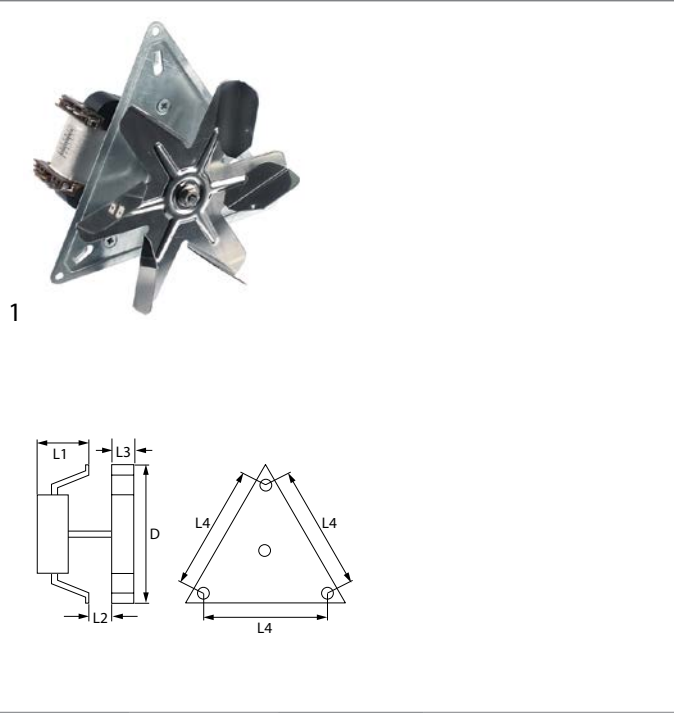

código	601249	referencia	535420010 RZZ263
descripción	ventilador de aire caliente 230V 32W 0.27A L1 60mm L2 20mm L3 20mm L4 157mm rodete ventilador ø 150mm ebm-papst tipo R2K150-AC01-15		
Para modelos:	E2101EU-OTC, E3101OTC-3HP, E3101OTC-4HP, G2101OTC, G3101OTC		

ventiladores radiales

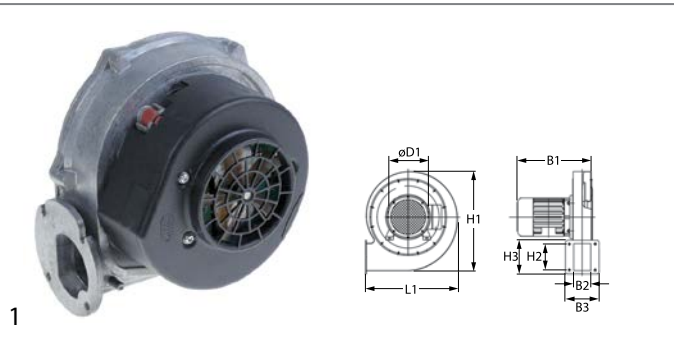

código	601181	referencia	530550023
descripción	ventilador radial 230V tensión AC 50Hz 100W H1 170mm L1 175mm D1 ø 50mm B1 115mm B2 40mm H2 45mm		

motores

motorreductores

para expendedoras de bebidas

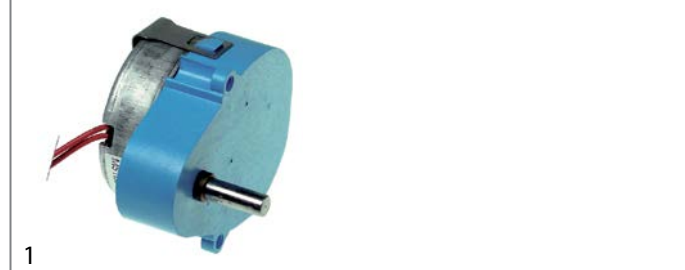

código	499156	referencia	730781894
descripción	motorreductor FIBER tipo G025J0BCD86 230V 50/60Hz 4rev/min árbol ø 5x6mm L 15mm tipo de motor M51BJ0R6400		

para hornos a vapor combinado



código	502288	referencia	530550027
descripción	kit de engranaje 8W 230V tensión AC 30rev/min árbol ø 6mm L 75mm An 87mm H 84mm kit de modificación		
repuestos para	502288	código	502291
		referencia	—
descripción	motorreductor METEOR tipo 58U59DB4A1/00 8W 230V tensión AC 50Hz 30rev/min árbol ø 6x5mm L 69mm An 49mm H 65mm		



bombas

bombas de lavado y aclarado

OLYMPIA

bombas



1

código	500199	referencia	738160996
descripción	bomba entrada \varnothing 32mm salida \varnothing 30/24mm tipo T80 230V 50Hz fases 1 0.25kW 0.34PS L 205mm dirección de rodadura izquierdo condensador 5 μ F OLYMPIA		
repuestos para	500199		
	código	365017	referencia —
	condensador de servicio capacidad 5 μ F 450V tolerancia 5% 50/60Hz temperatura ambiente máx. -25 a + 85°C \varnothing 28mm L 54mm M8 plástico empalme conector Faston 6,3mm 16.10.08 protección		
	código	510693	referencia —
	sello mecánico para árbol \varnothing 12mm anillo deslizante \varnothing ext. 24mm anillo deslizante H 15.5mm anillo deslizante \varnothing int. 11mm contraarandela montaje \varnothing 24mm altura contraarandela 8mm contraarandela \varnothing int. 13.5mm		
	código	521151	referencia —
	rotor \varnothing 71mm H 19mm tipo bomba OLYMPIA rosca M10R árbol \varnothing 12mm longitud árbol 8mm		
	código	521178	referencia —
	carcasa de bomba OLYMPIA salida \varnothing 30/24mm tipo bomba T80		
	código	521552	referencia —
	cubierta de bomba OLYMPIA entrada \varnothing 32mm salida \varnothing 30/24mm \varnothing 103mm int. \varnothing 93mm		
	código	521703	referencia —
	junta de tapa de bomba EPDM espesor 2.5mm int. \varnothing 75mm UE 1 pzs		

bombas de aumento de presión I



1

código	500358	referencia	738160720
descripción	bomba entrada \varnothing 3/8" salida \varnothing 3/8" tipo PS46 230V 50Hz 0.45kW \varnothing 100mm L 200mm condensador 10 μ F LGB		
repuestos para	500358		
	código	510713	referencia —
	arandela fricción para árbol \varnothing 12mm \varnothing ext. 24mm H 16mm		
	código	510723	referencia —
	contraarandela H 8mm \varnothing ext. 26mm int. \varnothing 13.5mm per sello mecánico		
	código	698400	referencia —
	junta de tapa de bomba tipo bomba PS46 espesor 2mm int. \varnothing 66mm UE 1 pzs		
accesorios para	500358		
	código	365015	referencia 530550039
	condensador de servicio capacidad 10 μ F 400V tolerancia 5%Hz temperatura ambiente máx. -25 a + 85°C \varnothing 35.5mm L 59mm M8 plástico empalme conector Faston 6,3mm protección		
	código	511279	referencia —
	empalme de tubo latón recto rosca 3/8" tubo \varnothing 12mm UE 1 pzs		
	código	520202	referencia —
	empalme de tubo latón niquelado recto rosca 3/8" tubo \varnothing 12mm UE 1 pzs		
	código	520677	referencia —
	empalme de tubo latón recto rosca 3/8" tubo \varnothing 13mm UE 1 pzs		

bombas de aumento de presión II

accesorios



1

código	365015	referencia	530550039
descripción	condensador de servicio capacidad 10 μ F 400V tolerancia 5%Hz temperatura ambiente máx. -25 a + 85°C \varnothing 35.5mm L 59mm M8 plástico empalme conector Faston 6,3mm protección		



bombas de vibración



1

código	500568	referencia	530550032
descripción	bomba magnética 230V 32W 50Hz entrada ø 7 salida ø 1/8" F CEME tipo E512/A32		
repuestos para	500568		
	código	390698	referencia —
	fusible térmico temp. desconexión 110°C apto para bomba Ulka		
	código	520153	referencia —
	soporte goma medidas 53x34x28mm		



1

código	499010	referencia	530772550
descripción	bomba magnética tipo E512/B46 230V 60W 50/60Hz entrada ø 7 salida ø 1/8" F CEMEL 125mm		



1

código	501567	referencia	530550178
descripción	bomba magnética tipo HF 230V 22W 50Hz entrada ø 6 salida ø 6 ULKA plástico L 97mm empalme conector Faston 4,8mm		

condensadores y filtros antiparasitarios

condensadores de servicio

plástico



1

código	365015	referencia	530550039
descripción	condensador de servicio capacidad 10µF 400V tolerancia 5%Hz temperatura ambiente máx. -25 a + 85°C ø 35.5mm L 59mm M8 plástico empalme conector Faston 6,3mm protección		

filtros

filtros antiparasitarios



1

código	365044	referencia	530570037
descripción	filtro antiparasitario tipo FC701Y2F 250V 50-60Hz conductor 2 con T empalme cable 200mm L 42mm ø 23mm Hmm Anmm plástico UE 1 pzs		

fusibles

fusibles finos



1

código	358532	referencia	530190756
descripción	fusible fino medida ø5x20mm 2A rápido nominal 250V UE 10 pzs		

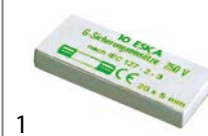

1

código	358595	referencia	730580042
descripción	fusible fino medida ø5x20mm 0.2A retardado nominal 250V UE 10 pzs		



1

código	358703	referencia	530560030
descripción	fusible fino medida ø5x20mm 0.4A retardado nominal 250V UE 10 pzs		





			
1			
código	358790	referencia	536430009 R5524
descripción	fusible fino medida $\phi 6,3 \times 32$ mm 5A retardado nominal 250V UE 10 pzs		
Para modelos:	E3840, E401F, E402F, E421, E421F, E422, E422F, G2844F, G2845F, G3106, G3840, G401F, G402F		

diversos

			
1			
código	358004	referencia	731750790
descripción	fusible 20A nominal 240V UE 1 pzs		
Para modelos:	E1962, E1965, E1994, E1995		

portafusibles

			
1			
código	550105	referencia	730326941
descripción	borne seccionable WIELAND tipo WK10/SIU 5X20 /V0 fusible adaptable $\phi 5 \times 20$ mm 1,0-16mm ² 10A nominal 250V		

			
1			
código	551212	referencia	731740420 RHH3/2
descripción	portafusibles fusible adaptable $\phi 6,3 \times 32$ mm $\phi 6$ mm 20A nominal 240V L 70mm An 25mm H 48mm empalme		
Para modelos:	E1112		

fusibles de rosca

sistema D0 (NEOZED)

			
1			
código	358043	referencia	530658294
descripción	fusible medida D01 16A nominal 250/400V E14 $\phi 11$ mm L 36mm UE 10 pzs		

			
1			
código	358045	referencia	530751863
descripción	fusible medida D02 35A nominal 250/400V E18 $\phi 15$ mm L 36mm UE 10 pzs		

suplementos de ajuste (NEOZED)

			
1			
código	358067	referencia	530751855
descripción	suplemento de ajuste medida D02 apto para 35A		

limitadores de corriente

			
1			
código	358515	referencia	530550036
descripción	limitador de corriente corriente de descon. 2.5A		

accesorios eléctricos

cables

cables de alimentación aparatos

			
1			
código	551136	referencia	535770061 801949
descripción	cable de conexión par aparatos BS1363 3 polos contactos P+N+T 1.5mm ² máx. 13A máx. 250V 2m con fusible países UK UE 1 pzs empalme ojal negro H07 RN-F tipo de conector G		
Para modelos:	G2840, G2841, G2842, G2844F, G2845F		

otros

			
1			
código	107315	referencia	539113294 635112
descripción	cable interruptor circuito L 600mm empalme Faston 6,3mm		
Para modelos:	G350-11, G350-12		



terminales

regletas de bornes a tornillo/con contactos de enchufe



1

código	550518	referencia	535770066
descripción	borne de conexión 6 polos máx. 40A máx. 450V empalme M6/conector Faston 6,3mm resis.a la temp. 150°C sección nominal 6mm ²		
Para modelos:	G2840, G2841, G2842		

bloques de bornes

WIELAND

bornes de fusibles



1

código	550105	referencia	730326941
descripción	borne seccionable WIELAND tipo WK10/SIU 5X20 /V0 fusible adaptable ø5x20mm 1,0-16mm ² 10A nominal 250V		

grifos de gas

PEL

serie 22S/V



1

código	109139	referencia	537400170 R9103
descripción	grifo de gas PEL tipo 22S/V entrada gas M20x1,5 (tubo ø 12mm) boquilla bypass ø 0mm salida gas M20x1,5 (tubo ø 12/10mm) conexión termopar M9x1 conexión de piloto M10x1 eje ø 10x8mm eje L 25/17mm parte plana derecho		
Para modelos:	G1629		

COPRECI

CAL-24200



1

código	109156	referencia	537220360 600617
descripción	grifo de gas COPRECI tipo CAL-24200 entrada gas brida de tubo ø21mm boquilla bypass ø 0.6mm salida gas M17x1 (tubo ø 10mm) conexión termopar M8x1 conexión de piloto eje ø 8x6,5mm parte plana derecho eje L 22/12mm entrada de tubo ø 8mm		



1

código	109135	referencia	537883000 600618
descripción	grifo de gas COPRECI tipo CAL-24200 entrada gas brida de tubo ø21mm boquilla bypass ø 0.6mm salida gas M17x1 (tubo ø 10mm) conexión termopar M8x1 conexión de piloto eje ø 8x6mm parte plana abajo eje L 48/14mm		



1

código	109173	referencia	539220480 600626
descripción	grifo de gas COPRECI tipo CAL-24200 entrada gas brida de tubo ø21mm boquilla bypass ø 0mm salida gas M17x1 (tubo ø 10mm) conexión termopar M8x1 conexión de piloto M8x1 eje ø 7x5mm parte plana abajo eje L 43/20mm entrada de tubo ø 8mm		
Para modelos:	G350-2-CE		

1



código	109133	referencia	539220221 600624
descripción	grifo de gas COPRECI tipo CAL-24200 entrada gas brida de tubo ø21mm boquilla bypass ø 0mm salida gas M17x1 (tubo ø 10mm) conexión termopar M8x1 conexión de piloto M8x1 eje ø 7x5mm parte plana derecho eje L 25/14mm boquilla interior ø 0mm entrada de tubo ø 6mm		
Para modelos:	G350-10, G350-9		

1



código	109175	referencia	531880800 600632
descripción	grifo de gas Kit COPRECI tipo CAL-24200 entrada gas brida de tubo boquilla bypass ø 0.6mm salida gas M17x1 (tubo ø 10mm) conexión termopar M8x1 eje ø 6x8mm parte plana abajo eje L 48/14mm entrada de tubo ø 8mm		
repuestos para	109175		
	código	109135	referencia
			537883000 600618
	descripción	grifo de gas COPRECI tipo CAL-24200 entrada gas brida de tubo ø21mm boquilla bypass ø 0.6mm salida gas M17x1 (tubo ø 10mm) conexión termopar M8x1 conexión de piloto eje ø 8x6mm parte plana abajo eje L 48/14mm	

2



código	109155	referencia	539110320 600621
descripción	grifo de gas COPRECI tipo CAL-24200 entrada gas brida de tubo ø21mm boquilla bypass ø 0mm salida gas M17x1 (tubo ø 10mm) conexión termopar M8x1 conexión de piloto M8x1 eje ø 8x6,5mm parte plana derecho eje L 22/12mm entrada de tubo ø 8mm		
Para modelos:	G350-7		

CAL-3200

1



código	109136	referencia	537560020 537950020 600614 RZZ50
descripción	grifo de gas COPRECI tipo CAL-3200 entrada gas M18x1,5 (tubo ø 12mm) boquilla bypass ø 0mm salida gas M18x1,5 (tubo ø 12mm) conexión termopar M10x1 conexión de piloto M8x1 eje ø 7x5mm parte plana abajo eje L 34,5/14mm sujeción frontal M14x1		
Para modelos:	G1478, G2512, G2522, G2532, G3512, G3532		

1



código	109132	referencia	535100920 535100921 535100922 600622 600627 R6046
descripción	grifo de gas COPRECI tipo CAL-24200 entrada gas brida de tubo ø21mm boquilla bypass ø 0mm salida gas M17x1 (tubo ø 10mm) conexión termopar M8x1 conexión de piloto M8x1 eje ø 8x6mm parte plana abajo eje L 43/20mm entrada de tubo ø 8mm		



1



código	109131	referencia	530170090 530840045 537880090 600612 700001 700002
descripción	grifo de gas COPRECI tipo CAL-3200 entrada gas M18x1,5 (tubo ø 12mm) boquilla bypass ø 0mm salida gas M18x1,5 (tubo ø 12mm) conexión termopar M10x1 conexión de piloto M8x1 eje ø 8x6mm parte plana abajo eje L 43/14mm		
Para modelos:	G3478, G6478		





			
1			
código	109137	referencia	531884540 537880290 600050 600613
descripción	grifo de gas COPRECI tipo CAL-3200 entrada gas M18x1,5 (tubo ø 12mm) boquilla bypass ø 0mm salida gas M18x1,5 (tubo ø 12mm) conexión termopar M10x1 conexión de piloto M8x1 eje ø 8x6mm parte plana derecho eje L 68/14mm		

			
1			
código	109159	referencia	530840040 600052
descripción	grifo de gas COPRECI tipo CAL-3200 entrada gas M18x1,5 (tubo ø 12mm) boquilla bypass ø 0mm salida gas M18x1,5 (tubo ø 12mm) conexión termopar M10x1 eje ø 8x6mm parte plana abajo eje L 43/14mm		
Para modelos:	G5478		
repuestos para	109159		
	código	109131	referencia 530170090 530840045 537880090 600612 700001 700002
	grifo de gas COPRECI tipo CAL-3200 entrada gas M18x1,5 (tubo ø 12mm) boquilla bypass ø 0mm salida gas M18x1,5 (tubo ø 12mm) conexión termopar M10x1 conexión de piloto M8x1 eje ø 8x6mm parte plana abajo eje L 43/14mm		
accesorios para	109159		
	código	107432	referencia 530840051 705003
	adaptador de pomo eje ø 6x8 en 5x7mm para grifo de gas parte plana universal		

CAL-5200			
			
1			
código	109138	referencia	535200021 670031
descripción	grifo de gas COPRECI tipo CAL-5200 entrada gas brida de tubo ø21mm boquilla bypass ø 0,76+0,51mm salida gas M14x1,5 (tubo ø 8mm) conexión termopar M8x1 conexión de piloto eje ø 7x5mm eje L 45/20mm parte plana abajo entrada de tubo ø 8mm		
Para modelos:	G3101, G3101D, G3101OTC, G3121, G3124, G3161, G3161D		

			
1			
código	107694	referencia	12009406 U872111 U872111000
descripción	grifo de gas COPRECI tipo CAL-5200 entrada gas brida de tubo ø21mm boquilla bypass ø 0,7mm salida gas 3/8" conexión termopar M8x1 conexión de piloto eje ø 8x6,5mm eje L 55/12mm parte plana derecho		

			
1			
código	107252	referencia	535200023 670002
descripción	grifo de gas Kit COPRECI tipo CAL-5200 entrada gas brida de tubo boquilla bypass ø 0,76+0,51mm salida gas M16x1,5 (tubo ø 8mm) conexión termopar M8x1 eje ø 5x7mm eje L 45/20mm parte plana abajo entrada de tubo ø 8mm		
repuestos para	107252		
	código	109138	referencia 535200021 670031
	grifo de gas COPRECI tipo CAL-5200 entrada gas brida de tubo ø21mm boquilla bypass ø 0,76+0,51mm salida gas M14x1,5 (tubo ø 8mm) conexión termopar M8x1 conexión de piloto eje ø 7x5mm eje L 45/20mm parte plana abajo entrada de tubo ø 8mm		

			
1			
código	109174	referencia	535200028 670057
descripción	grifo de gas Kit COPRECI tipo CAL-5200 entrada gas brida de tubo boquilla bypass ø 0,76+0,51mm salida gas M16x1,5 (tubo ø 8mm) conexión termopar M8x1 eje ø 5x7mm eje L 45/20mm parte plana abajo entrada de tubo ø 8mm		
repuestos para	109174		
	código	107252	referencia 535200023 670002
	grifo de gas Kit COPRECI tipo CAL-5200 entrada gas brida de tubo boquilla bypass ø 0,76+0,51mm salida gas M16x1,5 (tubo ø 8mm) conexión termopar M8x1 eje ø 5x7mm eje L 45/20mm parte plana abajo entrada de tubo ø 8mm		
	código	109138	referencia 535200021 670031
	grifo de gas COPRECI tipo CAL-5200 entrada gas brida de tubo ø21mm boquilla bypass ø 0,76+0,51mm salida gas M14x1,5 (tubo ø 8mm) conexión termopar M8x1 conexión de piloto eje ø 7x5mm eje L 45/20mm parte plana abajo entrada de tubo ø 8mm		



termostatos para gas

SIT

serie 710 Minisit

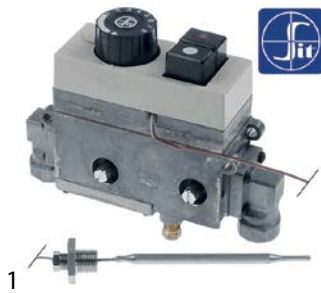

código	106029	referencia	539113290 R296
descripción	termostato de gas SIT tipo MINISIT 710 T máx 200°C 120-200°C entrada gas 3/8" salida gas 3/8" conexión termopar M9x1 conexión de piloto M10x1 sonda ø 6mm sonda L 105mm capilar 1050mm tipo de sensor tipo D1 regulador de presión no regulador de presión mbar prensaestopas M14x1,5 gas de piloto 6mm		
Para modelos:	G350-11, G350-12		
repuestos para	106029		
	código	100068	referencia —
	piloto de encendido 2 llamas empalme de gas 6mm		
	código	100809	referencia —
	junta tórica EPDM espesor 2mm int.ø 21mm UE 1 pzs		
	código	101053	referencia —
	grupo magnético G1: M9x1 G2: M24x1 L 45mm ø 17mm apto para Minisit		
	código	101137	referencia —
	tapa sin piezoencendedor		
	código	101505	referencia —
	empalme de gas rosca 3/8" acodado sin junta tórica MINISIT 710		
	código	101516	referencia —
	tornillo de cabeza plana rosca M4 rosca L 16mm inox DIN 7985/ISO 7045 UE 1 pzs		
	código	106225	referencia —
	sensor 120-200°C sonda ø 6mm sonda L 102mm capilar 1050mm T máx 200°C freidora tipo de sensor tipo D1 apto para MINISIT 710		
accesorios para	106029		
	código	100820	referencia —
	conducción para prensaestopas M M14x1,5 H M10x0,75 sonda ø máx. 6.5mm EC 22		
	código	101273	referencia —
	anillo cortante para tuboø 12mm L 9.5mm latón UE 1 pzs apto para universal		
	código	101276	referencia —
	tornillo de racor rosca 3/8" tubo ø 12mm UE 1 pzs		
	código	101278	referencia —
	anillo cortante para tuboø 10mm UE 1 pzs		
	código	101279	referencia —
	tornillo de racor rosca 3/8" para tuboø 10mm UE 1 pzs		

COPRECI

	1		
código	109140	referencia	539000004 670063
descripción	termostato de gas COPRECI Kit tipo MT7200 entrada gas brida de tubo boquilla bypass ø 0,6/0,4mm salida gas M16x1,5 (tubo ø 10mm) conexión de piloto cerrado conexión termopar M8x1 capilar 1000mm sonda ø 4.5mm sonda L 92mm eje ø 7x5mm eje L 41,5/20mm parte plana derecho entrada de tubo ø 8mm		

	1		
código	109158	referencia	535241008 670034
descripción	termostato de gas COPRECI Kit tipo MT7200 entrada gas brida de tubo boquilla bypass ø 0,6/0,4mm salida gas M16x1,5 (tubo ø 10mm) conexión termopar M8x1 capilar 1000mm sonda ø 4.5mm sonda L 92mm eje ø 5x7mm eje L 41.5mm parte plana derecho entrada de tubo ø 8mm		

	1			
código	109176	referencia	534101050 670004	
descripción	termostato de gas COPRECI Kit tipo MT7200 entrada gas brida de tubo boquilla bypass ø 0,76+0,51mm salida gas M16x1,5 (tubo ø 10mm) conexión termopar M8x1 capilar 1000mm sonda ø 4.5mm sonda L 92mm eje ø 7x5mm eje L 41,5/20mm parte plana derecho entrada de tubo ø 8mm			
repuestos para	109176			
	código	102078	referencia	535400180 R5033
	termopar M10x1 L 600mm M8x1			
	código	107258	referencia	535400120 R3179
	alargador para termopar rosca M10x1 - M8x1 L 1500mm			
	código	107643	referencia	—
	termopar SIT M10x1 L 600mm M8x1			





código	109172	referencia	535101091 600634
descripción	termostato de gas COPRECI Kit tipo MT7200 entrada gas brida de tubo ø21mm boquilla bypass ø 0.76mm salida gas M16x1,5 (tubo ø 10mm) conexión de piloto M10x1 conexión termopar M8x1 capilar 850mm sonda ø 4.5mm sonda L 92mm eje ø 8x6,5mm eje L 46/12mm parte plana abajo entrada de tubo ø 8mm salida de tubo ø 09. Oktmm		



código	109160	referencia	535130132 RZZ69
descripción	termostato de gas COPRECI tipo GT-354 entrada gas brida de tubo ø21mm boquilla bypass ø 0.95mm salida gas M15x1 (tubo ø 10mm) conexión de piloto conexión termopar M8x1 capilar 1200mm sonda ø 5mm sonda L 97mm eje ø 8x6mm eje L 41/20mm parte plana abajo entrada de tubo ø 8mm		



código	109129	referencia	535241007 670033
descripción	termostato de gas COPRECI tipo MT7200 entrada gas brida de tubo ø21mm boquilla bypass ø 0,6+0,44mm salida gas M16x1,5 (tubo ø 10mm) conexión de piloto cerrado conexión termopar M8x1 capilar 1000mm sonda ø 4.5mm sonda L 92mm eje ø 7x5mm eje L 41,5/20mm parte plana abajo entrada de tubo ø 8mm		
Para modelos:	G3161, G3161D		



código	109130	referencia	535200022 670032
descripción	termostato de gas COPRECI tipo MT7200 entrada gas brida de tubo ø21mm boquilla bypass ø 0,76+0,52mm salida gas M16x1,5 (tubo ø 10mm) conexión de piloto cerrado conexión termopar M8x1 capilar 1000mm sonda ø 4.5mm sonda L 92mm eje ø 7x5mm eje L 41,5/20mm parte plana derecho entrada de tubo ø 8mm		
Para modelos:	G3101, G3101D, G3107, G3107D, G3117, G3117D		

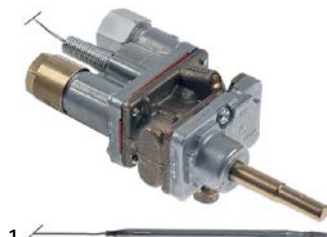

código	109157	referencia	539110756 670058
descripción	termostato de gas COPRECI tipo MT7200 entrada gas brida de tubo ø21mm boquilla bypass ø 0.6mm salida gas M16x1,5 (tubo ø 10mm) conexión de piloto cerrado conexión termopar M8x1 capilar 1000mm sonda ø 4.5mm sonda L 92mm eje ø 7x5mm eje L 41,5/20mm parte plana abajo entrada de tubo ø 8mm		

ROBERTSHAW





código	580074	referencia	537880231 600249
descripción	termostato de gas Kit tipo FDTE 010154 T máx 287°C hasta 287°C entrada gas 1/2" NPT boquilla bypass ø 0mm salida gas 1/2" NPT conexión termopar conexión de piloto cerrado capilar 1380mm sonda ø 5mm sonda L 365mm eje ø 11,1x7,5mm eje L 21/21mm parte plana izquierdo ROBERTSHAW entrada de tubo ø 12mm salida de tubo ø 12mm		
repuestos para	580074		
	código	referencia	531880710
	 termostato de gas tipo FDTE 010154 hasta 287°C low-550°F entrada gas 1/2" NPT boquilla bypass ø 0mm salida gas 1/2" NPT conexión termopar conexión de piloto cerrado capilar 1380mm sonda ø 5mm sonda L 365mm eje ø 11,1x7,5mm eje L 21/21mm parte plana izquierdo ROBERTSHAW		



código	580057	referencia	531880710
descripción	termostato de gas tipo FDTE 010154 hasta 287°C low-550°F entrada gas 1/2" NPT boquilla bypass ø 0mm salida gas 1/2" NPT conexión termopar conexión de piloto cerrado capilar 1380mm sonda ø 5mm sonda L 365mm eje ø 11,1x7,5mm eje L 21/21mm parte plana izquierdo ROBERTSHAW		



código	580052 ¹	referencia	531310100 RMS/1	
descripción	termostato de gas tipo GSH30240000 T máx 190°C 93-190°C 200-375°F entrada gas 1/4" CCT (tubo ø 1/4") boquilla bypass ømm salida gas 1/4" CCT (tubo ø 1/4") conexión termopar conexión de piloto capilar 24" - 610mm sonda ø 3/8" - 9,5mm sonda L 5 3/8" - 135mm prensaestopas 3/8" NPT eje ø 6,4x4,8mm eje L 21/21mm parte plana abajo ROBERTSHAW			
Para modelos:	G1860, G1860-CE			
accesorios para	580052			
	código	101481	referencia	—
	anillo cortante para tuboø 1/4" CCT UE 1 pzs			
	código	106109	referencia	—
	tornillo de apriete rosca 7/16"-24 UNS para tuboø 1/4" L 16mm latón UE 1 pzs EC 7/16" (11,113mm) agujero ø 6.4mm			
	código	106110	referencia	—
	tornillo de racor tubo ø 1/4"mm			

¹con prensaestopa 3/8" NPT

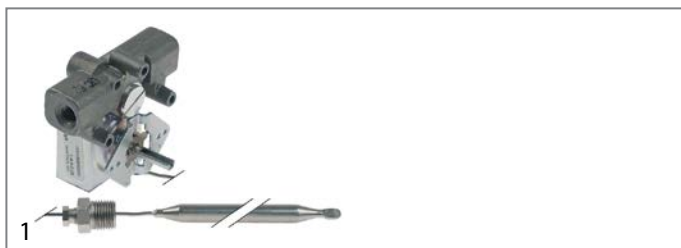



código	580070	referencia	531310110
descripción	termostato de gas tipo GSR3024 93-196°C 200-385°F entrada gas 1/4" CCT (tubo ø 1/4") salida gas 1/4" CCT (tubo ø 1/4") conexión termopar conexión de piloto capilar 600mm sonda ø 9.5mm sonda L 120mm		
Para modelos:	G1860		

válvulas de gas y centralitas de gas automáticas



válvulas de control de gas

HONEYWELL



código	106012	referencia	530550016	
descripción	válvula de gas tipo VK4115V 220-240V 50/60Hz entrada gas brida 32x32mm salida gas brida 32x32mm conexión termopar conexión de piloto margen de presión 15-60mbar máx. 60mbar tipo de operador HONEYWELL brida 32x32mm			
accesorios para	106012			
	código	102845	referencia	—
	empalme de gas acodado 1/2" brida 32x32mm dist. del agujero 24x24mm Tandem			
	código	102846	referencia	—
	empalme de gas recto 1/2" brida 32x32mm dist. del agujero 24x24mm apto para Tandem			



código	106206	referencia	530744050	
descripción	válvula de gas tipo VK4115V 220-240V 50/60Hz entrada gas brida 32x32mm salida gas brida 32x32mm conexión termopar conexión de piloto margen de presión 15-60mbar máx. 60mbar tipo de operador HONEYWELL brida 32x32mm			
accesorios para	106206			
	código	102845	referencia	—
	empalme de gas acodado 1/2" brida 32x32mm dist. del agujero 24x24mm Tandem			
	código	102846	referencia	—
	empalme de gas recto 1/2" brida 32x32mm dist. del agujero 24x24mm apto para Tandem			

1

código	107456	referencia	536114505 G114505
descripción	válvula de gas tipo VR4605A 230V 50Hz entrada gas 1/2" salida gas 1/2" conexión termopar conexión de piloto margen de presión 2,5-20mbar máx. 60mbar tipo de operador 220/240V (V404A 1329) tipo de regulación V5306E HONEYWELL		



1

código	106127	referencia	531310010
descripción	válvula de gas alimentación operador gas entrada 1/4" CCT salida 1/4" CCT entrada gas 3/4" NPT salida gas 3/4" NPT conexión termopar 11/32" conexión de piloto 1/4" CCT tipo 7000BGOR regulador de presión gas natural 5,2" W.C.		
Para modelos:	G1860, G1860-CE		
repuestos para	106127		
	código	101042	referencia —
	grupo magnético G1: 3/8" NEF apto para ROBERTSHAW para operador de gas		
	código	106109	referencia —
	tornillo de apriete rosca 7/16"-24 UNS para tuboø 1/4" L 16mm latón UE 1 pzs EC 7/16" (11,113mm) agujero ø 6.4mm		
	código	580033	referencia N/A
	pomo apto para ROBERTSHAW		

ROBERTSHAW

con controlador a gas



1

código	106126	referencia	531300012 RK14
descripción	válvula de gas alimentación operador gas entrada 1/4" CCT salida 1/4" CCT entrada gas 1/2" NPT salida gas 1/2" NPT conexión termopar 11/32" conexión de piloto 1/4" CCT tipo 7000BGOR regulador de presión gas natural 5,2" W.C. apto para ROBERTSHAW		
Para modelos:	G1830		
repuestos para	106126		
	código	101042	referencia —
	grupo magnético G1: 3/8" NEF apto para ROBERTSHAW para operador de gas		
	código	106109	referencia —
	tornillo de apriete rosca 7/16"-24 UNS para tuboø 1/4" L 16mm latón UE 1 pzs EC 7/16" (11,113mm) agujero ø 6.4mm		
	código	580033	referencia N/A
	pomo apto para ROBERTSHAW		

con controlador a termopila



1

código	107354	referencia	535710035 R3835
descripción	válvula de gas alimentación operador Millivolt entrada gas 1/2" NPT salida gas 1/2" NPT conexión termopar 11/32" conexión de piloto 1/4" CCT tipo U7000MVRL regulador de presión gas natural 6,7" W.C.		



SIT

ELETTROSIT



1

código	106032	referencia	531750330 RKK24
descripción	válvula de gas SIT tipo ELETTROSIT aliment. 230V entrada gas 1/2" salida gas 1/2" conexión termopar ASA 11/32 conexión de piloto M10x1 abajo núm. Ref. 0.810.156		
Para modelos:	G1962, G1965, G1994, G1995, G2962, G2965, G2994, G2995		
repuestos para	106032		
	código	100006	referencia —
	encendedor piezoeléctrico apto para ELETTROSIT cuerpo plástico soplado empalme ø2,4mm ø 14mm		



NOVASIT





1

código	107302	referencia	537350016 801433
descripción	válvula de gas SIT serie Novasit 820 aliment. 0.17V entrada gas 1/2" salida gas 1/2" conexión termopar M9x1 conexión de piloto M10x1 margen de presión 3-30mbar conexión del presostato M13x1 núm. Ref. 0820303 alimentación operador Millivolt		

1

	código	107429	referencia	537350019 801808
	descripción	válvula de gas SIT serie Novasit 820 aliment. 0.17V entrada gas 1/2" salida gas 1/2" conexión termopar M9x1 conexión de piloto M10x1 margen de presión 3-30mbar núm. Ref. 0820303 alimentación operador Millivolt Kit		
	repuestos para	107429		
	código	100110	referencia	—
	piloto de encendido SIT tipo serie 190 3 llamas boquilla ømm empalme de gasmm			

repuestos para	107429			
	código	107239	referencia	537350006
	válvula de gas SIT serie Novasit 820 aliment. 0.17VHz entrada gas 1/2" salida gas 1/2" conexión termopar M9x1 conexión de piloto M10x1 presión de encendido 3-5mbar margen de presión 3-30mbar conexión del presostato ciego núm. Ref. 0820303 alimentación operador Millivolt			
	código	107267	referencia	535480040 535710028 600039 RZZ303
	encendedor piezoeléctrico cuerpo plástico soplado montaje ø 18mm empalme F2,8x0,8			
	código	107296	referencia	535410011 660019
	línea de gas empalme ø6mm L 450mm ø ext. 8mm inox flexible grosor de la pared 0.5mm longitud de empalme 25mm			



1

código	107239	referencia	537350006	
descripción	válvula de gas SIT serie Novasit 820 aliment. 0.17VHz entrada gas 1/2" salida gas 1/2" conexión termopar M9x1 conexión de piloto M10x1 presión de encendido 3-5mbar margen de presión 3-30mbar conexión del presostato ciego núm. Ref. 0820303 alimentación operador Millivolt			
repuestos para	107239			
	código	100110	referencia	—
	piloto de encendido SIT tipo serie 190 3 llamas boquilla ømm empalme de gasmm			
	código	101065	referencia	—
	grupo magnético con cable L 44mm D1 ø 30mm D2 ø 20mm apto para NOVASIT			
	código	101305	referencia	—
	empalme de gas recto 1/2" brida 45x45mm ELETTROSIT/V4400/4600/4605 para SIT/HONEYWELL dist. del agujero 36x36mm			
	código	101306	referencia	—
	empalme de gas acodado brida 45x45mm dist. del agujero 36x36mm 1/2" ELETTROSIT/V4400/4600/4605 atornillado con junta tórica para SIT/HONEYWELL			
	código	101307	referencia	—
	empalme de gas recto brida 45x45mm dist. del agujero 36x36mm 3/4" ELETTROSIT/V4400/4600/4605 atornillado con junta tórica para SIT/HONEYWELL			
	código	101308	referencia	—
	empalme de gas acodado brida 45x45mm dist. del agujero 36x36mm 3/4" ELETTROSIT/V4400/4600/4605 atornillado con junta tórica para SIT/HONEYWELL			
	código	101312	referencia	—
	microinterruptor			
	código	101799	referencia	—
	adaptador de pomo eje ø 10x8mm eje L 18mm pieza de cierre abajo apto para ZANUSSI parte plana arriba			

Continúa en la página siguiente



repuestos para	107239			
	código	102116	referencia	537350005 R3825
	termogenerador ROBERTSHAW L 900mm sonda ø 9mm sonda L 57mm 250-750mV unión roscada 7/16"			





código	107430 ¹	referencia	535670022 638045
---------------	---------------------	-------------------	---------------------

descripción válvula de gas SIT serie Novasit 820 aliment. 0.17VHz entrada gas 1/2" salida gas 1/2" conexión termopar M9x1 conexión de piloto M10x1 presión de encendido 3-5mbar margen de presión 3-30mbar conexión del presostato ciego núm. Ref. 0820303 alimentación operador Millivolt

Para modelos: G3203, G3830, G3865

repuestos para	107430		
----------------	--------	--	--

	código	107239	referencia	537350006
	válvula de gas SIT serie Novasit 820 aliment. 0.17VHz entrada gas 1/2" salida gas 1/2" conexión termopar M9x1 conexión de piloto M10x1 presión de encendido 3-5mbar margen de presión 3-30mbar conexión del presostato ciego núm. Ref. 0820303 alimentación operador Millivolt			

	código	109128	referencia	—
	regulador de presión latón L 25mm ø 11.5mm rosca M13x1 para válvula de gas apto para válvulas de gas UE 1 pzs			

¹con regulador de presión y adaptador M18x1,5 (tubo ø12mm)

SIGMA





código	107245	referencia	536300030 750020
---------------	--------	-------------------	---------------------

descripción válvula de gas Kit tipo 0840036 aliment. 230V 50Hz entrada gas 1/2" salida gas 1/2" margen de presión 2-50mbar

Para modelos: G3840, G401, G401F, G402, G402F

repuestos para	107245		
----------------	--------	--	--

	código	106214	referencia	—
	bobina magnética aliment. 230V 50Hz Sigma			

	código	107253	referencia	—
	válvula de gas tipo 0840036 aliment. 230V 50Hz entrada gas 1/2" salida gas 1/2" margen de presión 2-50mbar			

accesorios para	107245		
-----------------	--------	--	--

	código	107222	referencia	—
	conector para válvula magnética 3 polos longitud del cable 1070mm			

TANDEM



código	107303	referencia	534400080 R2885
---------------	--------	-------------------	--------------------

descripción válvula de gas aliment. 230V 50Hz entrada gas 1/2" salida gas 1/2" conexión de piloto M10x1 tiempo de encendido 3-7s margen de presión 3-50mbar alim. para modulador tipo Tandem 830 SIT núm. Ref. 0.830.033

Para modelos: G4069, G4109

centralitas de gas automáticas

HONEYWELL



código	101165	referencia	536113060 G113060
---------------	--------	-------------------	----------------------

descripción centralita de gas automática HONEYWELL tipo S4560A 1008 núm. Ref. S4560A 1008 electrodos 1 tiempo de espera 0s tiempo de seguridad 10s 220-240V 10VA 50Hz

repuestos para	101165		
----------------	--------	--	--

	código	358696	referencia	—
	fusible fino medida ø5x20mm 4A semi retardado nominal 250V UE 10 pzs			

Honeywell



código	104647	referencia	536060016 R5439
---------------	--------	-------------------	--------------------

descripción centralita de gas automática HONEYWELL tipo S4565BD 3072 electrodos 3 tiempo de esperas tiempo de seguridad 3.5s 220-240V 4VA 50/60Hz

Para modelos: G2840, G2841, G2842, G2845F



Honeywell



1

código	103109	referencia	530550018
descripción	centralita de gas automática HONEYWELL tipo S4565C 1116 electrodos 2 tiempo de esperas tiempo de seguridad 5s 220-240V 4VA 50/60Hz		

SIT



1

código	102387	referencia	534400107 R2886
descripción	centralita de gas automática SIT tipo 503EFD electrodos 1 tiempo de espera 1.5s tiempo de seguridad 60s 220/240V 12VA 50-60Hz protección IP20		
Para modelos:	G4069, G4109		



1

código	107246	referencia	536300024 RV11
descripción	centralita de gas automática SIT tipo 571DBC electrodos 2 tiempo de espera 1s tiempo de seguridad 10s 230V 12VA 50/60Hz		
Para modelos:	G3106, G3840, G401, G401F, G402, G402F		

otros



1

código	107275	referencia	531930500 R3603
descripción	centralita de gas automática PACTROL tipo P13MKII apto para FALCON electrodos 2 tiempo de espera 1s tiempo de seguridad 3s 230V 50Hz		
Para modelos:	G1808-CE, G1808-Pre-CE, G1838-CE, G1848-CE, G1848-Pre-CE, G7004, G7008, G7011, G7204, G7208, G7211		

válvulas de seguridad

otros



1

código	107305	referencia	530961050 RRR37/3
descripción	válvula de seguridad BLACK TEKNIGAS tipo 3703/1/2IN margen de presión 0-50mbar entrada gas 1/2" H salida gas 1/2" H conexión termopar M9x1 M10x1 conexión de piloto M10x1 F (tubo ø 6mm)		



1

código	107251	referencia	530962080 RHH28
descripción	válvula de seguridad BLACK TEKNIGAS tipo G840HG margen de presión 0-50mbar entrada gas 1/2" (tubo ø 9/16") salida gas 1/2" (tubo ø 9/16") conexión termopar M9x1		
Para modelos:	G1107CE-OT		



válvulas magnéticas de gas

diversos



1

código	370711	referencia	531750320 531930530 701251
descripción	válvula magnética gas 2vías 230VAC entrada 1/2" H salida 1/2" H empalme cable L 69mm BLACK TEKNIGAS homologación IP40 altura total 94mm		
Para modelos:	G1962, G1965, G1994, G1995, G2962, G2965, G2994, G2995, G7004, G7008, G7011, G7204, G7208, G7211		



1

código	107442	referencia	534510930 RZZ43
descripción	válvula magnética gas 2vías triple 230VAC entrada 1/2" salida 1/2" L 105mm p máx. 0.065bar altura total 145mm		
Para modelos:	G1808-CE, G1808-Pre-CE, G1838-CE, G1848-CE, G1848-Pre-CE		

encendidos y tempares

pilotos de encendido

SIT

serie 140 - 145 - 150



1

código	107249	referencia	531600055 534101002 700019
descripción	piloto de encendido SIT tipo serie 145 2 llamas gas licuado boquilla 19 boquilla ø 0.23/0.26mm empalme de gas 4mm dirección de la llama izquierdo		
Para modelos:	G3107, G3107D, G3127, G3512, G3532, G401, G401F, G402, G402F		



1

código	107295	referencia	537130070 700005
descripción	piloto de encendido SIT tipo serie 145 2 llamas gas licuado boquilla 19 boquilla ø 0.23/0.26mm empalme de gas 6mm dirección de la llama izquierdo		



1

código	107285	referencia	531600050 60073	
descripción	piloto de encendido SIT tipo serie 145 2 llamas gas natural boquilla 30 boquilla ø 0,60/0,40mm empalme de gas 4mm dirección de la llama izquierdo			
Para modelos:	G2512, G2522, G2532, G3512, G3532, G401, G401F, G402, G402F			
repuestos para	107285			
	código	107286	referencia	531600070 R3106
	boquilla de quemador piloto SIT gas natural código 30 taladro ø 0,60/0,40mm UE 1 pzs			







1





código	107232	referencia	535820022 RH35
descripción	piloto de encendido SIT tipo serie 150 2 llamas boquilla ømm empalme de gasmm		
Para modelos:	G21223, G21523, G21823, G2623, G2641, G2642, G2642B, G2923, G2941, G2942		





1

código	107451	referencia	531750401 700016
descripción	piloto de encendido SIT tipo serie 150 2 llamas gas licuado boquilla 19 boquilla ø 0.23/0.26mm empalme de gas 6mm		
Para modelos:	G1962, G1965, G1994, G1995, G2962, G2965, G2994, G2995		

			
1			
código	107248	referencia	535100961 535101021 700004
descripción	piloto de encendido SIT tipo serie 150 2 llamas gas natural boquilla 36 boquilla ø 0,60/0,55mm empalme de gas 4mm		
Para modelos:	G3441, G3441R, G3641, G3941		
repuestos para	107248		
		código	100206 referencia 530961100 RH36/4
	boquilla de quemador piloto SIT gas natural código 36 taladro ø 0,60/0,55mm UE 1 pzs apto para SIT serie 150		
		código	100897 referencia —
	anillo cortante para tuboø 4mm UE 1 pzs para quemador piloto		
		código	100908 referencia —
	tornillo de racor rosca M10x1 para tuboø 4mm UE 1 pzs		

			
1			
código	107247	referencia	536000028 700006
descripción	piloto de encendido SIT tipo serie 150 2 llamas gas natural boquilla 36 boquilla ø 0,60/0,55mm empalme de gas 6mm		
Para modelos:	G21224B, G21524B, G21824B, G2624B, G2924B		
repuestos para	107247		
		código	100206 referencia 530961100 RH36/4
	boquilla de quemador piloto SIT gas natural código 36 taladro ø 0,60/0,55mm UE 1 pzs apto para SIT serie 150		
		código	100898 referencia —
	anillo cortante para tuboø 6mm UE 1 pzs para quemador piloto		
		código	100909 referencia —
	tornillo de racor rosca M10x1 para tuboø 6mm UE 1 pzs		



serie 190			
			
1			
código	107250	referencia	537350003 801806
descripción	piloto de encendido SIT tipo serie 190 3 llamas gas natural boquilla 51 boquilla ø 0.51mm empalme de gasmm Kit		

POLIDORO			
pilotos de encendido			
			
1			
código	107274	referencia	536300033 536300048 850083
descripción	piloto de encendido POLIDORO 3 llamas gas licuado código 25.2 empalme de gas 4mm completo con soporte		
Para modelos:	E3840, G3800, G3840, G401, G401F, G402, G402F		

			
1			
código	107356	referencia	537883019 R3211
descripción	piloto de encendido POLIDORO 3 llamas gas natural boquilla 29.2 código 29.2 empalme de gas 6mm		

			
1			
código	107272	referencia	535010005 896445
descripción	piloto de encendido POLIDORO 3 llamas gas natural boquilla 31.2 código 31.2 empalme de gas 4mm con soporte		
Para modelos:	G2625, G31225, G31225ES, G31525, G31525ES, G3425, G3625, G3625ES, G3925, G3925ES		

			
1			
código	107424	referencia	535520005 R5066
descripción	piloto de encendido POLIDORO 3 llamas gas natural código 29.2 empalme de gas 6mm		
Para modelos:	G2131-OT, G2151EU, G2151-OT		

			
1			
código	107425	referencia	537883017 610033
descripción	piloto de encendido POLIDORO 3 llamas gas natural código 29.2 empalme de gas 6mm con termopar		
repuestos para	107425		
		código	102036 referencia —
	termopar M8x1 L 1000mm conexión para conector ø6,0(6,5)mm		

Continúa en la página siguiente



repuestos para	107425		
	código	107356	referencia
			537883019 R3211
	piloto de encendido POLIDORO 3 llamas gas natural boquilla 29-2 código 29.2 empalme de gas 6mm		

ROBERTSHAW

pilotos de encendido

serie universal - tipo 3

	1		
código	580034	referencia	539220540 RZZ98
descripción	piloto de encendido ROBERTSHAW tipo 3CH-6 2 llamas gas natural código 18 para tuboø 1/4" CCT		
Para modelos:	G350-10, G350-9		

	1		
código	106083	referencia	537960022 RZZ97
descripción	piloto de encendido ROBERTSHAW tipo 3CHL-6 2 llamas gas natural código 18 para tuboø 1/4" CCT		

serie universal - tipo 6

Anchura de las partes superiores:
 6CH10 = 1" (25,4mm)
 6CH14 = 1½" (38,1mm)
 6CH24 = 2½" (63,5mm)
 6CH30 = 3" (76,2mm)



	1		
código	106092	referencia	531300050
descripción	piloto de encendido ROBERTSHAW tipo 6CH14-1 3 llamas gas natural código 26 para tuboø 1/4" CCT		
Para modelos:	G1830		

	1		
código	107269	referencia	531720060 537210280 610018 R3032
descripción	piloto de encendido ROBERTSHAW tipo 6CH24-1 3 llamas gas natural código 22 para tuboø 1/4" CCT		

	1		
código	106117	referencia	531310050 RM5
descripción	piloto de encendido ROBERTSHAW tipo 6CH24-1 3 llamas gas natural código 26 para tuboø 1/4" CCT empalme de gas 1/4" CCTmm boquilla ømm		
Para modelos:	G1860, G1860-CE		



serie universal con electrodos

	1		
código	107270	referencia	535710080 600921
descripción	piloto de encendido ROBERTSHAW tipo 4SHR-44 3 llamas gas licuado código 11 para tuboø 1/4" CCT		

	1		
código	106087	referencia	N/A
descripción	piloto de encendido ROBERTSHAW tipo 4SHR-44 3 llamas gas licuado código 16 para tuboø 1/4" CCT		
repuestos para	106087		
	código	101481	referencia
			—
	anillo cortante para tuboø 1/4" CCT UE 1 pzs		
	código	101482	referencia
			—
	tuerca de racor rosca 1/4" largo		

Continúa en la página siguiente



repuestos para	106087		
	código	102116	referencia
			537350005 R3825
	termogenerador ROBERTSHAW L 900mm sonda ø 9mm sonda L 57mm 250-750mV unión roscada 7/16"		
	código	102277	referencia
			535710039 R6450
	termopar ROBERTSHAW ASA 11/32 L 36" - 915mm 7/16"		
	código	106105	referencia
			531300070 RM5/6
	boquilla de quemador piloto gas licuado código 16 apto para ROBERTSHAW		



1

código	107271	referencia	535710070 R3761
descripción	piloto de encendido ROBERTSHAW tipo 4SHR-44 3 llamas gas natural código 18 para tuboø 1/4" CCT		



1

código	106086	referencia	N/A
descripción	piloto de encendido ROBERTSHAW tipo 4SHR-44 3 llamas gas natural código 26 para tuboø 1/4" CCT		
repuestos para	106086		
	código	100277	referencia
			535710091 RM5/7
	boquilla de quemador piloto gas natural código 26 apto para ROBERTSHAW		
	código	101481	referencia
			—
	anillo cortante para tuboø 1/4" CCT UE 1 pzs		
	código	101482	referencia
			—
	tuerca de racor rosca 1/4" largo		
	código	102116	referencia
			537350005 R3825
	termogenerador ROBERTSHAW L 900mm sonda ø 9mm sonda L 57mm 250-750mV unión roscada 7/16"		
	código	102277	referencia
			535710039 R6450
	termopar ROBERTSHAW ASA 11/32 L 36" - 915mm 7/16"		

HONEYWELL

pilotos de encendido



1

código	107448	referencia	536123580 G123580
descripción	piloto de encendido HONEYWELL tipo Q345A 1313 2 llamas gas natural/licuado boquilla BCR18/BBR10 1/4"		

pilotos de encendido específicos del fabricante

FALCON



1

código	107273	referencia	537400190 537880680 R3130
descripción	parte superior de quemador piloto 1 llama gas natural boquilla 30		
Para modelos:	G1629		



1

código	107492	referencia	537400195 537880685 R3131
descripción	piloto de encendido 1 llama gas licuado boquilla 31		
Para modelos:	G1629		



electródos

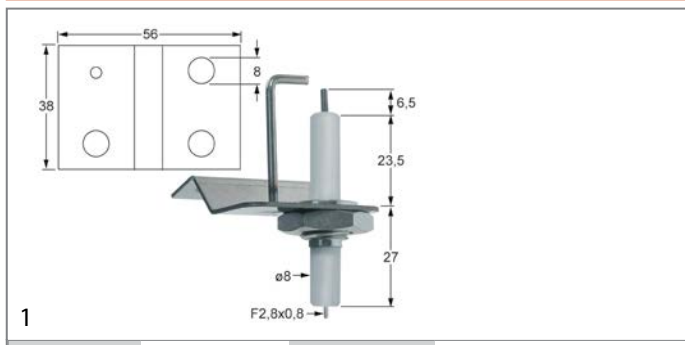

código	107355	referencia	535700560 899031
descripción	electrodo de encendido con soporte longitud brida 56mm anchura brida 38mm D1 ø 8mm L1 6.5mm LC1 23.5mm LC2 27mm empalme conector Faston 2,8mm medida de sujeción ø8mm distancia de sujeción 22mm		

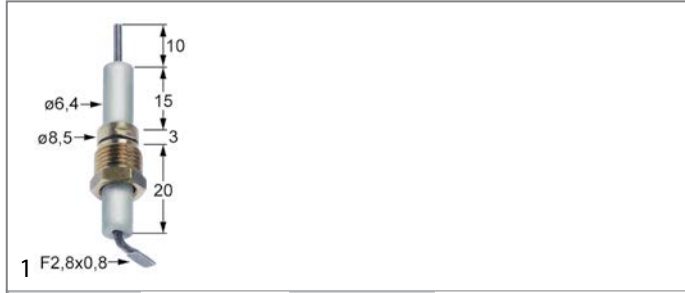

código	107281	referencia	530760010 537350007 801498 R3823
descripción	electrodo de encendido D1 ø 6.4mm D2 ø 8.5mm L1 10mm LC1 15mm LC2 3mm LC3 20mm empalme conector Faston 2,8mm M10x1		
Para modelos:	G2078TC-135L, G3203, G3206, G3830, G3860, G3865		

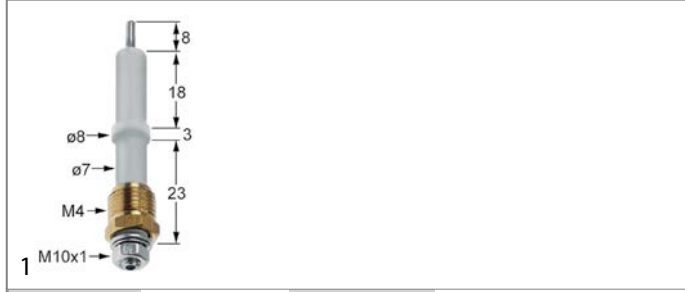

código	107280	referencia	530780060 531600090 531600100 703445 RH36 RH36/1
descripción	electrodo de encendido D1 ø 7mm D2 ø 8.5mm empalme M4 L1 8mm LC1 18mm LC2 3mm LC3 23mm M10x1		
Para modelos:	G3080-45L, G3080-90L		



código	107313	referencia	535950022 703180
descripción	electrodo de encendido D1 ø 7mm D2 ø 9mm empalme M4 L1 8mm LC1 18mm LC2 3mm LC3 23mm con racor		
Para modelos:	G21224B, G21523, G21524B, G21823, G21824B, G2623, G2624B, G2923, G2924B		

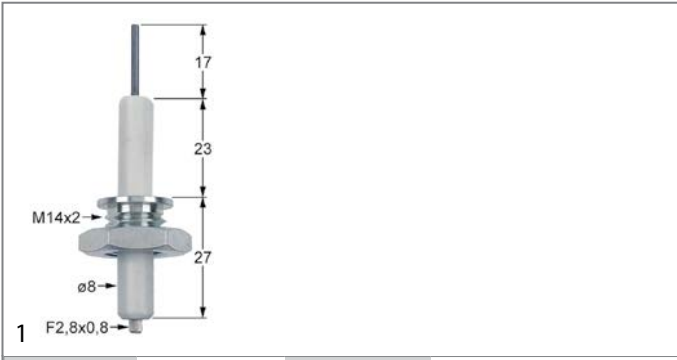

código	107282	referencia	535480033 RZZ304
descripción	electrodo de encendido D1 ø 8mm L1 17mm LC1 23mm LC2 27mm empalme conector Faston 2,8mm M14x2		
Para modelos:	G2101EU, G2101-OT, G2107EU, G2107-OT, G2107-SB, G2131-OT, G2151EU, G2161EU, G2161-OT, G2167-OT, G3101, G3101D, G3107, G3107D, G3117, G3117D, G3161, G3161D		



código	104638	referencia	536003328 G3328
descripción	electrodo de encendido D1 ø 9.5mm D2 ø 8mm L1 28mm LC1 9mm LC2 16mm LC3 16mm empalme conector Faston 6,3mm 7/16"		

1 componentes gas

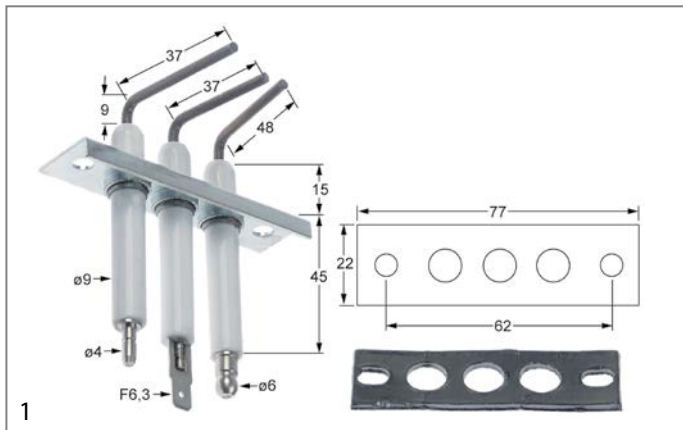

código	107306	referencia	536060018 802104
descripción	electrodo de encendido grupo longitud brida 77mm anchura brida 22mm D1 ø 9.5mm L1 9mm L2 37/37/48mm LC1 15mm LC3 45mm empalme ø4/6mm/conector Faston 6,3mm distancia de sujeción 62mm		
Para modelos:	G2840, G2841, G2842, G2845F		

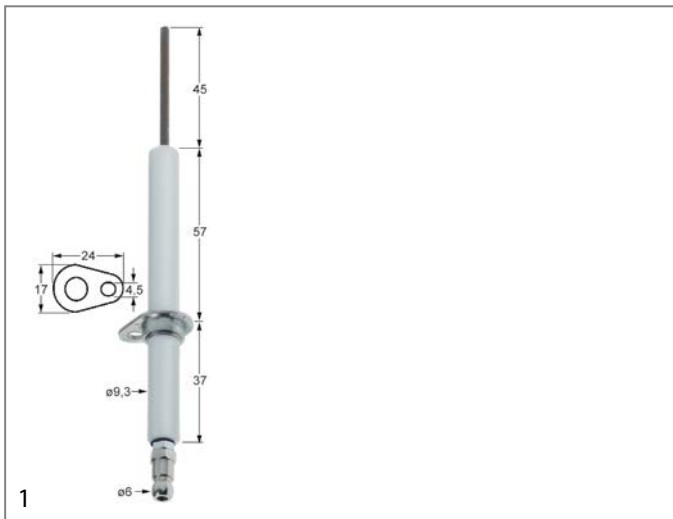

código	106756	referencia	530550017
descripción	electrodo de encendido longitud brida 24mm anchura brida 17mm D1 ø 9.3mm L1 45mm L2 70mm LC1 35mm LC2 22mm empalme ø6 medida de sujeción ø4,5mm A1/B13/C2		

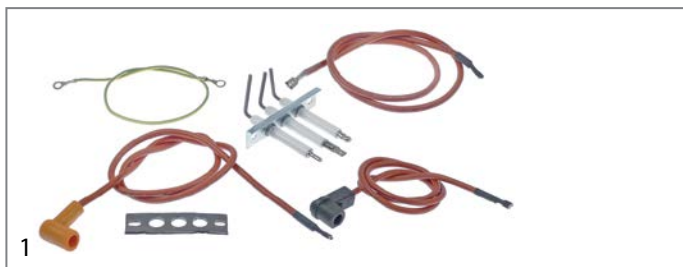

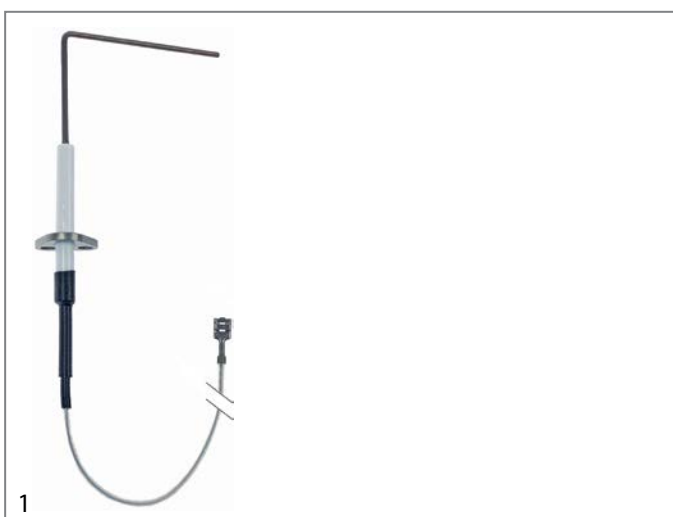

código	107452	referencia	536060030 802170
descripción	electrodo de encendido Kit longitud brida 77mm anchura brida 25mm D1 ø 9.5mm L1 9mm L2 37/49mm LC1 15mm LC2 43mm empalme ø4/6mm/conector Faston 6,3mm distancia de sujeción 62mm brida		
Para modelos:	G2840, G2841, G2842		
repuestos para	107452		

código	107306	referencia	536060018 802104
descripción	electrodo de encendido grupo longitud brida 77mm anchura brida 22mm D1 ø 9.5mm L1 9mm L2 37/37/48mm LC1 15mm LC3 45mm empalme ø4/6mm/conector Faston 6,3mm distancia de sujeción 62mm		

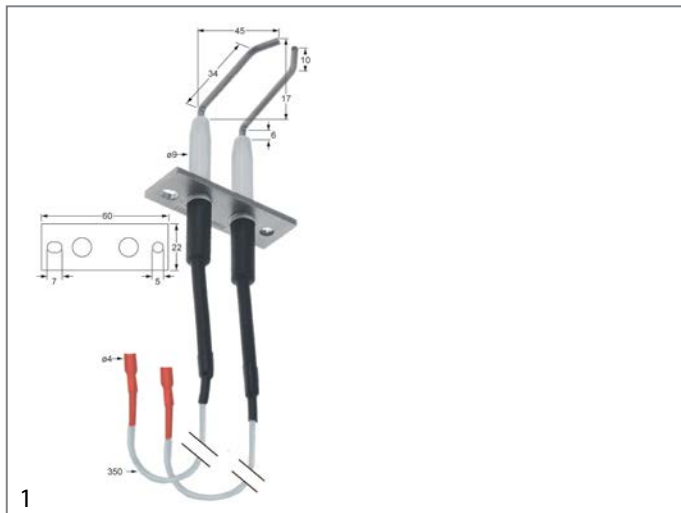

código	107890	referencia	530507184
descripción	electrodo de encendido longitud brida 24mm anchura brida 20mm D1 ø 7mm L1 45mm L2 70mm LC1 35mm LC2 22mm empalme F6,3 longitud del cable 450mm distancia de sujeción 9mm		



código	106996	referencia	530874787
descripción	electrodo de encendido longitud brida 60mm anchura brida 22mm D1 ø 9mm L1 17mm L2 45mm L3 6mm L4 34/10mm LC1 37mm LC2 32mm longitud del cable 350mm ø empalme ø4mm		
accesorios para	106996		
	código	referencia	—
	junta electrodo de encendido int.ø 13mm agujero ø 6mm L 60mm An 22mm apto para ELOMA grafito		

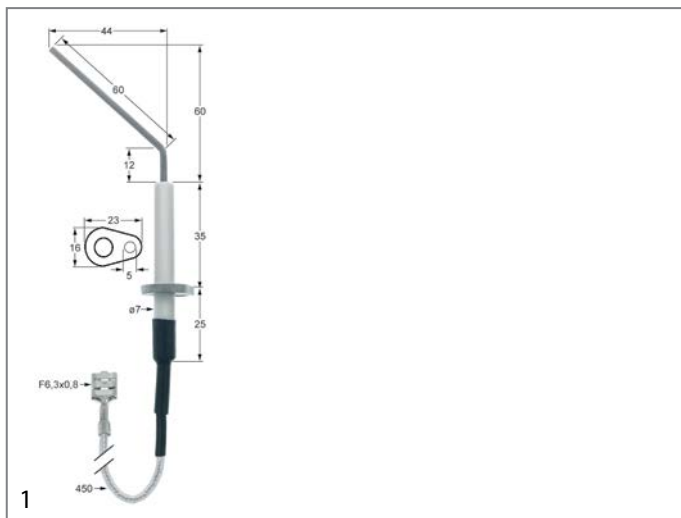

código	106997	referencia	530874906
descripción	electrodos de supervisión ø empalme F6,3mm longitud brida 23mm anchura brida 16mm D1 ø 7mm L1 60mm L2 44mm L4 12mm L3 60mm LC1 35mm LC2 25mm empalme F6,3x0,8 longitud del cable 450mm medida de sujeción ø5mm		



código	108151	referencia	530507496
descripción	junta bujía L 22.5mm An 15.5mm espesor 2mm grafito		



código	109177	referencia	535770090 R5215
descripción	junta para electrodo L 80mm An 30mm		



código	107294	referencia	531930585 T466007
descripción	soporte para electrodo de encendido L 112mm An 50mm taladro ø 14x13mm		
Para modelos:	G7004, G7008, G7011, G7204, G7208, G7211		



código	107307	referencia	536117003 G117003
descripción	soporte para electrodo de encendido L 41mm An 32mm taladro ø 8,5mm		

cables de encendido

cables prefabricados





código	107428	referencia	534510220 600017
descripción	cable de encendido juego empalme conector Faston 2,8mm		
Para modelos:	G1838-CE		



			
código	100036	referencia	531300122 531310122 700903 700913
descripción	cable de encendido longitud del cable 500mm empalme F2,8mm / F2,8mm		
Para modelos:	G1830, G1860, G1860-CE		

			
código	102159	referencia	531750350 537101590 701202 703346
descripción	cable de encendido longitud del cable 600mm empalme F2,8mm / F2,8mm		
Para modelos:	G1107CE-OT, G1962, G1965, G1994, G1995, G2962, G2965, G2994, G2995		

			
código	102156	referencia	530730014 530840110 531880741 535010002 539110290 609945 635060 701501 70151 703175 705002
descripción	cable de encendido longitud del cable 600mm empalme F2,8mm / ojal M4		
Para modelos:	G2078-45L, G2625, G2642B, G3478, G350-11, G350-12, G5478, G6478		

			
código	100037	referencia	535700580 609904
descripción	cable de encendido longitud del cable 900mm empalme F2,8mm / F2,8mm		

			
código	102195	referencia	530740007 701506
descripción	cable de encendido longitud del cable 900mm empalme F2,8mm / ojal M4		
Para modelos:	G2078-135L, G2078-90L		



encendedores piezoeléctricos

diámetro de montaje 18mm



código	107267	referencia	535480040 535710028 600039 RZZ303
descripción	encendedor piezoeléctrico cuerpo plástico soplado montaje ø 18mm empalme F2,8x0,8		
Para modelos:	G2101EU, G2101-OT, G2107EU, G2107-OT, G2107-SB, G2131-OT, G2151EU, G2151-OT, G2161EU, G2161-OT, G2167-OT		



			
código	107268	referencia	534101016 800150
descripción	encendedor piezoeléctrico cuerpo plástico soplado montaje ø 18mm empalme F2,8x0,8 juego		
repuestos para	107268		
	código	100037	referencia
			535700580 609904
	cable de encendido longitud del cable 900mm empalme F2,8mm / F2,8mm		
	código	107267	referencia
			535480040 535710028 600039 RZZ303
	encendedor piezoeléctrico cuerpo plástico soplado montaje ø 18mm empalme F2,8x0,8		

diámetro de montaje 22mm



			
código	107266	referencia	535010000 R5812
descripción	encendedor piezoeléctrico cuerpo plástico soplado montaje ø 22mm empalme F2,8x0,8 longitud del cable mm		
Para modelos:	G2625, G2642B, G3101, G3101D, G3107, G3107D, G3117, G3117D, G31225, G31225ES, G31525, G31525ES, G3161, G3161D, G3425, G3441, G3441R, G3625, G3625ES, G3641, G3830, G3865, G3925, G3925ES, G3941		



1 componentes gas

otros



código	107445	referencia	531750340 RAA9
descripción	encendedor piezoeléctrico empalme conector Faston 2,8mm con soporte		
Para modelos:	G1962, G1965, G1994, G1995, G2962, G2965, G2994, G2995		

accesorios

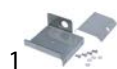

código	107308	referencia	531880743 610219
descripción	soporte para piezoencendedor taladro ø 18.5mm para FALCON		

unidades de encendido



código	104688	referencia	530550037
descripción	grupo de encendido salidas 1 220-240VAC medidas 84x62x38mm distancia de sujeción 59mm entrada F6,3x0,8 salida ø4mm tipo TRK2-30PVD 69VA 50/60Hz 0.3A protección IP00		

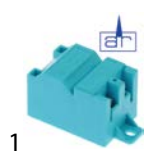

código	107278	referencia	531930480 804031
descripción	grupo de encendido salidas 2 220-240VAC 50-60Hz		
Para modelos:	G1808-CE, G1808-Pre-CE, G1838-CE, G1848-CE, G1848-Pre-CE, G7004, G7008, G7011, G7204, G7208, G7211		

termopares

juegos de termopares universales



código	102541	referencia	535101250
descripción	juego de termopares 12 piezas L 900mm		



código	102544	referencia	537960021 RII30
descripción	juego de termopares 8 piezas L 1200mm		

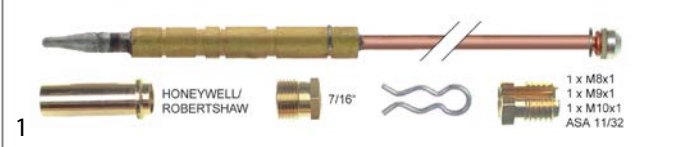

código	102284	referencia	537060110 539220530 600506 R3158
descripción	juego de termopares 8 piezas L 900mm		
Para modelos:	G350-10, G350-9		

termopares insertables

termopares insertables estándar

ROBERTSHAW

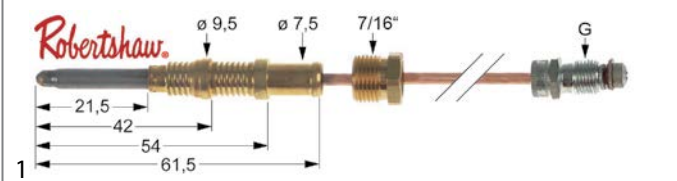

código	102277	referencia	535710039 R6450
descripción	termopar ROBERTSHAW ASA 11/32 L 36" - 915mm 7/16"		

con casquillo de enchufe ø5mm - type Junkers with aluminised tip

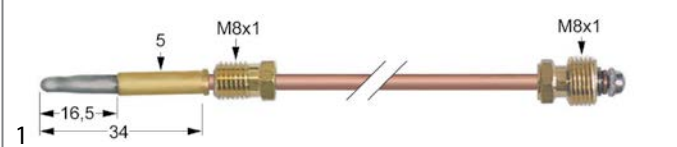

código	107453	referencia	537060100 R3157
descripción	termopar M8x1 L 320mm clavija ø5,0mm		

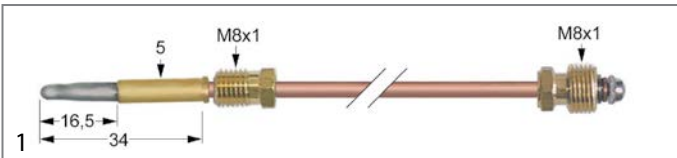

código	107449	referencia	537060112 610079
descripción	termopar M8x1 L 700mm clavija ø5,0mm		

con casquillo de enchufe $\varnothing 6\text{mm}$

SIT

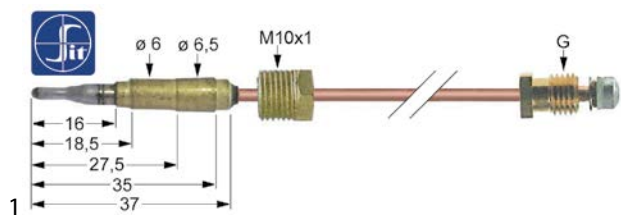

código	107256	referencia	537880070 R5369
descripción	termopar M10x1 L 1200mm conexión para conector $\varnothing 6,0(6,5)\text{mm}$		

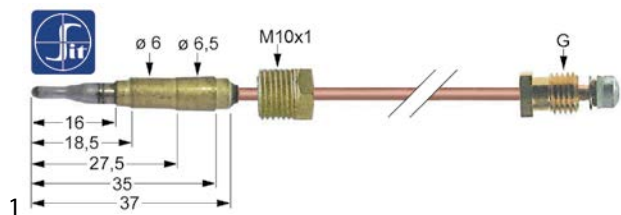

código	107299	referencia	531750360 R5580
descripción	termopar SIT ASA 11/32 L 750mm clavija $\varnothing 6,0\text{mm}$		
Para modelos:	G1962, G1965, G1994, G1995, G2962, G2965, G2994, G2995		

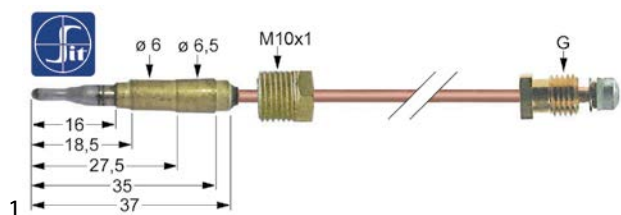

código	107257	referencia	531610010 R3100
descripción	termopar SIT M10x1 L 1000mm conexión para conector $\varnothing 6,0(6,5)\text{mm}$		
Para modelos:	G2512, G2522, G3512		

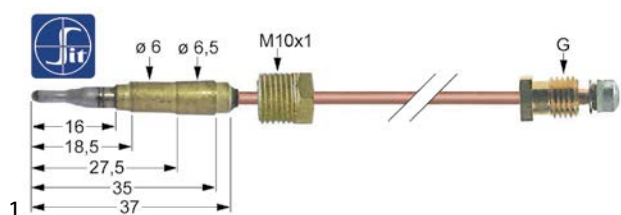

código	107259	referencia	531600040 R3099
descripción	termopar SIT M10x1 L 500mm clavija $\varnothing 6,0\text{mm}$		
Para modelos:	G2532, G3532		

termopares insertables niquelados

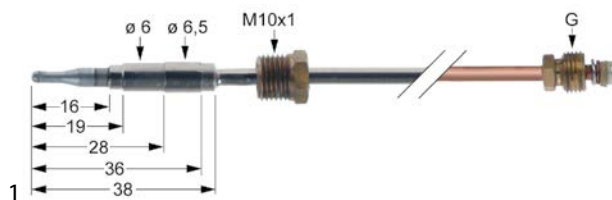

código	107260	referencia	534101001 P3100
descripción	termopar niquelado M10x1 L 1000mm conexión para conector $\varnothing 6,0(6,5)\text{mm}$		
Para modelos:	G3107, G3107D, G3127		

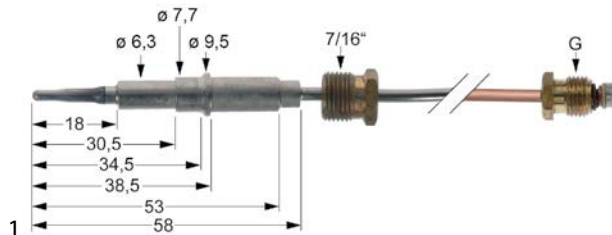

código	107297	referencia	535101250 R6096
descripción	termopar niquelado M10x1 L 600mm clavija $\varnothing 6,0\text{mm}$		

termopares insertables con interrupción

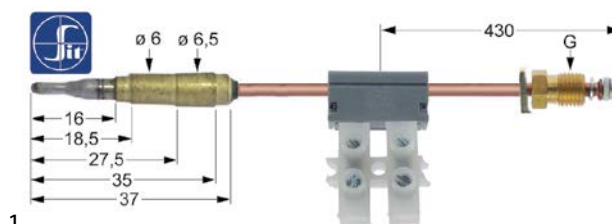

código	107455	referencia	535670024 638007
descripción	termopar con interruptor M9x1 L 850mm conexión para conector $\varnothing 6,0(6,5)\text{mm}$ conexión para soldadura		
Para modelos:	G3203, G3206, G3830, G3860, G3865		

repuestos para	107455		
	código	100907	referencia —
	unión roscada rosca M10x1 UE 1 pzs tipo SEF 1 $\varnothing\text{mm}$ para termopar		
	código	101265	referencia —
	interruptor rosca M9x1		
	código	107460	referencia —
	termopar SIT con interruptor M9x1 L 850mm clavija $\varnothing 6,0\text{mm}$ conexión para soldadura		



código	107261	referencia	537350015 801443
descripción	termopar SIT con interruptor M9x1 L 600mm clavija ø6,0mm cable 350mm		

código	107454	referencia	537350033 R5830
descripción	termopar SIT con interruptor M9x1 L 600mm conexión para conector ø6,0(6,5)mm conexión para soldadura		

termopares roscados

termopares roscados estándar

con casquillo roscado M8x1

SIT

código	107636	referencia	530962140 RJJ12
descripción	termopar SIT M9x1 L 600mm M8x1		
Para modelos:	G1107CE-OT		
accesorios para	107636		
	código	102067	referencia —
	tuerca rosca M8x1 H 3mm latón UE 1 pzs tipo SEF 1		

tipo Junkers con punta aluminizada

código	102078	referencia	535400180 R5033
descripción	termopar M10x1 L 600mm M8x1		
Para modelos:	G2101EU, G2101-OT, G2107EU, G2107-OT, G2107-SB, G2131-OT, G2151EU, G2151-OT, G2161EU, G2161-OT, G2167-OT, G3101, G3101D, G3107, G3107D, G3117, G3117D, G3161, G3161D		
accesorios para	102078		
	código	102067	referencia —
	tuerca rosca M8x1 H 3mm latón UE 1 pzs tipo SEF 1		

código	102060	referencia	535130121 RZZ70
descripción	termopar M8x1 L 1500mm M8x1		
accesorios para	102060		
	código	102067	referencia —
	tuerca rosca M8x1 H 3mm latón UE 1 pzs tipo SEF 1		

código	102054	referencia	535480011 RZZ68
descripción	termopar M8x1 L 320mm M8x1		
Para modelos:	G2101EU, G2101-OT, G2101OTC, G2102, G2107-OT, G2131-OT, G2151EU, G2151-OT, G2161EU, G2161-OT, G2167-OT, G3101, G3101D, G3101OTC, G3106, G3121, G3124, G3161, G3161D		
accesorios para	102054		
	código	102067	referencia —
	tuerca rosca M8x1 H 3mm latón UE 1 pzs tipo SEF 1		



código	102056	referencia	535480012 RZZ67
descripción	termopar M8x1 L 600mm M8x1		
Para modelos:	G2101EU, G2101-OT, G2101OTC, G2102, G2107-OT, G2131-OT, G2151EU, G2151-OT, G2161EU, G2161-OT, G2167-OT, G3101, G3101D, G3106, G3121, G3124, G3161, G3161D		
accesorios para	102056		
	código	102067	referencia —
		tuerca rosca M8x1 H 3mm latón UE 1 pzs tipo SEF 1	

termopares roscados niquelados

código	107450	referencia	537880300 RZZ274
descripción	termopar niquelado M10x1 L 600mm M8x1		

código	107298	referencia	537220330 R9004
descripción	termopar niquelado M8x1 L 750mm M8x1		





termopares específicos del fabricante

código	107265	referencia	531880730 600537
descripción	juego de termopares 11 piezas L 1200mm clavija ø6,0mm		

código	107263	referencia	537880200 600509
descripción	juego de termopares 13 piezas L 900mm clavija ø6,0mm		

código	107264	referencia	536000031 600505
descripción	juego de termopares 13 piezas L 900mm clavija ø6,0mm		
Para modelos:	G21224B, G21524B, G21824B, G2624B, G2924B		

código	107444	referencia	537060102 610080
descripción	juego de termopares 3 piezas L 330mm clavija ø5,0mm M8x1		

repuestos para	107444		
	código	101260	referencia —
		unión roscada para termopar rosca M8x1 UE 1 pzs	
	código	102202	referencia —
		termopar M8x1 L 320mm clavija ø5,0mm	
	código	107290	referencia 537060460 610038
		unión roscada para termopar rosca M12x1 H M8x1 L 45mm ø 10mm UE 1 pzs	
	código	107291	referencia 537060470 R3160
		casquillo de fijación para termopar L 24mm int.ø 4.2mm ø 6.5mm UE 1 pzs	

código	107427	referencia	531300140 RX20
descripción	juego de termopares 6 piezas L 900mm clavija ø6,0mm		
Para modelos:	G1830		



termogeneradores

código	102116	referencia	537350005 R3825
descripción	termogenerador ROBERTSHAW L 900mm sonda \varnothing 9mm sonda L 57mm 250-750mV unión roscada 7/16"		
Para modelos:	G3203, G3206, G3830, G3860, G3865		

código	107279	referencia	531313470 535750044 600633 RA39
descripción	interruptor rosca 11/32" G2: M9x0,75 L 33mm		
Para modelos:	G1830, G1860-CE, G2203, G2206		

alargadores

código	107258	referencia	535400120 R3179
descripción	alargador para termopar rosca M10x1 - M8x1 L 1500mm		
Para modelos:	G2101EU, G2101-OT, G2107EU, G2107-OT, G2107-SB, G2131-OT, G2151EU, G2151-OT, G2161EU, G2161-OT, G2167-OT, G3101, G3101D, G3107, G3107D, G3117, G3117D, G3161, G3161D		

otros

código	107315	referencia	539113294 635112
descripción	cable interruptor circuito L 600mm empalme Faston 6,3mm		
Para modelos:	G350-11, G350-12		

accesorios

interruptores

código	107465	referencia	531700070 600507	
descripción	interruptor			
repuestos para	107465			
	código	107279	referencia	531313470 535750044 600633 RA39
	interruptor rosca 11/32" G2: M9x0,75 L 33mm			

código	107291	referencia	537060470 R3160
descripción	casquillo de fijación para termopar L 24mm int. \varnothing 4.2mm \varnothing 6.5mm UE 1 pzs		

código	107290	referencia	537060460 610038
descripción	unión roscada para termopar rosca M12x1 H M8x1 L 45mm \varnothing 10mm UE 1 pzs		

puentes de encendido

código	109143	referencia	531610150 RZZ146
descripción	puente de encendido L 204mm		
Para modelos:	G2512		

quemadores de gas

quemadores de cocina

quemadores de cocina universales

GEV



1

código	104102	referencia	530960030
descripción	cabezal de quemador para ø de tapa de quemador 100mm ø ext. 130		

quemadores de cocina específicos del fabricante

FALCON

quemadores de cocina

serie G10



1

código	104652	referencia	537060060 537060120 610072
descripción	parte inferior de quemador para ø de tapa de quemador 114mm longitud total 245mm H 102mm		



1

código	104653	referencia	537060040 537060070 810657
descripción	quemador ø 114mm longitud total 245mm H 112mm		



1

código	104645	referencia	537060080 R3148
descripción	tapa de quemador ø 114mm 7.5kW H 14mm soporte ø 103.5mm		



1

código	107426	referencia	537060160 R3216
descripción	tubo de mezcla de aire L 77mm latón int.ø 13mm ø ext. 18mm		

serie G11, G21, G31



1

código	104639	referencia	535290001 R6320	
descripción	cabezal de quemador ø 137mm para ø de tapa de quemador 105mm H 11mm soporte ø 88mm			
Para modelos:	G3101, G3101D, G3101OTC, G3106, G3121, G3124, G3161, G3161D			
accesorios para	104639			
	código	104640	referencia	535290000 R6322
tapa de quemador ø 105mm soporte ø 86mm				



1

código	104641	referencia	535400060 R5896
descripción	cabezal de quemador ø 137mm para ø de tapa de quemador 118mm H 11mm soporte ø 88mm		
Para modelos:	G2101EU, G2101-OT, G2101OTC, G2102, G2107-OT, G2131-OT, G2151EU, G2161EU, G2161-OT, G2167-OT		



1

código	104643	referencia	537101560 RZZ64/3
descripción	cabezal de quemador ø 137mm para ø de tapa de quemador 118mm H 11mm soporte ø 88mm		
Para modelos:	G1197		



1

código	107423	referencia	537101096 800157
descripción	portaboquillas boquilla 175 L 72mm tubo ø 8mm racor tubular M12x1 M6x0,75		
Para modelos:	G1197		



 <p>1</p>			
código	104644	referencia	535130133 600147
descripción	quemador ø 137mm 4.3kW completo		
Para modelos:	G1107CE-OT		
repuestos para	104644		
	código	104642	referencia 535480006 RZZ64/8
tapa de quemador ø 118mm soporte ø 86mm			
	código	104643	referencia 537101560 RZZ64/3
cabezal de quemador ø 137mm para ø de tapa de quemador 118mm H 11mm soporte ø 88mm			

 <p>1</p>			
código	104640	referencia	535290000 R6322
descripción	tapa de quemador ø 105mm soporte ø 86mm		
Para modelos:	G3101, G3101D, G3101OTC, G3106, G3121, G3124, G3161, G3161D		
accesorios para	104640		
	código	104639	referencia 535290001 R6320
cabezal de quemador ø 137mm para ø de tapa de quemador 105mm H 11mm soporte ø 88mm			

 <p>1</p>			
código	104642	referencia	535480006 RZZ64/8
descripción	tapa de quemador ø 118mm soporte ø 86mm		
Para modelos:	G2101-OT, G2101OTC, G2102, G2107-OT, G2131-OT, G2151EU, G2161EU, G2161-OT, G2167-OT		

<p>otros</p>  <p>1</p>			
código	104646	referencia	537880420 610206
descripción	tapa de quemador ø 92mm H 14mm int.ø 50mm		

<p>parrillas de quemador</p>  <p>1</p>			
código	210045	referencia	535400130 RT604004
descripción	rejilla de quemador An 295mm L 560mm H 31mm para FALCON		
Para modelos:	G2101EU, G2101-OT, G2101OTC, G2102, G2124, G2131-OT, G2151EU, G2151-OT, G2161EU, G2161-OT		

 <p>1</p>			
código	210048	referencia	534100020 RT405010
descripción	rejilla de quemador An 295mm L 560mm H 37mm pos. de montaje centro		
Para modelos:	G1107CE-OT, G1197		

 <p>1</p>			
código	210047	referencia	534100010 RT405009
descripción	rejilla de quemador An 295mm L 560mm H 37mm pos. de montaje izquierdo/derecho		
Para modelos:	G1107CE-OT, G1167, G1197		

<p>accesorios</p> <p>parrillas de quemador</p>  <p>1</p>			
código	210045	referencia	535400130 RT604004
descripción	rejilla de quemador An 295mm L 560mm H 31mm para FALCON		
Para modelos:	G2101EU, G2101-OT, G2101OTC, G2102, G2124, G2131-OT, G2151EU, G2151-OT, G2161EU, G2161-OT		



1

código	210048	referencia	534100020 RT405010
descripción	rejilla de quemador An 295mm L 560mm H 37mm pos. de montaje centro		
Para modelos:	G1107CE-OT, G1197		



1

código	210047	referencia	534100010 RT405009
descripción	rejilla de quemador An 295mm L 560mm H 37mm pos. de montaje izquierdo/derecho		
Para modelos:	G1107CE-OT, G1167, G1197		

quemadores tubulares

quemadores tubulares



1

código	109142	referencia	531750420 701313
descripción	quemador tubular 1 fila L 370mm An 30mm ømm H 40mm anchura brida 40mm longitud brida 50mm sartén basculante		
Para modelos:	G1962, G1965, G1994, G1995, G2962, G2965, G2994, G2995		



1

código	109141	referencia	531600230 R3101
descripción	quemador tubular 1 fila L 460mm An 35mm ømm H 220mm grill		
Para modelos:	G2512, G2522, G2532, G3512		



1

código	109151	referencia	537880120 703166
descripción	quemador tubular 2 filas L 375mm An 230mm ømm H 40mm cocina de gas		



1

código	109149	referencia	536000034 609901
descripción	quemador tubular 2 filas L 390mm An 200mm ømm H 43mm grill hierro fundido		
Para modelos:	G21224B, G21524B, G21824B, G2624B, G2924B		



1

código	109154	referencia	539220590 635657
descripción	quemador tubular 2 filas L 390mm An 255mm ømm H 40mm grill hierro fundido		
Para modelos:	G350-10, G350-9		

quemadores para placas radiantes



1

código	109152	referencia	537880700 610077
descripción	quemador para placas radiantes ø 150mm H 70mm		



1

código	109153	referencia	537060350 R3169
descripción	quemador para placas radiantes ø 200mm H 70mm		



sopletes

1			
código	104314	referencia	530560000
descripción	junta L 108mm An 103mm H 3mm 6 orificios		

accesorios

juntas

1			
código	109180	referencia	535770039 802246
descripción	juego de juntas para quemador		
Para modelos:	G2840, G2841, G2842		

1			
código	109165	referencia	536060011 R5435
descripción	junta L 84mm An 65mm espesor 1.6mm corcho apto para FALCON		
Para modelos:	G2840, G2841, G2842, G2845F		

portaboquillas

1			
código	107443	referencia	537101097 810296
descripción	portaboquillas boquilla 107 L 72mm racor tubular M12x1 con venturi tubo ø 8mm		
Para modelos:	G1197		

1			
código	107284	referencia	535400080 R5004
descripción	portaboquillas boquilla 195 rosca M22x1 L 43mm racor tubular M12x1 M6x0,75		
Para modelos:	G2101-OT, G2101OTC, G2107-OT, G2161-OT, G2167-OT		

1			
código	107437	referencia	531880480 RH33/57
descripción	portaboquillas rosca 1/8" L 24.4mm EC 16		

otros

1			
código	109148	referencia	537101570 T602045
descripción	chapa de montaje para quemador L 560mm aluminio An 73mm H 40mm		
Para modelos:	G1107CE-OT, G1197		

1			
código	109168	referencia	534101090 P600012
descripción	chapa de montaje para quemador L 560mm An 202mm H 12mm pos. de montaje centro		
Para modelos:	G1107CE-OT, G1197		

1			
código	109167	referencia	534101080 P600011
descripción	chapa de montaje para quemador L 560mm An 252mm H 18mm pos. de montaje derecho		
Para modelos:	G1107CE-OT, G1197		

1			
código	109166	referencia	534101070 P600010
descripción	chapa de montaje para quemador L 567mm An 250mm H 24mm pos. de montaje izquierdo		
Para modelos:	G1107CE-OT, G1197		



			
1			
código	109161	referencia	537882055 R3193
descripción	inyector L 51mm D1 ø 14.5mm D2 ø 25mm con boquilla soporte de boquilla 1/8" boquilla ø 1.4mm EC 14		

			
1			
código	109150	referencia	531600240 RT615002
descripción	soporte para placa cerámica L 180mm An 90mm		
Para modelos:	G2512		

			
1			
código	107283	referencia	535400100 R5897
descripción	tuerca para portaboquillas ø 60mm rosca M22x1 EC 54		
Para modelos:	G2101-OT, G2101OTC, G2102, G2107-OT, G2131-OT, G2151EU, G2151-OT, G2161EU, G2161-OT, G2167-OT		

			
1			
código	109164	referencia	537101533 R8208
descripción	tuerca para venturi latón H 6mm EC 27		
Para modelos:	G1107CE-OT		

boquillas de gas

inyectores principales

boquillas de gas 1/8"

			
1			
código	107435	referencia	535670021 638042
descripción	boquilla de gas rosca 1/8" EC 10 taladro ø 1.57mm código 1.57 UE 2 pzs		
Para modelos:	G3203, G3830, G3865		

			
1			
código	107311	referencia	535680011 638044
descripción	boquilla de gas rosca 1/8" EC 10 taladro ø 2.15mm código 215 UE 2 pzs		
Para modelos:	G3206, G3860		

			
1			
código	107439	referencia	535670020 638041
descripción	boquilla de gas rosca 1/8" EC 10 taladro ø 2.38mm código 2.38 UE 2 pzs		
Para modelos:	G3203, G3830, G3865		

			
1			
código	107440	referencia	535680010 638043
descripción	boquilla de gas rosca 1/8" EC 10 taladro ø 3.2mm código 32 UE 2 pzs		
Para modelos:	G3206, G3860		

boquillas de gas 1/4"

			
1			
código	109171	referencia	539220680 RZZ100
descripción	boquilla de gas rosca 1/4" H código 2.9 EC 15 taladro ø 2.9mm L 38mm gas natural		
Para modelos:	G350-10, G350-9		

			
1			
código	109170	referencia	535100890 RZZ110
descripción	boquilla de gas rosca 1/4" H código 225 EC 15 taladro ø 2.25mm L 38mm gas natural		
Para modelos:	G3925ES		

			
1			
código	109144	referencia	535480036 R5055
descripción	boquilla de gas rosca 1/4" H código 23 EC 15 taladro ø 2.3mm L 38mm gas natural		
Para modelos:	G2101-OT, G2107EU, G2107-OT, G2107-SB, G2151EU, G2151-OT, G3101, G3101D, G3107, G3107D, G3117, G3117D		

			
1			
código	109146	referencia	530961130 RZZ113
descripción	boquilla de gas rosca 1/4" H código 26 EC 15 taladro ø 2.6mm L 38mm gas natural		
Para modelos:	G2625, G31225, G3625		





			
1			
código	109147	referencia	535410007 610620
descripción	boquilla de gas rosca 1/4" H código 360 EC 15 taladro ø 1.7mm gas licuado		
Para modelos:	G2107EU, G2107-SB, G3107, G3107D, G3127		

boquillas de gas M6x0,75			
			
1			
código	107310	referencia	537101140 RZZ132
descripción	boquilla de gas rosca M6x0,75 EC 7 taladro ø 1.07mm		
Para modelos:	G1107CE-OT, G1197		

			
1			
código	107287	referencia	535480007 RZZ134
descripción	boquilla de gas rosca M6x0,75 EC 7 taladro ø 1.75mm		
Para modelos:	G2101-OT, G2101OTC, G2107-OT, G2161-OT, G2167-OT		

			
1			
código	107288	referencia	535480009 RZZ135
descripción	boquilla de gas rosca M6x0,75 EC 7 taladro ø 1.95mm		
Para modelos:	G2101EU, G2101-OT, G2101OTC, G2102, G2131-OT, G2151EU, G2151-OT, G2161EU, G2161-OT		

boquillas de gas M7x1			
			
1			
código	107434	referencia	531400040 RL34
descripción	boquilla de gas rosca M7x1 EC 10 taladro ø 1.7mm		
Para modelos:	G1167		

boquillas de gas M 10x1			
			
1			
código	100654	referencia	536300027 RV92
descripción	boquilla de gas rosca M10x1 EC 11 taladro ø 1.7mm interior plano		
Para modelos:	G3840, G401, G401F, G402, G402F		

			
1			
código	107457	referencia	536300026 RV96
descripción	boquilla de gas rosca M10x1 EC 11 taladro ø 2.7mm interior punta-gudo código 270		
Para modelos:	G3840, G401, G401F, G402, G402F		

otras boquillas de gas			
			
1			
código	109145	referencia	531552254 700608
descripción	boquilla de gas rosca 1/2" UNEF código 20 taladro ø 0.4mm gas natural EC 6/17 L 42mm		

			
1			
código	109163	referencia	531550070 700602
descripción	boquilla de gas rosca 1/2" UNEF código 380 taladro ø 1.7mm gas natural EC 6/17 L 42mm		

			
1			
código	109162	referencia	530840020 RR5/1
descripción	boquilla de gas rosca 1/2" UNEF código taladro ø 3.2mm gas natural EC 15 L 30mm		
Para modelos:	G3478, G5478, G6478		

			
1			
código	107458	referencia	531790210 RH33/5
descripción	boquilla de gas rosca n.º 12 UNF código 140 taladro ø 1.05mm gas licuado EC 6 L 12mm		
Para modelos:	G1994, G1995, G2994, G2995		



			
1			
código	107436	referencia	531790100 RF53/9
descripción	boquilla de gas rosca n.º 12 UNF código 20 taladro ø 0.4mm gas licuado EC 6 L 12mm		
Para modelos:	G1994, G1995, G2994, G2995		

			
1			
código	107312	referencia	535930140 RH33/58
descripción	boquilla de gas rosca n.º 12 UNF código 210 taladro ø 1.3mm gas licuado EC 6 L 12mm		

			
1			
código	107433	referencia	531790180 RGG14
descripción	boquilla de gas rosca n.º 12 UNF código 400 taladro ø 1.74mm gas natural EC 6 L 12mm		
Para modelos:	G1994, G1995, G2994, G2995, G3425		

boquillas piloto

boquillas piloto ROBERTSHAW

			
1			
código	106107	referencia	537960023 RKK18/3
descripción	boquilla de quemador piloto gas licuado código 11 apto para ROBERTSHAW		

			
1			
código	106105	referencia	531300070 RM5/6
descripción	boquilla de quemador piloto gas licuado código 16 apto para ROBERTSHAW		
Para modelos:	G1830, G3203, G3206, G3830, G3860, G3865		

			
1			
código	100276	referencia	535710050 RKK18/4
descripción	boquilla de quemador piloto gas natural código 18 apto para ROBERTSHAW		

			
1			
código	106108	referencia	531720020 R3693
descripción	boquilla de quemador piloto gas natural código 22 apto para ROBERTSHAW		

			
1			
código	100277	referencia	535710091 RM5/7
descripción	boquilla de quemador piloto gas natural código 26 apto para ROBERTSHAW		
Para modelos:	G3203, G3206, G3830, G3860, G3865		

boquillas piloto SIT

serie 140/150

			
1			
código	100205	referencia	535410015 RH39
descripción	boquilla de quemador piloto SIT gas licuado código 19 taladro ø 0.23/0.26mm UE 1 pzs apto para SIT serie 150		
Para modelos:	G2107EU, G2107-SB, G3107, G3107D, G3127		

			
1			
código	107286	referencia	531600070 R3106
descripción	boquilla de quemador piloto SIT gas natural código 30 taladro ø 0,60/0,40mm UE 1 pzs		
Para modelos:	G2512, G2522, G2532, G3512, G3532, G401, G401F, G402, G402F		

			
1			
código	100206	referencia	530961100 RH36/4
descripción	boquilla de quemador piloto SIT gas natural código 36 taladro ø 0,60/0,55mm UE 1 pzs apto para SIT serie 150		
Para modelos:	G3107, G3107D, G3127		



juegos de boquillas de gas

código	107309	referencia	537350017 801804
descripción	juego de boquillas de gas gas licuado G2865 para FALCON		
repuestos para	107309		
	código	106105	referencia 531300070 RM5/6
boquilla de quemador piloto gas licuado código 16 apto para ROBERTSHAW			
	código	109128	referencia —
regulador de presión latón L 25mm ø 11.5mm rosca M13x1 para válvula de gaz apto para válvulas de gas UE 1 pzs			

código	250078	referencia	535820026 RZZ335
descripción	regulador de presión de gas RV48LM empalme 1/2" países UK presión entrada máx. 0.1bar presión de salida 12,5-30mbar		
Para modelos:	G21223, G21523, G21823, G2623, G2641, G2642, G2642B, G2923, G2941, G2942, G3441, G3441R, G3641, G3830, G3941		

materiales auxiliares de gas

accesorios

código	109169	referencia	535102325 R5837
descripción	encendedor de gas L 275mm recargable		

código	107446	referencia	536060001 802023
descripción	kit de modificación gas licuado en gas natural para FALCON para Burnertech		

reguladores de presión de gas

Presión estándar dependiendo del país:
 Alemania 50mbar
 España 37/50mbar
 Francia 37mbar
 Italia 30mbar
 Reino Unido 20mbar

código	250079	referencia	537560015 800386
descripción	kit de modificación en gas natural G1532 para FALCON		
repuestos para	250079		
	código	107286	referencia 531600070 R3106
boquilla de quemador piloto SIT gas natural código 30 taladro ø 0,60/0,40mm UE 1 pzs			
	código	250099	referencia —
regulador de presión de gas RV48LM empalme 1/2" - 1/2" países UK presión entrada máx. 0.1bar			

tuberías de gas

tuberías de gas principales

universal

código	107447	referencia	535770080 609943
descripción	línea de gas empalme 3/8" H - 3/8" M L 108mm ø ext. 16mm inox flexible DN11		
Para modelos:	G2840, G2841, G2842		

código	107296	referencia	535410011 660019
descripción	línea de gas empalme ø6mm L 450mm ø ext. 8mm inox flexible grosor de la pared 0.5mm longitud de empalme 25mm		
Para modelos:	G2107EU, G2107-SB		

código	107276	referencia	537101530 660014
descripción	línea de gas empalme ø8mm L 385mm ø ext. 10mm inox flexible grosor de la pared 0.5mm longitud de empalme 25mm		
Para modelos:	G1107CE-OT, G1197		

código	107277	referencia	537101540 660013
descripción	línea de gas empalme ø8mm L 650mm ø ext. 10mm inox flexible grosor de la pared 0.5mm longitud de empalme 25mm		
Para modelos:	G1197		

presostatos



1			
código	541073	referencia	530550019
descripción	presostato ø 45mm margen de presión ajustable 5-20mbar conexión de presión vertical sistemas de gas empalme 1/4" empalme presión ø 1/4"mm		

para planchas grill

cajas y paneles frontales



1			
código	694576	referencia	535101016 T613097
descripción	cubierta para grill L 495mm An 43mm H 25mm		

componentes específicos

para máquinas de espresso

unidades de infusión

juntas pra portafltro

juntas tóricas



1			
código	510409	referencia	730590010
descripción	junta tórica EPDM espesor 5.34mm int.ø 56.52mm UE 1 pzs		

para cocinas de placa radiante

placas de fundición



1			
código	694567	referencia	531880300 610012
descripción	placa de fundición ø 324mm H 9mm para placa radiante redondo		

para hornos a convección/combinados

unidades de salida

bandejas recogegotas



1			
código	691961	referencia	530550145
descripción	unidad de desagüe L 90mm edición desde 2009		



1			
código	692909	referencia	730782432
descripción	cojinete para bisagra de puerta batiente H 7mm plástico D1 ø 18mm D2 ø 12mm int.ø 10mm		

tubos de inyección



1			
código	692839	referencia	530743267
descripción	tubo de inyección para horno a vapor combinado forma U ø ext. 12mm int.ø 10mm L 265mm		

			
1			
código	692838	referencia	530753793
descripción	tubo de inyección para horno a vapor combinado recto ø ext. 12mm int.ø 8mm L 180mm -		

sistema de limpieza
casquillos de acoplamiento

			
1			
código	501591	referencia	530753890
descripción	empalme de tubos acero inoxidable tubo ø 10/13mm M9 para sistema de limpieza horno a vapor combinado		

limpieza del brazos

			
1			
código	542416	referencia	530775177
descripción	pletina sujeción ø 55mm cubo con junta para brazo de lavado para ELOMA horno a vapor combinado		

tubos flexibles

			
1			
código	694953	referencia	530550164
descripción	tubo flexible int.ø 13mm ø ext. 23mm L 1mm EPDM azul/blanco T máx 120°C para horno a vapor combinado		

tubos flexibles

			
1			
código	520534	referencia	530550162
descripción	tubo flexible int.ø 50mm ø ext. 58mm L 50mm silicona UE 1 para horno a vapor combinado espesor 4mm		

kits de servicio

			
1			
código	530902	referencia	530550068
descripción	brida Kit para brazos de lavado apto para horno a vapor combinado LAINOX		

bandejas de agua de goteo

			
1			
código	699854	referencia	530550147
descripción	bandeja de goteo L 520mm An 35mm H 70mm		

			
1			
código	699242	referencia	530550148
descripción	bandeja de goteo L 576mm An 32mm H 51mm		

			
1			
código	699269	referencia	530781177
descripción	tapón H 10mm ø 20mm		

macánica de puertas

<p>otros</p>  <p>imagen no disponible</p>			
1			
código	692909	referencia	730782432
descripción	cojinete para bisagra de puerta batiente H 7mm plástico D1 ø 18mm D2 ø 12mm int.ø 10mm		

topes de puerta



1

código	694922	referencia	530886726
descripción	tope de goma ø 11.5mm H 19mm goma		

mecánica de cierre



1

código	692714	referencia	530791652
descripción	arandela para cierre ø 44mm agujero ø 6x8mm		



1

código	692715	referencia	530888575
descripción	casquillo ø 50mm L 72mm An 59mm H 31mm dist. del agujero 60mm int.ø 37mm		





1

código	692716	referencia	530588504
descripción	cierre de puerta con interruptor L 140mm An 25mm H 63mm dist. del agujero 120mm int.ø 12mm		

bombas de vibración



1

código	500568	referencia	530550032
descripción	bomba magnética 230V 32W 50Hz entrada ø 7 salida ø 1/8" F CEME tipo E512/A32		
repuestos para	500568		
	código	390698	referencia —
	fusible térmico temp. desconexión 110°C apto para bomba Ulka		
	código	520153	referencia —
	soporte goma medidas 53x34x28mm		



1

código	499010	referencia	530772550
descripción	bomba magnética tipo E512/B46 230V 60W 50/60Hz entrada ø 7 salida ø 1/8" F CEME L 125mm		



1

código	501567	referencia	530550178
descripción	bomba magnética tipo HF 230V 22W 50Hz entrada ø 6 salida ø 6 ULKA plástico L 97mm empalme conector Faston 4,8mm		

intercambiadores de calor



1

código	520509	referencia	530550092
descripción	disco de reducción quemador de gas latón int.ø 3mm ø ext. 16mm espesor 2.2mm código 3		

otros



1

código	692300	referencia	530550161
descripción	bloqueador con racor para vidrio D1 ø 15mm L 8mm rosca M4		



1

código	696857	referencia	530566594
descripción	manguito L 42mm D1 ø 12mm D2 ø 36mm		



1

código	692363	referencia	531920640 P461407
descripción	tope para puerta L 31mm An 65mm H 16mm		
Para modelos:	E7204, E7208, E7211, G7204, G7208, G7211		



para sartén basculante

otros



1

código	701195	referencia	531750210 R447317
descripción	charnela de tapa L 248mm pos. de montaje izquierdo aluminio para sartén basculante		
Para modelos:	E1962, E1965, E1994, E1995, E2962, E2965, E2994, E2995, G1962, G1965, G1994, G1995, G2962, G2965, G2994, G2995		

para hornos

otros



1

código	696508	referencia	531880950 T392060
descripción	chimenea para horno L 230mm An 27mm H 50mm		
Para modelos:	G1036L, G1036S		

pomos

pomos personalizados para fabricantes

FALCON



1

código	112574	referencia	539110410
descripción	pomo interruptor 7 posiciones T máx°C°C ø 56mm eje ø 6x4,6mm parte plana arriba		
Para modelos:	E350-30, E350-33		



1

código	112573	referencia	539110380
descripción	pomo termostato T máx 250°C 100-250°C ø 56mm eje ø 6x4,6mm parte plana arriba		
Para modelos:	E350-30		



1

código	112863	referencia	731600009
descripción	pomo 0-3 ø 65mm eje ø 6x4,6mm parte plana arriba negro		
Para modelos:	E3512		



1

código	112572	referencia	731320030 731750780
descripción	pomo regulador de energía ON/1-4/FULL T máx°C°C ø 65mm eje ø 5x3,5mm parte plana arriba		
Para modelos:	E1962, E1965, E1994, E1995		



1

código	112701	referencia	537350037 R5851
descripción	pomo termostato T máx 190°C 140-190°C ø 66mm eje ø 5x7mm parte plana arriba negro		



1

código	112575	referencia	531750460
descripción	roseta ø 67mm		
Para modelos:	E1962, E1965, E1994, E1995, G1962, G1965, G1994, G1995		



accesorios

cubiertas



1

código	111510	referencia	530748781
descripción	tapa T máx°C°C ø 37mm eje ømm parte plana plata para pomo ELOMA		
accesorios para	111510		
	código	111498	referencia 530743690
	pomo T máx°C°C ø 48mm eje ø 6.5mm parte plana azul		

adaptador de pomo



1

código	107432	referencia	530840051 705003
descripción	adaptador de pomo eje ø 6x8 en 5x7mm para grifo de gas parte plana universal		
Para modelos:	G5478, G6478		

manillas y volantes

volantes

volantes



1

código	691973	referencia	531750510 701203 731750510
descripción	volante ø 150mm D1 ø 32mm taladro ø 17mm rosca ancho de ranuramm L1 20mm L2 60mm longitud de asidero 65mm con asidero abatible		
Para modelos:	E1962, E1994, E2962, E2994, G1962, G1994, G2962, G2994		

recambios y accesorios



1

código	514178	referencia	531750511 RG11/6
descripción	mango abatible ø 28mm longitud total 85mm soporte ø 20mm árbol ømm rosca M6 con pasador L 85mm		
Para modelos:	E2962, E2994, G1962, G1994, G2962, G2994		

asas de arco



1

código	701245	referencia	539220150 635214
descripción	asa de arco L 138mm H 53mm distancia de sujeción 116mm rosca M8x1,25 An 30mm negro		
Para modelos:	G350-1-CE, G350-2-CE		



1

código	701243	referencia	735270027 R4946
descripción	asa de arco L 145mm H 56/71mm distancia de sujeción 119mm rosca M5 An 30mm negro		



1

código	701187	referencia	535710003 R5016
descripción	asa de arco L 145mm H 56/73mm distancia de sujeción 118mm rosca M5 An 30mm negro		



1

código	701185	referencia	530783050 610005
descripción	asa de arco L 204mm H 58/74mm distancia de sujeción 177mm rosca M8x1,25 An 30mm Austauschset negro		
Para modelos:	E3078-10, E3078-20, E3078-30, E3080-10, E3080-20, G3080-45L, G3080-90L		
repuestos para	701185		
	código	701186	referencia 535480055 600168
	asa de arco L 204mm H 58/74mm distancia de sujeción 177mm rosca M8x1,25 An 30mm negro		



1

código	701186	referencia	535480055 600168
descripción	asa de arco L 204mm H 58/74mm distancia de sujeción 177mm rosca M8x1,25 An 30mm negro		
Para modelos:	E2101, E2101EU, E2101EU-OTC, E2102, E2112, E2117, E2161, E2161EU, G2101EU, G2101-OT, G2101OTC, G2102, G2107EU, G2107-OT, G2107-SB, G2112, G2131-OT, G2151EU, G2151-OT, G2161EU, G2161-OT, G2167-OT		

empuñaduras



1

código	701188	referencia	539211871 635003
descripción	empuñadura An 120mm H 80mm distancia de sujeción 103mm medida de montaje 69x112mm plástico		

cierres

cierres de palanca

específico del fabricante

FALCON



1

código	691990	referencia	530748765 EL748765
descripción	manilla de puerta tope a la derecha L 155mm An 60mm H 58mm longitud muelle 53mm azul distancia de sujeción 40mm rosca de sujeción M4		
repuestos para	691990		
	código	referencia	514450 530791504
	resorte para tirador de puerta ø 6mm L 61mm An 27.5mm		
accesorios para	691990		
	código	referencia	111510 530748781
	tapa T máx°C°C ø 37mm eje ømm parte plana plata para pomo ELOMA		



1

código	694067	referencia	530747998
descripción	retén con espiga 1 nivel L 26mm longitud total 51mm rosca M8		



cierres angulares

cierres de palanca

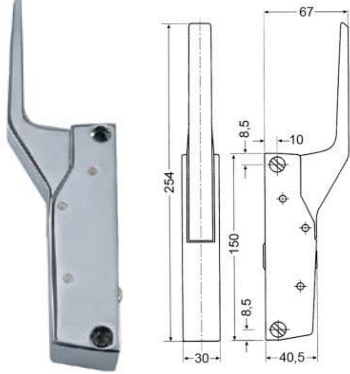
CAFF/FERMOD



1

código	700060	referencia	530377732
descripción	cierre de palanca L 150mm distancia de sujeción 133mm sin cierre aparatos térmicos G 791		
accesorios para	700060		
	código	referencia	700061 —
	retén L 58mm An 20mm H 35mm distancia de sujeción 42mm latón cromado para aparatos calientes		
	código	referencia	700062 530292532
	protección para mango aparatos térmicos		

CHG

serie R35

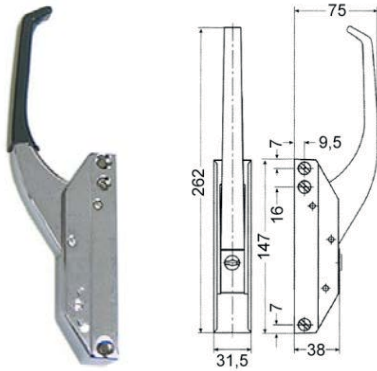

1

código	690178	referencia	734350140 R2648
descripción	cierre de estribo L 147mm distancia de sujeción 117/133mm sin cierre aparatos térmicos R35 H 38mm An 31mm completo con retén longitud total 263mm altura total 72mm		
Para modelos:	E4063, E4103		

cierres de enganche

específico del fabricante

FALCON



1

código	694571	referencia	535480054 RZZ224
descripción	cierre de enganche L 63mm An 28mm distancia de sujeción 43.5mm		
Para modelos:	E2101, E2101EU, E2101EU-OTC, E2102, E2112, E2117, E2161EU, E2914i, E3101-3HP, E3101-4HP, E3101OTC-3HP, E3101OTC-4HP, E3117, E3161-3HP, E3913i, E3914i, G2101EU, G2101-OT, G2101OTC, G2102, G2107EU, G2107-OT, G2107-SB, G2112, G2131-OT, G2151EU, G2151-OT, G2161EU, G2161-OT, G2167-OT, G3101, G3101OTC, G3106, G3107, G3117, G3161		



1

código	694573	referencia	534100090 G1107
descripción	cierre de enganche L 63mm An 28mm distancia de sujeción 43.5mm		



1

código	694575	referencia	530962150 REE16/2
descripción	cierre de enganche L 64mm An 26mm distancia de sujeción 48mm		

cierres de pestillo espagnolette

específicas del fabricante

FALCON



1

código	694572	referencia	530843210 705011
descripción	manilla de puerta H 96mm L 170mm An 55mm para cierre de pestillo espagnolette		
Para modelos:	E5478, E6478, G5478, G6478		

otros



1

código	694568	referencia	534510130 600086 600200 731910670
descripción	retén L 17mm longitud total 42mm rosca M6x1 rosca L 23mm		
Para modelos:	E1808, E1838, E1848, E7002, E7202, E7202S, E720RS1, E720RS2, E720RS3, G1808-CE, G1808-Pre-CE, G1838-CE, G1848-CE, G1848-Pre-CE		

bisagras

bisagras rectangulares

CHG

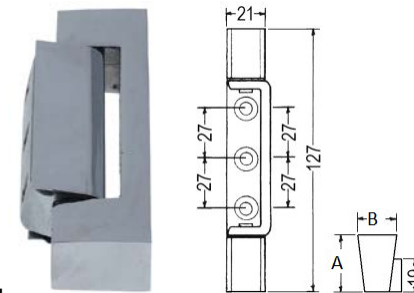

1

código	690291	referencia	530843125 RO31
descripción	bisagra rectangular L 127mm distancia de sujeción 27/27mm tope izquierdo/derecho sin rampa L1 30mm L2 28mm resis.a la temp. 240°C serie R42		
Para modelos:	E6478, G5478, G6478		

soporte de puerta



1

código	701246	referencia	531740050 800005
descripción	bisagra L 46mm An 28mm H 94mm pos. de montaje abajo derecha con casquillo para horno de convección		
Para modelos:	G1112		



1

código	701247	referencia	531740060 800004
descripción	bisagra L 46mm An 28mm H 94mm pos. de montaje abajo izquierda con casquillo para horno de convección		



código	701248	referencia	531740030 800008
descripción	bisagra L 47mm An 80mm H 52mm pos. de montaje arriba derecha con casquillo para horno de convección UE 1 pzs		
Para modelos:	G1112		



código	701192	referencia	530962190 T403706
descripción	bisagra de puerta L 47mm An 30mm H 19mm pos. de montaje izquierdo arriba UE 1 pzs		



código	701198	referencia	536430108 801936
descripción	bisagra de puerta L 26mm An 15mm H 24mm pos. de montaje arriba perno 20mm perno ø 10mm		
Para modelos:	E401, E401F, E402, E402F, E421, E421F, E422, E422F, G2844F, G2845F, G401, G401F, G402, G402F		



código	701212	referencia	535400225 600182
descripción	bisagra de puerta L 53mm An 30mm H 23mm Kit		



código	701210	referencia	731910110 802455
descripción	bisagra de puerta L 35mm An 38mm H 23mm pos. de montaje abajo perno 17mm perno ø 6.5mm Austauschset		
Para modelos:	E7002		



código	701191	referencia	535480058 T603371
descripción	bisagra de puerta L 54mm An 30mm H 24mm pos. de montaje izquierdo arriba UE 1 pzs		
Para modelos:	E2101, E2117, G2101-OT, G2101OTC, G2107-OT, G2107-SB, G2151-OT		



código	701211	referencia	731910100 802454
descripción	bisagra de puerta L 35mm An 38mm H 23mm pos. de montaje arriba perno 17mm perno ø 6.5mm Austauschset		
Para modelos:	E7002		



código	701209	referencia	534101014 T603373
descripción	bisagra de puerta L 55mm An 30mm H 24mm pos. de montaje abajo izquierda		
Para modelos:	G1107CE-OT, G1197		





código	701244	referencia	531740040 800003
descripción	bisagra de puerta L 46mm An 80mm H 24mm pos. de montaje arriba izquierda con casquillo para horno de convección UE 1 pzs		
Para modelos:	G1112		





código	701190	referencia	535200006 T603531
descripción	bisagra de puerta L 58mm An 60mm H 23mm pos. de montaje izquierdo arriba UE 1 pzs		
Para modelos:	E2101EU, E2101EU-OTC, E2914i, E3101-3HP, E3101-4HP, E3101OTC-3HP, E3101OTC-4HP, E3117, E3161-3HP, E3203, E3830, E3860, E3862, E3913i, E3914i, G2101EU, G2107EU, G2151EU, G3101, G3101OTC, G3106, G3107, G3117, G3161, G3203, G3206, G3830, G3860, G3865		

 <p>1</p>			
código	701194	referencia	53520007 T603533
descripción	bisagra de puerta L 59mm An 60mm H 23mm pos. de montaje izquierdo abajo		
Para modelos:	E2101EU, E2101EU-OTC, E3101-3HP, E3101-4HP, E3101OTC-3HP, E3101OTC-4HP, E3117, E3161-3HP, E3203, E3830, E3860, E3862, G2101EU, G2107EU, G2151EU, G3101, G3101OTC, G3106, G3107, G3117, G3161, G3203, G3206, G3830, G3860, G3865		

 <p>1</p>			
código	691978	referencia	539210800
descripción	bisagra de puerta pos. de montaje abajo derecha con perno		
Para modelos:	E350-30, G350-1-CE, G350-2-CE		

 <p>1</p>			
código	691976	referencia	539210790 739210790
descripción	bisagra de puerta pos. de montaje abajo izquierda con perno		
Para modelos:	E350-30, G350-1-CE, G350-2-CE		

 <p>1</p>			
código	691977	referencia	539210780
descripción	bisagra de puerta pos. de montaje arriba derecha con perno		
Para modelos:	E350-30, G350-1-CE, G350-2-CE		

 <p>1</p>			
código	691975	referencia	539210770
descripción	bisagra de puerta pos. de montaje arriba izquierda con perno		
Para modelos:	E350-30, G350-1-CE, G350-2-CE		

 <p>1</p>			
código	701193	referencia	536430109 802212
descripción	perno L 21mm pos. de montaje abajo rosca M5 ø 10mm para bisagra de puerta batiente UE 1 pzs		
Para modelos:	E401, E401F, E402, E402F, E421, E421F, E422, E422F, G2844F, G2845F, G401, G401F, G402, G402F		

 <p>1</p>			
código	691285	referencia	530550083
descripción	perno de bisagra		

accesorios

casquillos

 <p>imagen no disponible</p> <p>1</p>			
código	692909	referencia	730782432
descripción	cojinete para bisagra de puerta batiente H 7mm plástico D1 ø 18mm D2 ø 12mm int.ø 10mm		

otros

 <p>1</p>			
código	694994	referencia	530875023
descripción	disco de detención para bisagra int.ø 12mm ø ext. 30mm plástico		



grifería para cocinas industriales

grifos de caño

específico del fabricante

FALCON



1

código	541891	referencia	531313040 RM31/4
descripción	válvula de manguito empalme 3/4" H - 3/4" H longitud 49mm latón		
Para modelos:	G1860		

bisagras de tapa

otros

piezas de repuesto



1

código	701195	referencia	531750210 R447317
descripción	charnela de tapa L 248mm pos. de montaje izquierdo aluminio para sartén basculante		
Para modelos:	E1962, E1965, E1994, E1995, E2962, E2965, E2994, E2995, G1962, G1965, G1994, G1995, G2962, G2965, G2994, G2995		



1

código	701197	referencia	531750240 T448308
descripción	perno de bisagra para tapa ø 16mm L 96mm		
Para modelos:	E1962, E1965, E1994, E1995, E2962, E2965, E2994, E2995, G1962, G1965, G1994, G1995, G2962, G2965, G2994, G2995		



1

código	701196	referencia	531750180 RT447315
descripción	soporte de bisagra para tapa aluminio ø 16mm L 61mm		
Para modelos:	E1962, E1965, E1994, E1995, E2962, E2965, E2994, E2995, G1962, G1965, G1994, G1995, G2962, G2965, G2994, G2995		

grifos de vaciado

latón

grifos de vaciado



1

código	541887	referencia	530730024 530783010 RLF044
descripción	grifo de vaciado 1¼"-1½" A 52mm B 101mm		
Para modelos:	E3078-10, E3078-20, E3078-30, E3080-10, E3080-20, G2078-135L, G2078-45L, G2078-90L, G2078TC-135L, G3080-45L, G3080-90L		

pies para aparatos y tapas terminales

pies para aparatos

con placa de sujeción



1

código	701199	referencia	535480067 R6285
descripción	pie de aparato tubo ø 64mm dimensiones de la placa 90x70mm dist. del agujero 55x70mm H 115-180mm inox medida 2 1/2" UE 1 pzs		
Para modelos:	E3800, E3862, G2101EU, G2101-OT, G2101OTC, G2107EU, G2107-OT, G2107-SB, G2112, G2124, G2131-OT, G2151EU, G2151-OT, G2161EU, G2161-OT, G2167-OT, G3800, G3830, G3860, G3865		

DERBY RUOTE

recambios y accesorios

otros



código	560193	referencia	530349771
descripción	arandela dentada int.ø 10.4mm ø ext. 18mm acero zincado DIN/ISO DIN 6798A UE 1 pzs para rosca M10		

otros

con placa de sujeción

ø100mm



código	701208	referencia	535400211 899056
descripción	juego de ruedas pivotantes con freno total ø 100mm sujeción placa 96x90mm dist. del agujero 70x70 - 70x55mm cojinete rodamiento de bolas H 175mm ancho de rueda 32mm		



código	701200 ¹	referencia	530964350 RZZ318
descripción	rueda pivotante con freno total ø 100mm sujeción placa 96x90mm dimensiones de la placa 95x90mm dist. del agujero 70x70 - 70x55mm capacidad 120kg cojinete cojinete de fricción cuerpo de rueda poli-amida superficie fricción neumáticos TPE H 175mm ancho de rueda 32mm UE 1 pzs		
Para modelos:	E3101-3HP, E3101-4HP, E3101OTC-3HP, E3101OTC-4HP, E3117, E3121-3HP, E3121-4HP, E3161-3HP, E3161D, E3800, G3101, G3101D, G3101OTC, G3106, G3107, G3107D, G3117, G3117D, G3121, G3124, G3127, G3161, G3161D, G3800		

¹con freno total

cestos

cestos para freidoras

FALCON



código	970786	referencia	539211910 R318
descripción	cesto de freidora B1 135mm L1 285mm H1 120mm acero cromado		
Para modelos:	E350-36, E350-37, G350-11, G350-12		



código	970784	referencia	535770089 R513
descripción	cesto de freidora B1 144mm L1 435mm H1 155mm acero cromado		
Para modelos:	G2840, G2841, G2842, G2844F, G2845F		



código	970787	referencia	735010400 R4546
descripción	cesto de freidora B1 190mm L1 300mm H1 100mm acero		



código	970785	referencia	535710023 R5042
descripción	cesto de freidora B1 200mm L1 290mm H1 145mm acero		

rejillas y rieles guía

rejillas



1

código	210046	referencia	535101019 RT615007
descripción	rejilla L 535mm An 100mm H 75mm hierro fundido para grill		



1

código	210049	referencia	536000018 RT615016
descripción	rejilla L 535mm An 102mm H 75mm hierro fundido para grill		
Para modelos:	G21224B, G21524B, G21824B, G2624B, G2924B		

juntas

juntas térmicas

juntas para puertas



1

código	901591	referencia	539110025 635001
descripción	junta de puerta An 350mm L 500mm para FALCON Kit		



1

código	901590	referencia	531740302 703841
descripción	junta de puerta An 500mm L 710mm para FALCON juego 4 piezas		
Para modelos:	E1112, G2102, G2112		



1

código	901593	referencia	530962183 703452
descripción	junta de puerta An 910mm L 1350mm para FALCON juego 2 piezas		



1

código	901587	referencia	535480056 703450
descripción	junta de puerta L 1370mm para FALCON trenza inox pos. de montaje derecho		
Para modelos:	G2101-OT, G2107-OT, G2107-SB, G2151-OT		



1

código	901640	referencia	531402180 703510
descripción	junta de puerta L 1430mm para FALCON trenza inox		
Para modelos:	G1167		



1

código	901589	referencia	535200005 703455
descripción	junta de puerta L 1700mm para FALCON trenza inox		
Para modelos:	E2101EU, E3101-3HP, E3101-4HP, E3117, G2101EU, G2107EU, G2151EU, G3101, G3101D, G3107, G3107D, G3117, G3117D		



1

código	901139	referencia	539110010 635004
descripción	junta de puerta L 335mm para FALCON trenza inox		
Para modelos:	E350-30, G350-1-CE, G350-2-CE		



1

código	901592	referencia	534100250 801083
descripción	junta de puerta L 920mm para FALCON pos. de montaje izquierdo		
Para modelos:	G1107CE-OT		



1

código	901140	referencia	539110020 635005
descripción	junta de puerta L 490mm para FALCON trenza inox		
Para modelos:	E350-30, G350-1-CE, G350-2-CE		



1

código	901588	referencia	535480057 703451
descripción	junta de puerta L 930mm para FALCON trenza inox pos. de montaje izquierdo		
Para modelos:	G2101-OT, G2107-OT, G2107-SB, G2151-OT		



1

código	901642	referencia	531740300 703809
descripción	junta de puerta L 500mm para FALCON trenza inox		
Para modelos:	G1112		

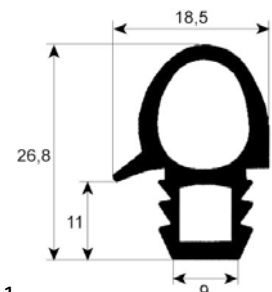

1

código	900100	referencia	530384410
descripción	junta de puerta perfil 2070 An 460mm L 645mm medidas exteriores UE 1 6 x 1/1		



1

código	901641	referencia	531740280 703808
descripción	junta de puerta L 700mm para FALCON trenza inox		
Para modelos:	G1112		

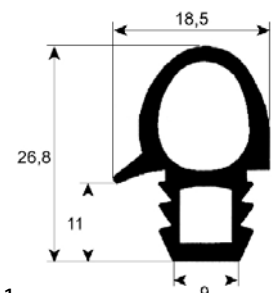

1

código	900101	referencia	530382310
descripción	junta de puerta perfil 2070 An 645mm L 700mm medidas exteriores UE 1 10 x 1/1		

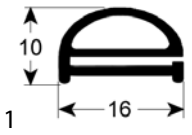

código	901583 ¹	referencia	531930525 600605
descripción	junta de puerta perfil 2229 An 495mm L 635mm medidas exteriores para FALCON con kit de fijación		
Para modelos:	E7004, E7204, G7004, G7204		

¹con kit de fijación



código	901584 ¹	referencia	531920525 600606
descripción	junta de puerta perfil 2229 An 615mm L 770mm medidas exteriores para FALCON con kit de fijación		
Para modelos:	E7008, E7208, G7008, G7208		

¹con kit de fijación



código	901585 ¹	referencia	531940090 600607
descripción	junta de puerta perfil 2229 An 770mm L 900mm medidas exteriores para FALCON con kit de fijación		
Para modelos:	E7011, E7211, G7011, G7211		

¹con kit de fijación

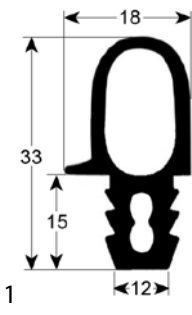

código	900865	referencia	530742368 EL742368
descripción	junta de puerta perfil 2449 An 490mm L 520mm UE 1		

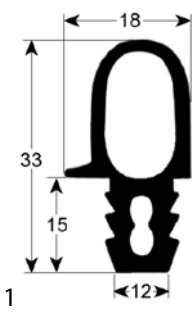

código	901483	referencia	530000423
descripción	junta de puerta perfil 2449 An 520mm L 1505mm UE 1		

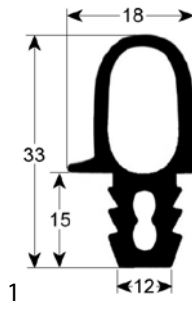

código	900497	referencia	530742376
descripción	junta de puerta perfil 2449 An 520mm L 775mm UE 1		



código	901490	referencia	530742406
descripción	junta de puerta perfil 2449 An 690mm L 1550mm UE 1		



código	900498	referencia	530693219 EL693219
descripción	junta de puerta perfil 2515 perímetro 1670mm UE 1		



código	902392	referencia	730580004
descripción	junta de puerta perfil 2761 An 400mm L 440mm medida inserción exterior para LAINOX		

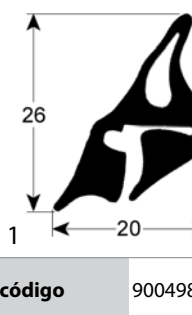

código	902392	referencia	730580004
descripción	junta de puerta perfil 2761 An 400mm L 440mm medida inserción exterior para LAINOX		

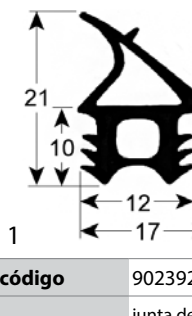

código	902392	referencia	730580004
descripción	junta de puerta perfil 2761 An 400mm L 440mm medida inserción exterior para LAINOX		

código	902023	referencia	530560006
descripción	junta de puerta perfil 2761 An 46mm L 775mm medidas exteriores UE 1 para LAINOX		

código	902024	referencia	530550062
descripción	junta de puerta perfil 2761 An 470mm L 560mm medidas exteriores UE 1		

código	901586	referencia	530843130 RS41
descripción	junta de puerta perfil 2956 L 3600mm para FALCON		
Para modelos:	E5478, G5478, G6478		

juntas para bandejeros

código	900199	referencia	530549207
descripción	junta para carro porta bandejas perfil 4070 L 1000mm UE 1		

juntas para paneles de control

código	902493	referencia	530742309
descripción	junta para panel de manejo An 220mm L 890mm para ELOMA para horno a vapor combinado con 8 ganchos de sujeción		

juntas tóricas

EPDM

código	504574	referencia	530013471
descripción	junta tórica EPDM espesor 1.78mm int.ø 9.25mm UE 1 pzs		

código	510409	referencia	730590010
descripción	junta tórica EPDM espesor 5.34mm int.ø 56.52mm UE 1 pzs		

silicona

código	532726	referencia	530577642
descripción	junta tórica silicona espesor 1.5mm int.ø 17mm UE 10 pzs		

Viton

código	510579	referencia	530581410
descripción	junta tórica Viton espesor 2.62mm int.ø 34.6mm UE 1 pzs		

código	529357	referencia	530753742
descripción	junta tórica Viton espesor 3.53mm int.ø 23.4mm UE 1 pzs		

NBR



1

código	532735	referencia	530503932
descripción	junta tórica NBR 70 espesor 1mm int.ø 6mm		

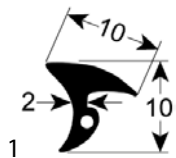

código	560648	referencia	530584096
descripción	junta para ELOMA L 1000mm UE 1m para horno a vapor combinado		

anillos de junta

juntas de grafito



1

código	696702	referencia	530550021
descripción	junta grafito ø ext. 84mm int.ø 61mm espesor 3mm UE 1 pzs		



1

código	699469	referencia	530505953 530742678
descripción	junta para ELOMA para modelo Genius T 6-11 10-11 L 64mm An 64mm para horno a vapor combinado int.ø 50mm grafito espesor 1.7mm		

juntas de silicona



1

código	359721	referencia	530693421
descripción	junta silicona ø ext. 48mm int.ø 39.5mm espesor 5mm UE 1 pzs		



1

código	699471	referencia	530507494
descripción	junta para ELOMA para modelo Genius T 6-11 10-11 para cámara quemador L 108mm An 100mm grafito horno a vapor combinado		

juntas de árbol

juntas de árbol



1

código	511172	referencia	530560025
descripción	junta de árbol int.ø 24mm ø ext. 29mm espesor 3mm		



1

código	699383	referencia	530560001
descripción	junta para LAINOX UE 1m ø ext. 126mm int.ø 90mm grafito espesor 3mm dist. del agujero 42mm agujero ø 7mm		

juntas especiales

para hornos a vapor combinado



1

código	699247	referencia	530550061
descripción	juego de juntas para horno a vapor combinado		

otros



1

código	109165	referencia	536060011 R5435
descripción	junta L 84mm An 65mm espesor 1.6mm corcho apto para FALCON		
Para modelos:	G2840, G2841, G2842, G2845F		

juntas de termostato



código	512389	referencia	534102050 RL/95
descripción	junta para termostato espesor 1mm L 45mm An 20mm UE 1 pzs dist. del agujero 30mm para FALCON		

muelles

muelles de torsión



código	692523	referencia	530503747
descripción	resorte de torsión ø 27.8mm int.ø 21.7mm L2 44mm espesor de hilo 3mm L1 13mm L3 44mm UE 1 pzs		

otros



código	514450	referencia	530791504
descripción	resorte para tirador de puerta ø 6mm L 61mm An 27.5mm		

manómetros



código	541979	referencia	530224758
descripción	manómetro ø 39mm margen de presión 0-4bar empalme atrás en el centro rosca 1/8"		

enrolladores de tubo y duchas de mano para lavado

duchas de mano para lavado



código	542062	referencia	530550110
descripción	ducha de mano de aparato 1/2" H L 225mm tipo LAINOX		



código	542404	referencia	530550111
descripción	tubo de ducha empalmes 1/2" L 2500mm inox cubierto en plástico ø nominal DN8mm		

enrolladores de tubo

enrolladores de mangueras para aparatos



código	545067	referencia	530753181
descripción	enrollador de mangueras sin ducha de mano longitud de tubo 1.55m		

dosificadores

bombas de pistón

dosificadores



código	361941	referencia	5316075
descripción	dosificador tipo 14825-645 230V detergente entrada 7mm salida 9mm 0,2-0,8l/h GRI PUMPS		





bombas de membrana

autoaspirantes

LARGO



1

código	361009	referencia	3086077 5315665
descripción	dosificador tipo N6 bomba de membrana abrillantador p mín. 0.5bar empalme presión ø recto, 4x6mm conector para succión ø recto, 4x6mm LANG		
repuestos para	361009		
	código	361079	referencia —
	resorte para tipo N5/N6 para esfera		
	código	361080	referencia —
	junta tórica EPDM espesor 2mm int.ø 16mm UE 1 pzs		
	código	361085	referencia —
	junta tórica EPDM espesor 2mm int.ø 8mm UE 1 pzs		
	código	361309	referencia —
	esfera para tipo N5/N6		
	código	361310	referencia —
	soporte para tipo N6 guía de bola		
	código	361311	referencia —
	junta tórica EPDM espesor 2mm int.ø 6mm UE 1 pzs para tipo N6		
	código	361314	referencia —
	anillo de válvula para tipo N6 soporte para junta tórica		
	código	361317	referencia —
	disco de obturación para tipo N6		
	código	361886	referencia —
	válvula de retención entradamm salidamm salida ø 12.4mm L 12.7mm		

tubos flexibles

tubos flexibles de ducha

tubos flexibles inoxidables



1

código	542404	referencia	530550111
descripción	tubo de ducha empalmes 1/2" L 2500mm inox cubierto en plástico ø nominal DN8mm		

tubos flexibles industriales

tubos de nylon



1

código	520252	referencia	530785857
descripción	tubo de nylon int.ø 6mm ø ext. 8mm L 5m grosor de la pared 1mm p de trabajo 10bar p de reventamiento 50bar T máx 100°C blanco		

tubos PE



1

código	520973	referencia	530550067
descripción	tubo flexible John Guest grosor de la pared 1.5mm LLDPE azul int.ø 7mm ø ext. 10mm		
accesorios para	520973		
	código	440564	referencia —
	racor para tubería John Guest recto rosca 1/4" BSP empalme de tubo ø10mm		
	código	440565	referencia —
	racor para tubería John Guest recto rosca 3/8" BSP empalme de tubo ø10mm		
	código	440608	referencia —
	racor para tubería John Guest recto rosca 1/2" BSP ø racor 10mm		
	código	440639	referencia —
	racor para tubería John Guest acodado rosca 1/4" BSP empalme de tubo ø10mm		
	código	520359	referencia 530550007
	racor para tubería John Guest acodado empalme de tubo ø10mm boquilla ø 10mm		
	código	520363	referencia 530550004
	racor para tubería John Guest pieza T empalme de tubo ø10mm - ø10mm - ø10mm		
	código	520494	referencia 530550005
	racor para tubería John Guest acodado empalme de tubo ø10mm - ø10mm		

tubos flexibles PU



1

código	512505	referencia	530550172
descripción	tubo flexible PU int.ø 5mm ø ext. 8mm L 1m grosor de la pared 1.5mm T máx -40 a +60°C poliuretano transparente/sin color		

tubos de silicona

sin tejido



código	530899	referencia	530550163
descripción	tubo de silicona int.ø 13mm ø ext. 18mm L 0.08m grosor de la pared 2.5mm rojo para horno a vapor combinado		

con tejido

con recubrimiento de fibra de vidrio trenzada



código	520024	referencia	530593303
descripción	tubo de silicona con recubierta de fibra de vidrio int.ø 9.5mm ø ext. 17mm L 5m grosor de la pared 3.75mm p de trabajo 4bar presión de reventam. a 95°C 26bar presión de reventam. a 130°C 14bar T máx 200°C blanco		

tubos formados

recto

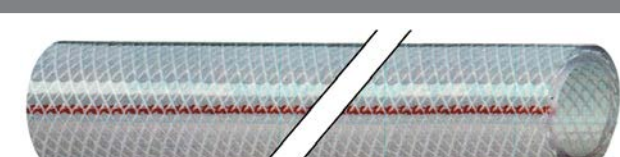

código	520599	referencia	531920490 600552
descripción	tubo de tejido de PVC D1 ø 11mm D2 ø 7mm transparente UE al metro		



código	520534	referencia	530550162
descripción	tubo flexible int.ø 50mm ø ext. 58mm L 50mm silicona UE 1 para horno a vapor combinado espesor 4mm		

guarniciones, empalmes para mangueras y tubos

empalmes de tubos

otros



código	501591	referencia	530753890
descripción	empalme de tubos acero inoxidable tubo ø 10/13mm M9 para sistema de limpieza horno a vapor combinado		

guarniciones

boquillas dobles



código	520160	referencia	530440092 530754447
descripción	boquilla doble latón niquelado rosca 1/8" - 1/8" UE 1 pzs		



código	521187	referencia	530570451
descripción	boquilla doble latón niquelado rosca 1/8" - 3/8" UE 1 pzs ø int. 1.5mm ø int. 2.9.3mm		

racores de tubo

piezas angulares



código	699452	referencia	530550011
descripción	pieza angular rosca M14x1 tubo ø 10mm latón		



empalmes de tubo

plástico



1

código	362011	referencia	530550008
descripción	empalme de tubo plástico recto rosca 1/4" tubo ø 8x6mm UE 1 pzs		

acero inoxidable



1

código	542385	referencia	530550013
descripción	empalme de tubo inox acodado rosca 1/4" tubo ø 10mm UE 1 pzs		

específico del fabricante



1

código	520360	referencia	730580000
descripción	empalme de tubo rosca 1/4" con acoplamiento recto plástico		



1

código	440027	referencia	530550006
descripción	pieza de empalme para tubo DI 6mm EC 15 longitud total 79mm plástico John Guest		

racores para tubería

JOHN GUEST



1

código	520359	referencia	530550007
descripción	racor para tubería John Guest acodado empalme de tubo ø10mm boquilla ø 10mm		
accesorios para	520359		
	código	520973	referencia 530550067
	tubo flexible John Guest grosor de la pared 1.5mm LLDPE azul int.ø 7mm ø ext. 10mm		



1

código	520493	referencia	530550010
descripción	empalme de tubos John Guest recto empalme de tubo ø8mm - ø10mm L 41mm PM201008E NSF, SK		



1

código	520492	referencia	530561000
descripción	racor para tubería John Guest recto empalme de tubo ø10mm - ø10mm		



1

código	520494	referencia	530550005
descripción	racor para tubería John Guest acodado empalme de tubo ø10mm - ø10mm		
accesorios para	520494		
	código	520973	referencia 530550067
	tubo flexible John Guest grosor de la pared 1.5mm LLDPE azul int.ø 7mm ø ext. 10mm		



1

código	520363	referencia	530550004
descripción	racor para tubería John Guest pieza T empalme de tubo ø10mm - ø10mm - ø10mm		
accesorios para	520363		
	código	520973	referencia 530550067
	tubo flexible John Guest grosor de la pared 1.5mm LLDPE azul int.ø 7mm ø ext. 10mm		



1

código	520495	referencia	530550009
descripción	racor para tubería John Guest recto rosca 1/8" BSP ø racor 8mm		
accesorios para	520495		
	código	520971	referencia —
	tubo flexible grosor de la pared 1mm LLDPE azul int.ø 4mm ø ext. 6mm presión de trabajo a 20°C 16bar		



1

código	440031	referencia	530550015
descripción	racor para tubería John Guest recto rosca 1/2" empalme de tubo ø8mm - ø8mm racor pasamuros		

válvulas y caños de pared

válvulas de bola

universal

válvulas de bola con manilla de palanca



1

código	540758	referencia	534510060 R3611
descripción	válvula de bola empalme 1" H - 1" M DN25 longitud 90mm con manilla de palanca longitud de asidero 95mm		
Para modelos:	E1808, E1838, E1848, E3862, G1008X, G1808-CE, G1808-Pre-CE, G1830-MK2, G1838-CE, G1838X, G1848-CE, G1848-Pre-CE, G1848X, G1860-MK2, G1865, G3830, G3860, G3865		

específico del fabricante

FALCON



1

código	514432	referencia	535770011 801956
descripción	válvula de bola H 1" juego L 82mm maneta de mariposa/ manilla de palanca		
Para modelos:	G2840, G2841, G2842, G2844F, G2845F		

válvulas de bola eléctricas



1

código	541892 ¹	referencia	534350605 600378
descripción	válvula de bola entrada 28mm salida 28mm con interruptor de límite 230V L 100mm 50/60Hz abierto sin corriente An 78mm H 115mm empalme cable 750mm cable 750 H M eje ø 9,5x3mm SUNVIC		

¹abierto sin corriente



1

código	403042	referencia	730610000
descripción	válvula de bola entrada 3/4" H salida 3/4" H 230V L 68mm cerrado sin corriente modo operativo eléctrico empalme cable 400mm		

válvulas de manguito



1

código	541891	referencia	531313040 RM31/4
descripción	válvula de manguito empalme 3/4" H - 3/4" H longitud 49mm latón		
Para modelos:	G1860		



componentes para el circuito agua

reductores de presión

reductores de presión

específico del fabricante



1

código	520502	referencia	530871419
descripción	reductor de presión Norgren serie R91 empalme 1/8" preajustable margen de ajuste 0,1-3bar p máx. 10bar T máx 50°C latón		

material auxiliar

abrazaderas

abrazaderas de seguridad

inox/latón



1

código	520069	referencia	530276634
descripción	abrazadera de tubo inox / latón ø 14-19mm ancho 11mm UE 5 pzs		



1

código	520070	referencia	530276642
descripción	abrazadera de tubo inox / latón ø 16-21mm ancho 11mm UE 5 pzs		



1

código	520071	referencia	530572160
descripción	abrazadera de tubo inox / latón ø 17-22mm ancho 11mm UE 5 pzs		



1

código	520067	referencia	730277665
descripción	abrazadera de tubo inox / latón ø 9-14mm ancho 10mm UE 5 pzs		

material de sujeción

tornillos

tornillos prisioneros

DIN 913/ISO 4026



1

código	560497	referencia	530753785 EL753785
descripción	tornillo prisionero rosca M8 L 8mm A2-A2L DIN 913/ISO 4026 EC 4 UE 20 pzs		

DIN 916/ISO 4029



1

código	560173	referencia	530588512
descripción	tornillo prisionero rosca M4 L 10mm inox DIN 916/ISO 4029 soporte Allen hexagonal EC 2 UE 20 pzs		

otros



1

código	560621	referencia	530399280
descripción	tornillo prisionero rosca 1/8" L 5mm latón EC hexagonal 5mm UE 1 pzs		

tuercas

tuercas hexagonales

tuercas hexagonales métricas (sin norma)



1

código	550681	referencia	530550002
descripción	tuerca rosca M12x1,25 H 5mm EC 17 latón UE 1 pzs		

arandelas

arandelas dentadas

DIN 6798A



1

código	560193	referencia	530349771
descripción	arandela dentada int.ø 10.4mm ø ext. 18mm acero zincado DIN/ISO DIN 6798A UE 1 pzs para rosca M10		



1

código	560127	referencia	530510020
descripción	arandela dentada int.ø 6.2mm ø ext. 11mm inox DIN/ISO DIN 6798A UE 20 pzs para rosca M6		

sujeciones

abrazaderas

abrazaderas de seguridad

inox/latón



1

código	520069	referencia	530276634
descripción	abrazadera de tubo inox / latón ø 14-19mm ancho 11mm UE 5 pzs		



1

código	520070	referencia	530276642
descripción	abrazadera de tubo inox / latón ø 16-21mm ancho 11mm UE 5 pzs		



1

código	520071	referencia	530572160
descripción	abrazadera de tubo inox / latón ø 17-22mm ancho 11mm UE 5 pzs		



1

código	520067	referencia	730277665
descripción	abrazadera de tubo inox / latón ø 9-14mm ancho 10mm UE 5 pzs		

consumibles

sellantes y pegamentos

silicona de alta temperatura



1

código	890107	referencia	530500402
descripción	silicone de alta temperatura TOMABOND TB76 -40 a +250°C rojo/marrón tubo 90ml		
descripción	Tomabond TB76 - tubo 90ml - pardo rojo Silicona elástica especial para uso general como adhesivo y sellante con altas solicitaciones térmicas. TB 76 se utiliza principalmente en instalaciones domiciliarias, climatización, ventilación y construcción de máquinas. Resiste a corto plazo temperaturas de 300°C		

fusibles

fusibles finos



1

código	358532	referencia	530190756
descripción	fusible fino medida ø5x20mm 2A rápido nominal 250V UE 10 pzs		



1

código	358595	referencia	730580042
descripción	fusible fino medida ø5x20mm 0.2A retardado nominal 250V UE 10 pzs		



1

código	358703	referencia	530560030
descripción	fusible fino medida ø5x20mm 0.4A retardado nominal 250V UE 10 pzs		



1



código	358790	referencia	536430009 R5524
descripción	fusible fino medida ø6,3x32mm 5A retardado nominal 250V UE 10 pzs		
Para modelos:	E3840, E401F, E402F, E421, E421F, E422, E422F, G2844F, G2845F, G3106, G3840, G401F, G402F		

1



código	358004	referencia	731750790
descripción	fusible 20A nominal 240V UE 1 pzs		
Para modelos:	E1962, E1965, E1994, E1995		

1



código	358043	referencia	530658294
descripción	fusible medida D01 16A nominal 250/400V E14 ø 11mm L 36mm UE 10 pzs		

1



código	358045	referencia	530751863
descripción	fusible medida D02 35A nominal 250/400V E18 ø 15mm L 36mm UE 10 pzs		

1



código	358067	referencia	530751855
descripción	suplemento de ajuste medida D02 apto para 35A		

A			
abrazaderas	89, 90		
abrazaderas de seguridad	89, 90		
accesorios eléctricos	36		
anillos de junta	83		
aparatos de mando y aviso	16		
arandelas dentadas	90		
B			
bisagras rectangulares	74		
bombas	34		
bombas de aumento de presión I	34		
bombas de aumento de presión II	34		
bombas de lavado y aclarado	34		
bombas de vibración	35		
bombillas incandescentes	17		
boquillas de gas	64		
boquillas dobles	86		
C			
cables	36		
cables de alimentación aparatos	36		
cables de encendido	53		
centralitas de gas automáticas	45		
cierres angulares	73		
cierres de enganche	74		
cierres de palanca	73		
cierres de pestillo espagnolette	74		
componentes para el circuito agua	89		
condensadores de servicio	35		
condensadores y filtros antiparasitarios	35		
conmutadores de levas	15		
consumibles	90		
contactores	19		
controladores electrónicos	23		
D			
dosificadores	84		
duchas de mano para lavado	84		
E			
electródos	29		
empalmes de tubo	87		
empalmes de tubos	86		
encendedores piezoeléctricos	54		
enrolladores de mangueras para aparatos	84		
enrolladores de tubo	84		
F			
filtros	35		
fusibles	35, 90		
fusibles de rosca	91		
fusibles finos	90		
G			
grifos de gas	37		
guarniciones	86		
I			
interruptores de contacto	15		
interruptores magnéticos	15		
interruptores y pulsadores	14		
J			
juntas de árbol	83		
juntas de termostato	84		
juntas para bandejeros	82		
juntas para paneles de control	82		
juntas para puertas	79		
juntas térmicas	79		
juntas tóricas	82		
L			
lámparas	16		
lámparas de señalización	16		
lámparas de señalización completas	16		
lámparas halógenas	17		
lámparas infrarrojas	18		
lámparas para hornos	18		
lámparas tubulares	18		
M			
material de sujeción	89		
microinterruptores	14		
motores	33		
motores de aire caliente	30		
P			
pilotos de encendido	47		
placas de cocción	6		
presostatos	28, 68		
puentes de encendido	59		
Q			
quemadores de cocina	60		
quemadores de gas	60		
quemadores para placas radiantes	62		
quemadores tubulares	62		
R			
racores de tubo	86		
racores para tubería	87		
reductores de presión	89, 89		
reguladores de energía	6		
reguladores de presión de gas	67		

rejillas y rieles guía	79
relés	22
relés de temporización	22
resistencias	3
resistencias circulación de aire	4
resistencias de inmersión	3
resistencias para hornos	3
resistencias para salamandras / tostadores de pan	3
resistencias para sartenes basculantes	3
ruedas para aparatos y esquinas protectoras	78

S

sellantes y pegamentos	90
semiconductores de potencia	21
señalizadores de alarma	19
sensores	23
sensores universales	23
silicona	90
silicona de alta temperatura	90
sondas de temperatura	23
sopletes	63
sujeciones	90

T

temporizadores	19
temporizadores eléctricos	19
temporizadores mecánicos	19
terminales	37
termopares	55
termostatos	7
termostatos de regulación	7
termostatos de seguridad	8
termostatos de superficie	7
termostatos para gas	40
tornillos	89
tornillos prisioneros	89
transformadores	22
tuberías de gas	67
tubos de nylon	85
tubos de silicona	86
tubos flexibles de ducha	85
tubos flexibles	85
tubos flexibles industriales	85
tubos flexibles inoxidables	85
tubos flexibles PU	85
tubos formados	86
tubos PE	85
tuercas	89
tuercas hexagonales	89

U

unidades de encendido	55
-----------------------	----

V

válvulas de bola	88
válvulas de bola eléctricas	28, 88
válvulas de control de gas	42
válvulas de manguito	88
válvulas de seguridad	46
válvulas magnéticas	26
válvulas magnéticas de gas	47
válvulas y caños de pared	88
ventilador axial	29
ventiladores	29
ventiladores de aire caliente	33
ventiladores radiales	33