



GAS



ELEKTRA



WATER



MECHANIEK



GEREEDSCHAP

Reparatie-onderdelen passend voor

FIREX

Het complete assortiment vindt u altijd up-to-date in onze webshop



Fabrikant-catalogussen

Per fabrikant de belangrijkste vervangingsonderdelen en toebehoren overzichtelijk bij elkaar

- ✓ **Compleet assortiment en altijd de actuele apparatuurgegevens in de GEV-Webshop**
- ✓ **Alfabetische Index achter in de catalogus**

GEV-Webshop

www.gev-online.nl



- 🔍 **Artikel als favoriet opslaan**
- 🔍 **Inloggen met E-mailadres en bekende paswoord**
- 🔍 **Bulk bestellen - meerdere artikelen direct in de winkelwagen laden**
- 🔍 **Direct op artikel zoeken zonder je hoeven aan te melden**



verwarmingselementen

elementen voor kantelbare braadpannen



1

| | | | |
|---------------------|---|---------------------|----------|
| bestelnr. | 416692 | fabrikantnr. | 40400082 |
| omschrijving | verwarmingselement kantel braadpan 2900W 230V L 312mm B 200mm H 82mm aansluiting M5 droog verwarmingselement VC 1 pijp ø 8.5mm B1 66mm B2 68mm aansluitafstand 61mm | | |



dompelelementen

3-gatsflens ø47,5mm

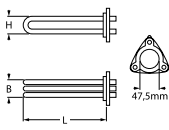

1



| | | | |
|---|---|---------------------|-----------------------|
| bestelnr. | 416834 | fabrikantnr. | 40400040 |
| omschrijving | verwarmingselement 8000W 230V inbouw ø 47.5mm VC 3 L 323mm B 35mm H 45mm aantal thermostaathulzen 1 thermostaathuls ø 7mm thermostaathuls lengte 263mm thermostaathuls buitenmidden, aanliggend pijp ø 8.5mm LA 64mm gat ø 8mm aansluiting M4 3-gatsflens dompel verwarmingselement | | |
| Toebehoren voor | 416834 | | |
|  | bestelnr. | 510408 | fabrikantnr. — |
| | O-ring EPDM materiaaldikte 5.34mm ID ø 47mm vpe 1stuk | | |
|  | bestelnr. | 510562 | fabrikantnr. — |
| | O-ring silicone materiaaldikte 5.34mm ID ø 47mm vpe 1stuk | | |



1



| | | | |
|---|--|---------------------|-----------------------|
| bestelnr. | 416835 | fabrikantnr. | 40400042 |
| omschrijving | verwarmingselement 9000W 230V inbouw ø 47.5mm VC 3 L 415mm B 30mm H 46mm aantal thermostaathulzen 1 thermostaathuls ø 7.5mm thermostaathuls lengte 255mm thermostaathuls buitenmidden, aanliggend LA 62mm gat ø 8mm aansluiting M4 3-gatsflens dompel verwarmingselement | | |
| Voor modellen: | KPI15ETA-GIGA, KPI15ET-GIGA, KPI30ETA-GIGA, KPI30ET-GIGA, KPI50ETA-GIGA, KPI50ET-GIGA | | |
| Toebehoren voor | 416835 | | |
|  | bestelnr. | 510408 | fabrikantnr. — |
| | O-ring EPDM materiaaldikte 5.34mm ID ø 47mm vpe 1stuk | | |
|  | bestelnr. | 510562 | fabrikantnr. — |
| | O-ring silicone materiaaldikte 5.34mm ID ø 47mm vpe 1stuk | | |



1

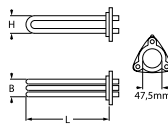



| | | | |
|---|--|---------------------|-----------------------|
| bestelnr. | 419113 | fabrikantnr. | 40400038 |
| omschrijving | verwarmingselement 9000W 230V inbouw ø 47.5mm VC 3 L 550mm B 38mm H 45mm aantal thermostaathulzen 1 thermostaathuls ø 7.3mm thermostaathuls lengte 260mm pijp ø 8.5mm aansluiting M4 3-gatsflens dompel verwarmingselement L1 55mm H1 33mm H2 34mm | | |
| Toebehoren voor | 419113 | | |
|  | bestelnr. | 510408 | fabrikantnr. — |
| | O-ring EPDM materiaaldikte 5.34mm ID ø 47mm vpe 1stuk | | |

groep 7



1

| | | | |
|---|--|---------------------|-----------------------|
| bestelnr. | 418505 | fabrikantnr. | 40400048 |
| omschrijving | verwarmingselement 8000W 230V VC 3 flens ø 47.5mm L 497mm B 35mm H 56mm pijp ø 8.5mm thermostaathuls ø 7.5mm thermostaathuls lengte 266mm aantal thermostaathulzen 1 thermostaathuls niet-aangrenzend aansluiting M4 dompel verwarmingselement 3-gatsflens LA 58mm inbouw ø 47.5mm gat ø 8mm | | |
| Voor modellen: | KPI10ETA-GIGA, KPI10ET-GIGA, KPI20ETA-GIGA | | |
| Toebehoren voor | 418505 | | |
|  | bestelnr. | 510408 | fabrikantnr. — |
| | O-ring EPDM materiaaldikte 5.34mm ID ø 47mm vpe 1stuk | | |
|  | bestelnr. | 510562 | fabrikantnr. — |
| | O-ring silicone materiaaldikte 5.34mm ID ø 47mm vpe 1stuk | | |



thermostaten

regel- en maximaalthermostaten

EGO

regelthermostaten

serie 55.10/19_

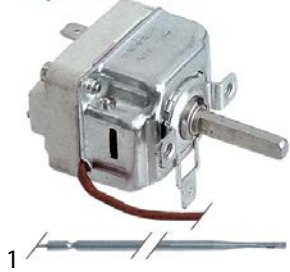

| | | | |
|-----------------------|--|---------------------|----------|
| bestelnr. | 375363 | fabrikantnr. | 40100050 |
| omschrijving | thermostaat t.max. 161°C instelbereik 73-161°C 1-polig 1NO 16A voeler ø 3mm voeler L 144mm capillaire 1600mm capillaire pijp geïsoleerd 1600mm stopbus as ø 6x4,6mm as L 23mm aspositie boven rotatiehoek 270° | | |
| Voor modellen: | KPI10ETA-GIGA, KPI10ET-GIGA, KPI15ETA-GIGA, KPI15ET-GIGA, KPI20EA-GIGA, KPI20E-GIGA, KPI20ETA-GIGA, KPI20ET-GIGA, KPI30EA-GIGA, KPI30E-GIGA, KPI30ETA-GIGA, KPI30ET-GIGA, KPI50EA-GIGA, KPI50E-GIGA, KPI50ETA-GIGA, KPI50ET-GIGA | | |

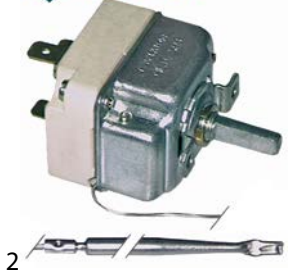

| | | | |
|---------------------|---|---------------------|----------|
| bestelnr. | 375270 | fabrikantnr. | 40100042 |
| omschrijving | thermostaat t.max. 295°C instelbereik 45-295°C 1-polig 1NO 16A voeler ø 4mm voeler L 100mm capillaire 900mm capillaire pijp geïsoleerd 350mm stopbus as L 23mm aspositie boven rotatiehoek 270° | | |

maximaalthermostaten

serie 55.32_



| | | | |
|-----------------------|---|---------------------|----------|
| bestelnr. | 375364 | fabrikantnr. | 40100041 |
| omschrijving | maximaalthermostaat uitschakeltemp. 190°C 3-polig 20A voeler ø 4mm voeler L 120mm capillaire 3000mm capillaire pijp geïsoleerd 3000mm stopbus voeler | | |
| Voor modellen: | KPI10ETA-GIGA, KPI10ET-GIGA, KPI15ETA-GIGA, KPI15ET-GIGA, KPI20ETA-GIGA, KPI20E-GIGA, KPI20ETA-GIGA, KPI30ETA-GIGA, KPI30ET-GIGA, KPI50ETA-GIGA, KPI50E-GIGA, PM9, G170GN-FAGOR, PM9.G270GN-FAGOR, PM9.G370GN-FAGOR | | |

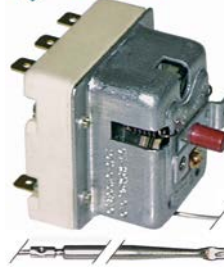

| | | | |
|---------------------|--|---------------------|----------|
| bestelnr. | 375350 | fabrikantnr. | 40100062 |
| omschrijving | maximaalthermostaat uitschakeltemp. 360°C 3-polig 20A voeler ø 4mm voeler L 120mm capillaire 1800mm capillaire pijp geïsoleerd 1800mm stopbus voeler RVS | | |



| | | | |
|-----------------------|--|---------------------|----------|
| bestelnr. | 390227 | fabrikantnr. | 40100062 |
| omschrijving | maximaalthermostaat uitschakeltemp. 360°C 3-polig 20A voeler ø 4mm voeler L 120mm capillaire 1800mm capillaire pijp geïsoleerd 1800mm stopbus voeler RVS | | |
| Voor modellen: | KPI20EA-GIGA, KPI20E-GIGA, KPI30EA-GIGA, KPI30E-GIGA, KPI50EA-GIGA, KPI50E-GIGA | | |



toebehoren

stopbustoebehoren

doorvoeren



| | | | |
|---------------------|---|---------------------|----------|
| bestelnr. | 550148 | fabrikantnr. | 10400188 |
| omschrijving | stopbusdoorvoering OD M12x0,75 BD M9x1 voeler ø max. 6.5mm SB 17 silicone | | |

schakelaars en tasters

drukschakelaar/-knoppen

ø25mm



| | | | |
|-----------------------|--|---------------------|----------|
| bestelnr. | 345038 | fabrikantnr. | 40100034 |
| omschrijving | drukschakelaar tastend inbouw ø 25mm zwart 2NO 250V 16A aansluiting vlaksteker 6,3mm omgevingstemperatuur max. 85°C bescherming IP40 | | |
| Voor modellen: | PM9.G170GN-FAGOR, PM9.G270GN-FAGOR, PM9.G370GN-FAGOR | | |



| | | | |
|------------------------|---|---------------------|----------|
| bestelnr. | 345039 | fabrikantnr. | 40100036 |
| omschrijving | beschermkap rond OD ø 33mm buitenmaat 23mm binnenmaat 21mm H 12mm transparant inbouw ø 25mm | | |
| Voor modellen: | PM9.G170GN-FAGOR, PM9.G270GN-FAGOR, PM9.G370GN-FAGOR | | |
| Toebehoren voor | 345039 | | |



| | | | |
|---------------------|---|---------------------|---|
| bestelnr. | 345001 | fabrikantnr. | — |
| omschrijving | drukschakelaar tastend inbouw ø 25mm geel 1NO/signaallamp 250V 16A afdekking aansluiting vlaksteker 6,3mm omgevingstemperatuur max. 85°C bescherming IP65 | | |

microschakelaars

hendelbediening



| | | | |
|---------------------|--|---------------------|----------|
| bestelnr. | 345044 | fabrikantnr. | 40100007 |
| omschrijving | microschakelaar met hendel 250V 16A 1CO aansluiting vlaksteker 6,3mm omgevingstemperatuur max. 85°C bevestigingsafstand 25mm type C99ZP3 besturingskracht: 25g hendellengte 71mm | | |

rolhendelbediening

microschakelaars



| | | | |
|---------------------|---|---------------------|----------|
| bestelnr. | 347272 | fabrikantnr. | 40100122 |
| omschrijving | microschakelaar met rolhendel 250V 16A 1CO aansluiting vlaksteker omgevingstemperatuur max. 85°C bevestigingsafstand 22.2mm wit hendellengte 20mm | | |

nokschakelaars

3-schakelstanden



| | | | |
|-----------------------|--|---------------------|--|
| bestelnr. | 300167 | fabrikantnr. | 40100004 40100004+SMP0936-00+SMP0938-00 |
| omschrijving | nokschakelaar 3 schakelstanden 2NO/1CO schakelvolgorde 0-1-2 16A as ø 6x4,6mm as L 23mm aansluiting schroefaansluiting | | |
| Voor modellen: | KPI10ETA-GIGA, KPI10ET-GIGA, KPI15ETA-GIGA, KPI15ET-GIGA, KPI20EA-GIGA, KPI20E-GIGA, KPI20ETA-GIGA, KPI20ET-GIGA, KPI30EA-GIGA, KPI30E-GIGA, KPI30ETA-GIGA, KPI30ET-GIGA, KPI50EA-GIGA, KPI50E-GIGA, KPI50ETA-GIGA, KPI50ET-GIGA | | |

lampen

signaallampen

signaallampen 2-delig (lens en signaallamp)

signaalelementen voor fittingtype SRZ / SDK / SDY / SFK



| | | | |
|-----------------------|--|---------------------|----------|
| bestelnr. | 359133 | fabrikantnr. | 40200154 |
| omschrijving | signaalelement 400V groen aansluiting vlaksteker 6,3mm | | |
| Voor modellen: | KPI10ETA-GIGA, KPI10ET-GIGA, KPI15ETA-GIGA, KPI15ET-GIGA, KPI20EA-GIGA, KPI20E-GIGA, KPI20ETA-GIGA, KPI20ET-GIGA, KPI30EA-GIGA, KPI30E-GIGA, KPI30ETA-GIGA, KPI30ET-GIGA, KPI50EA-GIGA, KPI50E-GIGA, KPI50ETA-GIGA, KPI50ET-GIGA | | |



signaallampen compleet

ø12mm

met schroeffitting



1

| | | | |
|-----------------------|--|---------------------|----------|
| bestelnr. | 359290 | fabrikantnr. | 40200150 |
| omschrijving | signaallamp ø 12mm 400V geel aansluiting vlaksteker 6,3mm | | |
| Voor modellen: | KPI10ETA-GIGA, KPI10ET-GIGA, KPI15ETA-GIGA, KPI15ET-GIGA, KPI20EA-GIGA, KPI20E-GIGA, KPI20ETA-GIGA, KPI20ET-GIGA, KPI30EA-GIGA, KPI30E-GIGA, KPI30ETA-GIGA, KPI30ET-GIGA, KPI50EA-GIGA, KPI50E-GIGA, KPI50ETA-GIGA, KPI50ET-GIGA | | |



1

| | | | |
|-----------------------|--|---------------------|----------|
| bestelnr. | 359291 | fabrikantnr. | 40200152 |
| omschrijving | signaallamp ø 12mm 400V groen aansluiting vlaksteker 6,3mm | | |
| Voor modellen: | KPI10ETA-GIGA, KPI10ET-GIGA, KPI15ETA-GIGA, KPI15ET-GIGA, KPI20EA-GIGA, KPI20E-GIGA, KPI20ETA-GIGA, KPI20ET-GIGA, KPI30EA-GIGA, KPI30E-GIGA, KPI30ETA-GIGA, KPI30ET-GIGA, KPI50EA-GIGA, KPI50E-GIGA, KPI50ETA-GIGA, KPI50ET-GIGA | | |



1



| | | | |
|-----------------------|--|---------------------|----------|
| bestelnr. | 359292 | fabrikantnr. | 40200148 |
| omschrijving | signaallamp ø 12mm 400V rood aansluiting vlaksteker 6,3mm | | |
| Voor modellen: | KPI10ETA-GIGA, KPI10ET-GIGA, KPI15ETA-GIGA, KPI15ET-GIGA, KPI20ETA-GIGA, KPI20E-GIGA, KPI20ET-GIGA, KPI30ETA-GIGA, KPI30E-GIGA, KPI30ET-GIGA, KPI50ETA-GIGA, KPI50E-GIGA | | |

timers

mechanische timers



1

| | | | |
|---|--|---------------------|-----------------------|
| bestelnr. | 350176 | fabrikantnr. | 40100158 |
| omschrijving | tijdschakelaar C20 2-polig looptijd 5min 2NO bij 250V 16A vaste positie nee as ø 6x4,6mm as 6x4,6mm as L 20mm bevestigingsafstand 28mm | | |
| Toebehoren voor | 350176 | | |
|  | bestelnr. | 110366 | fabrikantnr. — |
| | knop schakelaar nulstreep t.max. °C°C ø 44mm as ø 6x4,6mm afvlakking boven zwart | | |
|  | bestelnr. | 112138 | fabrikantnr. — |
| | symboolschijf indeling 5min vaste positie nee rotatiehoek 0-290° ø 60mm | | |

relais

niveaurelais

GICAR



1

| | | | |
|---------------------|--|---------------------|----------|
| bestelnr. | 403748 | fabrikantnr. | 40800054 |
| omschrijving | niveauregelaar 230V spanning AC 50/60Hz aansluiting vlaksteker 6,3mm type RL30/2E-2C/F | | |

magneetventielen

magneetventielen voor water

metaal

SIRAI

magneetventielen stoom (water)

2-wegs

serie L153-D



1

| | | | |
|---|---|---------------------|-----------------------|
| bestelnr. | 370326 | fabrikantnr. | 30100066 |
| omschrijving | magneetventiel 2-weg 230VAC aansluiting 1" L 105mm nominale breedte 22mm steekbus DIN -10 tot +140°C SIRAI serie L153-D spoeltype Z914A membraam EPDM (stoom/water) p max. 8bar p min. 0.1bar | | |
| Reparatie-onderdelen voor | 370326 | | |
|  | bestelnr. | 371161 | fabrikantnr. — |
| | magneetspoel 230VAC 27VA SIRAI spoeltype Z923A afname ø 16mm 50Hz | | |





zekeringen

glaszekeringen



1

| | | | |
|-----------------------|--|---------------------|----------|
| bestelnr. | 358605 | fabrikantnr. | 40200084 |
| omschrijving | fijnzekering grootte ø5x20mm 3.15A traag maximale spanning 250V vpe 10stuk | | |
| Voor modellen: | KPI10ETA-GIGA, KPI10ET-GIGA, KPI15ETA-GIGA, KPI15ET-GIGA | | |







| Toebehoren voor | | 101893 |
|---|---|-----------------------|
|  | bestelnr. | 101255 fabrikantnr. — |
| | snijring voor pijpø 12mm vpe 1stuk | |
|  | bestelnr. | 101256 fabrikantnr. — |
| | snijring voor pijpø 16mm vpe 1stuk | |
|  | bestelnr. | 101257 fabrikantnr. — |
| | snijring voor pijpø 20mm vpe 1stuk | |
|  | bestelnr. | 101286 fabrikantnr. — |
| | snijring ID ø 6mm vpe 1stuk | |
|  | bestelnr. | 110080 fabrikantnr. — |
| | knop ø 70mm as ø 10x8mm afvlakking universeel | |
|  | bestelnr. | 112206 fabrikantnr. — |
| | knopsymbol zilver gaskraan PEL21/22/23 t.max.°C OD ø 63mm ID ø 45.5mm | |

gasthermostaten

SIT

serie 630 Eurosit



| bestelnr. | | 101125 | fabrikantnr. | 30100080 |
|--|--|--------|--------------|----------|
| omschrijving | | | | |
| gasthermostaat type serie 630 Eurosit t.max. 340°C 100-340°C gasingang 3/8" gasuitgang 3/8" thermoelementaansluiting M9x1 waakvlamaansluiting M10x1 voeler ø 4mm voeler L 72mm capillaire 1050mm SIT | | | | |
| Toebehoren voor | | 101125 | | |
|  | bestelnr. | 100825 | fabrikantnr. | — |
| | gaskraanas as ø 8x6,5mm as L 22/14mm passend voor EUROSIT | | | |
|  | bestelnr. | 100904 | fabrikantnr. | — |
| | klenschroef M10x1 voor pijpø 4mm vpe 1stuk | | | |
|  | bestelnr. | 100905 | fabrikantnr. | — |
| | klenschroef M10x1 voor pijpø 6mm vpe 1stuk | | | |
|  | bestelnr. | 100949 | fabrikantnr. | — |
| | pakking passend voor serie 630 Eurosit | | | |
|  | bestelnr. | 101273 | fabrikantnr. | — |
| | snijring voor pijpø 12mm L 9.5mm koper vpe 1stuk passend voor universeel | | | |
|  | bestelnr. | 101276 | fabrikantnr. | — |
| | knelschroef draad 3/8" pijp ø 12mm vpe 1stuk | | | |
|  | bestelnr. | 101333 | fabrikantnr. | — |
| | plug draad 3/8" met o-ring | | | |

| Toebehoren voor | | 101125 | | |
|---|--|--------|--------------|---|
|  | bestelnr. | 101390 | fabrikantnr. | — |
| | gaskraanas as ø 6x4,6mm as L 32/15mm gaskraan met ontstekingsvlam passend voor ZANUSSI, MARENO voor gasthermostaat EUROSIT | | | |
|  | bestelnr. | 101392 | fabrikantnr. | — |
| | adapter passend voor serie 630 Eurosit | | | |
|  | bestelnr. | 110357 | fabrikantnr. | — |
| | gaskraanas as ø 8x6,5mm as L 36/12mm passend voor serie 630 Eurosit | | | |
|  | bestelnr. | 110358 | fabrikantnr. | — |
| | adapter as ø 10x8mm as L 29/18mm passend voor serie 630 Eurosit | | | |







gasventielen en branderautomaten

gasregelventielen

SIT

NOVASIT



| bestelnr. | | 101187 | fabrikantnr. | 30100014 |
|---|--|--------|--------------|----------|
| omschrijving | | | | |
| gasventiel SIT serie Novasit 820 0.17VHz gasingang 1/2" gasuitgang 1/2" thermoelementaansluiting M9x1 waakvlamaansluiting M10x1 ontstekingsdrukbaar drukbereik 5-50mbar aansluiting voor drukregelaar blind vergelijkingsnr. 0.820.301 voedingsoperator Millivolt | | | | |
| Reparatie-onderdelen voor 101187 | | | | |
|  | bestelnr. | 101065 | fabrikantnr. | — |
| | magneetspoel met kabel L 44mm D1 ø 30mm D2 ø 20mm passend voor NOVASIT | | | |
| Toebehoren voor | | 101187 | | |
|  | bestelnr. | 100110 | fabrikantnr. | 30100000 |
| | waakvlambrander SIT type serie 190 3-vlammig sproeier ømm gasaansluitingmm | | | |
|  | bestelnr. | 101305 | fabrikantnr. | — |
| | gasaansluiting recht 1/2" flens 45x45mm ELETTROSIT/V4400/4600/4605 passend voor SIT/HONEYWELL LA 36x36mm | | | |
|  | bestelnr. | 101306 | fabrikantnr. | — |
| | gasaansluiting haaks flens 45x45mm LA 36x36mm 1/2" ELETTROSIT/V4400/4600/4605 schroefaansluiting met o-ring passend voor SIT/HONEYWELL | | | |
|  | bestelnr. | 101307 | fabrikantnr. | — |
| | gasaansluiting recht flens 45x45mm LA 36x36mm 3/4" ELETTROSIT/V4400/4600/4605 schroefaansluiting met o-ring passend voor SIT/HONEYWELL | | | |
|  | bestelnr. | 101308 | fabrikantnr. | — |
| | gasaansluiting haaks flens 45x45mm LA 36x36mm 3/4" ELETTROSIT/V4400/4600/4605 schroefaansluiting met o-ring passend voor SIT/HONEYWELL | | | |

Tabel wordt vervolgd op de volgende pagina





| | |
|---|--|
| Toebehoren voor | 101187 |
|  | bestelnr. 102116 fabrikantnr. 40400130 |
| | thermogenerator ROBERTSHAW L 900mm voeler ø 9mm voeler L 57mm 250-750mV schroefaansluiting 7/16" |





| | | | |
|---------------------|---|---------------------|----------|
| bestelnr. | 107833 | fabrikantnr. | 30100012 |
| omschrijving | gasventiel SIT serie Novasit 826 230V 50Hz gasingang 1/2" gasuitgang 1/2" waakvlamaansluiting gesloten drukbereik 2-50mbar aansluiting voor drukregelaar blind vergelijkingsnr. 0.826.010 | | |

| | |
|---|---|
| Reparatie-onderdelen voor | 107833 |
|  | bestelnr. 101542 fabrikantnr. — magneetspoel 50Hz NOVA 822/826/827 passend voor NOVASIT 230V |

| | |
|--|---|
| Toebehoren voor | 107833 |
|  | bestelnr. 101305 fabrikantnr. — gasaansluiting recht 1/2" flens 45x45mm ELETTROSIT/V4400/4600/4605 passend voor SIT/HONEYWELL LA 36x36mm |

| | |
|---|---|
|  | bestelnr. 101306 fabrikantnr. — gasaansluiting haaks flens 45x45mm LA 36x36mm 1/2" ELETTROSIT/V4400/4600/4605 schroefaansluiting met o-ring passend voor SIT/HONEYWELL |
|---|---|

| | |
|---|---|
|  | bestelnr. 101307 fabrikantnr. — gasaansluiting recht flens 45x45mm LA 36x36mm 3/4" ELETTROSIT/V4400/4600/4605 schroefaansluiting met o-ring passend voor SIT/HONEYWELL |
|---|---|

| | |
|---|---|
|  | bestelnr. 101308 fabrikantnr. — gasaansluiting haaks flens 45x45mm LA 36x36mm 3/4" ELETTROSIT/V4400/4600/4605 schroefaansluiting met o-ring passend voor SIT/HONEYWELL |
|---|---|

| | |
|---|---|
|  | bestelnr. 101859 fabrikantnr. — aansluitstekker met kabel L 1000mm voor gelijkrichter passend voor NOVASIT |
|---|---|

toebehoren



| | | | |
|---------------------|---|---------------------|----------|
| bestelnr. | 100110 | fabrikantnr. | 30100000 |
| omschrijving | waakvlambrander SIT type serie 190 3-vlamig sproeier ømm gasaansluitingmm | | |

| | |
|---|--|
| Toebehoren voor | 100110 |
|  | bestelnr. 100202 fabrikantnr. — waakvlaminspuiters aardgas identificatienummer 41 vpe 1stuk sproeier ø 0.41mm |

| | |
|---|---|
|  | bestelnr. 100203 fabrikantnr. — waakvlaminspuiters flessengas identificatienummer 25 vpe 1stuk sproeier ø 0.25mm |
|---|---|

| | |
|---|--|
|  | bestelnr. 100701 fabrikantnr. — bougie aansluiting M4 vpe 1stuk |
|---|--|

| | |
|--|--|
| Toebehoren voor | 100110 |
|  | bestelnr. 100906 fabrikantnr. — schroefconnectie draad M10x1 voor ontstekingsselektrode koper vpe 1stuk SB 10 |
|  | bestelnr. 100907 fabrikantnr. — schroefconnectie draad M10x1 vpe 1stuk type SEF 1 ømm voor thermokoppel |
|  | bestelnr. 100908 fabrikantnr. — knelschroef draad M10x1 voor pijpø 4mm vpe 1stuk |
|  | bestelnr. 100909 fabrikantnr. — knelschroef draad M10x1 voor pijpø 6mm vpe 1stuk |
|  | bestelnr. 101282 fabrikantnr. — snijring voor pijpø 4mm L 7.4mm vpe 1stuk |
|  | bestelnr. 101287 fabrikantnr. — snijring voor pijpø 6mm vpe 1stuk |
|  | bestelnr. 102110 fabrikantnr. — waakvlamleiding koper pijp ø 4mm dikte 1mm L 3000mm |
|  | bestelnr. 102111 fabrikantnr. — waakvlamleiding koper pijp ø 6mm dikte 1mm L 3000mm |
|  | bestelnr. 107650 fabrikantnr. 30500006 waakvlaminspuiters SIT flessengas identificatienummer 30 vpe 1stuk |

ontstekingstechniek

waakvlambranders

SIT

serie 100

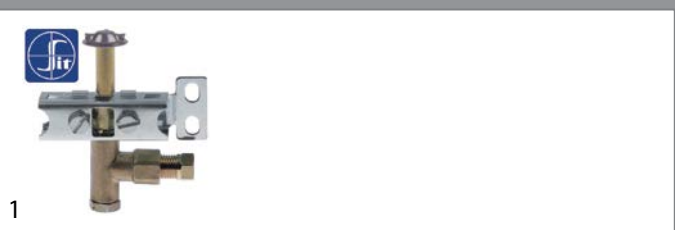



| | | | |
|------------------|--------|---------------------|----------|
| bestelnr. | 106906 | fabrikantnr. | 30100005 |
|------------------|--------|---------------------|----------|

| | | | |
|---------------------|---|--|--|
| omschrijving | waakvlambrander SIT type serie 100 3-vlamig sproeier ø 0.2mm gasaansluiting 6mm | | |
|---------------------|---|--|--|















| | | | |
|-----------------------|---|--|--|
| Voor modellen: | KP20GA-GIGA, KP20G-GIGA, KP20GTA-GIGA, KP20GT-GIGA, KP30GA-GIGA, KP30G-GIGA, KP30GTA-GIGA, KP30GT-GIGA, KP50GA-GIGA, KP50G-GIGA, KP50GTA-GIGA, KP50GT-GIGA, KPGN18G-GIGA, KPGN27G-GIGA, KPGN37G-GIGA, KPI20GA-GIGA, KPI20G-GIGA, KPI20GTA-GIGA, KPI20GT-GIGA, KPI30GA-GIGA, KPI30G-GIGA, KPI30GTA-GIGA, KPI30GT-GIGA, KPI50GA-GIGA, KPI50G-GIGA, KPI50GTA-GIGA, KPI50GT-GIGA, KPIGN18G-GIGA, KPIGN27G-GIGA, KPIGN37G-GIGA, PM9.G170GN-FAGOR, PM9.G270GN-FAGOR, PM9.G370GN-FAGOR | | |
|-----------------------|---|--|--|

| | |
|----------------------------------|--------|
| Reparatie-onderdelen voor | 106906 |
|----------------------------------|--------|

| | |
|---|---|
|  | bestelnr. 100245 fabrikantnr. 30500005 |
| | waakvlaminspuiters flessengas identificatienummer 20 boring ø 0.2mm vpe 1stuk draad M8x0,75 |

| | |
|---|----------------------------------|
|  | bestelnr. 100855 fabrikantnr. — |
| | waakvlambranderhouder drievoudig |



Tabel wordt vervolgd op de volgende pagina

| Reparatie-onderdelen voor 106906 | | | | |
|---|-----------|--------|--------------|----------|
|  | bestelnr. | 100885 | fabrikantnr. | — |
| mengkuls voor ontstekingsbrander vpe 1stuk | | | | |
|  | bestelnr. | 100916 | fabrikantnr. | — |
| drukveer voor ontstekingsbrander vpe 1stuk | | | | |
|  | bestelnr. | 100917 | fabrikantnr. | — |
| pakking voor ontstekingsbrander vpe 1stuk aluminium | | | | |
|  | bestelnr. | 100918 | fabrikantnr. | — |
| schroef voor ontstekingsbrander | | | | |
|  | bestelnr. | 107162 | fabrikantnr. | — |
| waakvlambrander bovendeel SIT 3-vlammig Hmm Lmm vpe 1stuk | | | | |
|  | bestelnr. | 107701 | fabrikantnr. | — |
| waakvlambranderonderstuk SIT serie 100 sproeier ø 0.2mm | | | | |
| Toebehoren voor 106906 | | | | |
|  | bestelnr. | 100245 | fabrikantnr. | 30500005 |
| waakvlaminspuiters flessengas identificatienummer 20 boring ø 0.2mm vpe 1stuk draad M8x0,75 | | | | |
|  | bestelnr. | 100246 | fabrikantnr. | — |
| waakvlaminspuiters aardgas boring ø 0.35mm vpe 1stuk draad M8x0,75 | | | | |
|  | bestelnr. | 100904 | fabrikantnr. | — |
| klemschroef M10x1 voor pijp ø 4mm vpe 1stuk | | | | |
|  | bestelnr. | 100905 | fabrikantnr. | — |
| klemschroef M10x1 voor pijp ø 6mm vpe 1stuk | | | | |
|  | bestelnr. | 102110 | fabrikantnr. | — |
| waakvlamleiding koper pijp ø 4mm dikte 1mm L 3000mm | | | | |
|  | bestelnr. | 102111 | fabrikantnr. | — |
| waakvlamleiding koper pijp ø 6mm dikte 1mm L 3000mm | | | | |
|  | bestelnr. | 107171 | fabrikantnr. | — |
| waakvlaminspuiters SIT aardgas/flessengas boring ø 0.25mm vpe 1stuk | | | | |
|  | bestelnr. | 107700 | fabrikantnr. | — |
| waakvlambranderonderstuk SIT serie 100 sproeier ø 0.25mm | | | | |
|  | bestelnr. | 107702 | fabrikantnr. | — |
| waakvlambranderonderstuk SIT serie 100 sproeier ø 0.35mm | | | | |

| toebehoren | | | |
|---|---|--------------|----------|
| waakvlambranderinspuiters | | | |
|  | 1 | | |
| bestelnr. | 102972 | fabrikantnr. | 30500003 |
| omschrijving | waakvlaminspuiters aardgas identificatienummer 40 boring ø 0.4mm vpe 1stuk | | |
| Voor modellen: | KP20GA-GIGA, KP20G-GIGA, KP20GTA-GIGA, KP20GT-GIGA, KP30GA-GIGA, KP30G-GIGA, KP30GTA-GIGA, KP30GT-GIGA, KP50GA-GIGA, KP50G-GIGA, KP50GTA-GIGA, KP50GT-GIGA, KPGN18G-GIGA, KPGN27G-GIGA, KPGN37G-GIGA, KPI20GA-GIGA, KPI20G-GIGA, KPI20GTA-GIGA, KPI20GT-GIGA, KPI30GA-GIGA, KPI30G-GIGA, KPI30GTA-GIGA, KPI30GT-GIGA, KPI50GA-GIGA, KPI50G-GIGA, KPI50GTA-GIGA, KPI50GT-GIGA, KPIGN18G-GIGA, KPIGN27G-GIGA, KPIGN37G-GIGA, PM9.G170GN-FAGOR, PM9.G270GN-FAGOR, PM9.G370GN-FAGOR | | |

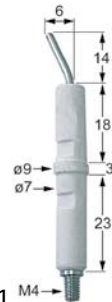







| | | | |
|---|---|--------------|----------|
|  | 1 | | |
| bestelnr. | 100245 | fabrikantnr. | 30500005 |
| omschrijving | waakvlaminspuiters flessengas identificatienummer 20 boring ø 0.2mm vpe 1stuk draad M8x0,75 | | |

| ontstekingselektroden | | | |
|--|---|--------------|----------|
|  | 1 | | |
| bestelnr. | 100706 | fabrikantnr. | 30100054 |
| omschrijving | bougie aansluiting M4 vpe 1stuk | | |
| Voor modellen: | KP20GA-GIGA, KP20G-GIGA, KP20GTA-GIGA, KP20GT-GIGA, KP30GA-GIGA, KP30G-GIGA, KP30GTA-GIGA, KP30GT-GIGA, KP50GA-GIGA, KP50G-GIGA, KP50GTA-GIGA, KP50GT-GIGA, KPGN18G-GIGA, KPGN27G-GIGA, KPGN37G-GIGA, KPI20GA-GIGA, KPI20G-GIGA, KPI20GTA-GIGA, KPI20GT-GIGA, KPI30GA-GIGA, KPI30G-GIGA, KPI30GTA-GIGA, KPI30GT-GIGA, KPI50GA-GIGA, KPI50G-GIGA, KPI50GTA-GIGA, KPI50GT-GIGA, KPIGN18G-GIGA, KPIGN27G-GIGA, KPIGN37G-GIGA | | |

| serie 190 | | | | |
|--|--|--------------|--------------|---|
|  | 1 | | | |
| bestelnr. | 100110 | fabrikantnr. | 30100000 | |
| omschrijving | waakvlambrander SIT type serie 190 3-vlammig sproeier ømm gasaansluitingmm | | | |
| Toebehoren voor | 100110 | | | |
|  | bestelnr. | 100202 | fabrikantnr. | — |
| waakvlaminspuiters aardgas identificatienummer 41 vpe 1stuk sproeier ø 0.41mm | | | | |
|  | bestelnr. | 100203 | fabrikantnr. | — |
| waakvlaminspuiters flessengas identificatienummer 25 vpe 1stuk sproeier ø 0.25mm | | | | |

Tabel wordt vervolgd op de volgende pagina



| | |
|--|---|
| Toebehoren voor | 100110 |
|  | bestelnr. 100701 fabrikantnr. — bougie aansluiting M4 vpe 1stuk |
|  | bestelnr. 100906 fabrikantnr. — schroefconnectie draad M10x1 voor ontstekingselektrode koper vpe 1stuk SB 10 |
|  | bestelnr. 100907 fabrikantnr. — schroefconnectie draad M10x1 vpe 1stuk type SEF 1 ømm voor thermokoppel |
|  | bestelnr. 100908 fabrikantnr. — knelschroef draad M10x1 voor pijpø 4mm vpe 1stuk |
|  | bestelnr. 100909 fabrikantnr. — knelschroef draad M10x1 voor pijpø 6mm vpe 1stuk |
|  | bestelnr. 101282 fabrikantnr. — snijring voor pijpø 4mm L 7.4mm vpe 1stuk |
|  | bestelnr. 101287 fabrikantnr. — snijring voor pijpø 6mm vpe 1stuk |
|  | bestelnr. 102110 fabrikantnr. — waakvlamleiding koper pijp ø 4mm dikte 1mm L 3000mm |
|  | bestelnr. 102111 fabrikantnr. — waakvlamleiding koper pijp ø 6mm dikte 1mm L 3000mm |
|  | bestelnr. 107650 fabrikantnr. 30500006 waakvlaminspuitser SIT flessengas identificatienummer 30 vpe 1stuk |

| | |
|---|--|
|  | bestelnr. 100709 fabrikantnr. 30100050 |
| omschrijving | bougie D1 ø 7mm D2 ø 9mm aansluiting M4 L1 13mm L2 13mm L3 23mm LL1 18mm LL2 3mm LL3 23mm voor het klemmen |
| Voor modellen: | PM9.G170GN-FAGOR, PM9.G270GN-FAGOR, PM9.G370GN-FAGOR |

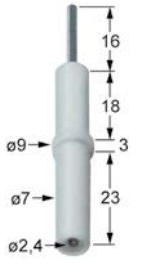
| | |
|---|--|
|  | bestelnr. 102330 fabrikantnr. 30100052 |
| omschrijving | bougie D1 ø 7mm D2 ø 9mm L1 16mm LL1 18mm LL2 3mm LL3 23mm voor het klemmen aansluit ø 2.4mm |

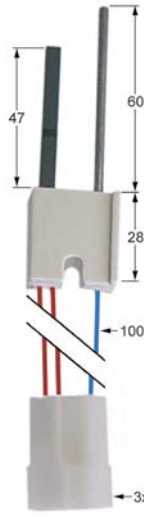
| | |
|---|--|
|  | bestelnr. 100730 fabrikantnr. 30100032/1 |
| omschrijving | gloeiplug kabellengte 100mm aansluiting ø2,4mm L1 47mm L2 60mm |

elektroden

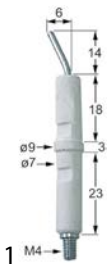
| | |
|---|---|
|  | bestelnr. 100706 fabrikantnr. 30100054 |
| omschrijving | bougie aansluiting M4 vpe 1stuk |
| Voor modellen: | KP20GA-GIGA, KP20G-GIGA, KP20GTA-GIGA, KP20GT-GIGA, KP30GA-GIGA, KP30G-GIGA, KP30GTA-GIGA, KP30GT-GIGA, KP50GA-GIGA, KP50G-GIGA, KP50GTA-GIGA, KP50GT-GIGA, KPGN18G-GIGA, KPGN27G-GIGA, KPGN37G-GIGA, KPI20GA-GIGA, KPI20G-GIGA, KPI20GTA-GIGA, KPI20GT-GIGA, KPI30GA-GIGA, KPI30G-GIGA, KPI30GTA-GIGA, KPI30GT-GIGA, KPI50GA-GIGA, KPI50G-GIGA, KPI50GTA-GIGA, KPI50GT-GIGA, KPIGN18G-GIGA, KPIGN27G-GIGA, KPIGN37G-GIGA |

piëzo-ontstekers

inbouwdiameter 22mm



| | | | |
|------------------------|---|---------------------|----------|
| bestelnr. | 100013 | fabrikantnr. | 40100130 |
| omschrijving | piëzo-ontsteker behuizing kunststof drukkend inbouw ø 22mm aansluiting ø2,4mm kabellengtemm | | |
| Voor modellen: | KP20GA-GIGA, KP20G-GIGA, KP20GTA-GIGA, KP20GT-GIGA, KP30GA-GIGA, KP30G-GIGA, KP30GTA-GIGA, KP30GT-GIGA, KP50GA-GIGA, KP50G-GIGA, KP50GTA-GIGA, KP50GT-GIGA, KPGN18G-GIGA, KPGN27G-GIGA, KPGN37G-GIGA, KPI20GA-GIGA, KPI20G-GIGA, KPI20GTA-GIGA, KPI20GT-GIGA, KPI30GA-GIGA, KPI30G-GIGA, KPI30GTA-GIGA, KPI30GT-GIGA, KPI50GA-GIGA, KPI50G-GIGA, KPI50GTA-GIGA, KPI50GT-GIGA, KPIGN18G-GIGA, KPIGN27G-GIGA, KPIGN37G-GIGA | | |
| Toebehoren voor | 100013 | | |
| |  | bestelnr. | 100023 |
| | | fabrikantnr. | — |
| | rondstekerhuls grootte 2.3mm 0,5-1,5mm ² CuZn t.max. 125°C vpe 20stuk | | |

ontstekingschakelaars



| | | | |
|-----------------------|--|---------------------|----------|
| bestelnr. | 345038 | fabrikantnr. | 40100034 |
| omschrijving | drukschakelaar tastend inbouw ø 25mm zwart 2NO 250V 16A aansluiting vlaksteker 6,3mm omgevingstemperatuur max. 85°C bescherming IP40 | | |
| Voor modellen: | PM9.G170GN-FAGOR, PM9.G270GN-FAGOR, PM9.G370GN-FAGOR | | |



| | | | |
|---------------------|---|---------------------|-------------------------------|
| bestelnr. | 107783 | fabrikantnr. | 40100132 40100132+10500092 |
| omschrijving | ontstekingschakelaar passend batterijtype AA 1.5V inbouw ø 22mm inbouwdiepte 68mm aansluiting F 2,8 bevestigingsafstandmm maat 98x58x35mm uitgangen 1 | | |

thermokoppels

insteekthermokoppels

insteekthermokoppels standaard

met steekhuls ø6(6,5)mm

thermokoppels SIT

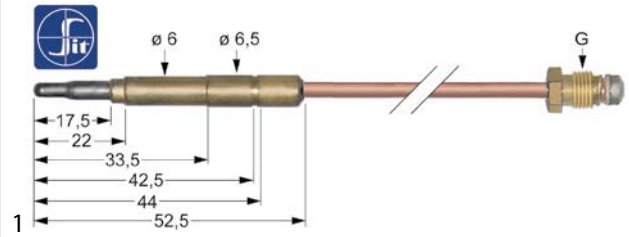

| | | | |
|-----------------------|---|---------------------|----------|
| bestelnr. | 107612 | fabrikantnr. | 40400100 |
| omschrijving | thermokoppel SIT M9x1 L 1000mm steekhuls ø6,0(6,5)mm | | |
| Voor modellen: | KP20GA-GIGA, KP20G-GIGA, KP20GTA-GIGA, KP20GT-GIGA, KP30GA-GIGA, KP30G-GIGA, KP30GTA-GIGA, KP30GT-GIGA, KP50GA-GIGA, KP50G-GIGA, KP50GTA-GIGA, KP50GT-GIGA, KPGN18G-GIGA, KPGN27G-GIGA, KPGN37G-GIGA, KPI20GA-GIGA, KPI20G-GIGA, KPI20GTA-GIGA, KPI20GT-GIGA, KPI30GA-GIGA, KPI30G-GIGA, KPI30GTA-GIGA, KPI30GT-GIGA, KPI50GA-GIGA, KPI50G-GIGA, KPI50GTA-GIGA, KPI50GT-GIGA, KPIGN18G-GIGA, KPIGN27G-GIGA, KPIGN37G-GIGA, PM9.G170GN-FAGOR, PM9.G270GN-FAGOR, PM9.G370GN-FAGOR | | |

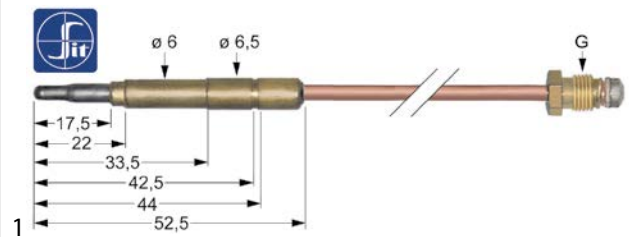

| | | | |
|---------------------|---|---------------------|----------|
| bestelnr. | 107611 | fabrikantnr. | 40400110 |
| omschrijving | thermokoppel SIT M9x1 L 850mm steekhuls ø6,0(6,5)mm | | |

thermogeneratoren

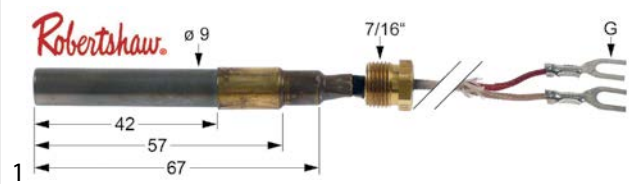

| | | | |
|---------------------|--|---------------------|----------|
| bestelnr. | 102116 | fabrikantnr. | 40400130 |
| omschrijving | thermogenerator ROBERTSHAW L 900mm voeler ø 9mm voeler L 57mm 250-750mV schroefaansluiting 7/16" | | |



gasbranders

staafbranders

staafbranders



| | | | |
|---------------------|--|---------------------|----------|
| bestelnr. | 105481 | fabrikantnr. | 30400060 |
| omschrijving | staafbrander ø 40mm Bmm Hmm L 325mm flens ø 61mm kantel braadpan | | |



| | | | |
|---------------------|--|---------------------|----------|
| bestelnr. | 105482 | fabrikantnr. | 30400050 |
| omschrijving | staafbrander ø 40mm Bmm Hmm L 396mm flens ø 61mm kantel braadpan | | |



| | | | |
|---------------------|---|---------------------|----------------------|
| bestelnr. | 105257 | fabrikantnr. | 30400050 old version |
| omschrijving | staafbrander ø 40mm Bmm Hmm L 397mm kookketel flens ø 61mm bevestigingsafstand 45mm | | |

gasinspuiters

waakvlambranderinspuiters

waakvlambranderinspuiters SIT

serie 100



| | | | |
|---------------------|--|---------------------|----------|
| bestelnr. | 102972 | fabrikantnr. | 30500003 |
| omschrijving | waakvlaminspuitter aardgas identificatienummer 40 boring ø 0.4mm vpe 1stuk | | |

| | | | |
|-----------------------|---|--|--|
| Voor modellen: | KP20GA-GIGA, KP20G-GIGA, KP20GTA-GIGA, KP20GT-GIGA, KP30GA-GIGA, KP30G-GIGA, KP30GTA-GIGA, KP30GT-GIGA, KP50GA-GIGA, KP50G-GIGA, KP50GTA-GIGA, KP50GT-GIGA, KPGN18G-GIGA, KPGN27G-GIGA, KPGN37G-GIGA, KPI20GA-GIGA, KPI20G-GIGA, KPI20GTA-GIGA, KPI20GT-GIGA, KPI30GA-GIGA, KPI30G-GIGA, KPI30GTA-GIGA, KPI30GT-GIGA, KPI50GA-GIGA, KPI50G-GIGA, KPI50GTA-GIGA, KPI50GT-GIGA, KPIGN18G-GIGA, KPIGN27G-GIGA, KPIGN37G-GIGA, PM9.G170GN-FAGOR, PM9.G270GN-FAGOR, PM9.G370GN-FAGOR | | |
|-----------------------|---|--|--|



| | | | |
|---------------------|---|---------------------|----------|
| bestelnr. | 100245 | fabrikantnr. | 30500005 |
| omschrijving | waakvlaminspuitter flessengas identificatienummer 20 boring ø 0.2mm vpe 1stuk draad M8x0,75 | | |

serie 160



| | | | |
|---------------------|--|---------------------|----------|
| bestelnr. | 107175 | fabrikantnr. | 30500007 |
| omschrijving | waakvlaminspuitter SIT aardgas identificatienummer 51 vpe 1stuk passend voor serie 160 | | |



| | | | |
|---------------------|--|---------------------|----------|
| bestelnr. | 107650 | fabrikantnr. | 30500006 |
| omschrijving | waakvlaminspuitter SIT flessengas identificatienummer 30 vpe 1stuk | | |

apparaatspecifieke bouwdeelen

voor deegkneedmachines

flenslagers

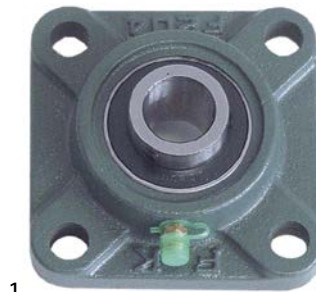

| | | | |
|---------------------|--|---------------------|----------|
| bestelnr. | 693112 | fabrikantnr. | 20400012 |
| omschrijving | flenslager type UCF204 schacht ø 20mm 4-gatsflens LA 64mm H 33mm flens L 86mm flens B 86mm gat ø 12mm flens F204 kogellager UC204G2 flenshoogte 25.5mm | | |

voor kantelbare braadpannen

assen



| | | | |
|---------------------|---------------------------|---------------------|------------------------|
| bestelnr. | 693110 | fabrikantnr. | SMB012800 SMB129-00 |
| omschrijving | draadstang L 363mm ø 20mm | | |

diversen

| | | | |
|---------------------|---|---------------------|-----------|
| 1 |  | | |
| bestelnr. | 693111 | fabrikantnr. | SMB013000 |
| omschrijving | as | | |

| | | | |
|---------------------|---|---------------------|-----------|
| 1 |  | | |
| bestelnr. | 693114 | fabrikantnr. | SMB063000 |
| omschrijving | as | | |

| | | | |
|---------------------|---|---------------------|-----------------------------|
| 1 |  | | |
| bestelnr. | 693109 | fabrikantnr. | SC02200 SC02200+10300042 |
| omschrijving | schroefdraadbus voor kantelbare pan koper draad TR20x4 | | |

voor kookketels

filters

| | | | |
|-----------------------|--|---------------------|------------------------|
| 1 |  | | |
| bestelnr. | 514503 | fabrikantnr. | 30700122 FX30700122 |
| omschrijving | afvoerfilter voor kookketel grootte 76x145mm | | |
| Voor modellen: | KPI10ETA-GIGA, KPI10ET-GIGA, KPI10VTA-GIGA, KPI10VT-GIGA, KPI15ETA-GIGA, KPI15ET-GIGA, KPI15VTA-GIGA, KPI15VT-GIGA, PM9.G170GN-FAGOR, PM9.G270GN-FAGOR, PM9.G370GN-FAGOR | | |

diversen

| | | | |
|-----------------------|---|---------------------|----------|
| 1 |  | | |
| bestelnr. | 540639 | fabrikantnr. | 10400058 |
| omschrijving | verlenging | | |
| Voor modellen: | KPI10VTA-GIGA, KPI10VT-GIGA, KPI15VTA-GIGA, KPI15VT-GIGA, KPI20VTA-GIGA, KPI20VT-GIGA, KPI30VTA-GIGA, KPI30VT-GIGA, KPI50VTA-GIGA, KPI50VT-GIGA | | |

knoppen

fabrikantspecifieke knoppen

FIREX

| | | | |
|-----------------------|---|---------------------|----------|
| 1 |  | | |
| bestelnr. | 112571 | fabrikantnr. | 20200001 |
| omschrijving | knop gaskraan met ontstekingsvlam ø 65mm as ø 10x8mm afvlakking onder | | |
| Voor modellen: | KP20GA-GIGA, KP20G-GIGA, KP20GTA-GIGA, KP20GT-GIGA, KP30GA-GIGA, KP30G-GIGA, KP30GTA-GIGA, KP30GT-GIGA, KP50GA-GIGA, KP50G-GIGA, KP50GTA-GIGA, KP50GT-GIGA, KPGN18G-GIGA, KPGN27G-GIGA, KPGN37G-GIGA, KPI20GA-GIGA, KPI20G-GIGA, KPI20GTA-GIGA, KPI20GT-GIGA, KPI30GA-GIGA, KPI30G-GIGA, KPI30GTA-GIGA, KPI30GT-GIGA, KPI50GA-GIGA, KPI50G-GIGA, KPI50GTA-GIGA, KPI50GT-GIGA, KPIGN18G-GIGA, KPIGN27G-GIGA, KPIGN37G-GIGA, PM9.G170GN-FAGOR, PM9.G270GN-FAGOR, PM9.G370GN-FAGOR | | |

grepen en draaiwielen

handwielen

| | | | |
|---------------------|---|---------------------|-----------|
| 1 |  | | |
| bestelnr. | 692443 | fabrikantnr. | SMB013600 |
| omschrijving | handwiel ø 150mm D1 ø 38mm boring ø 14mm draad groefbreedte 6mm groefdiepte 13mm bevestigingsafstand 18mm L1 40mm L2 43mm greep lengte 65mm met uittrekbaar handvat | | |

| | | | |
|---------------------|---|---------------------|-----------|
| 1 |  | | |
| bestelnr. | 692430 | fabrikantnr. | SMB063600 |
| omschrijving | handwiel ø 200mm D1 ø 50mm boring ø 20mm draad groefbreedte 6mm groefdiepte 13mm bevestigingsafstand 30mm L1 47mm L2 50mm greep lengte 90mm met uittrekbaar handvat | | |

kogelgrepen



| | | | |
|-----------------------|--|---------------------|----------|
| 1 | | | |
| bestelnr. | 540323 | fabrikantnr. | 20200013 |
| omschrijving | kogelgreep draad M10 ø 40mm met metalen bus zwart | | |
| Voor modellen: | KPI10ETA-GIGA, KPI10ET-GIGA, KPI15ETA-GIGA, KPI15ET-GIGA, KPI20ETA-GIGA, KPI20ET-GIGA, KPI20VTA-GIGA, KPI20VT-GIGA, KPI30ETA-GIGA, KPI30ET-GIGA, KPI30VTA-GIGA, KPI30VT-GIGA, KPI50ETA-GIGA, KPI50ET-GIGA, KPI50VTA-GIGA, KPI50VT-GIGA | | |

grootkeukenkranen

dekselscharnieren

type RUBINETTERIE DEL FRIULI

voor ronddeksels

reparatie-onderdelen



| | | | |
|---------------------|---|---------------------|----------|
| 1 | | | |
| bestelnr. | 540855 | fabrikantnr. | 20500046 |
| omschrijving | draaiveer ø 50.8mm draad ø 5.1mm L1 34mm L2 104mm L3 29mm inbouwpositie links | | |



| | | | |
|---------------------|--|---------------------|----------|
| 1 | | | |
| bestelnr. | 540854 | fabrikantnr. | 20500044 |
| omschrijving | draaiveer ø 50.8mm draad ø 5.1mm L1 34mm L2 104mm L3 29mm inbouwpositie rechts | | |

FIREX

dekselscharnieren



| | | | |
|-----------------------|--|---------------------|----------|
| 1 | | | |
| bestelnr. | 514412 | fabrikantnr. | 20300096 |
| omschrijving | dekselscharnier L 230mm bevestigingsafstand 1 150mm flensradius 320mm veerdikte 4mm voor ronddeksel | | |
| Voor modellen: | KPI10ETA-GIGA, KPI10ET-GIGA, KPI10VTA-GIGA, KPI10VT-GIGA, KPI15ETA-GIGA, KPI15ET-GIGA, KPI15VTA-GIGA, KPI15VT-GIGA | | |

| | | | | |
|----------------------------------|---|--------|---------------------|---|
| Reparatie-onderdelen voor | 514412 | | | |
| | bestelnr. | 540846 | fabrikantnr. | — |
| | draaiveer ø 42.5mm draad ø 4.1mm L1 93mm L2 26mm L3 26mm inbouwpositie links | | | |
| | bestelnr. | 540847 | fabrikantnr. | — |
| | draaiveer ø 42.5mm draad ø 4.1mm L1 93mm L2 26mm L3 26mm inbouwpositie rechts | | | |



| | | | |
|-----------------------|--|---------------------|----------|
| 1 | | | |
| bestelnr. | 514413 | fabrikantnr. | 20300086 |
| omschrijving | dekselscharnier L 270mm bevestigingsafstand 1 139mm flensradius 395mm veerdikte 5mm boring ø M15mm voor ronddeksel | | |
| Voor modellen: | KP20GA-GIGA, KP20G-GIGA, KP20GTA-GIGA, KP20GT-GIGA, KP30GA-GIGA, KP30G-GIGA, KP30GTA-GIGA, KP30GT-GIGA, KP50GA-GIGA, KP50G-GIGA, KP50GTA-GIGA, KP50GT-GIGA, KPI20EA-GIGA, KPI20E-GIGA, KPI20ET-GIGA, KPI20GA-GIGA, KPI20G-GIGA, KPI20GTA-GIGA, KPI20GT-GIGA, KPI20VTA-GIGA, KPI20VT-GIGA, KPI30EA-GIGA, KPI30E-GIGA, KPI30GA-GIGA, KPI30G-GIGA, KPI30GTA-GIGA, KPI30GT-GIGA, KPI50EA-GIGA, KPI50E-GIGA, KPI50GA-GIGA, KPI50G-GIGA, KPI50GTA-GIGA, KPI50GT-GIGA | | |

| | | | | |
|----------------------------------|--|--------|---------------------|----------|
| Reparatie-onderdelen voor | 514413 | | | |
| | bestelnr. | 540854 | fabrikantnr. | 20500044 |
| | draaiveer ø 50.8mm draad ø 5.1mm L1 34mm L2 104mm L3 29mm inbouwpositie rechts | | | |
| | bestelnr. | 540855 | fabrikantnr. | 20500046 |
| | draaiveer ø 50.8mm draad ø 5.1mm L1 34mm L2 104mm L3 29mm inbouwpositie links | | | |

| | | | |
|---|--|---------------------|-----------------------|
|  | | | |
| 1 | | | |
| bestelnr. | 514414 | fabrikantnr. | 20300108 |
| omschrijving | dekselscharnier L 270mm bevestigingsafstand 1 139mm flensradius 470mm veerdikte 6mm boring ø M15mm voor ronddeksel | | |
| Voor modellen: | KPI30ET-GIGA, KPI30VTA-GIGA, KPI30VT-GIGA, KPI50ET-GIGA, KPI50VTA-GIGA, KPI50VT-GIGA | | |
| Reparatie-onderdelen voor | 514414 | | |
|  | bestelnr. | 540856 | fabrikantnr. — |
| | draai veer ø 52mm draad ø 6.2mm L1 30mm L2 95mm L3 30mm inbouwpositie rechts | | |
|  | bestelnr. | 540857 | fabrikantnr. — |
| | draai veer ø 52mm draad ø 6.2mm L1 30mm L2 95mm L3 30mm inbouwpositie links | | |

reparatie-onderdelen

| | | | |
|--|--|---------------------|----------|
|  | | | |
| 1 | | | |
| bestelnr. | 540855 | fabrikantnr. | 20500046 |
| omschrijving | draai veer ø 50.8mm draad ø 5.1mm L1 34mm L2 104mm L3 29mm inbouwpositie links | | |

| | | | |
|---|---|---------------------|----------|
|  | | | |
| 1 | | | |
| bestelnr. | 540854 | fabrikantnr. | 20500044 |
| omschrijving | draai veer ø 50.8mm draad ø 5.1mm L1 34mm L2 104mm L3 29mm inbouwpositie rechts | | |

ICOS

| | | | |
|---|--|---------------------|----------|
|  | | | |
| 1 | | | |
| bestelnr. | 540855 | fabrikantnr. | 20500046 |
| omschrijving | draai veer ø 50.8mm draad ø 5.1mm L1 34mm L2 104mm L3 29mm inbouwpositie links | | |

| | | | |
|--|---|---------------------|----------|
|  | | | |
| 1 | | | |
| bestelnr. | 540854 | fabrikantnr. | 20500044 |
| omschrijving | draai veer ø 50.8mm draad ø 5.1mm L1 34mm L2 104mm L3 29mm inbouwpositie rechts | | |

dekselsluitingen

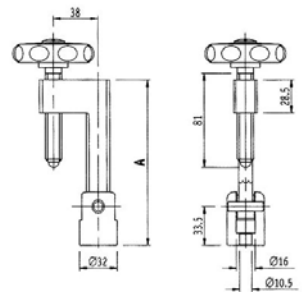
| | | | |
|--|--|---------------------|----------|
|   | | | |
| 1 | | | |
| bestelnr. | 514127 | fabrikantnr. | 20300093 |
| omschrijving | dekselsluiting greep ø 70mm L 143mm | | |
| Voor modellen: | KP20GA-GIGA, KP20GTA-GIGA, KP30GA-GIGA, KP30GTA-GIGA, KP50GA-GIGA, KP50GTA-GIGA, KPI10ETA-GIGA, KPI10VTA-GIGA, KPI15ETA-GIGA, KPI15VTA-GIGA, KPI20EA-GIGA, KPI20ETA-GIGA, KPI20GA-GIGA, KPI20GTA-GIGA, KPI20VTA-GIGA, KPI20VT-GIGA, KPI30EA-GIGA, KPI30ETA-GIGA, KPI30GA-GIGA, KPI30GTA-GIGA, KPI30VTA-GIGA, KPI30VT-GIGA, KPI50EA-GIGA, KPI50ETA-GIGA, KPI50GA-GIGA, KPI50GTA-GIGA, KPI50VTA-GIGA, KPI50VT-GIGA | | |

toevoerkranen

| | | | |
|--|--------------|---------------------|----------|
|  | | | |
| 1 | | | |
| bestelnr. | 693108 | fabrikantnr. | 30200005 |
| omschrijving | afsluitkraan | | |

aftapkranen

messing

aftapkranen



1

| | | | |
|---------------------|--|---------------------|----------|
| bestelnr. | 540275 | fabrikantnr. | 30200198 |
| omschrijving | aftapkraan 2" ID met flensmoer A 90mm B 151mm B1 80mm messing verchroomd | | |

Voor modellen:

KP20GA-GIGA, KP20G-GIGA, KP20GTA-GIGA, KP20GT-GIGA, KP30GA-GIGA, KP30G-GIGA, KP30GTA-GIGA, KP30GT-GIGA, KP50GA-GIGA, KP50G-GIGA, KP50GTA-GIGA, KP50GT-GIGA, KPGN18G-GIGA, KPGN27G-GIGA, KPGN37G-GIGA, KPI10ETA-GIGA, KPI10E-GIGA, KPI10VTA-GIGA, KPI10VT-GIGA, KPI15ETA-GIGA, KPI15E-GIGA, KPI15VTA-GIGA, KPI15VT-GIGA, KPI20EA-GIGA, KPI20E-GIGA, KPI20ETA-GIGA, KPI20ET-GIGA, KPI20GA-GIGA, KPI20G-GIGA, KPI20GTA-GIGA, KPI20GT-GIGA, KPI20VTA-GIGA, KPI20VT-GIGA, KPI30EA-GIGA, KPI30E-GIGA, KPI30ETA-GIGA, KPI30ET-GIGA, KPI30GA-GIGA, KPI30G-GIGA, KPI30GTA-GIGA, KPI30GT-GIGA, KPI30VTA-GIGA, KPI30VT-GIGA, KPI50EA-GIGA, KPI50E-GIGA, KPI50ETA-GIGA, KPI50ET-GIGA, KPI50GA-GIGA, KPI50G-GIGA, KPI50GTA-GIGA...(Andere modellen die u kunt zien in de webshop)

Reparatie-onderdelen voor 540275

| | | | | |
|--|------------------|--------------------------|---------------------|---|
| | bestelnr. | 540214 | fabrikantnr. | — |
| | | handvat ID ø 6mm L 145mm | | |

Toebehoren voor 540275

| | | | | |
|--|------------------|--|---------------------|---|
| | bestelnr. | 529484 | fabrikantnr. | — |
| | | vlakpakking fiber OD ø 58mm ID ø 50mm materiaaldikte 2mm vpe 1stuk | | |

| | | | | |
|--|------------------|---|---------------------|---|
| | bestelnr. | 542448 | fabrikantnr. | — |
| | | pakking silicone 60x49x2 voor aftapkraan 2" | | |

toebehoren



1

| | | | |
|---------------------|---|---------------------|----------|
| bestelnr. | 540954 | fabrikantnr. | 10400009 |
| omschrijving | binnenhuls voor afvoer kraan draad 1 1/2" | | |



1

| | | | |
|-----------------------|--|---------------------|----------|
| bestelnr. | 540957 | fabrikantnr. | 10400006 |
| omschrijving | binnenhuls voor afvoer kraan draad 2" L 120mm | | |
| Voor modellen: | KPI10VTA-GIGA, KPI10VT-GIGA, KPI15VTA-GIGA, KPI15VT-GIGA | | |



1

| | | | |
|---------------------|---|---------------------|----------|
| bestelnr. | 540956 | fabrikantnr. | 10500062 |
| omschrijving | pakking voor afvoer kraan slang buiten ø 46mm ID ø 38mm H 2mm | | |



1

| | | | |
|---------------------|---|---------------------|----------|
| bestelnr. | 540959 | fabrikantnr. | 10500060 |
| omschrijving | pakking voor afvoer kraan slang buiten ø 60mm ID ø 50mm H 2mm | | |

Voor modellen:

KP20GA-GIGA, KP20G-GIGA, KP20GTA-GIGA, KP20GT-GIGA, KP30GA-GIGA, KP30G-GIGA, KP30GTA-GIGA, KP30GT-GIGA, KP50GA-GIGA, KP50G-GIGA, KP50GTA-GIGA, KP50GT-GIGA, KPGN18G-GIGA, KPGN27G-GIGA, KPGN37G-GIGA, KPI10ETA-GIGA, KPI10E-GIGA, KPI10VTA-GIGA, KPI10VT-GIGA, KPI15ETA-GIGA, KPI15E-GIGA, KPI15VTA-GIGA, KPI15VT-GIGA, KPI20EA-GIGA, KPI20E-GIGA, KPI20ETA-GIGA, KPI20ET-GIGA, KPI20GA-GIGA, KPI20G-GIGA, KPI20GTA-GIGA, KPI20GT-GIGA, KPI20VTA-GIGA, KPI20VT-GIGA, KPI30EA-GIGA, KPI30E-GIGA, KPI30ETA-GIGA, KPI30ET-GIGA, KPI30GA-GIGA, KPI30G-GIGA, KPI30GTA-GIGA, KPI30GT-GIGA, KPI30VTA-GIGA, KPI30VT-GIGA, KPI50EA-GIGA, KPI50E-GIGA, KPI50ETA-GIGA, KPI50ET-GIGA, KPI50GA-GIGA, KPI50G-GIGA, KPI50GTA-GIGA...(Andere modellen die u kunt zien in de webshop)



1

| | | | |
|---------------------|--------------------------------------|---------------------|----------|
| bestelnr. | 540955 | fabrikantnr. | 10200004 |
| omschrijving | rozet voor afvoer kraan draad 1 1/2" | | |



1

| | | | |
|-----------------------|---|---------------------|----------|
| bestelnr. | 540958 | fabrikantnr. | 10200002 |
| omschrijving | rozet voor afvoerkraan slang buiten ø 120mm ID ø 60mm H 13mm | | |
| Voor modellen: | KP20GA-GIGA, KP20G-GIGA, KP20GTA-GIGA, KP20GT-GIGA, KP30GA-GIGA, KP30G-GIGA, KP30GTA-GIGA, KP30GT-GIGA, KP50GA-GIGA, KP50G-GIGA, KP50GTA-GIGA, KP50GT-GIGA, KPGN18G-GIGA, KPGN27G-GIGA, KPGN37G-GIGA, KPI10ETA-GIGA, KPI10ET-GIGA, KPI10VTA-GIGA, KPI10VT-GIGA, KPI15ETA-GIGA, KPI15ET-GIGA, KPI15VTA-GIGA, KPI15VT-GIGA, KPI20EA-GIGA, KPI20E-GIGA, KPI20ETA-GIGA, KPI20ET-GIGA, KPI20GA-GIGA, KPI20G-GIGA, KPI20GTA-GIGA, KPI20GT-GIGA, KPI20VTA-GIGA, KPI20VT-GIGA, KPI30EA-GIGA, KPI30E-GIGA, KPI30ETA-GIGA, KPI30ET-GIGA, KPI30GA-GIGA, KPI30G-GIGA, KPI30GTA-GIGA, KPI30GT-GIGA, KPI30VTA-GIGA, KPI30VT-GIGA, KPI50EA-GIGA, KPI50E-GIGA, KPI50ETA-GIGA, KPI50ET-GIGA, KPI50GA-GIGA, KPI50G-GIGA, KPI50GTA-GIGA... (Andere modellen die u kunt zien in de webshop) | | |

veiligheids armaturen

toebehoren



1

| | | | |
|---|---|---------------------|---------------------|
| bestelnr. | 540835 | fabrikantnr. | 10400061 |
| omschrijving | schroefkap draad 3/4" | | |
| Voor modellen: | KP20GTA-GIGA, KP20GT-GIGA, KP30GTA-GIGA, KP30GT-GIGA, KP50GTA-GIGA, KP50GT-GIGA, KPI10ETA-GIGA, KPI10ET-GIGA, KPI15ETA-GIGA, KPI15ET-GIGA, KPI20EA-GIGA, KPI20E-GIGA, KPI20ETA-GIGA, KPI20ET-GIGA, KPI20GA-GIGA, KPI20G-GIGA, KPI20GTA-GIGA, KPI20GT-GIGA, KPI30EA-GIGA, KPI30E-GIGA, KPI30ETA-GIGA, KPI30ET-GIGA, KPI30GA-GIGA, KPI30G-GIGA, KPI30GTA-GIGA, KPI30GT-GIGA, KPI30VTA-GIGA, KPI30VT-GIGA, KPI50EA-GIGA, KPI50E-GIGA, KPI50ETA-GIGA, KPI50ET-GIGA, KPI50GA-GIGA, KPI50G-GIGA, KPI50GTA-GIGA, KPI50GT-GIGA, KPIGN37G-GIGA, PM9.G170GN-FAGOR, PM9.G270GN-FAGOR, PM9.G370GN-FAGOR | | |
| Reparatie-onderdelen voor | 540835 | | |
| | bestelnr. | 513016 | fabrikantnr. |
|  | O-ring EPDM materiaaldikte 3.53mm ID ø 26.58mm vpe 1stuk | | |
| Toebehoren voor | 540835 | | |
| | bestelnr. | 513016 | fabrikantnr. |
|  | O-ring EPDM materiaaldikte 3.53mm ID ø 26.58mm vpe 1stuk | | |

veiligheidsventielen



1

| | | | |
|-----------------------|---|---------------------|----------|
| bestelnr. | 540722 | fabrikantnr. | 30300026 |
| omschrijving | veiligheidsventiel met uitgang voor deksel | | |
| Voor modellen: | KPI10ETA-GIGA, KPI15ETA-GIGA, KPI20ETA-GIGA, KPI30ETA-GIGA, KPI50ETA-GIGA | | |



1

| | | | |
|-----------------------|---|---------------------|----------------------------------|
| bestelnr. | 514415 | fabrikantnr. | 30300018 30300024 30300026 |
| omschrijving | veiligheidsventiel voor kookketel draad M33 | | |
| Voor modellen: | KP20GA-GIGA, KP20GTA-GIGA, KP30GA-GIGA, KP30GTA-GIGA, KP50GA-GIGA, KP50GTA-GIGA, KPI10VTA-GIGA, KPI10VT-GIGA, KPI15VTA-GIGA, KPI15VT-GIGA, KPI20EA-GIGA, KPI20E-GIGA, KPI20ETA-GIGA, KPI20ET-GIGA, KPI20GA-GIGA, KPI20G-GIGA, KPI20GTA-GIGA, KPI20GT-GIGA, KPI20VTA-GIGA, KPI20VT-GIGA, KPI30EA-GIGA, KPI30E-GIGA, KPI30ETA-GIGA, KPI30ET-GIGA, KPI30GA-GIGA, KPI30G-GIGA, KPI30GTA-GIGA, KPI30GT-GIGA, KPI30VTA-GIGA, KPI30VT-GIGA, KPI50EA-GIGA, KPI50E-GIGA, KPI50ETA-GIGA, KPI50ET-GIGA, KPI50GA-GIGA, KPI50G-GIGA, KPI50GTA-GIGA, KPI50GT-GIGA | | |

rubbers

thermische pakkingen

kookketel pakkingen

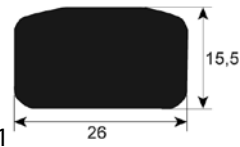

1

| | | | |
|-----------------------|--|---------------------|----------|
| bestelnr. | 900819 | fabrikantnr. | 10600300 |
| omschrijving | kookketelpakking profiel 3010 L 1000mm | | |
| Voor modellen: | KP20GA-GIGA, KP20GTA-GIGA, KP30GA-GIGA, KP30GTA-GIGA, KP50GA-GIGA, KP50GTA-GIGA, KPI10ETA-GIGA, KPI10VTA-GIGA, KPI15ETA-GIGA, KPI15VTA-GIGA, KPI20EA-GIGA, KPI20GA-GIGA, KPI20GTA-GIGA, KPI30EA-GIGA, KPI30GA-GIGA, KPI30GTA-GIGA, KPI50EA-GIGA, KPI50GA-GIGA, KPI50GTA-GIGA | | |

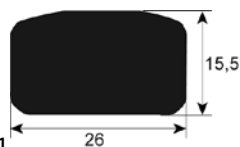

1

| | | | |
|-----------------------|--|---------------------|------------|
| bestelnr. | 900821 | fabrikantnr. | 10600300/1 |
| omschrijving | kookketelpakking profiel 3010 L 2000mm | | |
| Voor modellen: | KPI10ETA-GIGA, KPI10VTA-GIGA, KPI15ETA-GIGA, KPI15VTA-GIGA | | |



| | | | |
|-----------------------|--|---------------------|------------|
| bestelnr. | 900822 | fabrikantnr. | 10600300/2 |
| omschrijving | kookketelpakking profiel 3010 L 2400mm | | |
| Voor modellen: | KPI20ETA-GIGA, KPI20VTA-GIGA | | |

| | | | |
|-----------------------|--|---------------------|------------|
| bestelnr. | 900823 | fabrikantnr. | 10600300/3 |
| omschrijving | kookketelpakking profiel 3010 L 3000mm | | |
| Voor modellen: | KPI30ETA-GIGA, KPI30VTA-GIGA, KPI50ETA-GIGA, KPI50VTA-GIGA | | |

o-ringen

EPDM

| | | | |
|-----------------------|--|---------------------|----------|
| bestelnr. | 511937 | fabrikantnr. | 10500110 |
| omschrijving | O-ring EPDM materiaaldikte 3.53mm ID ø 28.17mm vpe 1stuk | | |
| Voor modellen: | KP20GTA-GIGA, KP20GT-GIGA, KP30GTA-GIGA, KP30GT-GIGA, KP50GTA-GIGA, KP50GT-GIGA, KPI10ETA-GIGA, KPI10ET-GIGA, KPI15ETA-GIGA, KPI15ET-GIGA, KPI20EA-GIGA, KPI20E-GIGA, KPI20ETA-GIGA, KPI20ET-GIGA, KPI20GA-GIGA, KPI20G-GIGA, KPI20GTA-GIGA, KPI20GT-GIGA, KPI30EA-GIGA, KPI30E-GIGA, KPI30ETA-GIGA, KPI30ET-GIGA, KPI30GA-GIGA, KPI30G-GIGA, KPI30GTA-GIGA, KPI30GT-GIGA, KPI50EA-GIGA, KPI50E-GIGA, KPI50ETA-GIGA, KPI50ET-GIGA, KPI50GA-GIGA, KPI50G-GIGA, KPI50GTA-GIGA, KPI50GT-GIGA, KPIGN37G-GIGA, PM9.G170GN-FAGOR, PM9.G270GN-FAGOR, PM9.G370GN-FAGOR | | |

aandrijfstechniek en kogellagers

kogellagers

flenslagers

| | | | |
|---------------------|--|---------------------|----------|
| bestelnr. | 693112 | fabrikantnr. | 20400012 |
| omschrijving | flenslager type UCF204 schacht ø 20mm 4-gatsflens LA 64mm H 33mm flens L 86mm flens B 86mm gat ø 12mm flens F204 kogellager UC204G2 flenshoogte 25.5mm | | |

veren

torsieveren

| | | | |
|---------------------|---|---------------------|----------|
| bestelnr. | 540855 | fabrikantnr. | 20500046 |
| omschrijving | draaiveer ø 50.8mm draad ø 5.1mm L1 34mm L2 104mm L3 29mm inbouwpositie links | | |

| | | | |
|---------------------|--|---------------------|----------|
| bestelnr. | 540854 | fabrikantnr. | 20500044 |
| omschrijving | draaiveer ø 50.8mm draad ø 5.1mm L1 34mm L2 104mm L3 29mm inbouwpositie rechts | | |

gasdrukveren

gasdrukveren

| | | | |
|---------------------|---|---------------------|----------|
| bestelnr. | 698322 | fabrikantnr. | 20300270 |
| omschrijving | gasdrukveer 882.5N stam 100mm D1 ø 22mm D2 ø 10mm LA 300mm gat ø 8/10mm L 315mm | | |

manometers

| | | | | |
|----------------------------------|---|---------------------|---------------------|---|
| bestelnr. | 541062 | fabrikantnr. | 30300022 | |
| omschrijving | manometer ø 63mm drukkereik 0 tot 1bar aansluiting markering instelbaar kookketel draad 1/4" | | | |
| Voor modellen: | KP20GTA-GIGA, KP20GT-GIGA, KP30GTA-GIGA, KP30GT-GIGA, KP50GTA-GIGA, KP50GT-GIGA, KPI10ETA-GIGA, KPI10ET-GIGA, KPI15ETA-GIGA, KPI15ET-GIGA, KPI20EA-GIGA, KPI20E-GIGA, KPI20ETA-GIGA, KPI20ET-GIGA, KPI20GA-GIGA, KPI20G-GIGA, KPI20GTA-GIGA, KPI20GT-GIGA, KPI20VTA-GIGA, KPI20VT-GIGA, KPI30EA-GIGA, KPI30E-GIGA, KPI30ETA-GIGA, KPI30ET-GIGA, KPI30GA-GIGA, KPI30G-GIGA, KPI30GTA-GIGA, KPI30GT-GIGA, KPI30VTA-GIGA, KPI30VT-GIGA, KPI50EA-GIGA, KPI50E-GIGA, KPI50ETA-GIGA, KPI50ET-GIGA, KPI50GA-GIGA, KPI50G-GIGA, KPI50GTA-GIGA, KPI50GT-GIGA, KPI50VTA-GIGA, KPI50VT-GIGA, KPIGN37G-GIGA, PM9.G170GN-FAGOR, PM9.G270GN-FAGOR, PM9.G370GN-FAGOR | | | |
| Reparatie-onderdelen voor | 541062 | | | |
| | bestelnr. | 541130 | fabrikantnr. | — |
| | glasplaat ø 58mm dikte 2mm | | | |



ventielen en containerinlaten

afsluitkranen

universeel



1

| | | | |
|---|---|---------------------|-----------------------|
| bestelnr. | 693107 | fabrikantnr. | 30200008 |
| omschrijving | afsluitkraan aansluiting 1/2" 1/2" koud totale lengte 54mm L1 27mm L2 30mm markering blauw roset draad G2 26x19G aansluit ø M4x0,7 IDmm | | |
| Reparatie-onderdelen voor | 693107 | | |
|  | bestelnr. | 514085 | fabrikantnr. — |
| | roset aansluiting 26x19G verchroomd totale lengtemm inbouwpositie | | |
|  | bestelnr. | 514086 | fabrikantnr. — |
| | zeskantmoer aansluiting 26x19G koper totale lengtemm inbouwpositie H 6mm SB 34 vpe 1stuk | | |
|  | bestelnr. | 540672 | fabrikantnr. — |
| | pakking passend voor bovendeeel | | |
|  | bestelnr. | 547711 | fabrikantnr. — |
| | kapgriep asafname ø 8mm markering blauw metaal H2 21mm D1 ø 33mm type D passend voor MONOLITH aslengte H1 8mm | | |
|  | bestelnr. | 548168 | fabrikantnr. — |
| | stergriep aansluiting warm totale lengtemm inbouwpositie ø 57mm markering rood | | |
|  | bestelnr. | 548169 | fabrikantnr. — |
| | stergriep aansluiting koud totale lengtemm inbouwpositie verchroomd ø 57mm | | |
| Toebehoren voor | 693107 | | |
|  | bestelnr. | 514086 | fabrikantnr. — |
| | zeskantmoer aansluiting 26x19G koper totale lengtemm inbouwpositie H 6mm SB 34 vpe 1stuk | | |

verbruiksmaterialen

zekeringen

glaszekeringen



1

| | | | |
|-----------------------|---|---------------------|----------|
| bestelnr. | 358605 | fabrikantnr. | 40200084 |
| omschrijving | fijnzekering grootte ø5x20mm 3.15A traag maximale spanning 250V vpe 10stuk | | |
| Voor modellen: | KPI10ETA-GIGA, KPI10ET-GIGA, KPI15ETA-GIGA, KPI15ET-GI- GA | | |

| | | | |
|---------------------------------------|----|-------------------------------|-------|
| A | | | |
| afsluitkranen | 20 | thermokoppels | 12 |
| D | | thermostaten | 4 |
| dompelelementen | 3 | timers | 6 |
| drukschakelaar/-knoppen | 5 | V | |
| E | | ventielen en containerinlaten | 20 |
| elementen voor kantelbare braadpannen | 3 | verbruiksmaterialen | 20 |
| G | | verwarmingselementen | 3 |
| gasbranders | 13 | W | |
| gasinspuiters | 13 | waakvlambranders | 9 |
| gaskranen | 7 | Z | |
| gasregelventielen | 8 | zekeringen | 6, 20 |
| gasthermostaten | 8 | | |
| glaszekeringen | 20 | | |
| K | | | |
| kookketel pakkingen | 18 | | |
| L | | | |
| lampen | 5 | | |
| M | | | |
| magneetventielen | 6 | | |
| maximaal thermostaten | 4 | | |
| mechanische timers | 6 | | |
| microschakelaars | 5 | | |
| N | | | |
| nokkenschakelaars | 5 | | |
| O | | | |
| ontstekingsschakelaars | 12 | | |
| o-ringen | 19 | | |
| P | | | |
| piëzo-ontstekers | 12 | | |
| R | | | |
| regelthermostaten | 4 | | |
| relais | 6 | | |
| S | | | |
| schakelaars en tasters | 5 | | |
| signaallampen | 5 | | |
| signaallampen compleet | 6 | | |
| staafbranders | 13 | | |
| T | | | |
| thermische pakkingen | 18 | | |