



GAS



ELEKTRO



WASSER



MECHANIK



WERKZEUG

Ersatzteile passend für

FOEM

Das komplette Sortiment finden Sie immer aktuell im GEV-Webshop

Hersteller-Kataloge

Für jeden Hersteller die wichtigsten Ersatz- und Zubehörteile übersichtlich zusammengestellt



- ✓ **Komplettes Sortiment und alle Gerätedaten immer aktuell im GEV-Webshop**
- ✓ **Alphabetischer Index am Ende des Katalog**

GEV-Webshop

www.gev-online.de

www.gev-online.ch



- 🔍 Artikel als Favoriten markieren
- 🔍 Einloggen mit E-Mail-Adresse und gewohntem Passwort
- 🔍 Komfort-Bestellung – mehrere Artikel gleichzeitig in den Warenkorb legen
- 🔍 Sofort Artikel suchen ohne Anmeldung



Kochplatten

quadratisch + rechteckig

kippar



1

GEV-Nr.	490085	Vergl.-Nr.	05010080750
Beschreibung	Kochplatte Maße 300x300mm 2500W 230V mit Gussrand Kippkochplatte Anschluss 3 Schraubklemmen H 43mm quadratisch		



1

GEV-Nr.	490089	Vergl.-Nr.	05010080850
Beschreibung	Kochplatte Maße 300x300mm 4000W 230V mit Gussrand Kippkochplatte Anschluss 4 Schraubklemmen H 43mm quadratisch		

Thermostate

Regel- und Sicherheitsthermostate

EGO

Regelthermostate

Serie 51_



1

GEV-Nr.	390070	Vergl.-Nr.	390070
Beschreibung	Thermostat T.max. 265°C Arbeitsbereich 55-265°C 1-polig 1NO 15A Fühler ø 3mm Fühler L 219mm Kapillarrohr 2000mm Stopfbuchse Achse ø 6x4,6mm Achslänge 23mm Achsstellung oben° Drehwinkel 270° Fühlermaterial CNS		

Serie 55.10/19_



1

GEV-Nr.	375004	Vergl.-Nr.	05000087150
Beschreibung	Thermostat T.max. 211°C Arbeitsbereich 35-200°C 1-polig 1CO 16A Fühler ø 6mm Fühler L 74mm Kapillarrohr 1500mm Kapillarrohr isoliertmm Stopfbuchse Achslänge 23mm Achsstellung oben Drehwinkel 270° Fühlermaterial CNS		

Serie 55.13_



1

GEV-Nr.	375505	Vergl.-Nr.	03051500140
Beschreibung	Thermostat T.max. 320°C Arbeitsbereich 50-320°C 1-polig 1NO 16A Fühler ø 3mm Fühler L 160mm Kapillarrohr 870mm Kapillarrohr isoliertmm Stopfbuchse Achse ø 6x4,6mm Achslänge 23mm Achsstellung oben Drehwinkel 270°		

Serie 55.34_



1

GEV-Nr.	375410	Vergl.-Nr.	05050033650
Beschreibung	Thermostat T.max. 180°C Arbeitsbereich 95-180°C 3-polig 3NO 16A Fühler ø 6mm Fühler L 133mm Kapillarrohr 1780mm Kapillarrohr isoliert 1400mm Stopfbuchse M10x1 Achse ø 6x4,6mm Achslänge 23mm Achsstellung oben Drehwinkel 270°		



GEV-Nr.	375412	Vergl.-Nr.	05000087350
Beschreibung	Thermostat T.max. 320°C Arbeitsbereich 50-320°C 3-polig 3NO 16A Fühler ø 3.1mm Fühler L 226mm Kapillarrohr 1480mm Kapillarrohr isoliert 1400mm Stopfbuchse Achse ø 6x4,6mm Achslänge 23mm Achsstellung oben Drehwinkel 318°		



GEV-Nr.	375411	Vergl.-Nr.	05000087250
Beschreibung	Thermostat T.max. 93°C Arbeitsbereich 30-93°C 3-polig 3NO 16A Fühler ø 6mm Fühler L 129mm Kapillarrohr 1480mm Kapillarrohr isoliert 1100mm Stopfbuchse M10x1 Achse ø 6x4,6mm Achslänge 23mm Achsstellung oben Drehwinkel 270°		

Sicherheitsthermostate

Serie 55.10/19_

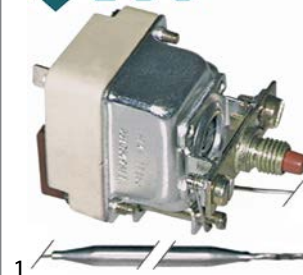

GEV-Nr.	390060	Vergl.-Nr.	05750107250	
Beschreibung	Sicherheitsthermostat Abschalttemp. 230°C 1-polig 0.5A Fühler CNS Fühler ø 6mm Fühler L 77mm Kapillarrohr 870mm Kapillarrohr isoliertmm Stopfbuchse			
Zubehör für	390060			
	GEV-Nr.	551083	Vergl.-Nr.	—
	Kappe für Sicherheitsthermostat Gewinde M8x1			

Schalter und Taster

Nockenschalter



4-Takt



GEV-Nr.	300103	Vergl.-Nr.	05010049940 05010078050
Beschreibung	Nockenschalter 4 Schaltstellungen 1NO/2CO Schaltfolge 0-1-2-3 32A Achse ø 6x4,6mm Achslänge 23mm Anschluss Schraubanschluss Keramik		

7-Takt



GEV-Nr.	300025	Vergl.-Nr.	05000083150	
Beschreibung	Nockenschalter 7 Schaltstellungen 1NO/2CO Schaltfolge 0-1-2-3-4-5-6 16A Achse ø 6x4,6mm Achslänge 23mm Anschluss Schraubanschluss 7-Takt Keramik			
Zubehör für	300025			
	GEV-Nr.	112172	Vergl.-Nr.	—
	Knebel universal ø 70mm schwarz ohne Adapter/Symbol			
	GEV-Nr.	112213	Vergl.-Nr.	—
	Knebelsymbol silber Schalter 7-Takt T.max.°C AD ø 63mm ID ø 45.5mm			
	GEV-Nr.	112311	Vergl.-Nr.	—
	Knebeladapter Achse ø 6x4,6mm L 0mm mit Feder			



GEV-Nr.	300106	Vergl.-Nr.	05010076150
Beschreibung	Nockenschalter 7 Schaltstellungen 1NO/2CO Schaltfolge 0-1-2-3-4-5-6 32A Achse ø 6x4,6mm Achslänge 23mm Anschluss Schraubanschluss 7-Takt Abflachung oben		

Timer

Zeitschalter mechanisch

			
1			
GEV-Nr.	350049	Vergl.-Nr.	305000080050
Beschreibung	Zeitschalter M2 mit Glocke 2-polig Laufzeit 30min Antrieb mechanisch 2NO bei 250V 16A Dauerstellung Ja Achse \varnothing 6x4,6mm Achse 6x4,6mm Achslänge 23mm BA 28mm Anschluss seitlich		
Zubehör für	350049		
	GEV-Nr.	110366	Vergl.-Nr. —
	Knebel Schalter Nullstrich T.max.°C°C \varnothing 44mm Achse \varnothing 6x4,6mm Abflachung oben schwarz		
	GEV-Nr.	111205	Vergl.-Nr. —
	Skalenscheibe Einteilung 30min Dauerstellung Ja Drehwinkel 30-300° \varnothing 60mm		

Ersatzteile und Zubehör

Knebel

			
1			
GEV-Nr.	110365	Vergl.-Nr.	30500004050
Beschreibung	Knebel Schalter Nullstrich T.max.°C°C \varnothing 44mm Achse \varnothing 3,5x3,5mm Abflachung schwarz		

Gashähne

PEL

Serie 20S

			
1			
GEV-Nr.	101068	Vergl.-Nr.	05010014700
Beschreibung	Gashahn PEL Typ 20S Gaseingang M16x1,5 (Rohr- \varnothing 10mm) KBD \varnothing 0,2mm Gasausgang 1/4" (Rohr- \varnothing 6mm) Thermoelementanschluss M8x1 Zündflammenanschluss Achse \varnothing 8x6,5mm Achslänge 22/15mm Abflachung oben Umbausatz Rohr \varnothing 10mm		
Ersatzteile für	101068		
	GEV-Nr.	101060	Vergl.-Nr. —
	Magneteinsatz Standard L 39mm D1 \varnothing 15,4mm D2 \varnothing 11mm passend für PEL20-21/JUNKERS/EGA		
	GEV-Nr.	101205	Vergl.-Nr. —
	Gashahnvorderteil Achse \varnothing 8x6,5mm Achslänge 22/15mm Abflachung oben/unten passend für PEL20		

Ersatzteile für	101068		
	GEV-Nr.	101230	Vergl.-Nr. —
	Thermoelementmutter G1: M8x1 G2: M18x1 Aluminium		
	GEV-Nr.	101278	Vergl.-Nr. —
	Schneidring für Rohr- \varnothing 10mm VPE 1 Stück		
	GEV-Nr.	101300	Vergl.-Nr. —
	Überwurfmutter Gewinde M16x1,5 Rohr \varnothing 10mm		
Zubehör für	101068		
	GEV-Nr.	110081	Vergl.-Nr. —
	Knebel \varnothing 70mm Achse \varnothing 8x6,5mm Abflachung universal		
	GEV-Nr.	110083	Vergl.-Nr. —
	Knebelsymbol Gashahn ohne Zündflamme silber		

Serie 22S/V

			
1			
GEV-Nr.	101087	Vergl.-Nr.	05000070930
Beschreibung	Gashahn PEL Typ 22S/V Gaseingang M20x1,5 (Rohr- \varnothing 12mm) KBD \varnothing 0,35mm Gasausgang M20x1,5 (Rohr- \varnothing 12/10mm) Thermoelementanschluss M9x1 Zündflammenanschluss M10x1 Achse \varnothing 10x8mm Achslänge 25/17mm Abflachung oben		
Ersatzteile für	101087		
	GEV-Nr.	100259	Vergl.-Nr. —
	Kleinbranddüse Typ PEL22 Bohrung \varnothing 0,35mm Gewinde M6x0,5		
	GEV-Nr.	101058	Vergl.-Nr. —
	Magneteinsatz L 39mm D1 \varnothing 15,4mm D2 \varnothing 13,5mm passend für PEL22/EGA24197 Standard		
	GEV-Nr.	101201	Vergl.-Nr. —
	Gashahnvorderteil Achse \varnothing 10x8mm Achslänge 25/17mm Abflachung oben/unten passend für PEL22		
	GEV-Nr.	101231	Vergl.-Nr. —
	Thermoelementmutter G1: M9x1 G2: M18x1		
	GEV-Nr.	101241	Vergl.-Nr. —
	Gasanschluss Gewinde M20x1,5 Rohr \varnothing 12/10mm für PEL-Gashähne vertikal		
	GEV-Nr.	101460	Vergl.-Nr. —
	O-Ring \varnothing 12,37mm D1 \varnothing 2,62mm passend für PEL22		
	GEV-Nr.	101461	Vergl.-Nr. —
	Schraube Kit passend für PEL22 VPE 4 Stück		
Zubehör für	101087		
	GEV-Nr.	100908	Vergl.-Nr. —
	Überwurfschraube Gewinde M10x1 für Rohr- \varnothing 4mm VPE 1 Stück		
	GEV-Nr.	100909	Vergl.-Nr. —
	Überwurfschraube Gewinde M10x1 für Rohr- \varnothing 6mm VPE 1 Stück		

Tabellenfortsetzung auf der nächsten Seite









Zubehör für	101087	GEV-Nr.	101240	Vergl.-Nr.	—
	Gasanschluss Gewinde M20x1,5 Rohr ø 12/10mm für PEL-Gashähne mit Dichtung und Schrauben horizontal	GEV-Nr.	101246	Vergl.-Nr.	—
	Schneidring für Rohr-ø 4mm VPE 1 Stück	GEV-Nr.	101248	Vergl.-Nr.	—
	Schneidring für Rohr-ø 12mm VPE 1 Stück passend für PEL	GEV-Nr.	101249	Vergl.-Nr.	—
	Schneidring für Rohr-ø 10mm VPE 1 Stück	GEV-Nr.	101250	Vergl.-Nr.	—
	Überwurfmutter Gewinde M20x1,5 für Rohr ø 10mm	GEV-Nr.	101251	Vergl.-Nr.	—
	Überwurfmutter Gewinde M20x1,5 für Rohr ø 12mm	GEV-Nr.	101286	Vergl.-Nr.	—
	Schneidring ID ø 6mm VPE 1 Stück	GEV-Nr.	110080	Vergl.-Nr.	—
	Knebel ø 70mm Achse ø 10x8mm Abflachung universal	GEV-Nr.	112206	Vergl.-Nr.	—
	Knebelsymbol silber Gashahn PEL21/22/23 T.max.°C AD ø 63mm ID ø 45.5mm				

Serie 23S/O



1



GEV-Nr.	101092	Vergl.-Nr.	05030043730
Beschreibung	Gashahn PEL Typ 23S/O Gaseingang M28x1,5 (Rohr-ø 20mm) KBD ø 0.35mm Gasausgang M24x1,5 (Rohr-ø 16mm) Thermoelementanschluss M10x1 Zündflammenanschluss M10x1 Achse ø 10x8mm Achslänge 25/17mm Abflachung oben		
Ersatzteile für	101092	GEV-Nr.	100455
	Kleinbranddüse Typ PEL23/24 Bohrung ø 0.35mm Gewinde M8x0,5	GEV-Nr.	101059
	Magneteinsatz G1: M10x1 G2: M22x1 L 46mm ø 18mm passend für PEL23S M10x1	GEV-Nr.	101204
	Gashahnvorderteil Achse ø 10x8mm Achslänge 25/17mm Abflachung oben/unten passend für PEL23S	GEV-Nr.	101244
	Gasanschluss Gewinde M24x1,5 Rohr ø 12/16mm horizontal für PEL-Gashähne	GEV-Nr.	101463
	Schraube passend für PEL23S VPE 4 Stück	GEV-Nr.	528455
	O-Ring Viton Materialstärke 2.62mm ID ø 18.72mm VPE 1 Stück		

Zubehör für	101092	GEV-Nr.	100908	Vergl.-Nr.	—
	Überwurfschraube Gewinde M10x1 für Rohr-ø 4mm VPE 1 Stück	GEV-Nr.	100909	Vergl.-Nr.	—
	Überwurfschraube Gewinde M10x1 für Rohr-ø 6mm VPE 1 Stück	GEV-Nr.	101246	Vergl.-Nr.	—
	Schneidring für Rohr-ø 4mm VPE 1 Stück	GEV-Nr.	101252	Vergl.-Nr.	—
	Überwurfmutter Gewinde M24x1,5 für Rohr ø 12mm	GEV-Nr.	101253	Vergl.-Nr.	—
	Überwurfmutter Gewinde M24x1,5 PEL für Rohr ø 16mm	GEV-Nr.	101254	Vergl.-Nr.	—
	Überwurfmutter Gewinde M28x1,5 Rohr ø 20mm	GEV-Nr.	101255	Vergl.-Nr.	—
	Schneidring für Rohr-ø 12mm VPE 1 Stück	GEV-Nr.	101256	Vergl.-Nr.	—
	Schneidring für Rohr-ø 16mm VPE 1 Stück	GEV-Nr.	101257	Vergl.-Nr.	—
	Schneidring für Rohr-ø 20mm VPE 1 Stück	GEV-Nr.	101286	Vergl.-Nr.	—
	Schneidring ID ø 6mm VPE 1 Stück	GEV-Nr.	110080	Vergl.-Nr.	—
	Knebel ø 70mm Achse ø 10x8mm Abflachung universal	GEV-Nr.	112206	Vergl.-Nr.	—
	Knebelsymbol silber Gashahn PEL21/22/23 T.max.°C AD ø 63mm ID ø 45.5mm				

JUNKERS



1

GEV-Nr.	nml ¹	Vergl.-Nr.	05000029000
Beschreibung	Gashahn JUNKERS Typ CH110 Gaseingang M20x1,5 KBD ø 0.35mm Gasausgang M20x1,5 Thermoelementanschluss M8x1 Zündflammenanschluss M10x1 Achse ø 10mm Achslänge 20.7mm Abflachung Rohrausgang ø 12/10mm		
Ersatzteile für	101096	GEV-Nr.	101060
	Magneteinsatz Standard L 39mm D1 ø 15.4mm D2 ø 11mm passend für PEL20-21/JUNKERS/EGA	GEV-Nr.	101230
	Thermoelementmutter G1: M8x1 G2: M18x1 Aluminium		

¹nicht mehr lieferbar
Tabellenfortsetzung auf der nächsten Seite



Zubehör für		101096		
	GEV-Nr.	100945	Vergl.-Nr.	—
Spannstift ø 3.2mm L 10mm				
	GEV-Nr.	101219	Vergl.-Nr.	—
Achsverlängerung L 25mm JUNKERS				
	GEV-Nr.	101233	Vergl.-Nr.	—
Überwurfmutter Gewinde M10x1 JUNKERS				
	GEV-Nr.	101281	Vergl.-Nr.	—
Schneidring für Rohr-ø 4mm L 8.7mm VPE 1 Stück passend für CB 502/503				
	GEV-Nr.	101284	Vergl.-Nr.	—
Schneidring für Rohr-ø 4mm VPE 1 Stück				
	GEV-Nr.	101285	Vergl.-Nr.	—
Überwurfschraube Gewinde M8x1 für Rohr-ø 4mm VPE 1 Stück JUNKERS				
	GEV-Nr.	110064	Vergl.-Nr.	—
Knebel				
	GEV-Nr.	110066	Vergl.-Nr.	—
Knebelschraube				
	GEV-Nr.	550396	Vergl.-Nr.	—
Achsverlängerung L 25mm JUNKERS				





Zubehör für		101132		
	GEV-Nr.	100905	Vergl.-Nr.	—
Klemmschraube M10x1 für Rohr-ø 6mm VPE 1 Stück				
	GEV-Nr.	101054	Vergl.-Nr.	—
Magneteinsatz G1: M10x1 G2: M24x1 L 45mm ø 17mm passend für Minisit				
	GEV-Nr.	101136	Vergl.-Nr.	—
Piezozünder passend für Minisit mit Abdeckkappe ømm Anschluss F6,3x0,8				
	GEV-Nr.	101137	Vergl.-Nr.	05010014700
Abdeckkappe ohne Piezozünder				
	GEV-Nr.	101267	Vergl.-Nr.	—
Reduzierung IG 3/8" AG 1/2" L 21mm				
	GEV-Nr.	101268	Vergl.-Nr.	—
Gasanschluss Gewinde 3/8" gewinkelt mit O-Ring MINISIT 710				
	GEV-Nr.	101269	Vergl.-Nr.	—
Gasanschluss Gewinde 1/2" gewinkelt mit O-Ring MINISIT 710				
	GEV-Nr.	101270	Vergl.-Nr.	—
Verschraubung IG 3/8" AG 3/8" L 28mm				
	GEV-Nr.	101272	Vergl.-Nr.	—
Verschraubung IG 1/2" AG 3/8" L 57mm				
	GEV-Nr.	101273	Vergl.-Nr.	—
Schneidring für Rohr-ø 12mm L 9.5mm Messing VPE 1 Stück passend für universal				
	GEV-Nr.	101274	Vergl.-Nr.	—
Schneidring für Rohr-ø 16mm VPE 1 Stück				
	GEV-Nr.	101275	Vergl.-Nr.	—
Überwurfschraube Gewinde 1/2" für Rohr-ø 16mm VPE 1 Stück				
	GEV-Nr.	101276	Vergl.-Nr.	—
Überwurfschraube Gewinde 3/8" Rohr ø 12mm VPE 1 Stück				
	GEV-Nr.	110068	Vergl.-Nr.	—
Knebel passend für Minisit ø 37mm				

Gasthermostate

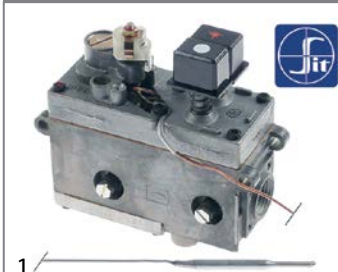
SIT

Serie 710 Minisit



GEV-Nr.	101132	Vergl.-Nr.	05010014700	
Beschreibung	Gasthermostat SIT Typ MINISIT 710 T.max. 340°C 100-340°C Gaseingang 1/2" Gasausgang 3/8" Thermoelementanschluss M9x1 Zündflammenanschluss M10x1 Fühler ø 5mm Fühler L 68mm Kapillarrohr 1050mm Sensortyp Typ B1 Druckregler Nein Druckreglerbar Stopfbuchse Zündgas Nein			
Ersatzteile für	101132			
	GEV-Nr.	101053	Vergl.-Nr.	—
Magneteinsatz G1: M9x1 G2: M24x1 L 45mm ø 17mm passend für Minisit				
	GEV-Nr.	102102	Vergl.-Nr.	—
Fühler 100-340°C Fühler ø 5mm Fühler L 68mm Kapillarrohr 1750mm T.max. 340°C Backofen/Grill Sensortyp Typ B1 passend für MINISIT 710				
Zubehör für	101132			
	GEV-Nr.	100809	Vergl.-Nr.	—
O-Ring EPDM Materialstärke 2mm ID ø 21mm VPE 1 Stück				
	GEV-Nr.	100904	Vergl.-Nr.	—
Klemmschraube M10x1 für Rohr-ø 4mm VPE 1 Stück				

Gasventile und Gasfeuerungsautomaten







Gasregelventile

SIT

ELETTROSIT



1

GEV-Nr.	101126	Vergl.-Nr.	305150036150
Beschreibung	Gasventil SIT Typ ELETTROSIT 230V Gaseingang 1/2" Gasausgang 1/2" Thermoelementanschluss M9x1 Zündflammenanschluss M10x1 unten Vergl.-Nr. 0.810.136		
Ersatzteile für	101126		
	GEV-Nr.	101312	Vergl.-Nr. —
	Mikroschalter		
	GEV-Nr.	101352	Vergl.-Nr. —
	Magnetspule 230V 50Hz passend für ELETTROSIT		
Zubehör für	101126		
	GEV-Nr.	100006	Vergl.-Nr. —
	Piezozünder passend für ELETTROSIT Körper Kunststoff drückend Anschluss ø2,4mm ø 14mm		
	GEV-Nr.	100904	Vergl.-Nr. —
	Klemmschraube M10x1 für Rohr-ø 4mm VPE 1 Stück		
	GEV-Nr.	100905	Vergl.-Nr. —
	Klemmschraube M10x1 für Rohr-ø 6mm VPE 1 Stück		
	GEV-Nr.	101301	Vergl.-Nr. —
	Gasanschluss Gewinde 1/2" gerade ELETTROSIT Schraubanschluss mit O-Ring		
	GEV-Nr.	101303	Vergl.-Nr. —
	Gasanschluss gerade Gewinde 3/4" ELETTROSIT		
	GEV-Nr.	101309	Vergl.-Nr. —
	Verlängerung		

Zündtechnik

Zündbrenner

SIT

Serie 100



1

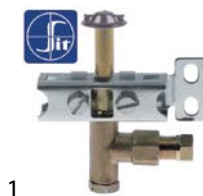

GEV-Nr.	106901	Vergl.-Nr.	05019906800
Beschreibung	Zündbrenner SIT Typ Serie 100 1-flammig Düse ø 0.2mm Gasanschluss 6mm		
Ersatzteile für	106901		
	GEV-Nr.	100854	Vergl.-Nr. —
	Zündbrennerhalter 2-fach		
	GEV-Nr.	100916	Vergl.-Nr. —
	Druckfeder für Zündbrenner VPE 1 Stück		
	GEV-Nr.	100917	Vergl.-Nr. —
	Dichtung für Zündbrenner VPE 1 Stück Aluminium		
	GEV-Nr.	100918	Vergl.-Nr. —
	Schraube für Zündbrenner		
Zubehör für	106901		
	GEV-Nr.	100904	Vergl.-Nr. —
	Klemmschraube M10x1 für Rohr-ø 4mm VPE 1 Stück		
	GEV-Nr.	100905	Vergl.-Nr. —
	Klemmschraube M10x1 für Rohr-ø 6mm VPE 1 Stück		
	GEV-Nr.	102110	Vergl.-Nr. —
	Zündgasleitung Kupfer Rohr ø 4mm Wandstärke 1mm L 3000mm		
	GEV-Nr.	102111	Vergl.-Nr. —
	Zündgasleitung Kupfer Rohr ø 6mm Wandstärke 1mm L 3000mm		
	GEV-Nr.	102742	Vergl.-Nr. —
	Zündbrennerdüse Flüssiggas Kennzahl 25 Bohrung ø 0.25mm VPE 1 Stück		



1

GEV-Nr.	106906	Vergl.-Nr.	05000010100 05000027300
Beschreibung	Zündbrenner SIT Typ Serie 100 3-flammig Düse ø 0.2mm Gasanschluss 6mm		
Ersatzteile für	106906		
	GEV-Nr.	100245	Vergl.-Nr. —
	Zündbrennerdüse Flüssiggas Kennzahl 20 Bohrung ø 0.2mm VPE 1 Stück Gewinde M8x0,75		

Tabellenfortsetzung auf der nächsten Seite

Ersatzteile für	106906		
	GEV-Nr.	100855	Vergl.-Nr. —
Zündbrennerhalter 3-fach			
	GEV-Nr.	100885	Vergl.-Nr. —
Luftmischhülse für Zündbrenner VPE 1 Stück			
	GEV-Nr.	100916	Vergl.-Nr. —
Druckfeder für Zündbrenner VPE 1 Stück			
	GEV-Nr.	100917	Vergl.-Nr. —
Dichtung für Zündbrenner VPE 1 Stück Aluminium			
	GEV-Nr.	100918	Vergl.-Nr. —
Schraube für Zündbrenner			
	GEV-Nr.	107162	Vergl.-Nr. —
Zündbrenneroberteil SIT 3-flammig Hmm Lmm VPE 1 Stück			
	GEV-Nr.	107701	Vergl.-Nr. —
Zündbrennerunterteil SIT Serie 100 Düse ø 0.2mm			
Zubehör für	106906		
	GEV-Nr.	100245	Vergl.-Nr. —
Zündbrennerdüse Flüssiggas Kennzahl 20 Bohrung ø 0.2mm VPE 1 Stück Gewinde M8x0,75			
	GEV-Nr.	100246	Vergl.-Nr. —
Zündbrennerdüse Erdgas Bohrung ø 0.35mm VPE 1 Stück Gewinde M8x0,75			
	GEV-Nr.	100904	Vergl.-Nr. —
Klemmschraube M10x1 für Rohr-ø 4mm VPE 1 Stück			
	GEV-Nr.	100905	Vergl.-Nr. —
Klemmschraube M10x1 für Rohr-ø 6mm VPE 1 Stück			
	GEV-Nr.	102110	Vergl.-Nr. —
Zündgasleitung Kupfer Rohr ø 4mm Wandstärke 1mm L 3000mm			
	GEV-Nr.	102111	Vergl.-Nr. —
Zündgasleitung Kupfer Rohr ø 6mm Wandstärke 1mm L 3000mm			
	GEV-Nr.	107171	Vergl.-Nr. —
Zündbrennerdüse SIT Erdgas/Flüssiggas Bohrung ø 0.25mm VPE 1 Stück			
	GEV-Nr.	107700	Vergl.-Nr. —
Zündbrennerunterteil SIT Serie 100 Düse ø 0.25mm			
	GEV-Nr.	107702	Vergl.-Nr. —
Zündbrennerunterteil SIT Serie 100 Düse ø 0.35mm			

Zubehör

Zünderlektroden

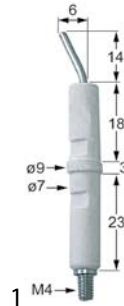

GEV-Nr.	100706	Vergl.-Nr.	05000078750
Beschreibung	Zünderlektrode Anschluss M4 VPE 1 Stück		



JUNKERS

Serie CB 503

Zündbrenner







GEV-Nr.	100101	Vergl.-Nr.	05010055800
Beschreibung	Zündbrenner JUNKERS Typ CB503003 Flüssiggas Düsentyp Nr.2 Gasanschluss 4mm mit Primärluft		

Ersatzteile für	100101		
	GEV-Nr.	100224	Vergl.-Nr. —
Zündbrennerdüse Erdgas Gasdruck 25mbar Kennzahl 26 VPE 1 Stück passend für JUNKERS CB503_			
	GEV-Nr.	101281	Vergl.-Nr. —
Schneidring für Rohr-ø 4mm L 8.7mm VPE 1 Stück passend für CB 502/503			
	GEV-Nr.	101283	Vergl.-Nr. —
Überwurfschraube Gewinde M10x1 für Rohr-ø 4mm VPE 1 Stück			

Zubehör für	100101		
	GEV-Nr.	100220	Vergl.-Nr. —
Zündbrennerdüse Flüssiggas Gasdruck 50mbar Kennzahl 2 VPE 1 Stück passend für JUNKERS CB503_			
	GEV-Nr.	100221	Vergl.-Nr. —
Zündbrennerdüse Flüssiggas Gasdruck 30mbar Kennzahl 29 VPE 1 Stück passend für JUNKERS CB50203_			
	GEV-Nr.	100222	Vergl.-Nr. —
Zündbrennerdüse Flüssiggas Gasdruck 50mbar Kennzahl 5 VPE 1 Stück passend für JUNKERS CB50203_			
	GEV-Nr.	100223	Vergl.-Nr. —
Zündbrennerdüse Erdgas Gasdruck 20mbar Kennzahl 3 VPE 1 Stück passend für JUNKERS CB503_			
	GEV-Nr.	100226	Vergl.-Nr. —
Zündbrennerdüse Flüssiggas Gasdruck 50mbar Kennzahl 15 passend für JUNKERS			
	GEV-Nr.	100227	Vergl.-Nr. —
Zündbrennerdüse Erdgas Gasdruck 25mbar Kennzahl 6 VPE 1 Stück passend für JUNKERS CB50203_			

Tabellenfortsetzung auf der nächsten Seite

Zubehör für	100101			
	GEV-Nr.	100228	Vergl.-Nr.	—
	Zündbrennerdüse Stadtgas Gasdruck 8mbar Kennzahl 4 VPE 1 Stück passend für JUNKERS CB50203_			
	GEV-Nr.	100909	Vergl.-Nr.	—
	Überwurfschraube Gewinde M10x1 für Rohr-ø 6mm VPE 1 Stück			
	GEV-Nr.	101287	Vergl.-Nr.	—
	Schneidering für Rohr-ø 6mm VPE 1 Stück			
	GEV-Nr.	102110	Vergl.-Nr.	—
	Zündgasleitung Kupfer Rohr ø 4mm Wandstärke 1mm L 3000mm			
	GEV-Nr.	102111	Vergl.-Nr.	—
	Zündgasleitung Kupfer Rohr ø 6mm Wandstärke 1mm L 3000mm			

Elektroden

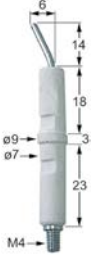
	GEV-Nr.	100706	Vergl.-Nr.	05000078750
	Beschreibung Zündelektrode Anschluss M4 VPE 1 Stück			

Zündkabel

Konfektionierte Kabel

	GEV-Nr.	100026	Vergl.-Nr.	05000080350
	Beschreibung Zündkabel Kabellänge 1000mm Anschluss ø4mm / F6,3mm			

Piezozünder

Einbaudurchmesser 18mm

	GEV-Nr.	100003	Vergl.-Nr.	05000080200
	Beschreibung Piezozünder Körper Metall drückend Einbau ø 18mm Anschluss F2,8x0,8			

Thermoelemente

Einsteckthermoelemente

Einsteckthermoelemente Standard

mit Stechhülse ø6(6,5)mm

Thermoelemente SIT

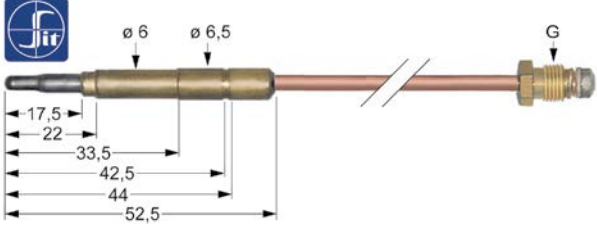
	GEV-Nr.	107619	Vergl.-Nr.	05050103900
	Beschreibung Thermoelement SIT M10x1 L 1000mm Stechhülse ø6,0(6,5)mm			

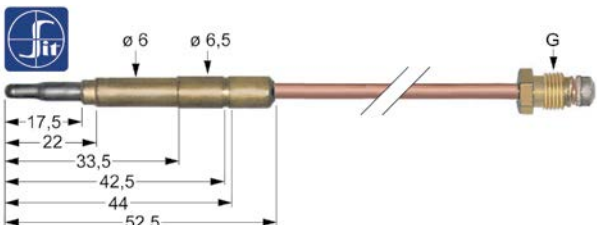
	GEV-Nr.	107613	Vergl.-Nr.	05000097100
	Beschreibung Thermoelement SIT M9x1 L 1200mm Stechhülse ø6,0(6,5)mm			

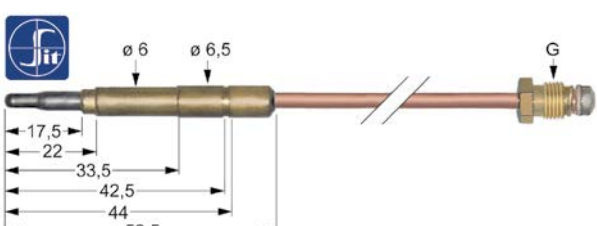
	GEV-Nr.	107614	Vergl.-Nr.	05000026900
	Beschreibung Thermoelement SIT M9x1 L 1500mm Stechhülse ø6,0(6,5)mm			

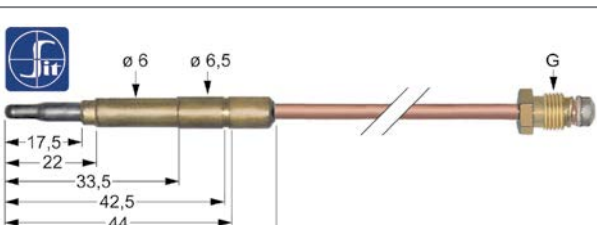
	GEV-Nr.	107606	Vergl.-Nr.	05021300200
	Beschreibung Thermoelement SIT M9x1 L 320mm Stechhülse ø6,0(6,5)mm			



GEV-Nr.	107611	Vergl.-Nr.	05019906600
Beschreibung	Thermoelement SIT M9x1 L 850mm Steckhülse ø6,0(6,5)mm		

Gasbrenner

Kochstellenbrenner

Herstellerspezifische Kochstellenbrenner

FOEM

Universal

GEV-Nr.	103046	Vergl.-Nr.	05000012530 050099108902
Beschreibung	Brennerdeckel ø 110mm mit Mittelloch		

GEV-Nr.	103045	Vergl.-Nr.	05000012630 05019909102	
Beschreibung	Brennerdeckel ø 80mm			
Zubehör für	103045			
	GEV-Nr.	104070	Vergl.-Nr.	—
	Brennerkopf für Brennerdeckel ø 70mm			

Knebel

Herstellerspezifische Knebel

FOEM

GEV-Nr.	110365	Vergl.-Nr.	30500004050
Beschreibung	Knebel Schalter Nullstrich T.max.°C°C ø 44mm Achse ø 3,5x3,5mm Abflachung schwarz		

Scharniere

Backofenscharniere

GEV-Nr.	700016	Vergl.-Nr.	05150024501	
Beschreibung	Backofenscharnier BA 118mm BA2mm Laschenbefestigung 13mm Hebellänge 116mm Nutabstand 11mm Federstärke 3.5mm Laschenposition links Federlänge 61mm L 153mm B 20mm			
Zubehör für	700016			
	GEV-Nr.	700003	Vergl.-Nr.	—
	Gegenhalter L 110mm B 12mm BA 94mm			

GEV-Nr.	700015	Vergl.-Nr.	05150024401	
Beschreibung	Backofenscharnier BA 118mm BA2mm Laschenbefestigung 13mm Hebellänge 116mm Nutabstand 11mm Federstärke 3.5mm Laschenposition rechts Federlänge 61mm L 153mm B 20mm			
Zubehör für	700015			
	GEV-Nr.	700003	Vergl.-Nr.	—
	Gegenhalter L 110mm B 12mm BA 94mm			

GEV-Nr.	700006	Vergl.-Nr.	0501001101	
Beschreibung	Backofenscharnier BA 173mm BA2 105mm Laschenbefestigung 14mm Hebellänge 120mm Nutabstand 11mm Federstärke 3.5mm Laschenposition links Federlänge 112mm B 25mm			
Zubehör für	700006			
	GEV-Nr.	700001	Vergl.-Nr.	—
	Gegenhalter L 118mm B 17mm BA 94mm			

Tabellenfortsetzung auf der nächsten Seite

Zubehör für	700006			
	GEV-Nr.	700007	Vergl.-Nr.	05010001201
Backofenscharnier BA 173mm BA2 105mm Laschenbefestigung 14mm Hebellänge 120mm Nutabstand 11mm Federstärke 3.5mm Laschenposition rechts Federlänge 112mm B 25mm				

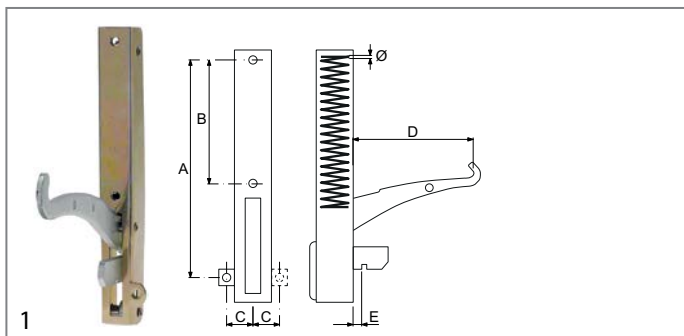

GEV-Nr.	700007	Vergl.-Nr.	05010001201	
Beschreibung	Backofenscharnier BA 173mm BA2 105mm Laschenbefestigung 14mm Hebellänge 120mm Nutabstand 11mm Federstärke 3.5mm Laschenposition rechts Federlänge 112mm B 25mm			
Zubehör für	700007			
	GEV-Nr.	700001	Vergl.-Nr.	—
Gegenhalter L 118mm B 17mm BA 94mm				
	GEV-Nr.	700006	Vergl.-Nr.	0501001101
Backofenscharnier BA 173mm BA2 105mm Laschenbefestigung 14mm Hebellänge 120mm Nutabstand 11mm Federstärke 3.5mm Laschenposition links Federlänge 112mm B 25mm				

Großküchenarmaturen





Be- und Entlüfter

	1		
GEV-Nr.	540827	Vergl.-Nr.	05030032301
Beschreibung	Be- und Entlüfter Gewinde 3/4" AG verchromt L 45mm ø 36mm		

Sicherheitsarmaturen

Sicherheitsarmaturen

	1			
GEV-Nr.	540744	Vergl.-Nr.	05030033801	
Beschreibung	Sicherheitsarmatur Gewinde 1 1/4" 0.5bar mit Manometer 3kg H 269mm			
Ersatzteile für	540744			
	GEV-Nr.	514121	Vergl.-Nr.	—
Sicherheitsventil Auslösedruck 0.5bar mit CE-Zulassung M88 Gewinde 1 1/4"				



Ersatzteile für	540744			
	GEV-Nr.	540821	Vergl.-Nr.	—
Armaturenträger Gewinde 1/4"				
	GEV-Nr.	540827	Vergl.-Nr.	05030032301
Be- und Entlüfter Gewinde 3/4" AG verchromt L 45mm ø 36mm				
	GEV-Nr.	540829	Vergl.-Nr.	—
Manometersiphon Gewinde 1/2"				
	GEV-Nr.	540830	Vergl.-Nr.	05030034401
Manometerhahn IG 1/4" AG 1/4"				
	GEV-Nr.	541062	Vergl.-Nr.	05030033701
Manometer ø 63mm Druckbereich 0 bis 1bar Anschluss Markierung einstellbar Kochkessel Gewinde 1/4"				

Zubehör

	1		
GEV-Nr.	540836	Vergl.-Nr.	05030031601
Beschreibung	Fülltrichter Gewinde 1/2" mit Absperrventil		



	1		
GEV-Nr.	540830	Vergl.-Nr.	05030034401
Beschreibung	Manometerhahn IG 1/4" AG 1/4"		

Sicherheitsventile

	1			
GEV-Nr.	540721	Vergl.-Nr.	05030032201	
Beschreibung	Sicherheitsventil Auslösedruck 0.5bar M88 Gewinde 1 1/4"			
Zubehör für	540721			
	GEV-Nr.	541501	Vergl.-Nr.	—
Reduzierung für Sicherheitsarmatur IG 1 1/4" AG 3/4"				



Manometer

			
1			
GEV-Nr.	541062	Vergl.-Nr.	05030033701
Beschreibung	Manometer ø 63mm Druckbereich 0 bis 1bar Anschluss Markierung einstellbar Kochkessel Gewinde 1/4"		
Ersatzteile für	541062		
	GEV-Nr.	541130	Vergl.-Nr.
			—
			
	Glasscheibe ø 58mm Stärke 2mm		

Messtechnik

Thermometer			
Einbauthermometer			
ø60mm			
			
1			
GEV-Nr.	379593	Vergl.-Nr.	05159905800
Beschreibung	Thermometer Einbau ø 60mm T.max. 300°C 50-300°C Fühler ø 4mm Fühler L 135mm Kapillarrohr 1050mm		

B

Backofenscharniere 11

G

Gasbrenner 11

Gashähne 5

Gasregelventile 8

Gasthermostate 7

K

Kochplatten 3

Kochstellenbrenner 11

M

Messtechnik 13

N

Nockenschalter 4

P

Piezozünder 10

R

Regelthermostate 3

S

Schalter und Taster 4

Sicherheitsthermostate 4

T

Thermoelemente 10

Thermostate 3

Timer 5

Z

Zeitschalter mechanisch 5

Zündbrenner 8

Zündkabel 10