



GAS COMPONENTS



ELECTRIC COMPONENTS



WATER TECHNOLOGY



MECHANICAL COMPONENTS



TOOLS

Spare parts suitable for

FRIGINOX

Find the complete and up-to-date range of products in our GEV Webshop



Manufacturer catalogue

The most important spare parts and accessories arranged clearly for every manufacturer

- ✓ Complete product range and all appliance data always up to date in the GEV Webshop
- ✓ Alphabetical Index at the end of the catalogue

GEV Webshop

www.gev-online.co.uk

www.gev-online.com



- 🔍 Add to Favourites
- 🔍 Sign In with email address and usual password
- 🔍 Easy-order – place several items in your basket at the same time
- 🔍 Quick Item search – no login needed



switches and momentary switches

rocker/momentary rocker switches

30x22mm



GEV No.	347791	Ref. No.	FX95040128
description	rocker switch mounting measurements 30x22mm green 2NO 230V 20A illuminated 0-I connection male faston 6.3mm ambient temperature max. 125/55°C protection IP65 with rubber collar		

microswitches

with push button

switches with snap-fit



GEV No.	348008	Ref. No.	FX95033270
description	microswitch with push button 250V 2.5A 1NO/1NC connection male faston 2.8mm/6.3mm L 27mm L1 22mm ambient temperature max. 104°C actuating force: 180g		

electronic controllers

ELIWELL

universal controllers

built-in version



GEV No.	379690	Ref. No.	FX95040265
description	electronic controller ELIWELL type ICPlus902 model ICP16D0750000 mounting measurements 71x29mm 230V voltage AC NTC/PTC relay outputs 1 CO-15A(8) NTC/PTC built-in depth 60mm defr. funct. -50 up to +150°C display 3½ digits		
accessories for	379690		
	GEV No.	378194	Ref. No. —
	temperature probe NTC 10kOhm cable PVC probe -20 up to +80°C cable -10 up to 100°C probe ø7x24.5mm cable length 1.5m without screw connection 2-wire		
	GEV No.	379052	Ref. No. —
	temperature probe PTC 1kOhm cable silicone probe -50 up to +150°C cable -50 up to +180°C probe ø6x40mm cable length 1.5m without screw connection 2-wire		
	GEV No.	379053	Ref. No. —
	temperature probe PTC 1kOhm cable PVC probe -50 up to +150°C cable -10 up to 100°C probe ø6x30mm cable length 3m without screw connection 2-wire		
	GEV No.	379057	Ref. No. —
	temperature probe NTC 10kOhm cable PVC probe -20 up to +80°C cable -10 up to 100°C probe ø6x25mm cable length 3m 2-wire		

accessories for	379690		
	GEV No.	379064	Ref. No. —
	temperature probe PTC 1kOhm cable silicone probe -50 up to +150°C cable -50 up to +180°C probe ø6x40mm cable length 3m without screw connection 2-wire		
	GEV No.	379142	Ref. No. —
	temperature probe PTC 1kOhm cable PVC probe -50 up to +150°C cable -10 up to 100°C probe ø6x30mm cable length 1.5m without screw connection 2-wire		
	GEV No.	379160	Ref. No. —
	temperature probe NTC 10kOhm cable thermoplastic probe -40 up to +110°C cable -40 up to +110°C probe ø6x14mm cable length 1.5m without screw connection 2-wire		
	GEV No.	379161	Ref. No. —
	temperature probe NTC 10kOhm cable thermoplastic probe -40 up to +110°C cable -40 up to +110°C probe ø6x14mm cable length 3m without screw connection 2-wire		
	GEV No.	379343	Ref. No. —
	temperature probe NTC 10kOhm cable silicone probe -40 up to +110°C cable -50 up to +180°C probe ø6x40mm cable length 3m 2-wire		
	GEV No.	379458	Ref. No. —
	temperature probe NTC 10kOhm cable silicone probe -40 up to +110°C cable -50 up to +180°C probe ø6x40mm cable length 1.5m without screw connection 2-wire		
	GEV No.	379781	Ref. No. —
	temperature probe PTC 1kOhm cable thermoplastic probe -50 up to +150°C cable -40 up to +110°C probe ø6x14mm cable length 1.5m without screw connection 2-wire		
	GEV No.	379782	Ref. No. —
	temperature probe PTC 1kOhm cable thermoplastic probe -50 up to +150°C cable -40 up to +110°C probe ø6x14mm cable length 3m 2-wire resistor 1kOhm		

refrigeration controllers











built-in version



GEV No.	378298	Ref. No.	FX95040273
description	electronic controller ELIWELL type IDPlus 961 model IDP17D0700000 mounting measurements 71x29mm 230V voltage AC NTC/PTC/Pt1000 relay outputs 1 NO-12A(12) NTC/PTC/Pt1000 front measurements 74x32mm built-in depth 67mm protection IP65 -55 up to +150°C display 3½ digits		
accessories for	378298		
	GEV No.	379052	Ref. No. —
	temperature probe PTC 1kOhm cable silicone probe -50 up to +150°C cable -50 up to +180°C probe ø6x40mm cable length 1.5m without screw connection 2-wire		
	GEV No.	379053	Ref. No. —
	temperature probe PTC 1kOhm cable PVC probe -50 up to +150°C cable -10 up to 100°C probe ø6x30mm cable length 3m without screw connection 2-wire		
	GEV No.	379064	Ref. No. —
	temperature probe PTC 1kOhm cable silicone probe -50 up to +150°C cable -50 up to +180°C probe ø6x40mm cable length 3m without screw connection 2-wire		

Table continues overleaf



accessories for		378298	
GEV No.	379142	Ref. No.	—
	temperature probe PTC 1kOhm cable PVC probe -50 up to +150°C cable -10 up to 100°C probe ø6x30mm cable length 1.5m without screw connection 2-wire		
	temperature probe NTC 10kOhm cable thermoplastic probe -40 up to +110°C cable -40 up to +110°C probe ø6x14mm cable length 1.5m without screw connection 2-wire		
	temperature probe NTC 10kOhm cable thermoplastic probe -40 up to +110°C cable -40 up to +110°C probe ø6x14mm cable length 3m without screw connection 2-wire		
	temperature probe NTC 10kOhm cable thermoplastic probe -40 up to +110°C cable -40 up to +110°C probe ø6x14mm cable length 6m 2-wire		
	temperature probe NTC 10kOhm cable thermoplastic probe -40 up to +110°C cable -40 up to +110°C probe ø6x14mm cable length 2m without screw connection 2-wire		
	temperature probe PTC 1kOhm cable PVC probe -50 up to +150°C cable -10 up to 100°C probe ø6x30mm cable length 5m without screw connection 2-wire		
	temperature probe NTC 10kOhm cable silicone probe -40 up to +110°C cable -50 up to +180°C probe ø6x40mm cable length 3m 2-wire		
	temperature probe NTC 10kOhm cable silicone probe -40 up to +110°C cable -50 up to +180°C probe ø6x40mm cable length 1.5m without screw connection 2-wire		
	temperature probe NTC 10kOhm cable thermoplastic probe -40 up to +110°C cable -40 up to +110°C probe ø6x14mm cable length 2.5m without screw connection 2-wire resistor 10kOhm		
	protector for electronic controller 71x29 L 93mm W 65mm plexiglas		
	temperature probe Pt1000 probe -50 up to +110°C cable silicone°C probe ø5x20mm cable length 3m protection IP68		

compressors

EMBRACO / ASPERA

R404a/R507

HMBP monophase

High/Medium evaporation temperature above -20/-15 °C

1

GEV No.	605161	Ref. No.	FX95055832
description	compressor coolant R404a/R507 type NEK6210GK 220-240V 50Hz HMBP fully hermetic 8.5kg 3/8HP cylinder capacity 8.78cm ³ CSIR H 200mmW 566W 674W 815W 988W 1195W 1435W 1707W		

L'UNITE HERMETIQUE / TECUMSEH

R404A

HMBP monophase

High/Medium evaporation temperature above -20/-15 °C

1

GEV No.	605151	Ref. No.	FX95055945
description	compressor coolant R404A type AE4440Z-FZ 220-240V 50Hz HMBP 10.5kg 1/3HP cylinder capacity 6.69cm ³ CSIR H 206mmWWW 433W 546W 676W 826W 1000W 1199W test method EN 12900 ambient temperature max. 45°C		



locks

edgemount latches

handle latches

CAFF/FERMOD

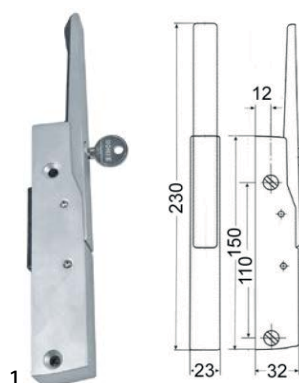

GEV No.	690456	Ref. No.	FX95040124
description	handle latch L 150mm mounting distance 110mm matt chrome-plated lockable refrigeration units 571 R-L CT 26mm complete with door catch		
spare parts for	690456		
	GEV No.	690429	Ref. No. —
	door catch CT 25.5mm		
accessories for	690456		
	GEV No.	690428	Ref. No. —
	door catch H 51mm W 13.9mm mounting distance 30mm plastic CT 16.5mm		
	GEV No.	690445	Ref. No. —
	base plate H 2mm		
	GEV No.	690446	Ref. No. —
	base plate H 5mm L 56mm W 18mm		

hinges

edgemount hinges

CAFF/FERMOD

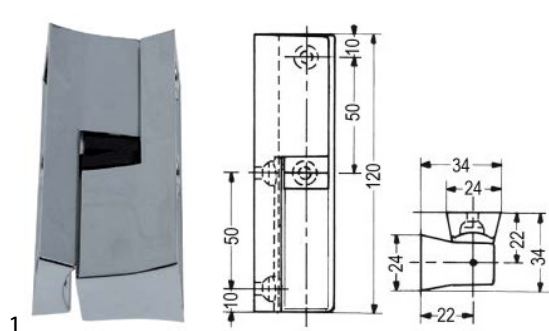

GEV No.	700565	Ref. No.	FX95014445
description	edgemount hinge L 120mm W 24mm mounting distance 50/50mm hinging left/right without lift series G 308		
accessories for	700565		
	GEV No.	690411	Ref. No. —
	base plate for type 308 thickness 8mm		

spring assisted hinges

universal

CAFF/FERMOD

group 2

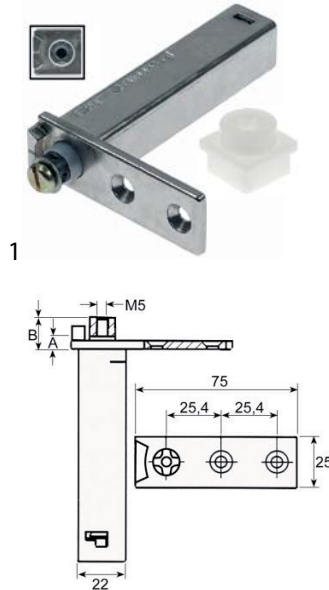

GEV No.	690494	Ref. No.	95014601 fx95014601
description	spring assisted hinge series 175 mounting pos. left/right torx L 75mm W 25.6mm H 100mm A 4mm B 11mm mounting measurements 22x22mm intake torx refrigeration units mounting distance 25mm		

door bearing



GEV No.	690583	Ref. No.	—
description	hinge bearing without bolt		

gaskets

refrigeration gaskets

plug-in gaskets

profile 9800

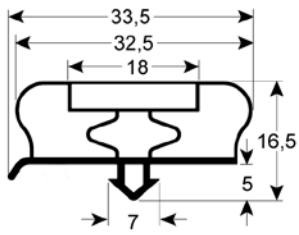

GEV No.	901815	Ref. No.	FX95030516
description	refrigeration gasket profile 9800 W 200mm L 362mm		

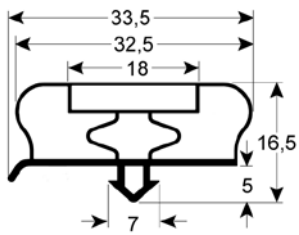

GEV No.	901598	Ref. No.	FX95030151
description	refrigeration gasket profile 9800 W 355mm L 630mm plug size		

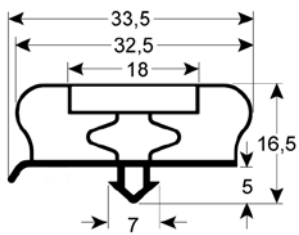

GEV No.	901816	Ref. No.	FX95030136
description	refrigeration gasket profile 9800 W 425mm L 626mm plug size W 455 length 658 external size		

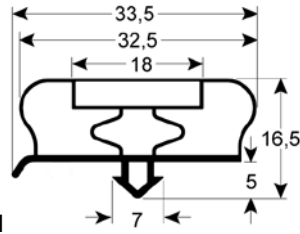

GEV No.	901599	Ref. No.	FX95016523
description	refrigeration gasket profile 9800 W 560mm L 1525mm plug size		

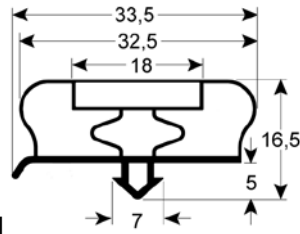

GEV No.	901600	Ref. No.	FX95033163
description	refrigeration gasket profile 9800 W 640mm L 725mm plug size		

mechanical components, equipment accessories

C

compressors 4

E

edgemount hinges 5

edgemount latches 5

electronic controllers 3

H

handle latches 5

M

microswitches 3

P

plug-in gaskets 6

R

refrigeration gaskets 6

rocker/momentary rocker switches 3

S

spring assisted hinges 5

switches and momentary switches 3