



GAS



ELEKTRA



WATER



MECHANIEK



GEREEDSCHAP

Reparatie-onderdelen passend voor

GASTROFRIT

Het complete assortiment vindt u altijd up-to-date in onze webshop



Fabrikant-catalogussen

Per fabrikant de belangrijkste vervangingsonderdelen en toebehoren overzichtelijk bij elkaar

- ✓ **Compleet assortiment en altijd de actuele apparatuurgegevens in de GEV-Webshop**
- ✓ **Alfabetische Index achter in de catalogus**

GEV-Webshop

www.gev-online.nl



- 🔍 **Artikel als favoriet opslaan**
- 🔍 **Inloggen met E-mailadres en bekende paswoord**
- 🔍 **Bulk bestellen - meerdere artikelen direct in de winkelwagen laden**
- 🔍 **Direct op artikel zoeken zonder je hoeven aan te melden**



verwarmingselementen

elementen voor frituses

1

bestelnr.	418532	fabrikantnr.	306010.024
omschrijving	verwarmingselement 6900W 230/400V VC 3 L 350mm B 215mm H 242mm L1 18mm L2 332mm H1 210mm H2 32mm flens L 250mm flens B 30mm LA 85mm gat ø 6mm aansluiting kabel kabellengte 320mm rechthoekige flens frituse		

1

bestelnr.	418549	fabrikantnr.	306010.014
omschrijving	verwarmingselement 10000W 400V VC 3 L 345mm B 200mm H 275mm windingen 15 H1 235mm H2 40mm frituse element aansluiting kabel		

1

bestelnr.	418552	fabrikantnr.	306010.013
omschrijving	verwarmingselement 10000W 400V VC 3 L 345mm B 206mm H 265mm windingen 15 H1 204mm H2 40mm frituse element kabellengte 1000mm pijp ø 8.5mm aansluitingslengte 430mm		

1

bestelnr.	418550	fabrikantnr.	306010.017
omschrijving	verwarmingselement 14000W 400V VC 3 L 349mm B 342mm H 275mm windingen 18 H1 242mm H2 33mm frituse element pijp ø 8.5mm speciale bevestiging aansluiting speciaal		

1

bestelnr.	418551	fabrikantnr.	306010.010
omschrijving	verwarmingselement 7200W 400V VC 3 L 285mm B 145mm H 268mm windingen 12 H1 238mm H2 30mm frituse element kabellengte 1200mm		

1

bestelnr.	418572	fabrikantnr.	306010.041
omschrijving	verwarmingselement 10000W 400V VC 3 L 335mm B 204mm H 30mm windingen 12 frituse element pijp ø 8mm		

1

bestelnr.	418573	fabrikantnr.	306010.042
omschrijving	verwarmingselement 13500W 400V VC 3 L 343mm B 335mm H 33mm windingen 18 frituse element pijp ø 8mm aansluitingslengte 13mm		

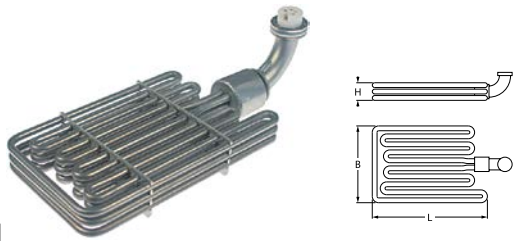
1

bestelnr.	418553	fabrikantnr.	306010.040
omschrijving	verwarmingselement 7200W 400V VC 3 L 260mm B 155mm H 33mm windingen 12 speciale bevestiging aansluiting speciaal friteuse element pijp ø 8mm		

toebehoren

overigen



1

bestelnr.	418533	fabrikantnr.	306035.032
omschrijving	aansluitblok voor verwarmingselement		



1

bestelnr.	551106	fabrikantnr.	306015.006
omschrijving	aansluitblok voor verwarmingselement		



1

bestelnr.	551091	fabrikantnr.	505000.000
omschrijving	stekeraansluiting 5-polig met kabel voor verwarmingselement		

thermostaten

regel- en maximaalthermostaten

EGO

regelthermostaten

serie 55.34_



1

bestelnr.	375143	fabrikantnr.	306025.007
omschrijving	thermostaat t.max. 110°C instelbereik 32-110°C 3-polig 3NO 16A voeler ø 6mm voeler L 138mm capillaire 1480mm capillaire pijp geïsoleerd 1100mm stopbus M9x1 as ø 6x4,6mm as L 23mm aspositie boven rotatiehoek 270°		



1

bestelnr.	375821	fabrikantnr.	306025.001 306025.006
omschrijving	thermostaat t.max. 190°C instelbereik 100-190°C 3-polig 3NO 16A voeler ø 6mm voeler L 133mm capillaire 530mm capillaire pijp geïsoleerd 500mm stopbus as ø 6x4,6mm as L 23mm aspositie boven rotatiehoek 270° speciale bevestiging		

maximaal thermostaten

serie 55.32_



1

bestelnr.	375393	fabrikantnr.	306025.010
omschrijving	maximaalthermostaat uitschakeltemp. 235°C 3-polig 1CO/2NC 20A voeler ø 6mm voeler L 87mm capillaire 1790mm capillaire pijp geïsoleerd 1710mm stopbus M9x1 voeler RVS		



serie 55.33_

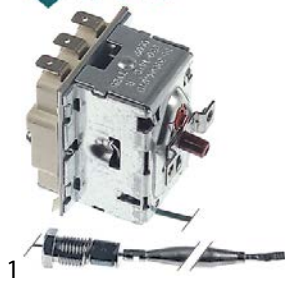

bestelnr.	375746	fabrikantnr.	306025.005
omschrijving	maximaalthermostaat uitschakeltemp. 230°C 3-polig 20A voeler ø 6mm voeler L 117mm capillaire 1470mm capillaire pijp geïsoleerd 1100mm stopbus M9x1 voeler RVS		



bestelnr.	375995	fabrikantnr.	306050.010
omschrijving	maximaalthermostaat uitschakeltemp. 230°C 3-polig 3NC 20A voeler ø 6mm voeler L 103mm capillaire 1170mm capillaire pijp geïsoleerd 1060mm stopbus inschakeltemp. 216°C voeler		

schakelaars en tasters

microschakelaars

hendelbediening



bestelnr.	347622	fabrikantnr.	306040.045
omschrijving	microschakelaar met hendel 250V 12A 1CO aansluiting vlaksteker 6,3mm L 51mm omgevingstemperatuur max. 85°C bevestigingsafstand 22.2mm type XGK2-88-J26Z1 besturingskracht: 40g		



bestelnr.	345791	fabrikantnr.	306040.045
omschrijving	microschakelaar met hendel 250V 12A 1CO aansluiting vlaksteker L 51mm omgevingstemperatuur max. 85°C		

nokschakelaars

voorzetschakelaars

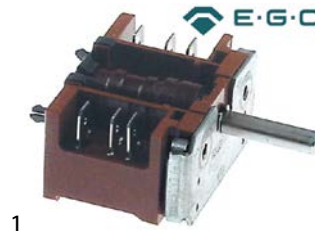

bestelnr.	301214	fabrikantnr.	306040.030
omschrijving	nokschakelaar 2 schakelstanden voorzetschakelaar 16A schakelvolgorde 0-1 as ø 6x4,6mm as L 33mm aansluiting vlaksteker 6,3mm kunststof omgevingstemperatuur max. 150°C		

overigen



bestelnr.	346853	fabrikantnr.	306040.040
omschrijving	veiligheidsschakelaar verwarmingselement met kabel		

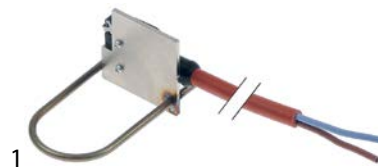

bestelnr.	347626	fabrikantnr.	505000.106
omschrijving	veiligheidsschakelaar verwarmingselement met kabel 1160mm		

systemschakelaars

speciale GEV artikelen

ø22mm

schakelaars (compleet)



bestelnr.	346858	fabrikantnr.	306040.016
omschrijving	drukschakelaar inbouwmaat ø22mm 1NO 660V max. 16(4) A 0-1 schakelend aan-uit groen verlicht aansluiting schroef-aansluiting		

Reparatie-onderdelen voor 346858





bestelnr.	345261	fabrikantnr.	—
omschrijving	contactblok 2NO 660V max. 16(4)A aansluiting schroef-aansluiting		





bestelnr.	359252	fabrikantnr.	—
omschrijving	gloeilamp fitting Ba9s 230V		



			
1			
bestelnr.	346857	fabrikantnr.	306040.013 306040.014
omschrijving	drukschakelaar inbouwmaat ø22mm 1NO 660V max. 16(4)A 0-1 schakelend rood verlicht aansluiting schroefaansluiting		
Reparatie-onderdelen voor 346857			
	bestelnr.	345261	fabrikantnr. —
	contactblok 2NO 660V max. 16(4)A aansluiting schroefaansluiting		
	bestelnr.	359606	fabrikantnr. —
	neonlamp fitting Ba9s 220V 2W transparant ø 10mm L 28mm		

			
1			
bestelnr.	346856	fabrikantnr.	306040.008
omschrijving	drukschakelaar inbouwmaat ø22mm 1NO 660V max. 16(4)A 0-1 schakelend water blauw verlicht aansluiting schroefaansluiting		
Reparatie-onderdelen voor 346856			
	bestelnr.	345261	fabrikantnr. —
	contactblok 2NO 660V max. 16(4)A aansluiting schroefaansluiting		
	bestelnr.	359252	fabrikantnr. —
	gloeilamp fitting Ba9s 230V		

			
1			
bestelnr.	347625	fabrikantnr.	306040.011
omschrijving	drukschakelaar inbouwmaat ø22mm 3NO/1NC 660V max. 16(4)A 0-1 schakelend geel verlicht aansluiting schroefaansluiting		

			
1			
bestelnr.	346855	fabrikantnr.	306040.014 306040.015
omschrijving	drukschakelaar inbouwmaat ø22mm 3NO/1NC 660V max. 16(4)A 0-1 schakelend oliepomp geel verlicht aansluiting schroef/F6,3		
Reparatie-onderdelen voor 346855			
	bestelnr.	345261	fabrikantnr. —
	contactblok 2NO 660V max. 16(4)A aansluiting schroefaansluiting		
	bestelnr.	345272	fabrikantnr. —
	contactblok 1NC/1NO 660V max. 16(4)A aansluiting schroefaansluiting		

Reparatie-onderdelen voor 346855			
	bestelnr.	359606	fabrikantnr. —
	neonlamp fitting Ba9s 220V 2W transparant ø 10mm L 28mm		

			
1			
bestelnr.	347602	fabrikantnr.	306040.009
omschrijving	drukschakelaar tastend inbouwmaat ø22mm 2NO/2NC 660V max. 16(4)A 0-1 drukkend groen verlicht aansluiting schroefaansluiting		

lampen

signaallampen

signaallampen compleet

ø10mm

met steekfitting

			
1			
bestelnr.	359439	fabrikantnr.	306045.010
omschrijving	signaallamp ø 10mm 230V groen kabellengte 220mm		

			
1			
bestelnr.	359438	fabrikantnr.	306045.011
omschrijving	signaallamp ø 10mm 230V rood kabellengte 220mm		

magneetschakelaars

TELEMECANIQUE (Schneider Electric)

magneetschakelaars

			
1			
bestelnr.	380698	fabrikantnr.	306020.004
omschrijving	relais AC1 20A 230VAC (AC3/400V) 12A/5,5kW hoofdcontact 3NO hulpcontact 1NO/1NC aansluiting veer aansluitklem type LCD123P7		

1

bestelnr.	380700	fabrikantnr.	306020.003
omschrijving	relais AC1 38A 230VAC (AC3/400V) 18.5kW hoofdcontact 1NO hulpcontact 1NC type LC1D38P7		



1

bestelnr.	403878	fabrikantnr.	505000.205
omschrijving	aansluitblok solidstate relais CRYDOM fasen 3 50A 530V 4-32 L 125mm B 95mm met koellichaam		

ALLEN BRADLEY

magneetschakelaars



1

bestelnr.	380459	fabrikantnr.	306020.002 306020.003
omschrijving	relais AC1 65A 230VAC (AC3/400V) 30A/15kW hoofdcontact 3NO aansluiting schroefaansluiting type 100-C30KF00 50/60Hz		

diversen



1

bestelnr.	402564	fabrikantnr.	505000.094
omschrijving	aansluitblok solidstate relais AIKS fasen 3 40A 48-480V 3-32 L 105mm B 75mm schroefaansluiting type ASS02-440DA		

solid state relais

CRYDOM



1

bestelnr.	403038	fabrikantnr.	505000.150
omschrijving	aansluitblok solidstate relais CRYDOM fasen 1 50A 480V 4-32VDC L 57mm B 45mm schroefaansluiting type CW-D4850P		



voelers

fabrikantspecifieke voelers

voelers



1

bestelnr.	400773	fabrikantnr.	306025.030
omschrijving	temperatuurvoeler Pt100 kabel PTFE voeler -100 tot +450°C kabel -40 tot +250°C aansluiting 2-aderig draad M10x1,5 voeler ø4x20mm kabellengte 0.5m		
Toebehoren voor	400773		
	bestelnr.	532590	fabrikantnr. —
	O-ring silicone materiaaldikte 2.62mm ID ø 13.95mm vpe 1stuk		
	bestelnr.	560197	fabrikantnr. —
	moer draad M10 H 8mm SB 17 RVS DIN/ISO DIN 934 / ISO 4032/8673 vpe 1stuk		



1

bestelnr.	403037	fabrikantnr.	306025.033
omschrijving	temperatuurvoeler Pt1000 kabel PTFE voeler -100 tot +450°C kabel -40 tot +250°C aansluiting 2-aderig draad M10 voeler ø4x30mm kabellengte 1m		

elektronica

printplaten



1

bestelnr.	400770	fabrikantnr.	306200.020
omschrijving	displayprintplaat		



1

bestelnr.	403044	fabrikantnr.	502000.019
omschrijving	ombouwset Gastro 6/7 naar Gastro 8		

triacs



1

bestelnr.	400771	fabrikantnr.	306200.007
omschrijving	triac		

bedieningsfoliën

bedieningsfoliën



1

bestelnr.	403036	fabrikantnr.	306200.013
omschrijving	membraanfolie knoppen 7 L 150mm B 80mm		



1

bestelnr.	400764	fabrikantnr.	306200.017
omschrijving	membraanfolie pastakoker TW-300		



1

bestelnr.	400766	fabrikantnr.	306200.015
omschrijving	membraanfolie voor friteuse		



1

bestelnr.	400767	fabrikantnr.	306200.016
omschrijving	membraanfolie voor friteuse		



1

bestelnr.	400768	fabrikantnr.	306200.014
omschrijving	membraanfolie voor friteuse		



1

bestelnr.	400765	fabrikantnr.	306200.018
omschrijving	membraanfolie voor pastakoker		

magneetventielen

magneetventielen voor water

diversen



1

bestelnr.	372215	fabrikantnr.	309030.001 501000.002 (old version)
omschrijving	magneetventiel eenheid		



metaal

ODE

2-wegs



1

bestelnr.	372004	fabrikantnr.	501000.002
omschrijving	magneetventiel eenheid koper 2-weg voeding 220/230VAC ingang 3/8" OD uitgang 3/8" OD L 145mm nominale breedte 12mm ODE p max. 0.1bar p min. 20bar 50/60Hz		

pompen

oliepompen



1

bestelnr.	500673	fabrikantnr.	306099.200
omschrijving	oliepomp BRINKMANN type TB16/170-GZX+581 70W 230V 50Hz L 300mm 960l/h condensator 5µF		

elektra toebehoren

steker / koppeling / stekerdozen

beveiligingscontact-stekerdozen

fabrikantspecifieke stekerdozen

diversen



1

bestelnr.	551104	fabrikantnr.	306035.033
omschrijving	stopcontact SEV1011 type 13 inbouwversie 3-polig contact P+N+PE max. 10A max. spanning 250V landen CH		

kabels

vlakbandkabels

groep 1



1

bestelnr.	400772	fabrikantnr.	306200.006
omschrijving	vlakbandkabel 34-polig L 135mm stekertype FC-34P roostermaat 2.54mm		

klemmen

printplaatklemmen



1

bestelnr.	403039	fabrikantnr.	306035.038
omschrijving	printplaatansluitingen 13-polig roostermaat 5mm		

apparaatspecifieke bouwdeelen voor friteuses

diversen



1

bestelnr.	692220	fabrikantnr.	302050.025
omschrijving	hefinrichting voor korf inbouwpositie links		



1

bestelnr.	692221	fabrikantnr.	302025.024 302050.024
omschrijving	hefinrichting voor korf inbouwpositie rechts		



1

bestelnr.	693942	fabrikantnr.	306099.015
omschrijving	hefinrichting zonder eindschakelaar voor friteusekorf inbouwpositie rechts		

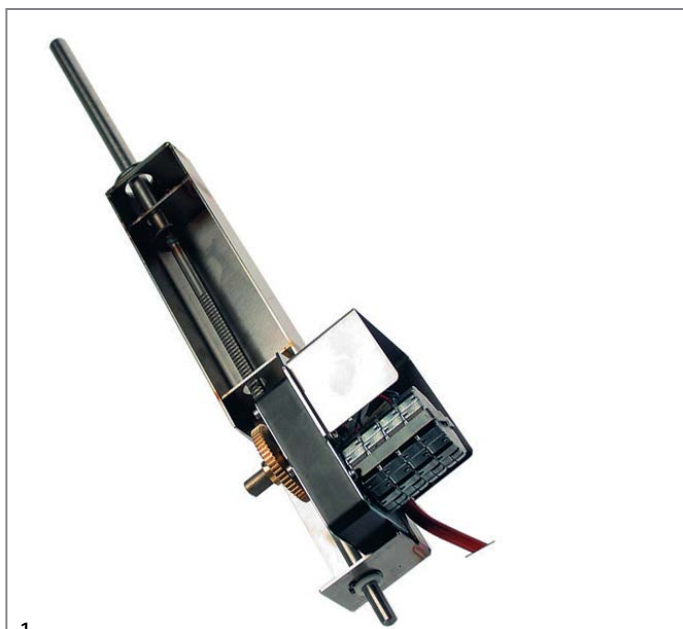

1

bestelnr.	693941	fabrikantnr.	306099.010
omschrijving	hefinrichting zonder eindschakelaar voor friteusekorf inbouwpositie links		



1

bestelnr.	692222	fabrikantnr.	303090.010
omschrijving	pompslang met pijp		

knoppen

universele knoppen



1

bestelnr.	110119	fabrikantnr.	306025.004
omschrijving	knop thermostaat t.max. 110°C ø 50mm as ø 6x4,6mm afvlakking boven zwart instelbereik 30-110°C rotatiehoek 270°		

Toebehoren voor	110119		
	bestelnr.	110135	fabrikantnr.



rozet knop tot ø 52mm



1

bestelnr.	110434	fabrikantnr.	306025.002
omschrijving	knop thermostaat t.max. 190°C ø 50mm as ø 6x4,6mm afvlakking boven zilver instelbereik 100-190°C rotatiehoek 270°		
Toebehoren voor	110434		
	bestelnr.	110135	fabrikantnr. —
	rozet knop tot ø 52mm		

fabrikantspecifieke knoppen

GASTROFRIT



1

bestelnr.	110119	fabrikantnr.	306025.004
omschrijving	knop thermostaat t.max. 110°C ø 50mm as ø 6x4,6mm afvlakking boven zwart instelbereik 30-110°C rotatiehoek 270°		
Toebehoren voor	110119		
	bestelnr.	110135	fabrikantnr. —
	rozet knop tot ø 52mm		



1

bestelnr.	110434	fabrikantnr.	306025.002
omschrijving	knop thermostaat t.max. 190°C ø 50mm as ø 6x4,6mm afvlakking boven zilver instelbereik 100-190°C rotatiehoek 270°		
Toebehoren voor	110434		
	bestelnr.	110135	fabrikantnr. —
	rozet knop tot ø 52mm		

filters

friteusefilters



1

bestelnr.	970544	fabrikantnr.	305099.002
omschrijving	oliefilter B 200mm L 260mm vpe 1stuk voor friteuse Hmm zonder greep		



1

bestelnr.	970543	fabrikantnr.	305099.003
omschrijving	oliefilter B 230mm L 475mm vpe 1stuk voor friteuse H 30mm metalen frame		
Toebehoren voor	970543		
	bestelnr.	970544	fabrikantnr. 305099.002
	oliefilter B 200mm L 260mm vpe 1stuk voor friteuse Hmm zonder greep		

korven

friteusekorven

GASTROFRIT



1

bestelnr.	970881	fabrikantnr.	503000.366
omschrijving	afdekking voor friteusekorf		



1

bestelnr.	970882	fabrikantnr.	503000.365
omschrijving	afdekking voor friteusekorf		



1

bestelnr.	970752	fabrikantnr.	303010.001
omschrijving	friteusekorf B1 150mm L1 250mm H1 160mm H2 250mm		
Toebehoren voor	970752		
	bestelnr.	970882	fabrikantnr. 503000.365
	afdekking voor friteusekorf		



1

bestelnr.	970755	fabrikantnr.	303010.004
omschrijving	friteusekorf B1 350mm L1 310mm H1 160mm H2 230mm		



1

bestelnr.	970538	fabrikantnr.	303010.004
omschrijving	friteusekorf B1 350mm L1 310mm H1 160mm H2 250mm		



1

bestelnr.	970751	fabrikantnr.	303010.002
omschrijving	friteusekorf B1 215mm L1 300mm H1 160mm H2 250mm		
Toebehoren voor	970751		
	bestelnr.	970881	fabrikantnr. 503000.366
	afdekking voor friteusekorf		

pastakorven
GASTROFRIT



1

bestelnr.	970760	fabrikantnr.	303010.058
omschrijving	pastakorf B1 150mm L1 300mm H1 195mm RVS		



1

bestelnr.	970759	fabrikantnr.	303010.052
omschrijving	friteusekorf B1 350mm L1 295mm H1 160mm RVS		



1

bestelnr.	970758	fabrikantnr.	301080.069
omschrijving	pastakorf B1 90mm L1 135mm H1 185mm grootte 1/6		



1

bestelnr.	970769	fabrikantnr.	303010.052
omschrijving	friteusekorf B1 350mm L1 300mm H1 195mm RVS met plaat		



1

bestelnr.	970756	fabrikantnr.	301080.073
omschrijving	pastakorf H1 155mm B1 105mm L1 155mm grootte 1/6 links		



1

bestelnr.	970757	fabrikantnr.	301080.076
omschrijving	pastakorf H1 155mm B1 105mm L1 155mm grootte 1/6 rechts		



1

bestelnr.	970806	fabrikantnr.	301080.070
omschrijving	pastakorf H1 185mm B1 95mm L1 135mm grootte 1/6 H2 250mm		



1

bestelnr.	970754	fabrikantnr.	303010.053
omschrijving	pastakorf H1 195mm B1 200mm L1 300mm L2 530mm H2 250mm met houder		



1

bestelnr.	970540	fabrikantnr.	303010.056
omschrijving	pastakorf L1 300mm B1 150mm H1 200mm H3 245mm RVS		
Toebehoren voor	970540		
	bestelnr.	970882	fabrikantnr. 503000.365
	afdekking voor friteusekorf		



1

bestelnr.	970541	fabrikantnr.	303010.055
omschrijving	pastakorf L1 300mm B1 200mm H1 155mm H3 250mm RVS		



1

bestelnr.	970542	fabrikantnr.	303010.057
omschrijving	pastakorf L1 300mm B1 345mm H1 200mm H3 245mm RVS		
Toebehoren voor	970542		
	bestelnr.	970881	fabrikantnr. 503000.366
	afdekking voor friteusekorf		

rubbers

o-ringen

Viton



1

bestelnr.	532622	fabrikantnr.	503000.030
omschrijving	O-ring EPDM materiaaldikte 5.7mm ID ø 34mm vpe 1stuk		



1

bestelnr.	510625	fabrikantnr.	305010.073
omschrijving	O-ring Viton materiaaldikte 2.5mm ID ø 13mm vpe 2stuk		



1

bestelnr.	514360	fabrikantnr.	303030.002 new version
omschrijving	kogelkraan aansluiting 1/2" ID - 1/2" ID DN15 totale lengte 49mm		

ventielen en containerinlaten

kogelkranen

universeel

kogelkranen met handgreep



1

bestelnr.	520282	fabrikantnr.	303030.011
omschrijving	kogelkraan aansluiting 1" ID - 1" ID DN25 totale lengte 67mm met hendelgreep		

fabrikantspecifiek

GASTROFRIT



1

bestelnr.	520735	fabrikantnr.	303030.002 old version
omschrijving	kogelkraan aansluiting 1/2" ID - koppeling DN13 totale lengte 67mm met hendelgreep greep lengte 94mm		

B

beveiligingscontact-stekerdozen 9

E

elektra toebehoren 9

elementen voor fritesuses 3

K

kabels 9

klemmen 9

kogelkranen 14

L

lampen 6

M

magneetschakelaars 6

magneetventielen 8

maximaal thermostaten 4

microschakelaars 5

N

nokkenschakelaars 5

O

oliepompen 9

o-ringen 13

P

pompen 9

R

regelthermostaten 4

S

schakelaars en tasters 5

signaallampen 6

signaallampen compleet 6

solid state relais 7

steker / koppeling / stekerdozen 9

systemschakelaars 5

T

thermostaten 4

V

ventielen en containerinlaten 14

verwarmingselementen 3

vlakbandkabels 9

voelers 7