



GAS



ELEKTRO



WASSER



MECHANIK



WERKZEUG

Ersatzteile passend für

HATCO

Das komplette Sortiment finden Sie immer aktuell im GEV-Webshop

Hersteller-Kataloge

Für jeden Hersteller die wichtigsten Ersatz- und Zubehörteile übersichtlich zusammengestellt



- ✓ **Komplettes Sortiment und alle Gerätedaten immer aktuell im GEV-Webshop**
- ✓ **Alphabetischer Index am Ende des Katalog**

GEV-Webshop

www.gev-online.de

www.gev-online.ch



- 🔍 Artikel als Favoriten markieren
- 🔍 Einloggen mit E-Mail-Adresse und gewohntem Passwort
- 🔍 Komfort-Bestellung – mehrere Artikel gleichzeitig in den Warenkorb legen
- 🔍 Sofort Artikel suchen ohne Anmeldung

Heizkörper

Heizkörper für Heiße-Theken



GEV-Nr.	418720	Vergl.-Nr.	X02.05.619.00
Beschreibung	Heizkörper 350W 220V HK 1 L 133mm B 116mm H 113mm B1 41mm B2 34mm Rohr ø 8mm Anschluss Flachstecker 6,3mm L1 17mm L2 116mm Rechteckflansch LA 56mm FL 70mm FB 16mm Loch ø 3mm		
Für Modelle:	FLVM1X		



GEV-Nr.	418721	Vergl.-Nr.	02.05.679.00 X02.09.258.00
Beschreibung	Heizkörper 700W 220V L 210mm B 85mm H 40mm Rohr ø 7mm Anschluss Flachstecker 6,3mm Laschenbefestigung Loch ø 5mm LA 66mm BA 78mm HK 1 Laschenlänge 25mm Laschenbreite 12.5mm Trockenheizkörper AL 17mm EP oben		



GEV-Nr.	418724	Vergl.-Nr.	X02.09.261.00
Beschreibung	Heizkörper 900W 220V L 290mm B 110mm H 40mm Rohr ø 7mm Anschluss Flachstecker 6,3mm mit Lasche Loch ø 5mm Befestigungsgewinde 103 LA 66mm HK 1 Laschenlänge 25mm Laschenbreite 12.5mm Trockenheizkörper AL 17mm EP unten		

Heizkörper für Rostbräter



GEV-Nr.	417716	Vergl.-Nr.	02.08.101.00 2-08-101 R02.08.101D.00 R02-08-101
Beschreibung	Heizkörper 500W 115V HK 1 L 485mm Laschenlänge 38mm Laschenbreite 25mm Rohr ø 6.5mm passend für HATCO		



GEV-Nr.	417538	Vergl.-Nr.	R02.09.205.00 R02.09.205E.00
Beschreibung	Heizkörper 275W 220V L 34mm Bmm Hmm HK 1		

Heizkörper für Salamander-/Toaster



GEV-Nr.	418723	Vergl.-Nr.	X02.09.260.00
Beschreibung	Heizkörper 1000W 220V L 290mm B 90mm H 40mm Rohr ø 7mm Anschluss Flachstecker 6,3mm mit Lasche Loch ø 5mm LA 66mm BA 83mm HK 1 Laschenlänge 25mm Laschenbreite 12.5mm Trockenheizkörper AL 17mm EP oben		

Heizkörper für Wärmebrücken



GEV-Nr.	418207	Vergl.-Nr.	R02.08.142E.00
Beschreibung	Heizkörper 1100W 220V HK 1 L 1095mm Bmm Laschenlänge 40mm Laschenbreite 18mm AL 27mm Anschluss M5 Rohr ø 6.3mm Laschenbefestigung Loch ø 5mm Trockenheizkörper		
Für Modelle:	GR 48		



GEV-Nr.	418722	Vergl.-Nr.	02.05.682.00 HAT02.05.682.00 X02.09.259.00
Beschreibung	Heizkörper 600W 220V L 210mm B 90mm H 40mm Rohr ø 7mm Anschluss Flachstecker 6,3mm mit Lasche Loch ø 5mm LA 66mm BA 83mm HK 1 Laschenlänge 25mm Laschenbreite 12.5mm Trockenheizkörper AL 17mm EP unten		



GEV-Nr.	418208	Vergl.-Nr.	R02.08.143E.00
Beschreibung	Heizkörper 1250W 220V HK 1 L 1245mm Bmm Laschenlänge 39mm Laschenbreite 25mm AL 27mm Anschluss M5 Rohr ø 6.5mm Laschenbefestigung Loch ø M4mm Trockenheizkörper		
Für Modelle:	GR 54		



GEV-Nr.	418209	Vergl.-Nr.	R02.08.144E.00
Beschreibung	Heizkörper 1400W 220V HK 1 L 1400mm Bmm Laschenlänge 39mm Laschenbreite 25mm AL 28mm Anschluss M5 Rohr ø 6.5mm Laschenbefestigung Loch ø M4mm Trockenheizkörper		
Für Modelle:	GR 60		



GEV-Nr.	418210	Vergl.-Nr.	R02.08.145E.00
Beschreibung	Heizkörper 1560W 220V HK 1 L 1565mm Bmm Laschenlänge 39mm Laschenbreite 25mm AL 26mm Anschluss M5 Rohr ø 6.5mm Laschenbefestigung Loch ø M4mm Trockenheizkörper		
Für Modelle:	GR 66		



1			
GEV-Nr.	418211	Vergl.-Nr.	R02.08.148E.00
Beschreibung	Heizkörper 1725W 220V HK 1 L 1715mm Bmm Laschenlänge 39mm Laschenbreite 25mm AL 27mm Anschluss M5 Rohr ø 6.8mm Laschenbefestigung Loch ø M4mm Trockenheizkörper		
Für Modelle:	GR 72		

1			
GEV-Nr.	418203	Vergl.-Nr.	R02.08.138E.00
Beschreibung	Heizkörper 350W 220V HK 1 L 335mm Bmm Laschenlänge 40mm Laschenbreite 18mm Anschluss M5 Rohr ø 6.3mm Rechteckflansch EP Trockenheizkörper Loch ø 5mm		
Für Modelle:	GR 18		

1			
GEV-Nr.	418202	Vergl.-Nr.	R02.08.103.00 R02.08.103E.00 R02.08.136E.00 R02.8.103E.00
Beschreibung	Heizkörper 500W 220V HK 1 L 485mm Bmm Laschenlänge 40mm Laschenbreite 18mm Anschluss M5 Rohr ø 6.3mm Rechteckflansch Loch ø M4mm Trockenheizkörper		
Für Modelle:	GR 24		

1			
GEV-Nr.	418204	Vergl.-Nr.	R02.08.139E.00
Beschreibung	Heizkörper 660W 220V HK 1 L 634mm Bmm Laschenlänge 40mm Laschenbreite 18mm Anschluss Flachstecker Rohr ø 6.5mm Rechteckflansch Loch ø 4mm Trockenheizkörper		
Für Modelle:	GR 30		

1			
GEV-Nr.	418205	Vergl.-Nr.	R02.08.140E.00
Beschreibung	Heizkörper 800W 220V HK 1 L 790mm Bmm Laschenlänge 40mm Laschenbreite 18mm AL 26mm Anschluss M5 Rohr ø 6.3mm Rechteckflansch Loch ø 5mm Trockenheizkörper FL 40mm FB 18mm		
Für Modelle:	GR 36		

1			
GEV-Nr.	418206	Vergl.-Nr.	R02.08.141E.00
Beschreibung	Heizkörper 950W 220V L 940mm Bmm Laschenlänge 40mm Laschenbreite 18mm Rohr ø 6.3mm Trockenheizkörper FL 40mm FB 18mm		
Für Modelle:	GR 42		

Heizkörper für Wärmeschränke

1			
GEV-Nr.	420568	Vergl.-Nr.	R02.08.003.00
Beschreibung	Heizkörper 350W 240V HK 1 L 540mm FL 38mm FB 25mm Anschluss M4 Rohr ø 6.5mm		

Rippenrohrheizkörper

1			
GEV-Nr.	418719	Vergl.-Nr.	X02.05.620.00
Beschreibung	Heizkörper 1000W 230V L 180mm B 80mm H 84mm Rohr ø 22mm Anschluss Flachstecker 6,3mm AL 36mm Trockenheizkörper HK 1 Laschenbefestigung		
Für Modelle:	FLVM1X		

Energeregler

EGO

1-kreisig

1				
GEV-Nr.	380666	Vergl.-Nr.	R02.19.019.00	
Beschreibung	Energeregler			
Für Modelle:	GRAH18, GRAH30, GRAH42, GRAH54			
Zubehör für	380666			
	GEV-Nr.	111825	Vergl.-Nr.	05.30.043.00 R05.30.043.00
	GEV-Nr.	112946	Vergl.-Nr.	07.01.034.00

Thermostate

Anlegethermostate

Anlegethermostate

1			
GEV-Nr.	390447	Vergl.-Nr.	X02.16.138.00
Beschreibung	Anlegethermostat LA 23.5mm Abschalttemp. 130°C NC 1-polig 10A 250V Anschluss F6,3		
Für Modelle:	FLVM1X		



			
1			
GEV-Nr.	390511	Vergl.-Nr.	R02.16.029.00
Beschreibung	Anlegethermostat Lamm Abschalttemp. 78°C 1NC 1-polig 10A Anschluss F4,8		

Zubehör für	301230		
	GEV-Nr.	691507	Vergl.-Nr. 04.08.240.00
	Abdeckung für Hebelschalter		

Regel- und Sicherheitsthermostate

IMIT / TEMPOMATIC / ARTHERMO

Regelthermostate



			
1			
GEV-Nr.	375891	Vergl.-Nr.	X02.16.136.00
Beschreibung	Thermostat T.max. 85°C Arbeitsbereich 0-85°C 1-polig 1CO 15A Fühler ø 6mm Fühler L 78mm Kapillarrohr 1000mm Kapillarrohr isoliertmm Stopfbuchse Achse ø 6x4,6mm Achslänge 15mm Fühlermaterial CNS		
Für Modelle:	FLVM1X		

Zubehör			
			
1			
GEV-Nr.	691507	Vergl.-Nr.	04.08.240.00
Beschreibung	Abdeckung für Hebelschalter		
Für Modelle:	GRAH18, GRAH30, GRAH42, GRAH54		

Schalter und Taster

Wippschalter/-taster

30x11mm

			
1			
GEV-Nr.	301010	Vergl.-Nr.	X02.19.180.00
Beschreibung	Wippschalter Einbaumaß 30x11mm rot 1NO/Leuchte 250V 16A 0-I Anschluss Flachstecker 6,3mm Umgebungstemperatur max. 85/125°C Schutzart IP40		
Für Modelle:	FLVM1X		
Zubehör für	301010		
	GEV-Nr.	301035	Vergl.-Nr. —
	Schutzhaube Einbaumaß 30x11mm		

			
1			
GEV-Nr.	112947	Vergl.-Nr.	07.01.035.00
Beschreibung	Blende L 60mm B 51mm		
Für Modelle:	GRAH18, GRAH30, GRAH42, GRAH54		

			
1			
GEV-Nr.	691506	Vergl.-Nr.	07.01.214.00
Beschreibung	Platte für Hebelschalter		
Für Modelle:	GRAH18, GRAH30, GRAH42, GRAH54		

Hebelschalter

M12x0,75

			
1			
GEV-Nr.	301230	Vergl.-Nr.	R02.19.008A.00
Beschreibung	Hebelschalter Gewinde M12x0,75 2NO 250V 15A ON-OFF Schraubanschluss		
Für Modelle:	GRAH18, GRAH30, GRAH42, GRAH54		
Zubehör für	301230		
	GEV-Nr.	112947	Vergl.-Nr. 07.01.035.00
	Blende L 60mm B 51mm		
	GEV-Nr.	691506	Vergl.-Nr. 07.01.214.00
	Platte für Hebelschalter		

Mikroschalter

hebelbetätigt

			
1			
GEV-Nr.	347021	Vergl.-Nr.	X02.19.186.00
Beschreibung	Mikroschalter mit Hebel 250V 5A 1CO Anschluss Lötanschluss L 15mm Umgebungstemperatur max. 85°C BA 10mm Betätigungskraft: 13g Hebellänge 17mm		

Schwimmerschalter

			
1			
GEV-Nr.	402061	Vergl.-Nr.	X02.01.249.00
Beschreibung	Schwimmerschalter Gewinde 9.7 1NO ø 26mm L 130mm Einbau ø 10mm 230V 0.5A Kabel Kabellänge 500mm		
Für Modelle:	FLVM1X		



Nockenschalter

4-Takt



GEV-Nr.	300022	Vergl.-Nr.	X02.19.174.00
Beschreibung	Nockenschalter 4 Schaltstellungen 2CO Schaltfolge 0-1-2-3 16A Achse ø 6x4,6mm Achslänge 23mm Anschluss Schraubanschluss		

Magnetschalter

Zubehör

Magnete



GEV-Nr.	691503	Vergl.-Nr.	X05.30.099.00
Beschreibung	Magnet für Tür		
Für Modelle:	FLVM1X		

Encoder und Potentiometer



GEV-Nr.	402057	Vergl.-Nr.	02.13.338.00 02.13.340.00 X02.13.330.00
Beschreibung	Potentiometer 0.5kOhm Drehwinkel 320° Achse ø 6mm Achslänge 12.8mm 25W 230V Typ FVR25W Kabellänge 150mm		
Zubehör für	402057		



GEV-Nr.	112939	Vergl.-Nr.	X05.30.098.00 X05.30.098.00 old
Beschreibung	Knebel Schalter Nullstrich ø 45mm Achse ø 6mm		

Lampen

Signallampen

Signallampen komplett

ø12mm

mit Steckfassung



GEV-Nr.	359041	Vergl.-Nr.	X02.19.175.00 X02.19.182.00
Beschreibung	Signallampe ø 12mm grün 230V Anschluss Flachstecker 6,3mm Temp.Best. 120°C VPE 1 Stück		
Für Modelle:	FLVM1X		



GEV-Nr.	359043	Vergl.-Nr.	X02.19.176.00 X02.19.181.00
Beschreibung	Signallampe ø 12mm rot 230V Anschluss Flachstecker 6,3mm Temp. Best. 120°C VPE 1 Stück		
Für Modelle:	FLVM1X		



GEV-Nr.	580014	Vergl.-Nr.	2-19-029 2-19-154
Beschreibung	Signallampe ø 12mm 230V rot		

ø12,5mm



GEV-Nr.	357009	Vergl.-Nr.	02.19.150.00
Beschreibung	Signallampe ø 12,5mm 230V grün Anschluss Flachstecker 4,8mm		
Für Modelle:	GRAH18, GRAH30, GRAH42, GRAH54		

Leuchtmittel für Steck-/Schraubfassungen

Glühlampen

für Beleuchtungstechnik



GEV-Nr.	359849	Vergl.-Nr.	R02.30.058.00
Beschreibung	Glühlampe T.max.°C Fassung E27 230V 60W ø 48mm L 102mm Glas L 75mm PTFE-beschichtet für HATCO Wärmebrücke GR VPE 1 Stück		

Backofenlampen

Herstellerspezifische Backofenlampen

HATCO



1

GEV-Nr.	359500	Vergl.-Nr.	X02.30.102.00
Beschreibung	Lampenfassung 250V Fassung E27 Anschluss Kabel 250mm ø 35mm H 38mm BAmm VPE 1 Stück		
Für Modelle:	FLVM1X		



1

GEV-Nr.	359848	Vergl.-Nr.	02.30.045.00 R02.30.045.00
Beschreibung	Lampenfassung Fassung E27 doppelt für HATCO Wärmebrücke GR		



1

GEV-Nr.	359847	Vergl.-Nr.	02.30.044.00 R02.30.044.00
Beschreibung	Lampenfassung Fassung E27 für HATCO Wärmebrücke GR		

Leuchtmittel

Glühlampen



1

GEV-Nr.	359849	Vergl.-Nr.	R02.30.058.00
Beschreibung	Glühlampe T.max.°C Fassung E27 230V 60W ø 48mm L 102mm Glas L 75mm PTFE-beschichtet für HATCO Wärmebrücke GR VPE 1 Stück		

Schütze

HARTLAND

Leistungsschütze



1

GEV-Nr.	580012	Vergl.-Nr.	2-01-018
Beschreibung	Schütz AC1 50A 240VAC 40A/10HP (AC3/240V) 40A/7,46kW Hauptkontakte 4NO Anschluss Schraubklemme/Flachstecker 6,3mm Typ HCCY4XU04CG		

Elektroniken

Platinen



1

GEV-Nr.	401799	Vergl.-Nr.	CM33580150
Beschreibung	Platine Eisbereiter für Gerät N201/N301//N501 230V		
Zubehör für	401799		
	GEV-Nr.	Vergl.-Nr.	—
	Verbindungskabel L 1300mm 2-polig Niveausonde passend für Eisbereiter Anschluss Stecker Steckertyp kodierter Stecker		



1

GEV-Nr.	403125	Vergl.-Nr.	76-2782-3
Beschreibung	Platine L 175mm B 99mm für Eiswürfelbereiter		



Tastaturen

Frontfolien



GEV-Nr.	402059	Vergl.-Nr.	X07.03.465.00
----------------	--------	-------------------	---------------

Beschreibung	Frontfolie Toaster TOASTMAX L 185mm B 85mm		
---------------------	--	--	--



GEV-Nr.	402060	Vergl.-Nr.	X07.03.466.00
----------------	--------	-------------------	---------------

Beschreibung	Frontfolie Toaster TOASTMAX L 265mm B 85mm		
---------------------	--	--	--

Magnetventile

Magnetventile Wasser

ELBI



GEV-Nr.	373001	Vergl.-Nr.	65010554
----------------	--------	-------------------	----------

Beschreibung	Magnetventil 1-fach gerade 230VAC Eingang 3/4" Ausgang 11,5mm Eingangl./min Ausgang 2l./min 50/60Hz DN10 T.max. 90°C Einschalt-dauer 100% ELBI Kunststoff		
---------------------	---	--	--

Lüfter

Axiallüfter

Import



GEV-Nr.	601080 ¹	Vergl.-Nr.	X02.12.082.00
----------------	---------------------	-------------------	---------------

Beschreibung	Axiallüfter L 119mm B 119mm H 38mm 230VAC 50/60Hz 23/20W Lager Kugellager Anschluss Flachstecker 2,8mm Metall ADDA Lüfterrad ø 110mm Temp.Best. 70°C		
---------------------	--	--	--

Zubehör für	601080		
--------------------	--------	--	--

GEV-Nr.	550898	Vergl.-Nr.	—
----------------	--------	-------------------	---

Beschreibung	Anschlusskabel Kabellänge 2000mm Anschluss F 2,8 Anschlussabstand 7,9mm für Axiallüfter		
---------------------	---	--	--

GEV-Nr.	692519	Vergl.-Nr.	—
----------------	--------	-------------------	---

Beschreibung	Schutzgitter L 120mm B 120mm Kunststoff		
---------------------	---	--	--

¹mit Kugellager



GEV-Nr.	601055 ¹	Vergl.-Nr.	X02.12.093.00
----------------	---------------------	-------------------	---------------

Beschreibung	Axiallüfter L 92mm B 92mm H 25mm 230VAC 50/60Hz 14,5/14W Lager Kugellager Anschluss Flachstecker 2,8mm Metall ADDA Lüfterrad ø 85mm Temp.Best. 70°C		
---------------------	---	--	--

Für Modelle:	FLVM1X		
---------------------	--------	--	--

Zubehör für	601055		
--------------------	--------	--	--

GEV-Nr.	550898	Vergl.-Nr.	—
----------------	--------	-------------------	---

Beschreibung	Anschlusskabel Kabellänge 2000mm Anschluss F 2,8 Anschlussabstand 7,9mm für Axiallüfter		
---------------------	---	--	--

GEV-Nr.	691103	Vergl.-Nr.	—
----------------	--------	-------------------	---

Beschreibung	Schutzgitter ø 90mm BA 83mm für Axiallüfter 92mm		
---------------------	--	--	--

¹mit Kugellager

Motoren

Getriebemotoren

Weitere

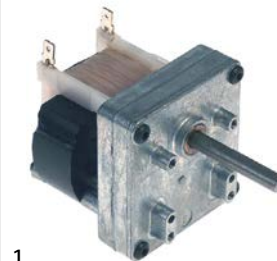

GEV-Nr.	601483	Vergl.-Nr.	02.12.079.00
----------------	--------	-------------------	--------------

Beschreibung	Getriebemotor MERKLE Typ 4515UI-063 230V 50Hz 11U/min Welle ø 7x8mm L 125mm B 76mm H 69mm für Toaster		
---------------------	---	--	--

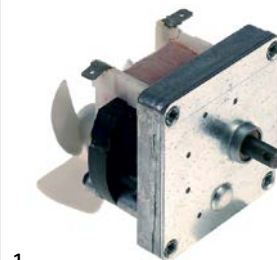

GEV-Nr.	601484	Vergl.-Nr.	02.12.026.00
----------------	--------	-------------------	--------------

Beschreibung	Getriebemotor MK Typ S4355L 230V 50Hz Welle ø 7x8mm L 76mm B 70mm H 92mm für Heißvitrine		
---------------------	--	--	--



Pumpen

Pumpen für Eiswürfelmaschinen



1

GEV-Nr.	500752	Vergl.-Nr.	62043002
Beschreibung	Pumpe GRE 60W 230V 60Hz Eingang ø 16mm Ausgang ø 21mm L 110mm Laufrichtung rechts für Eisbereiter		



1

GEV-Nr.	499122	Vergl.-Nr.	7626013
Beschreibung	Pumpe NBK MOTORS Typ YSP6PJDVF2 208-240V 50/60Hz Ausgang ø 26mm L 210mm Laufrichtung rechts für Eiswürfelbereiter		

Kondensatoren & Entstörfilter

Filter

RC-Glieder



1

GEV-Nr.	365076	Vergl.-Nr.	02.13.306.00
Beschreibung	RC-Glied 110-240V 50/60Hz Leiter 2 Anschluss Kabel VPE 1 Stück		
Für Modelle:	GRAH18, GRAH30, GRAH42, GRAH54		

Sicherungen

Feinsicherungen



1

GEV-Nr.	358611	Vergl.-Nr.	63001510
Beschreibung	Feinsicherung Größe ø5x20mm 16A flink Nennspannung 250V VPE 10 Stück		



1

GEV-Nr.	358028	Vergl.-Nr.	510127
Beschreibung	Feinsicherung Größe ø10x38mm 20A Nennspannung 500V Typ gG flink VPE 1 Stück		

Elektrozubehör

Klemmen

Lüsterklemmen



1

GEV-Nr.	550232	Vergl.-Nr.	R02.15.030.00
Beschreibung	Lüsterklemme 12-polig Querschnitt 2.5mm ² max. 32A max 450V Temp.Best. 150°C		
Für Modelle:	GRAH18, GRAH30, GRAH42, GRAH54		



1

GEV-Nr.	508353	Vergl.-Nr.	X02.15.052.00
Beschreibung	Lüsterklemme 3-polig Querschnitt 4mm ² max. 32A max 750V Temp. Best. 150°C		

Gerätespezifische Bauteile für Eisbereiter

Fühler



1

GEV-Nr.	694544	Vergl.-Nr.	76-2781-3
Beschreibung	Sensor für Eisstärke 1-polig Kabellänge 1450mm		



1

GEV-Nr.	694545	Vergl.-Nr.	76-0160-3
Beschreibung	Sensor für Eisstärke 1-polig Kabellänge 300mm		

Ventile

Füllventile



1	GEV-Nr.	694548	Vergl.-Nr.	0200361201
Beschreibung Füllventil mit Schwimmer				



1	GEV-Nr.	695613	Vergl.-Nr.	8369133
Beschreibung Füllventil mit Schwimmer				

für Toaster

Sonstiges



1	GEV-Nr.	694059	Vergl.-Nr.	X05.07.025.00
Beschreibung Antriebswelle ø 9.5mm L 235mm				
Zubehör für 694059				
	GEV-Nr.	691470	Vergl.-Nr.	X05.03.043.00
Sicherungsring E D1 ø 8mm D2 ø 16mm CNS DIN 6799 Stärke 1mm für Wellen ø 9-12mm				
	GEV-Nr.	694060	Vergl.-Nr.	X05.02.024.00
Flansch für Welle				



1	GEV-Nr.	694058	Vergl.-Nr.	X05.07.026.00
Beschreibung Antriebswelle ø 9.5mm L 320mm				
Zubehör für 694058				
	GEV-Nr.	691470	Vergl.-Nr.	X05.03.043.00
Sicherungsring E D1 ø 8mm D2 ø 16mm CNS DIN 6799 Stärke 1mm für Wellen ø 9-12mm				
	GEV-Nr.	694060	Vergl.-Nr.	X05.02.024.00
Flansch für Welle				



1	GEV-Nr.	694060	Vergl.-Nr.	X05.02.024.00
Beschreibung Flansch für Welle				



1	GEV-Nr.	691472	Vergl.-Nr.	X05.03.040.00
Beschreibung Kette US-Norm 25-1 Teilung 6mm Glieder 30 Innere Breite 3.3mm Rollenø 4.3mm einfach geschlossen				



1	GEV-Nr.	691473	Vergl.-Nr.	X05.03.044.00
Beschreibung Kette US-Norm 25-1 Teilung 6mm Glieder 31 Innere Breite 3.3mm Rollenø 4.3mm einfach geschlossen				

1

GEV-Nr.	694056	Vergl.-Nr.	05.03.036.00 X05.03.042.00
Beschreibung	Transportband L 570mm B 260mm Drahtstärke ø 1.2mm für Durchlauftoaster		



1

GEV-Nr.	694057	Vergl.-Nr.	X05.03.041.00
Beschreibung	Transportband L 580mm B 180mm Drahtstärke ø 1.2mm für Durchlauftoaster		

Zahnräder



1

GEV-Nr.	691474	Vergl.-Nr.	X05.09.052.00 X05.09.053.00
Beschreibung	Kettenzahnrad DIN/ISO Teilung 25-1 Zähne 24 Achsaufnahme ø 19mm H 18mm Nabe ø 19mm Metall ø 50mm		



1

GEV-Nr.	691475	Vergl.-Nr.	05.09.055.00 X05.09.054.00 X05.09.055.00
Beschreibung	Kettenzahnrad DIN/ISO Teilung 25-1 Zähne 36 Achsaufnahme ø 9,5mm H 18mm Nabe ø 19mm Metall ø 74mm		

für Wärmeveritren

Sonstige



1

GEV-Nr.	691508	Vergl.-Nr.	X04.17.1054.00
Beschreibung	Drehteller		

Knebel

Herstellerspezifische Knebel

HATCO



1

GEV-Nr.	111825	Vergl.-Nr.	05.30.043.00 R05.30.043.00
Beschreibung	Knebel Schalter Nullstrich ø 30mm Achse ø 6x4,6mm Abflachung rechts silber		
Für Modelle:	GRAH18, GRAH30, GRAH42, GRAH54		



1

GEV-Nr.	112939	Vergl.-Nr.	X05.30.098.00 X05.30.098.00 old
Beschreibung	Knebel Schalter Nullstrich ø 45mm Achse ø 6mm		
Für Modelle:	FLVM1X		



1

GEV-Nr.	112712	Vergl.-Nr.	05.30.020.00 X05.30.020.00 X05.30.098.00
Beschreibung	Knebel Schalter Nullstrich T.max.°C ø 38mm Achse ø 6mm Abflachung		

Zubehör

Blenden



GEV-Nr.	112946	Vergl.-Nr.	07.01.034.00
Beschreibung	Blende 0-7 Maße 51x60mm		
Für Modelle:	GRAH18, GRAH30, GRAH42, GRAH54		

Gerätefüße und Endkappen

Gerätefüße

mit Schraubbefestigung



GEV-Nr.	691476	Vergl.-Nr.	05.30.007.00 X05.30.092.00
Beschreibung	Gerätefuß Gewinde 3/8"-16UNC Gewinde L 12mm H 101-135mm Kunststoff Größe 1½" VPE 1 Stück		

Antriebstechnik und Kugellager

Ketten

Rollenketten 25-1 einfach



GEV-Nr.	691472	Vergl.-Nr.	X05.03.040.00
Beschreibung	Kette US-Norm 25-1 Teilung 6mm Glieder 30 Innere Breite 3.3mm Rollenø 4.3mm einfach geschlossen		



GEV-Nr.	691473	Vergl.-Nr.	X05.03.044.00
Beschreibung	Kette US-Norm 25-1 Teilung 6mm Glieder 31 Innere Breite 3.3mm Rollenø 4.3mm einfach geschlossen		

Messtechnik

Thermometer

Einbauthermometer

externe Stromversorgung



GEV-Nr.	403623	Vergl.-Nr.	X02.16.137.00
Beschreibung	Thermometer Einbaumaß 65x20mm 220V 0 bis +99°C Kabellänge 2900mm Fühler ø 6mm Fühler L 25mm		
Für Modelle:	FLVM1X		

Befestigungsmaterialien

Befestigungen

Sicherungsklammern



GEV-Nr.	691471	Vergl.-Nr.	X05.04.531.00
Beschreibung	Sicherungsklammer L 48mm Drahtstärke ø 2.3mm Edelstahl VPE 1 Stück		

Sicherungsringe

DIN 6799



GEV-Nr.	691470	Vergl.-Nr.	X05.03.043.00
Beschreibung	Sicherungsring E D1 ø 8mm D2 ø 16mm CNS DIN 6799 Stärke 1mm für Wellen ø 9-12mm		

Verbrauchsgüter

Sicherungen

Feinsicherungen



GEV-Nr.	358611	Vergl.-Nr.	63001510
Beschreibung	Feinsicherung Größe ø5x20mm 16A flink Nennspannung 250V VPE 10 Stück		



ø10x38mm 500V			
			
1			
GEV-Nr.	358028	Vergl.-Nr.	510127
Beschreibung	Feinsicherung Größe ø10x38mm 20A Nennspannung 500V Typ gG flink VPE 1 Stück		

A				
Anlegethermostate	4, 4			
Axiallüfter	8			
B				
Backofenlampen	7			
Befestigungen	12			
Befestigungsmaterialien	12			
E				
Elektrozubehör	9			
Energieregler	4			
F				
Feinsicherungen	12			
Filter	9			
G				
Glühlampen	6			
H				
Hebelschalter	5			
Heizkörper	3			
Heizkörper für Rostbräter	3			
Heizkörper für Salamander-/Toaster	3			
Heizkörper für Wärmebrücken	3			
Heizkörper für Wärmeschränke	4			
K				
Klemmen	9			
Kondensatoren & Entstörfilter	9			
L				
Lampen	6			
Lüfter	8			
M				
Magnetschalter	6			
Magnetventile	8			
Messtechnik	12			
Mikroschalter	5			
Motoren	8			
N				
Nockenschalter	6			
P				
Pumpen	9			
Pumpen für Eiswürfelmaschinen	9			
R				
Regelthermostate	5			
		Rippenrohrheizkörper	4	
S				
		Schalter und Taster	5	
		Schütze	7	
		Schwimmerschalter	5	
		Sicherungen	9, 12	
		Sicherungsklammern	12	
		Sicherungsringe	12	
		Signallampen	6	
		Signallampen komplett	6	
T				
		Thermostate	4	
V				
		Verbrauchsgüter	12	
W				
		Wippenschalter/-taster	5	