



COMPONENTES GAS



COMPONENTES ELÉCTRICOS



TECNOLOGÍA DEL AGUA



COMPONENTES MECÁNICOS



HERRAMIENTAS

Repuestos adaptables a

HORECA-SELECT

Encuentre nuestra gama siempre actualizada en la tienda online de GEV



Catálogo de fabricantes

Las piezas de repuesto y accesorios más importantes de cada fabricante reunidas y ordenadas de manera práctica

- ✓ En la tienda online GEV encontrará el surtido completo y toda la información actualizada de máquinas y aparatos
- ✓ Índice alfabético al final del catálogo

Tienda online GEV

www.gev-online.es
www.gev-online.com



- 🔍 marcar artículos como favoritos
- 🔍 acceso mediante su e-mail y su contraseña habitual
- 🔍 ponga en la cesta de la compra, múltiples artículos a la vez
- 🔍 búsqueda de artículos inmediata sin necesidad conectarse

inducción

bobinas de inducción



1

código	404000	referencia	01058352
descripción	bobina de inducción 3500W 230V 50Hz L 220mm An 217mm H 12mm apto para BARTSCHER para aparato de inducción		
Para modelos:	GIC2030, GIC2035		



1

código	404010	referencia	AD100087 GIC3035-04 GIC3035-B04 GIC3500-04 GIC3500-A04 GIC3535-04 GIC3535-D04
descripción	bobina de inducción ø 220mm H 10mm		
Para modelos:	GIC3500, GIC3535		



1

código	404009	referencia	GIC4035-04 GIC4035-C04
descripción	bobina de inducción ø 260mm H 50mm para wok de inducción		
Para modelos:	GIC4035		

resistencias

resistencias para hornos



1

código	416969	referencia	01203250 09950327000
descripción	resistencia 1400W 230V espirales 1 L 370mm An 400mm L1 45mm L2 325mm B1 184mm B2 30mm longitud brida 70mm anchura brida 22mm dist. del agujero 46mm longitud distancial 420mm agujero ø 5mm tubo ø 6.3mm empalme conector Faston 6,3mm espirales 3 brida rectangular resistencia seca		
Para modelos:	GCO1001, GCO2001		
accesorios para	416969		
	código	510368	referencia —
	junta L 70mm An 23.5mm agujero ø 5mm dist. del agujero 56mm FIBER espesor 2mm para resistencia		

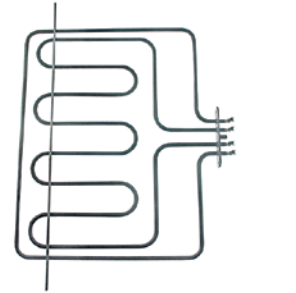

1

código	416970	referencia	01203240 09950317000
descripción	resistencia 2800W 230V espirales 2 L 323mm An 393mm L1 30mm L2 293mm B1 166mm B2 61mm longitud brida 100mm anchura brida 22mm dist. del agujero 76mm longitud distancial 485mm agujero ø 5mm tubo ø 6.3mm empalme conector Faston 6,3mm brida rectangular resistencia seca		
Para modelos:	GCO1001, GCO2001		
accesorios para	416970		
	código	528090	referencia 01000160 01980518000
	junta L 100mm An 22mm espesor 1mm		



resistencias para freidora

sujeción 2 orificios

código	417598	referencia	1.07.HDF4140403 GDF1104-013 GDF2124-013
descripción	resistencia 2500W 230V espirales 1 L 290mm An 130mm H 200mm L1 40mm L2 230mm tubo ø 8mm		
Para modelos:	GDF1104, GDF2124		

código	420145	referencia	016240419
descripción	resistencia 2500W 230V espirales 1 L 267mm An 127mm H 187mm sujeción 2 orificios empalme M4 resistencia de inmersión L1 32mm L2 235mm B1 38mm B2 50mm tubo ø 8mm rosca M12x1,25 distancia de sujeción 42mm longitud de empalme 15mm espirales 3		
Para modelos:	GDF1004, GDF2024		

código	420018	referencia	016210818
descripción	resistencia 3250W 230V espirales 1 L 265mm An 185mm H 200mm sujeción 2 orificios empalme M4 resistencia de inmersión L1 25mm L2 240mm B1 71mm B2 42mm tubo ø 8.1mm rosca M12x1 distancia de sujeción 34mm espirales 4		
Para modelos:	GDF1008, GDF2028		
repuestos para	420018		
	código	521131	referencia —
	tuerca rosca M12x1 H 3.5mm EC 17 inox UE 1 pzs		

código	417599	referencia	1.07.HDF8141903 GDF1108-012 GDF2128-012 HDF1108-013 HDF1108-13 HDF2128-013
descripción	resistencia 3250W 230V espirales 1 rosca M12x1,25 L 280mm An 190mm H 210mm L1 35mm L2 245mm B1 120mm B2 70mm tubo ø 8mm empalme M4		
Para modelos:	GDF1108, GDF2128		

resistencias para plancha grills

código	419177	referencia	D02169
descripción	resistencia 1750W 230V espirales 1 L 255mm An 240mm H 60mm tubo ø 6.3mm longitud del cable 600mm baño maría distancia de empalme 234mm resistencia seca		
Para modelos:	GEG2001		

código	418622	referencia	D02105
descripción	resistencia 3000W 230V espirales 1 L 277mm An 245mm H 55mm tubo ø 8mm empalme cable longitud del cable 600mm longitud de empalme 15mm plancha grill distancia de empalme 237mm resistencia seca		
Para modelos:	GEG1001		

resistencias para máquinas hot-dog

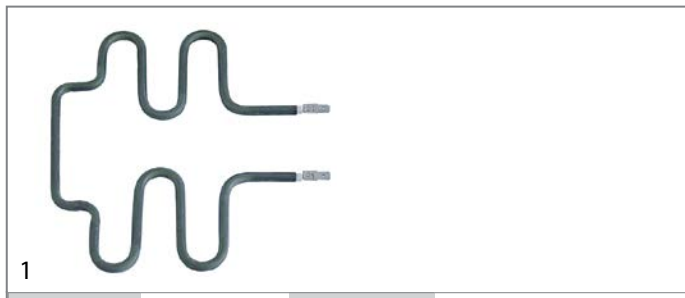

código	416718	referencia	D02002
descripción	resistencia 300W 230V L 170mm An 198mm tubo ø 6.3mm L1 50mm L2 120mm B1 68mm B2 62mm empalme conector Faston 6,3mm distancia de empalme 56mm resistencia seca espirales 1 grill para hot dog		
Para modelos:	GHM1001		

resistencias de máquinas de café



código	420147	referencia	A0ND010
descripción	resistencia 1200W 230V espirales 1 D1 ø 65mm H 42mm D2 ø 54mm espirales 3 empalme conector Faston 6,3mm resistencia de inmersión tubo ø 6.5mm para máquina de café		
Para modelos:	GCM1006, GCM2009		
accesorios para	420147		
	código	511646	referencia A0ND011
	junta silicona ø ext. 63mm int.ø 55mm espesor 2.3mm UE 1 pzs para resistencia		



código	420146	referencia	A0ND012
descripción	resistencia 130W 230V ø 130mm L 130mm H 54mm empalme conector Faston 6,3mm An 130mm espirales 1		
Para modelos:	GCM1006, GCM2009, GCM3016		



código	420143	referencia	A0ND037
descripción	resistencia espirales 1 D1 ø 65mm H 42mm D2 ø 54mm espirales 4 empalme conector Faston 6,3mm resistencia de inmersión tubo ø 6.5mm para máquina de café		
Para modelos:	GCM3016		
accesorios para	420143		
	código	511646	referencia A0ND011
	junta silicona ø ext. 63mm int.ø 55mm espesor 2.3mm UE 1 pzs para resistencia		

resistencias para refrigeración

otros			
	1		
código	420277	referencia	N/A RW40.05
descripción	resistencia 65W 220-240V L 120mm An 20mm H 21mm empalme Faston 6,3mm longitud del cable 300mm tubo ø 12mm refrigeración		
Para modelos:	GHR1040, GHR2600		

resistencias para grill de contacto

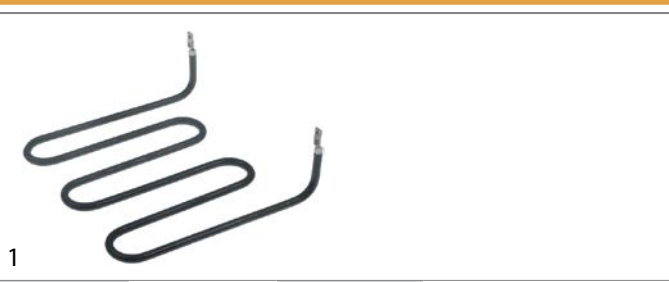

código	419161	referencia	912171
descripción	resistencia 1100W 415V L 180mm An 180mm H 40mm tubo ø 6.5mm empalme M4		
Para modelos:	GPG2001		

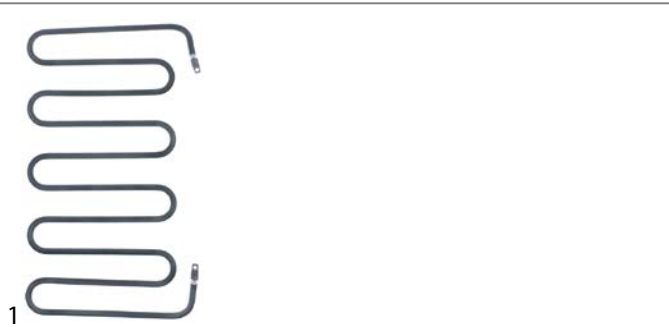

código	419002	referencia	902028
descripción	resistencia 1400W 230V espirales 1 L 175mm An 305mm H 20mm B1 40mm B2 325mm tubo ø 6.3mm espirales 5		
Para modelos:	GPG1001		

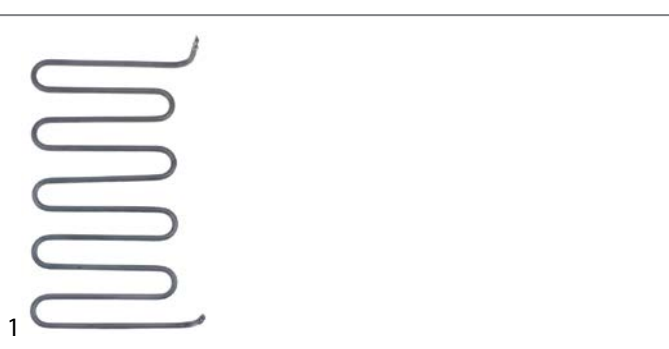

código	419003	referencia	902035
descripción	resistencia 1550W 240V L 175mm An 305mm H 40mm tubo ø 6.3mm empalme M4 espirales 5		
Para modelos:	GPG1001		



código	419160	referencia	912140
descripción	resistencia 900W 400V L 170mm An 180mm H 15mm B1 40mm B2 100mm tubo ø 6.5mm espirales 3 empalme M4		
Para modelos:	GPG2001		

resistencias de cuarzo



código	420089	referencia	D04034
descripción	resistencia de cuarzo 600W 115V L 365mm ø 11mm empalme conector Faston 6,3mm		
Para modelos:	GTO1001, GTO2001		

accesorios para	420089	código	551108	referencia	B07025
	resorte de fijación acero inoxidable para resistencia de cuarzo L 39mm An 25mm H 13.5mm taladro ø 10mm				



código	551108	referencia	B07025
descripción	resorte de fijación acero inoxidable para resistencia de cuarzo L 39mm An 25mm H 13.5mm taladro ø 10mm		
Para modelos:	GTO1001, GTO2001		

resistencias de inmersión

brida 3 orificios ø 38,5mm

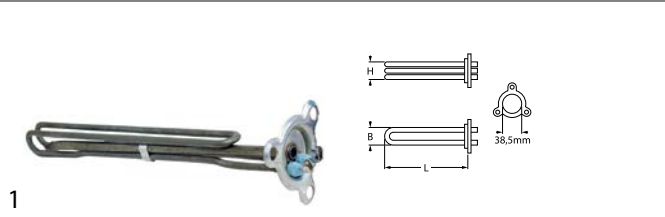

código	416263	referencia	905496
descripción	resistencia 2600W 230V montaje ø 38.5mm espirales 1 L 293mm An 26mm H 26mm casquillo portasondas 1 ø casquillo portasondas 7mm longitud casquillo portasondas 260mm casquillo termostato no ajustado tubo ø 6.3mm dist. del agujero 57mm agujero ø 10mm brida 3 orificios empalme conector Faston 6,3mm resistencia de inmersión		
Para modelos:	GGW1001, GGW2001		

repuestos para	416263	código	521120	referencia	907981
-----------------------	--------	---------------	--------	-------------------	--------

	junta tórica EPDM espesor 5.34mm int.ø 37.47mm UE 1 pzs				
--	---	--	--	--	--

accesorios para	416263	código	532577	referencia	—
------------------------	--------	---------------	--------	-------------------	---

	junta tórica EPDM espesor 5.34mm int.ø 40.65mm UE 1 pzs				
--	---	--	--	--	--

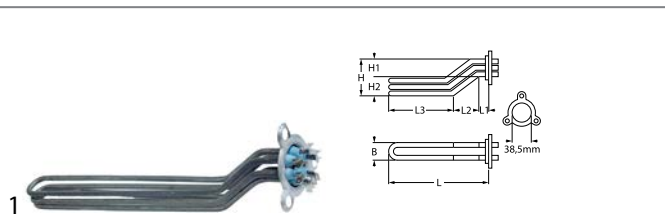

código	416267	referencia	905560
descripción	resistencia 4500W 230V montaje ø 38.5mm espirales 3 L 358mm An 32mm H 58mm L1 36mm L2 72mm L3 250mm H1 28mm H2 30mm dist. del agujero 57mm agujero ø 10mm tubo ø 6.3mm empalme conector Faston 6,3mm resistencia de inmersión brida 3 orificios		
Para modelos:	GDW1001		

repuestos para	416267	código	521120	referencia	907981
-----------------------	--------	---------------	--------	-------------------	--------

	junta tórica EPDM espesor 5.34mm int.ø 37.47mm UE 1 pzs				
--	---	--	--	--	--

accesorios para	416267	código	532577	referencia	—
------------------------	--------	---------------	--------	-------------------	---

	junta tórica EPDM espesor 5.34mm int.ø 40.65mm UE 1 pzs				
--	---	--	--	--	--



con brida de presión 50 x 26mm

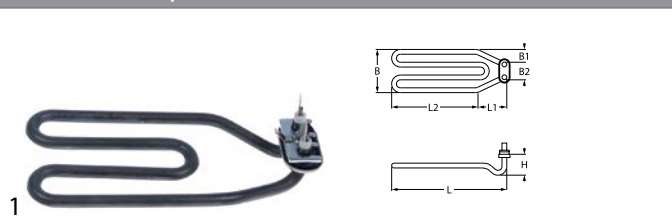

código	416209	referencia	904957 905858
descripción	resistencia 2000W 230V espirales 1 brida de presión brida 50x26mm L 180mm An 90mm H 24mm L1 55mm L2 125mm B1 28mm B2 35mm empalme conector Faston 6,3mm tubo ø 8.5mm longitud de empalme 28mm resistencia de inmersión		
Para modelos:	GDW1001		
accesorios para	416209		
	código	510387	referencia —
	junta L 46mm An 22mm ømm EPDM para resistencia para brida 50x26mm		



código	416259	referencia	905771
descripción	resistencia 1600W 230V espirales 1 L 275mm An 38mm H 28mm rosca M10x1 distancia de sujeción 27mm tubo ø 7.1mm empalme conector Faston 6,3mm sujeción 2 orificios longitud de empalme 26mm resistencia de inmersión		
Para modelos:	GGW1001, GGW2001		
accesorios para	416259		
	código	510416	referencia —
	junta plana fibra ø ext. 19mm int.ø 10.5mm espesor 1.5mm para rosca M10 UE 1 pzs		
	código	510893	referencia —
	junta tórica EPDM espesor 2.62mm int.ø 9.92mm UE 1 pzs		
	código	520231	referencia —
	tuerca rosca M10x1 H 6mm EC 14 acero zincado UE 1 pzs		
	código	521129	referencia —
	tuerca rosca M10 H 6mm inox EC 17 UE 1 pzs DIN/ISO DIN 439		

resistencias circulación de aire



código	418044	referencia	01203260 09950977000
descripción	resistencia 2500W 230V espirales 1 int.ø 180mm ø ext. 192mm L 245mm H 28mm L1 45mm B1 30mm H1 3mm H2 25mm longitud brida 70mm anchura brida 22mm dist. del agujero 56mm empalme conector Faston 6,3mm tubo ø 6.3mm resistencia circulación de aire agujero ø 5mm brida rectangular		
Para modelos:	GCO1001, GCO2001		
accesorios para	418044		
	código	550937	referencia 01000140 01960368000
	junta L 71mm An 21mm agujero ø 5mm dist. del agujero 57mm fibra espesor 1mm para resistencia		

accesorios

tuercas hexagonales

	imagen no disponible		
código	519051	referencia	902030
descripción	tuerca rosca M4 H 3.2mm EC 7 inox DIN/ISO DIN 934 / ISO 4032/8673 UE 20 pzs		
Para modelos:	GGW2001		

diversos

	1		
código	551108	referencia	B07025
descripción	resorte de fijación acero inoxidable para resistencia de cuarzo L 39mm An 25mm H 13.5mm taladro ø 10mm		
Para modelos:	GTO1001, GTO2001		

anillos de junta

juntas tóricas

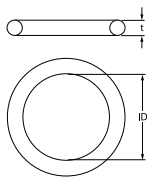
	1		
			
código	510072	referencia	904350
descripción	junta tórica EPDM espesor 3.53mm int.ø 32.93mm UE 1 pzs		
Para modelos:	GGW1001, GGW2001		



código	521120	referencia	907981
descripción	junta tórica EPDM espesor 5.34mm int.ø 37.47mm UE 1 pzs		
Para modelos:	GDW1001, GGW1001, GGW2001		

juntas para bridas

código	528090	referencia	01000160 01980518000
descripción	junta L 100mm An 22mm espesor 1mm		
Para modelos:	GCO1001, GCO2001		

código	550937	referencia	01000140 01960368000
descripción	junta L 71mm An 21mm agujero ø 5mm dist. del agujero 57mm fibra espesor 1mm para resistencia		
Para modelos:	GCO1001, GCO2001		

resortes de fijación

código	692132	referencia	016210820
descripción	clip para bulbo para tubo ø 8.5mm para sonda ø 4mm UE 1 pzs L 42mm An 14mm		
Para modelos:	GDF1008, GDF2028		

pinzas

código	692185	referencia	016210821
descripción	clip para bulbo para sonda ø 6mm inox UE 1 pzs L 40mm An 14mm		
Para modelos:	GDF1008, GDF2028		

código	692184	referencia	016240410
descripción	clip para bulbo para sonda ø 6mm inox UE 1 pzs L 57mm An 20mm		
Para modelos:	GDF1004, GDF2024		

termostatos

termostatos de superficie

termostatos de superficie de seguridad

código	390708	referencia	902004
descripción	termómetro de superficie de seguridad dist. del agujero 23.5mm temp. desconexión 180°C 1NC 1 polos 16A empalme M3 montaje ø 15mm		
Para modelos:	GPG1001		

código	390461	referencia	907243	
descripción	termómetro de superficie de seguridad dist. del agujero 23.8mm temp. desconexión 95°C 1NC 1 polos 16A empalme F6,3 sujeción 2 orificios			
Para modelos:	GGW1001, GGW2001			
accesorios para	390461			
	código	550388	referencia	—
	soporte para termostato de contacto distancia de sujeción 24.5mm fijación ø 3.8			

código	390379	referencia	A040625	
descripción	termómetro de superficie de seguridad dist. del agujero mm temp. desconexión 150°C 1NC 1 polos 16A empalme F6,3			
Para modelos:	GCM1006, GCM2009, GCM3016			
accesorios para	390379			
	código	550389	referencia	—
	soporte para termostato de contacto			

código	390318	referencia	907245
descripción	termómetro de superficie de seguridad temp. desconexión 95°C 1 polos sujeción 2 orificios		
Para modelos:	GDW1001		

termostatos de superficie

 <p>1</p>			
código	390869	referencia	253099000143 GMW1025-C19
descripción	termostato de contacto dist. del agujero 23.5mm temp. desconexión 140°C 1NC 1 polos 10A 250V empalme F4,8 UE 1 pzs		
Para modelos:	GMW1030		

 <p>1</p>			
código	390867	referencia	253099000224 GMW1025-C07 GMW1030-C07
descripción	termostato de contacto dist. del agujero 23.5mm temp. desconexión 180°C 1NC 1 polos 10A 250V empalme F4,8 UE 1 pzs		
Para modelos:	GMW1030		

 <p>1</p>			
código	390868	referencia	GMW1030-C19
descripción	termostato de contacto dist. del agujero 23.5mm temp. desconexión 180°C 1NC 1 polos 10A 250V empalme F4,8 UE 1 pzs		
Para modelos:	GMW1030		

 <p>1</p>			
código	390763	referencia	907244
descripción	termostato de contacto dist. del agujero 23.8mm temp. desconexión 55°C 1NC 1 polos 16A 250V empalme F6,3 sujeción 2 orificios para cuba		
Para modelos:	GGW1001, GGW2001		

 <p>1</p>			
código	390753	referencia	A0ND013
descripción	termostato de contacto dist. del agujero 24mm temp. desconexión 83°C 1NC 1 polos 16A 250V empalme F6,3 sujeción 2 orificios para máquina de café		
Para modelos:	GCM1006, GCM2009, GCM3016		

termostatos de control y seguridad

EGO

termostatos de regulación

serie 55.10/19_



código	375800	referencia	09952637000
descripción	termóstato T máx 308°C margen de trabajo 65-308°C 1 polos 1NO 16A sonda ø 3.03mm sonda L 120mm capilar 600mm aislamiento del capilarmm prensaestopas eje ø 6x4,6mm eje L 23mm posición del eje arriba ángulo de rotación 270° con 2 sensores		
Para modelos:	GCO1001		

serie 55.13_



código	375517	referencia	A039882
descripción	termóstato T máx 190°C margen de trabajo 60-190°C 1 polos 1NO 16A sonda ø 6mm sonda L 77mm capilar 870mm aislamiento del capilarmm prensaestopas eje ø 6/4,6mm eje L 23mm posición del eje izquierdo° ángulo de rotación 270°		
Para modelos:	GDF1004, GDF1008, GDF2024, GDF2028		
accesorios para	375517		
	código	512205	referencia 016240433
	 junta para sensor de temperatura ø ext. 15mm plástico UE 1 pzs		



código	375505	referencia	902011
descripción	termóstato T máx 320°C margen de trabajo 50-320°C 1 polos 1NO 16A sonda ø 3mm sonda L 160mm capilar 870mm aislamiento del capilar mm prensaestopas eje ø 6x4,6mm eje L 23mm posición del eje arriba ángulo de rotación 270°		
Para modelos:	GPG1001, GPG2001		

serie 55.17_



código	371320	referencia	A06032
descripción	termóstato T máx 280°C margen de trabajo 30-280°C 1 polos 1NO 16A sonda ø 3mm sonda L 170mm capilar 860mm aislamiento del capilar mm prensaestopas eje L 14mm posición del eje arriba ángulo de rotación 270°		
Para modelos:	GEG1001, GEG2001		

termostatos de seguridad

serie 55.32_



código	390999	referencia	01202690
descripción	termóstato de seguridad temp. desconexión 350°C margen de trabajo 30-350°C 2 polos NC 20A sonda ø 3mm sonda L 187mm capilar 690mm aislamiento del capilar 680mm prensaestopas eje ø mm bulbo inox		
Para modelos:	GCO2001		

IMIT / TEMPOMATIC / ARTHERMO

termostatos de regulación

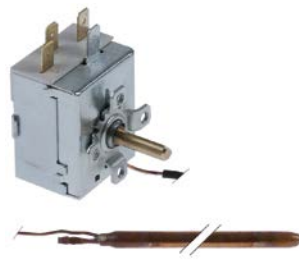

código	390683	referencia	TR0440	
descripción	termóstato T máx 86°C margen de trabajo 0-86°C 1 polos 1CO 16A sonda ø 6.5mm sonda L 98mm capilar 1000mm aislamiento del capilar 960mm prensaestopas eje ø 6x4,6mm eje L 20mm posición del eje +135° ángulo de rotación 270° material de bulbo cobre			
Para modelos:	GGW1001, GGW2001			
accesorios para	390683			
	código	110100	referencia	903982
	pomo termóstato T máx 90°C 0-90°C ø 42mm eje ø 6x4,6mm parte plana -135° negro			

CAEM

termostatos de seguridad



código	375456	referencia	01951367000
descripción	termóstato de seguridad temp. desconexión 335°C 2 polos 20A sonda ø 3mm sonda L 200mm capilar 1050mm aislamiento del capilar 650mm prensaestopas bulbo inox a 250 V 20A a 400 V 10A		
Para modelos:	GCO1001		

TECASA

termostatos de regulación



código	375134	referencia	A06032 (old version)
descripción	termóstato T máx 280°C margen de trabajo 30-280°C 1 polos 1NO 16A sonda ø 3mm sonda L 170mm capilar 860mm aislamiento del capilar mm prensaestopas eje L 14mm posición del eje arriba ángulo de rotación 270°		



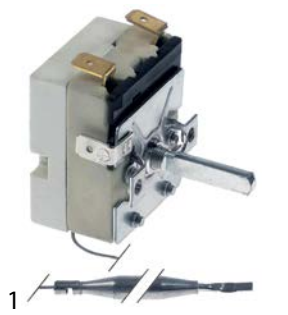

código	376091	referencia	01201220
descripción	termóstato T máx 328°C margen de trabajo 57-328°C 1 polos 1NO 16A sonda ø 3mm sonda L 98mm capilar 1540mm aislamiento del capilarmm prensaestopas eje ø 6x4,6mm eje L 21mm ángulo de rotación 270° interruptor auxiliar rosca sonda ø arandelamm		
Para modelos:	GCO2001		



código	390968	referencia	1.06.1851713 GDF1104-018 GDF1108-008 GDF2124-018 GDF2128-008 HDF1108-018 HDF1108-18 HDF2128-018
descripción	termóstato de control T máx 185°C margen de trabajo°C 2 polos 1NO 16A sonda ø 6mm sonda L 77mm capilar 1500mm aislamiento del capilarmm prensaestopas eje ø 6x4,6mm eje L 25mm posición del eje arriba ángulo de rotación 270° material de bulbo inox		
Para modelos:	GDF1104, GDF1108, GDF2124, GDF2128		

diversos
termostatos de regulación



código	390871	referencia	1.1.A.A06.02 GGC1078-05 GGC1078-5
descripción	termóstato T máx 95°C margen de trabajo 0-95°C 1 polos 1NO 6A sonda ø 6mm sonda L 95mm capilar 550mm aislamiento del capilar 490mm prensaestopas eje ø 6x4mm eje L 23mm posición del eje 45° ángulo de rotación 270° material de bulbo acero zincado 250V contactos conector Faston 4,8mm UE 1 pzs		

termostatos de seguridad



código	375523	referencia	016240438
descripción	termóstato de seguridad temp. desconexión 230°C 1 polos 1NC 16A sonda ø 4mm sonda L 100mm capilar 900mm aislamiento del capilar 410mm prensaestopas bulbo		
Para modelos:	GDF1004, GDF1008, GDF2024, GDF2028		

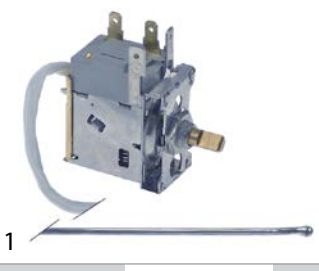

código	390870	referencia	GHR1040-14 RW40.20
descripción	termóstato T máx°C margen de trabajo°C 1 polos 1NO 5A sonda ø 2mm sonda Lmm capilar 750mm aislamiento del capilar 250mm prensaestopas eje ø 6x4mm eje L 12mm posición del eje 45° ángulo de rotación 270° material de bulbo inox 250V UE 1 pzs		
Para modelos:	GHR1040, GHR2600		



código	390970	referencia	1.06.230171301 GDF1104-005 GDF1104-5 GDF1108-023 GDF2124-005 GDF2128-023 HDF1108-005 HDF2128-005
descripción	termóstato de seguridad temp. desconexión 230°C 2 polos 1NC 16A sonda ø 5mm sonda L 48mm capilar 440mm aislamiento del capilar 150mm prensaestopas bulbo 250V modelo WQS-230		
Para modelos:	GDF1104, GDF1108, GDF2124, GDF2128		



termostatos para frío

universal con alojamiento



código	698867	referencia	GPC1046-09
descripción	termóstato bulbo capilar 650mm 1NO roscada tipo WPF17C-L2		
Para modelos:	GPC1046		

RANCO

serie K50



código	390760	referencia	3301323
descripción	termóstato RANCO tipo K50-L3210 sonda ø 2mm sonda Lmm capilar 2500mm margen de trabajo -30 a -23°C refrigeración		
Para modelos:	GFR1600		
accesorios para	390760		
	código	112654	referencia 3301324
	pomo ø 22.5mm eje ø 6x4mm azul para termostato		



código	390757	referencia	0225090
descripción	termóstato RANCO tipo K50-L3337 sonda ø 2mm sonda Lmm capilar 1500mm refrigeración		
Para modelos:	GRE1600		

otros fabricantes



código	390972	referencia	DQWA0010 HSC360-37
descripción	termóstato margen de trabajo°C sonda ø 10mm sonda L 24mm capilar 660mm tipo WPF-45270 dist. del agujero 55mm		



código	390761	referencia	20-0914-9
descripción	termóstato sonda ø 2mm capilar 1400mm para contenedor		
Para modelos:	GIM1023, GIM1038, GIM2023, GIM2038		



código	390762	referencia	20-0883-3
descripción	termóstato sonda ø 2mm sonda Lmm capilar 2000mm tipo WPF20.5B-L para evaporador		
Para modelos:	GIM1023, GIM1038, GIM2023, GIM2038		



código	390997	referencia	DQWA0002
descripción	termóstato sonda ø 3.4mm sonda Lmm capilar 770mm tipo WPF11-L para frigorífico 1NO 230V 50/60Hz		



accesorios

alargadores de eje

			
1			
código	551215	referencia	RW40.23
descripción	alargador de eje longitud total 89mm eje ø 6x4,6mm UE 1 pzs		
Para modelos:	GHR1040, GHR2600		

clips para bulbo



<p>pinzas</p> <p>para termostato</p> 			
1			
código	692185	referencia	016210821
descripción	clip para bulbo para sonda ø 6mm inox UE 1 pzs L 40mm An 14mm		
Para modelos:	GDF1008, GDF2028		

			
1			
código	692184	referencia	016240410
descripción	clip para bulbo para sonda ø 6mm inox UE 1 pzs L 57mm An 20mm		
Para modelos:	GDF1004, GDF2024		

interruptores y pulsadores



interruptores/pulsadores basculantes

<p>28x10mm</p> 			
1			
código	347804	referencia	DQKC0000 GBC1001-21 GBC1002-22 GBC1003-22
descripción	interruptor basculante medida de montaje 28x10mm rojo 1NO 250V 15A 0-I empalme conector Faston 6,3mm temperatura ambiente máx. 85°C protección IP40		

<p>30x11mm</p> 			
1			
código	301010	referencia	A0ND021
descripción	interruptor basculante medida de montaje 30x11mm rojo 1NO/ lámpara 250V 16A 0-I empalme conector Faston 6,3mm temperatura ambiente máx. 85/125°C protección IP40		
Para modelos:	GCM1006, GCM2009, GCM3016		
accesorios para	301010		
	código	referencia	—
		301035	
	cubierta protectora medida de montaje 30x11mm		

<p>30x22mm</p> 			
1			
código	347791	referencia	1.1.A.A07.10 205426 A040573 A07034 E2301GR00001 GCV1600-36 GPS1600-01 GSF1600-01 S900.01
descripción	interruptor basculante medida de montaje 30x22mm verde 2NO 230V 20A iluminado 0-I empalme conector Faston 6,3mm temperatura ambiente máx. 125/55°C protección IP65 con protección en goma		
Para modelos:	GDF1004, GDF2024, GDS1134, GDS1600, GHM1001, GHS1134, GHS1600, GHS2134, GHS2600, GJU1001, GPG1001, GPS1134, GPS1600, GPS2600, GSA1134, GSA1600, GSA2600, GSD2600, GSF1134, GSF1600, GSF2600		

			
1			
código	347531	referencia	016210836
descripción	interruptor basculante medida de montaje 30x22mm verde 2NO 250V 20A iluminado 0-I empalme conector Faston 6,3mm temperatura ambiente máx. 125/55°C protección IP65 con protección en goma		
Para modelos:	GDF1008, GDF2028		

			
1			
código	301188	referencia	20-0670-9
descripción	interruptor basculante medida de montaje 30x22mm negro 2NO/ 2NO 250V 16A I O II empalme conector Faston 6,3mm temperatura ambiente máx. 125/55°C protección IP40		
Para modelos:	GIM1023, GIM1038, GIM2023, GIM2038		
accesorios para	301188		
	código	referencia	—
		301036	
	cubierta protectora dimensión interior 30x22mm para interruptor basculante medida de montaje mm		



<p>ø20mm</p> 			
1			
código	347803	referencia	DQKA0000 GSC1100-04
descripción	interruptor basculante medida de montaje 20mm rojo 1NO 250V 15A 0-I empalme conector Faston 4,8mm temperatura ambiente máx. 85°C protección IP40		
Para modelos:	GSC1100, GSC1100G, GSC2336		



			
1			
código	347802	referencia	GSC1336-05 GSC2336-05 GSC2336-5 HSC360-31
descripción	interruptor basculante montaje ø 20mm rojo 1NO 250V 15A iluminado 0-I empalme conector Faston 4,8mm temperatura ambiente máx. 85°C protección IP40		
Para modelos:	GSC1336		

interruptores pulsantes y pulsadores

30x22mm

			
1			
código	345712	referencia	00000700296
descripción	interruptor pulsante medida de montaje 30x22mm rojo/verde 2CO 250V 16A Stop / I empalme conector Faston 6,3mm temperatura ambiente máx. 85°C protección IP40 con indicador		
Para modelos:	GFS1022, GFS1025, GFS1030, GFS2022, GFS2025, HFS2019, HFS2022, HFS2025		
accesorios para	345712		
	código	301127	referencia 00000000285
	cubierta protectora dimensión interior 30x55mm transparente		

ø22mm

			
1			
código	301127	referencia	00000000285
descripción	cubierta protectora dimensión interior 30x55mm transparente		
Para modelos:	GFS1022, GFS1025, GFS1030, GFS2025, HFS2025		

ø25mm

			
1			
código	345151 ¹	referencia	0202000
descripción	interruptor pulsante montaje ø 25mm naranja 2NO 250V 16A iluminado empalme conector Faston 6,3mm temperatura ambiente máx. 85°C protección IP40		
Para modelos:	GFR1600		

			
1			
código	347537	referencia	0202087
descripción	interruptor pulsante montaje ø 25mm verde 2NO 250V 16A iluminado interruptor principal empalme conector Faston 6,3mm temperatura ambiente máx. 55/120°C protección IP40		
Para modelos:	GFR1600, GRE1600		

microinterruptores

accionados por pistón

			
1			
código	347799	referencia	253039000003 GMW1025-C09 GMW1030-C09
descripción	microinterruptor con varilla 250V 15A 1CO empalme conector Faston 4,8mm temperatura ambiente máx. 105°C distancia de sujeción 22mm tipo W-15-102C fuerza de accionamiento: 180g blanco		
Para modelos:	GMW1030		

			
1			
código	347798	referencia	253039000010 GMW1025-C10 GMW1025-C11 GMW1030-C10 GMW1030-C11
descripción	microinterruptor con varilla 250V 15A 1NO empalme conector Faston 4,8mm L 20mm L2 22mm temperatura ambiente máx. 105°C distancia de sujeción 22mm tipo W-15-302C fuerza de accionamiento: 200g blanco		
Para modelos:	GMW1030		

M10

			
1			
código	347341	referencia	016240435
descripción	microinterruptor con varilla rosca M10x1 rosca L 16mm 250V 10A 1NO empalme conector Faston 6,3mm carrera 5mm distancia de sujeciónmm L 41mm temperatura ambiente máx. 85°C tipo X3L502K6DD fuerza de accionamiento: 130g		
Para modelos:	GDF1004, GDF1008, GDF2024, GDF2028		

¹iluminado





otros			
			
1			
código	347560	referencia	00000000304
descripción	microinterruptor con varilla distancia de sujeción 22mm rosca M10 rosca L 14mm 250V 12A 1NO empalme conector Faston 6,3mm carrera 3,5mm temperatura ambiente máx. 125°C tipo VRSR03AA1 fuerza de accionamiento: 135g		
Para modelos:	GFS1025		

otros			
			
1			
código	348187	referencia	HVS1000-47 YJS820-47
descripción	microinterruptor 230V 1NO empalme cable 400mm L 58mm L1 38mm		

con tecla			
interruptores de enganche rápido			
			
1			
código	348184	referencia	RC400.23
descripción	interruptor 250V 4A 1NO empalme F4,8 L 40mm L1 24mm L2 16mm		
Para modelos:	RC400		

			
1			
código	348192	referencia	0202070 I0202070
descripción	microinterruptor con tecla 250VA 1NO empalme conector Faston 6,3mm L 26x12mm temperatura ambiente máx. 85°C fuerza de accionamiento: 500g		
Para modelos:	GFR3600, GRE1600, GRE3600		

			
1			
código	347801	referencia	RW40.36
descripción	microinterruptor con varilla 250V 0.5A 1NC empalme conector Faston 4,8mm L 28x10mm temperatura ambiente máx. 85°C tipo versión empotrada fuerza de accionamiento: 150g		
Para modelos:	GHR1040, GHR2600		

accesorios			
			
1			
código	347794	referencia	GMW1030-P247
descripción	palanca para microinterruptor L 28mm pequeño int.ø 5mm An 22mm UE 1 pzs		
Para modelos:	GMW1030		

			
1			
código	347795	referencia	GMW1030-P246
descripción	palanca para microinterruptor L 45mm medio int.ø 5mm An 22mm UE 1 pzs		
Para modelos:	GMW1030		

			
1			
código	347796	referencia	GMW1030-P245
descripción	palanca para microinterruptor L 63mm grande int.ø 5mm An 22mm UE 1 pzs		
Para modelos:	GMW1030		

			
1			
código	347797	referencia	GMW1030-P23
descripción	soporte para microinterruptor L 165mm An 65mm UE 1 pzs		
Para modelos:	GMW1030		
accesorios para	347797		
	código	referencia	347794 GMW1030-P247
	palanca para microinterruptor L 28mm pequeño int.ø 5mm An 22mm UE 1 pzs		
	código	referencia	347795 GMW1030-P246
	palanca para microinterruptor L 45mm medio int.ø 5mm An 22mm UE 1 pzs		
	código	referencia	347796 GMW1030-P245
	palanca para microinterruptor L 63mm grande int.ø 5mm An 22mm UE 1 pzs		



interruptores posicionales

METRO



1

código	348088	referencia	1.05.035011HDFMS116 GDF1104-006 GDF1104-6 GDF1108-022 GDF2124-006 GDF2128-022 HDF1108-006 HDF2128-006
descripción	microinterruptor 1NO 250V 16A L 41mm An 12mm H 44mm fuerza de accionamiento: 250g		
Para modelos:	GDF1104, GDF1108, GDF2124, GDF2128		

interruptores de sistema ROLD



1

código	345651	referencia	905314
descripción	elemento de conmutación 2CO 250V 16A empalme conector Faston 6,3mm		
Para modelos:	GGW1001, GGW2001		



1

código	345627	referencia	909361
descripción	portaelementos medida de montaje 20,6x16,4mm negro abombado para pulsador 13x17mm		
Para modelos:	GGW1001, GGW2001		



1

código	345621	referencia	909362
descripción	tecla tamaño 17x13mm negro		
Para modelos:	GGW1001, GGW2001		



1

código	301104	referencia	905312
descripción	unidad de pulsador 1NO 250V 16A empalme conector Faston 6,3mm		
Para modelos:	GGW1001, GGW2001		

conmutadores de levas

4 posiciones

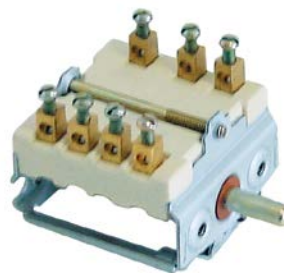

1

código	300094	referencia	A01001
descripción	conmutador de levas 4 posiciones de control 1NO/2CO secuencia de conmutación 0-1-2-3 16A eje ø 6x4,6mm eje L 15mm empalme atornillado 4 posiciones cerámica		
Para modelos:	GEG1001, GEG2001		

4 posiciones de conmutación



1

código	300243	referencia	912102
descripción	conmutador de levas 2 posiciones de conmutación secuencia de conmutación 0-1 eje ø 6x4,6mm eje L 23mm empalme conector Faston 6,3mm 4 polos		
Para modelos:	GPG2001		

1

código	347101	referencia	A01017
descripción	conmutador de levas 4 posiciones de control 1NO/1CO secuencia de conmutación 0-1-2-3 13A eje ø 6x4,6mm eje L 23mm empalme conector Faston 6,3mm plástico		
Para modelos:	GTO1001, GTO2001		

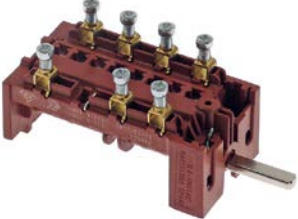

1

código	348143	referencia	A01001/1
descripción	conmutador de levas 4 posiciones de control 5NO secuencia de conmutación 0-1-2-3 16A eje ø 6x4,6mm eje L 23mm empalme conector Faston 6,3mm 8410R plástico		
Para modelos:	GEG1001		

10 posiciones de conmutación



1

código	301205	referencia	01200040 01950037000
descripción	conmutador de levas 10 posiciones de conmutación 5NO/1CO secuencia de conmutación 0-1-2-3-4-5-6-7-8-9 16A eje ø 6x4,6mm eje L 23mm empalme conector Faston 6,3mm cerámica		
Para modelos:	GCO1001, GCO2001		

interruptores magnéticos

37x16mm

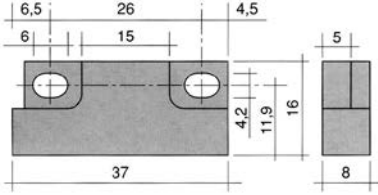



1

código	347540	referencia	909289
descripción	interruptor magnético L 37mm An 16mm 1NO 250V 0.04A P máx. 10W empalme conector Faston 6,3mm longitud del cable 370mm		
Para modelos:	GGW1001, GGW2001		

accesorios

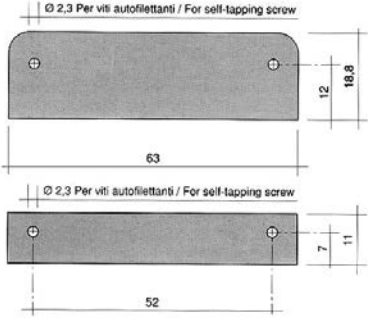
imanes

1

código	519049	referencia	903651	
descripción	imán ømm L 63mm H 10.7mm An 18.8mm dist. del agujero 52mm M2 agujero ø 2mm			
Para modelos:	GDW1001, GGW1001, GGW2001			
accesorios para	519049			
	código	560095	referencia	—
		tornillos de chapa ø 2.9mm L 9.5mm inox UE 20 pzs DIN 7981/ISO 7049 ø cabezal 5.6mm cabeza gota de sebo		

lámparas

lámparas de señalización

lámparas de señalización 2 piezas (lente y elemento)

casquillos para lámparas de señalización

ø 8mm (tipo RL-2)



1





código	359820	referencia	00002350 09950368534
descripción	casquillo para lámpara de señalización amarillo UE 1 pzs ø 8mm		
Para modelos:	GCO1001, GCO2001		





1

código	359819	referencia	00002360 09950388535
descripción	casquillo para lámpara de señalización verde UE 1 pzs ø 8mm		
Para modelos:	GCO1001, GCO2001		

elementos de señalización para tipo de casquillo RL

			
1			
código	359818	referencia	01200330 01951177000
descripción	lámpara de señalización 230V claro empalme conector Faston 6,3mm		
Para modelos:	GCO1001, GCO2001		
accesorios para	359818		
	código	359820	referencia 00002350 09950368534
casquillo para lámpara de señalización amarillo UE 1 pzs ø 8mm			
	código	359833	referencia —
casquillo para lámpara de señalización rojo UE 1 pzs ø 8mm			
	código	359948	referencia —
casquillo para lámpara de señalización claro UE 1 pzs ø 8mm			

			
1			
código	359817	referencia	01200340 01951187000
descripción	lámpara de señalización 230V verde empalme conector Faston 6,3mm		
Para modelos:	GCO1001, GCO2001		
accesorios para	359817		
	código	359819	referencia 00002360 09950388535
casquillo para lámpara de señalización verde UE 1 pzs ø 8mm			

lámparas de señalización completas

ø 6mm

			
1			
código	359005	referencia	903644
descripción	lámpara de señalización ø 6mm 230V amarillo longitud del cable 400mm		
Para modelos:	GGW1001, GGW2001		

			
1			
código	359004	referencia	903648
descripción	lámpara de señalización ø 6mm 230V verde longitud del cable 400mm resis.a la temp. 106°C		
Para modelos:	GGW1001, GGW2001		

ø10mm

con casquillo roscado

			
1			
código	359870	referencia	A0ND022
descripción	lámpara de señalización ø 10mm 230V verde empalme conector Faston 4,8mm casquillo portalámpara roscado		
Para modelos:	GCM1006, GCM2009, GCM3016		

ø12mm

con casquillo enchufable

			
1			
código	359042	referencia	A08003
descripción	lámpara de señalización ø 12mm amarillo 230V empalme conector Faston 6,3mm resis.a la temp. 120°C UE 1 pzs		
Para modelos:	GEG1001, GEG2001, GTO1001, GTO2001		

			
1			
código	359041	referencia	A08009
descripción	lámpara de señalización ø 12mm verde 230V empalme conector Faston 6,3mm resis.a la temp. 120°C UE 1 pzs		
Para modelos:	GEG1001, GEG2001		

			
1			
código	360509	referencia	016240441 912003
descripción	lámpara de señalización ø 12mm amarillo 230V empalme conector Faston 6,3mm termómetro		
Para modelos:	GDF1004, GDF1008, GDF2024, GDF2028, GPG1001		

			
1			
código	357111	referencia	912126
descripción	lámpara de señalización ø 12mm amarillo 400V empalme conector Faston 6,3mm termómetro		
Para modelos:	GPG2001		

			
1			
código	357110	referencia	912119
descripción	lámpara de señalización ø 12mm verde 400V empalme conector Faston 6,3mm resis.a la temp. 100°C		
Para modelos:	GPG2001		

ø14mm			
con casquillo roscado			
			
1			
código	360621	referencia	1.03.00020017 GDF1104-008 GDF1108-009 GDF2124-008 GDF2128-009 GDF2128-9 HDF1108-008 HDF2128-008
descripción	lámpara de señalización ø 14mm amarillo 220V empalme conector Faston 4,8mm plástico		
Para modelos:	GDF1104, GDF1108, GDF2124, GDF2128		

			
1			
código	360622	referencia	1.03.00020013 GDF1104-009 GDF1108-021 GDF2124-009 GDF2128-021 GDF2128-21 HDF1108-009 HDF2128-009
descripción	lámpara de señalización ø 14mm verde 220V empalme conector Faston 4,8mm plástico		
Para modelos:	GDF1104, GDF1108, GDF2124, GDF2128		

LEDs

barras de LED

			
1			
código	357257	referencia	DQLED007 HSC350DD-23
descripción	barra de LED L 1100mm An 14.4mm H 7.5mm 24VDC blanco número de lámparas 36 longitud del cable 120mm		

			
1			
código	357256	referencia	DQLED008 GSC1100G-27 HSC360G-21
descripción	barra de LED L 1200mm An 14.4mm H 7.5mm 24VDC blanco número de lámparas 42 longitud del cable 120mm		
Para modelos:	GSC1100G		

			
1			
código	357255	referencia	DQLED011 HSC350DD-30
descripción	barra de LED L 400mm An 14.4mm H 7.5mm 24VDC blanco número de lámparas 18 longitud del cable 380mm		

			
1			
código	357244	referencia	A1.1.A.A01.01.19
descripción	barra de LED L 580mm An 18mm H 13mmV negro/transparente número de lámparas 25 longitud del cable 210mm		
Para modelos:	GRV1100		

			
1			
código	357243	referencia	A1.1.A.A01.01.18
descripción	barra de LED L 580mm An 18mm H 13mmV negro/transparente número de lámparas 25 longitud del cable 850mm		
Para modelos:	GRV1100		

			
1			
código	357241	referencia	DQLED067
descripción	barra de LED L 600mm An 11.5mm H 12.5mm 24V número de lámparas 42 longitud del cable 285mm tensión DC		

			
1			
código	357138	referencia	1.1.A.A01.03.03 GCV1600-18
descripción	barra de LED L 698mm An 13mm H 13mm 230V número de lámparas 27 longitud del cable 800mm		



1

código	357258	referencia	GSC1100G-29
descripción	barra de LED L 900mm An 14.4mm H 7.5mm 24VDC blanco número de lámparas 30 longitud del cable 120mm		

accesorios



1

código	357247	referencia	A1.1.A.A06.01 A1.1.A.A07.01.01
descripción	alimentador con casquillo primaria 85-265V secundaria 0.2A		
Para modelos:	GRV1100		



1

código	357152	referencia	1.1.B.B25.20 GCV1600-38
descripción	alimentador para LED RT-130-2-24cm UE 1 pzs		

lámparas fluorescentes

lámparas fluorescentes

G5



1

código	357156	referencia	DQDA0009 GBC1001-31
descripción	lámpara fluorescente casquillo G5 L 285mm 8W ø 16mm 230V T5/865 UE 1 pzs		
Para modelos:	GBC1001		



1

código	357148	referencia	DQDA0010 GBC1002-32 GBC1003-32
descripción	lámpara fluorescente casquillo G5 L 547mm 14W ø 16mm 230V T5/865 UE 1 pzs		
Para modelos:	GBC1002, GBC1003		

G13



1

código	357145	referencia	DQDA0012 GSC1336-22 GSC2336-22
descripción	lámpara fluorescente casquillo G13 L 438mm 15W ø 27mm 230V UE 1 pzs tono de luz 865		
Para modelos:	GSC1336, GSC2336		



1

código	357146	referencia	DQDA0007 GSC1336-18 GSC2336-18 HSC360-26
descripción	lámpara fluorescente casquillo G13 L 895mm 30W ø 26mm 230V T8/765 UE 1 pzs		
Para modelos:	GSC1100, GSC1336, GSC2336		



1

código	357147	referencia	GSC1100-07
descripción	lámpara fluorescente casquillo G13 L 895mm 30W ø 26mm 230V T8/765 UE 1 pzs		

accesorios

casquillos



1

código	381169	referencia	GSC1100-42 GSC1336-43 GSC2336-43 SLJY2010
descripción	portalámparas casquillo G13 L 26.5mm An 24.5mm UE 1 pzs para lámparas fluorescentes		
Para modelos:	GSC1100, GSC1336		





1

código	381447	referencia	GBC1001-30 GBC1002-31 GBC1003-31 SLZA3000
descripción	portalámparas casquillo G13 L 33mm An 10mm H 28mm		
Para modelos:	GBC1001, GBC1002, GBC1003		

 <p>1</p>			
código	381413	referencia	HSC350-28 HSC360-28 SLZA2000
descripción	portalámparas casquillo G13 L 37.5mm An 28.5mm UE 1 pzs para lámparas fluorescentes		
Para modelos:	GSC1100, GSC2336		

<p>portacebadores</p>  <p>1</p>			
código	381170	referencia	GBC1001-27 GBC1002-28 GBC1003-28 GSC1100-44 GSC1336-21 GSC2336-21 SLZA1000
descripción	portacebador L 32mm An 24mm carcasa ø 23mm UE 1 pzs		
Para modelos:	GBC1001, GBC1002, GBC1003, GSC1100, GSC1336, GSC2336		

<p>cebadores</p>  <p>1</p>			
código	380464	referencia	DQDF0000 GBC1001-26 GBC1002-27 GBC1003-27 GSC1100-45 GSC1336-20 GSC2336-20
descripción	cebador 4-65W		
Para modelos:	GBC1001, GBC1002, GBC1003, GSC1100, GSC1336, GSC2336		

 <p>1</p>			
código	357150	referencia	1.1.A.A01.02.01 GGC1078-33 GGC2270-36
descripción	cebador para lámparas fluorescentes L 69mm An 38.5mm 11W tipo HG-YZ11E UE 1 pzs		
Para modelos:	GGC1270		



<p>balastros</p>  <p>1</p>			
código	403192	referencia	DQZB0005 GBC1002-18 GBC1003-18
descripción	balasto eléctrico 15W 220-240V empalme borne roscado para lámparas fluorescentes tipo JF-1595M UE 1 pzs		
Para modelos:	GBC1002, GBC1003		

 <p>1</p>			
código	403190	referencia	DQZA0027 GSC1100-35 GSC1336-35
descripción	balasto eléctrico 30W 220-240V empalme borne roscado para lámparas fluorescentes tipo JF-3095W UE 1 pzs		
Para modelos:	GSC1100, GSC1336		

 <p>1</p>			
código	358134	referencia	DQZA0024 GSC1336-23 GSC2336-23 HSC360-06
descripción	balasto eléctrico 76W 230V empalme borne roscado para lámparas fluorescentes tipo JF-1595W UE 1 pzs		
Para modelos:	GSC1336		

 <p>1</p>			
código	403191	referencia	DQZB0029 GBC1001-17
descripción	balasto eléctrico 9W 220V empalme borne roscado para lámparas fluorescentes tipo JF-995M UE 1 pzs		
Para modelos:	GBC1001		

<p>cubiertas</p>  <p>1</p>			
código	694870	referencia	HSC350-23 SLJY2016
descripción	caja L 131.5mm An 45mm H 40mm		
Para modelos:	GSC2336		

			
1			
código	694874	referencia	HSC350-38 SLZQ0037
descripción	cubierta juego pos. de montaje izquierdo/derecho An 82mm H 280mm P 34		
Para modelos:	GSC1100, GSC1100G, GSC2336		
repuestos para	694874		
	código	692393	referencia —
	código	692394	referencia —

			
1			
código	699314	referencia	GBC1001-32 SLZV0017
descripción	cubierta L 510mm An 30mm H 30mm		
Para modelos:	GBC1001		

			
1			
código	694873	referencia	HSC350-40 SLSE2008
descripción	cubierta L 590mm An 280mm H 1mm		
Para modelos:	GSC2336		

			
1			
código	699312	referencia	GBC1002-33 GBC1003-33 SLZV0018
descripción	cubierta L 810mm An 30mm H 30mm transparente		
Para modelos:	GBC1002		

			
1			
código	694872	referencia	HSC350-36 SLJV2040
descripción	cubierta soporte L 610mm An 20mm H 55mm pos. de montaje abajo		
Para modelos:	GSC2336		

			
1			
código	694871	referencia	HSC350-41 SLJV2041
descripción	cubierta soporte L 610mm An 20mm H 55mm pos. de montaje arriba		
Para modelos:	GSC2336		

			
1			
código	699307	referencia	HSC360-24 SLZE0061
descripción	tapa terminal L 60mm An 40mm H 10mm para lámpara		

lámparas para neveras

lámparas para neveras específicas del fabricante

NINGBO ROTOR

			
1			
código	357143	referencia	RW40.38
descripción	cubierta para lámpara plástico ø 62mm claro UE 1 pzs		
Para modelos:	GHR1040, GHR2600		

			
1			
código	360713	referencia	1.1.A.A01.01.01 GGC1078-31 GGC2270-35
descripción	lámpara halógena 11W 220/240V L 234mm An 32mm H 20mm		
Para modelos:	GGC1270		

			
1			
código	357127	referencia	RW40.35
descripción	LED refrigerador GHR1040 blanco 220V placa electrónica tensión AC		
Para modelos:	GHR1040, GHR2600		

			
1			
código	357144	referencia	RW40.37
descripción	portalámparas para LED ø 84mm UE 1 pzs		
Para modelos:	GHR1040, GHR2600		



1

código	357149	referencia	1.1.A.A01.01.03 GGC1078-32 GGC2270-37
descripción	portalámparas casquillo T140 250V L 34.5mm H 31mm plástico UE 1 pzs 500W dist. del agujero 254mm		
Para modelos:	GGC1270		

RWA



1

código	357143	referencia	RW40.38
descripción	cubierta para lámpara plástico ø 62mm claro UE 1 pzs		
Para modelos:	GHR1040, GHR2600		



1

código	357127	referencia	RW40.35
descripción	LED refrigerador GHR1040 blanco 220V placa electrónica tensión AC		
Para modelos:	GHR1040, GHR2600		



1

código	357144	referencia	RW40.37
descripción	portalámparas para LED ø 84mm UE 1 pzs		
Para modelos:	GHR1040, GHR2600		

lámparas para microondas

casquillos



1

código	357141	referencia	GMW1030-P21
descripción	portalámparas casquillo E14 250V ø 26mm L 37mm empalme conector Faston 4,8mm distancia de sujeción 40mm para microondas longitud del soporte 52mm plástico UE 1 pzs		
Para modelos:	GMW1030		

bombillas incandescentes



1

código	357142	referencia	GMW1030-C06
descripción	bombilla incandescente casquillo E14 230V 20W ø 22mm L 58mm UE 1 pzs cristal L 33mm		
Para modelos:	GMW1030		



1

código	357175	referencia	253079000039 GMW1025-C06
descripción	bombilla incandescente casquillo E14 230V 20W ø 25mm L 63mm UE 1 pzs cristal L 37mm		

lámparas para hornos

lámparas de horno universales

diámetro de montaje 35,5mm



1

código	359718	referencia	00002330	
descripción	lámpara de horno montaje ø 35.5mm 230V 15W casquillo E14 resis.a la temp. 300°C empalme conector Faston 6,3mm vidrio duro			
Para modelos:	GCO2001			
repuestos para	359718			
	código	359701	referencia	—
	descripción	portalámparas casquillo E14 220-230V montaje ø 35.5mm empalme conector Faston 6,3mm 15W		
	código	359740	referencia	—
	descripción	bombilla incandescente T máx 300°C casquillo E14 15W 230V ø 22mm L 48mm cristal L 20mm para lámpara de horno IMPORT		

diámetro de montaje 47,8mm



1

código	359703	referencia	01950077400	
descripción	lámpara de horno montaje ø 47.8mm 230V 15W casquillo E14 resis.a la temp. 300°C empalme conector Faston 6,3mm vidrio duro			
Para modelos:	GCO1001			
repuestos para	359703			
	código	359610	referencia	—
	descripción	bombilla incandescente T máx 300°C casquillo E14 15W 230V ø 22mm L 47mm cristal L 20mm para lámpara de horno tipo Philips		

Continúa en la página siguiente

repuestos para	359703			
	código	359725	referencia	—
	cubierta para lámpara de horno rosca ø 44mm H 43mm ø 54mm vidrio duro resis.a la temp. 350°C			

temporizadores

temporizadores eléctricos

	1		
código	360513	referencia	20-0978-9
descripción	temporizador tiempo de funcionamiento 5-15min/1-6min minuto por minuto hastamin 1CO/1NO posición permanente no margen de tiempo 5-15 / 1-6min 10A eje ømm ejemm eje Lmm empalme conector Faston 6,3mm ABB para máquina de hielo en cubitos 24-240V tensión AC/DC 2 polos		
Para modelos:	GIM1023, GIM1038, GIM2023, GIM2038		

con tiempo ajustable minuto por minuto

	1		
código	350142	referencia	09952437000
descripción	temporizador MS65 con campana tiempo de funcionamiento 120min minuto por minuto hasta 30min 1CO/1NC/2NO a 250 V 16A posición permanente presente margen de tiempo 0-120min accionamiento eléctrico 16A eje ø 6x4,6mm eje L 22mm empalme conector Faston 6,3mm Invensys atornillado/F6,3 230V tensión AC 50Hz		
Para modelos:	GCO1001		

temporizadores mecánicos

	1			
código	350186	referencia	01202980	
descripción	temporizador M2 2 polos tiempo de funcionamiento 120min accionamiento mecánico 2CO a 250 V 16A posición permanente presente eje ø 6x4,6mm eje 6x4,6mm eje L 23mm distancia de sujeción 28mm			
Para modelos:	GCO2001			
accesorios para	350186			
	código	112627	referencia	—
	pomo tiempo 120min ø 58mm eje ø 6x4,6mm parte plana abajo			

	1		
código	360164	referencia	A02008
descripción	temporizador MT49 2 polos tiempo de funcionamiento 15min accionamiento mecánico 2NO a 250 V 16A posición permanente presente eje 6x4,6mm eje L 16mm distancia de sujeción 28mm empalme lateral		
Para modelos:	GTO1001, GTO2001		

temporizador de descongelación

otros			
	1		
código	360553	referencia	1.1.A.A05.06 GGC1078-06 GGC1078-6
descripción	reloj de descongelación SONXIE tipo DBZF-625-2G2B intervalo de descongelación 6h tiempo de descongelación 2minmin retardo ventiladormin aliment. 200-240V UE 1 pzs		

señalizadores de alarma

platinas de zumabador

	1		
código	401062	referencia	01201250
descripción	platina de zumabador 230VAC L 48mm An 45mm empalme Faston 6,3mm		
Para modelos:	GCO2001		



contactores

ISKRA (FANAL)

contactores de potencia



1

código	380212	referencia	907096
descripción	contactor de potencia AC1 20A 230VAC (AC3/400V) 8,5A/5,5kW contactos principales 3NO contactos auxiliares 1NC empalme empalme atornillado tipo FANAL K07M 01 tipo ISKRA DSL7 01		
Para modelos:	GDW1001		

semiconductores de potencia

accesorios

diodos

diodos de alta tensión



1

código	403185	referencia	GMW1030-C45
descripción	diodo de alta tensión tipo RG304 empalme F4,8mm / ojal M4 para microondas UE 1 pzs		
Para modelos:	GMW1030		



1

código	403261	referencia	253089000101 GMW1025-C02
descripción	diodo de alta tensión tipo RG501 empalme F6,3mm / ojal M4 longitud del cable mm para microondas UE 1 pzs		

relés

relés de potencia

con lengüeta de sujeción

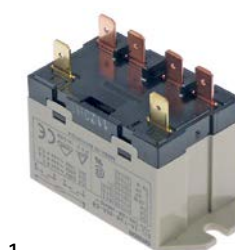

1

código	381252	referencia	1.03.00010026 GDF1108-003 GDF1108-3 GDF2128-003 HDF1108-021 HDF2128-021
descripción	relé OMRON 230VAC 25A 2NO empalme conector Faston 6,3mm lengüeta de sujeción a 250 V 25A N° fabricante G7L-2A-TUB 230VAC		
Para modelos:	GDF1108, GDF2128		



1

código	380867	referencia	DQWBZJ02
descripción	relé SHANGFANG 12VDC 30A 1NO empalme conector Faston 6,3mm fijación atornillada a 250 V 30A N° fabricante 855AW-1A-C1		
Para modelos:	GSC1100G, GSC2336		

magnetrones



1

código	403173	referencia	253017000051 GMW1025-C08
descripción	Magnetron tipo 2M248J(JT)		
Para modelos:	GMW1030		



1

código	403259	referencia	GMW1030-C08
descripción	Magnetron tipo M24FB-610A para microondas apto para GALANZ		
Para modelos:	GMW1030		

transformadores

transformadores de alta tensión



1

código	403258	referencia	GMW1030-C12 (Kabel kurz)
descripción	transformador de alta tensión primaria 230-240V 50Hz tipo 95244XC-5 para microondas		



1

código	403737	referencia	GMW1030-C12 GMW1030-C12 (Kabel lang)
descripción	transformador de alta tensión primaria 230-240V 50Hz tipo 95244XC-7 para microondas		
Para modelos:	GMW1030		



1

código	403257	referencia	253029000256 GMW1025-C12
descripción	transformador de alta tensión primaria 230-240V 50Hz tipo GAL-1000E-1G para microondas		

otros



1

código	403660	referencia	DQLED069 HBC1002-18 HBC2003-18
descripción	transformador primaria 100-240V secundaria 24VDC 20VA secundaria 0.84A		



1

código	403867	referencia	DQLED042 DQLED055 GSC1100G-31 GSC1100G-32 HSC350DD-32 HSC350DD-33 HSC360G-06
descripción	transformador primaria 100-240V secundaria 24VDC secundaria 0.42A H 25mm L 95mm An 40mm		
Para modelos:	GSC1100G		

controladores electrónicos

DIXELL

controladores de punto de refrigeración

versión empotrada



1

código	378256	referencia	GPS1600-02 GSF1600-02 RC600.34 RN600.27 S900.02
descripción	controlador electrónico DIXELL XR02CX-5N0C0 medida de montaje 71x29mm profundidad de montaje 56mm aliment. 230V tensión AC NTC salidas de relé 1 CO-8A(4) NTC protección IP54 función de descongelación/control temporizado -40 a +110°C display 2½ dígitos		
Para modelos:	GDS1134, GDS1600, GFR2600, GHS1134, GHS1600, GHS2134, GHS2600, GPS1134, GPS1600, GRE2600, GSA1134, GSA1600, GSF1134, GSF1600		
repuestos para	378256	código	379161
		referencia	—
	sensor de temperatura NTC 10kOhm cable termoplástico sonda -40 a +110°C cable -40 a +110°C bulbo ø6x14mm longitud de cable 3m sin racor de dos hilos		
accesorios para	378256	código	378194
		referencia	—
	sensor de temperatura NTC 10kOhm cable PVC sonda -20 a +80°C cable -10 a 100°C bulbo ø7x24,5mm longitud de cable 1.5m sin racor de dos hilos		

Continúa en la página siguiente



accesorios para	378256			
	código	379057	referencia	—
	sensor de temperatura NTC 10kOhm cable PVC sonda -20 a +80°C cable -10 a 100°C bulbo ø6x25mm longitud de cable 3m de dos hilos			
	código	379160	referencia	E21010150001 GPS1600-32 GSF1600-32 S900.32
	sensor de temperatura NTC 10kOhm cable termoplástico sonda -40 a +110°C cable -40 a +110°C bulbo ø6x14mm longitud de cable 1.5m sin racor de dos hilos			
	código	379161	referencia	—
	sensor de temperatura NTC 10kOhm cable termoplástico sonda -40 a +110°C cable -40 a +110°C bulbo ø6x14mm longitud de cable 3m sin racor de dos hilos			
	código	379343	referencia	0205610
	sensor de temperatura NTC 10kOhm cable silicona sonda -40 a +110°C cable -50 a +180°C bulbo ø6x40mm longitud de cable 3m de dos hilos			
	código	379458	referencia	—
	sensor de temperatura NTC 10kOhm cable silicona sonda -40 a +110°C cable -50 a +180°C bulbo ø6x40mm longitud de cable 1.5m sin racor de dos hilos			

 <p>71 x 29mm</p>				
	código	378267	referencia	E20A111C4D00 RC400.21 RN400.25
	descripción	controlador electrónico DIXELL XR02CX-5N0C1 medida de montaje 71x29mm profundidad de montaje 56mm aliment. 230V tensión AC NTC salidas de relé 1 NO-20A(8) NTC DI protección IP54 función de descongelación/control temporizado -40 a +110°C display 2½ dígitos		
	Para modelos:	GPS2600, GSA2600, GSD2600, GSF2600, RC400, RN400		
	accesorios para	378267		
	código	379161	referencia	—
	sensor de temperatura NTC 10kOhm cable termoplástico sonda -40 a +110°C cable -40 a +110°C bulbo ø6x14mm longitud de cable 3m sin racor de dos hilos			
	código	381249	referencia	—
	sensor de temperatura NTC 10kOhm cable PVC sonda -40 a +110°C cable -10 a 100°C empalme de dos hilos rosca bulbo ø6x14mm longitud de cable 3m			

				
	código	379843 ¹	referencia	1.1.A.A06.03.31 GCV1600-39
	descripción	kit controlador electrónico DIXELL XR30CX-5N2C1 medida de montaje 71x29mm aliment. 230V tensión AC NTC/PTC salidas de relé 2 incl. 1x sensor NTC -50 a +150°C display 3½ dígitos 2 TempAmbIN NTC/PTC sonda DEF DigiIN1 DigiIN2 DEF Relay relé ventilador Temp4/Dig1 NTC/PTC/DIG1 sensor de evaporador func. descon. relé compresor NO-20A(8) relé fotoeléctrico relé de alarma CO-8A(3) relé auxiliar		

¹con 1x sensor NTC

SHANGFANG

controladores de punto de refrigeración

versión empotrada









				
	código	379799 ¹	referencia	DQWBZX02 GSC1100-22 GSC1336-11 GSC2336-11
	descripción	controlador electrónico SHANGFANG tipo SF-104S-2 medida de montaje 71x29mm aliment. 12V tensión AC NTC salidas de relé 2 12VDC 12VDC NTC dimensiones frontales 77x35mm profundidad de montaje 40mm protección IP54 precisión 1% versión empotrada alarma sin accesorios func. descon. presente -45 a +45°C display 3 dígitos		
	Para modelos:	GSC1100, GSC1100G, GSC1336, GSC2336		
	repuestos para	379799		
	código	379054	referencia	—
	 transformador primaria 230VAC secundaria 12VAC 3VA secundaria 0.25A H 40mm L 45mm An 50mm empalme atornillado 50/60Hz tipo 153/M			
	código	380867	referencia	DQWBZJ02
	 relé SHANGFANG 12VDC 30A 1NO empalme conector Faston 6,3mm fijación atornillada a 250 V 30A N° fabricante 855AW-1A-C1			
	código	381318	referencia	—
	 sensor de temperatura NTC cable silicona colores cable blanco longitud de cable 3m sonda -40 a +110°C cable -50 a +180°C bulbo ø7x25mm conector codificado			
	código	381319	referencia	—
	 sensor de temperatura NTC cable silicona colores cable negro longitud de cable 3m evaporador sonda -40 a +110°C cable -50 a +180°C bulbo ø7x25mm conector codificado			
	accesorios para	379799		
	código	379054	referencia	—
	 transformador primaria 230VAC secundaria 12VAC 3VA secundaria 0.25A H 40mm L 45mm An 50mm empalme atornillado 50/60Hz tipo 153/M			
	código	380867	referencia	DQWBZJ02
	 relé SHANGFANG 12VDC 30A 1NO empalme conector Faston 6,3mm fijación atornillada a 250 V 30A N° fabricante 855AW-1A-C1			
	código	381318	referencia	—
	 sensor de temperatura NTC cable silicona colores cable blanco longitud de cable 3m sonda -40 a +110°C cable -50 a +180°C bulbo ø7x25mm conector codificado			
	código	381319	referencia	—
	 sensor de temperatura NTC cable silicona colores cable negro longitud de cable 3m evaporador sonda -40 a +110°C cable -50 a +180°C bulbo ø7x25mm conector codificado			

¹sin relé, mazo de cables, sensor y transformador











versión empotrada 2 piezas



código	379849 ¹	referencia	DQWB0005 GBC1001-18 GBC1002-19 GBC1003-19
descripción	controlador electrónico SHANGFANG tipo SF-1015 medida de montaje 71x29mm aliment. 230V tensión AC NTC salidas de relé 1 NO-30A NTC Comp dimensiones frontales 77x35mm profundidad de montaje 40mm protección IP54 precisión 1% versión empotrada alarma con relé, mazo de cables, sensor y transformador func. descon. presente -45 a +45°C display 3 dígitos		
Para modelos:	GBC1001, GBC1002, GBC1003		
repuestos para	379849		
	código	379054	referencia —
	transformador primaria 230VAC secundaria 12VAC 3VA secundaria 0.25A H 40mm L 45mm An 50mm empalme atornillado 50/60Hz tipo 153/M		
	código	380867	referencia DQWBZJ02
	relé SHANGFANG 12VDC 30A 1NO empalme conector Faston 6,3mm fijación atornillada a 250 V 30A N° fabricante 855AW-1A-C1		
	código	381318	referencia —
	sensor de temperatura NTC cable silicona colores cable blanco longitud de cable 3m sonda -40 a +110°C cable -50 a +180°C bulbo ø7x25mm conector codificado		
	código	381319	referencia —
	sensor de temperatura NTC cable silicona colores cable negro longitud de cable 3m evaporador sonda -40 a +110°C cable -50 a +180°C bulbo ø7x25mm conector codificado		
accesorios para	379849		
	código	379054	referencia —
	transformador primaria 230VAC secundaria 12VAC 3VA secundaria 0.25A H 40mm L 45mm An 50mm empalme atornillado 50/60Hz tipo 153/M		
	código	380867	referencia DQWBZJ02
	relé SHANGFANG 12VDC 30A 1NO empalme conector Faston 6,3mm fijación atornillada a 250 V 30A N° fabricante 855AW-1A-C1		
	código	381318	referencia —
	sensor de temperatura NTC cable silicona colores cable blanco longitud de cable 3m sonda -40 a +110°C cable -50 a +180°C bulbo ø7x25mm conector codificado		
	código	381319	referencia —
	sensor de temperatura NTC cable silicona colores cable negro longitud de cable 3m evaporador sonda -40 a +110°C cable -50 a +180°C bulbo ø7x25mm conector codificado		

¹con relé, mazo de cables, sensor y transformador



código	403074 ¹	referencia	DQWB0002 GSC1100-25 GSC1336-12 GSC2336-12
descripción	controlador electrónico SHANGFANG tipo SF-104S-2 medida de montaje 71x29mm aliment. 230V tensión AC NTC salidas de relé 2 NO-30A NO-30A NTC NTC dimensiones frontales 77x35mm profundidad de montaje 38mm protección IP54 precisión 1% versión empotrada alarma con relé, mazo de cables, sensor y transformador func. descon. presente -45 a +45°C display 2½ dígitos		
Para modelos:	GSC1100, GSC1100G, GSC1336, GSC2336		
repuestos para	403074		
	código	379054	referencia —
	transformador primaria 230VAC secundaria 12VAC 3VA secundaria 0.25A H 40mm L 45mm An 50mm empalme atornillado 50/60Hz tipo 153/M		
	código	380867	referencia DQWBZJ02
	relé SHANGFANG 12VDC 30A 1NO empalme conector Faston 6,3mm fijación atornillada a 250 V 30A N° fabricante 855AW-1A-C1		
	código	381318	referencia —
	sensor de temperatura NTC cable silicona colores cable blanco longitud de cable 3m sonda -40 a +110°C cable -50 a +180°C bulbo ø7x25mm conector codificado		
	código	381319	referencia —
	sensor de temperatura NTC cable silicona colores cable negro longitud de cable 3m evaporador sonda -40 a +110°C cable -50 a +180°C bulbo ø7x25mm conector codificado		
accesorios para	403074		
	código	379054	referencia —
	transformador primaria 230VAC secundaria 12VAC 3VA secundaria 0.25A H 40mm L 45mm An 50mm empalme atornillado 50/60Hz tipo 153/M		
	código	380867	referencia DQWBZJ02
	relé SHANGFANG 12VDC 30A 1NO empalme conector Faston 6,3mm fijación atornillada a 250 V 30A N° fabricante 855AW-1A-C1		
	código	381318	referencia —
	sensor de temperatura NTC cable silicona colores cable blanco longitud de cable 3m sonda -40 a +110°C cable -50 a +180°C bulbo ø7x25mm conector codificado		
	código	381319	referencia —
	sensor de temperatura NTC cable silicona colores cable negro longitud de cable 3m evaporador sonda -40 a +110°C cable -50 a +180°C bulbo ø7x25mm conector codificado		

¹con relé, mazo de cables, sensor y transformador



accesorios



1	código	380867	referencia	DQWBZJ02
descripción relé SHANGFANG 12VDC 30A 1NO empalme conector Faston 6,3mm fijación atornillada a 250 V 30A N° fabricante 855AW-1A-C1				
Para modelos: GSC1100G, GSC2336				

otros

controladores de punto de refrigeración



1	código	379848	referencia	GBC1001-19 GBC1002-20 GBC1003-20
descripción controlador electrónico ZHONGSHAN SHANGFANG INSTRUMENT tipo SF-101 medida de montaje 71x29mm aliment. 12V display 3 dígitos salidas de relé 1				

accesorios en general para controladores

otros



1	código	692369	referencia	1.1.C.C63.71 GCV1600-47
descripción soporte per termómetro An 81mm H 41mm plástico UE 1 pzs				

sensores

sensores universales

sondas de temperatura



1	código	379343	referencia	0205610
descripción sensor de temperatura NTC 10kOhm cable silicona sonda -40 a +110°C cable -50 a +180°C bulbo ø6x40mm longitud de cable 3m de dos hilos				
Para modelos: GFR1600, GRE1600				



1	código	379160	referencia	E21010150001 GPS1600-32 GSF1600-32 S900.32
descripción sensor de temperatura NTC 10kOhm cable termoplástico sonda -40 a +110°C cable -40 a +110°C bulbo ø6x14mm longitud de cable 1.5m sin racor de dos hilos				
Para modelos: GDS1134, GDS1600, GPS1134, GPS1600, GPS2600, GSA1134, GSA1600, GSA2600, GSD2600, GSF1134, GSF1600, GSF2600				

sensores específicos del fabricante

sensores



1	código	403910	referencia	I0205805
descripción sensor de temperatura NTC 10kOhm cable PVC sonda -40 a +110°C empalme de dos hilos bulbo 5x20 longitud de cable 1.475m				
Para modelos: GFR3600, GRE3600				



1	código	378331	referencia	909364
descripción sensor de temperatura NTC cable silicona sonda -40 a +110°C cable -50 a +180°C empalme conector codificado rosca bulbo ø6x50mm longitud de cable 2m				
Para modelos: GDW1001				

sensores



1	código	403155	referencia	AD400009 DQD010010R GIC3035-03 GIC3035-B03 GIC3500-03 GIC3500-A03 GIC3535-03 GIC3535-D03
descripción sensor para aparato de inducción ø 25mm H 17mm longitud del cable 130mm				
Para modelos: GIC3500, GIC3535				



1	código	403158	referencia	GIC4035-03 GIC4035-C03
descripción sensor para wok de inducción ø 25mm H 17mm longitud del cable 130mm				
Para modelos: GIC4035				



accesorios

sujeciones



1			
código	692373	referencia	GPS1600-31 GSF1600-31 S900.31
descripción	clip para bulbo para sensor de temperatura L 50mm An 31mm H 6mm inox agujero ø 5mm dist. del agujero 30mm UE 1 pzs		
Para modelos:	GDS1134, GDS1600, GPS1134, GPS1600, GSA1134, GSA1600, GSF1134, GSF1600		

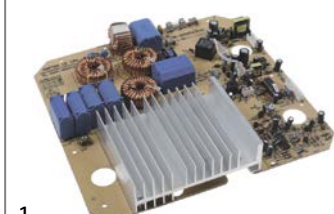

1			
código	402959	referencia	010583510M2
descripción	placa base aparato de inducción GIC2035 L 236mm An 230mm desde 06/2010		
Para modelos:	GIC2035		

electrónicas

accesorios electrónicos

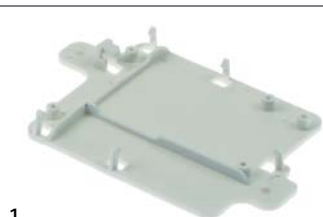

1			
código	551213	referencia	GMW1030-P65
descripción	soporte para placa electrónica L 125mm An 80mm espesor 3mm plástico UE 1 pzs		
Para modelos:	GMW1030		

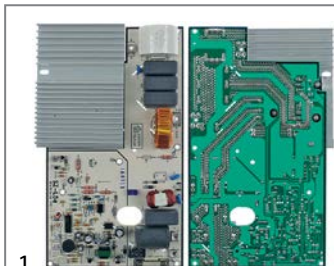

1			
código	403680	referencia	GIC3035-B5 GIC3535-B5 GIC4035-C5
descripción	placa base aparato de inducción GIC3035 L 267mm An 160mm empalme atornillado empalme de teclado 4 pins de contacto SZ-L5a		

placas electrónicas

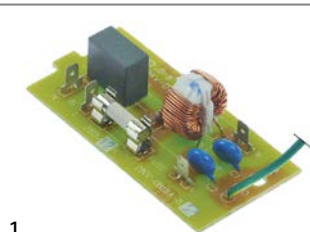

1			
código	403188	referencia	263029001088 GMW1025-C04
descripción	filtro de red microondas para GMW1025 250V 50/60Hz conductor 2 placa electrónica empalme conector Faston 4,8mm L 80mm H 20mm An 40mm placa electrónica UE 1 pzs longitud del cable 120mm tipo DNV-0818A-5		

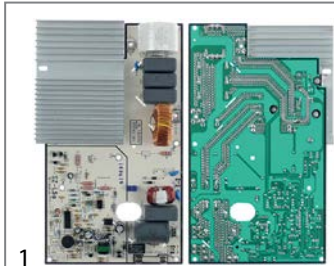

1			
código	403153	referencia	DQA010095R GIC3035-05 GIC3035-B05 GIC3500-05 GIC3500-A05 GIC3535-05 GIC3535-D05 GIC4035-05 GIC4035-C05
descripción	placa base aparato de inducción GIC3035 L 267mm An 160mm empalme conector Faston 6,3mm vertical empalme de teclado 4 pins de contacto SZ-L5		
Para modelos:	GIC3500, GIC3535, GIC4035		
accesorios para	403153		

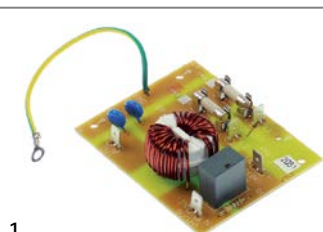

1			
código	403184	referencia	GMW1030-C04
descripción	filtro de red para microondas tipo GMW1030 250V 50/60Hz conductor 2 placa electrónica empalme conector Faston 6,3mm L 90mm H 20mm An 70mm placa electrónica UE 1 pzs longitud del cable 130mm		
Para modelos:	GMW1030		

código	403154	referencia	DQA020110R GIC3035-16 GIC3035-B16 GIC3535-16 GIC3535-D16
descripción	placa de teclado aparato de inducción GIC3035 L 247mm An 53mm empalme de teclado 4 pins de contacto edición desde 2012 tazas 8		



			
1			
código	403159	referencia	GIC3035-05 old GIC3035-B05 old GIC3535-05 old GIC3535-D05 old
descripción	placa base aparato de inducción GIC3535 L 265mm An 163mm empalme de teclado 7 pins de contacto		

			
1			
código	403325	referencia	010583510M
descripción	placa base para aparato de inducción GIC2035 L 236mm An 230mm hasta 06/2010		
Para modelos:	GIC2035		

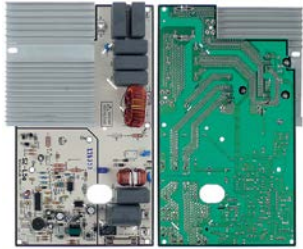
			
1			
código	403799	referencia	DQA010204R
descripción	placa base aparato de inducción HIC3500 L 265mm An 152mm		

			
1			
código	403460	referencia	GIC3500-A05 old
descripción	placa base para aparato de inducción L 265mm An 163mm empalme de teclado 7 pins de contacto		

			
1			
código	403715	referencia	HVS1000-42 YJS820-42
descripción	placa base envasadora al vacío HVS1000 L 88mm An 75mm		

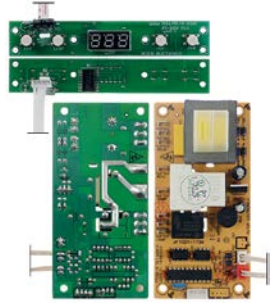
			
1			
código	361873	referencia	1.1.A.A17.01.01 1.1.A.A17.04.06 1.1.A.A17.04.06+1.1.A.A17.01.01 GGC2270-31 GGC2270-49
descripción	placa de control escaparate refrigerado GGC 1270/2270 longitud del cable 225mm 2 piezas tipo KB3150		
Para modelos:	GGC1270		

			
1			
código	402960	referencia	01059332M
descripción	placa base para aparato de inducción GIC2030 L 237mm An 231mm		
Para modelos:	GIC2030		

			
1			
código	403168	referencia	GMW1030-C17 old
descripción	placa de control microondas GMW1030 L 335mm An 50mm con indicación		

			
1			
código	403653	referencia	GMW1030-C17
descripción	placa de control microondas GMW1030 L 375mm An 50mm con indicación		
Para modelos:	GMW1030		



código	403798	referencia	DQA020344R
descripción	placa de display aparato de inducción HIC3500 L 50mm An 48mm		



código	403529	referencia	263019008956 GMW1025-C17
descripción	placa de display microondas GMW1025 L 160mm An 85mm longitud del cable 200mm para microondas		



código	403154	referencia	DQA020110R GIC3035-16 GIC3035-B16 GIC3535-16 GIC3535-D16
descripción	placa de teclado aparato de inducción GIC3035 L 247mm An 53mm empalme de teclado 4 pins de contacto edición desde 2012 tazas 8		
Para modelos:	GIC3535		
accesorios para	403154		

código	403156	referencia	GIC3035-17 GIC3035-B17 GIC3535-17 GIC3535-D17 GIC4035-17 GIC4035-C17 LAC5000003
descripción	panel de mando aparato de inducción GIC3535 An 300mm H 58mm		

código	403160	referencia	GIC3535-20 GIC3535-D20
descripción	panel de mando aparato de inducción GIC3535 An 300mm pos. de montaje derecho H 58mm		



código	403461	referencia	GIC3500-16 old GIC3500-A16 old
descripción	placa de teclado aparato de inducción GIC3500 L 247mm An 53mm empalme de teclado 7 pins de contacto tazas 8		



código	403212	referencia	909350
descripción	placa de teclado lavavajillas GDW1001/A670		
Para modelos:	GDW1001		



código	403161	referencia	GIC3035-16 old GIC3035-B16 old GIC3535-16 old GIC3535-D16 old
descripción	placa de teclado para aparato de inducción GIC3535/GIC4035 L 247mm An 53mm empalme de teclado 7 pins de contacto tazas 8		



código	403463	referencia	GIC3500-16 GIC3500-A16
descripción	placa de teclado para aparato de inducción L 247mm An 53mm empalme de teclado 4 pins de contacto tazas 8		



código	403462	referencia	GIC4035-16 old GIC4035-C16 old
descripción	placa de teclado para aparato de inducción L 247mm An 53mm empalme de teclado 7 pins de contacto tazas 8		



código	403717	referencia	HVS1000-25 YJS820-25
descripción	placa electrónica envasadora al vacío HVS1000 L 125mm An 100mm		

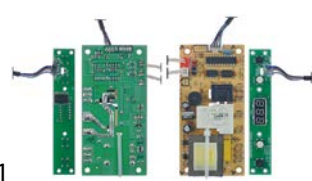

código	403664	referencia	A1.1.A.05.01.09
descripción	placa electrónica escaparate refrigerado GRV1100 incl. sonda		
Para modelos:	GRV1100		

1

código	403165	referencia	2852
descripción	placa electrónica GSM1000 regulación de revoluciones		
Para modelos:	GSM1000		
repuestos para	403165		
	código	referencia	2858
	 pomo para placa electrónica ø 26mm negro UE 1 pzs		



1

código	402915	referencia	909348
descripción	placa electrónica lavavajillas GDW1001 L 143mm An 122mm		
Para modelos:	GDW1001		



1

código	402965	referencia	907178
descripción	placa electrónica lavavajillas GGW2001 L 122mm An 80mm 50/60Hz 230/240V tensión AC		
Para modelos:	GGW2001		



1

código	403189	referencia	RW40.21
descripción	placa electrónica refrigerador GHR1040 L 60mm An 17.5mm UE 1 pzs		
Para modelos:	GHR1040, GHR2600		



1

código	402962	referencia	01059353M2
descripción	platina de control aparato de inducción GIC2035 L 257mm An 75mm edición desde 06/2010 tazas 6		
Para modelos:	GIC2035		



1

código	402961	referencia	01059331M
descripción	platina de control para aparato de inducción GIC2030 L 242mm An 69mm con display digital tazas 6		
Para modelos:	GIC2030		



1

código	403324	referencia	01059353M
descripción	platina de control para aparato de inducción GIC2035 L 257mm An 75mm edición hasta 06/2010 tazas 6		
Para modelos:	GIC2035		



1

código	403736	referencia	43845000 I9R00462
descripción	platina de control refrigeración IARP L 222mm An 40mm		
Para modelos:	GFR3600, GRE3600		

unidades centrales



1

código	401855	referencia	0000009240
descripción	caja electrónica con interruptor a presión doble para cortadora de fiambre 230V		
Para modelos:	GFS1030		



1

código	400788	referencia	00000000297
descripción	caja electrónica para cortadora de fiambre 230V		
Para modelos:	GFS1022, GFS1025, GFS1030, GFS2022, GFS2025, HFS2022, HFS2025		



1

código	403682	referencia	00000001752
descripción	caja electrónica para cortadora de fiambre 230V 50Hz edición desde 04/2016		
Para modelos:	HFS2019		

teclados

membranas de teclado



1

código	511647	referencia	909127
descripción	membrana de teclado para lavavajillas gris L 409mm An 57mm		
Para modelos:	GGW1001		



1

código	511648	referencia	909198
descripción	membrana de teclado para lavavajillas gris L 409mm An 57mm		
Para modelos:	GGW2001		



1

código	403156	referencia	GIC3035-17 GIC3035-B17 GIC3535-17 GIC3535-D17 GIC4035-17 GIC4035-C17 LAC5000003
descripción	panel de mando aparato de inducción GIC3535 An 300mm H 58mm		
Para modelos:	GIC3535, GIC4035		
accesorios para	403156		



código	403154	referencia	DQA020110R GIC3035-16 GIC3035-B16 GIC3535-16 GIC3535-D16
---------------	--------	-------------------	--

placa de teclado aparato de inducción GIC3035 L 247mm An 53mm empalme de teclado 4 pins de contacto edición desde 2012 tazas 8

teclados de membrana

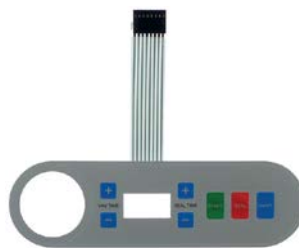

1

código	403718	referencia	HVS1000-36 YJS820-36
descripción	teclado de membrana envasadora al vacío HVS1000 L 190mm An 55mm		



1

código	403187	referencia	253069002692 GMW1025-C18
descripción	teclado de membrana microondas GMW1025 2 piezas tazas 15 UE 1 pzs L 164mm An 70mm		



1

código	403186	referencia	GMW1030-C18
descripción	teclado de membrana microondas tazas 18 UE 1 pzs L 386mm An 42mm		
Para modelos:	GMW1030		

paneles de mando



1

código	403160	referencia	GIC3535-20 GIC3535-D20
descripción	panel de mando aparato de inducción GIC3535 An 300mm pos. de montaje derecho H 58mm		
Para modelos:	GIC3535		
accesorios para	403160		



código	403154	referencia	DQA020110R GIC3035-16 GIC3035-B16 GIC3535-16 GIC3535-D16
---------------	--------	-------------------	--

placa de teclado aparato de inducción GIC3035 L 247mm An 53mm empalme de teclado 4 pins de contacto edición desde 2012 tazas 8



válvulas magnéticas

válvulas magnéticas agua

DELTROL

válvulas magnéticas con reducciones



1



código	370662	referencia	00000729
descripción	válvula magnética simple acodado 220-240VAC entrada 3/4" salida 11,5mm DELTROL DSVP40-X-2-B-.25-3 plástico reducción salida gris		
Para modelos:	GIM1023, GIM2023		









1













código	370663	referencia	00000887
descripción	válvula magnética simple acodado 220-240VAC entrada 3/4" salida 11,5mm DELTROL DSVP40-X-2-B-0.5-3 plástico reducción salida azul		
Para modelos:	GIM1038, GIM2038		



TP



1

código	370021	referencia	902400
descripción	válvula magnética doble recto 230VAC entrada 3/4" salida 11,5mm DN10 TP reducción entrada A blanco		
Para modelos:	GGW2001		
repuestos para	370021		
	código	371013	referencia —
		bobina magnética TP 230VAC 50/60Hz	
accesorios para	370021		
	código	371220	referencia —
		reducción TP velocidad de flujo 3l/min rojo tolerancia ±15%	
	código	371221	referencia —
		reducción TP velocidad de flujo 5.5l/min amarillo tolerancia ±15%	
	código	371222	referencia —
		reducción TP velocidad de flujo 6l/min gris tolerancia ±15%	
	código	371223	referencia —
		reducción TP velocidad de flujo 10l/min blanco tolerancia ±15%	
	código	371224	referencia —
		reducción TP velocidad de flujo 12l/min bronce tolerancia ±15%	

accesorios para	370021		
	código	371225	referencia —
		reducción TP velocidad de flujo 16l/min marrón claro tolerancia ±15%	
	código	371226	referencia —
		reducción TP velocidad de flujo 20l/min rojo tolerancia ±15%	
	código	371230	referencia —
		reducción TP velocidad de flujo 0.25l/min rojo tolerancia ±25%	
	código	371231	referencia —
		reducción TP velocidad de flujo 0.35l/min violeta tolerancia ±25%	
	código	371232	referencia —
		reducción TP velocidad de flujo 0.5l/min naranja tolerancia ±25%	
	código	371233	referencia —
		reducción TP velocidad de flujo 0.8l/min blanco tolerancia ±25%	
	código	371234	referencia —
		reducción TP velocidad de flujo 1l/min azul claro tolerancia ±25%	
	código	371235	referencia —
		reducción TP velocidad de flujo 1.2l/min marrón tolerancia ±25%	
	código	371236	referencia —
		reducción TP velocidad de flujo 1.5l/min marrón claro tolerancia ±25%	
	código	371237	referencia —
		reducción TP velocidad de flujo 2.5l/min amarillo tolerancia ±25%	
	código	371238	referencia —
		reducción TP velocidad de flujo 3.4l/min verde oscuro tolerancia ±25%	
	código	371239	referencia —
		reducción TP velocidad de flujo 5l/min negro tolerancia ±25%	
	código	371240	referencia —
		reducción TP velocidad de flujo 8l/min azul tolerancia ±20%	

1

código	370017	referencia	902390
descripción	válvula magnética simple recto 230VAC entrada 3/4" salida 11,5mm DN10 TP p.máx. 10bar		
Para modelos:	GDW1001, GGW1001		
repuestos para	370017		
	código	371013	referencia —
		bobina magnética TP 230VAC 50/60Hz	
accesorios para	370017		
	código	371220	referencia —
		reducción TP velocidad de flujo 3l/min rojo tolerancia ±15%	

Continúa en la página siguiente



accesorios para 370017	
	código 371221 referencia — reducción TP velocidad de flujo 5.5l/min amarillo tolerancia ±15%
	código 371222 referencia — reducción TP velocidad de flujo 6l/min gris tolerancia ±15%
	código 371223 referencia — reducción TP velocidad de flujo 10l/min blanco tolerancia ±15%
	código 371224 referencia — reducción TP velocidad de flujo 12l/min bronce tolerancia ±15%
	código 371225 referencia — reducción TP velocidad de flujo 16l/min marrón claro tolerancia ±15%
	código 371226 referencia — reducción TP velocidad de flujo 20l/min rojo tolerancia ±15%
	código 371230 referencia — reducción TP velocidad de flujo 0.25l/min rojo tolerancia ±25%
	código 371231 referencia — reducción TP velocidad de flujo 0.35l/min violeta tolerancia ±25%
	código 371232 referencia — reducción TP velocidad de flujo 0.5l/min naranja tolerancia ±25%
	código 371233 referencia — reducción TP velocidad de flujo 0.8l/min blanco tolerancia ±25%
	código 371234 referencia — reducción TP velocidad de flujo 1l/min azul claro tolerancia ±25%
	código 371235 referencia — reducción TP velocidad de flujo 1.2l/min marrón tolerancia ±25%
	código 371236 referencia — reducción TP velocidad de flujo 1.5l/min marrón claro tolerancia ±25%
	código 371237 referencia — reducción TP velocidad de flujo 2.5l/min amarillo tolerancia ±25%
	código 371238 referencia — reducción TP velocidad de flujo 3.4l/min verde oscuro tolerancia ±25%
	código 371239 referencia — reducción TP velocidad de flujo 5l/min negro tolerancia ±25%
	código 371240 referencia — reducción TP velocidad de flujo 8l/min azul tolerancia ±20%

diversos



1

código	374094	referencia	HVS1000-45 YJS820-45
descripción	válvula magnética acodado 2 vías entrada 4,5mm salida 4,5mm longitud del cable 300mm		



1

código	374093	referencia	HVS1000-41 YJS820-41
descripción	válvula magnética simple 2 vías 12VDC entrada 11mm salida 11mm apto para salida		

metal

ASCO

recambios y accesorios

juntas tóricas



1

código	371100	referencia	YJS820-4
descripción	junta tórica silicona espesor 1.78mm int.ø 6.07mm UE 1 pzs		

válvulas magnéticas refrigeración

diversos

válvulas



1

código	370373	referencia	76-0239-3
descripción	válvula magnética acodado DN1,9 empalme 6mm conexión para soldadura refrigeración acodado 90° 230V		
Para modelos:	GIM1023, GIM1038, GIM2023, GIM2038		
repuestos para	370373		
	código	371144	referencia 000001144
	bobina magnética 230V 50/60Hz refrigeración		

recambios y accesorios

solenoides



código	371144	referencia	000001144
descripción	bobina magnética 230V 50/60Hz refrigeración		
Para modelos:	GIM1023, GIM1038, GIM2023, GIM2038		

Válvulas magnéticas - accesorios



código	371100	referencia	YJS820-4
descripción	junta tórica silicona espesor 1.78mm int.ø 6.07mm UE 1 pzs		

presostatos

para sistemas de lavado

ø58mm con conector Faston 6,3mm

con empalme horizontal



código	541017	referencia	905270
descripción	presostato con abrazadera de montaje margen de presión 40/20mbar empalme 6mm ø 58mm conexión de presión horizontal sistemas de lavado		
Para modelos:	GGW1001, GGW2001		



código	541330	referencia	905283
descripción	presostato margen de presión 70/30mbar empalme 6mm ø 58mm conexión de presión horizontal sistemas de lavado empalme presión ø 6mm		
Para modelos:	GDW1001		

unidades condensadoras

código	379304***	referencia	123456
descripción			
Para modelos:			
repuestos para	605145		
código	420277	referencia	N/A RW40.05
descripción	resistencia 65W 220-240V L 120mm An 20mm H 21mm empalme Faston 6,3mm longitud del cable 300mm tubo ø 12mm refrigeración		

compresores

ACC/ZEL

R134A

LBP monofásico

Temperatura baja de evaporación inferior a -20°C



código	605126	referencia	S900.41
descripción	compresor refrigerante R134a tipo OF1350A 220-240V 50Hz LBPkg 1/4HP consumo 158W capacidad cilindro 7.5 cm ³ RSIR H 183mm WWWWWW ZEL		
Para modelos:	GDS1134, GDS1600, GHS1134, GHS2134, GPS1134, GSA1134, GSF1134		

MBP monofásico

Temperatura media de evaporación superior a -20°C



código	605253	referencia	RN400.08 RN400.09 RN400.10
descripción	compresor refrigerante R134a tipo GTH93AA 220-240V 50Hz MBP 9.8kg 1/4HP capacidad cilindro 9.3 cm ³ RSIR/RSCR H 184mm WWWWWW		
Para modelos:	RN400		



R600A

LBP monofásico

Temperatura baja de evaporación inferior a -20°C



1

código	605141	referencia	DQYD0015 E27B6F1Z0001 GBC1002-15 GBC1003-15 GSC2336-33 S960.01
descripción	compresor refrigerante R600a tipo HPY12AAa 220-240V 50Hz LBP 8.8kg 1/5HP capacidad cilindro 12 cm ³ RSIR H 200mmWWWWWWWWW		
Para modelos:	GBC1002, GBC1003, GPS1600, GPS2600, GSA1600, GSA2600, GSC2336, GSD2600, GSF1600, GSF2600		



1

código	605147	referencia	RC600.08
descripción	compresor refrigerante R600a tipo HTH14AA 220-240V 50Hz LBP 9.37kg 1/4HP capacidad cilindro 14 cm ³ RSIR/RSCR H 183mmWWWWWWW		
Para modelos:	GRE2600		



1

código	605150	referencia	A1.1.A.A02.14 GCV1600-37 GRV1100 HCV1100
descripción	compresor refrigerante R600a tipo HVM10AA 220-240V 50Hz LBP 8.7kg 1/6HP capacidad cilindro 10 cm ³ RSIR H 180mmWWWWWWWWW		
Para modelos:	GRV1100		



1

código	650150	referencia	VRX1560.01
descripción	compresor refrigerante R600a tipo HVM67AA 220-240V 50Hz LBP 7.5kg 1/8HP capacidad cilindro 7 cm ³ RSIR H 180mmWWWW		
Para modelos:	GHS1600, GHS2600		



1

código	605142	referencia	1.1.A.A02.04 DQYD0014 GBC1001-14 GGC1078-46
descripción	compresor refrigerante R600a tipo HVM86AA 220-240V 50Hz LBP completamente hermético 7.83kg 01. JulHP capacidad cilindro 8.6 cm ³ RSIR H 174mmWWWW		
Para modelos:	GBC1001		



1

código	605251	referencia	RC400.07 RC400.08 RC400.09
descripción	compresor refrigerante R600a tipo HVT10AA 220-240V 50Hz LBP 7.8kg 1/6HP capacidad cilindro 10 cm ³ RSCR H 174mmWWWW		
Para modelos:	RC400		



EMBRACO / ASPERA

R290A

LBP monofásico

Temperatura baja de evaporación inferior a -20°C



1

código	605258	referencia	I0210981
descripción	compresor refrigerante R290 tipo EMTE2134U 220-240V 50Hz LBP 9kg 3/8HP capacidad cilindro 9.5 cm ³ CSIR H 187mm 250W 278W 305W 330W 366WWWWWW		
Para modelos:	GFR3600		

R600A

LBP monofásico

Temperatura baja de evaporación inferior a -20°C



1

código	605257	referencia	45004031
descripción	compresor refrigerante R600a tipo EMD46CLT 220-240V 50Hz LBP 7.5kg capacidad cilindro 7.96 cm ³ RSCR H 210mm 88W 118W 154W 196W 246WWWWWW		
Para modelos:	GRE3600		

otros

R134A



1

código	605240	referencia	HSC800-07
descripción	compresor HuaGuang refrigerante R134a tipo AN150ML 220-240V 50Hz LBP 10.5kg 1/2HP capacidad cilindro 15.1 cm ³ CSIR H 180mmWWWWWWWWWW		



1

código	605239	referencia	DQYA0009 HBC2003-15
descripción	compresor HuaGuang refrigerante R134a tipo ANA90 220-240V 50Hz LBP 10.5kgHP consumo 255W capacidad cilindro cm ³ H 180mmWWWWWWWWWW		



1

código	605245	referencia	DQYA0014 HSC350-07 HSC350-7 HSC360-11
descripción	compresor HuaGuang refrigerante R134a tipo ATA72XL 220-240V 50/60Hz 7.2kg 1/5HP capacidad cilindro 7 cm ³ H 160mmWWWWWWWWWW		



1			
código	605140	referencia	DQYA0087 GSC1100-28 GSC1336-33
descripción	compresor KONOR tipo GQR90AA refrigerante R134a 220-240V 50Hz 10.1kg 1/4HP capacidad cilindro 9.1 cm ³ RSIR H 186mmWWWWWWWW		
Para modelos:	GSC1100, GSC1336		



1			
código	605272	referencia	DQYD0009 HSC350DD07 HSC360G-08
descripción	compresor HuaGuang refrigerante R600 tipo ETA110 220-240V 50Hz LBP 8kg 1/4HP RSIR		

accesorios

relé de arranque

otros



1			
código	605148	referencia	RN600.06
descripción	compresor KULTHORN tipo AEA2415Y refrigerante R134a 220-240V 50Hz		
Para modelos:	GFR2600		



1			
código	381450	referencia	RC600.13 RC600.14 RC600.14+RC600.13
descripción	relé de arranque 230V 16A		
Para modelos:	GRE2600		

R600A



1			
código	605143	referencia	1.1.A.A02.25 GGC2270-12
descripción	compresor DONPER tipo QD167YU refrigerante R600a 220-240V 50Hz completamente hermético 11.9kg consumo 276W capacidad cilindro 16.7 cm ³ RSCR H 220mm 169W 199W 236W 280W 334W 391WWWWWW metodo de test ASHRAE condensador 6µF		
Para modelos:	GGC1270		



1			
código	381449	referencia	RN600.09
descripción	relé de arranque KULTHORN KME 682-26NT 230V 16A		
Para modelos:	GFR2600		

interrupor térmico (klixon)

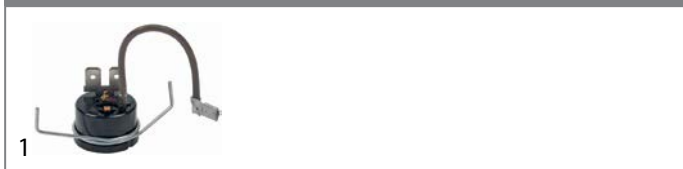

1			
código	391044	referencia	RN600.08
descripción	interrupor térmico para protección de motor térmica Klixon con cable T máx 105°C		
Para modelos:	GFR2600		

otros



1

código	699425	referencia	1.1.C.C41.01 GGC1078-45
descripción	amortiguador de vibraciones ø 25mm H 10mm		

ventiladores

ventilador axial

ebm-papst



1

código	601813 ¹	referencia	RC600.33
descripción	ventilador axial L 119mm An 119mm H 38mm 230VAC 50/60Hz 19W cojinete rodamiento de bolas N° fabricante 4656N/A02 longitud del cable 800mm metal empalme conector ebm-papst rodete ventilador ø 110mm		
Para modelos:	GRE2600		

¹con cojinete de fricción

importación



1

código	601131 ¹	referencia	I0221151
descripción	ventilador axial L 119mm An 119mm H 25mm 230VAC 50/60Hz 19/18W cojinete rodamiento de bolas empalme conector Faston 2,8mm metal ADDA rodete ventilador ø 110mm resis.a la temp. 70°C		
Para modelos:	GFR3600		
accesorios para	601131		
	código	550898	referencia I0221181
	cable de conexión longitud del cable 2000mm empalme F 2,8 distancia de empalme 7.9mm para ventilador axial		

¹con rodamiento de bolas



1

código	601909 ¹	referencia	45003031
descripción	ventilador axial L 119mm An 119mm H 38mm 220-240 50/60Hz 31/29W cojinete rodamiento de bolas empalme conector Faston 2,8mm		
Para modelos:	GFR3600, GRE3600		

¹con rodamiento de bolas



1

código	601834 ¹	referencia	1.1.A.A03.01.31 GCV1600-34
descripción	ventilador axial L 119mm An 119mm H 38mm 230VAC 50/60Hz 16/15W cojinete rodamiento de bolas N° fabricante RAM1238B1 empalme cable longitud del cable 900mm XINRUILIAN rodete ventilador ø 110mm resis.a la temp. -10 a +70°C consumo de corriente 0.16A		

¹con rodamiento de bolas



1

código	601604 ¹	referencia	E17A1A01010 GPS1600-34 GSF1600-34 S900.34
descripción	ventilador axial L 119mm An 119mm H 38mm 230VAC 50/60Hz 17/15W cojinete cojinete de fricción N° fabricante AA1282HS-AT empalme cable 300mm rodete ventilador ø 110mm resis.a la temp. 70°C consumo de corriente 0.1A caudal 130m ³ /h 2600rev/min		
Para modelos:	GDS1134, GDS1600, GHS1134, GHS1600, GHS2134, GHS2600, GPS1134, GPS1600, GPS2600, GSA1134, GSA1600, GSA2600, GSD2600, GSF1134, GSF1600, GSF2600		

¹con cojinete de fricción



1

código	602136	referencia	DQFD2003
descripción	ventilador axial L 119mm An 119mm H 38mm 230VAC 50/60Hz 22/38,4W cojinete cojinete de fricción N° fabricante HT-A12038S220 empalme con cable 500mm longitud del cable 300mm HUITONG rodete ventilador ø 110mm consumo de corriente 0,1/0,16A carcasa aluminio		
Para modelos:	GBC1001, GBC1002, GBC1003		



1

código	601787 ¹	referencia	DQFA1000 DQFD1000 DQFD1001 GBC1001-07 GBC1001-35 GBC1002-36 GBC1003-36 GSC1100-17 GSC1336-15 GSC2336-15 HSC360-30 HSC800-44
descripción	ventilador axial L 119mm An 119mm H 38mm 230VAC 50/60Hz 22/38,4W cojinete cojinete de fricción N° fabricante HT-A12038S220 empalme conector longitud del cable 300mm HUITONG rodete ventilador ø 110mm consumo de corriente 0,1/0,16A carcasa aluminio		
Para modelos:	GBC1001, GSC1100, GSC1100G, GSC1336, GSC2336		

¹con cojinete de fricción

1

código	601743	referencia	01058355
descripción	ventilador axial L 80mm An 80mm H 25mm 18VDC 1.8W empalme conector codificado longitud del cable 300mm		
Para modelos:	GIC2030, GIC2035		

accesorios

rejillas ventiladores



1

código	691104	referencia	GBC1001-36 GBC1002-37 GBC1003-37 GSC1336-13 GSC2336-13 HSC350-43 I0427017 WJFZ0007
descripción	rejilla de protección ø 115mm distancia de sujeción 105mm para ventilador axial 119mm		
Para modelos:	GBC1001, GBC1002, GBC1003, GFR3600, GRE3600, GSC1336, GSC2336		

cables de conexión



1

código	550898	referencia	I0221181
descripción	cable de conexión longitud del cable 2000mm empalme F 2,8 distancia de empalme 7.9mm para ventilador axial		
Para modelos:	GFR3600, GRE3600		

ventiladores para frigoríficos

motores refrigeración universales

ebm-papst

otros



1

código	601783	referencia	E17A1A050500 GPS1600-37 GSF1600-37 S900.37
descripción	motor de ventilador 10W 230V 50/60Hz L3 87mm An 67mm longitud del cable 400mm 1300rev/min ebm-papst M4Q045-CA03-51/C18 3 opciones de sujeción cojinete cojinete de fricción para mesas frías		
Para modelos:	GDS1134, GDS1600, GPS1134, GPS1600, GPS2600, GSA1134, GSA1600, GSA2600, GSD2600, GSF1134, GSF1600, GSF2600		
repuestos para	601783		
	código	601413	referencia —
	placa de sujeción apto para rodete ventilador ø ext. 32mm eje ø 7 distancia de sujeción 26mm		
accesorios para	601783		
	código	601385	referencia 30-0566-9 E181A1723401
	rodete ventilador aspirante ø 172mm fijación asta 25.4mm inclinación de la pala 34° An 42mm aluminio		



1

código	601736	referencia	20-0020-9
descripción	motor de ventilador M4Q045-BD01-05/S01 5W 230V 60Hz L1 45mm L3 75mm An 60mm longitud del cable 300mm 1550rev/min ebm-papst doble		
Para modelos:	GIM1023, GIM2023		
repuestos para	601736		
	código	601413	referencia —
	placa de sujeción apto para rodete ventilador ø ext. 32mm eje ø 7 distancia de sujeción 26mm		

ELCO

serie N - estándar



1

código	601735	referencia	0221115
descripción	motor de ventilador ELCO 5W 230V 50/60Hz cojinete cojinete de fricción L3 71mm An 59mm empalme Kabel 1430mm longitud del cable 1500mm 1300/1550rev/min 3 opciones de sujeción VN5-13/249		
Para modelos:	GRE1600		

otros



1

código	601789	referencia	1.1.A.A03.01.10 GGC2270-48
descripción	motor de ventilador 10W 220-240V 50/60Hz L1 50mm L2 72mm L3 90mm An 84mm longitud del cable 460mm 1300rev/min HANGZOU SAIWEI MOTOR YZ10-20		
Para modelos:	GGC1270		
repuestos para	601789		
	código	601413	referencia —
	placa de sujeción apto para rodete ventilador ø ext. 32mm eje ø 7 distancia de sujeción 26mm		



1

código	601737	referencia	20-0021-9
descripción	motor de ventilador 16W 230V 60Hz L1 43mm L3 87mm An 72mm longitud del cable 500mm 1550rev/min ebm-papst M4Q045-CF01-05/S01		
Para modelos:	GIM1038, GIM2038		
repuestos para	601737		
	código	601413	referencia —
	placa de sujeción apto para rodete ventilador ø ext. 32mm eje ø 7 distancia de sujeción 26mm		



1	código	602164	referencia	GSC1100G-07
descripción motor de ventilador 10W 220-240V 50-60Hz L2 65mm L3 81mm An 82mm longitud del cable 1200mm 1300/1500rev/min HL-YJF10				

accesorios

rodetes de ventilador

aluminio

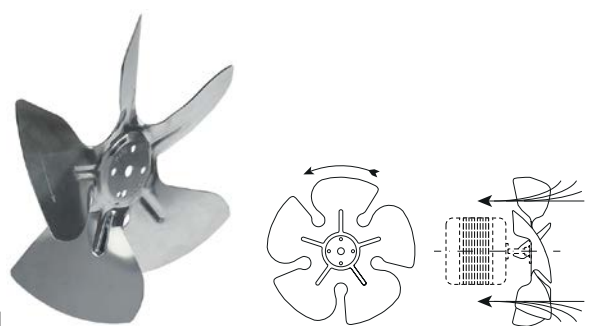

1	código	601385	referencia	30-0566-9 E181A1723401
descripción rodete ventilador aspirante ø 172mm fijación asta 25.4mm inclinación de la pala 34° An 42mm aluminio				
Para modelos: GIM1023, GIM2023, GPS2600, GSA2600, GSD2600, GSF2600				

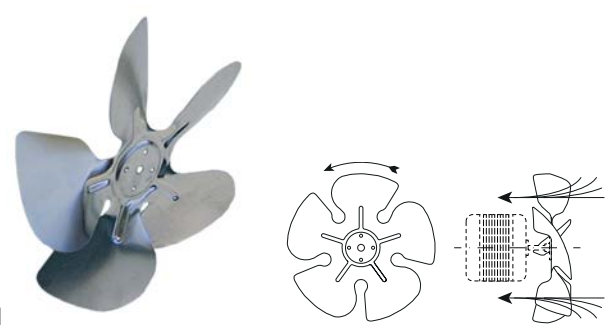

1	código	601069	referencia	0407004
descripción rodete ventilador aspirante ø 172mm sentido de rotación izquierdo fijación asta 25.4mm inclinación de la pala 25° An 32mm aluminio				
Para modelos: GRE1600				

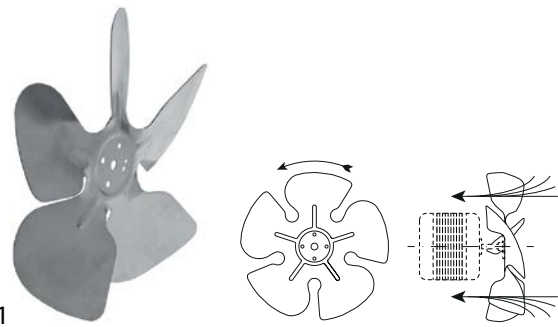

1	código	601070	referencia	1.1.A.A03.03.05 GGC2270-09 GGC2270-9
descripción rodete ventilador aspirante ø 200mm fijación asta 25.4mm inclinación de la pala 28° An 38mm aluminio				
Para modelos: GGC1270				

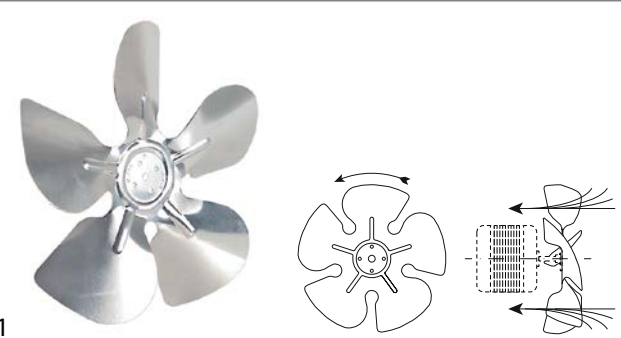

1	código	601283	referencia	30-0565-9
descripción rodete ventilador aspirante ø 230mm fijación asta 25.4mm inclinación de la pala 28° An 41mm aluminio				
Para modelos: GIM1038, GIM2038				

anillos de fijación



1	código	601586	referencia	0221128
descripción anillo para aspa ø 172mm aspirante ø 220mm H 49mm distancia de sujeción 1 208mm distancia de sujeción 2 94.5mm				
Para modelos: GRE1600				



rejillas ventiladores

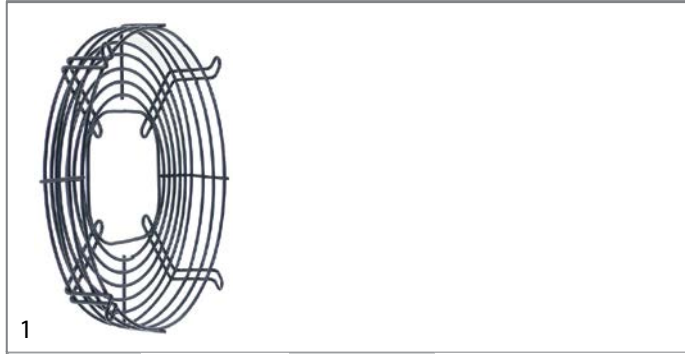

código	602101	referencia	E192A1200300 E192A1723800
descripción	rejilla de protección ø 210mm H 35mm distancia de sujeción 1 230mm distancia de sujeción 2 100mm		
Para modelos:	GPS2600, GSA2600, GSD2600, GSF2600		

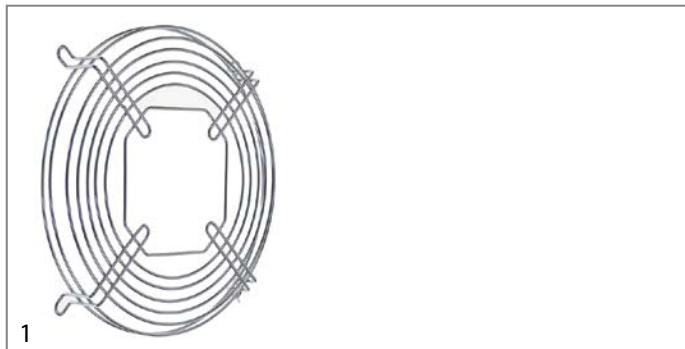

código	699432	referencia	1.1.B.B10.36 GGC2270-10
descripción	rejilla de protección ø 215mm distancia de sujeción 230mm		
Para modelos:	GGC1270		

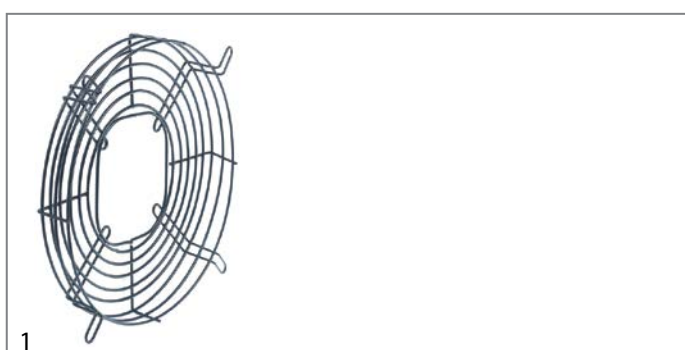

código	601738	referencia	GPS1600-38 GSF1600-38 S900.38
descripción	rejilla de protección para aspa ø 170mm ø 216mm H 30mm distancia de sujeción 1 224 a 254mm distancia de sujeción 2 94.5mm		
Para modelos:	GDS1134, GDS1600, GPS1134, GPS1600, GSA1134, GSA1600, GSF1134, GSF1600		

motores de refrigeración completos



código	601836	referencia	DQJB2004 GBC1002-07 GBC1003-07
descripción	ventilador 220V 25/3W 50/60Hz rodete ventilador ø 172mm L 82mm An 82mm empalme terminal de horquilla M4 longitud del cable 1000mm		
Para modelos:	GBC1002, GBC1003		



código	601835	referencia	DQJB2013 GSC1100-26
descripción	ventilador 220V 35/5W 50/60Hz L 82mm An 82mm empalme terminal de horquilla M4 longitud del cable 1100mm		
Para modelos:	GSC1100		

repuestos para	601835	código	602184	referencia	—
		placa de sujeción apto para rodete ventilador ø ext. 33mm eje ø 6 distancia de sujeción 17mm			



código	601791	referencia	1.1.A.A03.02.04 GGC2270-47
descripción	motor de ventilador par 220-240V 10W 50Hz rodete ventilador ø 110mm distancia de sujeción 137mm longitud del cable 800mm		
Para modelos:	GGC1270		

ventiladores de refrigeración

ventiladores de refrigeración

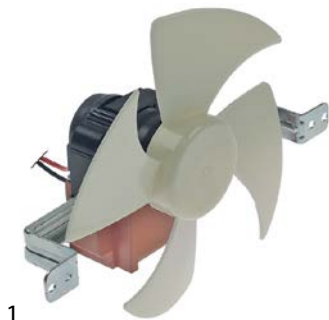

1

código	602078	referencia	A1.1.A.A03.01.08
---------------	--------	-------------------	------------------

descripción	motor de ventilador 220-240V 50Hz 5W eje \varnothing 4mm eje L 15mm L 205mm An 147mm H 80mm		
--------------------	---	--	--

Para modelos:	GRV1100
----------------------	---------

repuestos para	602078
-----------------------	--------



código	698913	referencia	
descripción	rodete ventilador soplado \varnothing 148mm soporte de eje \varnothing 3mm inclinación de la pala° An 17.5mm plástico UE 1 pzs palas 4		



1

código	601845	referencia	1.1.A.A03.01.08 GCG1078-40
---------------	--------	-------------------	-------------------------------

descripción	motor de ventilador 220-240V 50Hz IN 22W / OUT 5W eje \varnothing 4mm eje L 20/48mm L 65mm An 66mm H 73mm UE 1 pzs		
--------------------	--	--	--

accesorios para	601845
------------------------	--------



código	601846	referencia	1.1.C.C17.04 GCG1078-39
descripción	rodete ventilador soplado \varnothing 150mm soporte de eje \varnothing 4mm An 33mm plástico UE 1 pzs		

accesorios

aspas para ventiladores de refrigeración



1

código	698913	referencia	A1.1.A.A03.01.07
---------------	--------	-------------------	------------------

descripción	rodete ventilador soplado \varnothing 148mm soporte de eje \varnothing 3mm inclinación de la pala° An 17.5mm plástico UE 1 pzs palas 4		
--------------------	--	--	--

Para modelos:	GRV1100
----------------------	---------

VENTILADORES HORECA-SELECT



1

código	601846	referencia	1.1.C.C17.04 GCG1078-39
---------------	--------	-------------------	----------------------------

descripción	rodete ventilador soplado \varnothing 150mm soporte de eje \varnothing 4mm An 33mm plástico UE 1 pzs		
--------------------	--	--	--

ventiladores tangenciales

IMPORTACIÓN



1

código	601812	referencia	RC400.06 RC600.16
---------------	--------	-------------------	----------------------

descripción	ventilador tangencial YJ61-14A-HZ01 rodillo \varnothing 60mm L rodillo 180mm espesor de núcleo laminado 18mm posición del motor izquierdo 220-240V/50-60Hz 13W refrigeración cojinete goma empalme conector -30 a +100°C 220V longitud del cable 300mm 50Hz		
--------------------	---	--	--

Para modelos:	GRE2600, RC400
----------------------	----------------

EMMEVI - FER GAS

con bobina estándar



1

código	601018	referencia	01202330 15950427000
---------------	--------	-------------------	-------------------------

descripción	ventilador tangencial TG 180 rodillo \varnothing 60mm L rodillo 180mm posición del motor derecho 230V/50Hz 25W universal cojinete silicona empalme conector Faston 6,3mm -10 a +60°C 230V empalmes 1-2 1950U/min empalmes 1-4 1500U/min		
--------------------	---	--	--

Para modelos:	GCO1001, GCO2001
----------------------	------------------

accesorios para ventiladores tangenciales

sujeciones



código	692388	referencia	RC600.17
descripción	soporte para soplador transversal L 295mm An 85mm H 25mm UE 1 pzs		
Para modelos:	GRE2600		

conductos de aire



código	701630	referencia	00012330
descripción	conducto de aire para soplador transversal para horno a vapor combinado plástico gris		
Para modelos:	GCO2001		

motores de aire caliente

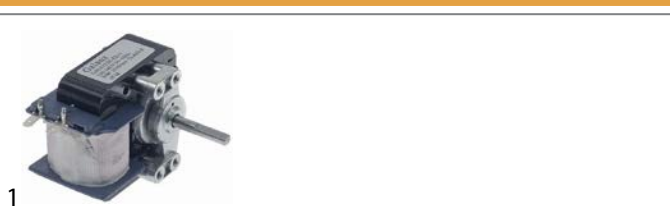

código	601865	referencia	GMW1030-C05
descripción	motor de ventilador 220-240V 50/60Hz 0.036kW 2500rev/min D1 ø 6mm consumo 18W a 50 Hz 2600rev/min longitud de la parte plana 18mm		
Para modelos:	GMW1030		

ventiladores de aire caliente

otros

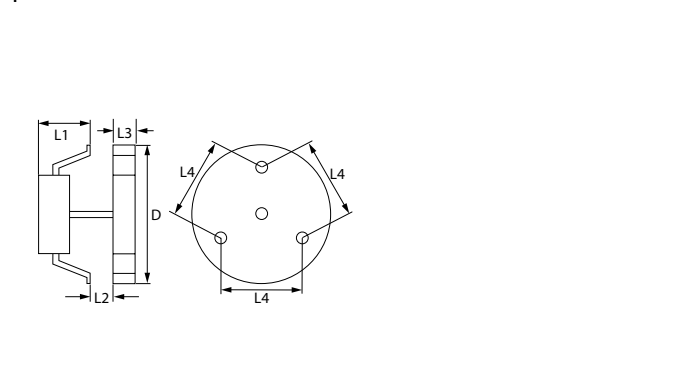

código	601125	referencia	11950057000	
descripción	ventilador de aire caliente 220-240V 45W 50/60Hz L1 70mm L2 11mm L3 25mm L4 87mm rodete ventilador ø 150mm FIME tipo C30R0479CLF			
Para modelos:	GCO1001			
accesorios para	601125			
	código	550879	referencia	—
	aislamiento ø 130mm espesor 3mm agujero ø 20mm para ventilador aire caliente			

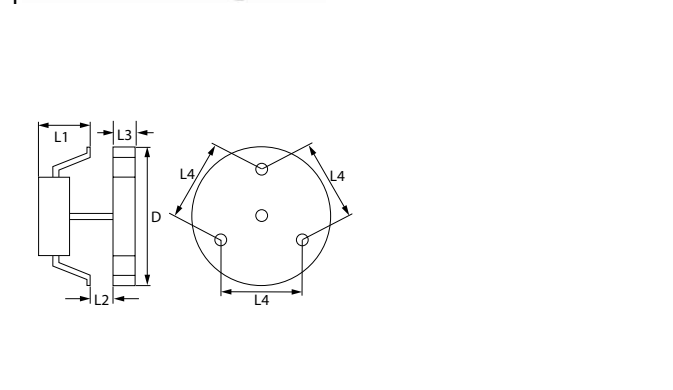

código	602100	referencia	01203230
descripción	ventilador de aire caliente 240V 59W 50/60Hz L1 80mm L2 16mm rodete ventilador ø 150mm IMS tipo 138251		
Para modelos:	GCO2001		

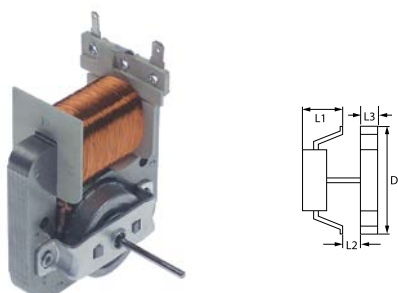

1

código	601838	referencia	278009000033 GMW1025-C05
descripción	motor de ventilador 220-240V 18W 2500rev/min L1 33mm L2 12mm L3 15mm L4mm rodete ventilador ø 120mm eje 2x2,5mm GALANZ tipo GAL6309E(30)-ZD UE 1 pzs		

accesorios

rodetes de ventilador para ventiladores de aire caliente



1

código	601839	referencia	223149000014 GMW1025-P06
descripción	rodete ventilador ø 120mm An 32mm soporte de eje ø 2x2,5mm plástico palas 4 UE 1 pzs		



1

código	602140	referencia	YHWF-110
descripción	ventilador de aire caliente 18V 2750rev/min L1 6mm L2mm L3 16mm L4mm rodete ventilador ø 85mm tipo YHWF-110		

otros



1

código	211088	referencia	09960218715
descripción	rejilla de protección L 155mm An 155mm para ventilador		
Para modelos:	GCO1001		



1

código	601827	referencia	DQB000019R GIC3035-15 GIC3035-B15 GIC3500-15 GIC3500-A15 GIC3535-15 GIC3535-D15 GIC4035-15 GIC4035-C15
descripción	ventilador de aire caliente 18V 2750rev/min L1 6mm L2mm L3 16mm L4mm rodete ventilador ø 85mm tipo YHWF-85		
Para modelos:	GIC3500, GIC3535, GIC4035		



1

código	601840	referencia	223139000011 GMW1025-P05
descripción	soporte ø 130mm L 135mm An 130mm para ventilador aire caliente UE 1 pzs		

ventiladores radiales

accesorios

rodetes de ventilador para ventiladores radiales



1

código	601837	referencia	GMW1030-P272
descripción	rodete ventilador para ventilador radial ø 96mm alojamiento del eje 4x5mm H 49mm palas 40 plástico UE 1 pzs		
Para modelos:	GMW1030		



accesorios en general

1



código	699309	referencia	HSC360-35 WJFZ0008
descripción	rejilla de protección ø 194mm dist. del agujero 208mm		

reguladores de revoluciones

1

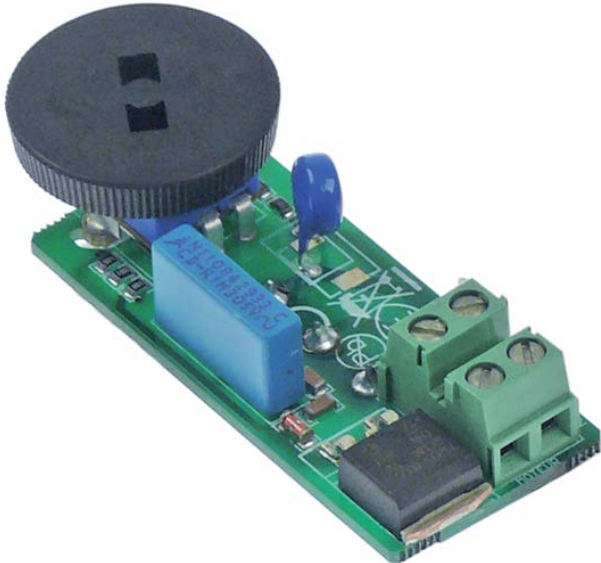

código	403165	referencia	2852
descripción	placa electrónica GSM1000 regulación de revoluciones		
Para modelos:	GSM1000		
repuestos para	403165		
	código	referencia	2858
	696506 pomo para placa electrónica ø 26mm negro UE 1 pzs		

motores

motorreductores

para microondas

1



código	601867	referencia	278019000017 GMW1025-C100
descripción	motorreductor GALANZ tipo GAL-33-30-TD(B) 4W 30V tensión AC 50/60Hz 33/40rev/min árbol ø 6x3,5mm para microondas UE 1 pzs		

1



código	601828	referencia	GMW1030-C100
descripción	motorreductor SYNCHRONOUS MOTOR tipo SM-16E 3W 220-240V tensión AC 50/60Hz 30/36rev/min árbol ø 6x3,5mm		
Para modelos:	GMW1030		

motores

para cortadoras de fiambre

1

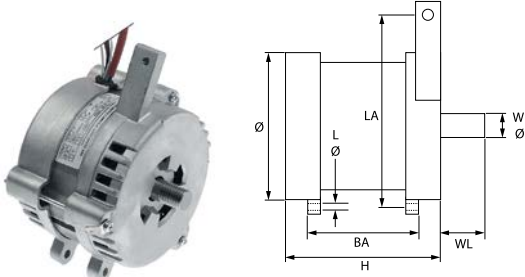

código	501530	referencia	00000001753
descripción	motor 230V fases 1 50Hz 1380rev/min árbol ø 15mm longitud árbol 25mm 195-220 edición desde 04/2016		
Para modelos:	HFS2019		

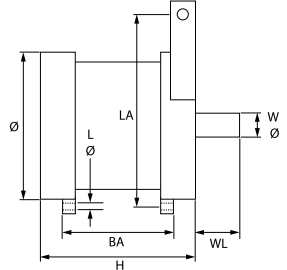
1

código	501427	referencia	00000700283
descripción	motor 230V fases 1 50Hz 1380rev/min árbol ø 15mm longitud árbol 25mm ø 115mm H 86mm distancia de sujeción 44mm dist. del agujero 145mm agujero ø 6mm tipo H35-700283		
Para modelos:	GFS1022, GFS2022, HFS2019, HFS2022		

1

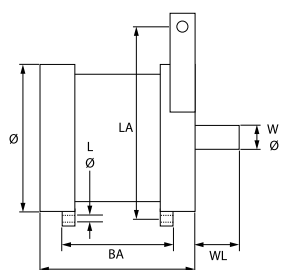
código	501434	referencia	00000000423
descripción	motor 230V fases 1 50Hz 1380rev/min árbol ø 15mm longitud árbol 33mm ø 113mm H 91mm distancia de sujeción 49mm dist. del agujero 150mm agujero ø 6mm tipo H40-423 ELETTRMECANICA condensador 8µF		
Para modelos:	GFS1025, GFS2025, HFS2025		



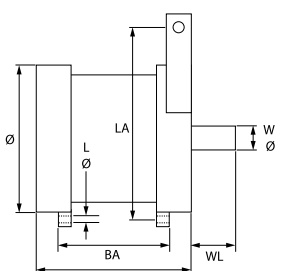

1

código	501433	referencia	00000000681
descripción	motor 230V fases 1 50Hz 1380rev/min árbol ø 15mm longitud árbol 35mm ø 113mm H 121mm distancia de sujeción 79mm dist. del agujero 150mm agujero ø 6mm tipo H70-681 ELETTRMECANICA condensador 10µF		
Para modelos:	GFS1030		

para mixers a inmersión

motores



1

código	698378	referencia	2847
descripción	motor para triturador portátil 230V 100W árbol ø 6.4mm GSM1000		
Para modelos:	GSM1000		

para exprimidores



1

código	501426	referencia	900956
descripción	motor para exprimidor 180W 230-240V 50Hz árbol ø 8mm longitud árbol 40mm tipo RCJ298252 0.18kW		
Para modelos:	GJU1001		

bombas

bombas de lavado y aclarado

LGB



1

código	500567	referencia	902238	
descripción	bomba entrada ø 28mm salida ø 28mm tipo ZF121DX 230V 50Hz fases 1 0.25kW L 195mm dirección de rodadura izquierdo condensador 6.3µF LGB			
Para modelos:	GGW1001, GGW2001			
repuestos para	500567			
	código	365012	referencia	00000000149
	condensador de servicio capacidad 6.3µF 450V tolerancia 5% 50Hz temperatura ambiente máx. -25 a + 85°C ø 30mm L 61mm M8 plástico empalme conector Faston 6,3mm protección			
	código	510703	referencia	—
	sello mecánico para árbol ø 13mm anillo deslizante H 13mm altura contraarandela 5.5mm ø ext. 26mm			

Continúa en la página siguiente

repuestos para	500567			
	código	521098	referencia	—
	cubierta de bomba LGB entrada ø 28mm salida ø 26mm presión secundaria 12mm int.ø 77mm			
	código	521099	referencia	—
	rotor ø 72mm H 17mm rosca M7R árbol ø 13mm longitud árbol 12mm			
	código	528800	referencia	—
	junta tórica EPDM espesor 2.62mm int.ø 75.87mm UE 1 pzs			



código	500470	referencia	902304	
descripción	bomba entrada ø 45mm salida ø 40mm tipo ZF270VDX 230V 50Hz fases 1 0.6kW 0.8PS L 225mm dirección de rodadura izquierdo condensador 12.5µF LGB			
Para modelos:	GDW1001			
repuestos para	500470			
	código	365014	referencia	—
	condensador de servicio capacidad 12.5µF 450V tolerancia 5%Hz temperatura ambiente máx. -25 a + 85°C ø 35mm L 70mm M8 plástico empalme conector Faston 6,3mm 45S.C3DS.12,5 protección			
	código	510702	referencia	—
	sello mecánico altura contraarandela 5.5mm int.ø 12mm			
	código	521109	referencia	—
	cubierta de bomba LGB entrada ø 45mm salida ø 40mm presión secundaria 12			
	código	521111	referencia	—
	rotor ø 105mm H 29mm rosca M8R árbol ø 20mm longitud árbol 5mm			
	código	521714	referencia	—
	junta de tapa de bomba espesor 4x4mm UE 1 pzs			

bombas de salida

GRE



1

código	499121	referencia	902328
descripción	bomba de desagüe entrada ø 24mm salida ø 22mm 33W 230V 50Hz GRE		
Para modelos:	GGW1001		



1

código	500959	referencia	902346
descripción	bomba de desagüe entrada ø 30mm salida ø 23mm 100W 230V 50Hz GRE		
Para modelos:	GDW1001		

bombas de aumento de presión II

accesorios



1

código	365015	referencia	0000000633
descripción	condensador de servicio capacidad 10µF 400V tolerancia 5%Hz temperatura ambiente máx. -25 a + 85°C ø 35.5mm L 59mm M8 plástico empalme conector Faston 6,3mm protección		
Para modelos:	GFS1030		



1

código	365012	referencia	0000000149
descripción	condensador de servicio capacidad 6.3µF 450V tolerancia 5% 50Hz temperatura ambiente máx. -25 a + 85°C ø 30mm L 61mm M8 plástico empalme conector Faston 6,3mm protección		
Para modelos:	GFS1022		

bombas para máquinas de cubitos de



1

código	499118	referencia	040000038
descripción	bomba HANNING tipo DP025-258 30W 220-240V 50Hz entrada ø 24mm salida ø 24mm L 130mm para máquina de hielo en cubitos Kit		
Para modelos:	GIM1038, GIM2038		



1

código	499125	referencia	040000036
descripción	bomba HANNING tipo DP025-258 30W 220-240V 50Hz entrada ø 24mm salida ø 24mm para máquina de hielo en cubitos Kit		
Para modelos:	GIM1023, GIM2023		

bombas de vacío

bombas de vacío



1

código	602111	referencia	HVS1000-30 YJS820-30
descripción	bomba de vacío 220/240V 0.32kW 50Hz tipo OLF400Z		

condensadores y filtros antiparasitarios

condensadores de arranque

condensadores de arranque



1

código	365214	referencia	RC600.12
descripción	condensador de arranque 5µF 450V 50/60Hz ciclo de trabajo 5% ø 35mm L 60.5mm empalme conector Faston 4,8mm		
Para modelos:	GRE2600		



1

código	365153	referencia	0210402
descripción	condensador de arranque 52µF 330V 50/60Hz ciclo de trabajo 3s 41280A133 2252347 ø 36mm L 83mm M8 plástico empalme cable 350mm		
Para modelos:	GRE1600		

condensadores de servicio

plástico



1

código	365015	referencia	0000000633
descripción	condensador de servicio capacidad 10µF 400V tolerancia 5%Hz temperatura ambiente máx. -25 a + 85°C ø 35.5mm L 59mm M8 plástico empalme conector Faston 6,3mm protección		
Para modelos:	GFS1030		



1

código	365012	referencia	0000000149
descripción	condensador de servicio capacidad 6.3µF 450V tolerancia 5% 50Hz temperatura ambiente máx. -25 a + 85°C ø 30mm L 61mm M8 plástico empalme conector Faston 6,3mm protección		
Para modelos:	GFS1022		



			
1			
código	365013	referencia	00000000182
descripción	condensador de servicio capacidad 8µF 400V tolerancia 5%Hz temperatura ambiente máx. -25 a + 85°C ø 31.5mm L 55mm M8 plástico empalme conector Faston 6,3mm protección		
Para modelos:	GFS1025, GFS2022, GFS2025, HFS2019, HFS2022, HFS2025		

filtros

filtros antiparasitarios

			
1			
código	365168	referencia	902107
descripción	filtro antiparasitario tipo FCP045000 250V 50/60Hz conductor 4 con T empalme conector Faston 6,3mm L 56mm ø 38mm Hmm Anmm M8 plástico UE 1 pzs		
Para modelos:	GDW1001		

filtros de red

sin caja

			
1			
código	403188	referencia	263029001088 GMW1025-C04
descripción	filtro de red microondas para GMW1025 250V 50/60Hz conductor 2 placa electrónica empalme conector Faston 4,8mm L 80mm H 20mm An 40mm placa electrónica UE 1 pzs longitud del cable 120mm tipo DNV-0818A-5		

			
1			
código	403184	referencia	GMW1030-C04
descripción	filtro de red para microondas tipo GMW1030 250V 50/60Hz conductor 2 placa electrónica empalme conector Faston 6,3mm L 90mm H 20mm An 70mm placa electrónica UE 1 pzs longitud del cable 130mm		
Para modelos:	GMW1030		

condensadores de alta tensión

			
1			
código	365158	referencia	GMW1030-C03
descripción	condensador de alta tensión para microondas 1.05µF tipo CH85-21105 2100V 50/60Hz doble empalme conector Faston 6,3mm L 90mm H 33mm An 52mm dipendente de aparato aluminio UE 1 pzs ømm		
Para modelos:	GMW1030		

			
1			
código	365159	referencia	253059000142 GMW1025-C03
descripción	condensador de alta tensión para microondas 1.15µF tipo CH85-21115 2100V 50/60Hz doble empalme conector Faston 4,8mm L 105mm H 33mm An 52mm dipendente de aparato aluminio UE 1 pzs		

fusibles

fusibles finos

			
1			
código	358186	referencia	DZJ020003
descripción	fusible medida ø6,3x32 15A retardado nominal 250V UE 1 pzs		

			
1			
código	358133	referencia	GIC3035-B06 GIC3500-A06 GIC3535-D06 GIC4035-C06
descripción	fusible fino medida ø6,3x32mm 16A retardado nominal 250V UE 1 pzs		
Para modelos:	GIC3500, GIC3535, GIC4035		

			
1			
código	358132	referencia	GIC3035-06 GIC3500-06 GIC3535-06 GIC4035-06
descripción	fusible fino medida ø6,3x32mm 16A retardado nominal 250V UE 20 pzs		



portafusibles

1 

código	358101	referencia	907116
descripción	portafusibles fusible adaptable ø5x20mm ø 14mm 4A nominal 250V empalme F6,3 con fusible 4A rápido		
Para modelos:	GGW1001, GGW2001		

accesorios eléctricos

conectores - acoplamientos - enchufes

enchufes/conectores de aparatos

aparatos de baja temperatura 70°C



1	código	551334	referencia	HVS1000-38 YJS820-38
descripción	enchufe/conector de aparatos C14 máx. 10A/250V F4,8			

cables

cables de alimentación aparatos



1	código	551085	referencia	00000009171 C03013
descripción	cable CEE7/7 tipo E+F 3 polos contactos P+N+T 1.5mm ² máx. 16A máx. 230V 2m con conector H05VV-F 3G1,5			
Para modelos:	GFS1022, GFS1025, GFS1030, GFS2022, GFS2025, GTO1001, GTO2001, HFS2019, HFS2022, HFS2025			



1	código	550726	referencia	HVS1000-39 YJS820-39
descripción	cable aliment. para aparatos de baja temp. CEE7/7 - C15 3 polos contactos P+N+T 1mm ² máx. 10A máx. 250V 2,0m H05VVF T70 2 polos + tierra aislam. PVC			

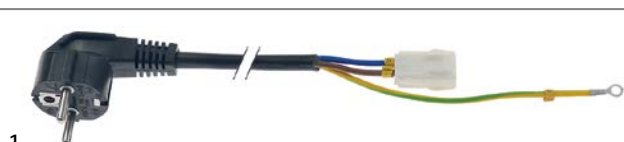

1	código	698880	referencia	E25EUB315300
descripción	cable de conexión 3 polos contactos P+N+T 1.5mm ² máx. 16A máx. 250V 2.9m			
Para modelos:	GPS2600, GSA2600, GSD2600, GSF2600			

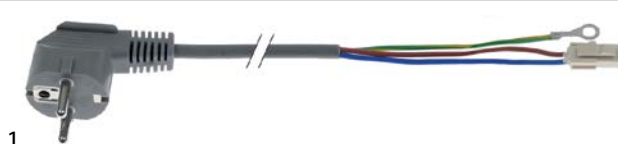

1	código	699313	referencia	RN600.01
descripción	cable de conexión CEE7/7 tipo E+F 3 polos contactos P+N+T 0.75mm ² máx. 16A máx. 250V 2.87m			
Para modelos:	GFR2600			



1	código	699317	referencia	GPS1600-45 GSF1600-45 S900.47
descripción	cable de conexión CEE7/7 tipo E+F 3 polos contactos P+N+T 1.5mm ² máx. 16A máx. 250V 2.95m H05VV-F negro			
Para modelos:	GDS1134, GDS1600, GHS1134, GHS1600, GHS2134, GHS2600, GPS1134, GPS1600, GSA1134, GSA1600, GSF1134, GSF1600			



1	código	551203	referencia	C03007
descripción	cable de conexión CEE7/7 tipo E+F 3 polos contactos P+N+T 2.5mm ² máx. 16A máx. 230V 2m H07 RN-F con conector			
Para modelos:	GEG2001			



1	código	551232	referencia	253159002607 GMW1025-C14
descripción	cable de conexión par aparatos CEE7/7 1mm ² máx. 500V 1.5m UE 1 pzs empalme conector Faston 6,3mm negro			



1	código	551217	referencia	DQXA6002 GBC1001-15 GBC1002-16 GBC1003-16 GSC1100-34 GSC1336-30 GSC2336-30
descripción	cable de conexión par aparatos CEE7/7 tipo E+F 3 polos contactos P+N+T 0.75mm ² máx. 16A 2.2m con compensador de tracción 16A UE 1 pzs blanco			
Para modelos:	GBC1001, GBC1002, GBC1003, GSC1100, GSC1100G, GSC1336, GSC2336			



1			
código	551218	referencia	1.1.A.A08.02.02 1.1.A.A08.02.79 1.1.A.A08.02.87 A1.1.A.A07.02.01 GCV1600-45 GGC1078-51 GGC2270-53 GGC2270-53-white
descripción	cable de conexión par aparatos CEE7/7 tipo E+F 3 polos contactos P+N+T 0.75mm ² máx. 16A máx. 230V 2m UE 1 pzs gris		
Para modelos:	GGC1270, GRV1100		

1			
código	551193	referencia	RW40.19
descripción	cable de conexión par aparatos CEE7/7 tipo E+F 3 polos contactos P+N+T 1.5mm ² máx. 16A máx. 230V 1.37m H07RN-F 3G1.50mm ² países A/B/D/F/I		
Para modelos:	GHR1040, GHR2600		

1			
código	552002	referencia	I3306470
descripción	cable de conexión par aparatos CEE7/7 tipo E+F contactos P+N+T 1mm ² máx. 16A máx. 230V 2.5m		
Para modelos:	GFR3600, GRE3600		

1			
código	551325	referencia	GIC3035-B7 GIC3535-B7 GIC4035-B7 XC0000071R
descripción	cable de conexión par aparatos P+N+T 1mm ² máx. 500V 1.5m UE 1m empalme atornillado		

accesorios			
pasacables			
racores para cables			
uniones roscadas			
1			
código	530431	referencia	902687
descripción	racor para cables rosca PG13,5 ø cable 12mm montaje ø 21mm UE 1 pzs plástico EC 24		
Para modelos:	GGW1001, GGW2001		

1			
código	551288 ¹	referencia	A10032
descripción	racor para cables rosca PG16 ø cable 14mm montaje ø 22.5mm EC 27 plástico UE 1 pzs		
Para modelos:	GEG1001, GEG2001		

¹con tuerca de sujeción

compensadores de tracción			
1			
código	506273	referencia	HVS1000-44 YJS820-44
descripción	compensador de tracción L 20mm An 8mm agujero ø 4mm UE 1 pzs		

1			
código	506235	referencia	1.1.C.C24.03 A1.1.C.C02.02 GGC1078-48
descripción	compensador de tracción L 28mm An 12mm H 8mm agujero ø 3.5mm dist. del agujero 16mm plástico UE 1 pzs		
Para modelos:	GRV1100		



cables de cinta plana

grupo 8



código	403213	referencia	909352
descripción	cable de cinta plana 7 polos L 400mm tipo de conector 1 fila		
Para modelos:	GDW1001		

mazos de cables



código	699172	referencia	912089 917089
descripción	mazo de cables		
Para modelos:	GPG1001		



código	699173	referencia	912188
descripción	mazo de cables		
Para modelos:	GPG2001		



código	694615	referencia	253169000472 GMW1025-C13
descripción	mazo de cables para microondas L 800mm UE 1 pzs		

cables de enlace

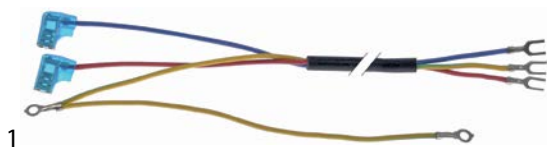

código	699304	referencia	DQXB9019 GBC1001-20 GBC1002-21 GBC1003-21
descripción	cable de enlace L 360mm 3 polos		
Para modelos:	GBC1001, GBC1002, GBC1003		

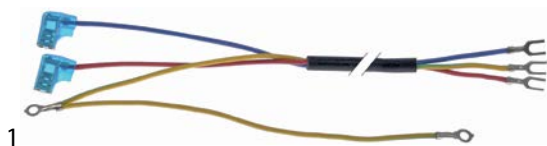

código	699305	referencia	DQXB2003 GSC1336-31 GSC2336-31
descripción	cable de enlace L 650mm 3 polos		
Para modelos:	GSC1336, GSC2336		

ACCESORIOS ELÉCTRICOS HORECA-SELECT

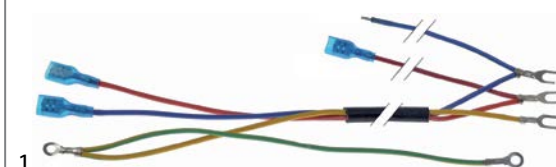

código	699306	referencia	DQXB4003
descripción	cable de enlace L 665mm 3 polos		
Para modelos:	GSC1100, GSC1100G		

terminales

regletas de bornes a tornillo/con contactos de enchufe



código	551444	referencia	01200720
descripción	borne de conexión 3 polos máx. 25A máx. 450V empalme conector Faston 6,3mm resis.a la temp. 150°C		
Para modelos:	GCO2001		



código	550278	referencia	904140
descripción	borne de conexión 3 polos máx. 40A máx. 400V empalme $\phi 6\text{mm}^2$ / F6,3 resis.a la temp. 150°C sección nominal 6mm^2		
Para modelos:	GGW1001, GGW2001		



código	550411	referencia	904150 A16014
descripción	borne de conexión 6 polos máx. 40A máx. 450V empalme $\phi 6\text{mm}^2$ / F6,3 resis.a la temp. 150°C sección nominal 6mm^2		
Para modelos:	GDW1001, GEG1001, GEG2001		



regletas de bornes a tornillo



1

código	551109	referencia	912041
descripción	cable de conexión 4 polos máx. 15A máx. 500V empalme atornillado resis.a la temp. 150°C		
Para modelos:	GPG1001, GPG2001		



1

código	551086	referencia	01009
descripción	caja de bornes 6 polos L 117mm An 67mm H 22mm protección IP30		
Para modelos:	GFR1600		

enchufes para aparatos



1

código	550300	referencia	A10007
descripción	borne de conexión 3 polos contactos P+N+T		
Para modelos:	GTO1001, GTO2001		

componentes específicos para cortadoras de fiambre

cubiertas



1

código	696528	referencia	00000000489
descripción	protector de cuchilla ø 180mm ø lama 220mm rosca de sujeción M6 medida de sujeción 12x12mm fundido aluminio edición en producción desde 2010		
Para modelos:	GFS1022, GFS2022, HFS2022		



1

código	550755 ¹	referencia	09950047000
descripción	cable de conexión 3 polos contactos P+N+T con compensador de tracción negro L 1600mm 2.5mm ²		
Para modelos:	GCO1001		

¹con cable 1600mm



1

código	697749	referencia	00000000463 00000000490
descripción	protector de cuchilla ø 209mm ø lama 250mm rosca de sujeción M6 medida de sujeción 12x12mm aluminio		
Para modelos:	GFS1025, GFS2025, HFS2025		

cajas de bornes



1

código	551214	referencia	S900.48 S960.02
descripción	caja de bornes 4 polos L 90mm An 52mm H 28mm con compensador de tracción UE 1 pzs		
Para modelos:	GDS1134, GDS1600, GHS1134, GHS1600, GHS2134, GHS2600, GSA1134, GSA1600		



1

código	551216	referencia	GBC1001-16 GBC1002-17 GBC1003-17 GSC2336-35 SLZB3001
descripción	caja de bornes 4 polos L 90mm An 52mm H 33mm con compensador de tracción 250V 1mm ² UE 1 pzs		
Para modelos:	GBC1001, GBC1002, GBC1003, GSC2336		



1

código	697744	referencia	00000000403
descripción	protector de cuchilla ø 248mm ø lama 300mm rosca de sujeción M6 medida de sujeción 12x12mm aluminio		
Para modelos:	GFS1030		

tornillos de retención

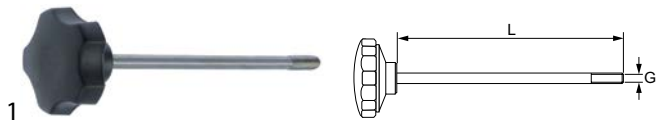

código	698376	referencia	00000001302 00000701302
descripción	tornillo de retención rosca M6 L 134mm negro		
Para modelos:	GFS1022, GFS2022, HFS2022		



código	697439	referencia	00000000777
descripción	tornillo de retención rosca M6 L 155mm asidero ø 40mm		
Para modelos:	GFS2025, HFS2025		



código	696602	referencia	00000009958
descripción	tornillo de retención rosca M6 L 188mm asidero ø 39mm para modelo 300/S-G, Dolly Verticale VS300		
Para modelos:	GFS1030		

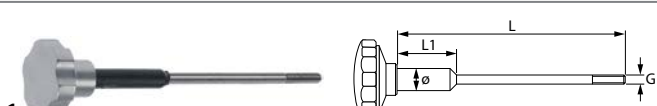

código	698629	referencia	00000709956
descripción	tornillo de retención rosca M6 L 155mm ø 10mm L1 55mm asidero ø 29mm		
Para modelos:	GFS1025		

manillas de ajuste



código	697419	referencia	00000000130 00000700130
descripción	manilla de ajuste 0-15 ø 55mm eje ø 12mm eje L 28mm asidero ø 42mm 250		
Para modelos:	GFS1022, GFS2022, GFS2025, HFS2019, HFS2022, HFS2025		



código	696522	referencia	00000009503
descripción	manilla de ajuste 0-22 ø 68mm eje ø 18mm eje L 50mm asidero ø 68mm sentido de rotación izquierdo		
Para modelos:	GFS1030		

excéntricas para espesor de corte



código	697470	referencia	00000000830
descripción	excéntrica para grosor de corte agujero ø 12mm ancho de estría 6mm ø ext. 52mm espesor 21.5mm		
Para modelos:	GFS2025, HFS2025		



código	697471	referencia	00000000379
descripción	excéntrica para grosor de corte agujero ø 12mm ancho de estría 6mm ø ext. 58mm espesor 21mm		
Para modelos:	GFS1022, GFS1025, GFS2022, HFS2019, HFS2022		

arandelas elásticas



código	697478	referencia	00000000671
descripción	arandela de muelle int.ø 19mm ø ext. 26mm UE 1 pzs		
Para modelos:	GFS1030		

piezas guía

para placas deslizantes



código	697483	referencia	00000000117
descripción	guía 195		
Para modelos:	GFS1022, GFS2022, HFS2019, HFS2022		



1

código	697448	referencia	00000009177
descripción	guía 220-250		
Para modelos:	GFS2025, HFS2025		



1

código	696524	referencia	00000000602 00000009691
descripción	guía L 117mm An 92mm H 51mm agujero ø 18mm soporte de eje ø 16mm aluminio		
Para modelos:	GFS1030		



1

código	697477	referencia	00000000126
descripción	placa de unión L 75mm An 15mm		
Para modelos:	GFS2022, GFS2025, HFS2019, HFS2022, HFS2025		

para carros



1

código	696510	referencia	00000009466
descripción	guía 220		
Para modelos:	GFS1022, GFS2022, HFS2019, HFS2022		

casquillos



1

código	698626	referencia	00000000119
descripción	casquillo ø ext. 18mm int.ø 16mm H 15mm		
Para modelos:	GFS1030, GFS2025, HFS2025		



1

código	698627	referencia	00000000611
descripción	casquillo ø ext. 8mm int.ø 5mm H 10mm		
Para modelos:	GFS1030		

árboles



1

código	697782	referencia	00000000501
descripción	árbol para carro ø 16mm L 390mm rosca M8		
Para modelos:	GFS1025		

carcasas

partes inferiores



1

código	698389	referencia	00000000768
descripción	cubierta L 447mm An 180mm plástico		
Para modelos:	GFS1030		



1

código	696512	referencia	00000000504
descripción	placa inferior 220		
Para modelos:	GFS1022, GFS2022, HFS2019, HFS2022		



1

código	696345	referencia	00000000516
descripción	placa inferior L 390mm An 190mm plástico 300		
Para modelos:	GFS1025		



1

código	698393	referencia	00000000701
descripción	placa inferior L 409mm An 174mm plástico		
Para modelos:	GFS2025, HFS2025		

protección de mano



código	697754	referencia	00000000784
descripción	protección de mano para cuchillo 300mm H 125mm An 60mm espesor 1.2mm agujero ø 6.5mm distancia de sujeción 84mm acero inoxidable		
Para modelos:	GFS1030		



código	696511	referencia	00000000197
descripción	rascador para cuchillo 220/250mm acero inoxidable		
Para modelos:	GFS1025, GFS2025, HFS2025		



código	697755	referencia	00000000162
descripción	protección de mano para carro 300 H 180mm An 152mm espesor 5mm agujero ø 10mm distancia de sujeción 110mm plástico		
Para modelos:	GFS1030		



código	697826	referencia	00000000924
descripción	protección de mano para cortadora de fiambre		
Para modelos:	GFS1025, GFS2025, HFS2025		



código	698964	referencia	00000000482
descripción	protección de mano para cortadora de fiambre 195-220		
Para modelos:	GFS2022, HFS2019, HFS2022		

accesorios



código	697482	referencia	00000000446
descripción	tornillo rosca M5 ø 8mm L 15mm		
Para modelos:	GFS1025, GFS1030, GFS2022, GFS2025, HFS2019, HFS2022, HFS2025		



código	697481	referencia	00000000623
descripción	tornillo de cabeza moleteada rosca M6 rosca L 8mm ø 14mm H 6mm inox		
Para modelos:	GFS1030, GFS2022, GFS2025, HFS2019, HFS2022, HFS2025		



código	698640	referencia	00000000924
descripción	portacuchillas completo con eje eje ø 14 longitud árbol 95mm rosca de sujeción M5 sujeción 3 orificios		
Para modelos:	GFS1022, GFS2022, HFS2022		



código	697747	referencia	00000000920
descripción	portacuchillas con árbol D1 ø 40mm D2 ø 64.3mm D3 ø 67.5mm eje ø 14 L 33mm longitud árbol 152mm rosca de sujeción M5 fijación ø 3 orificios		
Para modelos:	GFS1025		



código	697746	referencia	000000009469
descripción	portacuchillas con árbol D1 ø 40mm D2 ø 76mm eje ø 16 L 40mm longitud árbol 157mm rosca de sujeción M5 fijación ø 3 orificios		
Para modelos:	GFS1030		
repuestos para	697746		



código	514030	referencia	—
descripción	anillo tuarc árbol ø 20mm espesor 1.3mm acero DIN 471		



código	523512	referencia	00000000632
descripción	rodamiento de bolas radial tipo 6204-2RS árbol ø 20mm ø ext. 47mm An 14mm con arandelas de junta cojinete ranurado DIN 625-1		





código	692029	referencia	—
descripción	anillo tuarc taladro ø 47mm espesor 1.8mm acero DIN 472		



recipientes			
manillas			
 <p>1</p>			
código	698642	referencia	00000001130
descripción	manilla rosca M10 ø 59mm L 100mm aluminio		
Para modelos:	GFS1030		



 <p>1</p>			
código	696515	referencia	00000001242
descripción	manilla rosca M10x1,5 ø 34mm L 88mm prensador		
Para modelos:	GFS1025		
accesorios para	696515		
	código	696517	referencia
			00000800678 800678
	perno roscado para asidero ø 12mm L 64mm rosca M6/M10 acero inoxidable		

 <p>1</p>			
código	697429	referencia	00000000298
descripción	manilla rosca M6 ø 25mm L 126mm con protección de mano D1 ø 70mm		
Para modelos:	GFS2022, GFS2025, HFS2019, HFS2022, HFS2025		

recipientes			
 <p>1</p>			
código	698644	referencia	00000000608
descripción	protector de mano para ralladora 300-350 L 290mm agujero ø 12mm manilla M10 CE		
Para modelos:	GFS1030		
accesorios para	698644		
	código	110703	referencia
			—
	manilla cilíndrica rosca M10 ø 28mm L 87mm		

 <p>1</p>			
código	698418	referencia	00000009878
descripción	protector de mano para ralladora L 240mm agujero ø 12mm manilla M6 con asidero		
Para modelos:	GFS1025, GFS2025, HFS2025		

accesorios			
 <p>1</p>			
código	697480	referencia	00000000151
descripción	perno de fijación prensador ø 7.5mm L 8mm plástico		
Para modelos:	GFS1025, GFS1030, GFS2022, GFS2025, HFS2019, HFS2022, HFS2025		

 <p>1</p>			
código	696517	referencia	00000800678
descripción	perno roscado para asidero ø 12mm L 64mm rosca M6/M10 acero inoxidable		
Para modelos:	GFS1025		
accesorios para	696517		
	código	696515	referencia
			00000001242 1242
	manilla rosca M10x1,5 ø 34mm L 88mm prensador		

 <p>1</p>			
código	698630	referencia	00000000827
descripción	punta prensador ø 3mm L 11.5mm		
Para modelos:	GFS1025, GFS1030, GFS2022, GFS2025, HFS2019, HFS2022, HFS2025		

cuchillas circulares			
estándar			
 <p>1</p>			
código	697546	referencia	00000000254
descripción	cuchilla circular ø ext. 195mm soporte ø 30mm 3 orificios int. ø 155mm H 12.8mm C45 estándar		
Para modelos:	HFS2019		



1

código	697436	referencia	0000000855
descripción	cuchilla circular ø ext. 220mm soporte ø 40mm 3 orificios int.ø 180mm H 15.5mm C45		
Para modelos:	GFS1022, GFS2022, HFS2022		



1

código	697365	referencia	0000000142
descripción	cuchilla circular ø ext. 250mm soporte ø 40mm 3 orificios int.ø 210mm H 17.5mm C45 estándar		
Para modelos:	GFS1025, GFS2025, HFS2025		



1

código	697385	referencia	0000000636
descripción	cuchilla circular ø ext. 300mm soporte ø 40mm 3 orificios int.ø 250mm H 20mm C45 estándar		
Para modelos:	GFS1030		

unidades de afilado

tapa



1

código	696514	referencia	0000000863
descripción	tapa para afilador L 116mm An 100mm distancia de sujeción 26mm		
Para modelos:	GFS1025, GFS2022, GFS2025, HFS2022, HFS2025		



1

código	698643	referencia	0000000596
descripción	tapa para afilador L 150mm An 120mm		
Para modelos:	GFS1030		

soportes



1

código	696493	referencia	0000000771
descripción	soporte para afilador L 60mm An 31mm H 78mm agujero ø 12mm rosca de sujeción M6 con escuadra de sujeción		
Para modelos:	GFS1030		

pomos



1

código	697441	referencia	0000000854
descripción	tornillo de retención rosca M5 asidero ø 25mm negro L 30mm		
Para modelos:	GFS2022, GFS2025, HFS2022, HFS2025		



1

código	696518	referencia	0000000954
descripción	tornillo de retención rosca M5 L 47mm asidero ø 25mm plata		
Para modelos:	GFS1025		



1

código	697428	referencia	0000000138
descripción	tornillo de retención rosca M6 asidero ø 25mm negro L 15mm		
Para modelos:	HFS2019		



1



código	696523	referencia	00000009510
descripción	tornillo de retención rosca M6 L 53mm asidero ø 34mm plata		
Para modelos:	GFS1030		



unidades de afilado



1

código	697420	referencia	00000009168
descripción	unidad de afilado 195/200/220/250		
Para modelos:	HFS2019		
repuestos para	697420		
	código	697423	referencia 00000000816
	piedra de afilar ø 40mm espesor 8mm taladro ø 6mm granulación fino con bisel, con cubo		
	código	697424	referencia 00000000871
	piedra de afilar ø 40mm espesor 8mm taladro ø 6mm granulación grueso con bisel, con cubo		
	código	697428	referencia 00000000138
	tornillo de retención rosca M6 asidero ø 25mm negro L 15mm		





1

código	697397	referencia	00000009864
descripción	unidad de afilado 220/250/275		
Para modelos:	GFS1022, GFS1025, GFS2022, GFS2025, HFS2022, HFS2025		



1

código	697355	referencia	00000009693
descripción	unidad de afilado 350		
Para modelos:	GFS1030		
repuestos para	697355		
	código	697377	referencia 00000000720
	piedra de afilar ø 51mm espesor 12mm taladro ø 8mm granulación grueso sin bisel		
	código	697378	referencia 00000000721
	piedra de afilar ø 51mm espesor 7mm taladro ø 8mm granulación fino con bisel, sin cubo		

árboles



1

código	698633	referencia	00000000778
descripción	árbol para afilador ø 12mm L 95mm rosca M5		
Para modelos:	GFS1030		

piedras de afilar



1

código	697378	referencia	00000000721
descripción	piedra de afilar ø 51mm espesor 7mm taladro ø 8mm granulación fino con bisel, sin cubo		
Para modelos:	GFS1030		

piedras de afilar con cubo



1

código	697423	referencia	00000000816
descripción	piedra de afilar ø 40mm espesor 8mm taladro ø 6mm granulación fino con bisel, con cubo		
Para modelos:	HFS2019		



1

código	697424	referencia	00000000871
descripción	piedra de afilar ø 40mm espesor 8mm taladro ø 6mm granulación grueso con bisel, con cubo		
Para modelos:	HFS2019		



1

código	697422	referencia	00000000642
descripción	piedra de afilar ø 45mm espesor 8mm taladro ø 6mm granulación fino con bisel, con cubo		
Para modelos:	GFS1025, GFS2022, GFS2025, HFS2022, HFS2025		



1

código	697421	referencia	00000000641
descripción	piedra de afilar ø 45mm espesor 8mm taladro ø 6mm granulación grueso con bisel, con cubo		
Para modelos:	GFS1025, GFS2022, GFS2025, HFS2022, HFS2025		

pedras afilar en forma de taza



1

código	697377	referencia	00000000720
descripción	piedra de afilar ø 51mm espesor 12mm taladro ø 8mm granulación grueso sin bisel		
Para modelos:	GFS1030		

carros cortadora

manillas



1

código	697440	referencia	00000000432
descripción	manilla rosca M10 asidero ø 66mm H 51mm negro		
Para modelos:	GFS1022		

accesorios



1

código	698631	referencia	00000000895
descripción	árbol para carro rosca M6 L 170mm ø 12mm		
Para modelos:	GFS2025, HFS2025		



1

código	697827	referencia	00000000678
descripción	árbol para cortadora de fiambre rosca M10 L 95mm rosca L 12/15mm longitud total 122mm ø 16mm acero inoxidable		
Para modelos:	GFS1030		



1

código	696516	referencia	00000000186
descripción	soporte para carro L 56mm aluminio		
Para modelos:	GFS2022, HFS2019, HFS2022		

otros



1

código	697476	referencia	00000000509
descripción	casquillo ø 14mm L 88mm int.ø 12mm		
Para modelos:	GFS1025, GFS2022, GFS2025, HFS2019, HFS2022, HFS2025		



1

código	698628	referencia	00000000774
descripción	perno roscado rosca M6 L 37mm para cortadora de fiambre		
Para modelos:	GFS1030		



1

código	698392	referencia	00000000828
descripción	perno roscado rosca M6 ø 6mm L 35mm para cortadora de fiambre		
Para modelos:	GFS1025, GFS1030, GFS2022, GFS2025, HFS2019, HFS2022, HFS2025		



1

código	698388	referencia	00000000765
descripción	pletina sujeción ø 18mm L 128mm An 28mm		
Para modelos:	GFS1030		



1

código	697356	referencia	00000000300
descripción	soporte rosca M10x0,75 ø 30mm para microinterruptor int.ø 14.5mm espesor 13mm rosca de sujeción M5		
Para modelos:	GFS1025		

para mixers a inmersión

carcasas



1			
código	698387	referencia	2853M
descripción	adesivo para tapa plata L 50mm An 27mm		
Para modelos:	GSM1000		



1			
código	698386	referencia	2848M
descripción	adesivo para triturador portátil plata L 125mm An 25mm espesor 1mm CON.-DESC.		
Para modelos:	GSM1000		



1			
código	699133	referencia	2843M
descripción	caja derecho azul GSM1000		
Para modelos:	GSM1000		

accesorios para	699133		
	código	699134	referencia
			2849M
	descripción	caja izquierdo azul GSM1000	



1			
código	699134	referencia	2849M
descripción	caja izquierdo azul GSM1000		
Para modelos:	GSM1000		

accesorios para	699134		
	código	699133	referencia
			2843M
	descripción	caja derecho azul GSM1000	



1			
código	699708	referencia	2840M
descripción	cubierta para asidero azul GSM1000 L 80mm An 42mm		
Para modelos:	GSM1000		



1			
código	696503	referencia	2851
descripción	manilla para triturador portátil plástico gris		
Para modelos:	GSM1000		

acoplamientos



1			
código	696505	referencia	2860
descripción	acoplamiento con pasador elástico para triturador portátil D1 ø 19mm ø int. 1 8mm dientes 8 GSM1000		
Para modelos:	GSM1000		



1			
código	696504	referencia	2846
descripción	acoplamiento para triturador portátil D1 ø 19mm ø int. 1 6.3mm L 29.5mm dientes 8 GSM1000		
Para modelos:	GSM1000		

mezcladoras

cuchillas

cuchillas con soportes





1			
código	698262	referencia	0551
descripción	cuchillo ø 39mm agujero ø 4mm H 12mm		
Para modelos:	GSM1000		

			
1			
código	698261	referencia	0550
descripción	cuchillo ø 39mm agujero ø 4mm H 18mm		
Para modelos:	GSM1000		

			
1			
código	698381	referencia	0552
descripción	disco mezclador ø 36mm agujero ø 4mm H 0.8mm GSM1000		
Para modelos:	GSM1000		

			
1			
código	698382	referencia	0553
descripción	disco mezclador ø 36mm agujero ø 4mm H 3.4mm GSM1000		
Para modelos:	GSM1000		

mezcladoras			
			
1			
código	698379	referencia	2845M
descripción	varilla mezcladora GSM1000 L 234mm brida ø 66mm		
Para modelos:	GSM1000		

árboles			
			
1			
código	698380	referencia	2844M
descripción	árbol de accionamiento para triturador portátil con acoplamiento D1 ø 4mm D2 ø 8mm L 214mm inox		
Para modelos:	GSM1000		
repuestos para	698380		
	código	696505	referencia
			2860
	acoplamiento con pasador elástico para triturador portátil D1 ø 19mm ø int. 1 8mm dientes 8 GSM1000		

otros			
			
1			
código	698383	referencia	0632
descripción	junta de árbol int.ø 4mm ø ext. 12mm para triturador portátil H 6.3mm		
Para modelos:	GSM1000		

			
1			
código	532648	referencia	2859
descripción	junta tórica EPDM espesor 1.5mm int.ø 5mm UE 1 pzs		
Para modelos:	GSM1000		

			
1			
código	696506	referencia	2858
descripción	pomo para placa electrónica ø 26mm negro UE 1 pzs		
Para modelos:	GSM1000		

			
1			
código	696507	referencia	2854
descripción	soporte para motor plástico negro		
Para modelos:	GSM1000		

			
1			
código	698385	referencia	2841
descripción	soporte para asa L 40mm An 37mm espesor 1.5mm		
Para modelos:	GSM1000		

			
1			
código	698384	referencia	45710
descripción	tapa de protección para asa plástico negro		
Para modelos:	GSM1000		

para exprimidores

bandejas colectoras



1

código	696502	referencia	900963
descripción	bandeja colector para exprimidor ø 175mm agujero ø 42mm H 110mm inox		
Para modelos:	GJU1001		

juntas



1

código	511953	referencia	900871
descripción	juego de juntas para exprimidor		
Para modelos:	GJU1001		



1

código	532647	referencia	900970
descripción	junta tórica EPDM espesor 1.8mm int.ø 11.8mm UE 1 pzs		
Para modelos:	GJU1001		

motores



1

código	501426	referencia	900956
descripción	motor para exprimidor 180W 230-240V 50Hz árbol ø 8mm longitud árbol 40mm tipo RCJ298252 0.18kW		
Para modelos:	GJU1001		

elementos exprimidores



1

código	650167	referencia	221266
descripción	complemento exprimidor juego para exprimidor ø 57/62/79mm H 45/50/55mm plástico		
Para modelos:	GJU1001		



1

código	650168	referencia	900901
descripción	filtro para exprimidor ø 155mm H 23mm plástico		
Para modelos:	GJU1001		

árboles



1

código	650170	referencia	900895
descripción	árbol L 48mm cuadrado rosca M8x1,25 para exprimidor EC 12		
Para modelos:	GJU1001		

otros



1

código	650169	referencia	221242
descripción	bandeja de goteo para exprimidor ø 79mm H 20mm plástico negro		
Para modelos:	GJU1001		



1

código	650171	referencia	900925
descripción	cubierta para árbol ø 44mm H 18mm aluminio		
Para modelos:	GJU1001		

para frigoríficos

sistemas de desagüe

válvulas de desagüe



1

código	692441	referencia	GSC1100-48
descripción	pileta de desagüe L 45mm plástico H 38mm An 28mm tubo ø 10mm UE 1 pzs		

elementos de manejo



1

código	698848	referencia	GPC1088-03
descripción	lámpara con termostato ø 140mm H 35mm		
Para modelos:	GPC1088		

recambios y accesorios



1

código	551346	referencia	I0534005R
descripción	casquillo refrigerador compresor ø 9mm int.ø 6.5mm L 17mm UE 1 pzs		
Para modelos:	GFR3600, GRE3600		



1

código	699232	referencia	I0535012
descripción	compensador de tracción L 56mm An 14.5mm H 20mm		
Para modelos:	GFR3600, GRE3600		



1

código	694967	referencia	HSC360G-22 SLCX0002
descripción	cubierta L 51mm An 44mm H 12mm plástico distancia de sujeción 30mm		



1

código	698878	referencia	WJQZ9000 WJQZ9001
descripción	guia contrapeso para puerta corredera L 248mm An 20mm H 10mm		



1

código	698849	referencia	GPC1046-03 GPC1088-04
descripción	tapa L 96mm An 44mm H 13mm plástico		
Para modelos:	GPC1046, GPC1088		



1

código	750691	referencia	RN400.11 RN400.12
descripción	válvula de compensación de presión L 104mm An 59mm H 87mm		
Para modelos:	RN400		

cajas y paneles frontales

cubiertas



1

código	698890	referencia	PTBP9N88
descripción	cubierta L 1350mm An 65mm H 52mm UE 1 pzs		



			
1			
código	694969	referencia	GSC1100G-28
descripción	cubierta L 1420mm An 127mm H 30mm		

			
1			
código	694594	referencia	GSC1336-03 GSC2336-03
descripción	cubierta para iluminación An 615mm H 180mm espesor de placa máx. 1mm plexiglás blanco UE 1 pzs		
Para modelos:	GSC1336		

			
1			
código	998252	referencia	44037000
descripción	cubierta para ventilación L 72mm An 62mm H 10mm UE 1 pzs		
Para modelos:	GFR3600, GRE3600		

			
1			
código	694588	referencia	RC600.31
descripción	cubierta para ventilador axial An 663mm H 222mm espesor de placa máx. 0.7mm chapa UE 1 pzs		
Para modelos:	GRE2600		

			
1			
código	692389	referencia	GHR1040-21 RW40.27
descripción	deflector L 304mm An 25mm H 125mm aluminio UE 1 pzs		
Para modelos:	GHR1040, GHR2600		

			
1			
código	694595	referencia	GSC1336-02 GSC2336-02
descripción	revestimiento para iluminación L 185mm An 72mm H 15mm pos. de montaje derecho UE 1 pzs		
Para modelos:	GSC1336		

			
1			
código	694596	referencia	GSC1336-04 GSC2336-04
descripción	revestimiento para iluminación L 185mm An 72mm H 15mm pos. de montaje izquierdo UE 1 pzs		
Para modelos:	GSC1336		

			
1			
código	701271	referencia	GHR1040-12 RW40.18
descripción	tapa para tornillo Phillips plástico ø 12mm UE 1 pzs		
Para modelos:	GHR1040, GHR2600		

paneles de mando

			
1			
código	692381	referencia	RW40.25
descripción	panel de mando para frigorífico An 72mm H 110mm UE 1 pzs		
Para modelos:	GHR1040, GHR2600		

			
1			
código	699316	referencia	RC400.20 RN400.21
descripción	panel frontal L 598mm An 78mm H 52mm		
Para modelos:	RC400, RN400		

			
1			
código	699234	referencia	44027000
descripción	revestimiento L 780mm An 67mm H 62mm pos. de montaje arriba		
Para modelos:	GFR3600, GRE3600		

tapa



1

código	698864	referencia	GPC1046-05 GPC1088-06
descripción	cubierta negro L 50mm An 42mm H 7mm		
Para modelos:	GPC1046, GPC1088		

carcasas



1

código	692382	referencia	RW40.24
descripción	caja para termostato negro L 110mm An 70mm H 55mm UE 1 pzs		
Para modelos:	GHR1040, GHR2600		



1

código	699233	referencia	I9500323
descripción	caja de bornes L 98mm An 74mm H 35mm Kit		
Para modelos:	GFR3600, GRE3600		

pies para aparatos



1

código	698865	referencia	GPC1088-12
descripción	pie de aparato M8 rosca L 15mm ø 29mm		
Para modelos:	GPC1088		

manillas



1

código	692390	referencia	GSC1100-12 GSC1336-45 GSC2336-45 LCCG0005
descripción	barra de asidero para puerta L 380mm An 40mm aluminio UE 1 pzs		
Para modelos:	GSC1100, GSC1100G, GSC1336		

soportes



1

código	692383	referencia	RN400.24 RN600.20
descripción	soporte para evaporador pos. de montaje derecho L 98mm An 34mm H 37mm plástico UE 1 pzs		
Para modelos:	GFR2600, RN400		



1

código	692384	referencia	RN400.22 RN600.21
descripción	soporte para evaporador pos. de montaje izquierdo L 98mm An 34mm H 37mm plástico UE 1 pzs		
Para modelos:	GFR2600, RN400		



tapas			
 <p>1</p>			
código	692372	referencia	GDS1134-03 GDS1134-3 GDS1600-03 GDS1600-3 GPS1600-03 GPS1600-3 GSA1134-03 GSF1600-03 S900.03
descripción	tapa gris ø 16.5mm montaje ø 12.5mm H 7mm UE 1 pzs		
Para modelos:	GDS1134, GDS1600, GHS1134, GHS1600, GHS2134, GHS2600, GPS1134, GPS1600, GSA1134, GSA1600, GSF1134, GSF1600		

 <p>2</p>			
código	692735	referencia	RC400.33 RN400.31
descripción	tapa para ventilador de evaporador gris ø 24mm montaje ø 18mm H 5mm		
Para modelos:	RC400, RN400		

otros			
 <p>1</p>			
código	692391	referencia	GSC1336-24 GSC2336-24 SLZE0027
descripción	caja para portalámparas L 150mm An 40mm H 20mm plástico UE 1 pzs		
Para modelos:	GSC1100G, GSC1336, GSC2336		

 <p>1</p>			
código	692392	referencia	GSC1100-02 SLSE4005
descripción	cubierta para iluminación An 1170mm H 280mm espesor 1mm plástico UE 1 pzs		
Para modelos:	GSC1100, GSC1100G		

 <p>1</p>			
código	694875	referencia	SLZE0026
descripción	cubierta para termostato		

 <p>1</p>			
código	701268	referencia	RN400.23 RN600.32
descripción	perfil U para evaporador L 635mm An 16mm H 13mm aluminio UE 1 pzs		
Para modelos:	GFR2600, RN400		

 <p>1</p>			
código	701267	referencia	RC600.21 RN600.14
descripción	rejilla de ventilación blanco H 61mm L 770mm pos. de montaje abajo UE 1 pzs		
Para modelos:	GFR2600, GRE2600		

 <p>1</p>			
código	701547	referencia	RC400.17 RN400.18
descripción	rejilla de ventilación H 60mm L 600mm		
Para modelos:	RC400, RN400		

cajón			
 <p>1</p>			
código	699320	referencia	S901-4D.51
descripción	cajón para frigorífico L 590mm An 428mm H 255mm acero inoxidable		
Para modelos:	GDS1134		

puertas

puertas



1

código	694543	referencia	RC600.41 RN600.30
descripción	puerta An 765mm H 1740mm espesor 63mm		
Para modelos:	GFR2600, GRE2600		



1

código	699376	referencia	BLGM4161 HSC800-49
descripción	puerta cristal An 460mm H 1230mm pos. de montaje derecho P 30mm		



1

código	699406	referencia	RC400.30 RN400.29
descripción	puerta L 1715mm An 600mm H 76mm		
Para modelos:	RC400, RN400		



1

código	699375	referencia	BLGM4160 HSC800-51
descripción	puerta cristal An 460mm H 1230mm pos. de montaje izquierdo P 30mm		



código	699377	referencia	GSC1336-07 GSC2336-07
descripción	puerta cristal An 620mm H 1380mm con asidero P 40mm		
Para modelos:	GSC1336		



código	699374	referencia	BLPM2033 HSC360-40
descripción	puerta cristal An 620mm H 1600mm P 40mm		



código	699494	referencia	BLGM4024 HSC350DD-47	
descripción	puerta cristal An 620mm H 680mm P 38mm pos. de montaje arriba			
repuestos para	699494			
	código	902465	referencia	HSC350DD-46 HSC350DD-49 SLJP2015
junta para frigorífico perfil 9161 An 590mm L 650mm medida inserción				



código	699493	referencia	BLGM4025 HSC350DD-51	
descripción	puerta cristal con cerradura An 620mm H 680mm P 38mm pos. de montaje abajo			
repuestos para	699493			
	código	902465	referencia	HSC350DD-46 HSC350DD-49 SLJP2015
junta para frigorífico perfil 9161 An 590mm L 650mm medida inserción				



código	699382	referencia	BLGM4011 GSC1100-16
descripción	puerta cristal derecho An 600mm H 1330mm P 40mm		
Para modelos:	GSC1100, GSC1100G		



código	698989	referencia	BLGM2B12 HSC350-46
descripción	puerta cristal L 1350mm An 620mm		



código	699381	referencia	BLGM4010 GSC1100-15
descripción	puerta cristal izquierdo An 600mm H 1330mm P 40mm		
Para modelos:	GSC1100, GSC1100G		

otros



código	701272	referencia	GHR1040-22 RW40.28
descripción	balda grande para frigorífico An 325mm H 9mm P 145mm plástico UE 1 pzs		
Para modelos:	GHR1040, GHR2600		



código	701273	referencia	GHR1040-23 RW40.29
descripción	balda pequeño para frigorífico An 325mm H 9mm P 120mm plástico UE 1 pzs		
Para modelos:	GHR1040, GHR2600		

1

código	701274	referencia	GHR1040-24 RW40.30
descripción	bandeja juego para puerta An 290mm H 60mm P 103/77mm plástico UE 1 pzs		
Para modelos:	GHR1040, GHR2600		



1

código	694589	referencia	GHR1040-20 RW40.26
descripción	contenedor de agua para frigorífico L 71mm An 58mm H 35mm plástico UE 1 pzs		
Para modelos:	GHR1040, GHR2600		



1

código	692256	referencia	S900.29
descripción	contrasoporte para perno L 43mm agujero ø 6mm dist. del agujero 28.5mm		
Para modelos:	GDS1600, GSA1134, GSA1600		



1

código	694867	referencia	HSC350-29 PTBP2020
descripción	cubierta para evaporador L 525mm An 280mm H 53mm chapa UE 1 pzs		

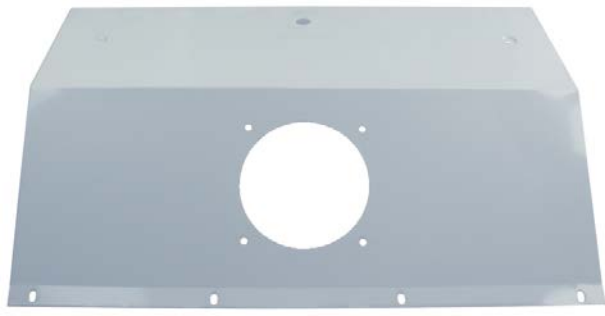

1

código	694597	referencia	GSC1336-14 GSC2336-14
descripción	cubierta para evaporador L 525mm An 345mm H 115mm chapa UE 1 pzs		
Para modelos:	GSC1336		



1

código	692424	referencia	GSC1336-19 GSC2336-19 SLZV0007
descripción	cubierta para iluminación pos. de montaje interior L 1263mm An 56mm H 20mm plástico UE 1 pzs		
Para modelos:	GSC1336, GSC2336		



1

código	698888	referencia	SLZV0019
descripción	cubierta transparente para lámpara L 810mm An 40mm H 30mm UE 1 pzs		
Para modelos:	GBC1003		



1

código	694590	referencia	GHR1040-10 GHR2600-10 RW40.16
descripción	distanciador ø 12mm int.ø 7.6mm H 1.4mm plástico UE 1 pzs		
Para modelos:	GHR1040, GHR2600		



1

código	692426	referencia	GSC1336-38 GSC2336-38 LCCJ2029
descripción	guida para frigorífico L 1145mm An 26mm H 4.5mm UE 1 pzs		
Para modelos:	GSC1100, GSC1100G, GSC1336, GSC2336		



1

código	692731	referencia	RC600.11
descripción	soporte L 80mm An 58mm P 25mm chapa de acero tincado		
Para modelos:	GRE2600		



1

código	701431	referencia	HSC360-22 WJLD0000
descripción	soporte para puerta de vidrio L 54mm An 42mm H 75mm agujero ø 7x12mm UE 1 pzs		



1

código	698877	referencia	LCCK0001
descripción	soporte de bandeja L 26.5mm An 8.5mm H 40mm aluminio		
Para modelos:	GSC1100, GSC1100G, GSC2336		

para mesas frías

cajas y paneles frontales



1

código	699318	referencia	S901-4D.49
descripción	soporte para mesas frías An 68mm H 364mm		
Para modelos:	GDS1134		

para congeladores

cajas y paneles frontales



1

código	692386	referencia	RC600.35 RN600.26
descripción	panel frontal An 770mm H 52mm plástico UE 1 pzs		
Para modelos:	GFR2600, GRE2600		

para vitrinas frías

elementos de manejo



1

código	692402	referencia	1.1.C.C12.14 GGC1078-15-white GGC1078-WHITE-15
descripción	manilla gris para vitrina H 9.5mm L 85mm An 25mm distancia de sujeción 70mm UE 1 pzs		



1

código	692409	referencia	1.1.C.C12.06 GGC2270-18 GGC2270-18-white
descripción	manilla de puerta L 100mm An 32mm dist. del agujero 68mm blanco		
Para modelos:	GGC1270		



			
1			
código	692700	referencia	1.1.C.C12.07 GGC2270-18-black
descripción	manilla de puerta L 100mm An 32mm dist. del agujero 68mm negro UE 1 pzs		

			
1			
código	692401	referencia	1.1.C.C23.01 GGC1078-11
descripción	pomo ø 27mm gris marca cero eje ø 6x4,6mm parte plana izquierdo para termostato para apretar UE 1		

recambios y accesorios

			
1			
código	699422	referencia	1.1.C.C63.61 GCV1600-35
descripción	clip para deshidratador L 90mm An 20mm H 52mm plástico UE 1 pzs		

			
1			
código	694912	referencia	GGC2270-52
descripción	compensador de tracción L 40mm An 20mm H 8mm		
Para modelos:	GGC1270		

			
1			
código	699436	referencia	A1.1.C.C21.15
descripción	guía L 250mm An 24mm H 10mm		
Para modelos:	GRV1100		

cajas y paneles frontales			
paneles			
			
1			
código	699160	referencia	A1.1.C.C21.07
descripción	barrera final pos. de montaje arriba/lateral para puerta An 420mm P 110mm H 23mm UE 1 pzs		
Para modelos:	GRV1100		

			
1			
código	692417	referencia	1.1.C.C21.01 GGC1078-09 GGC1078-9
descripción	caja para distribución An 130mm P 75mm H 145mm plástico UE 1 pzs		

			
1			
código	699407	referencia	S24AC20A0005
descripción	chapa pos. de montaje arriba para puerta An 890mm P 115mm H 10mm		
Para modelos:	GPS2600, GSA2600, GSD2600, GSF2600		

			
1			
código	692733	referencia	HSC360-27 SLJX2014
descripción	cubierta para lámpara An 55mm H 20mm L 1040mm		

			
1			
código	698914	referencia	A1.1.C.C19.05
descripción	cubierta pos. de montaje abajo para interruptor An 135mm P 20mm H 30mm plástico		
Para modelos:	GRV1100		

			
1			
código	699414	referencia	1.1.C.C02.01 GGC2270-30-white
descripción	cubierta de lámpara An 310mm P 5mm H 172mm blanco		



1

código	699415	referencia	1.1.C.C02.02 GGC2270-30-black
descripción	cubierta de lampara An 310mm P 5mm H 172mm negro		



1

código	699181	referencia	A1.1.C21.23
descripción	filtro An 260mm P 90mm H 296mm negro UE 1 pzs		
Para modelos:	GRV1100		



1

código	692405	referencia	1.1.C.C22.08 GGC1078-10
descripción	panel de mando para vitrina temperatura MIN/MAX An 130mm P 23mm H 145mm plástico UE 1 pzs		



1

código	699319	referencia	S901-4D.07
descripción	panel frontal para cajón An 428mm P 38mm H 255mm acero inoxidable		
Para modelos:	GDS1134		



1

código	699409	referencia	1.1.C.C15.03.03 GGC2270-06 GGC2270-06-white
descripción	panel frontal pos. de montaje anterior An 518mm P 35mm H 440mm blanco		
Para modelos:	GGC1270		

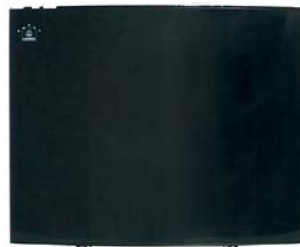

1

código	699410	referencia	1.1.C.C15.03.35 GGC2270-06-black
descripción	panel frontal pos. de montaje anterior An 518mm P 35mm H 440mm negro		



1

código	699401	referencia	S24AC21A0001
descripción	panel frontal pos. de montaje anterior An 865mm P 15mm H 248mm		
Para modelos:	GPS2600, GSA2600, GSD2600, GSF2600		



1

código	698854	referencia	1.1.C.C15.01.02 GGC1078-04-black GGC1078-50-black
descripción	panel frontal pos. de montaje anterior/posterior negro An 427mm P 33mm H 190mm plástico UE 1 pzs para vitrina		



1

código	692411	referencia	1.1.C.C40.02 GGC2270-45
descripción	placa de asiento para evaporador L 305mm An 241mm espesor 1.5mm plástico UE 1 pzs		
Para modelos:	GGC1270		



1

código	699158	referencia	A1.1.C.C21.06
descripción	placa de cubierta pos. de montaje arriba/abajo para puerta An 420mm P 110mm H 12mm UE 1 pzs		
Para modelos:	GRV1100		



1

código	698935	referencia	A1.1.B.B19.07
descripción	revestimiento pos. de montaje abajo para vitrina H 235mm UE 1 pzs ø 490mm		
Para modelos:	GRV1100		



1

código	698907	referencia	A1.1.B.B19.03
descripción	revestimiento pos. de montaje derecho para vitrina An 34mm P 10mm H 710mm 1 par acero cromado		
Para modelos:	GRV1100		

tapa



1

código	699403	referencia	S24AC50A0003
descripción	pieza adicional para vitrinas frías An 910mm P 705mm H 125mm		
Para modelos:	GSD2600		



1

código	699404	referencia	S24AC30A0003
descripción	pieza adicional para vitrinas frías An 910mm P 705mm H 55mm		
Para modelos:	GSF2600		



1

código	692414	referencia	GGC1078-29-white GGC1078-WHITE-29
descripción	tapa L 313mm An 163mm para iluminación UE 1 pzs		



1

código	698904	referencia	A1.1.C.C21.02
descripción	tapa negro An 475mm H 33mm L 355mm		
Para modelos:	GRV1100		



1

código	698922	referencia	A1.1.C.C21.01
descripción	tapa para vitrina negro An 474mm P 364mm H 24mm UE 1 pzs		
Para modelos:	GRV1100		

soportes de bandeja



1

código	698940	referencia	A1.1.C.C21.16 A1.1.C.C21.18 A1.1.C.C21.19
descripción	soporte de bandeja L 55mm An 18mm H 40mm pos. de montaje izquierdo/derecho con esfera		
Para modelos:	GRV1100		

carcasas



1

código	692436	referencia	1.1.C.C21.03 GGC2270-54
descripción	caja An 128mm P 65mm H 38mm plástico UE 1 pzs		
Para modelos:	GGC1270		



1

código	692412	referencia	GGC2270-58
descripción	caja An 40mm H 21mm plástico UE 1 pzs		
Para modelos:	GGC1270		



1

código	692415	referencia	1.1.C.C18.04 GGC1078-44
descripción	caja para evaporador An 370mm H 175mm L 420mm UE 1 pzs		



1

código	699323	referencia	VRX1560.2
descripción	caja para interruptor An 114mm P 68mm H 100mm		
Para modelos:	GHS1134, GHS1600, GHS2134, GHS2600		



1

código	699175	referencia	P04AC21A0003
descripción	caja para parte de manejo An 200mm P 115mm H 95mm		
Para modelos:	GPS2600, GSA2600, GSD2600, GSF2600		



1

código	698937	referencia	A1.1.C.C21.08
descripción	complemento pos. de montaje centro para vitrina H 210mm plástico ø 490mm		
Para modelos:	GRV1100		



1

código	692420	referencia	1.1.B.B05.02 GGC1078-08 GGC1078-8
descripción	cubierta para condensador An 365mm P 220mm H 130mm chapa UE 1 pzs		



1

código	692422	referencia	1.1.C.C16.02 GGC1078-41
descripción	cubierta para evaporador An 280mm P 345mm H 35mm plástico UE 1 pzs		



1

código	698916	referencia	A1.1.C.C04.14
descripción	cubierta pos. de montaje para placa electrónica An 140mm P 38mm H 80mm plástico UE 1 pzs		
Para modelos:	GRV1100		

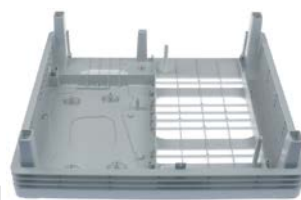

1

código	692416	referencia	1.1.C.C25.15 GGC1078-49
descripción	fondo para vitrina An 378mm H 115mm L 425mm UE 1 pzs		



1

código	698860	referencia	1.1.C.C56.84 GGC1078-18-black
descripción	guía pos. de montaje anterior para parte lateral An 23mm P 30mm H 635mm UE 1 pzs		



1

código	698861	referencia	1.1.C.C56.85 GGC1078-38-black
descripción	guía pos. de montaje atrás para parte lateral An 30mm P 30mm H 635mm UE 1 pzs		



1

código	692403	referencia	1.1.C.C15.01.01 GGC1078-04-white GGC1078-WHITE-4
descripción	panel frontal pos. de montaje anterior para vitrina An 427mm P 33mm H 190mm plástico UE 1 pzs blanco		

1

código	692269	referencia	1.1.C.C15.01.05 GGC2270-51 GGC2270-51-white
descripción	pared posterior para vitrina An 515mm P 45mm H 410mm blanco		
Para modelos:	GGC1270		



1

código	698851	referencia	1.1.C.C15.01.06 GGC2270-51-black
descripción	pared posterior para vitrina An 515mm P 45mm H 410mm negro		



1

código	698917	referencia	A1.1.C.C04.15
descripción	parte inferior pos. de montaje para carcasa An 153mm P 4mm H 85mm plástico UE 1 pzs blanco		
Para modelos:	GRV1100		



1

código	692270	referencia	1.1.C.C15.03.08 1.1.C.C15.03.08+1.1.C.C15.03.09 GGC2270-50 GGC2270-50-white
descripción	parte lateral An 418mm H 410mm plástico blanco		
Para modelos:	GGC1270		



1

código	692437	referencia	1.1.C.C22.07 GGC2270-55
descripción	tapa de caja An 130mm P 70mm H 6mm plástico UE 1 pzs		
Para modelos:	GGC1270		



1

código	692413	referencia	GGC2270-59
descripción	tapa de caja An 40mm P 18mm plástico UE 1 pzs		
Para modelos:	GGC1270		



1

código	692419	referencia	1.1.C.C01.15 GGC1078-27-white GGC1078-WHITE-27
descripción	tapa de caja para vitrinas frías An 425mm L 380mm plástico UE 1 pzs blanco		
accesorios para	692419		
código	692414	referencia	GGC1078-29-white GGC1078-WHITE-29
descripción	tapa L 313mm An 163mm para iluminación UE 1 pzs		



1

código	698936	referencia	A1.1.C.C21.09
descripción	zócalo pos. de montaje abajo H 160mm plástico ø 490mm		
Para modelos:	GRV1100		

regillas de ventilación



1

código	699411	referencia	1.1.C.C14.01 GGC1078-12-white
descripción	cubierta para ventilador An 425mm P 380mm H 36mm plástico UE 1 pzs blanco		



1

código	698855	referencia	1.1.C.C14.02 GGC1078-12-black
descripción	cubierta para ventilador An 425mm P 380mm H 36mm plástico UE 1 pzs negro		



1

código	698912	referencia	A1.1.C.C21.21
descripción	cubierta pos. de montaje para aspiración An 290mm P 10mm H 40mm plástico UE 1 pzs		
Para modelos:	GRV1100		



1

código	698915	referencia	A1.1.C.C21.20
descripción	cubierta pos. de montaje para ventilador An 270mm P 10mm H 63mm plástico		
Para modelos:	GRV1100		



1

código	698911	referencia	A1.1.C.C21.10
descripción	marco pos. de montaje abajo para vitrina An 370mm P 75mm H 70mm plástico		
Para modelos:	GRV1100		



1

código	699417	referencia	1.1.C.C26.01 GGC1078-02-white
descripción	rejilla pos. de montaje abajo para ventilación An 350mm P 12mm H 57mm plástico UE 1 pzs blanco		



1

código	698853	referencia	1.1.C.C26.02 GGC1078-02-black
descripción	rejilla pos. de montaje abajo para ventilación An 350mm P 12mm H 57mm plástico UE 1 pzs negro		



1

código	701254	referencia	1.1.C.C49.10 GCV1600-32
descripción	rejilla de ventilación para aspiración plástico negro H 50mm L 260mm UE 1 pzs		



1

código	701253	referencia	1.1.C.C49.09 GCV1600-33
descripción	rejilla de ventilación para ventilador plástico negro H 50mm L 620mm UE 1 pzs		

marcos



1

código	699413	referencia	1.1.C.C63.13 GCV1600-28
descripción	marco de puerta exterior An 375mm P 10mm H 375mm		

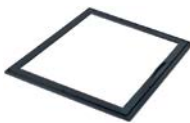

1

código	699412	referencia	1.1.C.C63.14 GCV1600-29
descripción	marco de puerta interior An 378mm P 10mm H 385mm		

partes laterales



1

código	699324	referencia	VRX38.12
descripción	parte lateral An 390mm P 40mm H 222mm		
Para modelos:	GHS1134, GHS1600, GHS2134, GHS2600		



1	código	698850	referencia	1.1.C.C15.03.10 GGC2270-50-black
	descripción	parte lateral An 418mm H 410mm plástico negro		



1	código	698906	referencia	A1.1.C.C21.12
	descripción	parte lateral para puerta An 47mm P 29mm H 660mm plástico		
	Para modelos:	GRV1100		



1	código	698862	referencia	1.1.C.C38.19 GGC1078-20-black
	descripción	parte lateral para puerta L 590mm espesor 17mm		

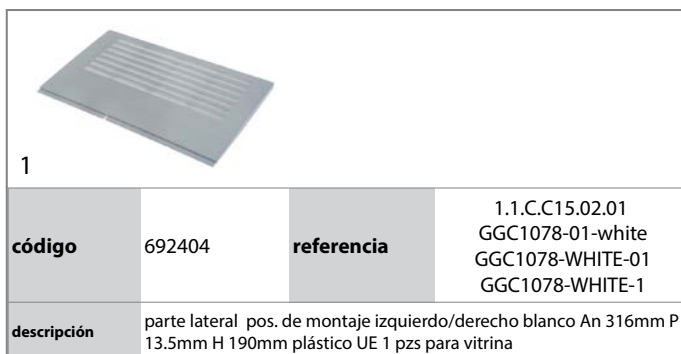

1	código	692404	referencia	1.1.C.C15.02.01 GGC1078-01-white GGC1078-WHITE-01 GGC1078-WHITE-1
	descripción	parte lateral pos. de montaje izquierdo/derecho blanco An 316mm P 13.5mm H 190mm plástico UE 1 pzs para vitrina		



1	código	698852	referencia	1.1.C.C15.02.02 GGC1078-01-black
	descripción	parte lateral pos. de montaje izquierdo/derecho negro An 316mm P 13.5mm H 190mm plástico UE 1 pzs para vitrina		

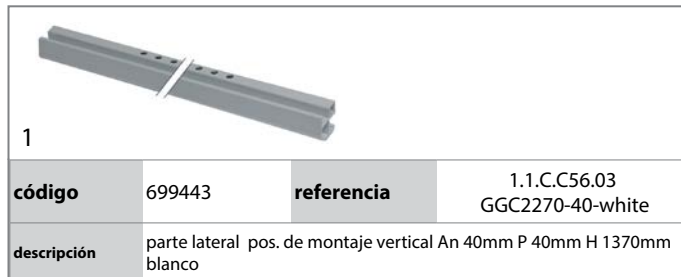

1	código	699443	referencia	1.1.C.C56.03 GGC2270-40-white
	descripción	parte lateral pos. de montaje vertical An 40mm P 40mm H 1370mm blanco		



1	código	699444	referencia	1.1.C.C56.06 GGC2270-40-black
	descripción	parte lateral pos. de montaje vertical An 40mm P 40mm H 1370mm negro		

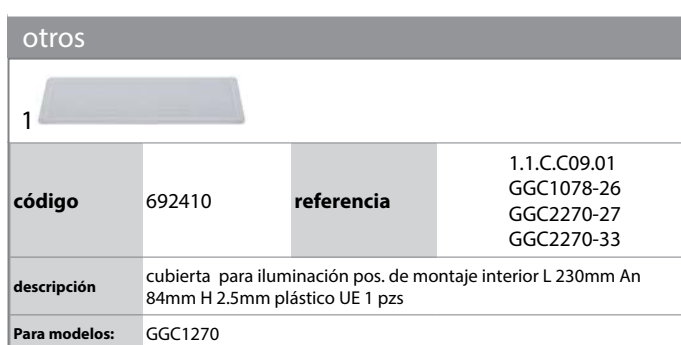

otros				
1	código	692410	referencia	1.1.C.C09.01 GGC1078-26 GGC2270-27 GGC2270-33
	descripción	cubierta para iluminación pos. de montaje interior L 230mm An 84mm H 2.5mm plástico UE 1 pzs		
	Para modelos:	GGC1270		



1	código	692380	referencia	RW40.31
	descripción	distanciador para botellas L 30mm An 8mm H 17mm plástico UE 1 pzs		
	Para modelos:	GHR1040, GHR2600		



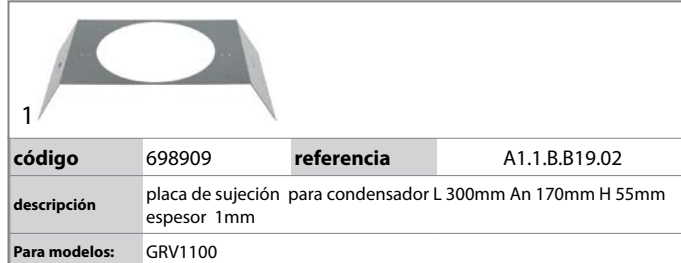

1	código	692370	referencia	1.1.C.C63.70 GCV1600-06
	descripción	guía para junta L 740mm An 42mm H 19mm plástico UE 1 pzs		



1	código	698909	referencia	A1.1.B.B19.02
	descripción	placa de sujeción para condensador L 300mm An 170mm H 55mm espesor 1mm		
	Para modelos:	GRV1100		

1			
código	699315	referencia	SLZE0042
descripción	placa de sujeción para evaporador L 55mm An 27mm H 6mm		
Para modelos:	GBC1001, GBC1002, GBC1003		

1			
código	692369	referencia	1.1.C.C63.71 GCV1600-47
descripción	soporte per termómetro An 81mm H 41mm plástico UE 1 pzs		

1			
código	699427	referencia	1.1.C.C03.01 GGC1078-28-white GGC2270-32-white
descripción	tapón ciego H 5mm ø 12mm		

1			
código	699428	referencia	1.1.C.C03.02 GGC1078-28-black GGC2270-32-black
descripción	tapón ciego H 5mm ø 12mm		

rieles guía

1			
código	698908	referencia	A1.1.C.C21.13
descripción	guía pos. de montaje izquierdo/derecho para vitrina An 45mm P 38mm H 665mm 1 par plástico		
Para modelos:	GRV1100		

1			
código	698905	referencia	A1.1.C.C21.14
descripción	travesaño central pos. de montaje atrás para vitrina An 65mm P 26.5mm H 665mm plástico		
Para modelos:	GRV1100		

vidrios

vidrios

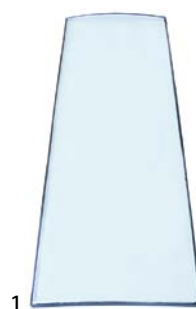

1			
código	692289	referencia	1.1.E.E2.02.65 GGC2270-20
descripción	vidrio An 460mm H 1360mm espesor 17mm curvado para frigorífico		
Para modelos:	GGC1270		

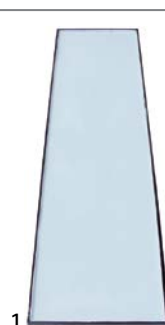

1			
código	692293	referencia	1.1.E.E2.02.44 GGC2270-38
descripción	vidrio L 1392mm An 376mm espesor 10mm plano pos. de montaje lateral para vitrinas frías		
Para modelos:	GGC1270		

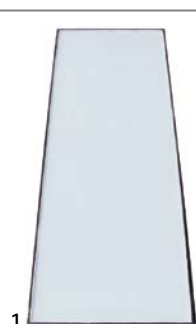

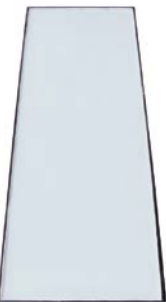
1			
código	699328	referencia	1.1.E.E2.02.45 GGC2270-39
descripción	vidrio L 1395mm An 464mm espesor 17.5mm pos. de montaje atrás escaparate refrigerado GGC2270		
Para modelos:	GGC1270		

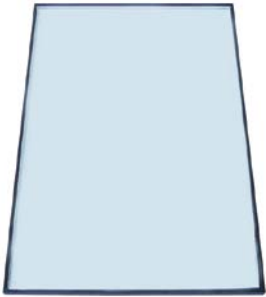

1			
código	699330	referencia	1.1.E.E2.02.76 GCV1600-27
descripción	vidrio L 360mm An 357mm espesor 10.5mm para puerta GCV1600		

1

código	692291	referencia	1.1.E.E2.02.64 GGC1078-21
descripción	vidrio L 635mm An 390mm espesor 10mm plano pos. de montaje puerta para vitrinas frías		

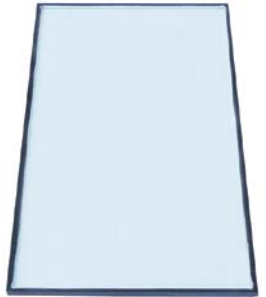

1

código	692290	referencia	1.1.E.E2.02.11 GGC1078-17
descripción	vidrio L 660mm An 332mm espesor 10mm plano pos. de montaje lateral para frigorífico		



1

código	699327	referencia	1.1.E.E2.02.75 GCV1600-26
descripción	vidrio L 645mm An 595mm H 16mm espesor 8mm pos. de montaje derecho para vitrinas frías GCV1600		



1

código	698939	referencia	A1.1.E.E07.09.02
descripción	vidrio L 715mm An 420mm H 120mm espesor 20mm abombado pos. de montaje izquierdo/derecho		
Para modelos:	GRV1100		



1

código	699326	referencia	1.1.E.E2.02.74 GCV1600-21
descripción	vidrio L 645mm An 595mm H 16mm espesor 8mm pos. de montaje izquierdo para vitrinas frías GCV1600		



1

código	699329	referencia	1.1.E.E2.04.15.A0 GCV1600-16
descripción	vidrio L 773mm An 710mm espesor 12mm pos. de montaje frontal para vitrinas frías GCV1600		

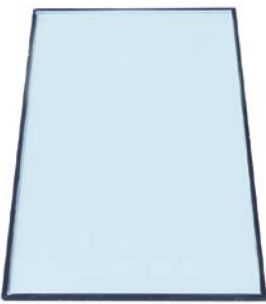

1

código	692292	referencia	1.1.E.E2.02.12 GGC1078-37
descripción	vidrio L 655mm An 390mm espesor 10mm plano pos. de montaje atrás para vitrinas frías		



1

código	698923	referencia	A1.1.E.E07.09.03
descripción	vidrio ø 390mm espesor 6mm		
Para modelos:	GRV1100		

accesorios



1			
código	699159	referencia	A1.1.D.D06.06.02
descripción	aislamiento para puerta L 315mm espesor 19mm An 85mm		
Para modelos:	GRV1100		



1			
código	699431	referencia	1.1.B.B14.05 GCV1600-13
descripción	guía L 775mm		

puertas



1			
código	699405	referencia	S24AC50A0004
descripción	estantería L 255mm An 890mm H 30mm acero inoxidable		
Para modelos:	GSD2600		



1			
código	698859	referencia	1.1.C.C11.02 GGC1078-16-black GGC1078-23-black
descripción	marco de puerta L 425mm An 15mm H 28mm pos. de montaje arriba/abajo		



1			
código	694541	referencia	RW40.03
descripción	puerta An 395mm H 540mm		
Para modelos:	GHR1040, GHR2600		



1			
código	699177	referencia	S24AC22A0001-RIGHT
descripción	puerta L 515mm An 425mm H 55mm pos. de montaje derecho		
Para modelos:	GPS2600, GSA2600, GSD2600, GSF2600		



1			
código	699176	referencia	S24AC22A0001-LEFT
descripción	puerta L 515mm An 425mm H 55mm pos. de montaje izquierdo		
Para modelos:	GPS2600, GSA2600, GSD2600, GSF2600		



1			
código	698971	referencia	BLGM9S52 HBC2003-50
descripción	puerta cristal An 440mm H 770mm con cerradura pos. de montaje derecho		



1

código	698972	referencia	BLGM9S00 HBC1002-45
descripción	puerta cristal An 440mm H 770mm con cerradura pos. de montaje izquierdo		
accesorios para	698972		
		código	902210
		referencia	JNMA0000
	junta L 930mm UE 1 medidas 5x6mm		



1

código	698973	referencia	BLGM9S01 HBC1002-44
descripción	puerta cristal An 440mm H 770mm pos. de montaje derecho		



1

código	698970	referencia	BLGM9S5M HBC2003-49
descripción	puerta cristal An 450mm H 770mm con cerradura pos. de montaje centrado		



1

código	699378	referencia	GBC1002-47 GBC1003-47
descripción	puerta cristal An 440mm H 770mm con cierre P 25mm		



1

código	698969	referencia	BLGM9S57 HBC2003-48
descripción	puerta cristal An 450mm H 770mm pos. de montaje izquierdo		



1

código	699379	referencia	GBC1002-49 GBC1003-49
descripción	puerta cristal An 440mm H 770mm P 25mm		



1

código	699380	referencia	GBC1001-44
descripción	puerta cristal An 600mm H 800mm P 30mm		

			
1			
código	698938	referencia	A1.1.E.E07.09.01
descripción	puerta cristal L 725mm An 418mm H 122mm para vitrina		
Para modelos:	GRV1100		

macánica de puertas

pernos

			
1			
código	699424	referencia	1.1.B.B09.03 GGC1078-36
descripción	perno de puerta H 7mm An 7mm L 20.5mm pos. de montaje arriba		

			
1			
código	699433	referencia	A1.1.B.B19.09
descripción	perno de puerta L 45.5mm ø 7mm		
Para modelos:	GRV1100		

casquillos

			
1			
código	699429	referencia	GGC1078-34-white
descripción	casquillo H 15mm ø 10mm		

			
1			
código	699430	referencia	1.1.C.C13.02 GGC1078-34-black
descripción	casquillo H 15mm ø 10mm		

			
1			
código	699435	referencia	A1.1.C.C19.07
descripción	casquillo H 17.5mm ø 16.8mm		
Para modelos:	GRV1100		

			
1			
código	699161	referencia	A1.1.B.B15.18
descripción	casquillo para puerta H 11.5mm ø 10mm		
Para modelos:	GRV1100		

otros

			
1			
código	694928	referencia	WJCX0000
descripción	imán de puerta L 46mm An 16mm H 14.5mm		

			
1			
código	694929	referencia	WJCXG000
descripción	placa para magnético L 45mm An 12mm H 1.5mm distancia de sujeción 32mm		

topes de puerta

			
1			
código	699442	referencia	A1.1.B.B19.05
descripción	tope de puerta H 3mm An 14mm L 664mm pos. de montaje vertical		
Para modelos:	GRV1100		

			
1			
código	699441	referencia	A1.1.B.B19.06
descripción	tope de puerta H 7mm An 9mm L 355mm pos. de montaje horizontal		
Para modelos:	GRV1100		

para máquina de hielo en cubitos

puertas

puertas



1

código	694417	referencia	40-1245-9
descripción	puerta para máquina de hielo en cubitos An 370mm H 180mm espesor 29mm gris		
Para modelos:	GIM1023, GIM2023		



1

código	694408	referencia	40-0937-9
descripción	puerta para máquina de hielo en cubitos An 475mm H 235mm espesor 28mm gris		
Para modelos:	GIM1038, GIM2038		

cortinas

accesorios

lamelas



1

código	694426	referencia	40-1258-9
descripción	lámina para cortina An 38mm H 94mm ø 6.5mm acodado		
Para modelos:	GIM1038, GIM2038		



1

código	694422	referencia	40-0882-9
descripción	lámina para cortina An 38mm H 95mm ø 6.5mm		
Para modelos:	GIM1023, GIM2023		

barras de cortina



1

código	694466	referencia	30-0570-9
descripción	barra de cortina para máquina de hielo en cubitos L 316mm ø 6mm		
Para modelos:	GIM1023, GIM2023		



1

código	694421	referencia	30-0455-9
descripción	barra de cortina para máquina de hielo en cubitos L 466mm ø 6mm		
Para modelos:	GIM1038, GIM2038		

tubos para refrigeración



1

código	694418	referencia	76-0240-3
descripción	tubo para refrigeración con colector		
Para modelos:	GIM1038, GIM2038		



1

código	694467	referencia	76-0267-9
descripción	tubo para refrigeración con colector		
Para modelos:	GIM1023, GIM2023		

para máquinas de infusión

recipientes de filtro

recipientes de filtro

BARTSCHER



1

código	950000	referencia	A038004
descripción	recipiente de filtro aluminio con tubo percolator edición en producción desde 10/2007 ø 205mm H 50mm para PRO 40T		
Para modelos:	GCM1006		

grifos de salida

grifos de salida



1

código	531128	referencia	A0ND029	
descripción	grifo de salida completo tubo ø 19mm longitud de tubo 22mm rosca M15x1 negro			
Para modelos:	GCM1006, GCM2009, GCM3016			
repuestos para	531128			
	código	531129	referencia	A0ND032
	junta para grifo de salida H 29mm ø 14.5mm apto para BARTSCHER			

piezas sueltas



1

código	531129	referencia	A0ND032
descripción	junta para grifo de salida H 29mm ø 14.5mm apto para BARTSCHER		
Para modelos:	GCM1006, GCM2009, GCM3016		

tubos indicadores de nivel

tubos indicadores de nivel



1

código	531131	referencia	A0ND043	
descripción	tubo nivel de agua ø ext. 12mm int.ø 10mm H 202mm para máquina de café			
Para modelos:	GCM1006			
accesorios para	531131			
	código	504297	referencia	A0ND036
	junta para tubo nivel de agua ø ext. 13mm int.ø 6mm silicona			



1

código	531130	referencia	A039690	
descripción	tubo nivel de agua ø ext. 12mm int.ø 10mm H 262mm para máquina de café			
Para modelos:	GCM2009, GCM3016			
accesorios para	531130			
	código	504297	referencia	A0ND036
	junta para tubo nivel de agua ø ext. 13mm int.ø 6mm silicona			

accesorios

juntas



1

código	504297	referencia	A0ND036
descripción	junta para tubo nivel de agua ø ext. 13mm int.ø 6mm silicona		
Para modelos:	GCM1006, GCM2009, GCM3016		



otros



1

código	531208	referencia	A0ND038
descripción	perno de reinicio L 107mm An 33mm para BARTSCHER		
Para modelos:	GCM1006, GCM2009, GCM3016		



1

código	531308	referencia	A039688 A040627
descripción	tubo L 335mm An 43mm tubo ø 9mm		
Para modelos:	GCM2009, GCM3016		

para cocina vitrocerámica

encimeras vitrocerámicas

vidrios vitrocerámicos

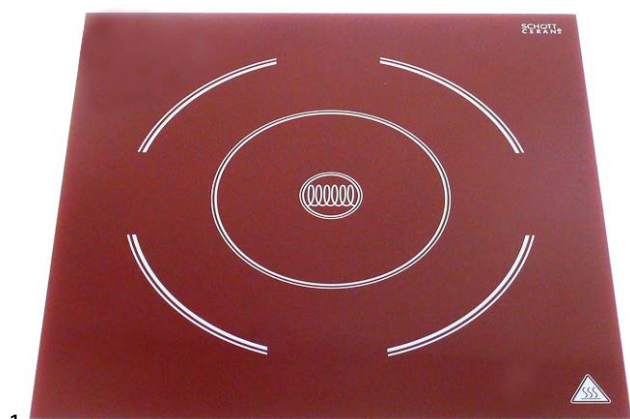

1

código	694579	referencia	GIC3035-01 GIC3035-B01 GIC3500-01 GIC3500-A01 MBF000032R
descripción	vidrio vitrocerámico L 300mm An 300mm espesor 4mm		
Para modelos:	GIC3500		

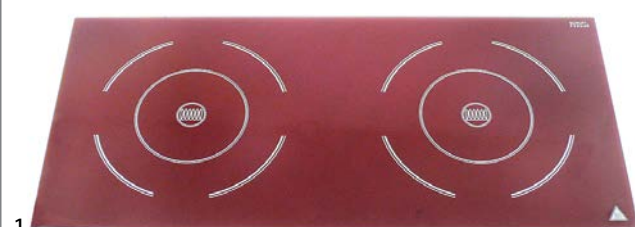

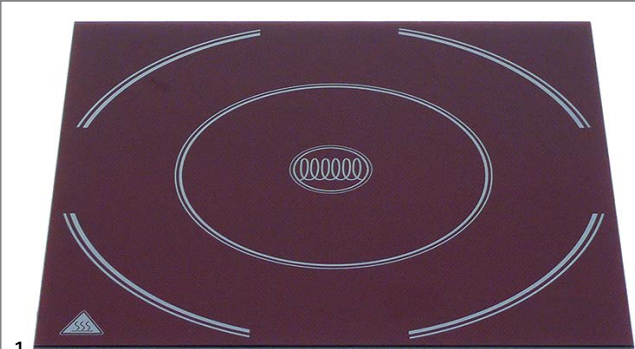

1

código	694582	referencia	GIC3535-01 GIC3535-D01
descripción	vidrio vitrocerámico L 655mm An 300mm espesor 4mm		
Para modelos:	GIC3535		



1

código	694932	referencia	MBA000234	
descripción	vidrio vitrocerámico para aparato de inducción L 274mm An 274mm espesor 4mm			
accesorios para	694932			
	código	890015	referencia	—
	silicone de alta temperatura OTTOSEAL S17 T máx 285°C rojo/marrón cartucho 310ml			
	código	890060	referencia	—
	pegamento PACTAN 6076 310ml 250°C antracita			

para freidoras

sujeciones



1

código	692544	referencia	2.02HDF4260701 GDF2124-034 GDF2124-34 GDF2128-025 HDF2128-023
descripción	lengueta de sujeción L 63mm An 25mm H 15mm		
Para modelos:	GDF2124, GDF2128		

tapa



1

código	698544	referencia	3.CP0603070100 GDF1104-032 GDF1108-039 GDF2124-032 GDF2128-040 GDF1108-035 HDF2128-036
descripción	pomo seta asidero ø 50mm ø 70mm L 36mm plástico negro		
Para modelos:	GDF1104, GDF1108, GDF2124, GDF2128		

otros



1

código	694738	referencia	HDF1108-030 HDF2128-031
descripción	revestimiento chapa L 45mm H 1mm int.ø 30mm		



1

código	694737	referencia	2.02HDF8A130001 GDF1108-032 GDF1108-32 GDF2128-033
descripción	revestimiento chapa L 63mm H 15mm int.ø 26mm		
Para modelos:	GDF1108, GDF2128		



1

código	970745	referencia	016240415
descripción	tapa para freidora inox L 295mm An 215mm H 7mm		
Para modelos:	GDF1004, GDF2024		



1

código	699212	referencia	2.HDF8A460201 GDF2128-020
descripción	tubo acero inoxidable L 30mm An 13mm rosca M5		
Para modelos:	GDF1108, GDF2128		

para grills

cubetas



1

código	692237	referencia	263990
descripción	bandeja colectora de grasa L 357mm An 37mm H 29mm		
Para modelos:	GPG1001		

soportes cestas



1

código	970744	referencia	016240426
descripción	soporte cesto para freidora L 139mm An 44mm H 8mm para BARTSCHER		
Para modelos:	GDF1004, GDF2024		



1

código	692238	referencia	263983
descripción	bandeja colectora de grasa L 497mm An 37mm H 29mm		
Para modelos:	GPG2001		



para hornos a convección/combinados

 <p>1</p>			
código	692843	referencia	00004380
descripción	casquillo distanciador int.ø 7mm H 7.5mm ø ext. 17.5mm para vidrio blanco		
Para modelos:	GCO2001		



recambios y accesorios



 <p>1</p>			
código	693043	referencia	F02005
descripción	rejilla de protección		
Para modelos:	GTO1001, GTO2001		

vidrios

 <p>1</p>			
código	693230	referencia	01981248300
descripción	vidrio L 430mm An 345mm espesor 4mm rectangular		
Para modelos:	GCO1001		

 <p>1</p>			
código	692841	referencia	21100870
descripción	vidrio L 447mm pos. de montaje interior An 585mm		
Para modelos:	GCO2001		
accesorios para	692841		
			
código	692842	referencia	21100880
descripción	vidrio L 450mm pos. de montaje exterior An 590mm		
			
código	692843	referencia	00004380
descripción	casquillo distanciador int.ø 7mm H 7.5mm ø ext. 17.5mm para vidrio blanco		

 <p>1</p>			
código	692842	referencia	21100880
descripción	vidrio L 450mm pos. de montaje exterior An 590mm		
Para modelos:	GCO2001		
accesorios para	692842		
			
código	692841	referencia	21100870
descripción	vidrio L 447mm pos. de montaje interior An 585mm		

accesorios para	692842		
			
código	692843	referencia	00004380
descripción	casquillo distanciador int.ø 7mm H 7.5mm ø ext. 17.5mm para vidrio blanco		
			
código	694993	referencia	00011680
descripción	manilla de puerta ø 18mm L 350mm acero inoxidable M5 negro mate		

 <p>1</p>			
código	691811	referencia	09982338418
descripción	vidrio L 583mm An 450mm pos. de montaje exterior		
Para modelos:	GCO1001		

Ventiladores - accesorios

 <p>1</p>			
código	701630	referencia	00012330
descripción	conducto de aire para soplador transversal para horno a vapor combinado plástico gris		
Para modelos:	GCO2001		

para máquinas hot-dog

<h3>tapa</h3>  <p>1</p>			
código	694450	referencia	F05051
descripción	tapa para aparato hot dog ø 205mm		
Para modelos:	GHM1001		

cilindros de vidrio



1

código	693002	referencia	F05009
descripción	cilindro de vidrio ø 200mm Pyrexglas H 240mm		
Para modelos:	GHM1001		

brochetas



1

código	693018	referencia	F05010
descripción	brocheta para panecillos para aparato hot dog		
Para modelos:	GHM1001		

contenedores de agua



1

código	693005	referencia	F05022
descripción	contenedor de agua para aparato hot dog PTFE/aluminio		
Para modelos:	GHM1001		

para aparatos de inducción



1

código	699333	referencia	DQA020343R SLA010075 SLA010075DQA020343R
descripción	caja para pomo L 60mm An 58mm H 25.5mm		



1

código	699335	referencia	WJD000048
descripción	chapa L 320mm An 15mm H 29mm		



1

código	699336	referencia	AB300015
descripción	complemento para placa electrónica L 298mm An 267mm H 60mm		



1

código	699334	referencia	WJD000047
descripción	deflector para aparato de inducción L 280mm An 17mm H 14mm		



1

código	970790	referencia	AB600022 GIC3035-12 GIC3035-B12 GIC3500-12 GIC3500-A12 GIC3535-12 GIC3535-D12 GIC4035-12 GIC4035-C12
descripción	filtro de grasa An 323mm H 144mm espesor 8mm inox capas 2 rejilla exterior 1 rejilla interior 1 para aparato de inducción		
Para modelos:	GIC3500, GIC3535, GIC4035		



1

código	699331	referencia	WJD000050
descripción	filtro de grasa L 125mm An 120mm H 9mm		

para sartén basculante

otros



1

código	523510	referencia	00000000860
descripción	rodamiento de bolas radial tipo 6202-2RS árbol ø 15mm ø ext. 35mm An 11mm con arandelas de junta cojinete ranurado DIN 625-1		
Para modelos:	GFS1025, GFS2022, GFS2025, HFS2019, HFS2022, HFS2025		

para grilles basculantes

piezas guía



1

código	698565	referencia	902097
descripción	cojinete de árbol pos. de montaje atrás L 35mm An 14mm H 12.5mm		
Para modelos:	GPG1001, GPG2001		

para grill de contacto

otros



1

código	692241	referencia	902195
descripción	árbol para grill de contacto		
Para modelos:	GPG2001		

para microondas

eléctrico

displays



1

código	692457	referencia	GMW1030-P40
descripción	arandela para display plexiglás An 32mm L 70mm espesor 1.3mm UE 1 pzs		
Para modelos:	GMW1030		

microinterruptores

soportes



1

código	347797	referencia	GMW1030-P23
descripción	soporte para microinterruptor L 165mm An 65mm UE 1 pzs		
Para modelos:	GMW1030		

accesorios para 347797

	código	347794	referencia	GMW1030-P247
	descripción	palanca para microinterruptor L 28mm pequeño int.ø 5mm An 22mm UE 1 pzs		
	código	347795	referencia	GMW1030-P246
	descripción	palanca para microinterruptor L 45mm medio int.ø 5mm An 22mm UE 1 pzs		
	código	347796	referencia	GMW1030-P245
	descripción	palanca para microinterruptor L 63mm grande int.ø 5mm An 22mm UE 1 pzs		

palancas



1

código	347794	referencia	GMW1030-P247
descripción	palanca para microinterruptor L 28mm pequeño int.ø 5mm An 22mm UE 1 pzs		
Para modelos:	GMW1030		



1

código	347795	referencia	GMW1030-P246
descripción	palanca para microinterruptor L 45mm medio int.ø 5mm An 22mm UE 1 pzs		
Para modelos:	GMW1030		



1

código	347796	referencia	GMW1030-P245
descripción	palanca para microinterruptor L 63mm grande int.ø 5mm An 22mm UE 1 pzs		
Para modelos:	GMW1030		

filtros de red

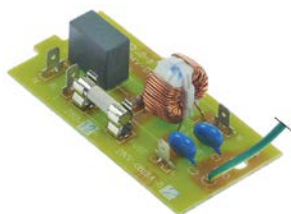

1

código	403188	referencia	263029001088 GMW1025-C04
descripción	filtro de red microondas para GMW1025 250V 50/60Hz conductor 2 placa electrónica empalme conector Faston 4,8mm L 80mm H 20mm An 40mm placa electrónica UE 1 pzs longitud del cable 120mm tipo DNV-0818A-5		



1

código	403184	referencia	GMW1030-C04
descripción	filtro de red para microondas tipo GMW1030 250V 50/60Hz conductor 2 placa electrónica empalme conector Faston 6,3mm L 90mm H 20mm An 70mm placa electrónica UE 1 pzs longitud del cable 130mm		
Para modelos:	GMW1030		

carcasas

partes externas



1

código	692453	referencia	GMW1030-P240
descripción	marco L 484mm An 72mm H 34mm para microondas UE 1 pzs		
Para modelos:	GMW1030		

placas cerámicas



1

código	692350	referencia	243999000108 GMW1025-P162
descripción	placa cerámica L 330mm An 335mm para microondas espesor 3.5mm GMW1025 UE 1 pzs		
accesorios para	692350		
	código	901698	referencia
			593219000016 GMW1025-P161
	junta L 330mm An 325mm silicona para placa cerámica UE 1 pzs		

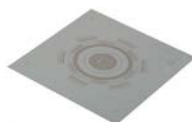

1

código	692462	referencia	GMW1030-P161
descripción	placa cerámica L 365mm An 353mm para microondas espesor 4mm GMW1030 para GALANZ		
Para modelos:	GMW1030		

otros



1

código	601869	referencia	213149000023 GMW1025-P04
descripción	soporte L 78mm An 20mm H 50mm para condensador UE 1 pzs		

puertas

láminas



1

código	692451	referencia	515059000119 GMW1025-P114
descripción	lámina L 287mm An 159mm para puerta interior espesor 0.1mm transparente para GALANZ plástico UE 1 pzs		

bisagras para puerta



1

código	701250	referencia	GMW1030-P377
descripción	gancho abajo para cierre de puerta L 51mm An 6mm H 28mm agujero ø 4.4mm UE 1 pzs		
Para modelos:	GMW1030		

cierres de puertas



1

código	347902	referencia	GMW1025-P198
descripción	retén L 174mm An 48mm para microondas GMW1025 para GALANZ plástico UE 1 pzs		



resortes de tracción



1

código	701249	referencia	GMW1030-P118
descripción	muelle de tracción ø 7.3mm longitud total 25.5mm espesor de hilo 1mm para cierre de puerta UE 1 pzs		
Para modelos:	GMW1030		

para saladettes

recambios y accesorios



1

código	692740	referencia	GDS1600-16 GPS1600-16 GSF1134-16 GSF1600-16 S900.16
descripción	tapa para tubo de desagüe ø 20mm montaje ø 15mm H 17.5mm plástico		
Para modelos:	GDS1134, GDS1600, GPS1134, GPS1600, GSA1134, GSA1600, GSF1134, GSF1600		



1

código	692739	referencia	GDS1600-15 GPS1600-15 GSF1134-15 GSF1600-15 S900.15
descripción	tubo de desagüe ø ext. 19mm int.ø 15mm H 79mm plástico rosca M20		
Para modelos:	GDS1134, GDS1600, GPS1134, GPS1600, GSA1134, GSA1600, GSF1134, GSF1600		



1

código	692742	referencia	GDS1600-14 GPS1600-14 GSF1134-14 GSF1600-14 S900.14
descripción	tuerca para tubo de desagüe rosca M20 H 18mm EC 26 plástico		
Para modelos:	GDS1134, GDS1600, GPS1134, GPS1600, GSA1134, GSA1600, GSF1134, GSF1600		

cajas y paneles frontales



1

código	692691	referencia	KITSR4AC4A00
descripción	distanciador juego 2 piezas para saladette An 25mm P 184mm H 11mm		
Para modelos:	GPS2600, GSD2600		



1

código	692692	referencia	KITSR4AC2A00
descripción	distanciador L 168/330/534mm 6 unidades		
Para modelos:	GSA2600		



1

código	692343	referencia	GSD1600-54 PS200.54
descripción	distanciador para saladette L 182mm An 25mm H 13mm UE 1 pzs		
Para modelos:	GDS1600		



1

código	692260	referencia	GPS1600-60
descripción	distanciador para saladette pos. de montaje exterior L 207mm An 35mm H 41mm aluminio UE 2 pzs		
Para modelos:	GPS1134, GPS1600		



1

código	692259	referencia	GPS1600-59
descripción	distanciator para saladette pos. de montaje interior L 182mm An 23mm H 12.5mm aluminio		
Para modelos:	GPS1134, GPS1600		



1

código	692257	referencia	VRX.01 VRX.02 VRX.04 VRX.05 VRX.06 VRX33-38
descripción	kit de sujeción para vidrio para saladette 53 piezas UE 1 pzs 6x clip de sujeción 7x codo 12x tornillo de cabeza plana 14x casquillo 14x unión roscada		
Para modelos:	GHS1134, GHS1600, GHS2134, GHS2600		



1

código	993263	referencia	P04AC20A0006
descripción	tabla de corte L 950mm An 130mm H 20mm		
Para modelos:	GSA2600		



1

código	692371	referencia	S900.25
descripción	tapón montaje ø 5.5mm ø 10mm H 13mm plástico UE 1 pzs		
Para modelos:	GSA1134, GSA1600		

puertas



1

código	701546	referencia	S24AC22A0006
descripción	perno de puerta L 28mm pos. de montaje arriba rosca L 8mmmm		
Para modelos:	GPS2600, GSA2600, GSD2600, GSF2600		



1

código	699321	referencia	GSF1600-07 S900.07
descripción	puerta pos. de montaje derecho An 427mm H 520mm P 36mm		
Para modelos:	GDS1600, GSA1134, GSA1600, GSF1134, GSF1600		



1

código	699325	referencia	GSF1600-49 S900.54
descripción	puerta pos. de montaje izquierdo An 427mm H 520mm P 36mm		
Para modelos:	GDS1600, GSA1134, GSA1600, GSF1134, GSF1600		



para salamandras



1

código	692240	referencia	30045
descripción	bandeja colectora para salamandra L 350mm An 245mm		
Para modelos:	GTO1001, GTO2001		

repuestos para	510929		
	código	510018	referencia —
	tuerca ø 92mm H 10.5mm para contenedor de sal int.ø 64mm		
	código	524177	referencia —
	tapa ø 69mm H 20mm para contenedor de sal int.ø 50mm		
accesorios para	510929		
	código	510071	referencia —
	junta plana goma ø ext. 81mm int.ø 68mm espesor 3mm para contenedor de sal UE 1 pzs		
	código	510654	referencia —
	junta H 6mm D1 ø 82mm D2 ø 68mm		
	código	510883	referencia —
	junta goma ø ext. 86mm int.ø 66mm espesor 2mm para contenedor de sal UE 1 pzs		

para lavavajillas

contenedores

tapas de recipientes



1

código	524508	referencia	906418
descripción	tapa ø 61mm para contenedor de sal		
Para modelos:	GGW2001		

accesorios



1

código	524507	referencia	902830
descripción	tuerca ø 83mm para contenedor de sal altura exterior 10mm UE 1 pzs		
Para modelos:	GGW2001		

recipientes de sal



1

código	510929	referencia	901770
descripción	recipiente de sal ø 120mm H 117mm tubo ø 10mm montaje ø 70mm altura total 157mm		
Para modelos:	GGW2001		
repuestos para	510929		
	código	506015	referencia —
	junta tórica EPDM espesor 3.53mm int.ø 39.69mm UE 1 pzs		

calentadores de agua

calentadores de agua para lavavajillas



1

código	508429	referencia	900384
descripción	calentador de agua 3500W 230V ø 127mm L 400mm		
Para modelos:	GDW1001		



1

código	517643	referencia	900368
descripción	calentador de agua ø 105mm L 340mm entrada ø 12mm		
Para modelos:	GGW1001, GGW2001		

cartuchos descalcificadores

columnas descalcificadoras



1

código	530000	referencia	902150
descripción	descalcificador cuádruple L 380mm An 180mm		
Para modelos:	GGW2001		

cámaras de aire

cámaras de aire



1

código	519250	referencia	907254
descripción	cámara de aire		
Para modelos:	GDW1001		



1

código	519513	referencia	905266
descripción	cámara de aire L 40mm An 30mm H 45mm rosca M12x1,75 tubo ø 5mm plástico		
Para modelos:	GGW1001, GGW2001		

accesorios para cámaras de aire



1

código	511385	referencia	907926
descripción	brida L 46mm An 32mm para cámara de aire		
Para modelos:	GDW1001		



1

código	511197	referencia	903261
descripción	junta L 46mm An 33mm para cámara de aire		
Para modelos:	GDW1001		

bloqueos antirretorno

bloqueos antirretorno



1

código	516101	referencia	TR2433
descripción	bloqueo antirretorno lavavajillas tubo ø 12mm		
Para modelos:	GDW1001		

repuestos para	516101			
	código	506367	referencia	—
	junta plana goma ø ext. 40mm int.ø 28mm espesor 1.8mm UE 1 pzs			

otros



1

código	850121	referencia	904571
descripción	soporte para descalcificador L 220mm An 40mm H 40mm para Silanos		
Para modelos:	GGW2001		

macánica de puertas

bisagras



1

código	502262	referencia	901246
descripción	bisagra pos. de montaje derecho L 94mm N45/N50		
Para modelos:	GDW1001		



1

código	502263	referencia	901247
descripción	bisagra pos. de montaje izquierdo L 94mm N45/N50		
Para modelos:	GDW1001		



1

código	519035	referencia	901245
descripción	bisagra de puerta taladros 3 bisagra		
Para modelos:	GGW1001, GGW2001		

pernos de bisagra



1

código	519204	referencia	904795
descripción	pasador de bisagra pasador de bisagra		
Para modelos:	GGW1001, GGW2001		

cierres



1

código	519247	referencia	906121
descripción	cierre de puerta cierre de puerta		
Para modelos:	GDW1001, GGW1001, GGW2001		
accesorios para	519247		
	código	referencia	519050 902023
	tuerca rosca M12x1,75 H 4mm EC 16 inox UE 1 pzs para cierre de enganche		

otros



1

código	504435	referencia	908146
descripción	junta plana plástico ø ext. 18mm int.ø 9.5mm espesor 2.5mm para bisagra de puerta batiente UE 1 pzs		
Para modelos:	GDW1001		

uniones roscadas



1

código	519054	referencia	902070
descripción	tuerca rosca 1"		
Para modelos:	GGW1001, GGW2001		



1

código	519055	referencia	902080
descripción	tuerca rosca 1¼"		
Para modelos:	GGW1001		

sistemas de lavado y aclarado



1

código	519238	referencia	906002
descripción	arandela int.ø 15mm ø ext. 33mm espesor 0.8mm inox UE 1 pzs		
Para modelos:	GGW2001		



1

código	501351	referencia	908124
descripción	brida pos. de montaje arriba ø 91mm H 11mm int.ø 45mm agujero ø 5.5mm		
Para modelos:	GDW1001		



1

código	519444	referencia	905449
descripción	contrasoporte pos. de montaje arriba/abajo para soporte de brazo de lavado para Silanos		
Para modelos:	GDW1001		
accesorios para	519444		
	código	referencia	519445 908141
	junta D1 ø 80mm D2 ø 50mm espesor 3mm con 4 orificios roscados		



1

código	519122	referencia	903351
---------------	--------	-------------------	--------

descripción	junta plana para brazo de aclarado		
--------------------	------------------------------------	--	--

Para modelos:	GGW1001, GGW2001		
----------------------	------------------	--	--



1

código	519437	referencia	902183
---------------	--------	-------------------	--------

descripción	pieza distanciadora		
--------------------	---------------------	--	--

Para modelos:	GDW1001		
----------------------	---------	--	--



1

código	519085	referencia	902880
---------------	--------	-------------------	--------

descripción	tornillo de cabeza moleteada ø 34mm rosca M6		
--------------------	--	--	--

Para modelos:	GDW1001, GGW1001		
----------------------	------------------	--	--



1

código	519201	referencia	904765
---------------	--------	-------------------	--------

descripción	tubo de aclarado		
--------------------	------------------	--	--

Para modelos:	GGW1001, GGW2001		
----------------------	------------------	--	--



1

código	519438	referencia	903743
---------------	--------	-------------------	--------

descripción	tubo de lavado ø 37mm L 700mm plástico apto para Silanos		
--------------------	--	--	--

Para modelos:	GDW1001		
----------------------	---------	--	--

para tostadoras

recambios y accesorios



1

código	693043	referencia	F02005
---------------	--------	-------------------	--------

descripción	rejilla de protección		
--------------------	-----------------------	--	--

Para modelos:	GTO1001, GTO2001		
----------------------	------------------	--	--

otros

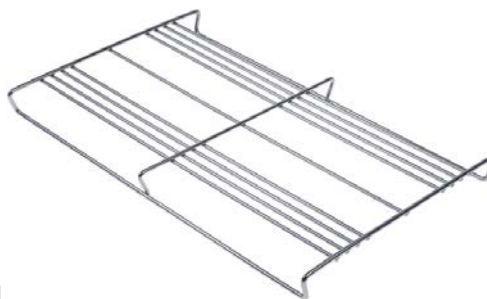

1

código	694449	referencia	F01069
---------------	--------	-------------------	--------

descripción	rejilla de protección L 315mm An 200mm para tostadora H 24mm		
--------------------	--	--	--

Para modelos:	GTO1001, GTO2001		
----------------------	------------------	--	--

para unidades de vacío

tapa



1

código	699600	referencia	HVS1000-02 YJS820-2
---------------	--------	-------------------	------------------------

descripción	tapa L 420mm An 350mm HVS1000		
--------------------	-------------------------------	--	--

cilindros de aire a presión

cilindros de aire a presión



1

código	692702	referencia	HVS1000-17 YJS820-17
---------------	--------	-------------------	-------------------------

descripción	cilindro de aire a presión ø 53mm H 30.5mm longitud árbol 12.8mm 1 par		
--------------------	---	--	--

cajas y paneles frontales

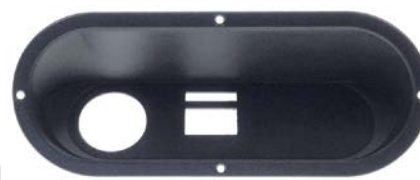

1

código	699610	referencia	HVS1000-34 YJS820-34
---------------	--------	-------------------	-------------------------

descripción	panel frontal para unidad de vacío An 100mm H 40mm HVS1000 L 250mm		
--------------------	--	--	--



topes de goma



1

código	699607	referencia	HVS1000-31 YJS820-31
descripción	tope de goma H 3mm L 30mm An 20mm 4 piezas		

barra de sellado



1

código	699601	referencia	HVS1000-07 YJS820-7
descripción	barra de sellado L 295mm An 20mm H 24mm		

base



1

código	699617	referencia	HVS1000-24 YJS820-24
descripción	placa de asiento L 132mm An 105mm H 0.5mm		



1

código	699611	referencia	HVS1000-01 YJS820-1
descripción	placa de asiento L 30mm An 30mm H 2mm 1 par agujero ø 5mm		



1

código	699445	referencia	HVS1000-43 YJS820-43
descripción	placa de asiento L 95mm An 90mm H 0.5mm		

otros



1

código	699605	referencia	HVS1000-14 YJS820-14
descripción	abrazadera L 95mm An 34mm H 48mm		



1

código	699602	referencia	HVS1000-06 YJS820-6
descripción	rail de goma L 298mm An 23mm H 9.5mm barra de sellado		



1

código	699609	referencia	HVS1000-12 YJS820-12
descripción	resorte L 104mm An 32mm to secure		



1

código	699604	referencia	HVS1000-48 YJS820-48
descripción	soporte L 38mm An 36mm H 124mm para microinterruptor		



1

código	699613	referencia	HVS1000-13 YJS820-13
descripción	tapón L 9mm An 6mm 1 par		



1

código	699608	referencia	HVS1000-10 YJS820-10
descripción	tuerca para entrada de aire rosca 1/4"		

para wok



1

código	694580	referencia	GIC4035-01 GIC4035-C01
descripción	cuenco para Wok para wok de inducción ø 310mm H 69mm Ceran		
Para modelos:	GIC4035		

pomos

pomos universales



1

código	112733	referencia	3.ZCK165BT19010101MGB GDF1104-020 GDF1108-007 GDF2124-020 GDF2124-20 GDF2128-007 HDF1108-020 HDF2128-020
descripción	pomo marca cero T máx°C ø 55mm eje ø 6x4,6mm parte plana arriba negro		
Para modelos:	GDF1104, GDF1108, GDF2124, GDF2128		

otros



1

código	692677	referencia	SLZI0001
descripción	pomo ø 26mm gris marca cero para termostato alojamiento del eje 6x4mm UE 1		



1

código	696506	referencia	2858
descripción	pomo para placa electrónica ø 26mm negro UE 1 pzs		
Para modelos:	GSM1000		

accesorios

rosetas



1

código	111806	referencia	3.ZCK165BT20010101-1 GDF1104-019 GDF1108-006 GDF2124-019 GDF2128-006 GDF2128-6 HDF1108-019 HDF2128-019
descripción	roseta pomo ø 16mm ø 55mm		
Para modelos:	GDF1104, GDF1108, GDF2124, GDF2128		

manillas y volantes

manillas de seta



1

código	111441	referencia	016240439
descripción	pomo seta con tornillo rosca M4 asidero ø 28mm L 24mm negro para tapa		
Para modelos:	GDF1004, GDF2024		



1

código	698641	referencia	00000001111
descripción	pomo seta rosca M6 asidero ø 34mm L 25mm aluminio		
Para modelos:	GFS1030		



1

código	691510	referencia	016210828
descripción	asa de arco L 130mm H 44mm distancia de sujeción 112mm		
Para modelos:	GDF1008, GDF2028		

barras de asidero

agarraderos específicas del fabricante

TECNOEKA



1

código	694993	referencia	00011680
descripción	manilla de puerta ø 18mm L 350mm acero inoxidable M5 negro mate		
Para modelos:	GCO2001		



1

código	698563	referencia	A0ND024
descripción	asa de arco L 144mm H 42mm distancia de sujeción 136mm rosca M3 An 32mm		
Para modelos:	GCM3016		



1

código	697997	referencia	A0ND006
descripción	manilla L 107mm H 20mm distancia de sujeción 60mm para contenedor ø 20mm An 46mm negro		
Para modelos:	GCM1006, GCM2009, GCM3016		

agarraderos

agarraderos



1

código	699449	referencia	HSC350DD-48 HSC350DD-52 SLZB0020
descripción	asidero para frigorífico L 220mm An 36mm H 23mm gris dist. del agujero 120mm		
Para modelos:	GSC2336		



1

código	699606	referencia	HVS1000-03 YJS820-3
descripción	manilla L 140mm H 38mm distancia de sujeción 120mm agujero ø 8.5mm		

asas de arco



1

código	698580	referencia	A0ND001
descripción	asa de arco L 114mm H 33mm distancia de sujeción 106mm rosca M3 An 30mm		
Para modelos:	GCM1006, GCM2009		

asideros para grills abatibles



1

código	692149	referencia	902264
descripción	manilla L 155mm ø 30mm soporte ø 10mm para grill de contacto		
Para modelos:	GPG1001		



empuñaduras



1

código	697995	referencia	016240427
descripción	empuñadura L 90mm An 60mm H 23.5mm distancia de sujeción 75mm plástico para freidora		
Para modelos:	GDF1004, GDF2024		

manillas para puertas

manillas para puertas



1

código	694617	referencia	GMW1030-P34
descripción	barra de asidero tubo ø 16mm L 235mm aluminio UE 1 pzs		
Para modelos:	GMW1030		

otros



1

código	692402	referencia	1.1.C.C12.14 GGC1078-15-white GGC1078-WHITE-15
descripción	manilla gris para vitrina H 9.5mm L 85mm An 25mm distancia de sujeción 70mm UE 1 pzs		



1

código	691960	referencia	A15015
descripción	manilla L 100mm An 32mm dist. del agujero 70mm para tapa		
Para modelos:	GTO1001, GTO2001		

MANILLAS Y VOLANTES HORECA-SELECT



1

código	110921	referencia	A15016
descripción	manilla L 130mm An 39mm dist. del agujero 91mm UE 1 pzs		
Para modelos:	GHM1001		



1

código	692545	referencia	3.HDF409010101 GDF1104-025 GDF1104-25 GDF2124-025
descripción	manilla L 96mm An 64mm dist. del agujero 73mm pos. de montaje panel lateral negro		
Para modelos:	GDF1104, GDF2124		



1

código	698858	referencia	1.1.C.C12.15 GGC1078-15-black
descripción	manilla negro para vitrina H 9.5mm L 85mm An 25mm distancia de sujeción 70mm UE 1 pzs		



1

código	692409	referencia	1.1.C.C12.06 GGC2270-18 GGC2270-18-white
descripción	manilla de puerta L 100mm An 32mm dist. del agujero 68mm blanco		
Para modelos:	GGC1270		



cierres

dispositivos de cierre

específico del fabricante

HORECA SELECT



1

código	692317	referencia	RC600.37 RN600.24
descripción	cilindro de cerradura con manilla ø 18.4mm ángulo de rotación 45° longitud de pestillo 40mm anchura de pestillo 15mm		
Para modelos:	GFR2600, GRE2600		
accesorios para	692317		
	código	692318	referencia
			RC600.36 RN600.25
	llave par para cilindro de cerradura 692317		



1

código	348185	referencia	Z04AC21A0002
descripción	cilindro de cerradura con manilla ø 18.4mm ángulo de rotación 45° longitud de pestillo 40mm anchura de pestillo 15mm con llave		
Para modelos:	GPS2600, GSA2600, GSD2600, GSF2600		



1

código	699178	referencia	RC400.22 RN400.26 RN400.27
descripción	cilindro de cerradura con manilla ø 18.4mm ángulo de rotación 45° longitud de pestillo 48mm anchura de pestillo 16mm con llave		
Para modelos:	RC400, RN400		



1

código	692318	referencia	RC600.36 RN600.25
descripción	llave par para cilindro de cerradura 692317		
Para modelos:	GFR2600, GRE2600		
accesorios para	692318		
	código	692317	referencia
			RC600.37 RN600.24
	cilindro de cerradura con manilla ø 18.4mm ángulo de rotación 45° longitud de pestillo 40mm anchura de pestillo 15mm		

bisagras

bisagras de resorte

específico del fabricante

RWA



1

código	701124	referencia	GPS1134-6 GPS1600-06 GSF1600-06
descripción	bisagra a resorte pos. de montaje 22x22 izquierdo/derecho L 76mm An 25mm H 101mm A 11mm B 15mm soporte 7,5x7,5 aparatos de refrigeración distancia de sujeción 25.4mm		
Para modelos:	GPS1134, GPS1600, GSF1134, GSF1600		



1

código	701145	referencia	RC400.25 RC600.39 RN400.28 RN600.28
descripción	bisagra a resorte pos. de montaje arriba L 65mm An 23mm distancia de sujeción 21mm		
Para modelos:	GFR2600, GRE2600, RC400, RN400		





1

código	701586	referencia	GN2100TN.04 Z04AA02A0007
descripción	bisagra a resorte pos. de montaje izquierdo/derecho L 74.5mm An 25mm H 102mm medida de montaje 8x8mm aparatos de refrigeración distancia de sujeción 25mm		
Para modelos:	GDS1600, GSA1134, GSA1600		

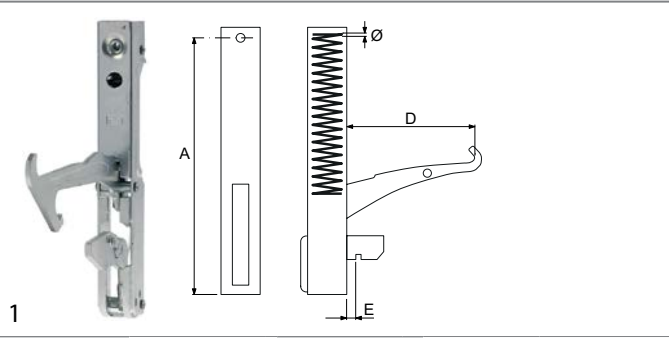
bisagras para hornos



código	700000	referencia	01980859512
descripción	bisagra para horno distancia de sujeción 142mm distancia de sujeción 2mm orejas de fijaciónmm longitud de palanca 127mm distancia de ranura 10mm espesor de resorte 3.7mm posición fijación L 155mm pos. de montaje izquierdo/derecho		
Para modelos:	GCO1001		
accesorios para	700000		
	código	693045	referencia —
	contrasoste L 110mm An 12mm distancia de sujeción 94mm		
	código	700707	referencia —
	contrasoste distancia de sujeción 94mm L 140mm pos. de montaje izquierdo An 13mm con chapa soldada H 110mm para bisagra		

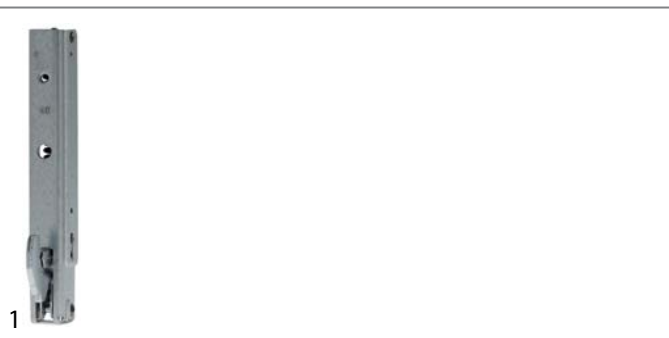

código	701573	referencia	00014610
descripción	bisagra para horno distancia de sujeción 142mm distancia de sujeción 2mm orejas de fijaciónmm longitud de palanca mm distancia de ranura 12mm espesor de resorte 3.3mm posición fijación longitud muelle 116mm L 170mm pos. de montaje izquierdo/derecho An 22mm		
Para modelos:	GCO2001		
accesorios para	701573		
	código	701631	referencia 00014600
	contrasoste distancia de sujeción 119mm L 135mm An 12mm		



código	701631	referencia	00014600
descripción	contrasoste distancia de sujeción 119mm L 135mm An 12mm		
Para modelos:	GCO2001		
accesorios para	701631		
	código	701573	referencia 00014610
	bisagra para horno distancia de sujeción 142mm distancia de sujeción 2mm orejas de fijaciónmm longitud de palanca mm distancia de ranura 12mm espesor de resorte 3.3mm posición fijación longitud muelle 116mm L 170mm pos. de montaje izquierdo/derecho An 22mm		

soporte de puerta



código	694927	referencia	HSC360-29
descripción	bisagra L 105mm An 52mm H 34mm perno 17mm perno ø 7mm		



código	701260	referencia	RW40.14
descripción	bisagra L 114mm An 50mm H 29mm pos. de montaje izquierdo/derecho abajo perno 16mm árbol ø 7mm UE 1 pzs		
Para modelos:	GHR1040, GHR2600		



código	701564	referencia	46996000
descripción	bisagra L 130mm An 85mm H 38mm distancia de sujeción 48mm distancia de sujeción 2 33mm rosca M6 ø 8mm perno 13mm perno ø 8mm		
Para modelos:	GFR3600, GRE3600		





 <p>1</p>			
código	692374	referencia	GPS1600-05 GSF1600-05 S900.05
descripción	bisagra L 30mm An 30mm H 45mm pos. de montaje abajo derecha espesor 3mm UE 1 pzs		
Para modelos:	GDS1600, GPS1134, GPS1600, GSA1134, GSA1600, GSF1134, GSF1600		

 <p>1</p>			
código	692258	referencia	GPS1600-50 GSF1600-50 S900.55
descripción	bisagra L 30mm An 30mm H 45mm pos. de montaje abajo izquierda espesor 3mm		
Para modelos:	GDS1600, GPS1134, GPS1600, GSA1134, GSA1600, GSF1134, GSF1600		

 <p>1</p>			
código	701284	referencia	GBC1001-43 GBC1002-46 GBC1003-46
descripción	bisagra L 39mm An 39mm H 23mm UE 1 pzs		

 <p>1</p>			
código	692375	referencia	S900.19.1
descripción	bisagra L 40mm An 43mm pos. de montaje izquierdo/derecho para tapa UE 1 pzs		
Para modelos:	GDS1600, GSA1134, GSA1600		

 <p>1</p>			
código	692690	referencia	S24AC22A0003
descripción	bisagra L 40mm An 70mm H 22mm distancia de sujeción 2.20mm		
Para modelos:	GPS2600, GSA2600, GSD2600, GSF2600		

 <p>1</p>			
código	701026	referencia	0162886
descripción	bisagra L 56mm An 50mm pos. de montaje arriba espesor 3mm		
Para modelos:	GFR1600, GRE1600		
accesorios para	701026		
	código	referencia	0530022
	 perno L 45mm pos. de montaje arriba rosca M8x1,25 ø 12mm para bisagra		

 <p>1</p>			
código	701027	referencia	0415122
descripción	bisagra L 58mm An 28mm H 73mm pos. de montaje abajo con perno		
Para modelos:	GFR1600, GRE1600		

 <p>1</p>			
código	701143	referencia	RC600.22 RN400.19 RN600.15
descripción	bisagra L 59mm An 27mm H 59mm pos. de montaje abajo derecha UE 1 pzs		
Para modelos:	GFR2600, GRE2600, RN400		

 <p>1</p>			
código	701144	referencia	RC400.16 RC600.20 RN400.17 RN600.12
descripción	bisagra L 59mm An 27mm H 59mm pos. de montaje abajo izquierda		
Para modelos:	GFR2600, GRE2600, RC400, RN400		

 <p>1</p>			
código	694968	referencia	HSC350DD-25 WJMA2020
descripción	bisagra L 77mm An 19mm H 42mm distancia de sujeción 27mm distancia de sujeción 2.27mm pos. de montaje centro espesor 3mm perno 18/22mm perno ø 7mm		



código	694592	referencia	GSC1336-08 GSC2336-08
descripción	bisagra L 82mm An 42mm H 50mm pos. de montaje abajo con perno UE 1 pzs		
Para modelos:	GSC1336		



código	694866	referencia	HSC350-22 WJMA2003
descripción	bisagra pos. de montaje abajo L 82mm An 53mm H 43mm distancia de sujeción 30mm distancia de sujeción 2 56mm espesor 4mm perno 20mm perno ø 7mm		
Para modelos:	GSC2336		



código	694926	referencia	HSC360-23 WJMA2012
descripción	bisagra L 82mm An 42mm H 50mm pos. de montaje abajo perno 19mm perno ø 9mm		



código	694593	referencia	GSC1336-06 GSC2336-06 GSC2336-6
descripción	bisagra pos. de montaje arriba con perno UE 1 pzs		
Para modelos:	GSC1336		



código	701261	referencia	RW40.13
descripción	bisagra L 85mm An 13mm H 20mm pos. de montaje arriba derecha UE 1 pzs		
Para modelos:	GHR1040, GHR2600		



código	694865	referencia	HSC350-32 WJMA0004
descripción	bisagra pos. de montaje arriba L 50mm An 33mm H 42mm distancia de sujeción 27mm espesor 3mm perno 32.5mm perno ø 9mm UE 1kg		
Para modelos:	GSC2336		



código	701258	referencia	RW40.12
descripción	bisagra L 85mm An 13mm H 20mm pos. de montaje izquierdo arriba UE 1 pzs		
Para modelos:	GHR1040, GHR2600		



código	701280	referencia	GSC1100-10 WJMA4002
descripción	bisagra de puerta L 42mm An 33mm H 82mm pos. de montaje abajo derecha/izquierda juego UE 1 pzs		
Para modelos:	GSC1100, GSC1100G		



código	701563	referencia	43870000
descripción	bisagra L 98mm An 48mm H 38mm distancia de sujeción 40mm distancia de sujeción 2 20mm rosca M6		
Para modelos:	GFR3600, GRE3600		



código	701281	referencia	GSC1100-13 WJMA4005
descripción	bisagra de puerta L 43mm An 82mm H 71mm pos. de montaje arriba derecha/izquierda juego UE 1 pzs		
Para modelos:	GSC1100, GSC1100G		



1

código	698866	referencia	GPC1046-12 GPC1088-13
descripción	bisagra de puerta L 90mm An 40mm H 19mm pos. de montaje abajo perno 13mm perno ø 10.5mm		
Para modelos:	GPC1046, GPC1088		



1

código	698863	referencia	GPC1046-04 GPC1088-05
descripción	bisagra de puerta L 90mm An 40mm H 19mm pos. de montaje arriba perno 13mm perno ø 10.5mm		
Para modelos:	GPC1046, GPC1088		



1

código	701265	referencia	RC400.35 RC600.27 RN400.33 RN600.19
descripción	casquillo H 12mm pos. de montaje abajo ø 19mm int.ø 14.5mm plástico para bisagra de puerta batiente UE 1 pzs		
Para modelos:	GFR2600, GRE2600, RC400, RN400		



1

código	692421	referencia	1.1.C.C13.01 GGC1078-34 GGC1270-42-plastic GGC2270-42-plastic
descripción	casquillo H 15mm ø 10/13mm int.ø 7mm plástico para bisagra de puerta batiente UE 1 pzs		
Para modelos:	GGC1270		



1

código	701263	referencia	RC400.36 RC600.26 RN400.34 RN600.17
descripción	casquillo H 18mm pos. de montaje abajo ø 14mm int.ø 7.2mm para bisagra de puerta batiente UE 1 pzs		
Para modelos:	GFR2600, GRE2600, RC400, RN400		



1

código	701567	referencia	41649000
descripción	casquillo L 11mm ø 11/15mm espesor 2mm		
Para modelos:	GFR3600, GRE3600		



1

código	692379	referencia	GPS1134-51 GPS1600-51 GSF1600-51
descripción	casquillo L 23mm ø 9.8mm int.ø 7.3mm gris UE 1 pzs		
Para modelos:	GPS1134, GPS1600, GSF1134, GSF1600		



1

código	692396	referencia	GSC1100-11
descripción	casquillo L 25mm ø 12mm int.ø 9.4mm transparente para bisagra de puerta batiente UE 1 pzs		



1

código	701572	referencia	I0534002
descripción	casquillo ø 18.5mm int.ø 12mm		
Para modelos:	GFR3600, GRE3600		



1

código	699419	referencia	1.1.B.B09.01 GGC1078-25
descripción	cojinete giratorio L 55mm An 15mm H 14mm distancia de sujeción 26mm pos. de montaje arriba		

			
1			
código	698918	referencia	A1.1.B.B19.08
descripción	cojinete giratorio L 60mm An 37mm H 27mm distancia de sujeción 23mm distancia de sujeción 2 23mm pos. de montaje arriba derecha perno 23mm ø 7mm		
Para modelos:	GRV1100		

			
1			
código	701256	referencia	S900.28
descripción	perno L 17mm pos. de montaje izquierdo/derecho rosca M4 ø 7mm para bisagra UE 1 pzs		
Para modelos:	GDS1600, GSA1134, GSA1600		

			
1			
código	701566	referencia	46997000
descripción	cojinete giratorio L 72mm An 39mm H 30mm distancia de sujeción 25mm distancia de sujeción 2 25mm pos. de montaje derecho		
Para modelos:	GFR3600, GRE3600		

			
1			
código	701275	referencia	GRE2600-24 RC400.37 RC600.24 RN400.35
descripción	perno L 19mm pos. de montaje abajo rosca M6 ø 7mm para bisagra de puerta batiente UE 1 pzs		
Para modelos:	GRE2600, RC400, RN400		

			
1			
código	701565	referencia	48205000
descripción	cojinete giratorio L 72mm An 39mm H 30mm distancia de sujeción 25mm distancia de sujeción 2 25mm pos. de montaje izquierdo		
Para modelos:	GFR3600, GRE3600		

			
1			
código	701257	referencia	GN2100TN.05 GPS1134-9 GPS1600-09 S900.06
descripción	perno L 25mm pos. de montaje arriba rosca M5 ø 7mm completo para bisagra de puerta batiente UE 1 pzs		
Para modelos:	GDS1600, GPS1134, GPS1600, GSA1134, GSA1600		

			
1			
código	699423	referencia	1.1.B.B09.17 GGC2270-25
descripción	cojinete giratorio L 85mm An 17mm H 17mm distancia de sujeción 48mm pos. de montaje arriba		
Para modelos:	GGC1270		

			
1			
código	701276	referencia	GSF1134-09 GSF1600-09
descripción	perno L 31mm pos. de montaje arriba rosca M8 ø 5/7mm para bisagra de puerta batiente UE 1 pzs		
Para modelos:	GSF1134, GSF1600		

			
1			
código	692406	referencia	1.1.B.B10.17 GGC1270-42-brass GGC2270-44
descripción	perno H 16.5mm ø 10/14mm int.ø 7mm latón para bisagra de puerta batiente UE 1 pzs		
Para modelos:	GGC1270		

			
1			
código	701264	referencia	RN600.16
descripción	perno L 32mm pos. de montaje abajo rosca M6 ø 7mm para bisagra de puerta batiente UE 1 pzs		
Para modelos:	GFR2600		



1

código	701562	referencia	44447000
descripción	perno L 36mm An 22mm rosca M6 perno 12mm perno ø 12mm		
Para modelos:	GFR3600, GRE3600		



1

código	701025	referencia	0530022
descripción	perno L 45mm pos. de montaje arriba rosca M8x1,25 ø 12mm para bisagra		
Para modelos:	GFR1600, GRE1600		
accesorios para	701025		
	código	701026	referencia 0162886
	bisagra L 56mm An 50mm pos. de montaje arriba espesor 3mm		

accesorios

base



1

código	701266	referencia	RC400.34 RC600.42 RN400.32 RN600.34
descripción	placa de asiento L 88mm An 35mm espesor 3mm para bisagra de puerta batiente pos. de montaje abajo UE 1 pzs		
Para modelos:	GFR2600, GRE2600, RC400, RN400		

elementos extraíbles

ruedas de rodadura

ruedas de rodadura



1

código	692376	referencia	S900.24
descripción	rueda de rodadura rodillo ø 12mm anchura total 5mm A 12mm B 5mm plástico con racor taladro ø 5.4mm rosca M4 rosca L 5.5mm UE 1 pzs		
Para modelos:	GSA1134, GSA1600		

ruedas de rodadura con soporte



1

código	692385	referencia	RC600.23 RN600.11
descripción	rueda de rodadura rodillo ø 21mm A1 7mm con soporte inox/plástico pos. de montaje abajo cojinete rodamiento de bolas UE 1 pzs L 52mm distancia de sujeción 41mm		
Para modelos:	GFR2600, GRE2600		

grifería para cocinas industriales

grifos de caño

universal

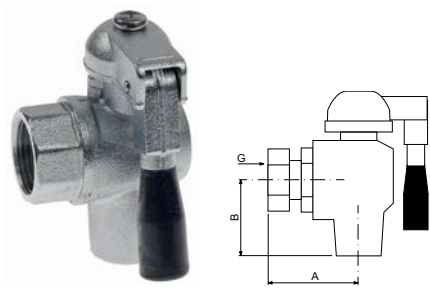

1

código	541540	referencia	016210829
descripción	grifo de salida latón niquelado An 38mm H 40mm rosca 3/4" H		
Para modelos:	GDF1008, GDF2028		
repuestos para	541540		
	código	697834	referencia —
	manilla cónica rosca M6x1 ø 13mm plástico L 53mm negro rosca L 6mm		



1

código	692499	referencia	016210831
descripción	reducción L 46mm rosca 1/2" M / 3/4" M ø 26mm		
Para modelos:	GDF1008, GDF2028		



código	541749	referencia	016210830
descripción	roseta para grifo de salida rosca D1 ø 63mm D2 ø 25mm		
Para modelos:	GDF1008, GDF2028		

filtros

filtros de grasa

filtros de grasa



código	699331	referencia	WJD000050
descripción	filtro de grasa L 125mm An 120mm H 9mm		

accesorios



código	699332	referencia	WJD000049
descripción	marco inox para filtro L 144mm An 152mm		

accesorios

material de sujeción



código	694581	referencia	GIC3035-13 GIC3035-B13 GIC3500-13 GIC3500-A13 GIC3535-13 GIC3535-19 GIC3535-D13 GIC3535-D19 GIC4035-13 GIC4035-C13 WJB000079R
descripción	marco L 317mm An 170mm H 9mm para filtro		
Para modelos:	GIC3500, GIC3535, GIC4035		

pies para aparatos y tapas terminales

pies enroscables



código	701230	referencia	900888
descripción	kit pies de aparato rosca M5 rosca L 10mm ø 22mm H 12mm goma EC UE 4 pzs taladro ø 5/10mm		
Para modelos:	GJU1001		



código	700972	referencia	S900.13
descripción	pie de aparato rosca M10 rosca L 16mm ø 29mm H 11.5mm UE 1 pzs para frigorífico		
Para modelos:	GDS1134, GDS1600, GHS1134, GHS1600, GHS2134, GHS2600, GSA1134, GSA1600		



código	692235	referencia	A13012
descripción	pie de aparato rosca M10 rosca L 20mm ø 26mm H 6mm UE 1 pzs		
Para modelos:	GEG1001, GEG2001		



código	802156	referencia	00002790 09960058500
descripción	pie de aparato rosca M10 rosca L 20mm ø 60mm H 50mm UE 1 pzs		
Para modelos:	GCO1001, GCO2001		



código	701262	referencia	RC600.19 RN600.13
descripción	pie de aparato rosca M10 rosca L 40mm ø 36mm H 15.5mm UE 1 pzs		
Para modelos:	GFR2600, GRE2600		

1

código	701036	referencia	A13006
descripción	pie de aparato rosca M10 rosca L 40mm ø 40mm H 52mm UE 1 pzs		
Para modelos:	GEG1001		



1

código	802048	referencia	912058
descripción	pie de aparato rosca M6 rosca L 14mm ø 30mm H 16mm UE 4 pzs		
Para modelos:	GPG1001, GPG2001		



1

código	701112	referencia	0403014 I0403014
descripción	pie de aparato rosca M10 rosca L 43mm ø 29mm H 52mm plástico EC 35 UE 1 pzs		
Para modelos:	GFR1600, GFR3600, GRE1600, GRE3600		



1

código	701587	referencia	AB300037
descripción	pie de aparato rosca M6 rosca L 20mm ø 26mm H 11mm UE 1 pzs		



1

código	701451	referencia	00000001240
descripción	pie de aparato rosca M5 rosca L 13mm ø 37.5mm H 25mm cónico aluminio EC UE 1 pzs taladro ø 6mm		
Para modelos:	GFS1025		



1

código	701220	referencia	AB300055 GIC3035-10 GIC3035-B10 GIC3500-10 GIC3500-A10 GIC3535-10 GIC3535-D10 GIC4035-10 GIC4035-C10
descripción	pie de aparato rosca M6 rosca L 20mm ø 33mm H 20mm EC 12 UE 1 pzs		
Para modelos:	GIC3500, GIC3535, GIC4035		



1

código	701588	referencia	AB300038
descripción	pie de aparato rosca M5 rosca L 7mm ø 24mm H 20mm		



1

código	701324	referencia	GSF1600-13
descripción	pie de aparato rosca M8 rosca L 22mm ø 35mm H 29mm UE 1 pzs L 41mm		
Para modelos:	GSF1134, GSF1600		



1

código	701219	referencia	AB300035 GIC3035-11 GIC3035-B11 GIC3500-11 GIC3500-A11 GIC3535-11 GIC3535-D11 GIC4035-11 GIC4035-C11
descripción	pie de aparato rosca M5 rosca L 9mm ø 33mm H 34mm UE 1 pzs		
Para modelos:	GIC3500, GIC3535, GIC4035		



1

código	701279	referencia	GBC1001-23 GBC1002-24 GBC1003-24 HSC360-18 WJLB0008
descripción	pie de aparato rosca M8 rosca L 22mm ø 35mm H 38mm UE 1 pzs		



1

código	701259	referencia	RW40.42
descripción	pie de aparato rosca M8 rosca L 31mm ø 30mm H 12mm UE 1 pzs		
Para modelos:	GHR1040, GHR2600		



1

código	697996	referencia	016240431
descripción	pie de aparato ø 23mm H 23.5mm taladro ø 5mm UE 1 pzs		
Para modelos:	GDF1004, GDF1008, GDF2024		



1

código	698495	referencia	00000001251
descripción	pie de aparato rosca M8 rosca L 9mm ø 48mm H 43mm cónico aluminio EC UE 1 pzs		
Para modelos:	GFS1030		



1

código	697998	referencia	01058356
descripción	pie de aparato ø 24/36mm H 25mm taladro ø 19mm UE 1 pzs rosca M8x1,25		
Para modelos:	GIC2030, GIC2035		

pies roscados



1

código	701555	referencia	HVS1000-40 YJS820-40
descripción	kit pies de aparato ø 39mm H 17mm UE 4 pzs		



1

código	691509	referencia	A042567
descripción	pie de aparato ø 28mm H 17.5mm goma taladro ø 6mm UE 1 pzs		
Para modelos:	GDF2028		



1

código	701270	referencia	GHR1040-09 RW40.15
descripción	pie de aparato ø 20mm H 12mm plástico taladro ø 5mm UE 1 pzs GHR1040		
Para modelos:	GHR1040, GHR2600		



1

código	698546	referencia	3,0000161 GDF1104-026 GDF1108-025 GDF2124-026 GDF2128-026 GDF2128-26 HDF1108-023 HDF2128-024
descripción	pie de aparato ø 29mm H 16mm goma taladro ø 6mm UE 1 pzs		
Para modelos:	GDF1104, GDF1108, GDF2124, GDF2128		



1

código	691814	referencia	A13003
descripción	pie de aparato ø 22mm H 20mm taladro ø 4mm UE 1 pzs		
Para modelos:	GHM1001, GTO1001, GTO2001		



1

código	697433	referencia	00000000140 00000700140
descripción	pie de aparato ø 35mm H 26mm taladro ø 5mm UE 1 pzs		
Para modelos:	GFS1022, GFS2022, GFS2025, HFS2019, HFS2022, HFS2025		



pies de aparatos insertables

 <p>1</p>			
código	701251	referencia	223189000015 GMW1025-P26
descripción	pie de aparato ø 20mm H 12mm montaje ø 8mm medida de montaje 19mm altura total 19mm plástico UE 1 pzs		

tapas terminales y tapones

tapones de carcasas

 <p>1</p>			
código	692371	referencia	S900.25
descripción	tapón montaje ø 5.5mm ø 10mm H 13mm plástico UE 1 pzs		
Para modelos:	GSA1134, GSA1600		

otros

con placa de sujeción

ø30mm

 <p>1</p>			
código	701277 ¹	referencia	GSC1336-42 GSC2336-42 WJLA1001 WJLA1009
descripción	rueda pivotante 2 con y 2 sin freno ø 30mm placa de sujeción carcasa chapa de acero tincado dimensiones de la placa 61x51mm dist. del agujeromm capacidad 60kg cojinete cojinete de fricción cuerpo de rueda PVC superficie fricción PVC H 44mm ancho de rueda 23.5mm		
Para modelos:	GBC1001, GBC1002, GBC1003, GSC1336, GSC2336		

¹con freno total

 <p>1</p>			
código	701523	referencia	HSC360-17 WJLA2001
descripción	rueda pivotante ø 31mm placa de sujeción H 45mm ancho de rueda 22.5mm UE 1 pzs		

ø75mm

 <p>1</p>			
código	701282	referencia	GSC1100-30 HSC800-14 WJLA1002
descripción	juego de ruedas pivotantes 2 con y 2 sin freno ø 75mm sujeción placa 102x83mm carcasa chapa de acero tincado dist. del agujero 55/75mm cojinete cojinete de fricción H 112mm ancho de rueda 31mm UE 4 pzs		
Para modelos:	GSC1100, GSC1100G		

con espiga

ø40mm

 <p>1</p>			
código	701120	referencia	1.1.B.B10.95 1.1.B.B10.95+1.1.B.B10.96 GGC2270-03
descripción	juego de ruedas 2 con y 2 sin freno ø 40mm con perno roscado carcasa acero cromado rosca L 24mm rosca ø M10x1,5mm capacidad 60kg cojinete rodamiento de bolas cuerpo de rueda nylon superficie fricción nylon H 68mm ancho de rueda 20mm UE 4 pzs		
Para modelos:	GGC1270		

juegos diversos

 <p>1</p>			
código	710027	referencia	RC400.14 RC400.15 RN400.15 RN400.16
descripción	juego de ruedas ø 21.5mm roscada dimensiones de la placa 40x58mm dist. del agujero 24/42mm cuerpo de rueda plástico ancho de rueda 33mm		
Para modelos:	RC400, RN400		

cestos

cestos para freidoras

METRO



1			
código	970867	referencia	2.HDF403069510 GDF1104-030 GDF1104-30 GDF2124-029
descripción	cesto de freidora B1 160mm L1 220mm H1 130mm medida 4 litros		
Para modelos:	GDF1104, GDF2124		
accesorios para	970867		
	código	694736	referencia
	manilla L 143mm An 41mm H 22mm plástico		
	código	694782	referencia
	manilla para cesta freidora		
	código	694783	referencia
			HDF1108-038 HDF2128-039
	manilla para cesta freidora		

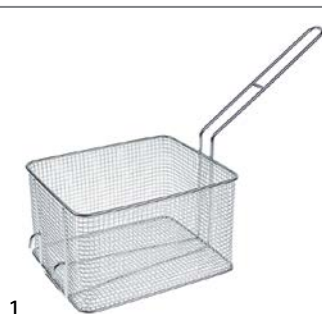

1			
código	970866	referencia	2.HDF800304 GDF1108-036 GDF2128-037 GDF2128-37
descripción	cesto de freidora B1 190mm L1 240mm H1 140mm sin asidero medida 8 litros		
Para modelos:	GDF1108, GDF2128		
accesorios para	970866		
	código	694736	referencia
	manilla L 143mm An 41mm H 22mm plástico		



1			
código	970868	referencia	HDF1108-033 HDF2128-034
descripción	cesto de freidora B1 200mm L1 250mm H1 140mm asidero abatible medida 8 litros		
accesorios para	970868		
	código	694736	referencia
	manilla L 143mm An 41mm H 22mm plástico		
	código	694782	referencia
	manilla para cesta freidora		
	código	694783	referencia
			HDF1108-038 HDF2128-039
	manilla para cesta freidora		



1			
código	694736	referencia	3.HDF818050101 GDF1104-029 GDF1104-29 GDF1108-037 GDF2124-030 GDF2128-038
descripción	manilla L 143mm An 41mm H 22mm plástico		
Para modelos:	GDF1104, GDF1108, GDF2124, GDF2128		
accesorios para	694736		
	código	560270	referencia
	tornillo cabeza abombada rosca M5 rosca L 12mm inox DIN 966/ISO 7047 UE 20 pzs soporte ranura cabeza avellanada		

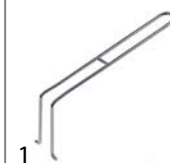

1			
código	694782	referencia	2.HDF812030609510 GDF1104-033 GDF2124-033
descripción	manilla para cesta freidora		
Para modelos:	GDF1104, GDF2124		

1

código	694783	referencia	HDF1108-038 HDF2128-039
descripción	manilla para cesta freidora		

tamices para empanar



1

código	970743	referencia	016210816
descripción	tamiz para empanar L 245mm An 205mm H 5mm acero cromado para freidora		
Para modelos:	GDF1008, GDF2028		



1

código	970742	referencia	016240418
descripción	tamiz para empanar L 216mm An 149mm H 37mm acero cromado para freidora		
Para modelos:	GDF1004, GDF2024		



1

código	970869	referencia	2.HDF405069510 GDF1104-028 GDF2124-028
descripción	tamiz para empanar L 220mm An 160mm H 35mm 4 litros		
Para modelos:	GDF1104, GDF2124		



1

código	970870	referencia	2.HDF812020609510 GDF1108-035 GDF2128-036 HDF1108-032 HDF1108-32 HDF2128-033
descripción	tamiz para empanar L 245mm An 200mm H 35mm 8 litros		
Para modelos:	GDF1108, GDF2128		

cestas alambre para hot dog



1

código	693004	referencia	F04012
descripción	cesto de rejilla para grill para hot dog ø 180mm H 210mm		
Para modelos:	GHM1001		

rejillas y rieles guía

parrillas

universal

sin reborde



1

código	970801	referencia	GBC1003-43 WJGA9008
descripción	parrilla An 345mm P 400mm acero cromado anillo externo reforzado 6mm refuerzos longitudinales 2.5mm traviesas 4 UE 1 pzs		
Para modelos:	GBC1003		



1

código	970800	referencia	GBC1001-41 WJGA9002
descripción	parrilla An 345mm P 500mm acero cromado anillo externo reforzado 6mm refuerzos longitudinales 2.5mm traviesas 4 UE 1 pzs		
Para modelos:	GBC1001		



código	970747	referencia	F01070
descripción	parrilla An 350mm P 240mm H 7mm inox para tostadora anillo externo reforzado 4mm refuerzos longitudinales 3mm traviesas ROLLER GRILL		
Para modelos:	GTO1001, GTO2001		



código	970905	referencia	GPC1046-13 GPC1088-14-half size
descripción	parrilla An 365mm P 165mm H 7mm anillo externo reforzado 4mm refuerzos longitudinales 3mm		
Para modelos:	GPC1046, GPC1088		



código	970906	referencia	GBC1002-43 GBC1003-43A GBC1003-43C WJGA9005
descripción	parrilla An 400mm P 345mm acero cromado anillo externo reforzado 6mm traviesas 4		
Para modelos:	GBC1002		

con reborde



código	750368	referencia	GSD1600-11 GSF1600-11 S900.11
descripción	parrilla An 320mm P 560mm acero plastificado anillo externo reforzado 7.5mm refuerzos longitudinales 3.5mm traviesas 2 gris		
Para modelos:	GDS1600, GSA1134, GSA1600		



código	970925	referencia	S14AC29A0001
descripción	parrilla An 325mm P 570mm GN 1/1 H 55mm acero plastificado anillo externo reforzado 7.5mm refuerzos longitudinales 4mm traviesas 3 gris		
Para modelos:	GPS2600, GSA2600, GSD2600, GSF2600		



código	970904	referencia	GPC1088-14-full size
descripción	parrilla An 350mm P 295mm H 30mm acero cromado anillo externo reforzado 4mm refuerzos longitudinales 2mm traviesas 1 UE 2 pzs		
Para modelos:	GPC1088		



código	970926	referencia	RC400.31
descripción	parrilla An 500mm P 400mm H 47mm acero plastificado anillo externo reforzado 8mm refuerzos longitudinales 4.5mm traviesas 1 blanco		
Para modelos:	RC400		



código	970791	referencia	GRE2600-28 RC600.28
descripción	parrilla An 650mm P 530mm GN 2/1 H 10mm acero plastificado arriba anillo externo reforzado 8mm refuerzos longitudinales 4mm traviesas 3 blanco		
Para modelos:	GRE2600		



código	970874	referencia	0427709
descripción	parrilla An 650mm P 540mm GN 2/1 H 30mm acero plastificado con tope para frigorífico anillo externo reforzado 7.3mm refuerzos longitudinales 3.2mm traviesas 2 blanco		
Para modelos:	GRE1600		







			
código	970795	referencia	1.1.B.B25.15 GCV1600-15
descripción	parrilla An 735mm P 235mm H 37mm acero cromado anillo externo reforzado 8mm refuerzos longitudinales 3mm traviesas 1		

			
código	970794	referencia	1.1.B.B25.16 GCV1600-14
descripción	parrilla An 735mm P 365mm H 35mm acero cromado anillo externo reforzado 8mm refuerzos longitudinales 3mm traviesas 1		

específico del fabricante

			
código	970792	referencia	GRE2600-25 RC600.25
descripción	parrilla An 185mm P 640mm acero plastificado abajo anillo externo reforzado 7mm refuerzos longitudinales 3.5mm blanco		
Para modelos:	GRE2600		

				
código	698856	referencia	1.1.B.B02.01.03 GGC1078-13-black	
descripción	parrilla An 360mm P 305mm acero plastificado			
accesorios para	698856			
	código	692400	referencia	1.1.C.C10.07 GGC1078-14 GGC1078-14-white
soporte de bandeja L 28.5mm An 14mm H 17.5mm plástico UE 1 pzs				
	código	698857	referencia	1.1.C.C10.08 GGC1078-14-black
soporte de bandeja L 28.5mm An 14mm H 17.5mm plástico UE 1 pzs				

			
código	970876	referencia	1.1.B.B02.01.01 GGC1078-13
descripción	parrilla An 360mm P 305mm acero plastificado		

			
código	692339	referencia	1.1.B.B02.04.01 GGC2270-41 GGC2270-41-white
descripción	parrilla An 430mm P 390mm H 8mm acero plastificado refrigeración anillo externo reforzado 8mm refuerzos longitudinales 3.6mm traviesas 5 blanco		
Para modelos:	GGC1270		

			
código	692696	referencia	1.1.B.B02.04.02 GGC2270-41-black
descripción	parrilla An 430mm P 390mm H 8mm acero plastificado refrigeración anillo externo reforzado 8mm refuerzos longitudinales 3.6mm traviesas 5 negro		

			
código	970927	referencia	RC400.32
descripción	parrilla An 500mm P 200mm H 25mm acero plastificado anillo externo reforzado 8mm refuerzos longitudinales 4mm traviesas 1 blanco		
Para modelos:	RC400		

			
código	970921	referencia	GSC1336-40 GSC2336-40 WJGA2010
descripción	parrilla An 500mm P 425mm H 38mm acero plastificado anillo externo reforzado 6.5mm refuerzos longitudinales 2.5mm traviesas 6 blanco UE 1kg		
Para modelos:	GSC1336		

			
código	970910	referencia	HSC360-38
descripción	parrilla An 530mm P 380mm H 40mm acero plastificado anillo externo reforzado 6mm refuerzos longitudinales 3mm traviesas 23		

			
1			
código	970799	referencia	GSC1100-09 WJGA4078
descripción	parrilla An 540mm P 505mm H 41mm acero plastificado anillo externo reforzado 6mm refuerzos longitudinales 3mm traviesas 3 blanco UE 1 pzs		
Para modelos:	GSC1100, GSC1100G		

			
1			
código	701252	referencia	1.1.B.B25.35 GCV1600-46
descripción	guía para portarrejillas L 405mm Hmm pos. de montaje izquierdo/derecho An 19mm inox UE 1 pzs		

			
1			
código	692368	referencia	1.1.B.B25.27 GCV1600-44
descripción	portarrejillas L 220mm H 83mm pos. de montaje abajo derecha inox UE 1 pzs		

			
1			
código	692366	referencia	1.1.B.B25.29 GCV1600-42
descripción	portarrejillas L 220mm H 83mm pos. de montaje arriba derecha inox UE 1 pzs		

			
1			
código	692365	referencia	1.1.B.B25.28 GCV1600-41
descripción	portarrejillas L 220mm H 83mm pos. de montaje arriba izquierda inox UE 1 pzs		

			
1			
código	692367	referencia	1.1.B.B25.26 GCV1600-43
descripción	portarrejillas L 320mm H 83mm pos. de montaje abajo izquierda inox UE 1 pzs		

			
1			
código	691917	referencia	F03006
descripción	asidero de rejilla L 204mm An 80mm		
Para modelos:	GTO1001, GTO2001		

			
1			
código	970930	referencia	44714000
descripción	parrilla An 650mm P 330mm H 9mm anillo externo reforzado 7mm refuerzos longitudinales 3mm traviesas 1		
Para modelos:	GRE3600		

			
1			
código	970929	referencia	44379000
descripción	parrilla An 665mm P 560mm H 30mm anillo externo reforzado 7mm refuerzos longitudinales 3mm traviesas 2		
Para modelos:	GFR3600, GRE3600		

			
1			
código	971149	referencia	RN600.05
descripción	parrilla An 715mm H 55mm acero plastificado L 365mm refuerzos longitudinales 4mm traviesas 4 blanco		
Para modelos:	GFR2600		

			
1			
código	971150	referencia	RC600.09
descripción	rejilla An 693mm P 303mm H 6mm acero plastificado refuerzos longitudinales 4mm traviesas 4 blanco		
Para modelos:	GRE2600		

accesorios

			
1			
código	971150	referencia	RC600.09
descripción	rejilla An 693mm P 303mm H 6mm acero plastificado refuerzos longitudinales 4mm traviesas 4 blanco		
Para modelos:	GRE2600		

			
1			
código	691917	referencia	F03006
descripción	asidero de rejilla L 204mm An 80mm		
Para modelos:	GTO1001, GTO2001		

rieles guía y soportos

universal



código	690332	referencia	I0402138
descripción	soporte de bandeja L 31/28mm An 22mm H 17mm inox con gancho UE 1 pzs		
Para modelos:	GFR3600, GRE3600		
accesorios para	690332		
	código	690330	referencia —
	cremallera L 1000mm An 22mm H 4mm tamaño orificio 3x8mm dist. del agujero 12.5mm acero inoxidable		

específico del fabricante



código	701269	referencia	RC600.29
descripción	cremallera L 1172mm An 22mm aluminio dist. del agujero 13mm UE 1 pzs tamaño orificio 3x8mm		
Para modelos:	GRE2600		



código	701278	referencia	GSC1100-37
descripción	cremallera L 1290mm An 26mm dist. del agujero 22mm UE 1 pzs tamaño orificio 10x10mm		



código	701550	referencia	S24AC29A0002
descripción	cremallera L 244mm An 50mm H 8mm pos. de montaje anterior		
Para modelos:	GPS2600, GSA2600, GSD2600, GSF2600		



código	701549	referencia	GPS1600-18 GSF1600-18 S24AC29A0005 S900.18
descripción	cremallera L 245mm An 40mm H 30mm pos. de montaje derecho		
Para modelos:	GDS1134, GDS1600, GPS1134, GPS1600, GPS2600, GSA1134, GSA1600, GSA2600, GSD2600, GSF1134, GSF1600, GSF2600		



código	701548	referencia	GSF1600-48 S24AC29A0004 S900.50
descripción	cremallera L 245mm An 40mm H 30mm pos. de montaje izquierdo		
Para modelos:	GDS1134, GDS1600, GPS2600, GSA1134, GSA1600, GSA2600, GSD2600, GSF1134, GSF1600, GSF2600		



código	699231	referencia	I0402137
descripción	guida blanco L 1350mm An 20mm H 5mm UE 1		
Para modelos:	GFR3600, GRE3600		



código	698870	referencia	GBC1001-25 GBC1002-26 GBC1003-26 LCCJ2001
descripción	guida L 390mm An 25mm pos. de montaje izquierdo/derecho altura interior 4mm		
Para modelos:	GBC1001, GBC1002, GBC1003		



código	696443	referencia	GPS1600-10 GSF1600-10 KITGD4AC2A00 S900.10.1
descripción	par de barras de ajuste forma U L 548mm An 20mm altura interior 13mm pos. de montaje izquierdo/derecho		
Para modelos:	GDS1600, GPS1134, GPS1600, GPS2600, GSA1134, GSA1600, GSA2600, GSD2600, GSF1134, GSF1600, GSF2600		





código	696388	referencia	S900.10
descripción	par de barras de ajuste forma U L 550mm An 20mm H 17mm pos. de montaje izquierdo/derecho		

			
1			
código	701585	referencia	GPS1600-12 GSF1600-12 S900.12
descripción	par de barras de ajuste L 245mm An 29mm H 15mm		
Para modelos:	GDS1134, GDS1600, GPS1134, GPS1600, GSA1134, GSA1600, GSF1134, GSF1600		

			
1			
código	692399	referencia	GSC1100-38
descripción	soporte de bandeja L 24mm An 7mm H 28mm aluminio para frigorífico UE 1 pzs		

			
1			
código	692398	referencia	GBC1001-42 GBC1002-44 GBC1003-44 LCCK0002
descripción	soporte de bandeja L 24mm An 9mm H 29mm aluminio para frigorífico UE 1 pzs		
Para modelos:	GBC1001, GBC1002, GBC1003		

			
1			
código	692400	referencia	1.1.C10.07 GGC1078-14 GGC1078-14-white
descripción	soporte de bandeja L 28.5mm An 14mm H 17.5mm plástico UE 1 pzs		

			
1			
código	698857	referencia	1.1.C10.08 GGC1078-14-black
descripción	soporte de bandeja L 28.5mm An 14mm H 17.5mm plástico UE 1 pzs		

			
1			
código	692387	referencia	RC600.32
descripción	soporte de bandeja L 31/28mm An 22mm H 19mm UE 1 pzs		
Para modelos:	GRE2600		

			
1			
código	694591	referencia	GSC1336-39 GSC2336-39 SLZE0028
descripción	soporte de bandeja L 33mm An 9mm H 27mm aluminio para frigorífico UE 1 pzs		
Para modelos:	GSC1336		

			
1			
código	692408	referencia	1.1.C10.09 GGC2270-17 GGC2270-17-white
descripción	soporte de bandeja L 38.5mm An 14mm H 18mm plástico UE 1 pzs		
Para modelos:	GGC1270		

			
1			
código	699416	referencia	1.1.C10.10 GGC2270-17-black
descripción	soporte de bandeja L 38.5mm An 14mm H 18mm plástico UE 1 pzs		

juntas

juntas para frigoríficos

juntas insertables

perfil 9161

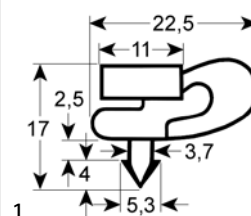

			
1			
código	902208	referencia	HSC360-39 SLJP2025
descripción	junta para frigorífico perfil 9161 An 590mm L 1540mm medida inserción		

1

código	902465	referencia	HSC350DD-46 HSC350DD-49 SLJP2015
descripción	junta para frigorífico perfil 9161 An 590mm L 650mm medida inserción		

perfil 9151

Fabricamos burlletes personalizables de este perfil

1

código	901377	referencia	0313291
descripción	junta para frigorífico perfil 9151 An 715mm L 1674mm medida inserción L1 1686mm B1 722mm medidas exteriores		
Para modelos:	GFR1600, GRE1600		

perfil 9149

1

código	902216	referencia	R04AC22A0002
descripción	junta para frigorífico perfil 9149 An 385mm L 480mm medida inserción		
Para modelos:	GPS2600, GSA2600, GSD2600, GSF2600		

1

código	902215	referencia	RC400.29 RN400.30
descripción	junta para frigorífico perfil 9149 An 555mm L 1680mm medida inserción		
Para modelos:	RC400, RN400		

1

código	901524	referencia	RC600.40 RN600.29
descripción	junta para frigorífico perfil 9149 An 720mm L 1710mm medida inserción		
Para modelos:	GFR2600, GRE2600		

perfil 9058

1

código	902395	referencia	44404000
descripción	junta para frigorífico perfil 9058 An 770mm L 1810mm medida inserción UE 1		
Para modelos:	GFR3600, GRE3600		

perfil 9152

1

código	902421	referencia	S901-4D.08
descripción	junta para frigorífico perfil 9152 An 225mm L 390mm medida inserción		
Para modelos:	GDS1134		

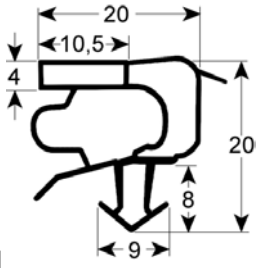

código	901486	referencia	GPS1600-08 GSF1600-08 S900.08
descripción	junta para frigorífico perfil 9152 An 390mm L 485mm medida inserción		
Para modelos:	GDS1600, GPS1134, GPS1600, GSA1134, GSA1600, GSF1134, GSF1600		

perfil 9156

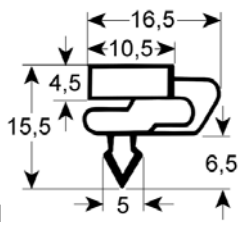

código	901662	referencia	GSC1100-14 SLJP4007
descripción	junta de puerta perfil 9156 An 569mm L 1295mm medida inserción UE 1 pzs		
Para modelos:	GSC1100, GSC1100G		

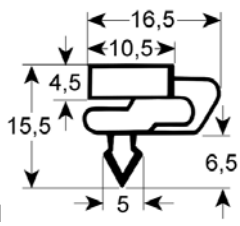

código	901674	referencia	GBC1002-48
descripción	junta para frigorífico perfil 9156 An 415mm L 775mm medida inserción UE 1 pzs		

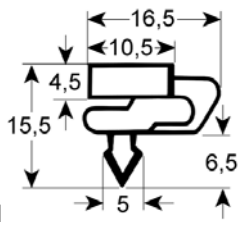

código	901660	referencia	GBC1001-45
descripción	junta para frigorífico perfil 9156 An 420mm L 785mm medida inserción UE 1 pzs		

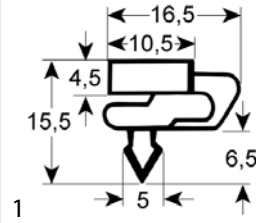

código	901648	referencia	GSC1336-44 GSC2336-44 SLJP2010
descripción	junta para frigorífico perfil 9156 An 595mm L 1340mm medida inserción UE 1 pzs		
Para modelos:	GSC1336, GSC2336		

perfil 9314

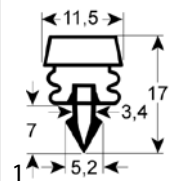

código	902158	referencia	HSC800-53
descripción	junta para frigorífico perfil 9314 Anmm L 1200mm		

perfil 9930

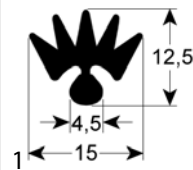

código	901645	referencia	1.1.C.63.69 GCV1600-07
descripción	junta para frigorífico perfil 9930 Anmm L 746mm medida inserción		

otros

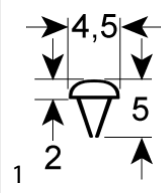

código	902210	referencia	JNMA0000
descripción	junta L 930mm UE 1 medidas 5x6mm		

juntas roscadas

perfil 9135

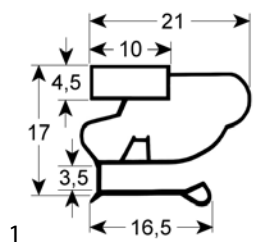

código	901520	referencia	RW40.02
descripción	junta para frigorífico perfil 9135 An 380mm L 520mm medidas exteriores UE 1		
Para modelos:	GHR1040, GHR2600		

perfil 9997

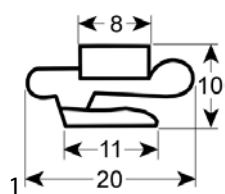

código	902150	referencia	A1.1.C.C21.17
descripción	junta para frigorífico perfil 9997 An 408mm L 720mm medidas exteriores		
Para modelos:	GRV1100		

perfil 9968

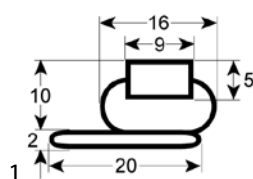

código	901649	referencia	1.1.E.E1.35 GGC1078-19 GGC1078-19-black
descripción	junta para frigorífico perfil 9968 An 418mm L 658mm medidas exteriores con refuerzo de metal UE 1 pzs		

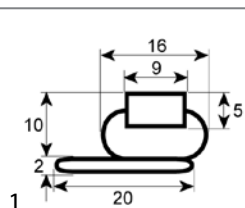

código	901650	referencia	1.1.E.E1.25 GGC2270-23 GGC2270-23 white
descripción	junta para frigorífico perfil 9968 An 515mm L 1390mm medidas exteriores con refuerzo de metal UE 1 pzs		
Para modelos:	GGC1270		

perfil 9910

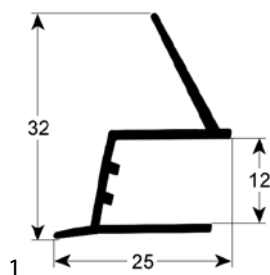

código	901646	referencia	1.1.C.C63.76 GCV1600-24
descripción	junta para frigorífico perfil 9910 Anmm L 735mm UE 1 pos. de montaje derecho		

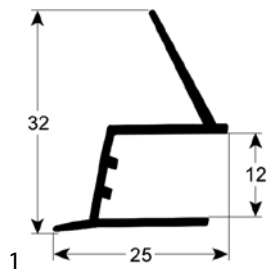

código	901651	referencia	1.1.C.C63.67 GCV1600-23
descripción	junta para frigorífico perfil 9910 Anmm L 735mm UE 1 pos. de montaje izquierdo		

juntas térmicas

juntas para puertas



código	902497	referencia	01000770
descripción	junta de puerta perfil 2764 L 1020mm para TECNOEKA		
Para modelos:	GCO2001		

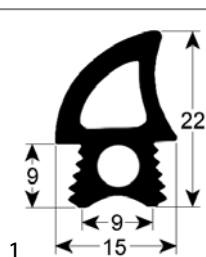

código	902419	referencia	01000810
descripción	junta de puerta perfil 2767 L 1780mm para TECNOEKA		
Para modelos:	GCO2001		

juntas de puerta con gancho de fijación



código	900396	referencia	09988928000
descripción	junta para hornos L 440mm An 370mm medidas exteriores		
Para modelos:	GCO1001		

juntas con refuerzo de alambre

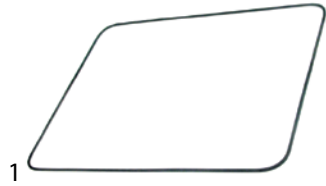

código	693232	referencia	09980928000
descripción	junta para hornos reforzado con hilo metálico L 425mm An 350mm		
Para modelos:	GCO1001		

juntas tóricas

EPDM

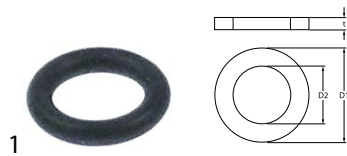

código	532648	referencia	2859
descripción	junta tórica EPDM espesor 1.5mm int.ø 5mm UE 1 pzs		
Para modelos:	GSM1000		

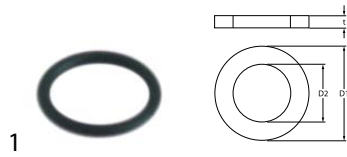

código	529545	referencia	50-0463-9 904324
descripción	junta tórica EPDM espesor 1.78mm int.ø 10.82mm UE 1 pzs		
Para modelos:	GDW1001, GGW1001, GGW2001, GIM1023, GIM1038, GIM2023, GIM2038		



código	532647	referencia	900970
descripción	junta tórica EPDM espesor 1.8mm int.ø 11.8mm UE 1 pzs		
Para modelos:	GJU1001		

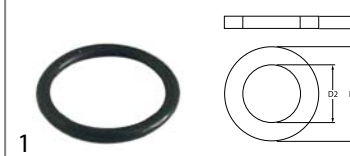

código	504590	referencia	904330
descripción	junta tórica EPDM espesor 2.62mm int.ø 18.72mm UE 1 pzs		
Para modelos:	GGW2001		

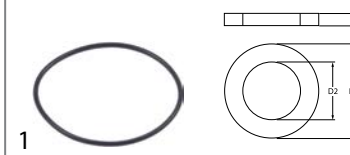

código	532618	referencia	016240424
descripción	junta tórica EPDM espesor 2mm int.ø 48.5mm UE 1 pzs		
Para modelos:	GDF1004, GDF1008, GDF2024, GDF2028		

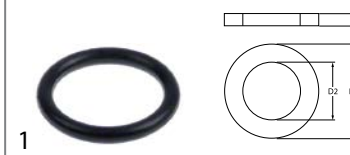

código	511322	referencia	904430
descripción	junta tórica EPDM espesor 3.53mm int.ø 20.22mm UE 1 pzs		
Para modelos:	GDW1001, GGW1001, GGW2001		

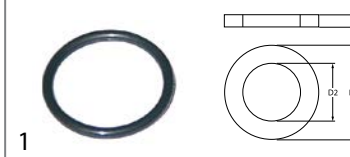

código	510072	referencia	904350
descripción	junta tórica EPDM espesor 3.53mm int.ø 32.93mm UE 1 pzs		
Para modelos:	GGW1001, GGW2001		

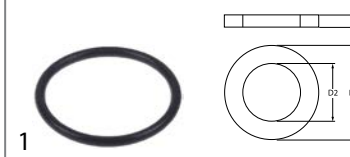

código	519179	referencia	904380
descripción	junta tórica EPDM espesor 3.53mm int.ø 41.28mm UE 1 pzs		
Para modelos:	GGW1001		



código	510955	referencia	00002001
descripción	junta tórica EPDM espesor 3mm int.ø 6mm UE 1 pzs		
Para modelos:	GCO2001		



código	521120	referencia	907981
descripción	junta tórica EPDM espesor 5.34mm int.ø 37.47mm UE 1 pzs		
Para modelos:	GDW1001, GGW1001, GGW2001		

silicona

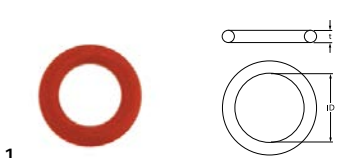

código	371100	referencia	YJS820-4
descripción	junta tórica silicona espesor 1.78mm int.ø 6.07mm UE 1 pzs		

anillos de junta

juntas de goma



código	511649	referencia	903263
descripción	junta plana goma ø ext. 20mm int.ø 12mm espesor 2mm UE 1 pzs		
Para modelos:	GGW1001, GGW2001		



código	511936	referencia	904991
descripción	junta plana goma ø ext. 25mm int.ø 16.5mm espesor 1.8mm UE 1 pzs sistemas de lavado		
Para modelos:	GDW1001		



código	519117	referencia	903301
descripción	junta plana goma ø ext. 60mm int.ø 47mm espesor 3mm UE 1 pzs		
Para modelos:	GGW1001, GGW2001		



código	519121	referencia	903340
descripción	junta plana goma ø ext. 80mm int.ø 67mm espesor 3mm UE 1 pzs para Silanos		
Para modelos:	GGW2001		

juntas de plástico



código	504435	referencia	908146
descripción	junta plana plástico ø ext. 18mm int.ø 9.5mm espesor 2.5mm para bisagra de puerta batiente UE 1 pzs		
Para modelos:	GDW1001		

juntas de papel

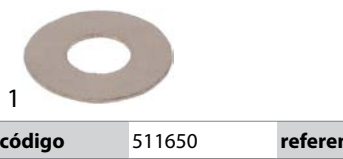

código	511650	referencia	903403
descripción	junta plana papel ø ext. 24mm int.ø 10.5mm espesor 1mm UE 1 pzs sistemas de lavado		
Para modelos:	GGW1001, GGW2001		

juntas de silicona



código	511646	referencia	A0ND011
descripción	junta silicona ø ext. 63mm int.ø 55mm espesor 2.3mm UE 1 pzs para resistencia		
Para modelos:	GCM1006, GCM2009, GCM3016		



código	504296	referencia	A040382
descripción	junta plana silicona ø ext. 29mm int.ø 12mm espesor 1.6mm UE 1 pzs para máquina de café		
Para modelos:	GCM1006, GCM2009, GCM3016		

juntas de árbol

juntas de árbol



código	698383	referencia	0632
descripción	junta de árbol int.ø 4mm ø ext. 12mm para triturador portátil H 6.3mm		
Para modelos:	GSM1000		



1

código	697475	referencia	0000012671
descripción	junta radial int.ø 20mm ø ext. 30mm espesor 5mm		
Para modelos:	GFS1025		

otros



1

código	511953	referencia	900871
descripción	juego de juntas para exprimidor		
Para modelos:	GJU1001		

juntas especiales

para envasadoras al vacío



1

código	699618	referencia	HVS1000-08 YJS820-8
descripción	junta de tapa L 1365mm		

para microondas



1

código	901698	referencia	593219000016 GMW1025-P161
descripción	junta L 330mm An 325mm silicona para placa cerámica UE 1 pzs		



1

código	902161	referencia	P161
descripción	junta L 365mm An 360mm silicona para placa cerámica UE 1 pzs para GMW1030		

otros



1

código	698543	referencia	3,0000403 GDF1108-033 GDF2128-034 HDF1108-037 HDF1108-37 HDF2128-038
descripción	junta altura exterior 4mm ø ext. 25mm int.ø 16mm		
Para modelos:	GDF1108, GDF2128		



1

código	698545	referencia	3,0000404 GDF1108-027 GDF1108-27 GDF2128-028 HDF1108-036 HDF2128-037
descripción	junta ø ext. 31mm int.ø 21mm		
Para modelos:	GDF1108, GDF2128		



1

código	504297	referencia	A0ND036
descripción	junta para tubo nivel de agua ø ext. 13mm int.ø 6mm silicona		
Para modelos:	GCM1006, GCM2009, GCM3016		

juntas de termostato



1

código	512205	referencia	016240433
descripción	junta para sensor de temperatura ø ext. 15mm plástico UE 1 pzs		
Para modelos:	GDF1004, GDF2024		

juntas patra brazos de lavado



1

código	506223	referencia	905257
descripción	junta D1 ø 110mm D2 ø 82mm espesor 3mm con 4 orificios roscados brida		
Para modelos:	GDW1001		



1

código	519445	referencia	908141
descripción	junta D1 ø 80mm D2 ø 50mm espesor 3mm con 4 orificios roscados		
Para modelos:	GDW1001		

componentes para el circuito frigorífico

controladores de agua de refrigeración

JOHNSON CONTROLS



1

código	541839	referencia	82-5272-9
descripción	regulador de agua de refrigeración 3/8" tipo V46SA-9952 empalme 6mm conexión para soldadura margen de presión Mai 23bar pres. máx. agua 18bar temp. máx. agua 90°C capilar 750mm L 101mm 405kg		
Para modelos:	GIM1023, GIM1038, GIM2023, GIM2038		

válvulas

válvulas Schrader

válvulas Schrader completas



1

código	750636	referencia	C01AA06A0003 GDS1600-36 GDS1600-42 GPS1134-36 GPS1134-42 GPS1600-36 GPS1600-42 GSF1600-36 GSF1600-42 S900.36 S900.42
descripción	válvula Schrader completo empalme 1/4"SAE ø 6mm L 120mm		
Para modelos:	GDS1134, GDS1600, GHS1134, GHS1600, GHS2134, GHS2600, GPS1134, GPS1600, GSA1134, GSA1600, GSF1134, GSF1600		

filtros deshidratadores antiácidos

accesorios

soportes



1

código	699297	referencia	GBC1001-10 GBC1002-10 GBC1003-10 SLJAC008
descripción	soporte L 40mm An 30mm H 31mm int.ø 18mm ø ext. 22mm para deshidratador		
Para modelos:	GBC1001, GBC1002, GBC1003, GSC1100G, GSC2336		

otros



1

código	750381	referencia	A1.1.A.A04.01 GBC1001-09 GBC1002-09 GBC1003-09 GSC1336-32 GSC2336-32 TCGV0002
descripción	deshidratador ø 18.5mm L 115.5mm empalme 2,4/5,2mm UE 1 pzs		
Para modelos:	GBC1001, GBC1002, GBC1003, GRV1100, GSC1336, GSC2336		



1

código	750693	referencia	1.1.A.A04.01 GCV1600-40
descripción	deshidratador ø 19mm L 120.5mm empalme 2/5mm UE 1 pzs		



1

código	750378	referencia	C04AC26A0001 RC400.12 RC600.03 RN400.07 RN600.04
descripción	deshidratador ø 19mm L 145mm empalme 4,5/8mm tipo XH9 UE 1 pzs		
Para modelos:	GFR2600, GPS2600, GRE2600, GSA2600, GSD2600, GSF2600, RC400, RN400		

1 

código	750383	referencia	GGC2270-08 GGC2270-8
descripción	deshidratador ø 19mm L 182mm empalme 6,5/6,5mm UE 1 pzs		
Para modelos:	GGC1270		

1 

código	750694	referencia	1.1.A.A04.06 GGC2270-07
descripción	deshidratador ø 25mm L 144mm empalme 6/8mm UE 1 pzs		
Para modelos:	GGC1270		

1 

código	750324	referencia	GPS1600-44 GSF1600-44 S900.44
descripción	deshidratador tamaño 20g ø 23mm L 117mm empalme 4,8/8,3mm		
Para modelos:	GDS1134, GDS1600, GHS1134, GHS1600, GHS2134, GHS2600, GPS1134, GPS1600, GSA1134, GSA1600, GSF1134, GSF1600		

1 

código	750382	referencia	GSC1100-31 TCGV0002 HSC350-10 TCGV0009
descripción	deshidratador ø 18.5mm L 120mm empalme 4/7mm UE 1 pzs		
Para modelos:	GSC1100, GSC1100G		
accesorios para	750382		
	código	694868	referencia —
	soporte para deshidratador L 40mm An 30mm H 31mm UE 1 pzs		

1 

código	750311	referencia	0145040
descripción	deshidratador tamaño 20g ø 19mm L 149mm empalme 3,2/6,2mm		
Para modelos:	GFR1600		

1 

código	750310	referencia	0145015
descripción	deshidratador tamaño 20g ø 19mm L 150mm empalme 3,2/5/6,2mm		
Para modelos:	GRE1600		

tubos para refrigeración

tubos de cobre sin aislar

1 

código	694931	referencia	GPS1600-43 GSF1600-43 S900.43 VRX.15
descripción	capilar int.ø 0.8mm ø ext. 2mm L 2340m		
Para modelos:	GDS1134, GDS1600, GHS1134, GHS1600, GHS2134, GHS2600, GPS1134, GPS1600, GSA1134, GSA1600, GSF1134, GSF1600		

1 

código	692407	referencia	1.1.B.B06.21 GGC2270-57
descripción	tubo de cobre cobre int.ø 3.8mm ø ext. 4.8mm L 0.1m UE 1 pzs		
Para modelos:	GGC1270		

1 

código	692667	referencia	A1.1.B..B02.07
descripción	tubo de cobre int.ø 5mm ø ext. 6mm L 0.23m UE 1		
Para modelos:	GRV1100		

1 

código	692418	referencia	1.1.B.B06.26 GGC2270-56
descripción	tubo para refrigeración cobre int.ø 5mm ø ext. 6mm L 1m UE 1		
Para modelos:	GGC1270		



1 

código	692699	referencia	A1.1.B..B02.04
descripción	tubo para refrigeración int.ø 3.5mm ø ext. 5mm L 0.1m		
Para modelos:	GRV1100		

tubos de cobre aislados

1 

código	699322	referencia	GPS1600-39 GSF1600-39 S900.39
descripción	tubo para refrigeración diámetro ø 6 espesor de aislamiento 8mm L 525mm		
Para modelos:	GDS1134, GDS1600, GPS1134, GPS1600, GSA1134, GSA1600, GSF1134, GSF1600		

aislamientos

1 

código	694930	referencia	RC600.10
descripción	tubo flexible aislante grosor de la pared 8mm modelo 3/8"x5/8" refrigeración int.ø 20mm		
Para modelos:	GRE2600		

tubos calentadoras

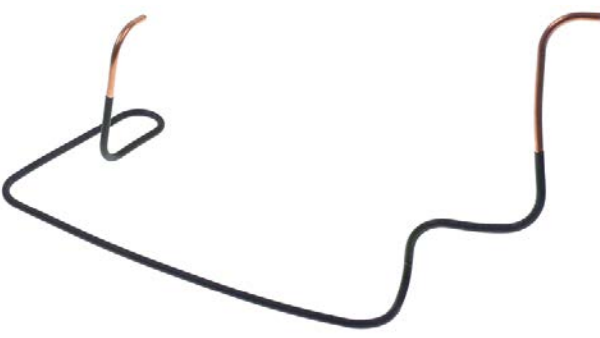
1 

código	699421	referencia	GCV1600-49
descripción	calentador ø ext. 5mm int.ø 3.3mm L 320mm cobre UE 1m		

1 

código	701583	referencia	C04AC26A0002
descripción	calentador ø ext. 6mm int.ø 3mm L 260mm cobre		
Para modelos:	GPS2600, GSA2600, GSD2600, GSF2600		

1 

código	701584	referencia	RC600.07 RC600.15
descripción	calentador ø ext. 6mm int.ø 5mm L 330mm cobre		
Para modelos:	GRE2600		

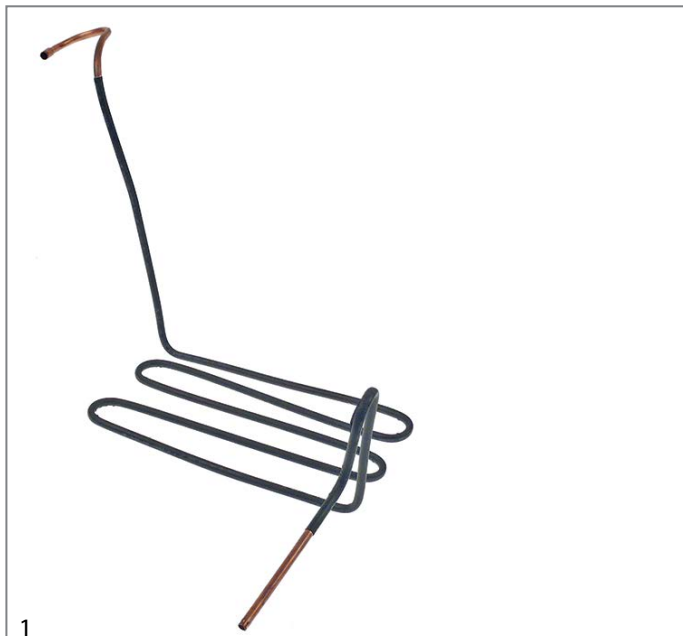

código	701495	referencia	TCGD4010
descripción	calentador ø ext. 6mm int.ø 5mm UE 1m para evaporador ø empalme 6mm		
Para modelos:	GSC1100G		



código	699400	referencia	RC400.10
descripción	calentador pos. de montaje abajo ø 6mm L 300mm An 155mm H 170mm		
Para modelos:	RC400		

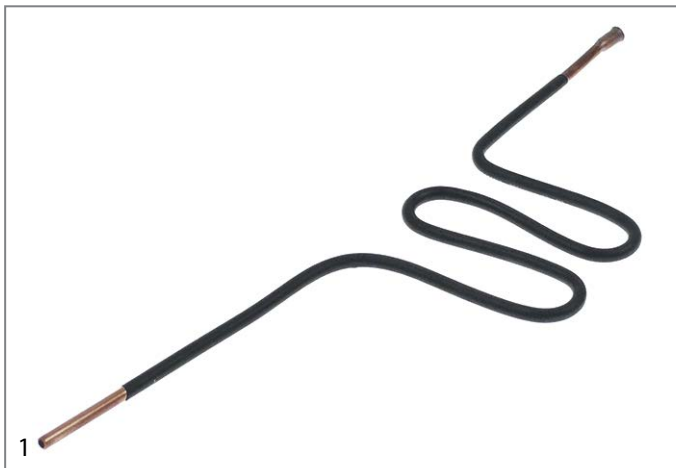

código	701432	referencia	TCGD2012
descripción	calentador tubo ø ext. 5mm int.ø 3mm L 350mm cobre UE 1		

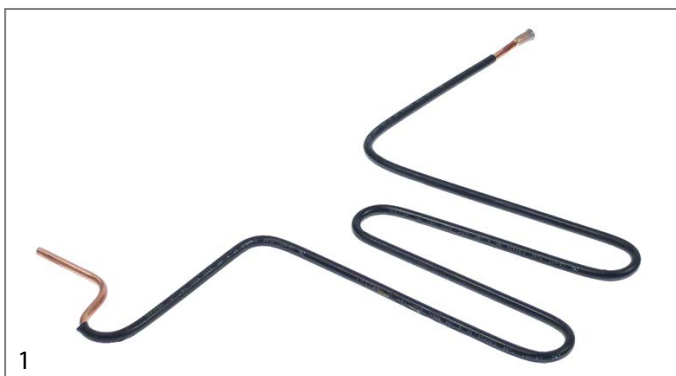

código	701582	referencia	GBC1001-13 GBC1002-11 GBC1003-11 TCGD2001
descripción	calentador tubo ø ext. 5mm int.ø 3mm L 355mm H 250mm		
Para modelos:	GBC1001		

evaporadores

para frigoríficos

específico del fabricante



código	750342	referencia	0130010
descripción	evaporador L 1580mm An 660mm apto para AB500P		
Para modelos:	GRE1600		



1

código	750352	referencia	1.1.A.A10.27 GGC1078-43
descripción	evaporador L 250mm An 50mm H 117mm		



1

código	750629	referencia	GPC1088-02
descripción	evaporador L 320mm An 320mm H 5mm		
Para modelos:	GPC1088		



1

código	750350	referencia	1.1.A.A10.40 GGC2270-15
descripción	evaporador L 345mm An 100mm H 215mm longitud total 345mm anchura total 100mm altura total 240mm para frigorífico		
Para modelos:	GGC1270		



1

código	750345	referencia	GSC1336-16 GSC2336-16
descripción	evaporador L 520mm An 180mm H 160mm		
Para modelos:	GSC1336		



1

código	750371	referencia	1.1.A.A10.23 GCV1600-09
descripción	evaporador L 545mm An 50mm H 110mm longitud total 600mm anchura total 50mm altura total 123mm		



1

código	750728	referencia	GSC1100G-39
descripción	evaporador L 610mm An 120mm H 215mm		



1

código	750660	referencia	HSC800-42 TLZA4003
descripción	evaporador L 620mm An 225mm H 160mm		



1

código	750375	referencia	GSC1100-19 TLZA4004
descripción	evaporador L 760mm An 140mm H 225mm		
Para modelos:	GSC1100		



1

código	750367	referencia	GFR2600-31 RN600.31
descripción	evaporador para congelador horizontal GFR2600 L 600mm An 450mm H 1200mm		
Para modelos:	GFR2600		



1

código	750387	referencia	GBC1001-39 TLZA9000
descripción	evaporador para frigorífico GBC1001 L 430mm An 500mm		
Para modelos:	GBC1001		



1

código	750376	referencia	GBC1002-41 TLZD9001
descripción	evaporador para frigorífico GBC1002 L 760mm An 500mm		
Para modelos:	GBC1002		



1

código	750456	referencia	HSC360-21
descripción	evaporador para frigorífico HSC360 L 780mm An 495mm		



1

código	750361	referencia	RC600.04
descripción	evaporador para frigorífico L 1000mm An 471mm		
Para modelos:	GRE2600		



1

código	750377	referencia	GBC1003-41 TLZD9002
descripción	evaporador para frigorífico L 1000mm An 500mm		
Para modelos:	GBC1003		

para vitrinas frías



1

código	750690	referencia	RN400.02
descripción	evaporador An 430mm P 415mm H 1210mm		
Para modelos:	RN400		



1

código	750646	referencia	A1.1.A.A09.03
descripción	evaporador L 280mm An 82mm H 116mm longitud total 330mm anchura total 120mm		
Para modelos:	GRV1100		

accesorios

otros



1

código	692425	referencia	GSC1336-28 GSC2336-28
descripción	casquillo para evaporador plástico ø 24mm L 34mm UE 1 pzs		
Para modelos:	GSC1336		



1

código	699408	referencia	RC400.24
descripción	clip para evaporador ø 31.5mm		
Para modelos:	RC400		



1

código	701268	referencia	RN400.23 RN600.32
descripción	perfil U para evaporador L 635mm An 16mm H 13mm aluminio UE 1 pzs		
Para modelos:	GFR2600, RN400		

condensadores

filtros

1



código	699402	referencia	P04AC28A0002
descripción	filtro para condensador L 218mm An 230mm espesor 6mm UE 1 pzs		
Para modelos:	GPS2600, GSA2600, GSD2600, GSF2600		

1



código	694587	referencia	GPS1600-04 GSF1600-04 S900.04
descripción	filtro de aire para condensador L 218mm An 194mm espesor 6mm UE 1 pzs		
Para modelos:	GDS1134, GDS1600, GPS1134, GPS1600, GSA1134, GSA1600, GSF1134, GSF1600		

condensadores

1



código	750373	referencia	DTLA9002 GBC1002-06 HBC2003-06
descripción	condensador An 190mm P 160mm H 205mm UE 1 pzs		
Para modelos:	GBC1003		

1



código	750372	referencia	DTLA9000 GBC1001-06
descripción	condensador An 195mm P 80mm H 205mm UE 1 pzs		
Para modelos:	GBC1001		



1

código	750347	referencia	C04AC28A0001 GPS1600-35 GSF1600-35 S900.35
descripción	condensador An 220mm P 100mm H 230mm L 270mm		
Para modelos:	GDS1134, GDS1600, GPS1134, GPS1600, GPS2600, GSA1134, GSA1600, GSA2600, GSD2600, GSF1134, GSF1600, GSF2600		



1

código	750385	referencia	GBC1003-06
descripción	condensador An 255mm P 180mm H 205mm UE 1 pzs		



1

código	750384	referencia	1.1.A.A09.01 GGC1078-07 GGC1078-7
descripción	condensador An 220mm P 60mm H 280mm UE 1 pzs		

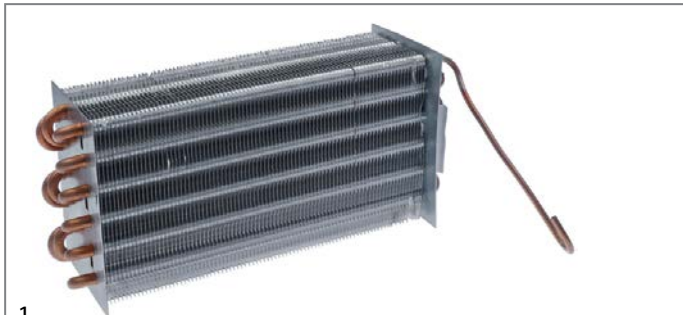

1

código	750370	referencia	1.1.A.A09.21 GCV1600-30
descripción	condensador An 265mm P 93mm H 140mm UE 1 pzs		



1

código	750351	referencia	1.1.A.A09.09 GGC2270-11
descripción	condensador An 255mm P 130mm H 235mm		
Para modelos:	GGC1270		



1

código	750659	referencia	HSC800-06
descripción	condensador An 290mm P 180mm H 215mm UE 1 pzs		



1

código	750729	referencia	GSC1100G-17
descripción	condensador An 395mm P 235mm H 275mm		

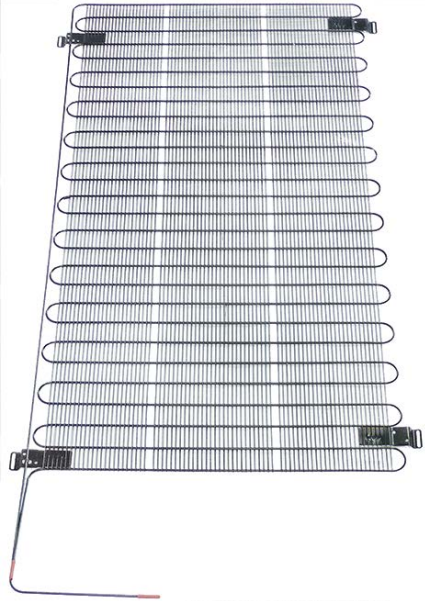

1

código	750703	referencia	44918000
descripción	condensador An 790mm P 10mm H 1360mm		
Para modelos:	GFR3600		

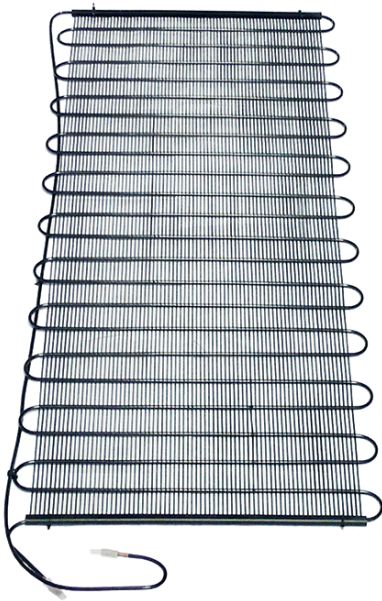

1

código	750689	referencia	RC400.03 RN400.03
descripción	condensador An 550mm P 7mm H 1170mm UE 1 pzs		
Para modelos:	RC400, RN400		

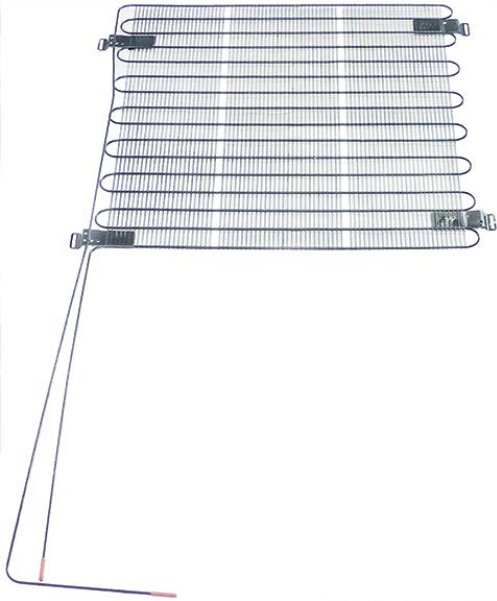

1

código	750699	referencia	45034000
descripción	condensador An 790mm P 10mm H 750mm UE 1 pzs		
Para modelos:	GRE3600		



1

código	750374	referencia	DTLA4008 GSC1100-29
descripción	condensador An 555mm P 100mm H 275mm UE 1 pzs		
Para modelos:	GSC1100		

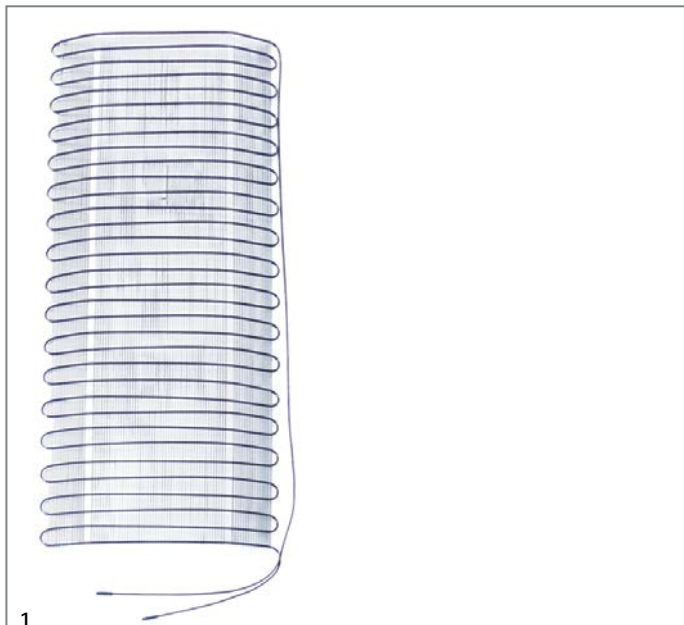

1

código	750346	referencia	DTLB2004 GSC1336-27 GSC2336-27 HSC360-02
descripción	condensador L 1430mm An 520mm		
Para modelos:	GSC1336		

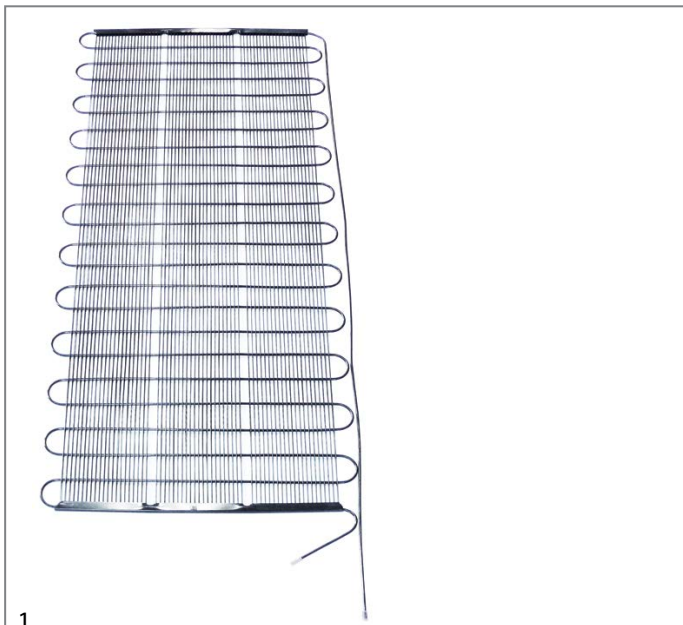

1

código	750360	referencia	RC600.05
descripción	condensador para frigorífico An 500mm H 1170mm UE 1 pzs		
Para modelos:	GRE2600		

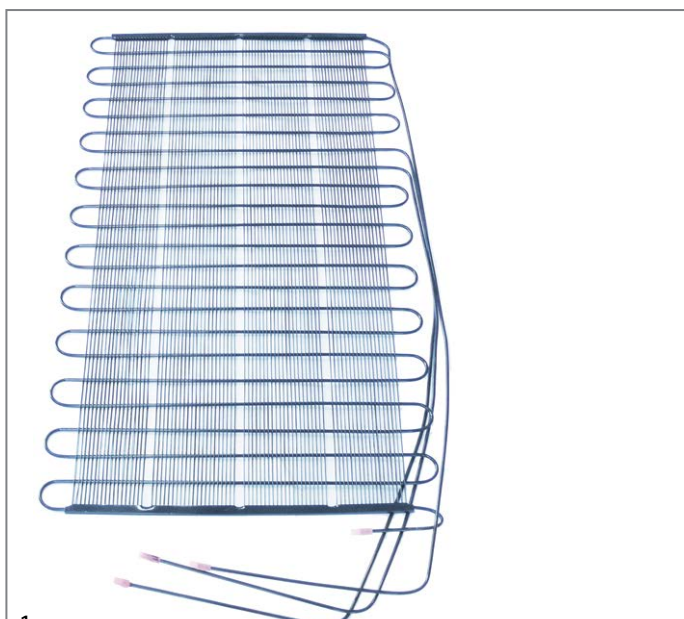

1

código	750379	referencia	RN600.03
descripción	condensador para congelador horizontal An 640mm H 1165mm UE 1 pzs		
Para modelos:	GFR2600		



1

código	750319	referencia	VRX.11
descripción	condensador para mesa pizza An 228mm P 77mm H 179mm		
Para modelos:	GHS1134, GHS1600, GHS2134, GHS2600		





1

código	750647	referencia	A1.1.A06.03
descripción	condensador para vitrina An 160mm P 312mm H 110mm UE 1 pzs		
Para modelos:	GRV1100		



1

código	699211	referencia	I0425088
descripción	bandeja de agua condensada L 230mm An 144mm H 45mm		
Para modelos:	GRE3600		



1

código	750380	referencia	RC400.11 RC600.06
descripción	bandeja de agua condensada sin calentamiento L 205mm An 155mm H 78mm para congelador horizontal UE 1 pzs		
Para modelos:	GRE2600, RC400		

bandejas de agua condensada y cubetas de evaporación

bandejas de agua condensada



1

código	699308	referencia	GBC1002-14 GBC1003-14
descripción	bandeja de agua condensada L 120mm An 74mm H 58mm UE 1 pzs		



1

código	699302	referencia	SLZJ0021
descripción	bandeja de agua condensada L 185mm An 130mm H 75mm		
Para modelos:	GBC1001		



1

código	699299	referencia	GSC1336-47 SLZJ0014
descripción	bandeja de agua condensada L 210mm An 105mm H 80mm		
Para modelos:	GSC1336, GSC2336		

cubetas de evaporación sin resistencia



1

código	750632	referencia	SLZJ0022
descripción	bandeja de goteo L 187mm An 128mm H 70mm plástico		
Para modelos:	GBC1002, GBC1003		



1

código	750631	referencia	GSC1100-27 SLZJ0015
descripción	bandeja de goteo L 302mm An 204mm H 85mm plástico		
Para modelos:	GSC1100, GSC1100G		



1

código	699418	referencia	1.1.C.C29.02 GGC2270-04
descripción	bandeja de goteo L 400mm An 144mm H 50mm plástico		
Para modelos:	GGC1270		



1

código	750630	referencia	GPC1088-08
descripción	cubeta de evaporación L 200mm An 135mm H 30mm plástico		
Para modelos:	GPC1088		

técnica de accionamiento y rodamientos de bolas

rodamientos de bolas

cojinetes a bolas 2RS



código	523501	referencia	00000000637
descripción	rodamiento de bolas radial tipo 608-2RS árbol \varnothing 8mm \varnothing ext. 22mm An 7mm con arandelas de junta cojinete ranurado DIN 625-1		
Para modelos:	GFS1030		



código	523510	referencia	00000000860
descripción	rodamiento de bolas radial tipo 6202-2RS árbol \varnothing 15mm \varnothing ext. 35mm An 11mm con arandelas de junta cojinete ranurado DIN 625-1		
Para modelos:	GFS1025, GFS2022, GFS2025, HFS2019, HFS2022, HFS2025		



código	523512	referencia	00000000632
descripción	rodamiento de bolas radial tipo 6204-2RS árbol \varnothing 20mm \varnothing ext. 47mm An 14mm con arandelas de junta cojinete ranurado DIN 625-1		
Para modelos:	GFS1030		



código	523504	referencia	00000000862
descripción	rodamiento de bolas radial tipo 626-2RS árbol \varnothing 6mm \varnothing ext. 19mm An 6mm con arandelas de junta cojinete ranurado DIN 625-1		
Para modelos:	GFS1025, GFS2022, GFS2025, HFS2019, HFS2022, HFS2025		

correas de accionamiento

correas trapezoidales nervadas

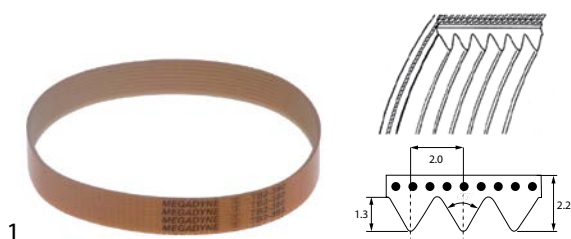

código	698215	referencia	00000000635
descripción	correa trapezoidal nervada número de nervios 10 An 20mm L 400mm perfil TB2		
Para modelos:	GFS1030		

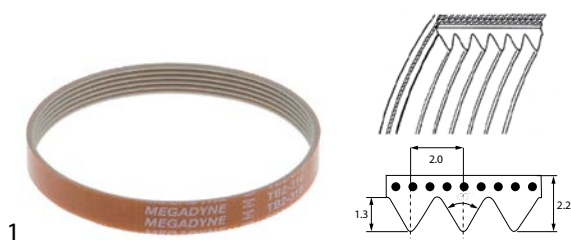

código	698963	referencia	00000000492
descripción	correa trapezoidal nervada número de nervios 5 An 10mm L 310mm perfil TB2		
Para modelos:	GFS2022, HFS2022		

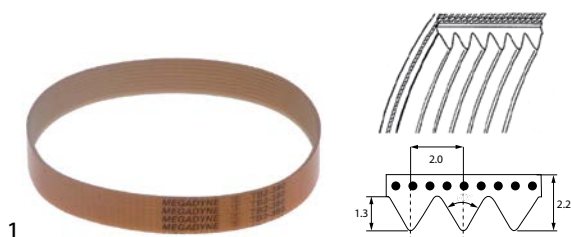

código	698217	referencia	00000000861
descripción	correa trapezoidal nervada número de nervios 7 An 14mm L 330mm perfil TB2		
Para modelos:	GFS1025, GFS2025, HFS2025		

muelles

muelles de torsión

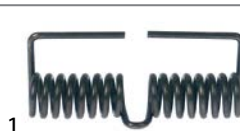

código	700569	referencia	901908
descripción	resorte de torsión \varnothing 21.5mm L2 40mm espesor de hilo 3.3mm L1 100mm L3 45mm		
Para modelos:	GPG1001, GPG2001		



resortes de gas

resortes de gas



1

código	701554	referencia	HVS1000-46 YJS820-46
descripción	resorte de gas derecho 80N D1 ø 6mm D2 ø 15mm L 162mm HVS1000		



1

código	701553	referencia	HVS1000-21 YJS820-21
descripción	resorte de gas izquierdo 80N D1 ø 6mm D2 ø 15mm L 162mm HVS1000		

resortes de tracción



1

código	519443	referencia	908042
descripción	muelle de tracción ø 11.5mm longitud total 220mm espesor de hilo 2mm		
Para modelos:	GDW1001		



1

código	701249	referencia	GMW1030-P118
descripción	muelle de tracción ø 7.3mm longitud total 25.5mm espesor de hilo 1mm para cierre de puerta UE 1 pzs		
Para modelos:	GMW1030		

accesorios de cocina

gastro-norm

piezas de unión



1

código	692377	referencia	S900.20
descripción	distanciador para recipiente gastronorm L1 180mm L2 200mm inox An 38mm H 12.5mm UE 1 pzs espesor 0.6mm		
Para modelos:	GSA1134, GSA1600		



1

código	692378	referencia	S900.21
descripción	distanciador para recipiente gastronorm L1 325mm L2 295mm inox An 23mm H 14mm UE 1 pzs espesor 0.9mm		
Para modelos:	GSA1134, GSA1600		



1

código	692262	referencia	S900.22
descripción	distanciador para recipiente gastronorm L1 530mm L2 550mm inox An 23mm H 14mm UE 1 pzs espesor 0.7mm		
Para modelos:	GSA1134, GSA1600		

manómetros



1

código	542340	referencia	HVS1000-35 YJS820-35
descripción	manómetro ø 41mm margen de presión 0-1bar empalme 5mm		

dosificadores

bombas de membrana

autoaspirantes con presión secundaria

GERMAC

tipo 2001



1

código	361545	referencia	902013	
descripción	dosificador tipo 2001 abrillantador entrada 4x6mm salida M10x1 conector para succión ø 4x6mm presión secundaria 11mm bola de retención PTFE 1mm GERMAC CODE VNR/U3			
Para modelos:	GDW1001, GGW1001, GGW2001			
repuestos para	361545			
	código	361551	referencia	—
	descripción	resorte de compresión espesor de hilo 1mm		
	código	361700	referencia	—
	descripción	empalme de tubo giratorio tubo ø 4x6mm plástico empalme M10x1		
	código	361702	referencia	—
	descripción	empalme de tubo latón tubo ø 4x6mm		
	código	361705	referencia	—
	descripción	junta para empalme de tubo M12x1		
	código	510298	referencia	—
	descripción	válvula labial dosificador apto para DB2/DS5		

Continúa en la página siguiente

accesorios para	361545			
	código	361142	referencia	—
	kit de montaje	detergente tipo de tubo 4x6mm longitud de tubo 2m PVC 2x tubo flexible/filtro recipiente/caño de pared transparente		
	código	361550	referencia	—
	empalme de tubo	tubo ø 4x6mm		
	código	361553	referencia	—
	membrana	EPDM		
	código	361701	referencia	—
	empalme de tubo	rosca M10x1 boquilla ø 7.5mm		
	código	361703	referencia	—
	empalme de tubo	rosca M10x1 latón empalme de tubo ø 4x6mmmm		
	código	361704	referencia	—
	empalme de tubo	latón recto rosca M12x1 tubo ø 11mm UE 1 pzs		
	código	510296	referencia	—
	membrana	silicona		
	código	520090	referencia	—
	tubo flexible de PVC	int.ø 4mm ø ext. 6mm L 2m grosor de la pared 1mm T máx 60°C transparente		
	código	520091	referencia	—
	tubo de nylon	int.ø 4mm ø ext. 6mm L 2m grosor de la pared 1mm p de trabajo 10bar p de reventamiento 50bar T máx 100°C transparente		

accesorios para	520010			
	código	520054	referencia	—
	junta plana	goma ø ext. 23.5mm int.ø 14mm espesor 2.3mm UE 10 pzs		

tubos de salida

	1			
código	530571	referencia	907440	
descripción	manguera de desagüe DN24 L 1500mm ø int. recta 24mm ø ext. recto 29mm dim.ext. codo 29mm ø ext. codo 35mm tubo ø ext. 28mm			
Para modelos:	GGW2001			

	1			
código	519456	referencia	907439	
descripción	manguera de desagüe L 1500mm D1 ø 21mm D2 ø 21mm			
Para modelos:	GDW1001, GGW1001			

accesorios

diversos

	1			
código	513329	referencia	906375	
descripción	soporte para dosificadoras L 70mm H 25mm An 40mm acero para muelle			
Para modelos:	GDW1001, GGW1001			

tubos flexibles

tubos flexibles de entrada

tubos flexibles de entrada de PVC

	1			
código	520010	referencia	907344	
descripción	tubo flexible de entrada PVC recto-curvado DN13 empalmes 3/4" L 1500mm p de trabajo 10bar p de reventamiento 32bar T máx 90°C azul homologación VDE cierre plana			
Para modelos:	GDW1001, GGW1001, GGW2001			
accesorios para	520010			
	código	520053	referencia	—
	filtro empalme 3/4"	D1 ø 26mm D2 ø 15mm UE 10 pzs goma espesor 8mm		

tubos flexibles industriales

tubos flexibles de PVC

tubos de PVC sin tejido

	1			
código	699440	referencia	A1.1.K.K04.08	
descripción	tubo flexible int.ø 10mm ø ext. 13mm L 196m			
Para modelos:	GRV1100			

	1			
código	699439	referencia	A1.1.E.E06.03	
descripción	tubo flexible int.ø 8mm ø ext. 10mm L 0.36m			
Para modelos:	GRV1100			



			
1			
código	570027	referencia	902046
descripción	tubo flexible de PVC int.ø 4mm ø ext. 7mm L 100m grosor de la pared 1.5mm T máx 60°C transparente		
Para modelos:	GDW1001, GGW1001, GGW2001		

			
1			
código	520637	referencia	RW40.34
descripción	tubo flexible de PVC int.ø 6mm ø ext. 9mm L 0.4m grosor de la pared 1.5mm T máx 60°C transparente		
Para modelos:	GHR1040, GHR2600		

tubos de silicona

sin tejido

			
1			
código	530410	referencia	907279
descripción	tubo de silicona int.ø 4mm ø ext. 7mm L 2m grosor de la pared 1.5mm T máx 200°C transparente		
Para modelos:	GDW1001, GGW1001, GGW2001		

tubos formados

recto

			
1			
código	519392	referencia	903756
descripción	tubo formado L 61mm lavavajillas recto ø tubo 50mm int. ø tubo 38mm		
Para modelos:	GDW1001		

forma L

			
1			
código	519132	referencia	903674
descripción	tubo formado sistemas de lavado L-Form núm. Ref. 903674		
Para modelos:	GGW1001, GGW2001		

			
1			
código	519563	referencia	908136
descripción	tubo formado terminal ø ext. 56mm altura interior 45mm ø DE2 56mm medida interior 44mm L 160mm UE 1 L-Form		
Para modelos:	GDW1001		

forma S

			
1			
código	519131	referencia	903668
descripción	tubo formado forma S sistemas de lavado núm. Ref. 903668		
Para modelos:	GGW1001, GGW2001		

otros

			
1			
código	699420	referencia	GGC1078-47
descripción	tubo formado int.ø 19mm ø ext. 24mm L 150mm		

para lavavajillas

otros

			
1			
código	530432	referencia	907360
descripción	tubo de presión ø ext. 17mm int.ø 10mm L 1000mm p de trabajo 10bar p de reventamiento 25bar resis.a la temp. 110°C		
Para modelos:	GGW1001, GGW2001		



código	519448	referencia	907295
descripción	tubo flexible D1 ø 12mm D2 ø 19.5mm		
Para modelos:	GDW1001, GGW1001, GGW2001		

guarniciones, empalmes para mangueras y tubos

empalmes de tubos

sin racor



código	519644	referencia	905434
descripción	pieza T plástico empalme ø12mm - ø5mm - ø12mm		
Para modelos:	GDW1001, GGW1001, GGW2001		



código	519216	referencia	905382
descripción	pieza T plástico tubo ø 12-12-12mm 3 vías		
Para modelos:	GDW1001, GGW1001, GGW2001		



código	699612	referencia	HVS1000-15 YJS820-15
descripción	pieza T plástico tubo ø 5-5-5mm		



código	504817	referencia	HVS1000-29 YJS820-29
descripción	pieza T inox tubo ø 10-10-10mm		



código	504823	referencia	HVS1000-28 YJS820-28
descripción	empalme en cruz inox tubo ø 10-10-10-10mm L 57mm An 57mm		

empalmes de tubo

latón niquelado



código	519239	referencia	905452
descripción	empalme de tubo latón niquelado rosca 1/4" tubo ø 11mm UE 1 pzs		
Para modelos:	GGW1001, GGW2001		

específico del fabricante



código	699615	referencia	HVS1000-11 YJS820-11
descripción	empalme de tubo para tubo DI 10mm empalme 1/4"mm L-Form		

material auxiliar

abrazaderas

abrazaderas de tubo

DIN 3017 - W2



código	520115	referencia	902460
descripción	abrazadera de tubo ø 25-40mm ancho 9mm UE 10 pzs DIN 3017		
Para modelos:	GDW1001, GGW1001, GGW2001		



1

código	520116	referencia	902441
descripción	abrazadera de tubo ø 32-50mm ancho 9mm UE 5 pzs DIN 3017		
Para modelos:	GDW1001, GGW1001, GGW2001		

DIN 3017 - W4



1

código	520120	referencia	902440
descripción	abrazadera de tubo inox W4 ø 12-20mm ancho 9mm UE 1 pzs DIN 3017		
Para modelos:	GDW1001, GGW1001, GGW2001		



1

código	520121	referencia	902450
descripción	abrazadera de tubo inox W4 ø 16-27mm ancho 9mm UE 1 pzs DIN 3017		
Para modelos:	GGW2001		

sistemas de medición

termómetros

termómetros incorporados



1

código	541080	referencia	3303276
descripción	termómetro medida de montaje 58x25,5mm -40 a +40°C capilar 2500mm sonda ø 6mm sonda L 30mm		
Para modelos:	GFR1600, GRE1600		

alimentación eléctrica externa



1

código	378274 ¹	referencia	0406046
descripción	termómetro ARThERMO tipo ROF-DIG/230 medida de montaje 58x25,5mm dimensiones frontales 64x31mm 230V tensión AC -30 a +110°C bulbo ø6x40mm longitud del cable 2500mm display 3 dígitos		
Para modelos:	GFR1600, GRE1600		

¹con 1x sensor NTC

material de sujeción

tornillos

tornillos de cabeza plana



1

código	560281	referencia	GHR1040-05 RW40.11
descripción	tornillo de cabeza plana rosca M5 rosca L 16mm inox DIN 7985/ISO 7045 UE 1 pzs soporte Phillips ø cabezal 10mm espesor cabezal 2mm		
Para modelos:	GHR1040, GHR2600		

tuercas hexagonales



1

código	560309	referencia	907846
descripción	tornillo de cabeza hexagonal rosca M10 rosca L 16mm inox EC 17 UE 1 pzs DIN 933 / ISO 4017		
Para modelos:	GGW1001, GGW2001		



1

código	560464	referencia	907820
descripción	tornillo de cabeza hexagonal rosca M8 rosca L 12mm inox EC 13 UE 1 pzs espesor cabezal 5mm DIN 933 / ISO 4017		
Para modelos:	GDW1001, GGW1001, GGW2001		



			
1			
código	699616	referencia	HVS1000-23 YJS820-23
descripción	tornillo rosca M10 rosca L 26mm EC 17 UE 2 pzs espesor cabezal 7mm L 60mm		

tornillos planos

			
1			
código	560551	referencia	00000000615
descripción	tornillo plano rosca M10 L 15mm Inox UE 1 pzs soporte ranura ø cabezal 24.5mm		
Para modelos:	GFS1030		

tornillos de cabeza moleteada

			
1			
código	697481	referencia	00000000623
descripción	tornillo de cabeza moleteada rosca M6 rosca L 8mm ø 14mm H 6mm inox		
Para modelos:	GFS1030, GFS2022, GFS2025, HFS2019, HFS2022, HFS2025		

tuercas

tuercas hexagonales

DIN 934 / ISO 4032/8673

			
1			
código	560197	referencia	902025 HVS1000-20 YJS820-20
descripción	tuerca rosca M10 H 8mm EC 17 inox DIN/ISO DIN 934 / ISO 4032/8673 UE 1 pzs		
Para modelos:	GGW1001, GGW2001		

			
1			
código	506166	referencia	HVS1000-16 YJS820-16
descripción	tuerca rosca M12 H 10mm EC 19 inox DIN/ISO DIN 934 / ISO 4032/8673 UE 1 pzs		



			
1			
código	505200	referencia	902037
descripción	tuerca rosca M12x1,75 H 10mm EC 19 inox DIN/ISO DIN 934 / ISO 4032/8673 UE 1 pzs		
Para modelos:	GGW1001, GGW2001		

			
imagen no disponible			
1			
código	519051	referencia	902030
descripción	tuerca rosca M4 H 3.2mm EC 7 inox DIN/ISO DIN 934 / ISO 4032/8673 UE 20 pzs		
Para modelos:	GGW2001		

tuercas hexagonales métricas (sin norma)

			
1			
código	692742	referencia	GDS1600-14 GPS1600-14 GSF1134-14 GSF1600-14 S900.14
descripción	tuerca para tubo de desagüe rosca M20 H 18mm EC 26 plástico		
Para modelos:	GDS1134, GDS1600, GPS1134, GPS1600, GSA1134, GSA1600, GSF1134, GSF1600		

			
1			
código	519050	referencia	902023
descripción	tuerca rosca M12x1,75 H 4mm EC 16 inox UE 1 pzs para cierre de enganche		
Para modelos:	GDW1001, GGW1001, GGW2001		

tuercas hexagonales pulgadas

			
1			
código	506024	referencia	902104
descripción	tuerca rosca 3/8" H 6mm inox EC 22 UE 1 pzs		
Para modelos:	GDW1001		



arandelas

arandelas elásticas



1

código	697478	referencia	00000000671
descripción	arandela de muelle int.ø 19mm ø ext. 26mm UE 1 pzs		
Para modelos:	GFS1030		

arandelas

DIN 125A



1

código	560312	referencia	906055
descripción	arandela int.ø 10.5mm ø ext. 20mm espesor 2mm inox UE 1 pzs DIN 125A para rosca M10		
Para modelos:	GGW1001, GGW2001		

otros



1

código	560593	referencia	HVS1000-22 YJS820-22
descripción	arandela int.ø 10.5mm ø ext. 15.8mm espesor 1mm inox UE 4 pzs		



1

código	560486	referencia	0521000
descripción	arandela int.ø 14.1mm ø ext. 22mm espesor 2mm plástico UE 1 pzs		
Para modelos:	GFR1600, GRE1600		



1

código	519238	referencia	906002
descripción	arandela int.ø 15mm ø ext. 33mm espesor 0.8mm inox UE 1 pzs		
Para modelos:	GGW2001		

sujeciones

clips de fijación



1

código	692865	referencia	00007750
descripción	clip de sujeción para portalámparas L 16mm H 19mm		
Para modelos:	GCO2001		

abrazaderas

abrazaderas de tubo

DIN 3017 - W2



1

código	520115	referencia	902460
descripción	abrazadera de tubo ø 25-40mm ancho 9mm UE 10 pzs DIN 3017		
Para modelos:	GDW1001, GGW1001, GGW2001		



1

código	520116	referencia	902441
descripción	abrazadera de tubo ø 32-50mm ancho 9mm UE 5 pzs DIN 3017		
Para modelos:	GDW1001, GGW1001, GGW2001		

DIN 3017 - W4



1

código	520120	referencia	902440
descripción	abrazadera de tubo inox W4 ø 12-20mm ancho 9mm UE 1 pzs DIN 3017		
Para modelos:	GDW1001, GGW1001, GGW2001		

			
1			
código	520121	referencia	902450
descripción	abrazadera de tubo inox W4 ø 16-27mm ancho 9mm UE 1 pzs DIN 3017		
Para modelos:	GGW2001		

pasadores elásticos			
			
1			
código	691637	referencia	0744
descripción	pasador elástico ø 3mm L 20mm		
Para modelos:	GSM1000		

			
1			
código	692236	referencia	902240
descripción	pasador elástico ø 4mm L 40mm		
Para modelos:	GPG1001, GPG2001		

consumibles

fusibles

fusibles finos

ø6,3x32mm 250V

			
1			
código	358133	referencia	GIC3035-B06 GIC3500-A06 GIC3535-D06 GIC4035-C06
descripción	fusible fino medida ø6,3x32mm 16A retardado nominal 250V UE 1 pzs		
Para modelos:	GIC3500, GIC3535, GIC4035		

			
1			
código	358132	referencia	GIC3035-06 GIC3500-06 GIC3535-06 GIC4035-06
descripción	fusible fino medida ø6,3x32mm 16A retardado nominal 250V UE 20 pzs		

A		F	
abrazaderas	146, 149	filtros	53
abrazaderas de tubo	146, 149	filtros deshidratadores antiácidos	131
accesorios eléctricos	54	fusibles	53, 150
aislamientos	133	fusibles finos	150
anillos de junta	129	G	
arandelas	149	gastro-norm	143
arandelas elásticas	149	I	
B		interruptores de sistema ROLD	16
balastros	21	interruptores magnéticos	17
bisagras de resorte	107	interruptores posicionales	16
bisagras para hornos	108	interruptores pulsantes y pulsadores	14
bobinas de inducción	3	interruptores y pulsadores	13
bombas	50	interruptores/pulsadores basculantes	13
bombas de aumento de presión II	51	J	
bombas de lavado y aclarado	50	juntas con refuerzo de alambre	128
bombas de salida	51	juntas de árbol	129
bombas de vacío	52	juntas de puerta con gancho de fijación	128
bombas para máquinas de cubitos de hielo	52	juntas de termostato	130
C		juntas insertables	124
cables	54	juntas para frigoríficos	124
cables de alimentación aparatos	54	juntas para puertas	127
cables de cinta plana	56	juntas patra brazos de lavado	130
cables de enlace	56	juntas roscadas	127
cajas de bornes	57	juntas térmicas	127
cebadores	21	juntas tóricas	128
clips de fijación	149	L	
clips para bulbo	13	lámparas	17
compensadores de tracción	55	lámparas de señalización	17
componentes para el circuito frigorífico	131	lámparas de señalización completas	18
compresores	37	lámparas fluorescentes	20, 20
condensadores de alta tensión	53	lámparas para hornos	23
condensadores de arranque	52	lámparas para microondas	23
condensadores de servicio	52	lámparas para neveras	22
condensadores y filtros antiparasitarios	52	LEDs	19
conectores - acoplamientos - enchufes	54	M	
conmutadores de levas	16	magnetrones	25
consumibles	150	material de sujeción	147
contactores	25	microinterruptores	14
controladores de agua de refrigeración	131	motores	49
controladores electrónicos	26	motores de aire caliente	47
D		motores refrigeración universales	43
dosificadores	143	P	
E		parrillas	119
empalmes de tubo	146	pasacables	55
empalmes de tubos	146	pasadores elásticos	150
enchufes/conectores de aparatos	54		
evaporadores	134		

pinzas	13	tubos flexibles de entrada de PVC	144
presostatos	37	tubos flexibles de PVC	144
R		tubos flexibles industriales	144
racores para cables	55	tubos formados	145
reguladores de revoluciones	49	tubos para refrigeración	132
rejillas y rieles guía	119	tuercas	148
relés	25	tuercas hexagonales	147, 148
resistencias	3	U	
resistencias circulación de aire	7	unidades condensadoras	37
resistencias de cuarzo	6	V	
resistencias de inmersión	6	válvulas magnéticas	35
resistencias de máquinas de café	5	válvulas Schrader	131
resistencias para freidora	4	ventilador axial	41
resistencias para grill de contacto	5	ventiladores	41
resistencias para hornos	3	ventiladores de aire caliente	47
resistencias para plancha grills	4	ventiladores de refrigeración	46
resistencias para refrigeración	5	ventiladores para frigoríficos	43
ruedas para aparatos y esquinas protectoras	117	ventiladores radiales	48
S		ventiladores tangenciales	46
semiconductores de potencia	25		
señalizadores de alarma	24		
sensores	29		
sensores universales	29		
sistemas de medición	147		
sondas de temperatura	29		
sujeciones	149		
T			
tapas terminales y tapones	117		
temporizador de descongelación	24		
temporizadores	24		
temporizadores eléctricos	24		
temporizadores mecánicos	24		
terminales	56		
termostatos	8		
termostatos de regulación	9, 10		
termostatos de seguridad	10		
termostatos de superficie	8, 9		
termostatos de superficie de seguridad	8		
termostatos para frío	12		
tornillos	147		
tornillos de cabeza moleteada	148		
tornillos de cabeza plana	147		
tornillos planos	148		
transformadores	26		
tubos de cobre aislados	133		
tubos de cobre sin aislar	132		
tubos de salida	144		
tubos de silicona	145		
tubos flexibles	144		
tubos flexibles de entrada	144		