



COMPONENTES GAS



COMPONENTES ELÉCTRICOS



TECNOLOGÍA DEL AGUA



COMPONENTES MECÁNICOS



HERRAMIENTAS

Repuestos adaptables a

IARP

Encuentre nuestra gama siempre actualizada en la tienda online de GEV



Catálogo de fabricantes

Las piezas de repuesto y accesorios más importantes de cada fabricante reunidas y ordenadas de manera práctica

- ✓ En la tienda online GEV encontrará el surtido completo y toda la información actualizada de máquinas y aparatos
- ✓ Índice alfabético al final del catálogo

Tienda online GEV

www.gev-online.es
www.gev-online.com



- 🔍 marcar artículos como favoritos
- 🔍 acceso mediante su e-mail y su contraseña habitual
- 🔍 ponga en la cesta de la compra, múltiples artículos a la vez
- 🔍 búsqueda de artículos inmediata sin necesidad conectarse

resistencias

resistencias para refrigeración

resistencias de descongelación



código	417669	referencia	0205376
descripción	resistencia 233W 230V L 195mm An 122mm empalme conector Faston 6,3mm longitud del cable 1000mm tubo ø 8.5mm descongelación		

cables de calefacción

empalme ambos lados (con revestimiento de metal trenzado)



código	417516	referencia	0231005
descripción	cable de calefacción 40.6W 230V ø 2.6mm L 4600mm 10W/m		

termostatos

termostatos para frío

DANFOSS

termostatos de regulación

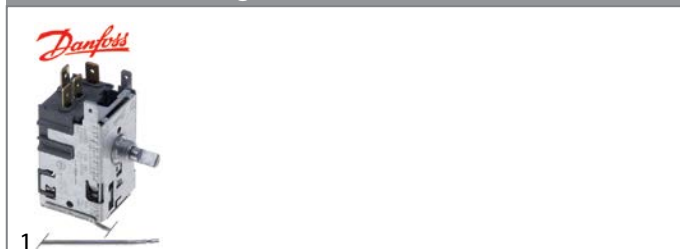

código	390774	referencia	0225093 0225178
descripción	termostato tipo 077B3317L capilar 2000mm margen de trabajo -13,6 a -30,0°C sonda ø 2mm		

RANCO

serie K22

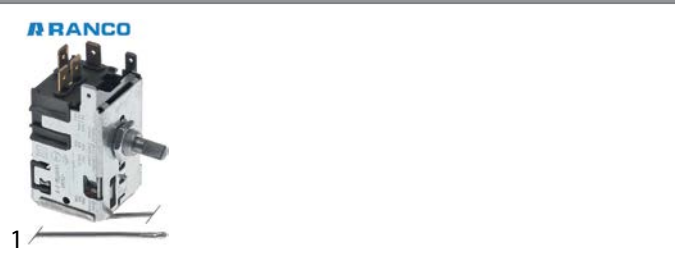

código	391000	referencia	0225095 3305084 I3305084
descripción	termostato RANCO tipo K22L1067 sonda ø 2mm sonda L 7mm capilar 1500mm T caliente 10.5°C T fría -32°C eje L 11mm eje 6x4mm		

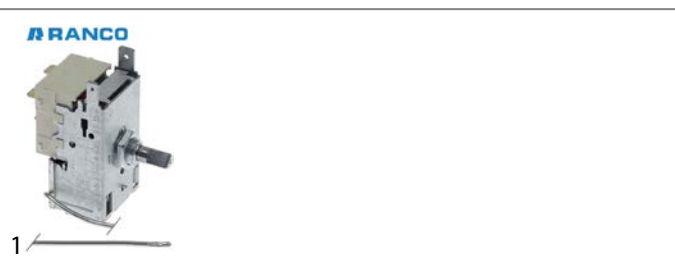

código	391003	referencia	0225008
descripción	termostato RANCO tipo K22L1067 sonda ø 2mm sonda Lmm capilar 1500mm T caliente -10°C T fría -34°C		



código	390775	referencia	0225105
descripción	termostato RANCO tipo K22L2088 sonda ø 2mm capilar 2500mm margen de trabajo -10 a -20°C		

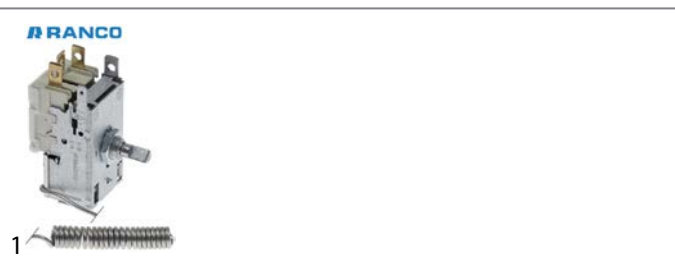

código	391007	referencia	3304241
descripción	termostato RANCO tipo K22-L8103 sonda ø 2mm sonda L 48mm capilar 1500mm T caliente 10°C T fría -5°C para frigorífico		

serie K50



código	391008	referencia	3304724
descripción	termóstato RANCO tipo K50B-S3492 sonda ø 2mm sonda Lmm capilar 2500mm T caliente -19°C T fría -26°C máquina de hielo en cubitos		



código	390990	referencia	I0225186
descripción	termóstato RANCO tipo K50B-S3528 capilar 800mm		



código	390760	referencia	3301323
descripción	termóstato RANCO tipo K50-L3210 sonda ø 2mm sonda Lmm capilar 2500mm margen de trabajo -30 a -23°C refrigeración		

accesorios para 390760



código	112654	referencia	3301324
pomo ø 22.5mm eje ø 6x4mm azul para termostato			



código	391004	referencia	3300683
descripción	termóstato RANCO tipo K50-L3313 sonda ø 2mm sonda Lmm capilar 1500mm para vitrinas frías		



código	391002	referencia	0225088 3306115 I3306115
descripción	termóstato RANCO tipo K50-L3319 sonda ø 2mm sonda L 7mm capilar 1000mm eje L 11mm eje 6x4mm		



código	390757	referencia	0225090
descripción	termóstato RANCO tipo K50-L3337 sonda ø 2mm sonda Lmm capilar 1500mm refrigeración		



código	391005	referencia	3303610
descripción	termóstato RANCO tipo K50-L3425 sonda ø 2mm sonda Lmm capilar 1000mm T caliente -10°C T fría -30°C para vitrinas frías		



código	391006	referencia	0225081 0225185
descripción	termóstato RANCO tipo K50L7201 sonda ø 2mm sonda L 36mm capilar 900mm para frigorífico		



serie K57



1 

código	390665	referencia	3302297 3304195
descripción	termóstato RANCO tipo K57-L2852 sonda ø 10mm sonda L 40mm capilar 1200mm		

interruptores y pulsadores

interruptores/pulsadores basculantes

30x22mm





1

código	301009	referencia	0202008 0202030
descripción	interruptor basculante medida de montaje 30x22mm blanco 2NO 250V 16A iluminado 0-I empalme conector Faston 6,3mm temperatura ambiente máx. 125/55°C protección IP65		
Para modelos:	GAYA20-TOP-DOOR		
accesorios para	301009		
	código	301036	referencia —
	cubierta protectora dimensión interior 30x22mm para interruptor basculante medida de montaje mm		



1

código	301002	referencia	3305916 I3305916
descripción	interruptor basculante medida de montaje 30x22mm naranja 2NO 250V 16A iluminado 0-I empalme conector Faston 6,3mm temperatura ambiente máx. 85/125°C protección IP65		
accesorios para	301002		
	código	301036	referencia —
	cubierta protectora dimensión interior 30x22mm para interruptor basculante medida de montaje mm		



1

código	301003	referencia	0202083
descripción	interruptor basculante medida de montaje 30x22mm verde 2NO 250V 16A iluminado 0-I empalme conector Faston 6,3mm temperatura ambiente máx. 125/55°C protección IP65		
accesorios para	301003		
	código	301036	referencia —
	cubierta protectora dimensión interior 30x22mm para interruptor basculante medida de montaje mm		

interruptores pulsantes y pulsadores

27,2x22,2mm



1

código	348112	referencia	3301934
descripción	interruptor pulsante medida de montaje 27,2x22,2mm 2NO 250V 16A sin tapa empalme conector Faston 6,3mm temperatura ambiente máx. 55°C		

ø25mm



1

código	348109	referencia	0202088 3300972
descripción	interruptor pulsante montaje ø 25mm blanco 2NO 250V 16A luz empalme conector Faston 6,3mm temperatura ambiente máx. 55°C		



1

código	347536	referencia	0202007
descripción	interruptor pulsante montaje ø 25mm blanco 2NO 250V 16A empalme conector Faston 6,3mm temperatura ambiente máx. 125°C protección IP40		



1

código	345151 ¹	referencia	0202000
descripción	interruptor pulsante montaje ø 25mm naranja 2NO 250V 16A iluminado empalme conector Faston 6,3mm temperatura ambiente máx. 85°C protección IP40		

¹iluminado



1

código	345161 ¹	referencia	3303454
descripción	interruptor pulsante montaje ø 25mm verde 2NO 250V 16A iluminado empalme conector Faston 6,3mm temperatura ambiente máx. 85°C protección IP40		

¹iluminado



1

código	346003	referencia	0202084
descripción	pulsador montaje ø 25mm rojo 1NO/lámpara 250V 16A iluminado empalme conector Faston 6,3mm temperatura ambiente máx. 85°C protección IP65		





			
1			
código	347537	referencia	0202087
descripción	interruptor pulsante montaje ø 25mm verde 2NO 250V 16A iluminado interruptor principal empalme conector Faston 6,3mm temperatura ambiente máx. 55/120°C protección IP40		

microinterruptores

con tecla

interruptores de enganche rápido

			
1			
código	345249	referencia	020270
descripción	microinterruptor con tecla 250V 0.25A 1NO empalme conector Faston 6,3mm L 26x12mm temperatura ambiente máx. 85°C fuerza de accionamiento: 500g		

			
1			
código	348192	referencia	0202070 I0202070
descripción	microinterruptor con tecla 250VA 1NO empalme conector Faston 6,3mm L 26x12mm temperatura ambiente máx. 85°C fuerza de accionamiento: 500g		



lámparas



lámparas de señalización

lámparas de señalización completas

30x22mm

			
1			
código	359155	referencia	0200007
descripción	lámpara de señalización medida de montaje 30x22mm 230V rojo empalme conector Faston 6,3mm resis.a la temp. 125°C tipo RL2		

			
1			
código	359157	referencia	0200008
descripción	lámpara de señalización medida de montaje 30x22mm 230V verde empalme conector Faston 6,3mm resis.a la temp. 125/55°C tipo RL2		
Para modelos:	GAYA20-TOP-DOOR		
accesorios para	359157		
	código	301036	referencia
			—
	cubierta protectora dimensión interior 30x22mm para interruptor basculante medida de montaje mm		

			
1			
código	359178	referencia	N/A
descripción	lámpara de señalización medida de montaje 30x22mm 230V verde empalme conector Faston 6,3mm resis.a la temp. 85°C tipo Marquardt 1667.. IP44		
accesorios para	359178		
	código	301036	referencia
			—
	cubierta protectora dimensión interior 30x22mm para interruptor basculante medida de montaje mm		

lámparas fluorescentes

accesorios

balastos

			
1			
código	401504	referencia	0206009 3303896
descripción	balasto eléctrico 18W 230V UE 1 pzs		
Para modelos:	GAYA20-TOP-DOOR		

			
1			
código	401505	referencia	0206012 3303897
descripción	balasto eléctrico 36W 230V UE 1 pzs		
Para modelos:	GAYA20-TOP-DOOR		

temporizadores

temporizadores de programa

			
1			
código	403659	referencia	3306879
descripción	temporizador CDC 4901F1 motores 1 cámaras 1 tiempo de funcionamiento 20s aliment. 230V 50Hz eje ø 6x4,6mm eje Lmm		

temporizador de descongelación

BIGATTI



1

código	360520	referencia	3301867
descripción	reloj de descongelación BIGATTI tipo D94.44 intervalo de descongelación 4x en 24h tiempo de descongelación 12.5min aliment. 230V 50Hz		

CDC



1

código	403603	referencia	I3306873
descripción	reloj de descongelación CDC tipo 4901F1CME000.1000 intervalo de descongelación 4x en 24h tiempo de descongelación 12.5min aliment. 230V 50/60Hz		

otros



1

código	360187	referencia	3300736
descripción	reloj de descongelación tipo RZ-2001-21 intervalo de descongelación 4H tiempo de descongelación 15min retardo ventilador 5min aliment. 230V 50Hz func. descon. 4x en 24h		

relés

relés de potencia

con lengüeta de sujeción



1

código	381252	referencia	3301814
descripción	relé OMRON 230VAC 25A 2NO empalme conector Faston 6,3mm lengüeta de sujeción a 250 V 25A N° fabricante G7L-2A-TUB 230VAC		



1

código	380139	referencia	3301894 3301895
descripción	relé de potencia FINDER 230VAC 16A 2CO empalme F6,3 lengüeta de sujeción medidas 68x38,2x35,8mm N° fabricante 62.82.8.230.0000		



1

código	380687	referencia	3300702
descripción	relé de potencia FINDER 230VAC 30A 2NO empalme F6,3 lengüeta de sujeción N° fabricante 66.82.8.230.0300		
Para modelos:	GAYA20-TOP-DOOR		



controladores electrónicos

EUREMA

controladores de punto de refrigeración



1

código	378471	referencia	3304410 3306508 I3306508
descripción	controlador electrónico EUREMA tipo TE11E medida de montaje 58x25mm aliment. 230V tensión AC PTC salidas de relé 1 NO-16A PTC profundidad de montaje 82mm protección IP65 versión empotrada -50 a +50°C display 2 dígitos		



1

código	378281	referencia	0233096 3303605
descripción	controlador electrónico EUREMA tipo TE32E medida de montaje 64x32mm aliment. 230V tensión AC PTC salidas de relé 3 NO-16A NO-8A NO-5A PTC protección IP65 versión empotrada -50 a +50°C display 2 dígitos		



1

código	378486	referencia	TE32F
descripción	controlador electrónico EUREMA tipo TE32F medida de montaje 58x25mm aliment. 230V tensión AC PTC/NTC salidas de relé 3 NO-16A CO-10A NO-10A PTC/NTC PTC/NTC DI dimensiones frontales 64x32mm profundidad de montaje 82mm protección IP65 precisión 1% versión empotrada con adaptador 71x29 func. descon. presente -50 a +99°C display 2½ dígitos		

termómetros



1

código	379778	referencia	0205115 TE01DEF
descripción	termómetro EUREMA tipo TE01 medida de montaje 58x25mm 230V tensión AC -10 a +55°C PTC display 2 dígitos dimensiones frontales 63x32mm protección IP65 precisión 1%		



1

código	378472	referencia	3301028 I3301028
descripción	termómetro EUREMA tipo TE01DEF medida de montaje 58x25mm 230V tensión AC°C entrada de medición PTC display 2½ dígitos dimensiones frontales 64x32mm protección IP65 precisión 1% PTC		

accesorios



1

código	378306	referencia	3303038
descripción	módulo de carga EUREMA tipo EWEM036 medida de montaje 115x37mm aliment. 230V tensión AC salidas de relé 3 CO-20A CO-16A CO-10A dimensiones frontalesmm profundidad de montaje 70mm protección IPx0 versión montaje mural func. descon.°C display		

accesorios para	378306	código	403555	referencia	3303049
			cable de cinta plana 5 polos L 1000mm tipo de conector IDC-AUTO-COM HE14, 90° medida reticular 2.54mm		

sensores

sensores universales

sondas de temperatura



1

código	379343	referencia	0205610
descripción	sensor de temperatura NTC 10kOhm cable silicona sonda -40 a +110°C cable -50 a +180°C bulbo ø6x40mm longitud de cable 3m de dos hilos		

sensores específicos del fabricante

sensores



1

código	403910	referencia	I0205805
descripción	sensor de temperatura NTC 10kOhm cable PVC sonda -40 a +110°C empalme de dos hilos bulbo 5x20 longitud de cable 1.475m		



electrónicas

placas electrónicas



1

código	402976	referencia	0205600
descripción	placa electrónica termómetro L 68mm An 33mm longitud del cable 2000mm con sensor 230V tensión AC		



1

código	403736	referencia	43845000 I9R00462
descripción	platina de control refrigeración IARP L 222mm An 40mm		

teclados

membranas de teclado



1

código	403764	referencia	49357000
descripción	membrana de teclado congelador instantáneo L 165mm An 45mm		

válvulas magnéticas

válvulas magnéticas refrigeración

DANFOSS

cuerpos de válvula



1

código	370160	referencia	0189035 I0189035	
descripción	cuerpo de válvula magnética NC tipo EVR 3 p máx. 45.2bar DN 3.2mm empalme 6mm conexión para soldadura -40° a 105°C refrigeración recto DANFOSS			
accesorios para	370160			
	código	371046	referencia	—
	consola para válvula magnética para EVR2,3,6,10			

compresores

EMBRACO / ASPERA

R134A

HBP monofásico

Temperatura alta de evaporación superior a -15°C



1

código	605181	referencia	0210607
descripción	compresor refrigerante R134a tipo EMT50HDP 220-240V 50Hz HBP 7.8kg 1/6HP capacidad cilindro 4.5 cm ³ RSIR H 166mmWWW 161W 207W 261W 324W 396W 476W		

HMBP monofásico

Temperatura alta/media de evaporación superior a -20/-15 °C



1

código	605016	referencia	0210611
descripción	compresor refrigerante R134a tipo EM65HHR 220-240V 50Hz HBP completamente hermético 7.62kg 1/6HP capacidad cilindro 5.54 cm ³ CSIRWWW 287W 389W 499W 617W 742W metodo de test ASHRAE 842W		



R290A

LBP monofásico

Temperatura baja de evaporación inferior a -20°C

1

código	605258	referencia	I0210981
descripción	compresor refrigerante R290 tipo EMTE2134U 220-240V 50Hz LBP 9kg 3/8HP capacidad cilindro 9.5 cm ³ CSIR H 187mm 250W 278W 305W 330W 366W		



1

código	605274	referencia	0210809
descripción	compresor refrigerante R290 tipo NEK2134U 220-240V 50Hz LBP 11kg 1/2HP capacidad cilindro 9.99 cm ³ CSIR 351W 441W 552W 682W 833W metodo de test ASHRAE		



1

código	605204	referencia	0210951
descripción	compresor refrigerante R290 tipo NEK2160U 220-240V 50Hz LBP 11.9kg 3/4HP capacidad cilindro 16.8 cm ³ CSR H 206mm 508W 646W 808W 995W 1206W metodo de test ASHRAE		

R600A

LBP monofásico

Temperatura baja de evaporación inferior a -20°C

1

código	605257	referencia	45004031
descripción	compresor refrigerante R600a tipo EMD46CLT 220-240V 50Hz LBP 7.5kg capacidad cilindro 7.96 cm ³ RSCR H 210mm 88W 118W 154W 196W 246W		

SECOPI DANFOSS

R134A

HMBP monofásico

Temperatura alta/media de evaporación superior a -20/-15 °C

1

código	605076	referencia	0210109
descripción	compresor refrigerante R134a tipo SC18G 220-240V 50Hz HMBP completamente hermético 13.7kg 1/2HP consumo 495W capacidad cilindro 17.7 cm ³ CSIR H 219mmW 348W 485W 649W 844W 1074W 1343W 1655W 2014W metodo de test ASHRAE		

repuestos para 605076

código	380058	referencia	—
	relé de arranque DANFOSS 117U6019/F278 HST		



1			
código	605194	referencia	0210107
descripción	compresor refrigerante R134a tipo SC21G 220-240V 50Hz HMBP 13.5kg 5/8HP consumo 643W capacidad cilindro 20.95 cm ³ CSR H 219mmW 410W 558W 746W 977W 1250W 1568W 1931W 2343W metodo de test ASHRAE		

ventiladores

ventilador axial

importación



1			
código	601131 ¹	referencia	0221005 0221151 I0221151
descripción	ventilador axial L 119mm An 119mm H 25mm 230VAC 50/60Hz 19/18W cojinete rodamiento de bolas empalme conector Faston 2,8mm metal ADDA rodete ventilador ø 110mm resis.a la temp. 70°C		
accesorios para	601131		
	código	referencia	0221181 I0221181
	cable de conexión longitud del cable 2000mm empalme F 2,8 distancia de empalme 7.9mm para ventilador axial		

¹con rodamiento de bolas



1			
código	601909 ¹	referencia	45003031
descripción	ventilador axial L 119mm An 119mm H 38mm 220-240 50/60Hz 31/29W cojinete rodamiento de bolas empalme conector Faston 2,8mm		

¹con rodamiento de bolas



1			
código	601055 ¹	referencia	0221007
descripción	ventilador axial L 92mm An 92mm H 25mm 230VAC 50/60Hz 14.5/14W cojinete rodamiento de bolas empalme conector Faston 2,8mm metal ADDA rodete ventilador ø 85mm resis.a la temp. 70°C		
accesorios para	601055		
	código	referencia	0221181 I0221181
	cable de conexión longitud del cable 2000mm empalme F 2,8 distancia de empalme 7.9mm para ventilador axial		
	código	referencia	—
	rejilla de protección ø 90mm distancia de sujeción 83mm para ventilador axial 92mm		

¹con rodamiento de bolas

accesorios

rejillas ventiladores



1			
código	691104	referencia	0427017 I0427017
descripción	rejilla de protección ø 115mm distancia de sujeción 105mm para ventilador axial 119mm		

cables de conexión



1			
código	550898	referencia	0221181 I0221181
descripción	cable de conexión longitud del cable 2000mm empalme F 2,8 distancia de empalme 7.9mm para ventilador axial		



ventiladores para frigoríficos

motores refrigeración universales

ELCO

serie N - estándar



1

código	601442	referencia	0220067 I0220067
descripción	motor de ventilador ELCO 10W 230V 50-60Hz cojinete cojinete de fricción L1 45mm L3 83mm An 83mm longitud del cable 1800mm 1300/1550rev/min 3 opciones de sujeción VN10-20/507 triple		
repuestos para	601442		
	código	601413	referencia —
	placa de sujeción apto para rodete ventilador ø ext. 32mm eje ø 7 distancia de sujeción 26mm		



1

código	601762	referencia	0221141
descripción	motor de ventilador ELCO 10W 230V 50Hz cojinete rodamiento de bolas L1 49mm L2 59mm L3 86.5mm An 83mm empalme cable 500mm longitud del cable 500mm 1300/1550rev/min 3 opciones de sujeción VN10-20/1456		
repuestos para	601762		
	código	601413	referencia —
	placa de sujeción apto para rodete ventilador ø ext. 32mm eje ø 7 distancia de sujeción 26mm		



1

código	601763	referencia	0221140
descripción	motor de ventilador ELCO 16W 230V 50/60Hz cojinete rodamiento de bolas L1 48mm L2 64mm L3 91.5mm An 83mm empalme cable 500mm longitud del cable 500mm 1300/1550rev/min 3 opciones de sujeción VN16-25/1457		
repuestos para	601763		
	código	601413	referencia —
	placa de sujeción apto para rodete ventilador ø ext. 32mm eje ø 7 distancia de sujeción 26mm		

1

código	601735	referencia	0221115 3604962
descripción	motor de ventilador ELCO 5W 230V 50/60Hz cojinete cojinete de fricción L3 71mm An 59mm empalme Kabel 1430mm longitud del cable 1500mm 1300/1550rev/min 3 opciones de sujeción VN5-13/249		

serie IQ



1

código	601886	referencia	0220087
descripción	motor de ventilador 14W 230V 50/60Hz L2 35-56mm L3 95mm An 80mm longitud del cable 1000mm 1400rev/min ELCO motor IQ 3 opciones de sujeción cojinete rodamiento de bolas		



1

código	601887	referencia	0220088
descripción	motor de ventilador 25W 230V 50/60Hz L2 46-66mm L3 115mm An 90mm longitud del cable 1000mm 1400rev/min ELCO motor IQ 3 opciones de sujeción cojinete rodamiento de bolas		

FMI



1

código	601332	referencia	0220072 I0220072
descripción	motor de ventilador 16W 230V 50Hz L1 65mm L2 54mm L3 94mm An 77mm longitud del cable 500mm 1300/1550rev/min ABS12 5 opciones de montaje cojinete cojinete de fricción		
Para modelos:	GAYA20-TOP-DOOR		
repuestos para	601332		
	código	601413	referencia —
	placa de sujeción apto para rodete ventilador ø ext. 32mm eje ø 7 distancia de sujeción 26mm		

accesorios

rodetes de ventilador

aluminio

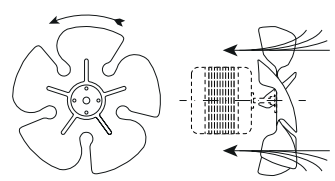
1

código	601069	referencia	0407004
descripción	rodete ventilador aspirante ø 172mm sentido de rotación izquierdo fijación asta 25.4mm inclinación de la pala 25° An 32mm aluminio		

anillos de fijación



1

código	601586	referencia	0221128
descripción	anillo para aspa ø 172mm aspirante ø 220mm H 49mm distancia de sujeción 1 208mm distancia de sujeción 2 94.5mm		



1

código	601587	referencia	0221116
descripción	anillo para aspa ø 200mm aspirante ø 246mm H 49mm distancia de sujeción 1 236mm distancia de sujeción 2 94.5mm		

ventiladores tangenciales

COPREL

ventiladores dobles



1

código	602107	referencia	N/A
descripción	ventilador tangencial COPREL TFD rodillo ø 60mm L rodillo 2x300mm espesor de núcleo laminado 30mm posición del motor centrado 230V/50-60Hz 35W universal cojinete silicona empalme cable 1600mm caudal 333m³/h -10 up a +50°C		

condensadores y filtros antiparasitarios

condensadores de arranque

condensadores de arranque



1

código	365153	referencia	0210402
descripción	condensador de arranque 52µF 330V 50/60Hz ciclo de trabajo 3s 41280A133 2252347 ø 36mm L 83mm M8 plástico empalme cable 350mm		



fusibles

contactores de protección de línea

otros



1

código	356000	referencia	I3301770
descripción	disyuntor 2 20A con interruptor de corriente de defecto		

accesorios eléctricos

cables

cables de alimentación aparatos



1

código	552002	referencia	I3306470
descripción	cable de conexión par aparatos CEE7/7 tipo E+F contactos P+N+T 1mm ² máx. 16A máx. 230V 2.5m		

cables de cinta plana

grupo 6



1

código	403555	referencia	3303049
descripción	cable de cinta plana 5 polos L 1000mm tipo de conector IDC-AUTO-COM HE14, 90° medida reticular 2.54mm		

cajas de bornes



1

código	551086	referencia	01009
descripción	caja de bornes 6 polos L 117mm An 67mm H 22mm protección IP30		

componentes específicos

para frigoríficos

recambios y accesorios



1

código	551346	referencia	I0534005R
descripción	casquillo refrigerador compresor ø 9mm int.ø 6.5mm L 17mm UE 1 pzs		



1

código	699232	referencia	I0535012
descripción	compensador de tracción L 56mm An 14.5mm H 20mm		

cajas y paneles frontales

cubiertas



1

código	998252	referencia	44037000
descripción	cubierta para ventilación L 72mm An 62mm H 10mm UE 1 pzs		

paneles de mando



1

código	699234	referencia	44027000
descripción	revestimiento L 780mm An 67mm H 62mm pos. de montaje arriba		

carcasas



1

código	699233	referencia	I9500323
descripción	caja de bornes L 98mm An 74mm H 35mm Kit		

pomos

pomos personalizados para fabricantes

IARP



1

código	112654	referencia	3301324
descripción	pomo ø 22.5mm eje ø 6x4mm azul para termostato		

cierres

dispositivos de cierre

específico del fabricante

IARP



1

código	701113	referencia	0423001
descripción	cilindro de cerradura ángulo de rotación 180° longitud de pestillo 32mm anchura de pestillo 17mm montaje ø 19mm		



1

código	702100	referencia	44373000
descripción	cilindro de cerradura ø 19mm ángulo de rotación 180° longitud de pestillo 42.5mm anchura de pestillo 14mm		



1

código	701114	referencia	0423002
descripción	retén plástico H 15mm L 40mm An 15mm agujero ø 4.2mm distancia de sujeción 14mm para cierre		

bisagras

soporte de puerta



1

código	701564	referencia	46996000
descripción	bisagra L 130mm An 85mm H 38mm distancia de sujeción 48mm distancia de sujeción 2 33mm rosca M6 ø 8mm perno 13mm perno ø 8mm		



1

código	701026	referencia	0162886
descripción	bisagra L 56mm An 50mm pos. de montaje arriba espesor 3mm		
accesorios para	701026		
código	701025	referencia	0530022
descripción	perno L 45mm pos. de montaje arriba rosca M8x1,25 ø 12mm para bisagra		



1

código	701027	referencia	0415122
descripción	bisagra L 58mm An 28mm H 73mm pos. de montaje abajo con perno		



1

código	701039	referencia	0160434
descripción	bisagra L 67mm An 43mm H 22mm pos. de montaje abajo derecha		



1

código	701563	referencia	43870000
descripción	bisagra L 98mm An 48mm H 38mm distancia de sujeción 40mm distancia de sujeción 2 20mm rosca M6		



código	692537	referencia	0415134 I0415134
descripción	bisagra de puerta L 68mm An 25mm pos. de montaje arriba derecha con varilla		



código	701567	referencia	41649000
descripción	casquillo L 11mm ø 11/15mm espesor 2mm		



código	701572	referencia	I0534002
descripción	casquillo ø 18.5mm int.ø 12mm		



código	701566	referencia	46997000
descripción	cojinete giratorio L 72mm An 39mm H 30mm distancia de sujeción 25mm distancia de sujeción 2 25mm pos. de montaje derecho		



código	701565	referencia	48205000
descripción	cojinete giratorio L 72mm An 39mm H 30mm distancia de sujeción 25mm distancia de sujeción 2 25mm pos. de montaje izquierdo		



código	701562	referencia	44447000
descripción	perno L 36mm An 22mm rosca M6 perno 12mm perno ø 12mm		



código	701025	referencia	0530022
descripción	perno L 45mm pos. de montaje arriba rosca M8x1,25 ø 12mm para bisagra		
accesorios para	701025		
	código	701026	referencia 0162886
	bisagra L 56mm An 50mm pos. de montaje arriba espesor 3mm		

pies para aparatos y tapas terminales

pies enroscables



código	701112	referencia	0403014 I0403014
descripción	pie de aparato rosca M10 rosca L 43mm ø 29mm H 52mm plástico EC 35 UE 1 pzs		

rejillas y rieles guía

parrillas



universal

con reborde





código	970824	referencia	0427743
descripción	parrilla An 526mm P 418mm acero plastificado con tope traviesas 2		



código	970556	referencia	0427396
descripción	parrilla An 530mm P 650mm GN 2/1 acero plastificado con tope anillo externo reforzado 9mm refuerzos longitudinales 5mm traviesas 2 blanco apto para refrigerador		
accesorios para	970556		
	código	690330	referencia —
	cremallera L 1000mm An 22mm H 4mm tamaño orificio 3x8mm dist. del agujero 12.5mm acero inoxidable		
	código	690332	referencia I0402138
	soporte de bandeja L 31/28mm An 22mm H 17mm inox con gancho UE 1 pzs		

Continúa en la página siguiente





accesorios para	970556			
	código	694700	referencia	—
	soporte de bandeja L 31/28mm An 22mm H 18mm inox UE 12 pzs			
	código	694701	referencia	—
	soporte de bandeja L 31/28mm An 22mm H 17mm inox con gancho UE 12 pzs			

			
código	970874	referencia	0427709
descripción	parrilla An 650mm P 540mm GN 2/1 H 30mm acero plastificado con tope para frigorífico anillo externo reforzado 7.3mm refuerzos longitudinales 3.2mm traviesas 2 blanco		

específico del fabricante			
			
código	970930	referencia	44714000
descripción	parrilla An 650mm P 330mm H 9mm anillo externo reforzado 7mm refuerzos longitudinales 3mm traviesas 1		

			
código	970929	referencia	44379000
descripción	parrilla An 665mm P 560mm H 30mm anillo externo reforzado 7mm refuerzos longitudinales 3mm traviesas 2		

rieles guía y soportos

universal				
				
código	690332	referencia	I0402138	
descripción	soporte de bandeja L 31/28mm An 22mm H 17mm inox con gancho UE 1 pzs			
accesorios para	690332			
	código	690330	referencia	—
	cremallera L 1000mm An 22mm H 4mm tamaño orificio 3x8mm dist. del agujero 12.5mm acero inoxidable			

específico del fabricante			
			
código	699231	referencia	I0402137
descripción	guida blanco L 1350mm An 20mm H 5mm UE 1		

			
código	691835	referencia	0160741
descripción	soporte de bandeja L 28/25mm An 35mm H 19mm		

juntas

juntas para frigoríficos

juntas insertables

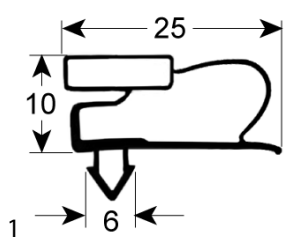
perfil 9050			
			
código	902152	referencia	0313225
descripción	junta para frigorífico perfil 9050 An 560mm L 1585mm medida inserción		

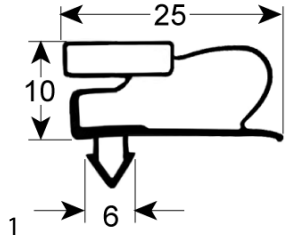
			
código	902051	referencia	0313220
descripción	junta para frigorífico perfil 9050 An 700mm L 1505mm medida inserción		

perfil 9151

Fabricamos burletes personalizables de este perfil

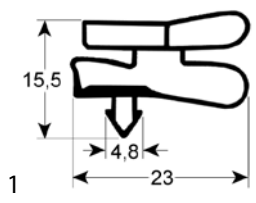
			
código	901457	referencia	3303310
descripción	junta para frigorífico perfil 9151 An 495mm L 1440mm medida inserción		

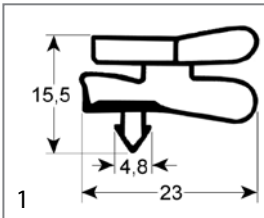

código	901458	referencia	0313223
descripción	junta para frigorífico perfil 9151 An 535mm L 1690mm medida inserción		

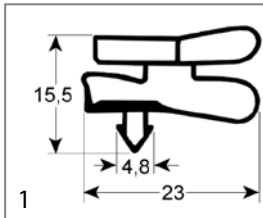

código	901086	referencia	0313206
descripción	junta para frigorífico perfil 9151 An 620mm L 1522mm medida inserción L1 1532mm B1 630mm medidas exteriores		

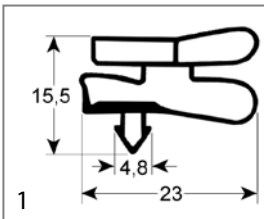

código	901083	referencia	0313205
descripción	junta para frigorífico perfil 9151 An 550mm L 1722mm medida inserción L1 1712mm B1 540mm medidas exteriores		

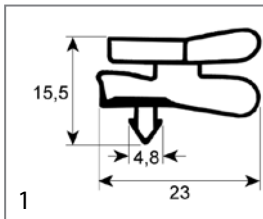

código	901096	referencia	0313191 3300917
descripción	junta para frigorífico perfil 9151 An 620mm L 890mm medida inserción		

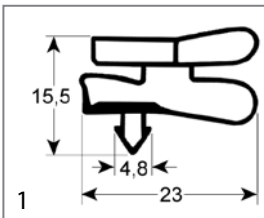

código	901179	referencia	3302200 I3302200
descripción	junta para frigorífico perfil 9151 An 555mm L 1555mm medida inserción L1 1545mm B1 545mm medidas exteriores		

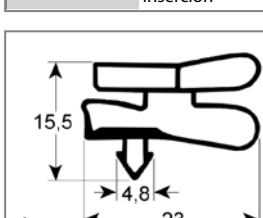

código	901081	referencia	0313010
descripción	junta para frigorífico perfil 9151 An 634mm L 1391mm medidas exteriores L1 1381mm B1 624mm medida inserción		

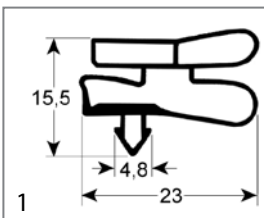

código	901080	referencia	0313007 I0313007
descripción	junta para frigorífico perfil 9151 An 558mm L 1713mm medida inserción L1 1703mm B1 548mm medidas exteriores		

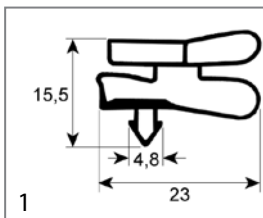

código	901097	referencia	3300913
descripción	junta para frigorífico perfil 9151 An 637mm L 576mm medida inserción		

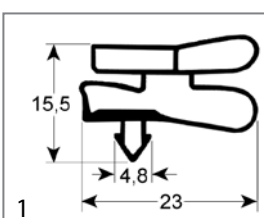

código	901082	referencia	0313178
descripción	junta para frigorífico perfil 9151 An 585mm L 1390mm medida inserción L1 1380mm B1 575mm medidas exteriores		

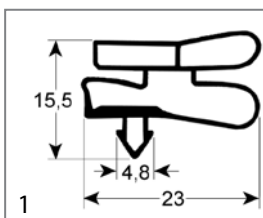

código	901796	referencia	0313221
descripción	junta para frigorífico perfil 9151 An 655mm L 1534mm		



código	901377	referencia	0313291
descripción	junta para frigorífico perfil 9151 An 715mm L 1674mm medida inserción L1 1686mm B1 722mm medidas exteriores		

código	901322	referencia	0313233
descripción	junta para frigorífico perfil 9151 An 717mm L 1515mm medida inserción L1 1505mm B1 707mm medidas exteriores		

código	901085	referencia	0313200
descripción	junta para frigorífico perfil 9151 An 730mm L 1550mm medida inserción L1 1540mm B1 720mm medidas exteriores		

código	901084	referencia	0313202 0313207
descripción	junta para frigorífico perfil 9151 An 740mm L 1619mm medida inserción L1 1609mm B1 730mm medidas exteriores L exterior 1625mm anchura medida exterior 740mm		

perfil 9058

código	902395	referencia	44404000
descripción	junta para frigorífico perfil 9058 An 770mm L 1810mm medida inserción UE 1		

componentes para el circuito frigorífico

filtros deshidratadores antiácidos

otros

código	750311	referencia	0145040
descripción	deshidratador tamaño 20g ø 19mm L 149mm empalme 3,2/6,2mm		

código	750310	referencia	0145015
descripción	deshidratador tamaño 20g ø 19mm L 150mm empalme 3,2/5/6,2mm		

evaporadores

para frigoríficos

específico del fabricante

código	750342	referencia	0130010
descripción	evaporador L 1580mm An 660mm apto para AB500P		

código	750621	referencia	0119189
descripción	evaporador para frigorífico L 390mm An 325mm IARP		



condensadores

condensadores



código	750703	referencia	44918000
descripción	condensador An 790mm P 10mm H 1360mm		

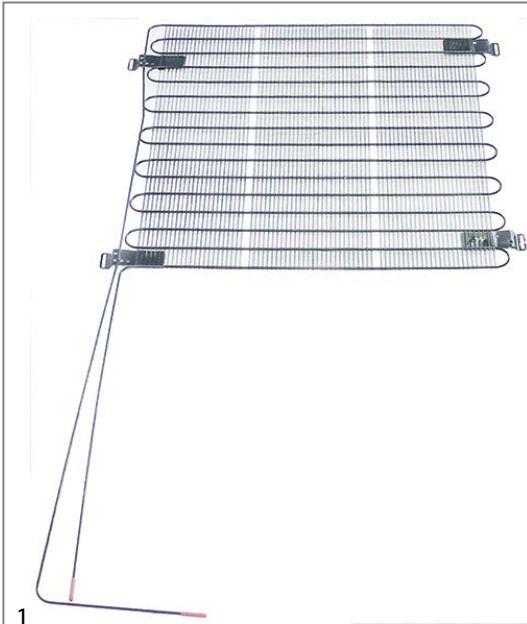

código	750699	referencia	45034000
descripción	condensador An 790mm P 10mm H 750mm UE 1 pzs		

bandejas de agua condensada y cubetas de evaporación

bandejas de agua condensada



código	699211	referencia	I0425088
descripción	bandeja de agua condensada L 230mm An 144mm H 45mm		

sistemas de medición

termómetros

termómetros incorporados



código	541080	referencia	0406018 3303276
descripción	termómetro medida de montaje 58x25,5mm -40 a +40°C capilar 2500mm sonda ø 6mm sonda L 30mm		
Para modelos:	GAYA20-TOP-DOOR		

alimentación eléctrica externa



código	378274 ¹	referencia	0406046
descripción	termómetro ARThERMO tipo ROF-DIG/230 medida de montaje 58x25,5mm dimensiones frontales 64x31mm 230V tensión AC -30 a +110°C bulbo ø6x40mm longitud del cable 2500mm display 3 dígitos		

¹con 1x sensor NTC



material de sujeción

arandelas

arandelas

otros



1

código	560486	referencia	0521000
descripción	arandela int.Ø 14.1mm Ø ext. 22mm espesor 2mm plástico UE 1 pzs		
Para modelos:	GAYA20-TOP-DOOR		

A			
accesorios eléctricos	14	resistencias	3
arandelas	21	resistencias de descongelación	3
B		resistencias para refrigeración	3
balastos	6	S	
C		sensores	8
cables	14	sensores universales	8
cables de alimentación aparatos	14	sistemas de medición	20
cables de calefacción	3	sondas de temperatura	8
cables de cinta plana	14	T	
cajas de bornes	14	temporizador de descongelación	7
componentes para el circuito frigorífico	19	temporizadores	6
compresores	9	temporizadores de programa	6
condensadores de arranque	13	termostatos	3
condensadores y filtros antiparasitarios	13	termostatos para frío	3
controladores electrónicos	8	V	
E		válvulas magnéticas	9
evaporadores	19	ventilador axial	11
F		ventiladores	11
filtros deshidratadores antiácidos	19	ventiladores para frigoríficos	12
fusibles	14	ventiladores tangenciales	13
I			
interruptores pulsantes y pulsadores	5		
interruptores y pulsadores	5		
interruptores/pulsadores basculantes	5		
J			
juntas insertables	17		
juntas para frigoríficos	17		
L			
lámparas	6		
lámparas de señalización	6		
lámparas de señalización completas	6		
lámparas fluorescentes	6		
M			
material de sujeción	21		
microinterruptores	6		
motores refrigeración universales	12		
P			
parrillas	16		
R			
rejillas y rieles guía	16		
relés	7		