



GAS



ELEKTRO



WASSER



MECHANIK



WERKZEUG

Ersatzteile passend für

LA-SPAZIALE

Das komplette Sortiment finden Sie immer aktuell im GEV-Webshop

Hersteller-Kataloge

Für jeden Hersteller die wichtigsten Ersatz- und Zubehörteile übersichtlich zusammengestellt



- ✓ **Komplettes Sortiment und alle Gerätedaten immer aktuell im GEV-Webshop**
- ✓ **Alphabetischer Index am Ende des Katalog**

GEV-Webshop

www.gev-online.de

www.gev-online.ch



- 🔍 Artikel als Favoriten markieren
- 🔍 Einloggen mit E-Mail-Adresse und gewohntem Passwort
- 🔍 Komfort-Bestellung – mehrere Artikel gleichzeitig in den Warenkorb legen
- 🔍 Sofort Artikel suchen ohne Anmeldung



Heizkörper

Heizkörper für Kaffeemaschinen



1

GEV-Nr.	417390	Vergl.-Nr.	806
Beschreibung	Heizkörper 1250W 220V HK 1 L 135mm B 50mm H 22mm L1 24mm L2 36mm L3 75mm BA 42mm Gewinde 1/4" Anschluss Flachstecker 6,3mm AL 22mm Rohr ø 8.3mm 2-Lochbefestigung Tauchheizkörper		



1

GEV-Nr.	417391	Vergl.-Nr.	7201
Beschreibung	Heizkörper 1250W 230V HK 1 Fø 50mm L 160mm B 22mm H 54mm Rohr ø 8.3mm Anschluss Flachstecker 6,3mm Tauchheizkörper		



1

GEV-Nr.	417393	Vergl.-Nr.	7478
Beschreibung	Heizkörper 1250W 230V HK 1 ø 65mm H 200mm B1 48mm H1 135mm H2 65mm BA 32mm Gewinde 3/8" Kupfer Windungen 5 Rohr ø 8.5mm Tauchheizkörper 2-Lochbefestigung Anschluss Flachstecker 6,3mm		



1

GEV-Nr.	417038	Vergl.-Nr.	N/A	
Beschreibung	Heizkörper 2700W 230V HK 1 ø 110mm H 200mm B1 48mm H1 158mm H2 42mm BA 40mm Gewinde 3/8" Kupfer Windungen 4 Rohr ø 8mm Tauchheizkörper 2-Lochbefestigung Anschluss M6			
Zubehör für	417038			
	GEV-Nr.	361183	Vergl.-Nr.	—
	Mutter Gewinde 3/8" H 6mm MsNi SW 20 VPE 1 Stück			
	GEV-Nr.	521137	Vergl.-Nr.	—
	Flachdichtung Fiber AD ø 20mm ID ø 18mm Materialstärke 1.5mm für Gewinde 3/8" VPE 1 Stück			



1

GEV-Nr.	417394	Vergl.-Nr.	425
Beschreibung	Heizkörper 2700W 230V HK 1 ø 112mm H 205mm B1 44mm H1 160mm H2 45mm BA 30mm Gewinde 3/8" Kupfer Windungen 4 Rohr ø 8.5mm Tauchheizkörper Anschluss Flachstecker 6,3mm		



1

GEV-Nr.	417387	Vergl.-Nr.	5504
Beschreibung	Heizkörper 2800W 230V HK 3 Einbau ø 50mm LA 63mm L 345mm B 35mm H 75mm L1 40mm L2 50mm L3 255mm H1 35mm H2 40mm Rohr ø 8.3mm Anschluss Flachstecker 6,3mm Tauchheizkörper 3-Lochflansch		



1

GEV-Nr.	417389	Vergl.-Nr.	426
Beschreibung	Heizkörper 3500W 230V HK 1 ø 115mm H 205mm B1 50mm H1 160mm H2 45mm BA 32mm Gewinde 3/8" Kupfer Windungen 4 Rohr ø 8.5mm Tauchheizkörper 2-Lochbefestigung Anschluss Flachstecker 6,3mm		



1

GEV-Nr.	417388	Vergl.-Nr.	1724
Beschreibung	Heizkörper 3500W 230V HK 3 Einbau ø 50mm LA 63mm L 350mm B 35mm H 70mm L1 40mm L2 60mm L3 250mm H1 35mm H2 35mm Loch ø 8mm Rohr ø 8.3mm Anschluss Flachstecker 6,3mm Tauchheizkörper 3-Lochflansch		



1

GEV-Nr.	417386	Vergl.-Nr.	5505
Beschreibung	Heizkörper 3800W 230V HK 3 Einbau ø 50mm LA 63mm L 550mm B 35mm H 70mm L1 45mm L2 55mm L3 450mm H1 35mm H2 35mm Loch ø 8mm Rohr ø 8.3mm Anschluss Flachstecker 6,3mm Tauchheizkörper 3-Lochflansch		





GEV-Nr.	417147	Vergl.-Nr.	5505
Beschreibung	Heizkörper 3800W 230V HK 3 Einbau ø 51mm LA 63mm L 550mm B 38mm H 65mm Loch ø 10mm TH ø 7mm THL 245mm THA 1 THP nicht anliegend Rohr ø 8mm Anschluss M6 Tauchheizkörper 3-Lochflansch		

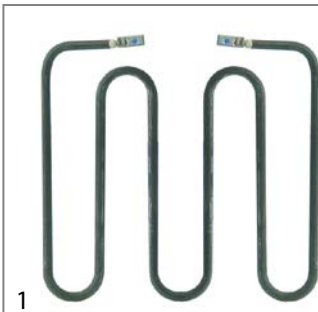

GEV-Nr.	417392	Vergl.-Nr.	7356
Beschreibung	Heizkörper 800W 230V HK 1 Fø 50mm L 160mm B 22mm H 54mm Rohr ø 8.3mm Anschluss Flachstecker 6,3mm Tauchheizkörper		

Heizkörper für Kontaktgrills



GEV-Nr.	416145	Vergl.-Nr.	2987
Beschreibung	Heizkörper 1000W 230V L 177mm B 180mm H 18mm B1 46mm B2 88mm Rohr ø 6.3mm Windungen 3 Anschluss M4 Trockenheizkörper		

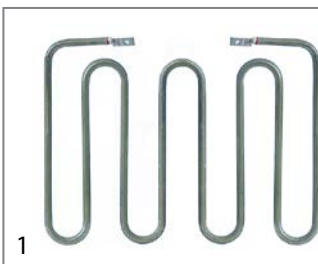

GEV-Nr.	416146	Vergl.-Nr.	5684
Beschreibung	Heizkörper 1200W 230V L 180mm B 228mm H 20mm B1 55mm B2 118mm AL 23mm Rohr ø 6.3mm Windungen 4 Anschluss M4 Trockenheizkörper		

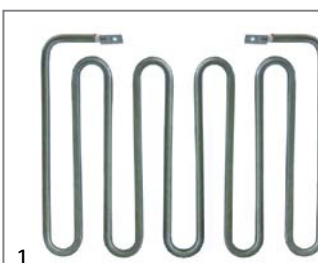

GEV-Nr.	416147	Vergl.-Nr.	5697
Beschreibung	Heizkörper 1500W 230V L 180mm B 175mm H 15mm B1 52mm B2 71mm AL 22mm Rohr ø 6.3mm Windungen 5 Anschluss M4 Trockenheizkörper		

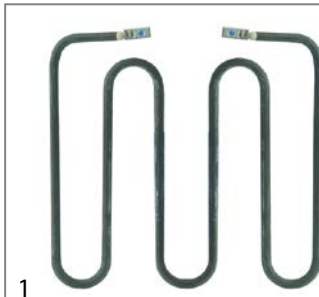

GEV-Nr.	416148	Vergl.-Nr.	2986
Beschreibung	Heizkörper 800W 230V HK 1 L 175mm B 180mm H 20mm B1 46mm B2 118mm AL 23mm Rohr ø 6.3mm Windungen 3 Anschluss M4 Trockenheizkörper		

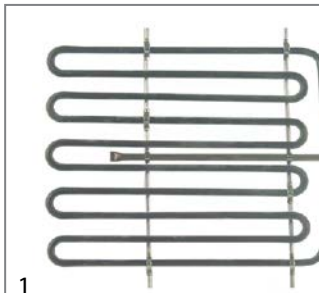

GEV-Nr.	416173	Vergl.-Nr.	6521
Beschreibung	Heizkörper 850W 230V HK 1 L 254mm B 202mm H 25mm B1 68mm B2 66mm AL 23mm Rohr ø 6.3mm Windungen 5 Anschluss M4 THA 1 TH ø 5mm THL 195mm Steglänge 240mm Trockenheizkörper		

Zubehör

Unterlegscheiben



GEV-Nr.	560113	Vergl.-Nr.	1746 624
Beschreibung	Unterlegscheibe ID ø 6.4mm AD ø 12mm Materialstärke 1.6mm CNS VPE 20 Stück DIN 125A für Gewinde M6		

Dichtungsringe

Graphitdichtungen

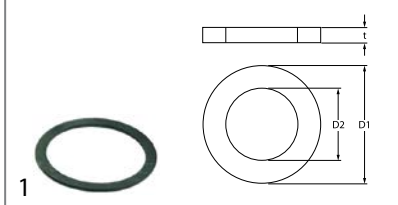

GEV-Nr.	528016	Vergl.-Nr.	N/A
Beschreibung	Flachdichtung Graphit AD ø 62mm ID ø 50mm Materialstärke 2mm VPE 1 Stück		



PTFE-Dichtungen

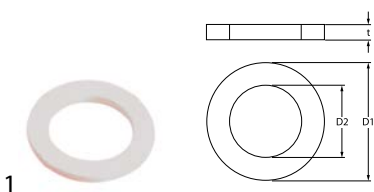

GEV-Nr.	528885	Vergl.-Nr.	424
Beschreibung	Flachdichtung PTFE AD ø 26mm ID ø 17mm Materialstärke 2mm VPE 1 Stück passend für SPAZIALE		

O-Ringe

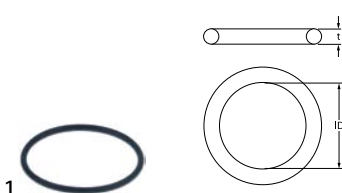

GEV-Nr.	510243	Vergl.-Nr.	02418
Beschreibung	O-Ring Viton Materialstärke 3.53mm ID ø 55.56mm VPE 1 Stück		

Flanschdichtungen



GEV-Nr.	528024	Vergl.-Nr.	N/A
Beschreibung	Dichtung für Heizkörper		

GEV-Nr.	528015	Vergl.-Nr.	N/A
Beschreibung	Dichtung ID ø 55mm Fiber Materialstärke 2mm Loch ø 8mm LA 62mm passend für SPAZIALE für Heizkörper Kaffeetechnik		

Thermostate

Anlegethermostate

Anlege-Sicherheitsthermostate



GEV-Nr.	390709	Vergl.-Nr.	6687
Beschreibung	Sicherheits-Anlegethermostat Abschalttemp. 180°C 1NC 1-polig 16A Anschluss F6,3 Schraubbefestigung Gewinde M4		



GEV-Nr.	390590	Vergl.-Nr.	3343
Beschreibung	Sicherheits-Anlegethermostat LA 24mm Abschalttemp. °C 1NC 1-polig AV Anschluss Stecker 2-Lochbefestigung		

Regel- und Sicherheitsthermostate

EGO

Sicherheitsthermostate

Serie 55.32_

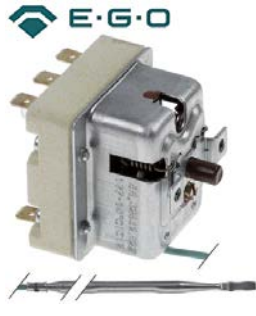

GEV-Nr.	390324	Vergl.-Nr.	1477
Beschreibung	Sicherheitsthermostat Abschalttemp. 169°C 3-polig 3NC 20A Fühler ø 4mm Fühler L 128mm Kapillarrohr 890mm Kapillarrohr isoliert 210/210mm Stopfbuchse Fühler CNS		

IMIT / TEMPOMATIC / ARTHERMO

Regelthermostate



GEV-Nr.	390707	Vergl.-Nr.	11168 809
Beschreibung	Thermostat T.max. 130°C Arbeitsbereich °C 1-polig NC 16A Fühler ø 7mm Fühler L 90mm Kapillarrohr 150mm Kapillarrohr isoliertmm Stopfbuchse M14x1 Achse ø 6x4,6mm Achslänge 23mm Drehwinkel 270°		

Schalter und Taster

Wippschalter/-taster

30x11mm



GEV-Nr.	301010	Vergl.-Nr.	805
Beschreibung	Wippschalter Einbaumaß 30x11mm rot 1NO/Leuchte 250V 16A 0-1 Anschluss Flachstecker 6,3mm Umgebungstemperatur max. 85/125°C Schutzart IP40		

Zubehör für 301010

GEV-Nr.	301035	Vergl.-Nr.	—
Beschreibung	Schutzhaube Einbaumaß 30x11mm		

30x22mm



GEV-Nr.	301001	Vergl.-Nr.	804
Beschreibung	Wippenschalter Einbaumaß 30x22mm rot 2NO 250V 16A beleuchtet 0-I Anschluss Flachstecker 6,3mm Umgebungstemperatur max. 125/55°C Schutzart IP65		
Zubehör für	301001		
	GEV-Nr.	301036	Vergl.-Nr.
	Schutzhaube Innenmaß 30x22mm für Wippenschalter Einbaumaß-mm		

Druckschalter/-taster

20,6x16,4mm





GEV-Nr.	347320	Vergl.-Nr.	4953
Beschreibung	Drucktaster Einbaumaß 20,6x16,4mm schwarz 1NO 250V 12A Anschluss Flachstecker 6,3mm Umgebungstemperatur max. 85°C Schutzart IP40		

28,5x28,5mm



GEV-Nr.	345142	Vergl.-Nr.	2942
Beschreibung	Druckschalter Einbaumaß 28,5x28,5mm rot/grün 2NO 250V 16A Tasse Anschluss Flachstecker 6,3mm Umgebungstemperatur max. 150°C Schutzart IP40 mit Indikator		



GEV-Nr.	347319	Vergl.-Nr.	2942
Beschreibung	Druckschalter Einbaumaß 28,5x28,5mm grün/rot 2NO 250V 16A Tasse Anschluss Flachstecker 6,3mm Umgebungstemperatur max. 150°C Schutzart IP40 mit Indikator		
Ersatzteile für	347319		
	GEV-Nr.	345604	Vergl.-Nr.
	Elementträger einfach Einbaumaß 28,5x28,5mm schwarz für Drucktasten 23x23mm		
	GEV-Nr.	345720	Vergl.-Nr.
	Schaltelement 2NO 250V 16A Anschluss Flachstecker 6,3mm		
	GEV-Nr.	346251	Vergl.-Nr.
	Dreh Scheibe orange/grün Scheibe ø 20,6mm		

Sonstige



GEV-Nr.	347321	Vergl.-Nr.	5825
Beschreibung	Schaltelement schwarz 1NO 20V 1A tastend Anschluss kodierter Stecker Umgebungstemperatur max. 85°C		

Mikroschalter

stiftbetätigt

M10



GEV-Nr.	347216	Vergl.-Nr.	607
Beschreibung	Mikroschalter mit Druckstift Gewinde M10x0,75 Gewinde L 14mm 250V 10A 1CO Anschluss Flachstecker 6,3mm Hub 7,5mm BA 22mm L 28mm Umgebungstemperatur max. 125°C Typ NR6K5 Betätigungskraft: 260g		



GEV-Nr.	345032	Vergl.-Nr.	607
Beschreibung	Mikroschalter mit Druckstift Gewinde M10x1 Gewinde L 12mm 250V 16A 1CO Anschluss Flachstecker 6,3mm Hub 7mm BA 22mm L 28mm Umgebungstemperatur max. 125°C Typ SP9603 Betätigungskraft: 180g		

Systemschalter ROLD



GEV-Nr.	347192	Vergl.-Nr.	6619
Beschreibung	Schaltelement 2NO 250V 16A Anschluss Flachstecker 6,3mm		
Zubehör für	347192		
	GEV-Nr.	347183	Vergl.-Nr.
	Drucktaste Einbau ø 14,3mm verchromt		



Schwimmerschalter

1 

GEV-Nr.	347337	Vergl.-Nr.	1322
Beschreibung	Schwimmerschalter Gewinde 1/8" 1NC ø 28mm L 100mm Einbau ø 1/8"mm 230V 0.5A Steckanschluss Kabellänge 300mm		

Drehschalter

GIOVENZANA

Drehschalter

1 

GEV-Nr.	347323	Vergl.-Nr.	503
Beschreibung	Drehschalter Stellungen 2 0-1 Kontaktsätze 2 Typ PO20 690V 20A Achse ø 5x5mm Achslänge 28mm Achse vierkant Anschluss Schraubanschluss		

1 

GEV-Nr.	347326	Vergl.-Nr.	2496
Beschreibung	Drehschalter Stellungen 2 0-1 Kontaktsätze 2 Typ PO20 690V 32A Achse ø 5x5mm Achslänge 28mm Achse vierkant Anschluss Schraubanschluss 2 Schaltstellungen		

1 

GEV-Nr.	347324	Vergl.-Nr.	2620
Beschreibung	Drehschalter Stellungen 2 0-1 Kontaktsätze 4 Typ PO20 690V 20A Achse ø 5x5mm Achslänge 28mm Achse vierkant Anschluss Schraubanschluss		

1 

GEV-Nr.	347325	Vergl.-Nr.	5694
Beschreibung	Drehschalter Stellungen 3 0-1-2 Kontaktsätze 6 Typ PO20 690V 20A Achse ø 5x5mm Achslänge 23mm Achse vierkant Anschluss Schraubanschluss		

Zubehör

1 

GEV-Nr.	111344	Vergl.-Nr.	2421
Beschreibung	Knebel Nullstrich ø 40mm Achsem L 100mm Achsaufnahme 5x5mm		

VM

1 

GEV-Nr.	347322	Vergl.-Nr.	504
Beschreibung	Drehschalter 0-1 36A Achslänge 24mm Anschluss Schraubanschluss 2 Schaltstellungen 4-polig CODE P501531 Achse 5x5mm		

Zubehör

Hebel

1 

GEV-Nr.	111342	Vergl.-Nr.	1611 4968 6049
Beschreibung	Hebel für Drehschalter ON-OFF L 80mm B 32mm Lochgröße 5x5mm schwarz		

Magnetschalter

23x14mm

1 

GEV-Nr.	347339	Vergl.-Nr.	7635
Beschreibung	Magnetschalter L 23mm B 14mm NO Anschluss Flachstecker 2,8mm Kabellänge 250mm		

ø 9mm

1 

GEV-Nr.	346107	Vergl.-Nr.	2727
Beschreibung	Magnetschalter NO Anschluss Flachstecker 6,3mm Kabellänge 140mm L 31.5mm Einbau ø 9mm		



Lampen

Signallampen

Signallampen 2-teilig (Linse und Signalelement)

Signallampenkappen

ø10mm (Typ SRZ-3)



1

GEV-Nr. 359123 **Vergl.-Nr.** 1113**Beschreibung** Signallampenfassung Einbaumaß ø10mm grün rund VPE 1 Stück**Zubehör für** 359123

1

GEV-Nr. 359132 **Vergl.-Nr.** —
Beschreibung Signalelement grün 250V Anschluss Flachstecker 6,3mm Schutzart IP54 Umgebungstemperatur max. 85°C

Signalelemente für Fassungsstyp SRZ / SDK / SDY / SFK



1

GEV-Nr. 359573 **Vergl.-Nr.** 1112
6593**Beschreibung** Signalelement 230V Anschluss Steckanschluss ø 8mm

1

GEV-Nr. 359130 **Vergl.-Nr.** 1112
6593**Beschreibung** Signalelement 230V klar Anschluss Flachstecker 6,3mm ø 8mm

Signallampen komplett

30x11mm



1

GEV-Nr. 359158 **Vergl.-Nr.** 1096**Beschreibung** Signallampe Einbaumaß 30x11mm 230V rot Anschluss Flachstecker 6,3mm Temp.Best. 125°C

Relais

Niveaurelais

GIEMME



1

GEV-Nr. 402535 **Vergl.-Nr.** 5236**Beschreibung** Niveauregler 230V 50/60Hz Typ RL0 2 RELE+LIV/F

1

GEV-Nr. 402532 **Vergl.-Nr.** 1964**Beschreibung** Niveauregler 230V Typ MAGNETIC+AUTOL.

1

GEV-Nr. 401945 **Vergl.-Nr.** N/A**Beschreibung** Niveaurelais 230V Spannung AC 5A Anschluss Flachstecker 6,3mm Typ RL1E/2C/F

Fühler

Herstellerspezifische Fühler

Fühler



1

GEV-Nr. 379482 **Vergl.-Nr.** 2817**Beschreibung** Temperaturfühler NTC 200kOhm Kabel PTFE Fühler -40 bis +125°C Kabel -40 bis +250°C Anschluss kodierter Stecker Gewinde Fühler ø4x30mm Kabellänge 0.14m

			
1			
GEV-Nr.	402551	Vergl.-Nr.	5060
Beschreibung	Temperaturfühler NTC Kabel PTFE Fühler -40 bis +125°C Kabel -40 bis +250°C Anschluss Flachstecker 2,8mm Gewinde 3/8" Fühler ø5x10mm Kabellänge 0.1m		

			
1			
GEV-Nr.	379481	Vergl.-Nr.	1486 7540
Beschreibung	Temperaturfühler NTC Kabel PVC Fühler -40 bis +110°C Kabel -10 bis +100°C Anschluss Flachstecker 2,8mm Gewinde Fühler ø4x30mm Kabellänge 0.15m		

			
1			
GEV-Nr.	379490	Vergl.-Nr.	6226
Beschreibung	Temperaturfühler PTC Kabel Silikon Fühler -50 bis +150°C Kabel -50 bis +180°C Anschluss 2-adrig Gewinde Fühler ø6x40mm Kabellänge 1.2m		

			
1			
GEV-Nr.	402508	Vergl.-Nr.	1561
Beschreibung	Platine L 100mm B 60mm mit Taste Versorgung 240VAC		

			
1			
GEV-Nr.	402506	Vergl.-Nr.	6682
Beschreibung	Platine L 135mm B 100mm Versorgung 230VAC		

Hall-Sensoren

			
1			
GEV-Nr.	402550	Vergl.-Nr.	3418
Beschreibung	Hall-Sensor L 16mm B 16mm H 10mm für Flowmeter		

			
1			
GEV-Nr.	402498	Vergl.-Nr.	7389
Beschreibung	Platine L 140mm B 80mm Versorgung 230VAC		

Elektroniken

Platinen

			
1			
GEV-Nr.	402513	Vergl.-Nr.	6683
Beschreibung	Display L 150mm B 98mm		

			
1			
GEV-Nr.	402499	Vergl.-Nr.	7522
Beschreibung	Platine L 140mm B 80mm Versorgung 230VAC		

			
1			
GEV-Nr.	402536	Vergl.-Nr.	6263
Beschreibung	Platine L 178mm B 100mm Dosierer Versorgung 230VAC		



1

GEV-Nr.	402493	Vergl.-Nr.	1584 1585
Beschreibung	Platine L 200mm B 100mm mit Tastaturplatine Versorgung 230VAC		



1

GEV-Nr.	402505	Vergl.-Nr.	4850
Beschreibung	Platine L 200mm B 100mm Versorgung 230VAC		



1

GEV-Nr.	402510	Vergl.-Nr.	2948
Beschreibung	Platine L 80mm B 55mm Versorgung 24VAC		



1

GEV-Nr.	402511	Vergl.-Nr.	5067
Beschreibung	Platine L 80mm B 55mm Versorgung 24VAC		



1

GEV-Nr.	402522	Vergl.-Nr.	7390
Beschreibung	Tastaturplatine L 154mm B 49mm Tasten 5		



1

GEV-Nr.	402520	Vergl.-Nr.	1485
Beschreibung	Tastaturplatine L 31mm B 27mm Tasten 1		

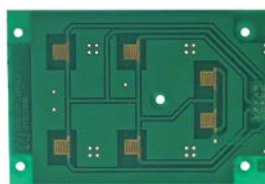

1

GEV-Nr.	402521	Vergl.-Nr.	6001
Beschreibung	Tastaturplatine L 94mm B 64mm Tasten 6		

Zentraleinheiten



1

GEV-Nr.	402538	Vergl.-Nr.	6381
Beschreibung	Zentraleinheit 24V 5A		



1

GEV-Nr.	402512	Vergl.-Nr.	4951
Beschreibung	Zentraleinheit mit Display		

Dosierelektroniken

GICAR

Gruppe 5



1			
GEV-Nr.	403207	Vergl.-Nr.	N/A
Beschreibung	Dosierelektronik 230V Spannung AC 50/60Hz 10A Typ DOS 30/2GR+LIV		

GIEMME



1			
GEV-Nr.	402533	Vergl.-Nr.	2473
Beschreibung	Dosierelektronik 230V 50/60Hz 8A Typ RL0 2GR+RL/F		



1			
GEV-Nr.	402534	Vergl.-Nr.	3200
Beschreibung	Dosierelektronik 230V 50/60Hz 5-10A Typ RL2 4GR+RL+THE/F-C		

Tastaturen

Frontfolien



1			
GEV-Nr.	402529	Vergl.-Nr.	1518
Beschreibung	Tastaturfolie Kaffeemaschine für Gerät Super 3000 L 193mm B 60mm Tasten 5		



1			
GEV-Nr.	400499	Vergl.-Nr.	1521
Beschreibung	Tastaturfolie L 110mm B 38mm Tasten 5		



1			
GEV-Nr.	400500	Vergl.-Nr.	2475
Beschreibung	Tastaturfolie L 110mm B 38mm Tasten 5		



1			
GEV-Nr.	402531	Vergl.-Nr.	4643
Beschreibung	Tastaturfolie L 110mm B 38mm Tasten 5		



1			
GEV-Nr.	402530	Vergl.-Nr.	1519
Beschreibung	Tastaturfolie L 193mm B 59mm Tasten 1		

Folientastaturen



1			
GEV-Nr.	403677	Vergl.-Nr.	08500
Beschreibung	Folientastatur für Espresso-Maschine für Gerät S5/S5 COMPACT Tasten 5 L 75mm B 32mm		



1			
GEV-Nr.	402523	Vergl.-Nr.	5805
Beschreibung	Folientastatur L 108mm B 48mm		



1			
GEV-Nr.	402524	Vergl.-Nr.	6308
Beschreibung	Folientastatur L 135mm B 100mm		

Tastatureinheiten



1			
GEV-Nr.	402514	Vergl.-Nr.	1605
Beschreibung	Tastatureinheit Tasten 1 Beleuchtung rot L 70mm B 48mm		



1	GEV-Nr. 402516	Vergl.-Nr.	1598
Beschreibung Tastatureinheit Tasten 5 L 118mm B 43mm			



1	GEV-Nr. 402518	Vergl.-Nr.	2474
Beschreibung Tastatureinheit Tasten 5 L 118mm B 43mm			



1	GEV-Nr. 402519	Vergl.-Nr.	4848
Beschreibung Tastatureinheit Tasten 5 L 118mm B 43mm			

Zubehör



1	GEV-Nr. 347334	Vergl.-Nr.	6297
Beschreibung Drucktaste Außenmaß 28x40mm schwarz			



1	GEV-Nr. 402527	Vergl.-Nr.	7396
Beschreibung Tastenleiste Tasten 5 L 154mm B 31mm			



1	GEV-Nr. 402528	Vergl.-Nr.	7397
Beschreibung Tastenleiste Tasten 5 L 154mm B 31mm			



1	GEV-Nr. 402526	Vergl.-Nr.	7395
Beschreibung Tastenleiste Tasten 5 L 156mm B 31mm			



1	GEV-Nr. 402525	Vergl.-Nr.	5498
Beschreibung Tastenleiste Tasten 5 L 88mm B 64mm			

Magnetventile

Magnetventile Wasser

TP

Magnetventile mit Reduzierung



1	GEV-Nr. 370427	Vergl.-Nr.	3345
Beschreibung Magnetventil 1-fach gewinkelt 230VAC Eingang 3/4" Ausgang 11,5mm Eingangl/min Ausgang 1.2l/min DN10 T.max. 90°C TP Kunststoff Reduzierung Ausgang dunkelbraun			

Metall

ASCO

Ersatzteile und Zubehör

O-Ringe





1	GEV-Nr. 371095	Vergl.-Nr.	625
Beschreibung O-Ring Viton Materialstärke 1.78mm ID ø 6.07mm VPE 1 Stück			

LUCIFER

3-Wege





Serie 131F





1	GEV-Nr. 370053	Vergl.-Nr.	628
Beschreibung Magnetventil 3-Wege 230VAC DN 2.5mm Steckbuchse DIN -10 bis +140°C Serie 131F Spulentyp DZ06S6 Membrane FKM(Wasser/ Dampf) p max 10bar Flansch 32x32mm			
Ersatzteile für 370053			
	GEV-Nr. 370061	Vergl.-Nr.	626
Magnetventilkörper LUCIFER-PARKER 3-Wege Außenkonus			

Tabellenfortsetzung auf der nächsten Seite



Ersatzteile für	370053			
	GEV-Nr.	371031	Vergl.-Nr.	—
	Magnetspule LUCIFER-PARKER 230VAC 9VA Spulentyp DZ06S6 Aufnahme ø 15mm			
Zubehör für	370053			
	GEV-Nr.	371090	Vergl.-Nr.	—
	Steckdose Steckertyp DIN 43650A Schraubanschluss			
	GEV-Nr.	371095	Vergl.-Nr.	625
	O-Ring Viton Materialstärke 1.78mm ID ø 6.07mm VPE 1 Stück			
	GEV-Nr.	371100	Vergl.-Nr.	—
	O-Ring Silikon Materialstärke 1.78mm ID ø 6.07mm VPE 1 Stück			

Ersatzteile und Zubehör			
Ventilkörper			
	1		
GEV-Nr.	370061	Vergl.-Nr.	626
Beschreibung	Magnetventilkörper LUCIFER-PARKER 3-Wege Außenkonus		

ODE			
Magnetventile Dampf (Wasser)			
Serie 21A			
	1		
GEV-Nr.	370582	Vergl.-Nr.	4843
Beschreibung	Magnetventil Messing 2-Wege 24VAC Eingang 1/4" Ausgang 1/4" Anschluss 1/4" L 40mm DN 5.5mm -10 bis +140°C ODE Spulentyp BDA Membrane FKM(Wasser/Dampf) p max 3bar 50/60Hz		

Serie 31A1			
	1		
GEV-Nr.	370583	Vergl.-Nr.	1379
Beschreibung	Magnetventil Messing 3-Wege 24VAC DN 1.5mm -10 bis +140°C ODE Serie 31A1 Spulentyp BDA Membrane Rubin p max 15bar p min 0bar Flansch 32x32mm 24V Spannung AC		

PARKER			
2-Wege			
Serie 7121			
	1		
GEV-Nr.	370584	Vergl.-Nr.	907
Beschreibung	Magnetventil CNS 230VAC Eingang 1/8" Ausgang 1/8" Anschluss 1/8" DN 1.5mm Spulentyp BDA p max 15bar 50Hz Eingang 1/8"mm		

Serie VE-146				
	1			
GEV-Nr.	370067	Vergl.-Nr.	6478	
Beschreibung	Magnetventil 2-Wege 230VAC Anschluss 1/4" L 40mm DN 3mm Steckbuchse DIN -20° bis +130°C PARKER Serie VE-146 Spulentyp ZB09 Membrane FKM (Wasser) p max 7bar			
Ersatzteile für	370067			
	GEV-Nr.	371029	Vergl.-Nr.	—
	Magnetspule PARKER 230VAC 9VA Spulentyp ZB09 Aufnahme ø 14mm H 33mm B 34mm T 43mm			
Zubehör für	370067			
	GEV-Nr.	371090	Vergl.-Nr.	—
	Steckdose Steckertyp DIN 43650A Schraubanschluss			

Magnetventilzubehör			
	1		
GEV-Nr.	371095	Vergl.-Nr.	625
Beschreibung	O-Ring Viton Materialstärke 1.78mm ID ø 6.07mm VPE 1 Stück		

Elektroden			
	1		
GEV-Nr.	402554	Vergl.-Nr.	6357
Beschreibung	Niveauelektrode 1/4" Gesamtlänge 105mm Fühler L 87mm Fühlerlänge isoliert 74mm Anschluss gebogen ø 3mm		



1 

GEV-Nr.	402555	Vergl.-Nr.	7852
Beschreibung	Niveauelektrode 1/4" Gesamtlänge 130mm Fühler L 110mm Fühlerlänge isoliert 105mm Anschluss gebogen ø 3mm		

1 

GEV-Nr.	400020	Vergl.-Nr.	911
Beschreibung	Niveauelektrode 1/4" Gesamtlänge 150mm Fühler L 124mm Fühlerlänge isoliert 26mm Anschluss Flachstecker 6,3mm Edelstahl ø 2,5mm		

1 

GEV-Nr.	402553	Vergl.-Nr.	911
Beschreibung	Niveauelektrode 1/4" Gesamtlänge 155mm Fühler L 136mm Fühlerlänge isoliert 124mm Anschluss gebogen ø 3mm		

1 

GEV-Nr.	402556	Vergl.-Nr.	6368
Beschreibung	Niveauelektrode Gesamtlänge 303mm Anschluss gebogen CNS ø 3mm		

1 

GEV-Nr.	402550	Vergl.-Nr.	3418
Beschreibung	Hall-Sensor L 16mm B 16mm H 10mm für Flowmeter		

Pumpen

Pumpen für Eiswürfelmaschinen

1 

GEV-Nr.	500161	Vergl.-Nr.	2980
Beschreibung	Pumpe REBO Typ NR40 55W 230V 50Hz Ausgang ø 17mm L 110mm Laufrichtung links für Eiswürfelbereiter		
Ersatzteile für	500161		
	GEV-Nr.	500970	Vergl.-Nr. —
	Pumpenmotor 55W 230V 50Hz REBO L 205mm Typ Ausgang ømm passend für für Eisbereiter		

Sicherungen

Feinsicherungen

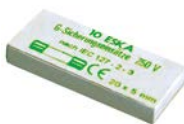
1 

GEV-Nr.	358605	Vergl.-Nr.	6249
Beschreibung	Feinsicherung Größe ø5x20mm 3.15A träge Nennspannung 250V VPE 10 Stück		

Flowmeter und Durchflusssensoren

Flowmeter

Sonstige

1 

GEV-Nr.	402542	Vergl.-Nr.	2498
Beschreibung	Flowmeter Gewinde 1/4" CNS		

Gerätespezifische Bauteile

für Barmixer

Blender

Becherkomponenten

Messer

Messer komplett



1

GEV-Nr. 696742 **Vergl.-Nr.** C0007F305

Beschreibung Messereinheit ø 52mm für Gerät P100/P102/P103/P105

für Eisbereiter

Ablaufsysteme

Überlaufrohre



1

GEV-Nr. 695083 **Vergl.-Nr.** 6120

Beschreibung Überlaufrohr ID ø 22mm D1 ø 27mm D2 ø 19mm L 144mm

für Espressomaschinen

Blenden



1

GEV-Nr. 692672 **Vergl.-Nr.** 01591

Beschreibung Seitenteil L 180mm H 67mm T 30 EP links für Gerät Super 3000



1

GEV-Nr. 692673 **Vergl.-Nr.** 01592

Beschreibung Seitenteil L 180mm H 67mm T 30 EP rechts für Gerät Super 3000

Siebträger

Siebträger Standard

Siebträger ohne Auslauf



1

GEV-Nr. 525986 **Vergl.-Nr.** N/A

Beschreibung Siebträger passend für SPAZIALE ohne Auslauf Befestigung ø 76mm Auslauf 3/8" ID ø 56mm Keilhöhe 12mm Keilposition horizontal Keilzahl 2 Hebel gerade

Siebträger kurz



1

GEV-Nr. 525165 **Vergl.-Nr.** 2891

Beschreibung Siebträger Befestigung ø 76mm Auslauf 3/8" ID ø 56mm Griff M12x1,25 Keilhöhe 12mm Keilposition horizontal Keilzahl 2 Hebel gerade Messing verchromt

Zubehör für 525165

GEV-Nr. 525127 **Vergl.-Nr.** 4962

Beschreibung Griff ø 25mm Gewinde M12x1,25 Gewinde L 12mm L 122mm schwarz Thermoplast



1

GEV-Nr. 529060 **Vergl.-Nr.** N/A

Beschreibung Siebträger Befestigung ø 76mm Auslauf 3/8" ID ø 56mm Griff M12x1,75 Keilhöhe 12mm Keilposition horizontal Keilzahl 2 Hebel gerade Messing verchromt

Zubehör für 529060

GEV-Nr. 529045 **Vergl.-Nr.** —

Beschreibung Griff ø 35mm Gewinde M12x1,75 Gewinde L 15mm L 125mm schwarz

Griffe

mit Außengewinde



1

GEV-Nr. 525127 **Vergl.-Nr.** 4962

Beschreibung Griff ø 25mm Gewinde M12x1,25 Gewinde L 12mm L 122mm schwarz Thermoplast

Hülsen



1

GEV-Nr.	525139	Vergl.-Nr.	4961 9924
Beschreibung	Hülse ø 36mm L 38mm schwarz		

Siebe

für 1 Tasse



1

GEV-Nr.	525156	Vergl.-Nr.	1945
Beschreibung	Kaffeeseib ø 65mm Einbau ø 55mm H 23.3mm Tassen 1 Kaffeemenge 6g		



1

GEV-Nr.	529029	Vergl.-Nr.	646
Beschreibung	Kaffeeseib ø 65mm Einbau ø 55mm H 25mm Tassen 1 Kaffeemenge 7g		

für 2 Tassen



1

GEV-Nr.	525155	Vergl.-Nr.	1943
Beschreibung	Kaffeeseib ø 65mm Einbau ø 55mm H 25.7mm Tassen 2 Kaffeemenge 12g		



1

GEV-Nr.	529030	Vergl.-Nr.	645
Beschreibung	Kaffeeseib ø 65mm Einbau ø 55mm H 27.5mm Tassen 2 Kaffeemenge 14g		

Blindfilter



1

GEV-Nr.	529064	Vergl.-Nr.	647
Beschreibung	Blindfilter ø 65mm Einbau ø 55mm H 25mm		

Siebträgerfedern



1

GEV-Nr.	529065	Vergl.-Nr.	649 7051
Beschreibung	Siebträgerfeder L 70mm B 60mm Drahtstärke ø 1.1mm für Espresso-Siebträger		

Brühgruppen

Duschensiebe

2-teilig



1

GEV-Nr.	529090	Vergl.-Nr.	2908+2909
Beschreibung	Duschensieb ø 51,6/49,1mm H 3,6/2,3mm Loch ø 5.5mm 2-teilig		

Siebträgerdichtungen

flach

Standard



1

GEV-Nr.	528086	Vergl.-Nr.	1939
Beschreibung	Siebträgerdichtung D1 ø 64.5mm D2 ø 52.5mm H 6.3mm VPE 1 Stück		



1

GEV-Nr.	528041	Vergl.-Nr.	1968
Beschreibung	Siebträgerdichtung D1 ø 64.5mm D2 ø 52.5mm H 6.65mm		





Brühgruppen manuell			
Einzelteile			
Hebel			
Zubehör			
			
1			
GEV-Nr.	525151	Vergl.-Nr.	618
Beschreibung	Bolzen mit Kugel ø 6mm L 12mm		

Magnete			
			
1			
GEV-Nr.	525122	Vergl.-Nr.	614
Beschreibung	Magnet Gewinde M5 für Magnetventil H 23mm AD ø 49mm ID ø 15mm		

Einzelteile			
Düsen			
ohne Gewinde			
			
1			
GEV-Nr.	525121	Vergl.-Nr.	276
Beschreibung	Düse Bohrung ø 0.57mm ø 5mm D1 ø 6.5mm L 10mm		

			
1			
GEV-Nr.	528888	Vergl.-Nr.	276
Beschreibung	Düse Bohrung ø 0.65mm ø 5mm D1 ø 6.5mm L 10mm		

Dichtungen			
			
1			
GEV-Nr.	529190	Vergl.-Nr.	1631
Beschreibung	O-Ring Viton Materialstärke 2.62mm ID ø 31.42mm VPE 1 Stück		

Sicherheitsventile			
Sicherheitsventile			
1/2"			
			
1			
GEV-Nr.	525125	Vergl.-Nr.	1932
Beschreibung	Sicherheitsventil Anschluss 1/2" Auslösedruck 1.7bar Zulassung CE 0036 plombiert		

3/8"			
			
1			
GEV-Nr.	529312	Vergl.-Nr.	381
Beschreibung	Sicherheitsventil Anschluss 3/8" Auslösedruck 1.8bar		

Expansionsventile			
mit Schlauchanschluss			
			
1			
GEV-Nr.	525123	Vergl.-Nr.	288
Beschreibung	Expansionsventil G1: 1/4" AG Schlauch ø 6.5mm Gesamtlänge 78mm		

			
1			
GEV-Nr.	525124	Vergl.-Nr.	1626
Beschreibung	Expansionsventil G1: 1/4" AG Schlauch ø 9mm Gesamtlänge 78mm		

Druckfedern			
			
1			
GEV-Nr.	525118	Vergl.-Nr.	292
Beschreibung	Druckfeder ø 14.3mm L 30.5mm Drahtstärke ø 2mm		

Ablaufwannen

Ablaufwannen



GEV-Nr.	525157	Vergl.-Nr.	1590
Beschreibung	Ablaufwanne L 100mm B 72mm H 75mm Schlauch ø 10/16mm Schlauchlänge 20/25mm		

Be- und Entlüfter



GEV-Nr.	527981	Vergl.-Nr.	508
Beschreibung	Be- und Entlüfter Anschluss 1/4"		

Dampf-/Wasserhähne

Dampf-/Wasserhähne

Dampf-/Wasserhähne



GEV-Nr.	525126	Vergl.-Nr.	217
Beschreibung	Dampf-/Wasserhahn Eingang 1/4" Ausgang 3/8" Achse 5x7 Achslänge 6mm Messing		



GEV-Nr.	529610	Vergl.-Nr.	216
Beschreibung	Dampf-/Wasserhahn Eingang 3/8" Ausgang 3/8" Achse 5x7 Achslänge 6mm Messing		

Dampfhähne

Diverses



GEV-Nr.	525154	Vergl.-Nr.	233
Beschreibung	Scheibe ø 8mm Materialstärke 1mm		

Dampf-/Wasserrohre

Dampfrohre



GEV-Nr.	529613	Vergl.-Nr.	1838
Beschreibung	Dampfrohr EP links		



GEV-Nr.	525133	Vergl.-Nr.	7546
Beschreibung	Dampfrohr EP links Gewinde 3/8" H 160mm Rohr ø 8mm Messing verchromt		



GEV-Nr.	525132	Vergl.-Nr.	4832
Beschreibung	Dampfrohr EP links Gewinde 3/8" H 180mm Rohr ø 8mm Messing verchromt		



GEV-Nr.	525116	Vergl.-Nr.	1838
Beschreibung	Dampfrohr EP links Gewinde 3/8" H 210mm Rohr ø 8mm Messing verchromt		



GEV-Nr.	525131	Vergl.-Nr.	4831
Beschreibung	Dampfrohr EP rechts Gewinde 3/8" H 180mm Rohr ø 8mm Messing verchromt		



1

GEV-Nr.	525117	Vergl.-Nr.	1839
Beschreibung	Dampfrohr EP rechts Gewinde 3/8" H 210mm Rohr ø 8mm Messing verchromt		



1

GEV-Nr.	529612	Vergl.-Nr.	1839
Beschreibung	Dampfrohr EP rechts Gewinde 3/8" H 210mm Rohr ø 8mm Messing verchromt		



1

GEV-Nr.	525159	Vergl.-Nr.	7832
Beschreibung	Dampfrohr Gewinde 3/8" H 160mm Rohr ø 10mm CNS		



1

GEV-Nr.	525158	Vergl.-Nr.	6591
Beschreibung	Dampfrohr Gewinde 3/8" H 170mm Rohr ø 10mm CNS		



1

GEV-Nr.	525130	Vergl.-Nr.	4473
Beschreibung	Dampfrohr Gewinde 3/8" H 180mm Rohr ø 10mm CNS		



1

GEV-Nr.	525129	Vergl.-Nr.	825
Beschreibung	Dampfrohr Gewinde 3/8" H 210mm Rohr ø 8mm Messing verchromt		

Wasserrohre



1

GEV-Nr.	525128	Vergl.-Nr.	2686
Beschreibung	Wasserrohr Gewinde 3/8" ø 25mm L 87mm Rohr ø 12mm SW 20 Messing verchromt		

Zubehör

Buchsen



1

GEV-Nr.	529705	Vergl.-Nr.	7579
Beschreibung	Buchse D1 ø 8.3mm D2 ø 12mm H 6mm Messing ID ø 7mm		

Dichtungen



1

GEV-Nr.	528402	Vergl.-Nr.	807
Beschreibung	O-Ring Viton Materialstärke 2.62mm ID ø 10.78mm VPE 1 Stück		

Federn



1

GEV-Nr.	525162	Vergl.-Nr.	5327
Beschreibung	Druckfeder ø 11.5mm L 19mm Drahtstärke ø 1.7mm Edelstahl		



1

GEV-Nr.	529704	Vergl.-Nr.	7568
Beschreibung	Druckfeder ø 11.8mm L 16mm Drahtstärke ø 1.6mm Stahl		

Sonstige



1

GEV-Nr.	528898	Vergl.-Nr.	523
Beschreibung	Unterlegscheibe ID ø 11.2mm AD ø 14.8mm Materialstärke 1mm CNS		

Überwurfmuttern



GEV-Nr.	528899	Vergl.-Nr.	524
Beschreibung	Überwurfmutter Gewinde 3/8" L 22mm Loch ø 12mm Messing		

Feinfilter

Feinfilter



GEV-Nr.	525161	Vergl.-Nr.	2284
Beschreibung	Feinfilter flach Gewebe ø 8mm H 1.5mm		



GEV-Nr.	528889	Vergl.-Nr.	275
Beschreibung	Feinfilter flach mit Rand ø 7mm		

Füllventile

Zubehör

Hebel



GEV-Nr.	111343	Vergl.-Nr.	1837
Beschreibung	Hebel Gewinde M8 ø 18/22mm Kunststoff		

Niveauschaugläser

Niveauschaugläser

Dichtungen



GEV-Nr.	529427	Vergl.-Nr.	266
Beschreibung	Dichtung D1 ø 13mm D2 ø 17.5mm ID ø 11mm H 9mm Gummi Wasserstandsglas passend für PAVONI		



GEV-Nr.	525164	Vergl.-Nr.	265
Beschreibung	Dichtung D1 ø 14mm D2 ø 17mm ID ø 10.78mm H 9mm Silikon		



GEV-Nr.	525163	Vergl.-Nr.	266
Beschreibung	Dichtung D1 ø 14mm D2 ø 17mm ID ø 10.8mm H 9mm Viton		

Schauglasrohre



GEV-Nr.	529404	Vergl.-Nr.	267 268
Beschreibung	Füllstandsrohr ø 11mm H 150mm ID ø 8mm		



GEV-Nr.	529405	Vergl.-Nr.	267 268
Beschreibung	Füllstandsrohr ø 11mm H 150mm ID ø 8mm		

Rückschlagventile

Dichtungen



GEV-Nr.	528425	Vergl.-Nr.	290
Beschreibung	Dichtung D1 ø 14.9mm D2 ø 6mm Gesamtlänge 8.9mm L1 4mm L2 4.9mm		

Druckfedern



GEV-Nr.	525119	Vergl.-Nr.	279
Beschreibung	Druckfeder ø 8mm L 28mm Drahtstärke ø 0.4mm		





Kolben			
			
1			
GEV-Nr.	528886	Vergl.-Nr.	280
Beschreibung	Ventil dreieckig ø 12mm L 22mm		

für Kaffeemühlen

Mahlscheiben			
Mahlscheiben konisch			
			
1			
GEV-Nr.	527705	Vergl.-Nr.	8785 C0004M122B
Beschreibung	Mahlscheibenpaar Drehrichtung rechts D1 ø 63mm D2 ø 40mm H 23.5mm Achse ø 13mm		

Knebel

Dampf-/Wasserhähne

Dampf-/Wasserhähne			
			
1			
GEV-Nr.	525135	Vergl.-Nr.	6037
Beschreibung	Drehgriff Dampf ø 52mm schwarz		
			
1			
GEV-Nr.	525134	Vergl.-Nr.	249
Beschreibung	Drehgriff ø 33mm Achse ø 6,5x8mm schwarz		
			
1			
GEV-Nr.	525136	Vergl.-Nr.	1558
Beschreibung	Drehgriff ø 46mm Achse ø 6,5x8mm schwarz		
			
1			
GEV-Nr.	525137	Vergl.-Nr.	4963
Beschreibung	Drehgriff ø 47mm Achse ø 6,5x8mm schwarz		

Knebelsymbole			
			
1			
GEV-Nr.	525138	Vergl.-Nr.	4959
Beschreibung	Hülse ø 53mm L 25mm schwarz		
			
1			
GEV-Nr.	525141	Vergl.-Nr.	6039
Beschreibung	Klemmring für Griff ø 22.4mm L 11mm schwarz		
			
1			
GEV-Nr.	525140	Vergl.-Nr.	5124
Beschreibung	Ring für Hahn ø 38mm L 13mm schwarz		
			
1			
GEV-Nr.	525115	Vergl.-Nr.	244
Beschreibung	Symbol Dampf ø 19mm		
			
1			
GEV-Nr.	525142	Vergl.-Nr.	3061
Beschreibung	Symbol Dampf ø 40mm L 16.5mm schwarz/gold		
			
1			
GEV-Nr.	525145	Vergl.-Nr.	4960
Beschreibung	Symbol Dampf ø 47mm L 26.5mm schwarz/gold		
			
1			
GEV-Nr.	525144	Vergl.-Nr.	3063
Beschreibung	Symbol Niveau ø 40mm L 16.5mm		
			
1			
GEV-Nr.	525143	Vergl.-Nr.	3062
Beschreibung	Symbol Wasser ø 40mm L 16.5mm		

Griffe und Handräder

Zylindergriffe

feststehend



1

GEV-Nr.	525160	Vergl.-Nr.	4916
Beschreibung	Zylindergriff Gewinde M6 Bohrung \emptyset konisch 12mm \emptyset 18mm L 40mm Thermoplast		

Hebel

mit Griff



1

GEV-Nr.	111343	Vergl.-Nr.	1837
Beschreibung	Hebel Gewinde M8 \emptyset 18/22mm Kunststoff		

Hebelgriffe



1

GEV-Nr.	525160	Vergl.-Nr.	4916
Beschreibung	Zylindergriff Gewinde M6 Bohrung \emptyset konisch 12mm \emptyset 18mm L 40mm Thermoplast		

Dichtungen

O-Ringe

EPDM

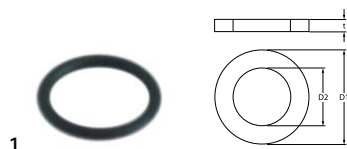

1

GEV-Nr.	529545	Vergl.-Nr.	5328
Beschreibung	O-Ring EPDM Materialstärke 1.78mm ID \emptyset 10.82mm VPE 1 Stück		

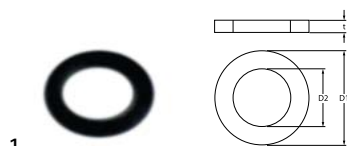

1

GEV-Nr.	528485	Vergl.-Nr.	586
Beschreibung	O-Ring EPDM Materialstärke 1.78mm ID \emptyset 6.07mm VPE 1 Stück		

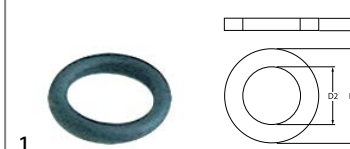

1

GEV-Nr.	529412	Vergl.-Nr.	1472
Beschreibung	O-Ring EPDM Materialstärke 2.62mm ID \emptyset 10.78mm VPE 1 Stück		

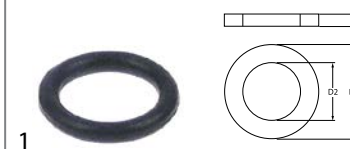

1

GEV-Nr.	525608	Vergl.-Nr.	7580
Beschreibung	O-Ring EPDM Materialstärke 2.7mm ID \emptyset 12.1mm		

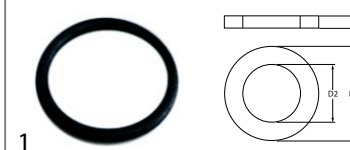

1

GEV-Nr.	361080	Vergl.-Nr.	08289
Beschreibung	O-Ring EPDM Materialstärke 2mm ID \emptyset 16mm VPE 1 Stück		

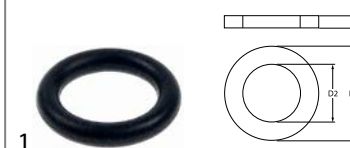

1

GEV-Nr.	361085	Vergl.-Nr.	281
Beschreibung	O-Ring EPDM Materialstärke 2mm ID \emptyset 8mm VPE 1 Stück		

Silikon



1

GEV-Nr.	528222	Vergl.-Nr.	1470
Beschreibung	O-Ring Silikon Materialstärke 2.62mm ID \emptyset 10.78mm VPE 1 Stück		

Viton



1

GEV-Nr.	528833	Vergl.-Nr.	1470
Beschreibung	O-Ring Viton Materialstärke 1.78mm ID \emptyset 11.11mm VPE 1 Stück		



GEV-Nr.	528687	Vergl.-Nr.	219
Beschreibung	O-Ring Viton Materialstärke 1.78mm ID \varnothing 3.69mm VPE 1 Stück		

GEV-Nr.	528647	Vergl.-Nr.	1468
Beschreibung	O-Ring Viton Materialstärke 2.62mm ID \varnothing 15.08mm VPE 1 Stück		

GEV-Nr.	371095	Vergl.-Nr.	625
Beschreibung	O-Ring Viton Materialstärke 1.78mm ID \varnothing 6.07mm VPE 1 Stück		

GEV-Nr.	528293	Vergl.-Nr.	1471
Beschreibung	O-Ring Viton Materialstärke 2.62mm ID \varnothing 15.88mm VPE 1 Stück		

GEV-Nr.	528282	Vergl.-Nr.	281
Beschreibung	O-Ring Viton Materialstärke 1.78mm ID \varnothing 7.66mm VPE 1 Stück		

GEV-Nr.	532560	Vergl.-Nr.	225
Beschreibung	O-Ring Viton Materialstärke 2.62mm ID \varnothing 20.63mm VPE 1 Stück		

GEV-Nr.	528246	Vergl.-Nr.	1469
Beschreibung	O-Ring Viton Materialstärke 1.78mm ID \varnothing 8.73mm VPE 1 Stück		

GEV-Nr.	529190	Vergl.-Nr.	1631
Beschreibung	O-Ring Viton Materialstärke 2.62mm ID \varnothing 31.42mm VPE 1 Stück		

GEV-Nr.	528402	Vergl.-Nr.	807
Beschreibung	O-Ring Viton Materialstärke 2.62mm ID \varnothing 10.78mm VPE 1 Stück		

GEV-Nr.	525146	Vergl.-Nr.	7418
Beschreibung	O-Ring Viton Materialstärke 2.62mm ID \varnothing 42.52mm VPE 1 Stück		

GEV-Nr.	528291	Vergl.-Nr.	1472
Beschreibung	O-Ring Viton Materialstärke 2.62mm ID \varnothing 11.91mm VPE 1 Stück		

GEV-Nr.	525147	Vergl.-Nr.	4553
Beschreibung	O-Ring Viton Materialstärke 3.53mm ID \varnothing 142.5mm VPE 1 Stück		

GEV-Nr.	510243	Vergl.-Nr.	02418
Beschreibung	O-Ring Viton Materialstärke 3.53mm ID \varnothing 55.56mm VPE 1 Stück		

Sonstige

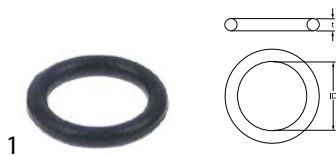

GEV-Nr.	525608	Vergl.-Nr.	7580
Beschreibung	O-Ring EPDM Materialstärke 2.7mm ID ø 12.1mm		

Dichtungsringe

Fiberdichtungen



GEV-Nr.	525149	Vergl.-Nr.	899
Beschreibung	Flachdichtung Fiber AD ø 93mm ID ø 81mm Materialstärke 2mm für Boiler VPE 1 Stück		

Graphitdichtungen



GEV-Nr.	528016	Vergl.-Nr.	N/A
Beschreibung	Flachdichtung Graphit AD ø 62mm ID ø 50mm Materialstärke 2mm VPE 1 Stück		

PTFE-Dichtungen



GEV-Nr.	528885	Vergl.-Nr.	424
Beschreibung	Flachdichtung PTFE AD ø 26mm ID ø 17mm Materialstärke 2mm VPE 1 Stück passend für SPAZIALE		



GEV-Nr.	528683	Vergl.-Nr.	225
Beschreibung	Flachdichtung PTFE AD ø 26mm ID ø 21mm Materialstärke 2mm VPE 1 Stück passend für GAGGIA, SPAZIALE		



GEV-Nr.	528131	Vergl.-Nr.	405
Beschreibung	Flachdichtung PTFE AD ø 52mm ID ø 40mm Materialstärke 2mm VPE 1 Stück		



GEV-Nr.	528149	Vergl.-Nr.	405
Beschreibung	Flachdichtung PTFE AD ø 85mm ID ø 72mm Materialstärke 2mm VPE 1 Stück passend für SPAZIALE		

Vitondichtungen



GEV-Nr.	528686	Vergl.-Nr.	00221
Beschreibung	Dichtung Viton AD ø 15mm ID ø 6mm Materialstärke 3.5mm VPE 1 Stück		

Spezialdichtungen

Gruppendichtungen



GEV-Nr.	528147	Vergl.-Nr.	N/A
Beschreibung	Gruppendichtung		



GEV-Nr.	525148	Vergl.-Nr.	485
Beschreibung	Dichtung AD ø 34mm ID ø 18mm H 6.3mm		

Federn

Druckfedern



GEV-Nr.	525162	Vergl.-Nr.	5327
Beschreibung	Druckfeder ø 11.5mm L 19mm Drahtstärke ø 1.7mm Edelstahl		



			
1			
GEV-Nr.	529704	Vergl.-Nr.	7568
Beschreibung	Druckfeder ø 11.8mm L 16mm Drahtstärke ø 1.6mm Stahl		

			
1			
GEV-Nr.	525118	Vergl.-Nr.	292
Beschreibung	Druckfeder ø 14.3mm L 30.5mm Drahtstärke ø 2mm		

			
1			
GEV-Nr.	525120	Vergl.-Nr.	223
Beschreibung	Druckfeder ø 14.4mm L 26mm Drahtstärke ø 1.8mm		

			
1			
GEV-Nr.	528684	Vergl.-Nr.	223
Beschreibung	Druckfeder ø 14.5mm L 33mm Drahtstärke ø 2.1mm		

			
1			
GEV-Nr.	528475	Vergl.-Nr.	292
Beschreibung	Druckfeder ø 14.7mm L 33mm Drahtstärke ø 2mm		

			
1			
GEV-Nr.	528257	Vergl.-Nr.	522
Beschreibung	Druckfeder ø 15mm L 17mm Drahtstärke ø 1.8mm		

			
1			
GEV-Nr.	528894	Vergl.-Nr.	1624
Beschreibung	Druckfeder ø 21.7mm L 40mm Drahtstärke ø 1.3mm		

			
1			
GEV-Nr.	528887	Vergl.-Nr.	1625
Beschreibung	Druckfeder ø 6.5mm L 13mm Drahtstärke ø 0.9mm		

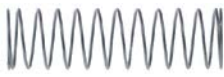
			
1			
GEV-Nr.	525119	Vergl.-Nr.	279
Beschreibung	Druckfeder ø 8mm L 28mm Drahtstärke ø 0.4mm		

			
1			
GEV-Nr.	528392	Vergl.-Nr.	279
Beschreibung	Druckfeder ø 8mm L 29mm Drahtstärke ø 0.5mm		

Manometer

			
1			
GEV-Nr.	541735	Vergl.-Nr.	1481
Beschreibung	Manometer Doppelskala ø 58mm Druckbereich 0-2,5 / 0-15bar Anschluss rückseitig Gewinde 1/8"		

			
1			
GEV-Nr.	541737	Vergl.-Nr.	5044
Beschreibung	Manometer Doppelskala ø 58mm Druckbereich 0-2,5 / 0-15bar Anschluss rückseitig Gewinde 1/8"		

			
1			
GEV-Nr.	541233	Vergl.-Nr.	N/A
Beschreibung	Manometer Doppelskala ø 60mm Druckbereich 0-2,5 / 0-15bar Anschluss rückseitig Gewinde 1/8"		



1

GEV-Nr.	541287	Vergl.-Nr.	N/A
Beschreibung	Manometer Doppelskala ø 60mm Druckbereich 0-2,5 / 0-15bar Anschluss rückseitig Gewinde 1/8"		



1

GEV-Nr.	541740	Vergl.-Nr.	6738
Beschreibung	Manometer ø 42mm Druckbereich 0-16bar Gewinde 1/8" Anschluss rückseitig		



1

GEV-Nr.	541410	Vergl.-Nr.	N/A
Beschreibung	Manometer Doppelskala ø 60mm Druckbereich 0-2,5 / 0-15bar Anschluss rückseitig Gewinde 1/8"		



1

GEV-Nr.	541739	Vergl.-Nr.	6237
Beschreibung	Manometer ø 42mm Druckbereich 0-2,5bar Gewinde 1/8" Anschluss rückseitig		



1

GEV-Nr.	541222	Vergl.-Nr.	N/A
Beschreibung	Manometer Doppelskala ø 60mm Druckbereich 0-2,5 / 0-16bar Anschluss rückseitig Gewinde 1/8"		



1

GEV-Nr.	541741	Vergl.-Nr.	6737
Beschreibung	Manometer ø 43mm Druckbereich 0-2,5bar Gewinde 1/8" Anschluss rückseitig		



1

GEV-Nr.	541226	Vergl.-Nr.	N/A
Beschreibung	Manometer Doppelskala ø 60mm Druckbereich 0-2,5 / 0-16bar Anschluss rückseitig Gewinde 1/8"		



1

GEV-Nr.	541738	Vergl.-Nr.	2047
Beschreibung	Manometer ø 58mm Druckbereich 0-2,5bar Anschluss rückseitig Markierung 1,35-2,5 Gewinde 1/4"		



1

GEV-Nr.	541227	Vergl.-Nr.	N/A
Beschreibung	Manometer Doppelskala ø 60mm Druckbereich 0-2,5 / 0-16bar Anschluss rückseitig Gewinde 1/8"		

Befestigungsmaterialien

Schrauben

Sechskantschrauben



1

GEV-Nr.	560274	Vergl.-Nr.	643
Beschreibung	Sechskantschraube Gewinde M5 Gewinde L 25mm CNS SW 8 ohne Schaft VPE 20 Stück DIN 933 / ISO 4017		



1

GEV-Nr.	541224	Vergl.-Nr.	N/A
Beschreibung	Manometer Doppelskala ø 63mm Druckbereich 0-2,5 / 0-15bar Anschluss rückseitig Gewinde 1/8"		





Zylinderkopfschrauben			
DIN 912/ISO 4762			
			
1			
GEV-Nr.	560025	Vergl.-Nr.	669
Beschreibung	Zylinderkopfschraube Gewinde M4 Gewinde L 10mm SW 3 CNS VPE 20 Stück DIN 912/ISO 4762		

Muttern			
Flügelmuttern			
			
1			
GEV-Nr.	560147	Vergl.-Nr.	4939
Beschreibung	Flügelmutter Gewinde M6 CNS DIN/ISO DIN 315 VPE 20 Stück		

Sechskantmuttern			
Sechskantmuttern Zoll			
			
1			
GEV-Nr.	503045	Vergl.-Nr.	07063
Beschreibung	Mutter Gewinde 1/4" H 4.5mm Messing SW 17 VPE 1 Stück		

Scheiben			
Unterlegscheiben			
DIN 125A			
			
1			
GEV-Nr.	560113	Vergl.-Nr.	1746 624
Beschreibung	Unterlegscheibe ID ø 6.4mm AD ø 12mm Materialstärke 1.6mm CNS VPE 20 Stück DIN 125A für Gewinde M6		

Sonstige			
			
1			
GEV-Nr.	528898	Vergl.-Nr.	523
Beschreibung	Unterlegscheibe ID ø 11.2mm AD ø 14.8mm Materialstärke 1mm CNS		

			
1			
GEV-Nr.	560413	Vergl.-Nr.	241
Beschreibung	Unterlegscheibe ID ø 17mm AD ø 25mm Materialstärke 0.8mm CNS		

			
1			
GEV-Nr.	560412	Vergl.-Nr.	1131
Beschreibung	Unterlegscheibe ID ø 5mm AD ø 8mm Materialstärke 1mm Messing		

Befestigungen			
Sicherungsringe			
DIN 472			
			
1			
GEV-Nr.	525153	Vergl.-Nr.	487
Beschreibung	Sicherungsring Bohrung ø 32mm Materialstärke 1.1mm DIN 472		

DIN 6799			
			
1			
GEV-Nr.	518557	Vergl.-Nr.	634
Beschreibung	Sicherungsring E D1 ø 5mm D2 ø 11mm CNS DIN 6799 Stärke 0.7mm		

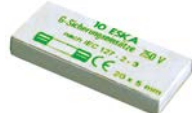
Verbrauchsgüter			
Sicherungen			
Feinsicherungen			
			
1			
GEV-Nr.	358605	Vergl.-Nr.	6249
Beschreibung	Feinsicherung Größe ø5x20mm 3.15A träge Nennspannung 250V VPE 10 Stück		

A			
Anlege-Sicherheitsthermostate	5	Sechskantmüttern	27
Anlegethermostate	5	Sechskantschrauben	26
B		Sicherheitsthermostate	5
Befestigungen	27	Sicherungen	14, 27
Befestigungsmaterialien	26	Sicherungsringe	27
D		Signallampen	8
Dichtungsringe	24	Signallampen komplett	8
Drehschalter	7	Systemschalter ROLD	6
Druckschalter/-taster	6	T	
E		Thermostate	5
Elektroden	13	U	
F		Unterlegscheiben	27
Feinsicherungen	27	V	
Flowmeter	14	Verbrauchsgüter	27
Flügelmüttern	27	W	
Fühler	8	Wippenschalter/-taster	5
H		Z	
Hall-Sensoren	9	Zylinderkopfschrauben	27
Heizkörper	3		
Heizkörper für Kaffeemaschinen	3		
Heizkörper für Kontaktgrills	4		
L			
Lampen	8		
M			
Magnetschalter	7		
Magnetventile	12		
Mikroschalter	6		
Müttern	27		
O			
O-Ringe	22		
P			
Pumpen	14		
Pumpen für Eiswürfelmaschinen	14		
R			
Regelthermostate	5		
Relais	8		
S			
Schalter und Taster	5		
Schrauben	26		
Schwimmerschalter	7		