



COMPOSANTS GAZ



COMPOSANTS ÉLECTRIQUES



TECHNIQUE DES EAUX



COMPOSANTS MÉCANIQUES



OUTILLAGE

Pièces détachées appropriées pour

MCC-TRADING-INTERNATIONAL

Consultez notre gamme complète et mise à jour dans notre webshop



Catalogue du fabricant

Les principaux accessoires et pièces de rechange sont regroupés de façon claire

- ✓ La gamme complète et l'ensemble des données de l'appareil sont constamment actualisés dans la boutique en ligne GEV
- ✓ Index alphabétique à la fin du catalogue

Boutique en ligne GEV

www.gev-online.fr
www.gev-online.ch
www.gev-online.com



- 🔍 Sélectionnez vos favoris
- 🔍 Connexion avec votre adresse mail et votre mot de passe
- 🔍 Commande en volume facilitée
- 🔍 Recherche sans login obligatoire



induction

bobines d'induction



1

référence	404010	ref. no.	AD100087
description	bobine d'induction ø 220mm H 10mm		
Pour modèles:	HIC3500		

résistances

résistances pour friteuses

fixation à 2 trous

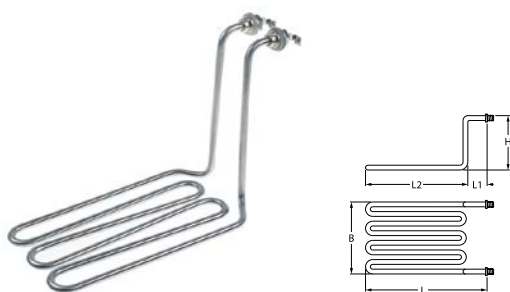

1

référence	417598	ref. no.	1.07.HDF4140403 GDF1104-013
description	résistance 2500W 230V circuits de chauffage 1 L 290mm lar. 130mm H 200mm L1 40mm L2 230mm tube ø 8mm		
Pour modèles:	HDF1104		

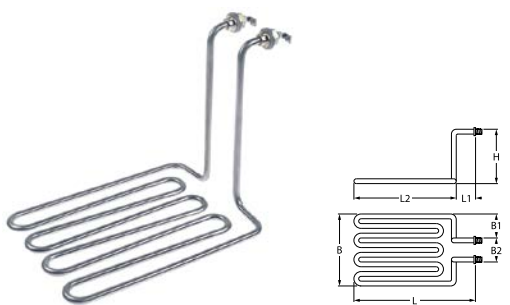

1

référence	417599	ref. no.	1.07.HDF8141903 HDF1108-013 HDF2128-013
description	résistance 3250W 230V circuits de chauffage 1 filetage M12x1,25 L 280mm lar. 190mm H 210mm L1 35mm L2 245mm B1 120mm B2 70mm tube ø 8mm raccord M4		
Pour modèles:	HDF1108, HDF2128		

résistances réfrigération

résistances de dégivrage



1

référence	420518	ref. no.	C01AA46A0007
description	résistance 500W 220V L 290mm lar. 96mm H 88mm longueur de câble 400mm tube ø 8.5mm		
Pour modèles:	RN700		

autres



1

référence	420491	ref. no.	E24075121000
description	résistance 20W 230V L 225mm lar. 195mm H 2.5mm raccord connecteur longueur de câble 1000mm		
Pour modèles:	RN700		

cordons chauffants

connection bilatérale

avec cosses mâles



1

référence	420492	ref. no.	E24075104400
description	cordon chauffant 10W 230V L 4400mm L1 (non chauffant) 500mm L2 (chauffant) 3900mm		
Pour modèles:	RC700, RN700		

résistances circulaires



1

référence	419243	ref. no.	RES30033	
description	résistance 2700W 230V circuits de chauffage 1 int. ø 180mm ø ext. 193mm L 208mm H 30mm L1 8mm B1 30mm H1 7mm H2 23mm longueur de bride 70 distribution interdite en Francem largeur de bride 22mm dist.trou 56mm raccord cosse mâle 6,3mm tube ø 6.3mm résistance circulaire trou ø 5mm bride rectangulaire 70 x 22mm avec vis			
Pour modèles:	HCO500			
pièces détachées	419243			
	référence	560102	ref. no.	—
		vis tôles ø 3.9mm L 9.5mm inox Q 20 pc DIN 7981/ISO 7049 tête ø 7.5mm tête goutte-de-suif		



thermostats

thermostats contact

thermostats contact



référence	390634	ref. no.	TER30002
description	thermostat contact dist.trou 23.5mm temp. déconnexion 145°C 1NC 1-pôles 16A 250V raccord F6,3 fixation à 2 trous		
Pour modèles:	HCO500		



référence	391010	ref. no.	E31A25001000
description	thermostat contact dist.troumm temp. déconnexion 25°C NC 1-pôles 16A 230V raccord connecteur codé		
Pour modèles:	RN700		

thermostats de réglage et de sécurité

EGO

thermostats de réglage

série 55.17_

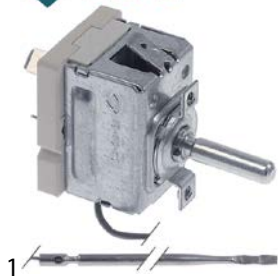

référence	391048	ref. no.	TER30016
description	thermostat t.max. 292°C 1-pôles 1NO sonde ø 3mm sonde L 182mm axe ø 6x4,6mm axe L 23mm positionnement de l'axe en haut° angle de rotation 270° matériel de sonde inox avec accessoires d'installation		
Pour modèles:	HCO500		

divers

thermostats de réglage



référence	390968	ref. no.	1.06.1851713 GDF1104-018 HDF1108-018 HDF2128-018
description	thermostat de contrôle t.max. 185°C temp. d'utilisation°C 2-pôles 1NO 16A sonde ø 6mm sonde L 77mm tube capillaire 1500mm tube capillaire isolémm presse étoupe axe ø 6x4,6mm axe L 25mm position de l'axe en haut angle de rotation 270° matériel de sonde inox		
Pour modèles:	HDF1104, HDF1108, HDF2128		

thermostats de sécurité



référence	390970	ref. no.	1.06.230171301 GDF1104-005 HDF1108-005 HDF2128-005
description	thermostat de sécurité temp. déconnexion 230°C 2-pôles 1NC 16A sonde ø 5mm sonde L 48mm tube capillaire 440mm tube capillaire isolé 150mm presse étoupe sonde 250V modèle WQS-230		
Pour modèles:	HDF1104, HDF1108, HDF2128		

thermostats froid

RANCO

série K50



référence	376068	ref. no.	A0804000066
description	thermostat RANCO type K50-L3459 sonde ø 2mm sonde L 110mm tube capillaire 1500mm		
Pour modèles:	HSC300N, HSC300N-Silver		



autres fabricants



référence	390997	ref. no.	DQWA0002 HSC350-18
description	thermostat sonde ø 3.4mm sonde Lmm tube capillaire 770mm type WPF11-L pour réfrigérateur 1NO 230V 50/60Hz		
Pour modèles:	HSC350, HSC350B, HSC350DD, HSC350G, HSC350GB		



référence	390972	ref. no.	DQWA0010 HSC360-37
description	thermostat temp. d'utilisation°C sonde ø 10mm sonde L 24mm tube capillaire 660mm type WPF-45270 dist.trou 55mm		
Pour modèles:	HSC360, HSC360B, HSC360G, HSC360GB		

accessoires

divers



référence	698980	ref. no.	B1301080407
description	bouton pour thermostat trou ø 6x4,6mm épaisseur 6.25mm ø 23.5mm		
Pour modèles:	HSC300N, HSC300N-Silver		

interrupteurs et boutons-poussoirs

interrupteurs/poussoirs à bascule

28x10mm



référence	347804	ref. no.	DQKC0000 HBC1002-22 HBC2003-22
description	interrupteur à bascule dimensions de montage 28x10mm rouge 1NO 250V 15A 0-I raccord cosse mâle 6,3mm température ambiante max. 85°C protection IP40		

30x11mm



référence	347350	ref. no.	A0910000001
description	interrupteur à bascule dimensions de montage 30x11mm noir 1CO 250V 16A I O raccord cosse mâle 6,3mm température ambiante max. 90°C protection IP40		
Pour modèles:	HSC300N, HSC300N-Silver		

30x22mm



référence	347791	ref. no.	1.1.A.A07.10 E2301GR00001
description	interrupteur à bascule dimensions de montage 30x22mm vert 2NO 230V 20A lumineux 0-I raccord cosse mâle 6,3mm température ambiante max. 125/55°C protection IP65 avec protection en caoutchouc		
Pour modèles:	HCV1100, HSA2600, RC700, RN700		

ø20mm



référence	347803	ref. no.	DQKA0000 HSC800-37
description	interrupteur à bascule dimensions de montage 20mm rouge 1NO 250V 15A 0-I raccord cosse mâle 4,8mm température ambiante max. 85°C protection IP40		
Pour modèles:	GSC1100G, HSC350, HSC350B, HSC350DD, HSC350G, HSC350GB, HSC360, HSC360B, HSC360G, HSC360GB, HSC800, HSC800G		



référence	347802	ref. no.	HSC350-37
description	interrupteur à bascule encastrément ø 20mm rouge 1NO 250V 15A lumineux 0-I raccord cosse mâle 4,8mm température ambiante max. 85°C protection IP40		

interrupteurs et poussoirs

19x13mm



référence	348188	ref. no.	E2307BK00001
description	interrupteur à poussoir dimensions de montage 19x13mm noir 1NO 250V 10A raccord F4,8		
Pour modèles:	RC700, RN700		



ø22mm



1

référence	347819	ref. no.	1.05.053512HY57
description	bouton poussoir encastrément ø 22mm rouge/vert 1NO/1NC/voyant 240V 10A MARCHE-ARRÊT raccord à vis température ambiante max. 85°C protection IP65		
Pour modèles:	HVC1001		
accessoires pour	347819		
	référence	358007	ref. no. —
	capot protection dimension extérieure 33x53mm dimension intérieure 30x50mm H 23mm		

microrupteurs

actionnement par goupille

autres



1

référence	348187	ref. no.	HVS1000-47 YJS820-47
description	microrupteur 230V 1NO raccord câble 400mm L 58mm L1 38mm		

avec bouton-poussoir

interrupteurs avec fixation par encliquetage



1

référence	348173	ref. no.	A0910000006
description	microrupteur 230V 2.5A 1NO raccord F4,8 L 24x27mm dist. fix.mm type force de actionnement: 580g		
Pour modèles:	HSC300N, HSC300N-Silver		



1

référence	346772	ref. no.	E2306WH00001
description	microrupteur avec bouton-poussoir 250V 5A 1CO raccord cosse mâle 4,8mm L 24x27mm température ambiante max. 85°C force de actionnement: 160g		
Pour modèles:	RC700, RN700		

fins de course

METRO



1

référence	348088	ref. no.	1.05.035011HDFMS116 GDF1104-006 HDF1108-006 HDF2128-006
description	microrupteur 1NO 250V 16A L 41mm lar. 12mm H 44mm force de actionnement: 250g		
Pour modèles:	HDF1104, HDF1108, HDF2128		

microrupteurs magnétiques

M12x1



1

référence	348243	ref. no.	1.03.00010073
description	microrupteur magnétique filetage M12x1 1NO 36V tension AC/DC 0.5A raccord câble longueur de câble 950mm L 35mm modèle M12-2SPST-01		
Pour modèles:	HVC1001		



1

référence	348244	ref. no.	1.03.00010078
description	microrupteur magnétique filetage M12x1 1NO 36V tension AC/DC 0.5A raccord câble longueur de câble 950mm L 50mm modèle M12-2SPST-02		

accessoires

aimants



1

référence	348242	ref. no.	1.03.00010018
description	aimant ø 19.5mm H 2.8mm		



supports de aimant





			
1			
référence	348241	ref. no.	1.03.00010057
description	support de aimant avec aimant dimension intérieure 19.5mm H 14mm filetage M12 ø 24mm		
Pour modèles:	HVC1001		
pièces détachées	348241		
		référence	348242
		ref. no.	1.03.00010018
	aimant ø 19.5mm H 2.8mm		

lampes

voyants lumineux

voyants lumineux 2 pièces (lentille et élément)

éléments de signalisation pour type de douille RL

			
1			
référence	359818	ref. no.	IND30009
description	voyant lumineux 230V transparent raccord cosse mâle 6,3mm		
Pour modèles:	HCO500		
accessoires pour	359818		
		référence	359820
		ref. no.	—
	capuchon pour voyant lumineux jaune Q 1 pc ø 8mm		
		référence	359833
		ref. no.	—
	capuchon pour voyant lumineux rouge Q 1 pc ø 8mm		
		référence	359948
		ref. no.	—
	capuchon pour voyant lumineux transparent Q 1 pc ø 8mm		

voyants lumineux complets

ø14mm

ave culot à vis

			
1			
référence	360621	ref. no.	1.03.00020017 GDF1104-008 HDF1108-008 HDF2128-008
description	voyant lumineux ø 14mm jaune 220V raccord cosse mâle 4,8mm plastique		
Pour modèles:	HDF1104, HDF1108, HDF2128		

			
1			
référence	360622	ref. no.	1.03.00020013 GDF1104-009 HDF1108-009 HDF2128-009
description	voyant lumineux ø 14mm vert 220V raccord cosse mâle 4,8mm plastique		
Pour modèles:	HDF1104, HDF1108, HDF2128		

30x11mm

			
1			
référence	359160	ref. no.	A0914000016
description	voyant lumineux dimensions de montage 30x11mm 230V vert raccord cosse mâle 6,3mm rectangulaire résist.à la temp. 125°C		
Pour modèles:	HSC300N, HSC300N-Silver		

LED

barres LED

			
1			
référence	357257	ref. no.	DQLED007
description	barre LED L 1100mm lar. 14.4mm H 7.5mm 24VDC blanc nombre de lampes 36 longueur de câble 120mm		
Pour modèles:	HSC350DD, HSC350G, HSC350GB		

			
1			
référence	357256	ref. no.	DQLED008
description	barre LED L 1200mm lar. 14.4mm H 7.5mm 24VDC blanc nombre de lampes 42 longueur de câble 120mm		
Pour modèles:	GSC1100G, HSC360G, HSC360GB, HSC800G		



1

référence	357245	ref. no.	1.1.A.A01.09.65
description	barre LED L 344mm lar. 13mm H 13mmV blanc nombre de lampes 16 longueur de câble 1030mm		
Pour modèles:	HCV1100		



1

référence	357255	ref. no.	DQLED011
description	barre LED L 370mm lar. 14.4mm H 7.5mm 24VDC blanc nombre de lampes 18 longueur de câble 380mm		
Pour modèles:	HSC350DD, HSC350G, HSC350GB		



1

référence	357251	ref. no.	DQLED066 HBC1002-29
description	barre LED L 400mm lar. 12mm H 12mm 24V bleu nombre de lampes 30 longueur de câble 280mm		
Pour modèles:	HBC1002		



1

référence	357241	ref. no.	DQLED067 HBC2003-29
description	barre LED L 600mm lar. 11.5mm H 12.5mm 24V nombre de lampes 42 longueur de câble 285mm tension DC		
Pour modèles:	HBC2003, HBC2003G		

accessoires



1

référence	357246	ref. no.	1.1.A.A01.10.04
description	bloc d'alimentation primaire 85-265V secondaire 0.2A Q 1 pc		
Pour modèles:	HCV1100		

tubes fluorescents

tubes fluorescents

G5



1

référence	357156	ref. no.	DQDA0009
description	tube fluorescent douille G5 L 285mm 8W ø 16mm 230V T5/865 Q 1 pc		



1

référence	357148	ref. no.	DQDA0010
description	tube fluorescent douille G5 L 547mm 14W ø 16mm 230V T5/865 Q 1 pc		

G13



1

référence	357254	ref. no.	A0902000002
description	tube fluorescent douille G13 L 436mm 15W ø 25mm 230V Q 1 pc teinte de couleur 865		
Pour modèles:	HSC300N, HSC300N-Silver		



1

référence	357145	ref. no.	DQDA0012 HSC350-31
description	tube fluorescent douille G13 L 438mm 15W ø 27mm 230V Q 1 pc teinte de couleur 865		
Pour modèles:	HSC350, HSC350B		



1

référence	357146	ref. no.	DQDA0007 HSC350-24 HSC800-26
description	tube fluorescent douille G13 L 895mm 30W ø 26mm 230V T8/765 Q 1 pc		
Pour modèles:	HSC350, HSC350B, HSC800		



accessoires

douilles



référence	381413	ref. no.	HSC350-28 HSC360-28 SLZA2000
description	douille douille G13 L 37.5mm lar. 28.5mm Q 1 pc pour tubes fluorescents		
Pour modèles:	HSC350, HSC350B, HSC360, HSC360B, HSC800		



référence	381169	ref. no.	HSC800-30 SLJY2010
description	support lampe douille G13 L 26.5mm lar. 24.5mm Q 1 pc pour tubes fluorescents		
Pour modèles:	HSC800		



référence	381412	ref. no.	A0905000002
description	support lampe douille G13 L 26.5mm lar. 24.5mm Q 1 pc pour tubes fluorescents		
Pour modèles:	HSC300N, HSC300N-Silver		

douilles starter



référence	381170	ref. no.	HSC350-34 HSC360-08 HSC800-35 SLZA1000
description	douille starter L 32mm lar. 24mm corps ø 23mm Q 1 pc		
Pour modèles:	HSC350, HSC350B, HSC360, HSC360B, HSC800		

starter



référence	380464	ref. no.	A0909000002 DQDF0000 HSC350-33 HSC360-09
description	starter 4-65W		
Pour modèles:	HSC300N, HSC300N-Silver, HSC350, HSC350B, HSC360, HSC360B, HSC800		

ballasts



référence	403690	ref. no.	A0908000001
description	ballast 15W 220-240V raccord borne à vis pour tubes fluorescents type 9.26.53.315 Q 1 pc		
Pour modèles:	HSC300N, HSC300N-Silver		



référence	403192	ref. no.	DQZB0005
description	ballast 15W 220-240V raccord borne à vis pour tubes fluorescents type JF-1595M Q 1 pc		





référence	403190	ref. no.	DQZA0027 HSC800-31
description	ballast 30W 220-240V raccord borne à vis pour tubes fluorescents type JF-3095W Q 1 pc		





référence	358134	ref. no.	DQZA0024 HSC360-06
description	ballast 76W 230V raccord borne à vis pour tubes fluorescents type JF-1595W Q 1 pc		
Pour modèles:	HSC360, HSC360B, HSC800		

			
1			
référence	403191	ref. no.	DQZB0029
description	ballast 9W 220V raccord borne à vis pour tubes fluorescents type JF-995M Q 1 pc		

capots			
			
1			
référence	694870	ref. no.	HSC350-23 SLJY2016
description	boîtier L 131.5mm lar. 45mm H 40mm		
Pour modèles:	HSC350, HSC350B		

			
1			
référence	551330	ref. no.	B1301010379
description	capot L 43mm lar. 30mm H 38mm capot		
Pour modèles:	HSC300N, HSC300N-Silver		

			
1			
référence	698982	ref. no.	B1301000176
description	capot L 457mm lar. 45mm H 38mm transparent		
Pour modèles:	HSC300N, HSC300N-Silver		

			
1			
référence	699314	ref. no.	SLZV0017
description	capot L 510mm lar. 30mm H 30mm		

			
1			
référence	694873	ref. no.	HSC350-40 SLSE2008
description	capot L 590mm lar. 280mm H 1mm		
Pour modèles:	HSC350, HSC350DD, HSC350G		

			
1			
référence	699312	ref. no.	SLZV0018
description	capot L 810mm lar. 30mm H 30mm transparent		
Pour modèles:	HBC1002		

			
1			
référence	694874	ref. no.	HSC350-38 SLZQ0037
description	capot set pos. de montage à droite et à gauche lar. 82mm H 280mm P 34		
Pour modèles:	GSC1100G, HSC350, HSC350DD, HSC350G, HSC800, HSC800G		
pièces détachées	694874		
	référence	692393	ref. no. —
	panneau pour capot pos. de montage à droite lar. 82mm H 280mm P 34mm plastique Q 1 pc		
	référence	692394	ref. no. —
	panneau pour capot pos. de montage à gauche lar. 82mm H 280mm P 34mm plastique Q 1 pc		

			
1			
référence	694872	ref. no.	HSC350-36 SLJV2040
description	capot support L 610mm lar. 20mm H 55mm pos. de montage en bas		
Pour modèles:	HSC350, HSC350DD, HSC350G		

			
1			
référence	694871	ref. no.	HSC350-41 SLJV2041
description	capot support L 610mm lar. 20mm H 55mm pos. de montage en haut		
Pour modèles:	HSC350, HSC350DD, HSC350G		

			
1			
référence	699307	ref. no.	HSC360-24 SLZE0061
description	embout L 60mm lar. 40mm H 10mm pour lampe		
Pour modèles:	HSC360, HSC360B		

lampes pour réfrigérateurs

lampes pour réfrigérateurs spécifiques au fabricant

RWA

			
1			
référence	698879	ref. no.	E22AC0080015
description	lampe LED 1.5W 12V L 75mm lar. 32mm H 28mm longueur de câble 100mm Q 1 pc		
Pour modèles:	RC700, RN700		



lampes four

lampes four universelles

diamètre de montage 35,5mm



1			
référence	357176	ref. no.	LAM30006
description	lampe four encastrément ø 35.5mm 230V 40W douille G9 résist.à la temp. 300°C raccord câble 100mm verre dur		
Pour modèles:	HCO500		

minuteries

minuteries mécaniques



1			
référence	350130	ref. no.	PRG30001
description	minuterie M11 avec sonnerie 1-pôles temps de marche 120min entraînement mécanique 1NO aux 250V 16A infini oui axe ø 6x4,6mm axe L 23mm dist. fix. 28mm filetage de fixation M4 raccord cosse mâle 6,3mm fixation à 4 trous plat en haut		
Pour modèles:	HCO500		

relais

relais de puissance

avec fixation patte

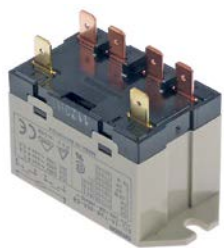

1			
référence	381252	ref. no.	1.03.00010026 HDF1108-021 HDF2128-021
description	relais OMRON 230VAC 25A 2NO raccord cosse mâle 6,3mm fixation patte aux 250V 25A code fabricant G7L-2A-TUB 230VAC		
Pour modèles:	HDF1108, HDF2128		



1			
référence	380867	ref. no.	DQWBZJ02 HSC800-22
description	relais SHANGFANG 12VDC 30A 1NO raccord cosse mâle 6,3mm fixation par vis aux 250V 30A code fabricant 855AW-1A-C1		
Pour modèles:	GSC1100G, HSC800, HSC800G		

transformateurs

transformateurs ouverts

avec bornes de connection



1			
référence	403691	ref. no.	A0904000014
description	transformateur primaire 230VAC secondaire 54VAC secondaire 1.6A raccord à vis		
Pour modèles:	HSC300N, HSC300N-Silver		

transformateurs encapsulés

PMA



1			
référence	379054	ref. no.	HSC800-23
description	transformateur primaire 230VAC secondaire 12VAC 3VA secondaire 0.25A H 40mm L 45mm lar. 50mm raccord à vis 50/60Hz type 153/M		

blocs d'alimentation







1			
référence	530625	ref. no.	E26A10120050
description	bloc d'alimentation primaire 100-240VAC secondaire 12VDC 5VA secondaire 0.42A H 20mm L 55mm lar. 40mm 50/60Hz		
Pour modèles:	RC700, RN700		





autres

			
1			
référence	403660	ref. no.	DQLED069 HBC1002-18 HBC2003-18
description	transformateur primaire 100-240V secondaire 24VDC 20VA secondaire 0.84A		
Pour modèles:	HBC1002, HBC2003, HBC2003G		

			
1			
référence	403867	ref. no.	DQLED042 DQLED055
description	transformateur primaire 100-240V secondaire 24VDC secondaire 0.42A H 25mm L 95mm lar. 40mm		
Pour modèles:	GSC1100G, HSC350DD, HSC350G, HSC350GB, HSC360G, HSC360GB, HSC800G		

accessoires pour	378256		
	référence	379161	ref. no. —
	sonde de température NTC 10kOhm câble thermoplastique sonde -40 jusqu'à +110°C câble -40 jusqu'à +110°C sonde ø6x14mm longueur de câble 3m sans raccord fileté bifilaire		
	référence	379343	ref. no. —
	sonde de température NTC 10kOhm câble silicone sonde -40 jusqu'à +110°C câble -50 jusqu'à +180°C sonde ø6x40mm longueur de câble 3m bifilaire		
	référence	379458	ref. no. —
	sonde de température NTC 10kOhm câble silicone sonde -40 jusqu'à +110°C câble -50 jusqu'à +180°C sonde ø6x40mm longueur de câble 1.5m sans raccord fileté bifilaire		

			
1			
référence	378267	ref. no.	E20A111C0D00 E20A111C4D00
description	régulateur électronique DIXELL XR02CX-5N0C1 dimensions de montage 71x29mm profondeur d'encastrement 56mm aliment. 230V tension AC NTC nb sorties relais 1 NO-20A(8) NTC DI protection IP54 température maximale/commande temporisée -40 jusqu'à +110°C affichage à 2½ chiffres		
Pour modèles:	HFR2600G, HSA2600, RC700		

accessoires pour	378267		
	référence	379161	ref. no. —
	sonde de température NTC 10kOhm câble thermoplastique sonde -40 jusqu'à +110°C câble -40 jusqu'à +110°C sonde ø6x14mm longueur de câble 3m sans raccord fileté bifilaire		
	référence	381249	ref. no. —
	sonde de température NTC 10kOhm câble PVC sonde -40 jusqu'à +110°C câble -10 jusqu'à 100°C raccord bifilaire filetage sonde ø6x14mm longueur de câble 3m		





			
1			
référence	378535	ref. no.	E20A113F0D00
description	régulateur électronique DIXELL XR06CX-5R0C1 dimensions de montage 71x29mm aliment. 230V tension AC NTC nb sorties relais 3 NO-20A(8) CO-8A(3) NO-5A(2) NTC NTC DI protection IP54 0 jusqu'à +60°C affichage à 2½ chiffres		
Pour modèles:	RN700		

régulateurs électroniques

DIXELL

régulateurs électroniques pour réfrigération

version à encastrer

			
1			
référence	378256	ref. no.	RC600.34 RN600.27
description	régulateur électronique DIXELL XR02CX-5N0C0 dimensions de montage 71x29mm profondeur d'encastrement 56mm aliment. 230V tension AC NTC nb sorties relais 1 CO-8A(4) NTC protection IP54 température maximale/commande temporisée -40 jusqu'à +110°C affichage à 2½ chiffres		
Pour modèles:	HFR2600, HRE2600		
pièces détachées	378256		
	référence	379161	ref. no. —
	sonde de température NTC 10kOhm câble thermoplastique sonde -40 jusqu'à +110°C câble -40 jusqu'à +110°C sonde ø6x14mm longueur de câble 3m sans raccord fileté bifilaire		
accessoires pour	378256		
	référence	378194	ref. no. —
	sonde de température NTC 10kOhm câble PVC sonde -20 jusqu'à +80°C câble -10 jusqu'à 100°C sonde ø7x24,5mm longueur de câble 1.5m sans raccord fileté bifilaire		
	référence	379057	ref. no. —
	sonde de température NTC 10kOhm câble PVC sonde -20 jusqu'à +80°C câble -10 jusqu'à 100°C sonde ø6x25mm longueur de câble 3m bifilaire		
	référence	379160	ref. no. E21010150001
	sonde de température NTC 10kOhm câble thermoplastique sonde -40 jusqu'à +110°C câble -40 jusqu'à +110°C sonde ø6x14mm longueur de câble 1.5m sans raccord fileté bifilaire		



SHANGFANG

régulateurs électroniques pour réfrigération

version à encastrer



référence	379799 ¹	ref. no.	DQWBZX02 HSC800-52
description	régulateur électronique SHANGFANG type SF-104S-2 dimensions de montage 71x29mm aliment. 12V tension AC NTC nb sorties relais 2 12VDC 12VDC NTC dimension frontale 77x35mm profondeur d'encastrement 40mm protection IP54 précision 1% version à encastrer alarme sans accessoires fonc. dégiv. oui -45 jusqu'à +45°C affichage 3 chiffres		
Pour modèles:	GSC1100G, HSC800, HSC800G		

pièces détachées	379799			
	référence	379054	ref. no.	HSC800-23
	transformateur primaire 230VAC secondaire 12VAC 3VA secondaire 0.25A H 40mm L 45mm lar. 50mm raccord à vis 50/60Hz type 153/M			
	référence	380867	ref. no.	DQWBZJ02 HSC800-22
	relais SHANGFANG 12VDC 30A 1NO raccord cosse mâle 6,3mm fixation par vis aux 250V 30A code fabricant 855AW-1A-C1			
	référence	381318	ref. no.	—
	sonde de température NTC câble silicone couleurs de câble blanc longueur de câble 3m sonde -40 jusqu'à +110°C câble -50 jusqu'à +180°C sonde ø7x25mm connecteur codé			
	référence	381319	ref. no.	—
	sonde de température NTC câble silicone couleurs de câble noir longueur de câble 3m évaporateur sonde -40 jusqu'à +110°C câble -50 jusqu'à +180°C sonde ø7x25mm connecteur codé			

accessoires pour	379799			
	référence	379054	ref. no.	HSC800-23
	transformateur primaire 230VAC secondaire 12VAC 3VA secondaire 0.25A H 40mm L 45mm lar. 50mm raccord à vis 50/60Hz type 153/M			
	référence	380867	ref. no.	DQWBZJ02 HSC800-22
	relais SHANGFANG 12VDC 30A 1NO raccord cosse mâle 6,3mm fixation par vis aux 250V 30A code fabricant 855AW-1A-C1			
	référence	381318	ref. no.	—
	sonde de température NTC câble silicone couleurs de câble blanc longueur de câble 3m sonde -40 jusqu'à +110°C câble -50 jusqu'à +180°C sonde ø7x25mm connecteur codé			
	référence	381319	ref. no.	—
	sonde de température NTC câble silicone couleurs de câble noir longueur de câble 3m évaporateur sonde -40 jusqu'à +110°C câble -50 jusqu'à +180°C sonde ø7x25mm connecteur codé			

¹sans relais, câblage, sonde et transformateur

version à encastrer 2 pièces



référence	378531	ref. no.	HBC1002-19 HBC2003-19
description	régulateur électronique SHANGFANG type SF-101S dimensions de montage 71x29mm aliment. 230V tension AC NTC nb sorties relais 1 NO-30A NTC Comp dimension frontale 77x35mm profondeur d'encastrement 40mm protection IP54 précision 1% version à encastrer alarme avec relais, câblage, sonde et transformateur fonc. dégiv. oui -45 jusqu'à +45°C affichage 3 chiffres		



référence	379849 ¹	ref. no.	DQWB0005
description	régulateur électronique SHANGFANG type SF-101S dimensions de montage 71x29mm aliment. 230V tension AC NTC nb sorties relais 1 NO-30A NTC Comp dimension frontale 77x35mm profondeur d'encastrement 40mm protection IP54 précision 1% version à encastrer alarme avec relais, câblage, sonde et transformateur fonc. dégiv. oui -45 jusqu'à +45°C affichage 3 chiffres		
Pour modèles:	HBC1002, HBC2003		

pièces détachées	379849			
	référence	379054	ref. no.	HSC800-23
	transformateur primaire 230VAC secondaire 12VAC 3VA secondaire 0.25A H 40mm L 45mm lar. 50mm raccord à vis 50/60Hz type 153/M			
	référence	380867	ref. no.	DQWBZJ02 HSC800-22
	relais SHANGFANG 12VDC 30A 1NO raccord cosse mâle 6,3mm fixation par vis aux 250V 30A code fabricant 855AW-1A-C1			
	référence	381318	ref. no.	—
	sonde de température NTC câble silicone couleurs de câble blanc longueur de câble 3m sonde -40 jusqu'à +110°C câble -50 jusqu'à +180°C sonde ø7x25mm connecteur codé			
	référence	381319	ref. no.	—
	sonde de température NTC câble silicone couleurs de câble noir longueur de câble 3m évaporateur sonde -40 jusqu'à +110°C câble -50 jusqu'à +180°C sonde ø7x25mm connecteur codé			

accessoires pour	379849			
	référence	379054	ref. no.	HSC800-23
	transformateur primaire 230VAC secondaire 12VAC 3VA secondaire 0.25A H 40mm L 45mm lar. 50mm raccord à vis 50/60Hz type 153/M			
	référence	380867	ref. no.	DQWBZJ02 HSC800-22
	relais SHANGFANG 12VDC 30A 1NO raccord cosse mâle 6,3mm fixation par vis aux 250V 30A code fabricant 855AW-1A-C1			
	référence	381318	ref. no.	—
	sonde de température NTC câble silicone couleurs de câble blanc longueur de câble 3m sonde -40 jusqu'à +110°C câble -50 jusqu'à +180°C sonde ø7x25mm connecteur codé			

¹avec relais, câblage, sonde et transformateur

Tableau continue sur la page suivante

accessoires pour	379849		
	référence	381319	ref. no.
	sonde de température NTC câble silicone couleurs de câble noir longueur de câble 3m évaporateur sonde -40 jusqu'à +110°C câble -50 jusqu'à +180°C sonde ø7x25mm connecteur codé		





référence	403074 ¹	ref. no.	DQWB0002
description	régulateur électronique SHANGFANG type SF-1045-2 dimensions de montage 71x29mm aliment. 230V tension AC NTC nb sorties relais 2 NO-30A NO-30A NTC NTC dimension frontale 77x35mm profondeur d'encastrement 38mm protection IP54 précision 1% version à encasturer alarme avec relais, câblage, sonde et transformateur fonc. dégiv. oui -45 jusqu'à +45°C affichage à 2½ chiffres		
Pour modèles:	GSC1100G, HBC1002, HBC2003, HBC2003G, HSC800		

pièces détachées 403074

	référence	379054	ref. no.	HSC800-23
	transformateur primaire 230VAC secondaire 12VAC 3VA secondaire 0.25A H 40mm L 45mm lar. 50mm raccord à vis 50/60Hz type 153/M			

	référence	380867	ref. no.	DQWBZJ02 HSC800-22
	relais SHANGFANG 12VDC 30A 1NO raccord cosse mâle 6,3mm fixation par vis aux 250V 30A code fabricant 855AW-1A-C1			

	référence	381318	ref. no.	—
	sonde de température NTC câble silicone couleurs de câble blanc longueur de câble 3m sonde -40 jusqu'à +110°C câble -50 jusqu'à +180°C sonde ø7x25mm connecteur codé			

	référence	381319	ref. no.	—
	sonde de température NTC câble silicone couleurs de câble noir longueur de câble 3m évaporateur sonde -40 jusqu'à +110°C câble -50 jusqu'à +180°C sonde ø7x25mm connecteur codé			

accessoires pour 403074

	référence	379054	ref. no.	HSC800-23
	transformateur primaire 230VAC secondaire 12VAC 3VA secondaire 0.25A H 40mm L 45mm lar. 50mm raccord à vis 50/60Hz type 153/M			

	référence	380867	ref. no.	DQWBZJ02 HSC800-22
	relais SHANGFANG 12VDC 30A 1NO raccord cosse mâle 6,3mm fixation par vis aux 250V 30A code fabricant 855AW-1A-C1			

	référence	381318	ref. no.	—
	sonde de température NTC câble silicone couleurs de câble blanc longueur de câble 3m sonde -40 jusqu'à +110°C câble -50 jusqu'à +180°C sonde ø7x25mm connecteur codé			

	référence	381319	ref. no.	—
	sonde de température NTC câble silicone couleurs de câble noir longueur de câble 3m évaporateur sonde -40 jusqu'à +110°C câble -50 jusqu'à +180°C sonde ø7x25mm connecteur codé			

¹avec relais, câblage, sonde et transformateur

accessoires

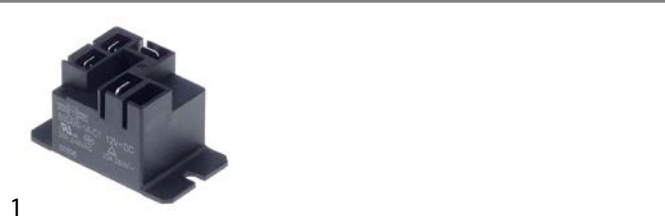

référence	380867	ref. no.	DQWBZJ02 HSC800-22
description	relais SHANGFANG 12VDC 30A 1NO raccord cosse mâle 6,3mm fixation par vis aux 250V 30A code fabricant 855AW-1A-C1		
Pour modèles:	GSC1100G, HSC800, HSC800G		



référence	379054	ref. no.	HSC800-23
description	transformateur primaire 230VAC secondaire 12VAC 3VA secondaire 0.25A H 40mm L 45mm lar. 50mm raccord à vis 50/60Hz type 153/M		

accessoires généraux pour régulateurs



référence	698934	ref. no.	1.1.C.C34.03
description	support L 77mm lar. 28mm H 37mm régulateurs électroniques		
Pour modèles:	HCV1100		

sondes
sondes universelles

sondes de température

	référence	379160	ref. no.	E21010150001
description	sonde de température NTC 10kOhm câble thermoplastique sonde -40 jusqu'à +110°C câble -40 jusqu'à +110°C sonde ø6x14mm longueur de câble 1.5m sans raccord fileté bifilaire			
Pour modèles:	HSA2600, RC700, RN700			



senseurs



1

référence	403155	ref. no.	DQD010010R
description	sonde pour appareil à induction ø 25mm H 17mm longueur de câble 130mm		
Pour modèles:	HIC3500		

modules électroniques

platines

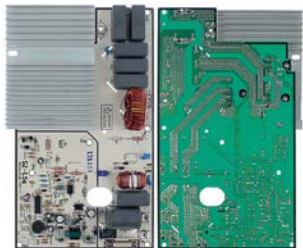

1

référence	403799	ref. no.	DQA010204R
description	carte mère appareil à induction HIC3500 L 265mm lar. 152mm		
Pour modèles:	HIC3500		



1

référence	403715	ref. no.	HVS1000-42 YJS820-42
description	carte mère machine à emballer sous-vide HVS1000 L 88mm lar. 75mm		
Pour modèles:	HVS1000		



1

référence	403717	ref. no.	HVS1000-25 YJS820-25
description	platine machine à emballer sous-vide HVS1000 L 125mm lar. 100mm		
Pour modèles:	HVS1000		

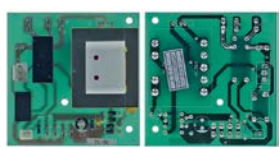

1

référence	403947	ref. no.	1.02.HLC300513000
description	platine pour coupe-légumes L 82mm lar. 82mm		



1

référence	403665	ref. no.	1.1.A.A13.01.51
description	platine de commande pour vitrine HCV1100 avec arrichage avec sonde		

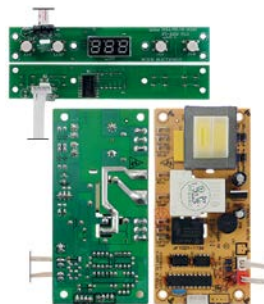

1

référence	361873	ref. no.	1.1.A.A17.01.01
description	platine de commande vitrine frigorifique GGC 1270/2270 longueur de câble 225mm de 2 pièces type KB3150		
Pour modèles:	HCV1100		



1

référence	403798	ref. no.	DQA020344R
description	platine indication appareil à induction HIC3500 L 50mm lar. 48mm		
Pour modèles:	HIC3500		



claviers

claviers à membrane



1

référence	403718	ref. no.	HVS1000-36 YJS820-36
description	clavier à membrane machine à emballer sous-vide HVS1000 L 190mm lar. 55mm		
Pour modèles:	HVS1000		

électrovannes

électrovannes pour l'eau

divers



1

référence	374094	ref. no.	HVS1000-45 YJS820-45
description	électrovanne coudé 2 voies entrée 4,5mm sortie 4,5mm longueur de câble 300mm		
Pour modèles:	HVS1000		



1

référence	374093	ref. no.	HVS1000-41 YJS820-41
description	électrovanne simple 2 voies 12VDC entrée 11mm sortie 11mm adaptable à sortie		
Pour modèles:	HVS1000		

métal

ASCO

pièces détachées et accessoires

joint toriques



1

référence	371100	ref. no.	HVS1000-04 YJS820-4
description	joint torique silicone épaisseur 1.78mm int. ø 6.07mm Q 1 pc		
Pour modèles:	HVS1000		

Électrovannes - accessoires



1

référence	371100	ref. no.	HVS1000-04 YJS820-4
description	joint torique silicone épaisseur 1.78mm int. ø 6.07mm Q 1 pc		
Pour modèles:	HVS1000		

compresseurs

ACC/ZEL

R600A

LBP monphasé

Température d'évaporation faible supérieure à -20 °C



1

référence	605141	ref. no.	DQYD0015 E27B6F1Z0001 HBC1002-15
description	compresseur fréon R600a type HPY12AAa 220-240V 50Hz LBP 8.8kg 1/5HP cylindrée 12cm ³ RSIR H 200mm WWWWWW		
Pour modèles:	HBC1002, HSA2600		



1

référence	605147	ref. no.	RC600.08
description	compresseur fréon R600a type HTH14AA 220-240V 50Hz LBP 9.37kg 1/4HP cylindrée 14cm ³ RSIR/RSCR H 183mmWWWWWWW		
Pour modèles:	HRE2600		



1

référence	605150	ref. no.	1.1.A.A02.01
description	compresseur fréon R600a type HVM10AA 220-240V 50Hz LBP 8.7kg 1/6HP cylindrée 10cm ³ RSIR H 180mmWWWWWWW		
Pour modèles:	HCV1100		



1

référence	605142	ref. no.	DQYD0014
description	compresseur fréon R600a type HVM86AA 220-240V 50Hz LBP complètement hermétique 7.83kg 1/7HP cylindrée 8.6cm ³ RSIR H 174mmWWWW		

EMBRACO / ASPERA

R290A
LBP monophasé
Température d'évaporation faible supérieure à -20 °C



1

référence	605243	ref. no.	A080100000 A0801000468
description	compresseur fréon R290 type NEU2155U 220-240V 50Hz LBP 11.2kg 3/4HP cylindrée 13.54cm ³ CSIR H 190mm 463W 744W 916W 1110WWWWWWW méthode de test ASHRAE		
Pour modèles:	HSC300N, HSC300N-Silver		

R404a/R507

LBP monophasé
Température d'évaporation faible supérieure à -20 °C



1

référence	605164	ref. no.	E27A4P4E0000
description	compresseur fréon R404A type NEU2178GK 220-240V 50Hz LBP 17kg 1HP cylindrée 17.4cm ³ CSR H 220mm 442W 610W 808W 1032W 1285W 1565WWWWWWW		
Pour modèles:	RN700		



SECOP DANFOSS

R134A

HMBP monophasé

Température d'évaporation élevée/moyenne supérieure à -20/-15 °C



1

référence	605087	ref. no.	E27A1N2S0000
description	compresseur fréon R134a type SC12G 220-240V 50Hz HMBP complètement hermétique 12.6kg 1/3HP puissance absorbée 470W cylindrée 12.9cm ³ RSIR/CSIR H 203mm 140W 216W 312W 430W 574W 746W 951W 1191W 1469W méthode de test ASHRAE 79.6W 1790W		
Pour modèles:	RC700		
pièces détachées	605087		
	référence	380483	ref. no. —
	relais de démarrage DANFOSS 117U6003 HST		

autres

R134A



1

référence	605240	ref. no.	DQYA0049 HSC800-07
description	compresseur HuaGuang fréon R134a type AN150ML 220-240V 50Hz LBP 10.5kg 1/2HP cylindrée 15.1cm ³ CSIR H 180mmWWWWWWWWWW		
Pour modèles:	HSC800		



1

référence	605239	ref. no.	DQYA0009 HBC2003-15
description	compresseur HuaGuang fréon R134a type ANA90 220-240V 50Hz 10.5kgHP puissance absorbée 255W cylindrée cm ³ H 180mmWWWWWWWWWW		
Pour modèles:	HBC2003		



1

référence	605245	ref. no.	DQYA0014 HSC350-07 HSC360-11
description	compresseur HuaGuang fréon R134a type ATA72XL 220-240V 50/60Hz 7.2kg 1/5HP cylindrée 7cm ³ H 160mmWWWWWWWWWW		
Pour modèles:	HSC350, HSC350B, HSC360, HSC360B		



1

référence	605140	ref. no.	DQYA0087
description	compresseur KONOR type GQR90AA fréon R134a 220-240V 50Hz 10.1kg 1/4HP cylindrée 9.1cm ³ RSIR H 186mmWWWWWWWWWW		



1

référence	605148	ref. no.	RN600.06
description	compresseur KULTHORN type AEA2415Y fréon R134a 220-240V 50HzHP cylindrécm ³ WWWWWW		
Pour modèles:	HFR2600		

R600A



1

référence	605272	ref. no.	DQYD0009
description	compresseur HuaGuang fréon R600 type ETA110 220-240V 50Hz LBP 8kg 1/4HP cylindrécm ³ RSIRWWWWW		
Pour modèles:	HSC350DD, HSC350G, HSC350GB, HSC360G, HSC360GB		

accessoires

relais de démarrage

autres



1

référence	381450	ref. no.	RC600.13 RC600.14
description	relais de démarrage 230V 16A		
Pour modèles:	HRE2600		



1

référence	381449	ref. no.	RN600.09
description	relais de démarrage KULTHORN KME 682-26NT 230V 16A		
Pour modèles:	HFR2600		

interrupteurs thermiques (klixon)



1

référence	391044	ref. no.	RN600.08
description	interrupteur thermique pour contacteur-disjoncteur Klixon avec câble t.max. 105°C		
Pour modèles:	HFR2600		

divers



1

référence	699425	ref. no.	1.1.C.C41.01
description	amortisseurs de vibration ø 25mm H 10mm		
Pour modèles:	HCV1100		

ventilateurs

ventilateurs axiaux

ebm-papst



1

référence	601813 ¹	ref. no.	RC600.33
description	ventilateur axial L 119mm lar. 119mm H 38mm 230VAC 50/60Hz 19W palier roulement à billes code fabricant 4656N/A02 longueur de câble 800mm métal raccord connecteur ebm-papst hélice ø 110mm		
Pour modèles:	HRE2600		

¹avec palier lisse



import



référence	601604 ¹	ref. no.	E17A1A010100
description	ventilateur axial L 119mm lar. 119mm H 38mm 230VAC 50/60Hz 17/15W palier palier lisse code fabricant AA1282HS-AT raccord câble 300mm hélice ø 110mm résist.à la temp. 70°C absorption de courant 0.1A débit 130m ³ /h 2600tr/min		
Pour modèles:	HSA2600		

¹avec palier lisse



référence	602136	ref. no.	DQFD2003 HBC2003-33
description	ventilateur axial L 119mm lar. 119mm H 38mm 230VAC 50/60Hz 22/38,4W palier palier lisse code fabricant HT-A12038S220 raccord avec câble 500mm longueur de câble 300mm HUI TONG hélice ø 110mm absorption de courant 0,1/0,16A corps aluminium		
Pour modèles:	HBC1002, HBC2003, HBC2003G		



référence	601787 ¹	ref. no.	DQFA1000 DQFD1000 DQFD1001 HBC1002-33 HSC350-42 HSC360-30 HSC800-44
description	ventilateur axial L 119mm lar. 119mm H 38mm 230VAC 50/60Hz 22/38,4W palier palier lisse code fabricant HT-A12038S220 raccord connecteur longueur de câble 300mm HUI TONG hélice ø 110mm absorption de courant 0,1/0,16A corps aluminium		
Pour modèles:	GSC1100G, HSC350, HSC350B, HSC350DD, HSC350G, HSC350GB, HSC360, HSC360B, HSC360G, HSC360GB, HSC800, HSC800G		

¹avec palier lisse

accessoires

grilles de ventilation



référence	691104	ref. no.	HBC1002-34 HBC2003-34 HSC350-43 WJFZ0007
description	grille ventilateur ø 115mm dist. fix. 105mm pour ventilateur axial 119mm		
Pour modèles:	HBC1002, HBC2003, HBC2003G, HSC350, HSC350B, HSC350DD, HSC350G, HSC350GB		



ventilateurs froids

moteurs froids universels

ebm-papst

autres



référence	601783	ref. no.	E17A1A050500 E17A1A100900
description	moteur ventilateur 10W 230V 50/60Hz L3 87mm lar. 67mm longueur de câble 400mm 1300tr/min ebm-papst M4Q045-CA03-51/C18 3 options de fixation palier palier lisse pour tables réfrigérée		
Pour modèles:	HSA2600, RC700, RN700		
pièces détachées	601783		
	référence	601413	ref. no. —
	patte de fixation adaptable à hélice ø ext. 32mm arbre ø 7 dist. fix. 26mm		
accessoires pour	601783		
	référence	601385	ref. no. E181A1723401
	hélice aspirant ø 172mm fixation rotor 25.4mm angle du rotor 34° lar. 42mm aluminium		



accessoires

rotors

aluminium

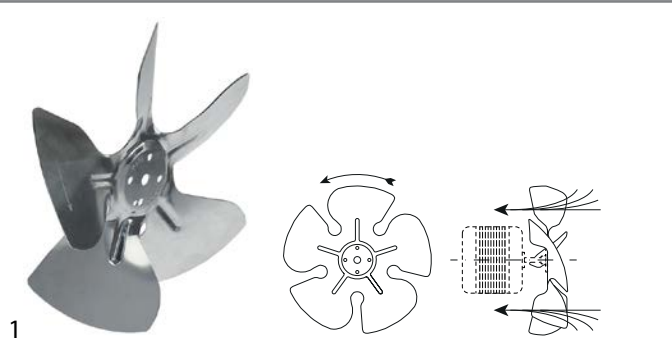

référence	601385	ref. no.	E181A1723401
description	hélice aspirant ø 172mm fixation rotor 25.4mm angle du rotor 34° lar. 42mm aluminium		
Pour modèles:	HSA2600		

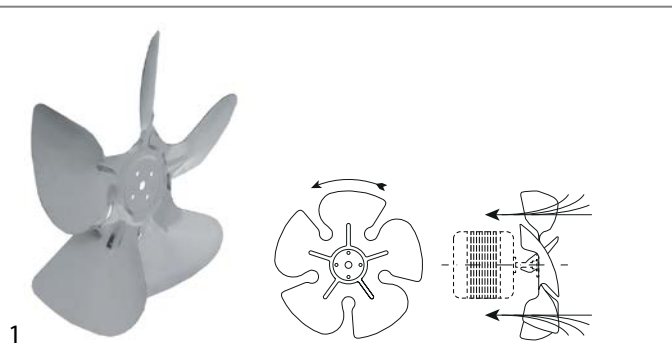

référence	602113	ref. no.	E181A2303401
description	hélice aspirant ø 230mm fixation rotor 25.4mm angle du rotor 34°		
Pour modèles:	RC700, RN700		

grilles de ventilation

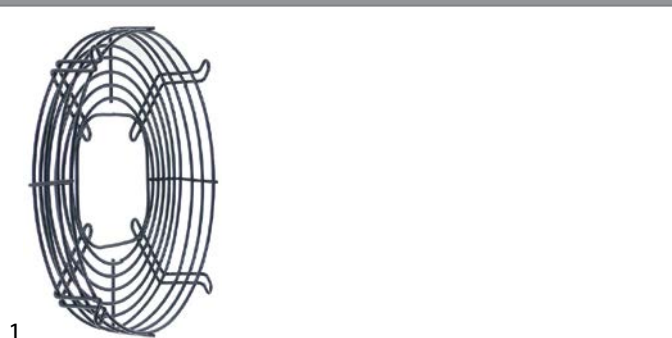

référence	602101	ref. no.	E192A1200300 E192A1723800
description	grille ventilateur ø 210mm H 35mm distance de fixation 1 230mm distance de fixation 2 100mm		
Pour modèles:	HSA2600		

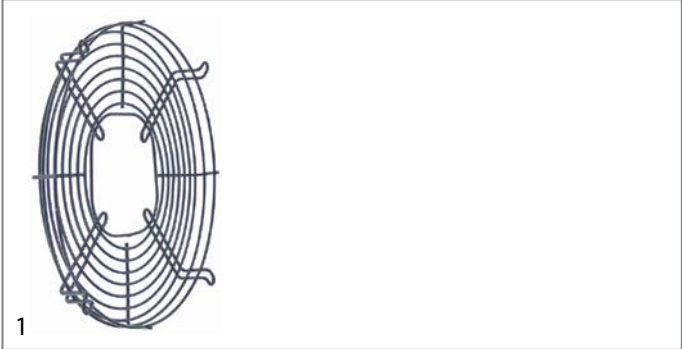

référence	602112	ref. no.	E191A2303800 E192A2303800
description	grille ventilateur ø 250mm H 28mm distance de fixation 1 265mm distance de fixation 2 115mm		
Pour modèles:	RC700, RN700		

moteurs froids complets



référence	601836	ref. no.	DQJB2004 HBC1002-07 HBC2003-07 HSC800-19
description	ventilateur 220V 25/3W 50/60Hz hélice ø 172mm L 82mm lar. 82mm raccord cosse à fourche M4 longueur de câble 1000mm		
Pour modèles:	HBC1002, HBC2003, HBC2003G, HSC800		



référence	601835	ref. no.	DQJB2013	
description	ventilateur 220V 35/5W 50/60Hz L 82mm lar. 82mm raccord cosse à fourche M4 longueur de câble 1100mm			
pièces détachées	601835			
	référence	602184	ref. no.	—
	patte de fixation adaptable à hélice ø ext. 33mm arbre ø 6 dist. fix. 17mm			



ventilateurs froids

ventilateurs froids

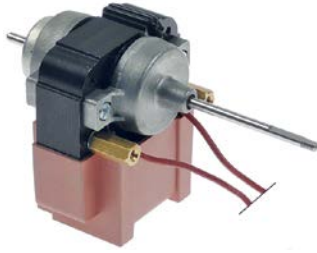

1			
référence	602079	ref. no.	1.1.A.A03.01.73
description	moteur ventilateur 220-240V 50Hz 5W axe ø 4mm axe L 16/55mm L 140mm lar. 65mm H 76mm		
Pour modèles:	HCV1100		

accessoires

rotors pour ventilateurs froids



1			
référence	698933	ref. no.	1.1.A.A03.01.59
description	hélice aspirant ø 150mm logement d'axe ø 3,5x4mm lar. 10.5mm Q 1 pc palettes 6		
Pour modèles:	HCV1100		



1			
référence	601846	ref. no.	1.1.C.C17.01 1.1.C.C17.04
description	hélice soufflant ø 150mm logement d'axe ø 4mm lar. 33mm plastique Q 1 pc		
Pour modèles:	HCV1100		

ventilateurs tangentiels

IMPORT



1			
référence	601812	ref. no.	RC600.16
description	ventilateur tangential YJ61-14A-HZ01 rouleau ø 60mm longueur rouleau 180mm épaisseur de noyau feuilleté 18mm position de moteur à gauche 220-240V/50-60Hz 13W réfrigération palier caoutchouc raccord connecteur -30 jusqu'à +100°C 220V longueur de câble 300mm 50Hz		
Pour modèles:	HRE2600		



1			
référence	601847	ref. no.	A0805000051
description	ventilateur tangential YJ61-16A-HZ03 rouleau ø 60mm longueur rouleau 180mm épaisseur de noyau feuilleté 15mm position de moteur à droite 220-240V/50-60Hz 27W réfrigération palier caoutchouc raccord cosse mâle 6,3mm -10 jusqu'à +60°C 230V 50/60Hz		
Pour modèles:	HSC300N, HSC300N-Silver		

accessoires pour ventilateurs tangentiels

fixations



1			
référence	692388	ref. no.	RC600.17
description	support pour ventilateur tangential L 295mm lar. 85mm H 25mm Q 1 pc		
Pour modèles:	HRE2600		

ventilateurs à air chaud

autres

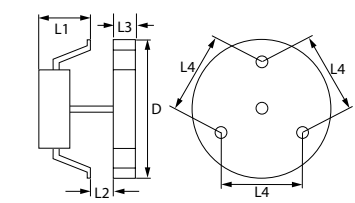

référence	500902	ref. no.	MOT30029
description	moteur ventilateur 220V 55W 50/60Hz L1 68mm FIME type L25R sans hélice		
Pour modèles:	HCO500		
accessoires pour	500902		
	référence	550879	ref. no. —
	isolation ø 130mm épaisseur 3mm trou ø 18mm pour ventilateurs à air chaud		

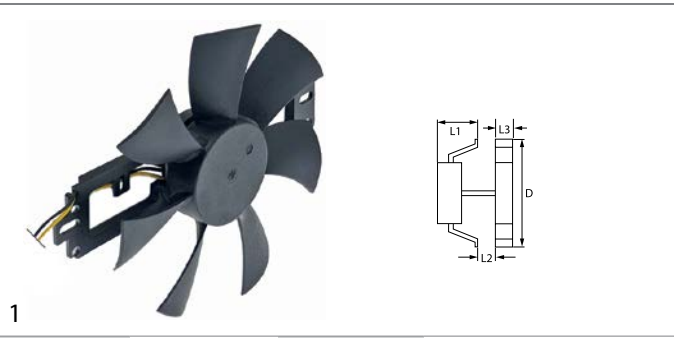

référence	602140	ref. no.	AD200057
description	ventilateur à air chaud 18V 2750tr/min L1 6mm L2mm L3 16mm L4mm hélice ø 85mm type YHWF-110		
Pour modèles:	HIC3500		

accessoires

rotors pour ventilateurs à air chaud

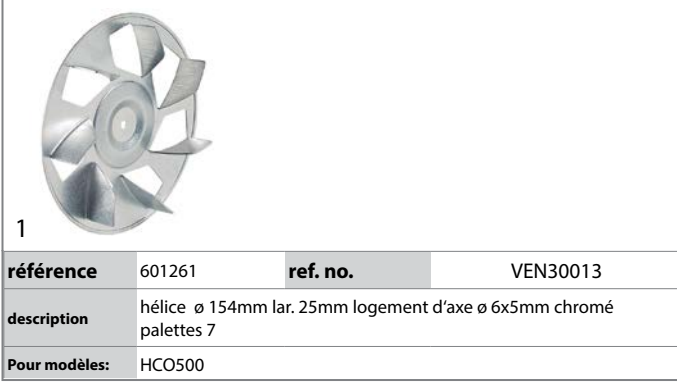

référence	601261	ref. no.	VEN30013
description	hélice ø 154mm lar. 25mm logement d'axe ø 6x5mm chromé palettes 7		
Pour modèles:	HCO500		

accessoires généraux



référence	699426	ref. no.	1.1.C.C46.04.16
description	cadre ø 160/210mm pour ventilateur		
Pour modèles:	HCV1100		



référence	699309	ref. no.	HSC360-35 WJFZ0008
description	grille ventilateur ø 194mm dist.trou 208mm		
Pour modèles:	HSC360, HSC360B, HSC360G		

moteurs

moteurs

pour coupe-légumes



référence	601855	ref. no.	1.04.05001406100-1
description	moteur 230V 550W 50Hz 1400tr/min phases 1 arbre ø 31.5mm L. arbre 37mm H 220mm dist. fix. 170mm		
Pour modèles:	HVC1001		
pièces détachées	601855		

	référence	365020	ref. no. —
	condensateur de service capacité 14µF 400V tolérance 5%Hz température ambiante max. -25 à +85°C ø 35mm L 70mm M8 plastique raccord cosse mâle 6,3mm protection		

pompes

pompes aspirantes

pompes aspirantes



1

référence	602111	ref. no.	HVS1000-30 YJS820-30
description	pompe aspirante 220/240V 0.32kW 50Hz type OLF400Z		
Pour modèles:	HVS1000		

condensateurs & filtres antiparasites

condensateurs de démarrage

condensateurs de démarrage



1

référence	365214	ref. no.	RC600.12
description	condensateur de démarrage 5µF 450V 50/60Hz facteur de service 5% ø 35mm L 60.5mm raccord cosse mâle 4,8mm		
Pour modèles:	HRE2600		

fusibles

fusibles verres



1

référence	358186	ref. no.	DZJ020003
description	fusible mesure ø6,3x32 15A à action retardée nominale 250V Q 1 pc		
Pour modèles:	HIC3500		

accessoires électriques

fiches - embouts - prises femelles

prises/connecteurs pour appareils

appareils de basse température 70°C



1

référence	551334	ref. no.	HVS1000-38 YJS820-38
description	connecteur pour prises appareil C14 max 10A/250V F4,8		
Pour modèles:	HVS1000		

câbles

câbles alimentation pour appareils



1

référence	550726	ref. no.	HVS1000-39 YJS820-39
description	câble aliment. pour appareils de basse temp. CEE7/7 - C15 3-pôles contacts P+N+T 1mm ² max. 10A max 250V 2,0m H05VVF T70 2-pôles + prise de terre isolation PVC		
Pour modèles:	HVS1000		



1

référence	551217	ref. no.	DQXA6002 HBC1002-16 HBC2003-16 HSC350-05 HSC360-05
description	câble d'alimentation CEE7/7 type E+F 3-pôles contacts P+N+T 0.75mm ² max. 16A 2.2m avec serre cable 16A Q 1 pc blanc		
Pour modèles:	GSC1100G, HBC1002, HBC2003, HBC2003G, HSC350, HSC350B, HSC350DD, HSC350G, HSC350GB, HSC360, HSC360B, HSC360G, HSC360GB, HSC800, HSC800G		





1

référence	551218	ref. no.	1.1.A.A08.02.02 1.1.A.A08.02.36 1.1.A.A08.02.79 1.1.A.A08.02.87
description	câble d'alimentation CEE7/7 type E+F 3-pôles contacts P+N+T 0.75mm ² max. 16A max 230V 2m Q 1 pc gris		
Pour modèles:	HCV1100		



			
référence	551325	ref. no.	XC0000071R
description	câble d'alimentation P+N+T 1mm ² max 500V 1.5m Q 1m raccord à vis		
Pour modèles:	HIC3500		

			
référence	698880	ref. no.	E25EUB315300
description	câble de raccordement 3-pôles contacts P+N+T 1.5mm ² max. 16A max 250V 2.9m		
Pour modèles:	HSA2600, RC700, RN700		

			
référence	699313	ref. no.	RN600.01
description	câble de raccordement CEE7/7 type E+F 3-pôles contacts P+N+T 0.75mm ² max. 16A max 250V 2.87m		
Pour modèles:	HFR2600		

			
référence	551203	ref. no.	CAV30014
description	câble de raccordement CEE7/7 type E+F 3-pôles contacts P+N+T 2.5mm ² max. 16A max 230V 2m H07 RN-F avec connecteur		
Pour modèles:	HCO500		

câbles PVC			
			
référence	551331	ref. no.	A0927000129
description	câble PVC 2-pôles 0.75mm ² L 580mm blanc température constante°C t.max°C tension d'essaiV		
Pour modèles:	HSC300N, HSC300N-Silver		

accessoires
 passe-câbles
 passe-câbles à vis
 raccords filetés

			
référence	551379	ref. no.	PPC30004
description	passe-câble à vis filetage PG13,5 câble ø 12mm encastrément ø 20mm OC 24 plastique Q 1 pc avec écrou		
Pour modèles:	HCO500		

serres cable			
			
référence	506273	ref. no.	HVS1000-44 YJS820-44
description	serre cable L 20mm lar. 8mm trou ø 4mm Q 1 pc		
Pour modèles:	HVS1000		

			
référence	506235	ref. no.	1.1.C.C24.03
description	serre cable L 28mm lar. 12mm H 8mm trou ø 3.5mm dist.trou 16mm plastique Q 1 pc		
Pour modèles:	HCV1100		

câbles rallonge			
			
référence	699304	ref. no.	DQXB9019 HBC1002-21 HBC2003-21
description	câble de raccordement L 360mm 3-pôles		
Pour modèles:	HBC1002, HBC2003, HBC2003G		

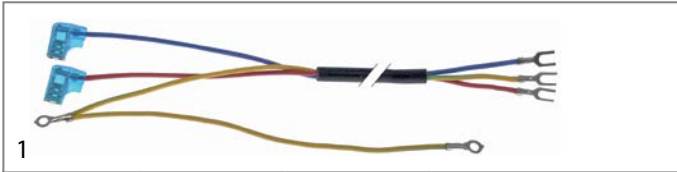
référence	699305	ref. no.	DQXB2003 HSC350-03 HSC360-03
description	câble de raccordement L 650mm 3-pôles		
Pour modèles:	HSC350, HSC350B, HSC350DD, HSC350G, HSC350GB		

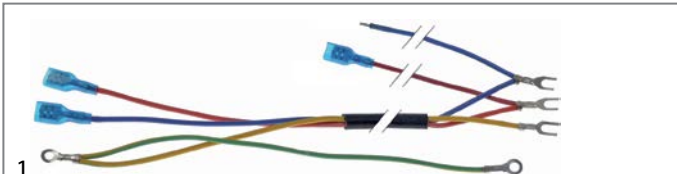

référence	699306	ref. no.	DQXB4003 HSC800-02
description	câble de raccordement L 665mm 3-pôles		
Pour modèles:	GSC1100G, HSC800, HSC800G		

bornes

bornes de raccord à vis/faston

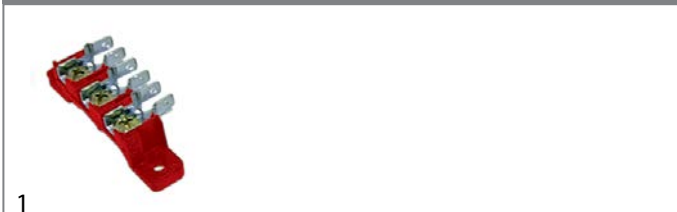

référence	550516	ref. no.	MOR30005
description	bornier de raccordement 3-pôles max. 40A max 400V raccord M6/ cosse mâle 6,3mm résist.à la temp. 150°C section nominale 6mm ² dist. fix. 66.5mm		
Pour modèles:	HCO500		

boîtes de dérivation

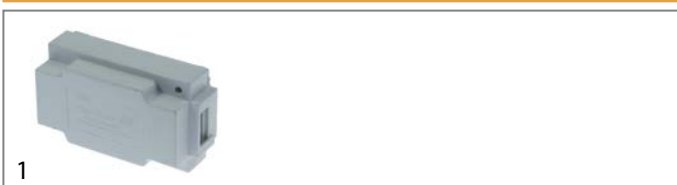

référence	551216	ref. no.	HBC1002-17 HBC2003-17 HSC350-06 HSC360-10 HSC800-21 SLZB3001
description	boîte de dérivation 4-pôles L 90mm lar. 52mm H 33mm avec serre-cable 250V 1mm ² Q 1 pc		
Pour modèles:	HBC1002, HBC2003, HBC2003G, HSC350, HSC350B, HSC350DD, HSC350G, HSC350GB, HSC360, HSC360B, HSC360G, HSC360GB		

pièce de rechange pour appareils spécifiques

pour coupe-légumes

plateaux répartiteurs



référence	699135	ref. no.	3.HLC300087040301
description	plateau répartiteur haut H 30mm ø 200mm logement ø 20mm dist. trou 41mm		
Pour modèles:	HVC1001		

disques rape



référence	699633	ref. no.	2,0000001 HVC1001-Pos.033.4
description	disque rape type H3 ø 205mm logement ø 19mm H 33mm épaisseur de tranche 3mm		
Pour modèles:	HVC1001		



référence	699634	ref. no.	2,0000021 HVC1001-Pos.033.5
description	disque rape type H4 ø 205mm logement ø 19mm H 33mm épaisseur de tranche 4mm		
Pour modèles:	HVC1001		

disques à trancher

lames lisses

disques à trancher



référence	699631	ref. no.	2,0000004 HVC1001-Pos.033.2
description	disque à trancher type P2 ø 205mm logement ø 19mm épaisseur de tranche 2mm plastique		
Pour modèles:	HVC1001		





 <p>1</p>			
référence	699632	ref. no.	2,0000003 HVC1001-Pos.033.3
description	disque à trancher type P4 ø 205mm logement ø 19mm épaisseur de tranche 4mm plastique		
Pour modèles:	HVC1001		

<p>grilles à bâtonnets</p>  <p>1</p>			
référence	699638	ref. no.	2,0000008
description	grille à bâtonnets type HU4 ø 205mm logement ø 19mm épaisseur de tranche 4mm		

<p>tiges-poussoirs</p>  <p>1</p>			
référence	696868	ref. no.	3.HLC300A081060201
description	tige-poussoir ø 50mm L 130mm longueur totale 275mm plastique		
Pour modèles:	HVC1001		

<p>arbres</p>  <p>1</p>			
référence	692921	ref. no.	2.HLC300045000
description	arbre L1 37mm L2 88mm D1 ø 19mm D2 ø 14mm pour coupe-légumes longueur totale 128mm		
Pour modèles:	HVC1001		

<p>divers</p>  <p>1</p>			
référence	692924	ref. no.	2.HLC300-092120340
description	douille séparation ø ext. 20mm int. ø 15.5mm H 27mm pour coupe-légumes		
Pour modèles:	HVC1001		

 <p>1</p>			
référence	692925	ref. no.	2.HLC300-060100410
description	manchon fileté ø ext. M16mm int. ø M10mm H 285mm pour coupe-légumes		
Pour modèles:	HVC1001		

<p>pour réfrigérateurs</p> <p>pièces détachées et accessoires</p>  <p>1</p>			
référence	694869	ref. no.	HSC350-17
description	capot L 153mm lar. 57mm H 110mm plastique Q 1 pc dist. fix. 125mm		

 <p>1</p>			
référence	694967	ref. no.	SLCX0002
description	capot L 51mm lar. 44mm H 12mm plastique dist. fix. 30mm		
Pour modèles:	HSC350DD, HSC350G, HSC360G		



1

référence	698881	ref. no.	P01AA08A0002
description	filtre pour condensat L 270mm lar. 228mm H 3.5mm plastique		
Pour modèles:	RC700		



1

référence	698878	ref. no.	HBC1002-47 HBC2003-46 WJQZ9000 WJQZ9001
description	guide contrepoids pour porte coulissante L 248mm lar. 20mm H 10mm		
Pour modèles:	HBC1002, HBC2003, HBC2003G		



1

référence	694868	ref. no.	HSC350-11
description	support pour déshydrateur L 40mm lar. 30mm H 31mm Q 1 pc		



1

référence	750691	ref. no.	P01AF00A0004
description	vanne d'équilibrage L 104mm lar. 59mm H 87mm		
Pour modèles:	HFR2600G		

boîtiers et façades

capots

1

référence	698890	ref. no.	HBC2003-25 PTBP9N88
description	capot L 1350mm lar. 65mm H 52mm Q 1 pc		
Pour modèles:	HBC2003		

1

référence	698891	ref. no.	HBC1002-25 PTBP9N76
description	capot pour compresseur L 900mm lar. 65mm H 52mm Q 1 pc		
Pour modèles:	HBC1002		



1

référence	694588	ref. no.	RC600.31
description	capot pour ventilateur axial lar. 663mm H 222mm épaisseur plaque 0.7mm tôle Q 1 pc		
Pour modèles:	HRE2600		

couvercles

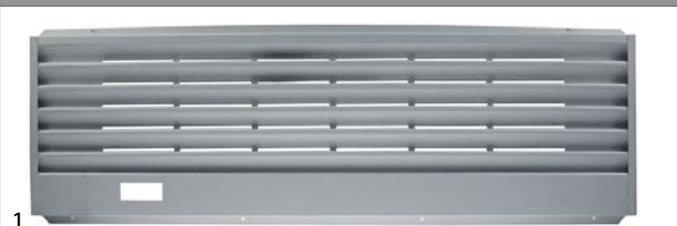

1

référence	698886	ref. no.	HSC800-16
description	capot pour compresseur blanc L 1005mm lar. 325mm H 45mm Q 1 pc		

poignées





1

référence	692390	ref. no.	LCCG0005
description	barre de poignée pour porte L 380mm lar. 40mm aluminium Q 1 pc		
Pour modèles:	GSC1100G		





supports			
			
1			
référence	692383	ref. no.	P01AF07A0003 RN600.20
description	support pour évaporateur pos. de montage à droite L 98mm lar. 34mm H 37mm plastique Q 1 pc		
Pour modèles:	HFR2600, HFR2600G		

			
1			
référence	692384	ref. no.	P01AF07A0004 RN600.21
description	support pour évaporateur pos. de montage à gauche L 98mm lar. 34mm H 37mm plastique Q 1 pc		
Pour modèles:	HFR2600, HFR2600G		

capuchons			
			
1			
référence	698981	ref. no.	B1301080403
description	capot L 15mm lar. 12mm H 6mm plastique		
Pour modèles:	HSC300N		

			
1			
référence	698986	ref. no.	B1301080400
description	capuchon ø 10.7mm H 6mm Q 5 pc		
Pour modèles:	HSC300N		

autres			
			
1			
référence	692391	ref. no.	HSC350-39 HSC800-39 SLZE0027
description	boîtier pour culot L 150mm lar. 40mm H 20mm plastique Q 1 pc		
Pour modèles:	GSC1100G, HSC350, HSC350B, HSC350DD, HSC350G, HSC350GB, HSC800, HSC800G		

			
1			
référence	694859	ref. no.	HSC800-40
description	capot pour éclairage L 970mm lar. 280mm plexiglas épaisseur 1mm		

			
1			
référence	692392	ref. no.	SLSE4005
description	capot pour éclairage lar. 1170mm H 280mm épaisseur 1mm plastique Q 1 pc		
Pour modèles:	GSC1100G		

			
1			
référence	694875	ref. no.	HSC350-19 SLZE0026
description	capot pour thermostat		
Pour modèles:	HSC350, HSC350DD, HSC350G		

			
1			
référence	701267	ref. no.	RC600.21 RN600.14
description	grille de ventilation blanc H 61mm L 770mm pos. de montage en bas Q 1 pc		
Pour modèles:	HFR2600, HRE2600		

			
1			
référence	701268	ref. no.	RN600.32
description	profil en U pour évaporateur L 635mm lar. 16mm H 13mm aluminium Q 1 pc		
Pour modèles:	HFR2600		



portes

portes



référence	694543	ref. no.	RC600.41 RN600.30
description	porte lar. 765mm H 1740mm épaisseur 63mm		
Pour modèles:	HFR2600, HRE2600		



référence	699381	ref. no.	BLGM4010
description	porte vitrée à gauche lar. 600mm H 1330mm P 40mm		
Pour modèles:	GSC1100G		
pièces détachées	699381		
	référence	901662	ref. no. SLJP4007
	joint porte profil 9156 lar. 569mm L 1295mm dimension d'insertion Q 1 pc		



référence	699382	ref. no.	BLGM4011
description	porte vitrée à droite lar. 600mm H 1330mm P 40mm		
Pour modèles:	GSC1100G		
pièces détachées	699382		
	référence	901662	ref. no. SLJP4007
	joint porte profil 9156 lar. 569mm L 1295mm dimension d'insertion Q 1 pc		



référence	699493	ref. no.	BLGM4025
description	porte vitrée avec serrure lar. 620mm H 680mm P 38mm pos. de montage en bas		
Pour modèles:	HSC350DD		
pièces détachées	699493		
	référence	902465	ref. no. SLJP2015
	joint froid profil 9161 lar. 590mm L 650mm dimension d'insertion		



référence	698989	ref. no.	BLGM2B12 HSC350-46
description	porte vitrée L 1370mm lar. 620mm P 47mm		
Pour modèles:	HSC350, HSC350G		



référence	699375	ref. no.	BLGM4160
description	porte vitrée lar. 460mm H 1230mm pos. de montage à gauche P 30mm		
Pour modèles:	HSC800, HSC800G		



référence	699376	ref. no.	BLGM4161
description	porte vitrée lar. 460mm H 1230mm pos. de montage à droite P 30mm		
Pour modèles:	HSC800, HSC800G		



référence	692675	ref. no.	B0406040009 B0406040010
description	porte vitrée lar. 592mm H 1625mm épaisseur 50mm		
Pour modèles:	HSC300N, HSC300N-Silver		



référence	699374	ref. no.	BLPM2033 HSC360-40
description	porte vitrée lar. 620mm H 1600mm P 40mm		
Pour modèles:	HSC360, HSC360G		



référence	699494	ref. no.	BLGM4024
description	porte vitrée lar. 620mm H 680mm P 38mm pos. de montage en haut		
Pour modèles:	HSC350DD		
pièces détachées	699494		

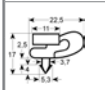

référence	902465	ref. no.	SLJP2015
description	joint froid profil 9161 lar. 590mm L 650mm dimension d'insertion		

autres



référence	692424	ref. no.	HSC350-25 SLZV0007
description	capot pour éclairage pos. de montage intérieur L 1263mm lar. 56mm H 20mm plastique Q 1 pc		
Pour modèles:	HSC350, HSC350B		

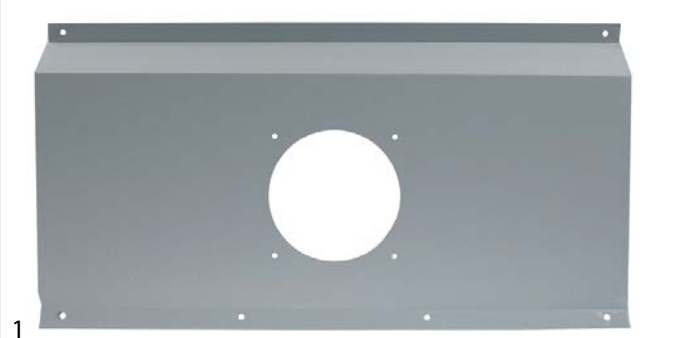

référence	694867	ref. no.	HSC350-29 PTBP2020
description	capot pour évaporateur L 525mm lar. 280mm H 53mm tôle Q 1 pc		
Pour modèles:	HSC350, HSC350DD, HSC350G		



référence	698888	ref. no.	HBC1002-30 HBC2003-30 SLZV0019
description	capot transparent pour lampe L 810mm lar. 40mm H 30mm Q 1 pc		
Pour modèles:	HBC2003, HBC2003G		



référence	692426	ref. no.	HSC350-26 LCCJ2029
description	guide pour réfrigérateur L 1145mm lar. 26mm H 4.5mm Q 1 pc		
Pour modèles:	GSC1100G, HSC350, HSC350DD, HSC350G, HSC800, HSC800G		

1

référence	692731	ref. no.	RC600.11
description	support L 80mm lar. 58mm P 25mm tôle d'acier zingué		
Pour modèles:	HRE2600		



1

référence	701431	ref. no.	HSC360-22 WJLD0000
description	support pour porte vitrée L 54mm lar. 42mm H 75mm trou ø 7x12mm Q 1 pc		
Pour modèles:	HSC360, HSC360B, HSC360G, HSC360GB		



1

référence	698877	ref. no.	HSC800-28 LCCK0001
description	supports tablette L 26.5mm lar. 8.5mm H 40mm aluminium		
Pour modèles:	GSC1100G, HSC800, HSC800G		

por congélateurs

boîtiers et façades



1

référence	692386	ref. no.	RC600.35 RN600.26
description	front lar. 770mm H 52mm plastique Q 1 pc		
Pour modèles:	HFR2600, HRE2600		

pour vitrine réfrigérée

pièces détachées et accessoires



1

référence	699437	ref. no.	1.1.B.B09.16
description	pendant pour pied L 44.5mm lar. 27mm H 15.5mm		
Pour modèles:	HCV1100		

boîtiers et façades

façades



1

référence	692733	ref. no.	HSC360-27 SLJX2014
description	capot pour lampe lar. 55mm H 20mm L 1040mm		
Pour modèles:	HSC360, HSC360B		



1

référence	698928	ref. no.	1.1.C.C46.04.11
description	capot pour vitrine lar. 625mm P 165mm H 40mm plastique		
Pour modèles:	HCV1100		



1

référence	699401	ref. no.	S24AC21A0001
description	front pos. de montage à l'avant lar. 865mm P 15mm H 248mm		
Pour modèles:	HSA2600		



1

référence	698927	ref. no.	1.1.C.C46.04.09
description	panneau pos. de montage à l'avant pour vitrine lar. 696mm P 16mm H 205mm plastique Q 1 pc		
Pour modèles:	HCV1100		



1

référence	698984	ref. no.	B1301010355
description	panneau pos. de montage en bas lar. 460mm P 14mm H 15mm plastique Q 1 pc		
Pour modèles:	HSC300N, HSC300N-Silver		

			
1			
référence	698977	ref. no.	B1301080533
description	panneau pos. de montage en bas lar. 535mm P 15mm H 120mm plastique Q 1 pc		
Pour modèles:	HSC300N		

			
1			
référence	698983	ref. no.	B1301081009
description	panneau pos. de montage en haut per distribution lar. 593mm P 60mm H 65mm plastique Q 1 pc		
Pour modèles:	HSC300N		

			
1			
référence	698929	ref. no.	1.1.C.C46.04.08
description	panneau pos. de montage pour régulateur électronique lar. 185mm P 16mm H 93mm plastique Q 1 pc		
Pour modèles:	HCV1100		

			
1			
référence	698985	ref. no.	B1301081032
description	patte de fixation pos. de montage en haut per distribution lar. 283mm P 42mm H 54mm Q 1 pc		
Pour modèles:	HSC300N		

			
1			
référence	699407	ref. no.	S24AC20A0005
description	tôle pos. de montage en haut pour porte lar. 890mm P 115mm H 10mm		
Pour modèles:	HSA2600		

supports tablette

			
1			
référence	698978	ref. no.	B1301010365
description	supports tablette L 42mm lar. 42mm H 21.5mm pos. de montage à droite		
Pour modèles:	HSC300N, HSC300N-Silver		

			
1			
référence	698979	ref. no.	B1301010366
description	supports tablette L 42mm lar. 42mm H 21.5mm pos. de montage à gauche		
Pour modèles:	HSC300N, HSC300N-Silver		

boîtiers

			
1			
référence	692436	ref. no.	1.1.C.C21.03
description	boîtier lar. 128mm P 65mm H 38mm plastique Q 1 pc		
Pour modèles:	HCV1100		

			
1			
référence	699175	ref. no.	P04AC21A0003
description	boîtier pour partie de commande lar. 200mm P 115mm H 95mm		
Pour modèles:	HSA2600		

			
1			
référence	692437	ref. no.	1.1.C.C22.07
description	couverture de boîtier lar. 130mm P 70mm H 6mm plastique Q 1 pc		
Pour modèles:	HCV1100		

			
1			
référence	699298	ref. no.	HSC800-38
description	partie latérale pos. de montage en haut pour lampe lar. 40mm H 80mm L 280mm plastique		

cadre

			
1			
référence	698926	ref. no.	1.1.C.C16.01.10
description	cadre pos. de montage extérieur pour porte lar. 375mm P 16mm H 325mm plastique Q 1 pc		



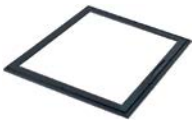

			
1			
référence	698925	ref. no.	1.1.C.C46.01.09
description	cadre pos. de montage intérieur pour porte lar. 385mm P 7mm H 330mm plastique Q 1 pc		
Pour modèles:	HCV1100		

parties laterales			
			
1			
référence	698921	ref. no.	1.1.C.C46.04.02
description	partie latérale pos. de montage à droite pour vitrine lar. 34mm P 448mm H 450mm plastique Q 1 pc		
Pour modèles:	HCV1100		

			
1			
référence	698919	ref. no.	1.1.C.C46.04.01
description	partie latérale pos. de montage à gauche pour vitrine lar. 34mm P 448mm H 450mm plastique Q 1 pc		
Pour modèles:	HCV1100		

autres			
			
1			
référence	699310	ref. no.	HSC800-47
description	capot L 500mm lar. 40mm épaisseur 0.5mm		

			
1			
référence	699315	ref. no.	HBC1002-39 HBC2003-39 SLZE0042
description	patte de fixation pour évaporateur L 55mm lar. 27mm H 6mm		
Pour modèles:	HBC1002, HBC2003, HBC2003G		

vitres			
			
1			
référence	692668	ref. no.	1.1.E.E2.08.47
description	vitre L 435mm lar. 445mm épaisseur 10.5mm pos. de montage à gauche/à droite pour vitrine		
Pour modèles:	HCV1100		

			
1			
référence	698924	ref. no.	1.1.E.E2.08.16
description	vitre L 650mm lar. 523mm H 12.5mm		

			
1			
référence	698930	ref. no.	1.1.E.E2.02.39
description	vitre Lmm lar. 360mm H 308mm épaisseur 10.5mm pour porte		

portes			
			
1			
référence	699379	ref. no.	BLGM9H01
description	porte vitrée lar. 440mm H 770mm avec rouleaux P 25mm d 8mm fourniture par transporteur routier uniquement		

			
1			
référence	698971	ref. no.	BLGM9S52 HBC2003-50
description	porte vitrée lar. 440mm H 770mm avec serrure pos. de montage à droite		
Pour modèles:	HBC2003, HBC2003G		





1

référence	699378	ref. no.	BLGM9H02
description	porte vitrée lar. 440mm H 770mm avec serrure pos. de montage à droite P 25mm		



1

référence	698973	ref. no.	BLGM9S01 HBC1002-44
description	porte vitrée lar. 440mm H 770mm pos. de montage à droite P 25mm		
Pour modèles:	HBC1002		



1

référence	698972	ref. no.	BLGM9S00 HBC1002-45
description	porte vitrée lar. 440mm H 770mm avec serrure pos. de montage à gauche		
Pour modèles:	HBC1002		
accessoires pour	698972		
	référence	902210	ref. no. HBC2003-52 JNMA0000
joint L 930mm Q 1 mesures 5x6mm			



1

référence	698969	ref. no.	BLGM9S57 HBC2003-48
description	porte vitrée lar. 440mm H 770mm pos. de montage à gauche		
Pour modèles:	HBC2003, HBC2003G		



1

référence	698970	ref. no.	BLGM9S5M HBC2003-49
description	porte vitrée lar. 440mm H 770mm avec serrure pos. de montage centré fourniture par transporteur routier uniquement		
Pour modèles:	HBC2003, HBC2003G		



1

référence	699380	ref. no.	BLGM9H00 GBC1001-44
description	porte vitrée lar. 600mm H 800mm P 30mm		

mécanique porte

divers



1

référence	694928	ref. no.	HBC1002-48 HBC2003-44 WJXC0000
description	aimant porte L 46mm lar. 16mm H 14.5mm		
Pour modèles:	HBC1002, HBC2003, HBC2003G		





 <p>1</p>			
référence	694929	ref. no.	HBC1002-49 HBC2003-45 WJXG000
description	plaque pour aimant L 45mm lar. 12mm H 1.5mm dist. fix. 32mm		
Pour modèles:	HBC1002, HBC2003, HBC2003G		

pour cuisinière vitrocéramique

plaques vitrocéramiques

vitrocéramiques

 <p>1</p>			
référence	694932	ref. no.	MBA000234
description	plaque céramique pour appareil à induction L 274mm lar. 274mm épaisseur 4mm		
Pour modèles:	HIC3500		
accessoires pour	694932		
	référence	890015	ref. no. —
	silicone à haute température OTTOSEAL S17 t.max. 285°C rouge/ brun cartouche 310ml		
	référence	890060	ref. no. —
	adhésif PACTAN 6076 310ml 250°C anthracite		

pour friteuses

fixations

 <p>1</p>			
référence	692544	ref. no.	2.02HDF4260701 HDF2128-023
description	éclisse de fixation L 63mm lar. 25mm H 15mm		
Pour modèles:	HDF2128		

couvercles

 <p>1</p>			
référence	698544	ref. no.	3.CP0603070100 GDF1104-032 HDF1108-035 HDF2128-036
description	poignée de poing poignée ø 50mm ø 70mm L 36mm plastique noir		
Pour modèles:	HDF1104, HDF1108, HDF2128		

divers

 <p>1</p>			
référence	694738	ref. no.	HDF1108-030 HDF2128-031
description	panneau tôle L 45mm H 1mm int. ø 30mm		

pour fours à convection/fours à vapeurs

vitres

 <p>1</p>			
référence	694950	ref. no.	VET30017
description	verre de porte pour cuiseur universel L 485mm pos. de montage intérieur lar. 415mm épaisseur 4mm		
Pour modèles:	HCO500		
 <p>1</p>			
référence	694951	ref. no.	VET05021
description	verre de porte pour cuiseur universel L 555mm pos. de montage extérieur lar. 425mm épaisseur 4mm		
Pour modèles:	HCO500		

pour appareils à induction



1

référence	699333	ref. no.	DQA020343R SLA010075
description	boîtier pour manette L 60mm lar. 58mm H 25.5mm		
Pour modèles:	HIC3500		



1

référence	699334	ref. no.	WJD000047
description	déflecteur pour appareil à induction L 280mm lar. 17mm H 14mm		
Pour modèles:	HIC3500		



1

référence	699331	ref. no.	WJD000050
description	dégraisseur L 125mm lar. 120mm H 9mm		
Pour modèles:	HIC3500		



1

référence	699336	ref. no.	AB300015
description	insert pour platine L 298mm lar. 267mm H 60mm		
Pour modèles:	HIC3500		



1

référence	699335	ref. no.	WJD000048
description	tôle L 320mm lar. 15mm H 29mm		
Pour modèles:	HIC3500		

pour sauteuses basculantes

divers



1

référence	523510	ref. no.	4.01.6202GBT294166
description	roulement rigide à billes type 6202-2RS arbre ø 15mm ø ext. 35mm lar. 11mm avec rondelles d'étanchéité roulement rainuré à billes DIN 625-1		
Pour modèles:	HVC1001		

pour fours

boîtiers et façades



1

référence	692763	ref. no.	DEF30123
description	capot pour four à convection L 320mm lar. 325mm H 62mm		
Pour modèles:	HCO500		

pour saladettes

boîtiers et façades



1

référence	692692	ref. no.	KITSR4AC2A00
description	entretoise L 168/330/534mm 6 pièces		
Pour modèles:	HSA2600		



1

référence	993263	ref. no.	P04AC20A0006
description	planche à couper L 950mm lar. 130mm H 20mm		
Pour modèles:	HSA2600		

boîtiers et façades

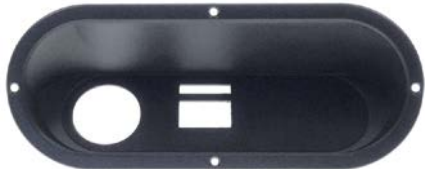

1

référence	699610	ref. no.	HVS1000-34 YJS820-34
description	front pour appareil de mise sous vide lar. 100mm H 40mm HVS1000 L 250mm		
Pour modèles:	HVS1000		

portes



1

référence	701546	ref. no.	S24AC22A0006
description	boulon de porte L 28mm pos. de montage en haut filetage L 8mmmm		
Pour modèles:	HSA2600		

amortisseur en caoutchouc



1

référence	699607	ref. no.	HVS1000-31 YJS820-31
description	tampon en caoutchouc H 3mm L 30mm lar. 20mm 4 pièces		
Pour modèles:	HVS1000		

pour machines à emballer sous-vide

couvercles



1

référence	699600	ref. no.	HVS1000-02 YJS820-2
description	couvercle L 420mm lar. 350mm HVS1000		
Pour modèles:	HVS1000		

barres de soudage



1

référence	699601	ref. no.	HVS1000-07 YJS820-7
description	barre de soudage L 295mm lar. 20mm H 24mm		
Pour modèles:	HVS1000		

cylindres d'air comprimé



1

référence	692702	ref. no.	HVS1000-17 YJS820-17
description	cylindre d'air comprimé ø 53mm H 30.5mm L. arbre 12.8mm 1 paire		
Pour modèles:	HVS1000		

cale d'épaisseur



1

référence	699617	ref. no.	HVS1000-24 YJS820-24
description	cale d'épaisseur L 132mm lar. 105mm H 0.5mm		
Pour modèles:	HVS1000		



1

référence	699611	ref. no.	HVS1000-01 YJS820-1
description	cale d'épaisseur L 30mm lar. 30mm H 2mm 1 paire trou ø 5mm		
Pour modèles:	HVS1000		



1

référence	699445	ref. no.	HVS1000-43 YJS820-43
description	cale d'épaisseur L 95mm lar. 90mm H 0.5mm		
Pour modèles:	HVS1000		

divers



1

référence	699613	ref. no.	HVS1000-13 YJS820-13
description	bouchon L 9mm lar. 6mm 1 paire		
Pour modèles:	HVS1000		



1

référence	699608	ref. no.	HVS1000-10 YJS820-10
description	écrou pour entrée d'air filetage 1/4"		
Pour modèles:	HVS1000		



1

référence	699605	ref. no.	HVS1000-14 YJS820-14
description	fermoir L 95mm lar. 34mm H 48mm		
Pour modèles:	HVS1000		



1

référence	699602	ref. no.	HVS1000-06 YJS820-6
description	rail caoutchouc L 298mm lar. 23mm H 9.5mm pour barre de soudure		
Pour modèles:	HVS1000		



1

référence	699609	ref. no.	HVS1000-12 YJS820-12
description	ressort L 104mm lar. 32mm to secure		
Pour modèles:	HVS1000		



1

référence	699604	ref. no.	HVS1000-48 YJS820-48
description	support L 38mm lar. 36mm H 124mm pour microrupteur		
Pour modèles:	HVS1000		

manettes

manettes universelles



1

référence	112733	ref. no.	3.ZCK165BT19010101MGB GDF1104-020 HDF1108-020 HDF2128-020
description	manette zéro mécanique t.max.°C ø 55mm axe ø 6x4,6mm plat en haut noir		
Pour modèles:	HDF1104, HDF1108, HDF2128		



autres

 <p>1</p>			
référence	692677	ref. no.	HSC350-20 SLZI0001
description	manette ø 26mm gris zéro mécanique pour thermostat logement d'axe 6x4mm Q 1		
Pour modèles:	HSC350, HSC350DD, HSC350G, HSC360, HSC360B, HSC360G, HSC360GB		

manettes en étoile

 <p>1</p>			
référence	692919	ref. no.	3.HBS3000095070100
description	manette en étoile filetage M8 ø 40mm L 32mm noir pour coupe-légumes		
Pour modèles:	HVC1001		

accessoires

rosaces

 <p>1</p>			
référence	111806	ref. no.	3.ZCK165BT20010101-1 GDF1104-019 HDF1108-019 HDF2128-019
description	rosace manette ø 16mm ø 55mm		
Pour modèles:	HDF1104, HDF1108, HDF2128		

profilés poignée

profilés poignée

 <p>1</p>			
référence	698869	ref. no.	HSC800-50 SLZB0037
description	profilé poignée filetage M4 L 300mm		
Pour modèles:	HSC800, HSC800G		

 <p>1</p>			
référence	699449	ref. no.	SLZB0020
description	profilé poignée pour réfrigérateur L 220mm lar. 36mm H 23mm gris dist.trou 120mm		
Pour modèles:	HSC350DD, HSC350G, HSC360, HSC360G		

poignées et volants

poignées cylindriques

fixe

 <p>1</p>			
référence	692918	ref. no.	3.HLC30000511A070100
description	poignée cylindrique filetage M10 ø 30mm L 97mm plastique pour coupe-légumes		
Pour modèles:	HVC1001		

poignées arquées

 <p>1</p>			
référence	699606	ref. no.	HVS1000-03 YJS820-3
description	poignée L 140mm H 38mm dist. fix. 120mm trou ø 8.5mm		
Pour modèles:	HVS1000		

 <p>1</p>			
référence	701522	ref. no.	B2205000001
description	poignée arquée L 340mm H 40mm dist. fix. 270mm trou ø 4x8mmmm lar. 26mm		
Pour modèles:	HSC300N		

autres



1

référence	692545	ref. no.	3.HDF409010101 GDF1104-025
description	poignée L 96mm lar. 64mm dist.trou 73mm pos. de montage panneau latéral noir		
Pour modèles:	HDF1104		

charnières four



1

référence	701592	ref. no.	CER30021 STA00028
description	set de charnières four dist. fix. 140mm longueur de levier 42mm écart des rainures 15mm épaisseur ressort 2.9mm L 170mm pos. de montage à gauche/à droite avec contre-support Q 2 pc		
Pour modèles:	HCO500		

charnières

charnières à ressort

spécifiques au fabricant

RWA



1

référence	701318	ref. no.	Z01AA02A0007
description	charnière à ressort pos. de montage à gauche/à droite L 75mm lar. 25mm H 100mm A 11mm B 15mm support 7,5x7,5 appareils froids dist. fix. 25.4mm		
Pour modèles:	RC700, RN700		



1

référence	701145	ref. no.	RC600.39 RN600.28
description	charnière à ressort pos. de montage en haut L 65mm lar. 23mm dist. fix. 21mm		
Pour modèles:	HFR2600, HRE2600		

boisseau



1

référence	701275	ref. no.	RC600.24 Z01AE62A0005
description	boulon L 19mm pos. de montage en bas filetage M6 ø 7mm pour charnière porte Q 1 pc		
Pour modèles:	HFR2600G, HRE2600		



1

référence	701264	ref. no.	RN600.16
description	boulon L 32mm pos. de montage en bas filetage M6 ø 7mm pour charnière porte Q 1 pc		
Pour modèles:	HFR2600		



1

référence	694927	ref. no.	HSC360-29
description	charnière L 105mm lar. 52mm H 34mm boulon 17mm boulon ø 7mm		



1

référence	692690	ref. no.	S24AC22A0003
description	charnière L 40mm lar. 70mm H 22mm distance de fixation 2 20mm		
Pour modèles:	HSA2600		





			
1			
référence	701144	ref. no.	RC600.20 RN600.12
description	charnière L 59mm lar. 27mm H 59mm pos. de montage en bas à gauche		
Pour modèles:	HFR2600, HRE2600		

			
1			
référence	701143	ref. no.	RC600.22 RN600.15
description	charnière L 59mm lar. 27mm H 59mm pos. de montage en bas droite Q 1 pc		
Pour modèles:	HFR2600, HRE2600		

			
1			
référence	694968	ref. no.	WJMA2020
description	charnière L 77mm lar. 19mm H 42mm dist. fix. 27mm distance de fixation 2 27mm pos. de montage milieu épaisseur 3mm boulon 18/22mm boulon ø 7mm		
Pour modèles:	HSC350DD		

			
1			
référence	694926	ref. no.	HSC360-23 WJMA2012
description	charnière L 82mm lar. 42mm H 50mm pos. de montage en bas boulon 19mm boulon ø 9mm		
Pour modèles:	HSC360, HSC360B, HSC360G, HSC360GB		

			
1			
référence	694866	ref. no.	HSC350-22 WJMA2003
description	charnière pos. de montage en bas L 82mm lar. 53mm H 43mm dist. fix. 30mm distance de fixation 2 56mm épaisseur 4mm boulon 20mm boulon ø 7mm		
Pour modèles:	HSC350, HSC350B, HSC350DD, HSC350G, HSC350GB		

			
1			
référence	694865	ref. no.	HSC350-32 WJMA0004
description	charnière pos. de montage en haut L 50mm lar. 33mm H 42mm dist. fix. 27mm épaisseur 3mm boulon 32.5mm boulon ø 9mm Q 1kg		
Pour modèles:	HSC350, HSC350B, HSC350DD, HSC350G, HSC350GB		

			
1			
référence	701280	ref. no.	WJMA4002
description	charnière porte L 42mm lar. 33mm H 82mm pos. de montage en bas droite/gauche set Q 1 pc		
Pour modèles:	GSC1100G		

			
1			
référence	701281	ref. no.	WJMA4005
description	charnière porte L 43mm lar. 82mm H 71mm pos. de montage en haut droite/gauche set Q 1 pc		
Pour modèles:	GSC1100G		

			
1			
référence	698987	ref. no.	A0706000012
description	charnière porte L 64mm lar. 24mm H 22.6mm pos. de montage en bas		
Pour modèles:	HSC300N, HSC300N-Silver		

			
1			
référence	698883	ref. no.	Z01AA02A0004
description	coussinet de pivotement L 180mm lar. 98mm pos. de montage en bas Q 1 pc		
Pour modèles:	RC700, RN700		

			
1			
référence	698885	ref. no.	S21AA02A0003
description	coussinet de pivotement L 55mm lar. 35mm H 80mm pos. de montage à droite épaisseur 3mm sans boulon		
Pour modèles:	RC700, RN700		



1

référence	698884	ref. no.	S21AA02A0002
description	coussinet de pivotement L 55mm lar. 35mm H 80mm pos. de montage à gauche épaisseur 3mm sans boulon		
Pour modèles:	RC700, RN700		



1

référence	701265	ref. no.	RC600.27 RN600.19
description	douille H 12mm pos. de montage en bas ø 19mm int. ø 14.5mm plastique pour charnière porte Q 1 pc		
Pour modèles:	HFR2600, HRE2600		



1

référence	701263	ref. no.	RC600.26 RN600.17 Z01AE62A0012
description	douille H 18mm pos. de montage en bas ø 14mm int. ø 7.2mm pour charnière porte Q 1 pc		
Pour modèles:	HFR2600, HFR2600G, HRE2600		



1

référence	699179	ref. no.	P01AA02A0008
description	support charnière L 78mm lar. 28mm H 22mm dist. fix. 27mm pos. de montage en bas droite épaisseur 3mm		
Pour modèles:	RC700, RN700		

accessoires

cale d'épaisseur



1

référence	701266	ref. no.	RC600.42 RN600.34 Z01AE62A0010
description	cale d'épaisseur L 88mm lar. 35mm épaisseur 3mm pour charnière porte pos. de montage en bas Q 1 pc		
Pour modèles:	HFR2600, HFR2600G, HRE2600		

sorties

galets roulement

galets roulement avec support



1

référence	692385	ref. no.	RC600.23 RN600.11
description	galet roulement rouleau ø 21mm B1 7mm avec support inox/plastique pos. de montage en bas palier roulement à billes Q 1 pc L 52mm dist. fix. 41mm		
Pour modèles:	HFR2600, HRE2600		

filtres

filtres à graisse

dégraisseur



1

référence	699331	ref. no.	WJD000050
description	dégraisseur L 125mm lar. 120mm H 9mm		
Pour modèles:	HIC3500		

accessoires



1

référence	699332	ref. no.	WJD000049
description	cadre inox pour filtre L 144mm lar. 152mm		
Pour modèles:	HIC3500		

pieds d'appareil et embouts

pieds d'appareil

avec plaque





1

référence	701499	ref. no.	KITFT1AA0A00
description	kit pied d'appareil tube ø 64mm dimension plaque 85x85mm dist. trou 56x56 jusqu'à 65x65mm H 120-185mm inox Q 4 pc		
Pour modèles:	RC700, RN700		





pieds vissés

 <p>1</p>			
référence	701593	ref. no.	PIE30010
description	pied d'appareil filetage M10 filetage L 18.5mm ø 49mm H 35mm plastique Q 4 pc		
Pour modèles:	HCO500		

 <p>1</p>			
référence	701262	ref. no.	RC600.19 RN600.13
description	pied d'appareil filetage M10 filetage L 40mm ø 36mm H 15.5mm Q 1 pc		
Pour modèles:	HFR2600, HRE2600		

 <p>1</p>			
référence	701588	ref. no.	AB300038
description	pied d'appareil filetage M5 filetage L 7mm ø 24mm H 20mm		
Pour modèles:	HIC3500		

 <p>1</p>			
référence	701587	ref. no.	AB300037
description	pied d'appareil filetage M6 filetage L 20mm ø 26mm H 11mm Q 1 pc		
Pour modèles:	HIC3500		

 <p>1</p>			
référence	701279	ref. no.	HSC350-14 WJLB0008
description	pied d'appareil filetage M8 filetage L 22mm ø 35mm H 38mm Q 1 pc		
Pour modèles:	HSC350, HSC350B, HSC350DD, HSC350G, HSC350GB, HSC360, HSC360B, HSC360G, HSC360GB		

 <p>1</p>			
référence	699434	ref. no.	1.1.CC32.18
description	pied d'appareil filetage M8 filetage L 24mm ø 28mm		
Pour modèles:	HCV1100		

 <p>1</p>			
référence	701521	ref. no.	B1301000186
description	pied d'appareil filetage M8 filetage L 28mm ø 30mm H 38mm Q 1 pc		
Pour modèles:	HSC300N, HSC300N-Silver		

pieds à visser

 <p>1</p>			
référence	701555	ref. no.	HVS1000-40 YJS820-40
description	kit pied d'appareil ø 39mm H 17mm Q 4 pc		
Pour modèles:	HVS1000		

 <p>1</p>			
référence	698546	ref. no.	3,0000161 GDF1104-026 HDF1108-023 HDF2128-024
description	pied d'appareil ø 29mm H 16mm caoutchouc trou ø 6mm Q 1 pc		
Pour modèles:	HDF1104, HDF1108, HDF2128		

TENTE

avec plaque

acier chromé

 <p>1</p>			
référence	710026	ref. no.	KITCS1AA0A00
description	jeu de roulettes pivotants ø 100mm à visser corps acier chromé dimension plaque 76x96mm dist.trou 60mm palier palier lisse corps de roue polypropylène H 135mm largeur de roue 32mm set		
Pour modèles:	RC700, RN700		

autres

avec plaque

ø30mm



référence	701277 ¹	ref. no.	HBC1002-24 HBC2003-24 WJLA1009
description	roue pivotante 2 avec et 2 sans frein ø 30mm plaque de fixation corps tôle d'acier zingué dimension plaque 61x51mm dist.troumm portance 60kg palier palier lisse corps de roue PVC surface roulement PVC H 44mm largeur de roue 23.5mm		
Pour modèles:	HBC1002, HBC2003, HBC2003G		

¹avec frein de roue



référence	701523	ref. no.	HSC350-13 WJLA2001
description	roue pivotante ø 31mm plaque de fixation H 45mm largeur de roue 22.5mm Q 1 pc		
Pour modèles:	HSC350, HSC350B, HSC350DD, HSC350G, HSC350GB, HSC360, HSC360B, HSC360G, HSC360GB		

ø75mm



référence	701282	ref. no.	HSC800-14 WJLA1002
description	jeu de roulettes pivotants 2 avec et 2 sans frein ø 75mm fixation plaques 102x83mm corps tôle d'acier zingué dist.trou 55/75mm palier palier lisse H 112mm largeur de roue 31mm Q 4 pc		
Pour modèles:	GSC1100G, HSC800, HSC800G		

paniers

grilles de fond



référence	970869	ref. no.	2.HDF405069510 GDF1104-028
description	grille de fond L 220mm lar. 160mm H 35mm 4 litres		
Pour modèles:	HDF1104		



référence	970870	ref. no.	2.HDF812020609510 HDF1108-032 HDF2128-033
description	grille de fond L 245mm lar. 200mm H 35mm 8 litres		
Pour modèles:	HDF1108, HDF2128		

grilles et crémailières

grilles

universels

sans bord relevé



référence	970801	ref. no.	HBC2003-40 WJGA9008
description	grille lar. 345mm P 400mm acier chromé épaisseur de cadre de grille 6mm épaisseur fils longitudinaux 2.5mm croisillons 4 Q 1 pc		
Pour modèles:	HBC2003, HBC2003G		



référence	970800	ref. no.	WJGA9002
description	grille lar. 345mm P 500mm acier chromé épaisseur de cadre de grille 6mm épaisseur fils longitudinaux 2.5mm croisillons 4 Q 1 pc		



référence	970906	ref. no.	HBC1002-40 WJGA9005
description	grille lar. 400mm P 345mm acier chromé épaisseur de cadre de grille 6mm croisillons 4		
Pour modèles:	HBC1002		



avec bord relevé



référence	970925	ref. no.	S14AC29A0001
description	grille lar. 325mm P 570mm GN 1/1 H 55mm acier plastifié épaisseur de cadre de grille 7.5mm épaisseur fils longitudinaux 4mm croisillons 3 gris		
Pour modèles:	HSA2600		



référence	970909	ref. no.	I01AA09A0002
description	grille lar. 530mm P 650mm GN 2/1 H 43mm acier plastifié épaisseur de cadre de grille 7mm épaisseur fils longitudinaux 4mm croisillons 3 gris		
Pour modèles:	RC700, RN700		
accessoires pour	970909		
	référence	701500	ref. no. KITGD1AA0A00
	couple de guides L 670mm lar. 15mm H 20mm pos. de montage à gauche/à droite paire		



référence	970791	ref. no.	RC600.28
description	grille lar. 650mm P 530mm GN 2/1 H 10mm acier plastifié en haut épaisseur de cadre de grille 8mm épaisseur fils longitudinaux 4mm croisillons 3 blanc		
Pour modèles:	HRE2600		

spécifiques au fabricant



référence	970792	ref. no.	RC600.25
description	grille lar. 185mm P 640mm acier plastifié en bas épaisseur de cadre de grille 7mm épaisseur fils longitudinaux 3.5mm blanc		
Pour modèles:	HRE2600		

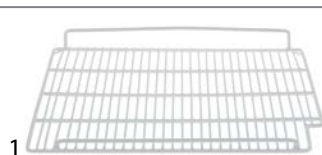

référence	970995	ref. no.	HSC800G.16 left WJGA4071
description	grille lar. 445mm P 480mm H 40mm acier plastifié épaisseur de cadre de grille 6mm épaisseur fils longitudinaux 3.5mm croisillons 3		



référence	970996	ref. no.	HSC800G.16 right WJGA4073
description	grille lar. 445mm P 480mm H 40mm acier plastifié épaisseur de cadre de grille 6mm épaisseur fils longitudinaux 3.5mm croisillons 3		



référence	970921	ref. no.	HSC350-44 WJGA2010
description	grille lar. 500mm P 425mm H 38mm acier plastifié épaisseur de cadre de grille 6.5mm épaisseur fils longitudinaux 2.5mm croisillons 6 blanc Q 1kg		
Pour modèles:	HSC350, HSC350DD, HSC350G		



référence	970910	ref. no.	HSC360-38 WJGA2023
description	grille lar. 530mm P 380mm H 40mm acier plastifié épaisseur de cadre de grille 6mm épaisseur fils longitudinaux 3mm croisillons 23		



référence	970799	ref. no.	WJGA4078
description	grille lar. 540mm P 505mm H 41mm acier plastifié épaisseur de cadre de grille 6mm épaisseur fils longitudinaux 3mm croisillons 3 blanc Q 1 pc		
Pour modèles:	GSC1100G		



référence	970916	ref. no.	1.1.B.B02.05.03
description	grille lar. 610mm P 310mm acier chromé épaisseur de cadre de grille 5mm épaisseur fils longitudinaux 3mm croisillons 5		
Pour modèles:	HCV1100		



référence	971150	ref. no.	RC600.09
description	grille lar. 693mm P 303mm H 6mm acier plastifié épaisseur fils longitudinaux 4mm croisillons 4 blanc		
Pour modèles:	HRE2600		



1

référence	971149	ref. no.	RN600.05
description	grille lar. 715mm H 55mm acier plastifié L 365mm épaisseur fils longitudinaux 4mm croisillons 4 blanc		
Pour modèles:	HFR2600		

accessoires



1

référence	699311	ref. no.	HSC800-46
description	profil L 400mm lar. 28mm H 15mm pour grille		

crémailières et supports

spécifiques au fabricant



1

référence	696443	ref. no.	KITGD4AC2A00
description	couple de guides forme U L 548mm lar. 20mm hauteur intérieur 13mm pos. de montage à gauche/à droite		
Pour modèles:	HSA2600		



1

référence	701500	ref. no.	KITGD1AA0A00
description	couple de guides L 670mm lar. 15mm H 20mm pos. de montage à gauche/à droite paire		
Pour modèles:	RC700, RN700		



1

référence	701269	ref. no.	RC600.29
description	crémailière L 1172mm lar. 22mm aluminium dist.trou 13mm Q 1 pc trou 3x8mm		
Pour modèles:	HRE2600		



1

référence	698887	ref. no.	HSC800-27
description	crémailière L 1400mm lar. 25mm H 4.5mm dist.trou 21mm Q 1 pc		



1

référence	701550	ref. no.	S24AC29A0002
description	crémailière L 244mm lar. 50mm H 8mm pos. de montage à l'avant		
Pour modèles:	HSA2600		



1

référence	701549	ref. no.	S24AC29A0005
description	crémailière L 245mm lar. 40mm H 30mm pos. de montage à droite		
Pour modèles:	HSA2600		



1

référence	701548	ref. no.	S24AC29A0004
description	crémailière L 245mm lar. 40mm H 30mm pos. de montage à gauche		
Pour modèles:	HSA2600		



1

référence	698882	ref. no.	S21AA09A0001
description	guide L 1240mm lar. 35mm hauteur intérieur 30mm largeur crochet 16.5mm pos. de montage à gauche/à droite		
Pour modèles:	RC700, RN700		



1



référence	698870	ref. no.	HBC1002-26 HBC2003-26 LCCJ2001
description	guide L 390mm lar. 25mm pos. de montage à gauche/à droite hauteur intérieur 4mm		
Pour modèles:	HBC1002, HBC2003, HBC2003G		

2



référence	692398	ref. no.	HBC1002-41 HBC1003-41 HBC2003-41 LCCK0002
description	supports tablette L 24mm lar. 9mm H 29mm aluminium pour réfrigérateur Q 1 pc		
Pour modèles:	HBC1002, HBC2003, HBC2003G		

1



référence	692387	ref. no.	RC600.32
description	supports tablette L 31/28mm lar. 22mm H 19mm Q 1 pc		
Pour modèles:	HRE2600		

1



référence	694591	ref. no.	HSC350-27 SLZE0028
description	supports tablette L 33mm lar. 9mm H 27mm aluminium pour réfrigérateur Q 1 pc		
Pour modèles:	HSC350, HSC350B, HSC350DD, HSC350G, HSC350GB		

joint

joint de meuble froid

joint tubulaires

profil 9146

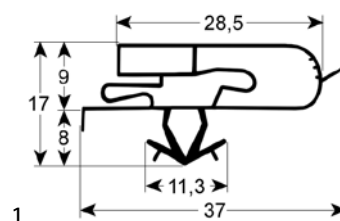

référence	902133	ref. no.	R01AA02A0005
description	joint froid profil 9146 lar. 630mm L 1500mm dimension d'insertion		
Pour modèles:	RC700, RN700		

profil 9149

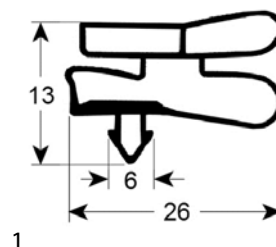

référence	902216	ref. no.	R04AC22A0002
description	joint froid profil 9149 lar. 385mm L 480mm dimension d'insertion		
Pour modèles:	HSA2600		

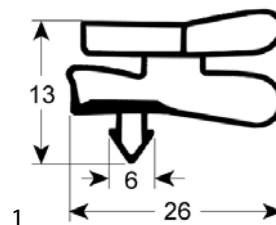

référence	901524	ref. no.	RC600.40 RN600.29
description	joint froid profil 9149 lar. 720mm L 1710mm dimension d'insertion		
Pour modèles:	HFR2600, HRE2600		

profil 9156

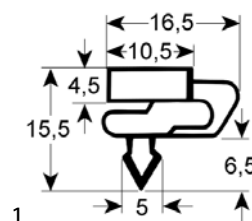

référence	901674	ref. no.	SLJP9002
description	joint froid profil 9156 lar. 415mm L 775mm dimension d'insertion Q 1 pc		

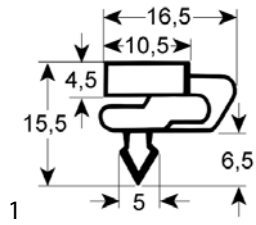

référence	901648	ref. no.	HSC350-45 SLJP2010
description	joint froid profil 9156 lar. 595mm L 1340mm dimension d'insertion Q 1 pc		
Pour modèles:	HSC350, HSC350G		

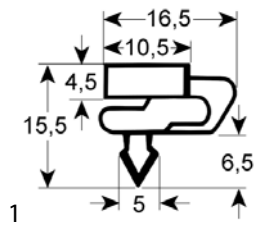

référence	901662	ref. no.	SLJP4007
description	joint porte profil 9156 lar. 569mm L 1295mm dimension d'insertion Q 1 pc		
Pour modèles:	GSC1100G		

profil 9161

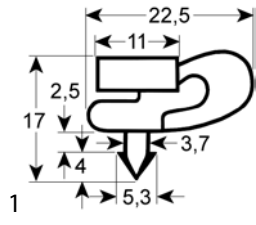

référence	902208	ref. no.	HSC360-39 SLJP2025
description	joint froid profil 9161 lar. 590mm L 1540mm dimension d'insertion		
Pour modèles:	HSC360, HSC360G		

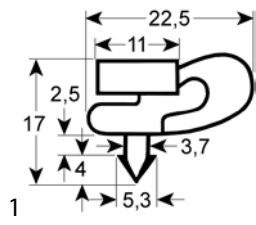

référence	902465	ref. no.	SLJP2015
description	joint froid profil 9161 lar. 590mm L 650mm dimension d'insertion		
Pour modèles:	HSC350DD		

profil 9314

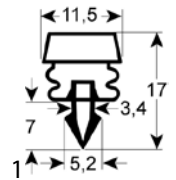

référence	902158	ref. no.	HSC800-53
description	joint froid profil 9314 lar.mm L 1200mm dimension d'insertion		

autres

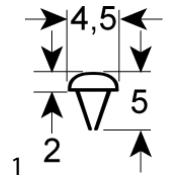

référence	902210	ref. no.	HBC2003-52 JNMA0000
description	joint L 930mm Q 1 mesures 5x6mm		
Pour modèles:	HBC1002, HBC2003		

jointts thermiques

jointts porte

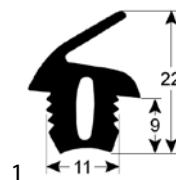

référence	902446	ref. no.	GUA30015
description	joint porte profil 2718 L 5500mm		
Pour modèles:	HCO500		

jointts toriques

silicone

ø1,78mm

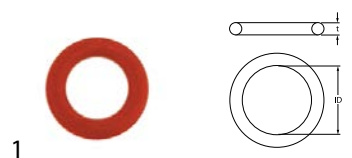

référence	371100	ref. no.	HVS1000-04 YJS820-4
description	joint torique silicone épaisseur 1.78mm int. ø 6.07mm Q 1 pc		
Pour modèles:	HVS1000		



jointes arbre

jointes arbre



1

référence	692922	ref. no.	4.01.FB1535721
description	joint SPI int. ø 15mm ø ext. 35mm pour coupe-légumes H 15mm		
Pour modèles:	HVC1001		

jointes spéciaux

pour machines à emballer sous-vide



1

référence	699618	ref. no.	HVS1000-08 YJS820-8
description	joint couvercle L 1365mm		
Pour modèles:	HVS1000		

autres



1

référence	698543	ref. no.	3.0000403 HDF1108-037 HDF2128-038
description	joint hauteur extérieur 4mm ø ext. 25mm int. ø 16mm		
Pour modèles:	HDF1108, HDF2128		



1

référence	698545	ref. no.	3.0000404 HDF1108-036 HDF2128-037
description	joint ø ext. 31mm int. ø 21mm		
Pour modèles:	HDF1108, HDF2128		

composants du circuit frigorifique

vannes

vannes Schrader

valves Schrader complètes



1

référence	750636	ref. no.	C01AA06A0003
description	valve Schrader complet raccord 1/4"SAE ø 6mm L 120mm		
Pour modèles:	RC700, RN700		

filtres déshydrateurs

accessoires

supports



1

référence	699297	ref. no.	HBC1002-10 HBC2003-10 HSC360-15 HSC800-11 SLJAC008
description	support L 40mm lar. 30mm H 31mm int. ø 18mm ø ext. 22mm pour déshydrateur		
Pour modèles:	GSC1100G, HBC1002, HBC2003, HBC2003G, HSC350, HSC350B, HSC350DD, HSC350G, HSC350GB, HSC360, HSC360B, HSC360G, HSC360GB, HSC800, HSC800G		

autres



1

référence	750381	ref. no.	HBC1002-09 HBC2003-09 HSC360-14 TCGV0002
description	déshydrateur ø 18.5mm L 115.5mm raccord 2,4/5,2mm Q 1 pc		
Pour modèles:	HBC1002, HBC2003, HBC2003G, HSC350, HSC350B, HSC350DD, HSC350G, HSC350GB, HSC360, HSC360B, HSC360G, HSC360GB		



1

référence	750693	ref. no.	1.1.A.A04.01
description	déshydrateur ø 19mm L 120.5mm raccord 2/5mm Q 1 pc		
Pour modèles:	HCV1100		

1 

référence	750378	ref. no.	C01AE66A0001 RC600.03 RN600.04
description	déshydrateur ø 19mm L 145mm raccord 4,5/8mm type XH9 Q 1 pc		
Pour modèles:	HFR2600, HFR2600G, HRE2600, HSA2600		

1 

référence	750641	ref. no.	C01AA06A0001
description	déshydrateur ø 29mm L 120.5mm raccord 8/8mm Q 1 pc		
Pour modèles:	RC700, RN700		

1 

référence	750382	ref. no.	HSC350-10 HSC800-10 TCGV0002 HSC350-10 TCGV0009
description	déshydrateur ø 18.5mm L 120mm raccord 4/7mm Q 1 pc		
Pour modèles:	GSC1100G, HSC800, HSC800G		
accessoires pour	750382		
	référence	694868	ref. no. HSC350-11
	support pour déshydrateur L 40mm lar. 30mm H 31mm Q 1 pc		

1 

référence	750635	ref. no.	C01AA06A0006
description	déshydrateur ø 58mm L 120mm raccord 1/4" ODF type SDCL-0325 Q 1 pc		
Pour modèles:	RC700, RN700		

conduits fréon

tubes capillaires

1 

référence	694914	ref. no.	C01AA06A0002
description	tube capillaire L 2790mm ø ext. 1.4mm Q 1		
Pour modèles:	RC700, RN700		

tubes de cuivre non isolés

1 

référence	692418	ref. no.	1.1.B.B06.26
description	conduit fréon cuivre int. ø 5mm lon. 1m ø ext. 6mm Q 1		
Pour modèles:	HCV1100		

1 

référence	692699	ref. no.	1.1.B.B06.27
description	conduit fréon int. ø 3.5mm lon. 0.1m ø ext. 5mm		

1 

référence	692730	ref. no.	HBC1002-12 HBC2003-12 TCGO3004
description	tube de cuivre int. ø 4mm lon. 0.095m ø ext. 6mm		
Pour modèles:	HBC1002, HBC2003, HBC2003G		



tubes de cuivre isolés



1

référence	694913	ref. no.	C01AA06A0004
description	tube de cuivre avec isolation épaisseur 8mm épaisseur isolation 4mm L 1060mm Q 1		
Pour modèles:	RC700, RN700		

isolations



1

référence	694930	ref. no.	RC600.10
description	tuyau d'isolation épaisseur 8mm modèle 3/8"x5/8" réfrigération int. ø 20mm		
Pour modèles:	HRE2600		

tubes chauffantes



1

référence	701501	ref. no.	C01AA06A0005
description	radiateur ø ext. 6.5mm int. ø 4.5mm L 210mm Q 1		
Pour modèles:	RC700		

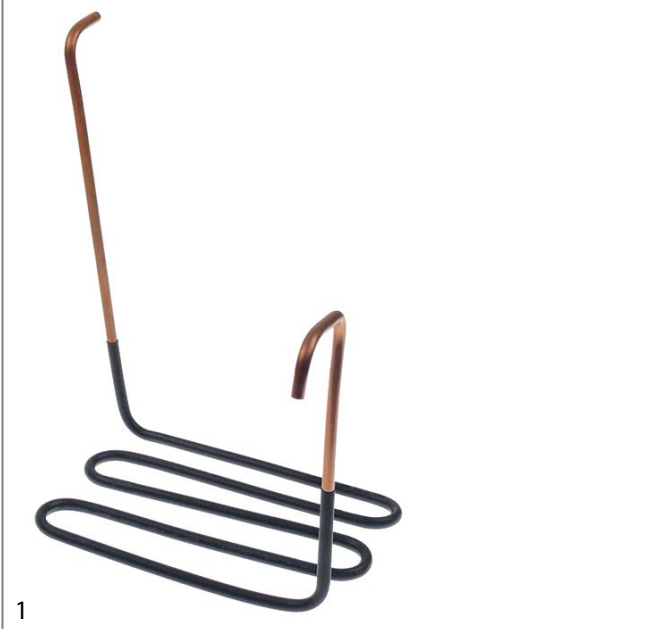

1

référence	701556	ref. no.	C01AA46A0005
description	radiateur ø ext. 6.5mm int. ø 5mm L 200mm		
Pour modèles:	RN700		



1

référence	701584	ref. no.	RC600.07 RC600.15
description	radiateur ø ext. 6mm int. ø 5mm L 330mm cuivre		
Pour modèles:	HRE2600		

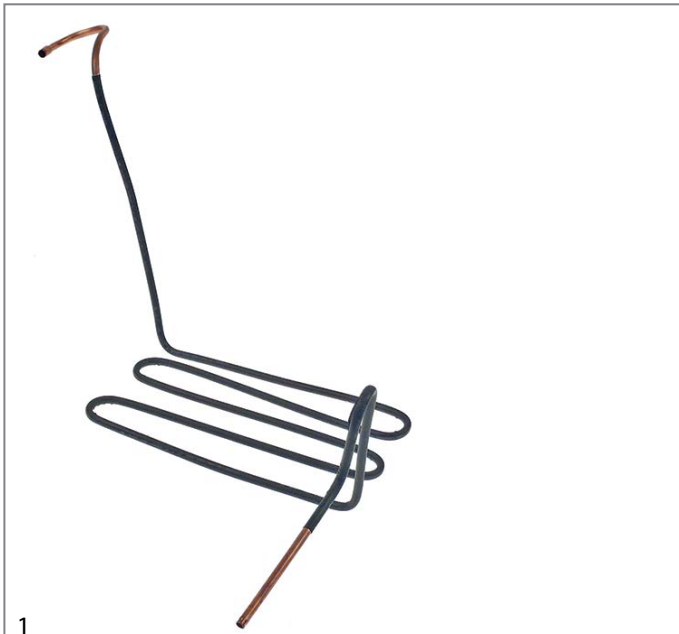

1

référence	701495	ref. no.	HSC800-08 TCGD4010
description	radiateur ø ext. 6mm int. ø 5mm Q 1m pour évaporateur raccord ø 6mm		
Pour modèles:	GSC1100G, HSC800, HSC800G		

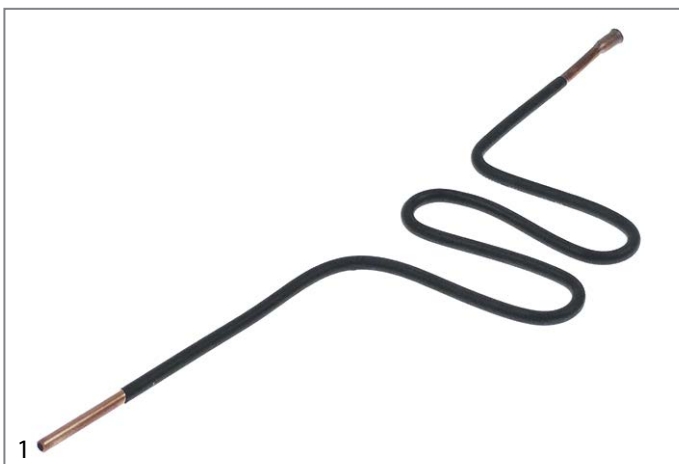

1

référence	701432	ref. no.	HSC350-08 HSC360-12 TCGD2012
description	radiateur tube ø ext. 5mm int. ø 3mm L 350mm cuivre Q 1		

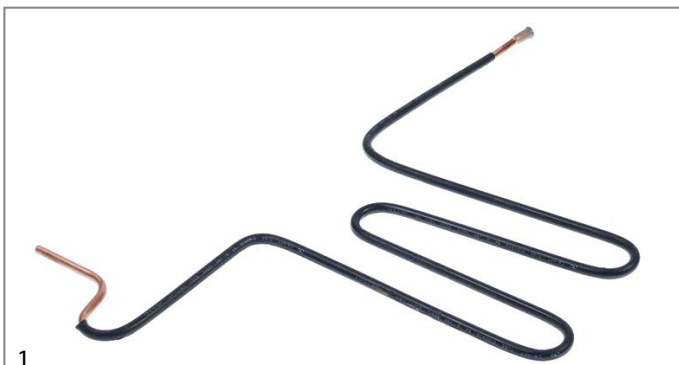

1

référence	701582	ref. no.	HBC1002-11 HBC2003-11 TCGD2001
description	radiateur tube ø ext. 5mm int. ø 3mm L 355mm H 250mm		

évaporateurs pour réfrigérateurs

spécifiques au fabricant



1

référence	750640	ref. no.	C01AA48A0001
description	condenseur L 245mm lar. 255mm P 160mm hauteur totale 290mm		
Pour modèles:	RN700		



1

référence	750634	ref. no.	HBC2003-38
description	évaporateur L 1000mm lar. 510mm		

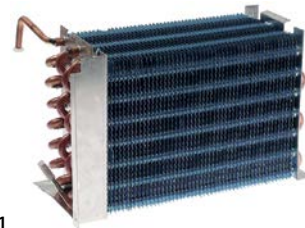

1

référence	750638	ref. no.	C01AA07A0001
description	évaporateur L 245mm lar. 135mm H 190mm longueur totale 310mm largeur totale 230mm hauteur totale 190mm		
Pour modèles:	RC700		



1

référence	750637	ref. no.	C01AA08A0001
description	évaporateur L 257mm lar. 255mm H 122mm largeur totale 260mm distance de fixation 1 187mm		
Pour modèles:	RC700		

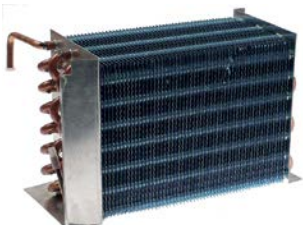
1

référence	750639	ref. no.	C01AA47A0001
description	évaporateur L 305mm lar. 185mm H 135mm longueur totale 290mm		
Pour modèles:	RN700		



1

référence	750660	ref. no.	HSC800-42 TLZA4003
description	évaporateur L 620mm lar. 225mm H 160mm		
Pour modèles:	HSC800		



1

référence	750375	ref. no.	TLZA4004
description	évaporateur L 760mm lar. 140mm H 225mm		



1

référence	750367	ref. no.	RN600.31
description	évaporateur pour congélateur armoire GFR2600 L 600mm lar. 450mm H 1200mm		
Pour modèles:	HFR2600		



1

référence	750766	ref. no.	A0802010015
description	évaporateur pour congélateur armoire lar. 450mm H 1200mm L 600mm HSC300N		
Pour modèles:	HSC300N, HSC300N-Silver		



1

référence	750387	ref. no.	TLZA9000
description	évaporateur pour réfrigérateur GBC1001 L 430mm lar. 500mm		



1

référence	750376	ref. no.	HBC1002-38 TLZD9001
description	évaporateur pour réfrigérateur GBC1002 L 760mm lar. 500mm		
Pour modèles:	HBC1002		



1

référence	750456	ref. no.	HSC360-21 TLZD2008
description	évaporateur pour réfrigérateur HSC360 L 780mm lar. 495mm		



1

référence	750361	ref. no.	RC600.04
description	évaporateur pour réfrigérateur L 1000mm lar. 471mm		
Pour modèles:	HRE2600		



1

référence	750377	ref. no.	TLZD9002
description	évaporateur pour réfrigérateur L 1000mm lar. 500mm		
Pour modèles:	HBC2003, HBC2003G		

pour vitrine réfrigérée



1

référence	750648	ref. no.	1.1.A.A10.85
description	évaporateur L 305mm lar. 50mm H 115mm longueur totale 305mm largeur totale 50mm hauteur totale 150mm		
Pour modèles:	HCV1100		

accessoires

divers



1

référence	701268	ref. no.	RN600.32
description	profil en U pour évaporateur L 635mm lar. 16mm H 13mm aluminium Q 1 pc		
Pour modèles:	HFR2600		

condensateurs

filtres



1

référence	699402	ref. no.	P04AC28A0002
description	filtre pour condensateur L 218mm lar. 230mm épaisseur 6mm Q 1 pc		
Pour modèles:	HSA2600		

condensateurs

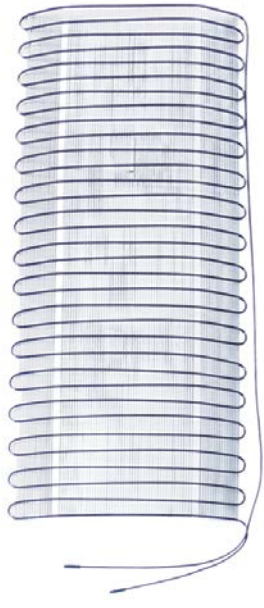

1

référence	750346	ref. no.	HSC350-02
description	condenseur L 1430mm lar. 520mm		
Pour modèles:	HSC350, HSC350B		



1

référence	750373	ref. no.	DTLA9002 HBC2003-06
description	condenseur lar. 190mm P 160mm H 205mm Q 1 pc		
Pour modèles:	HBC2003, HBC2003G		



référence	750372	ref. no.	DTLA9000
description	condenseur lar. 195mm P 80mm H 205mm Q 1 pc		

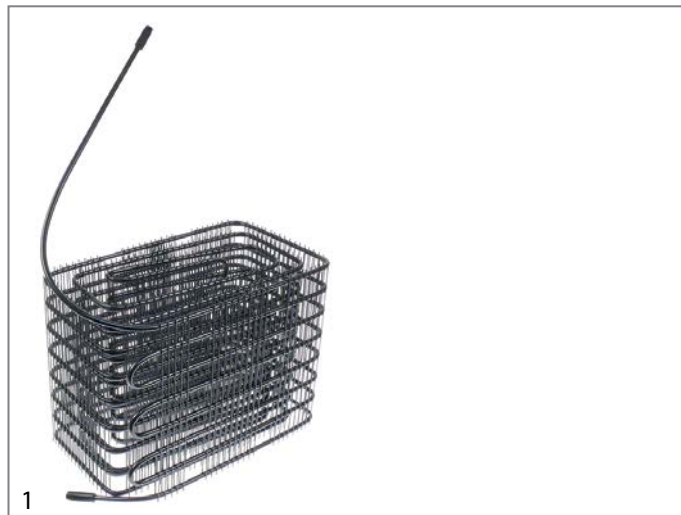

référence	750659	ref. no.	HSC800-06
description	condenseur lar. 290mm P 180mm H 215mm Q 1 pc		



référence	750347	ref. no.	C04AC28A0001
description	condenseur lar. 220mm P 100mm H 230mm L 270mm		
Pour modèles:	HSA2600		



référence	750374	ref. no.	DTLA4008
description	condenseur lar. 555mm P 100mm H 275mm Q 1 pc		



référence	750385	ref. no.	HBC1002-06
description	condenseur lar. 255mm P 180mm H 205mm Q 1 pc		

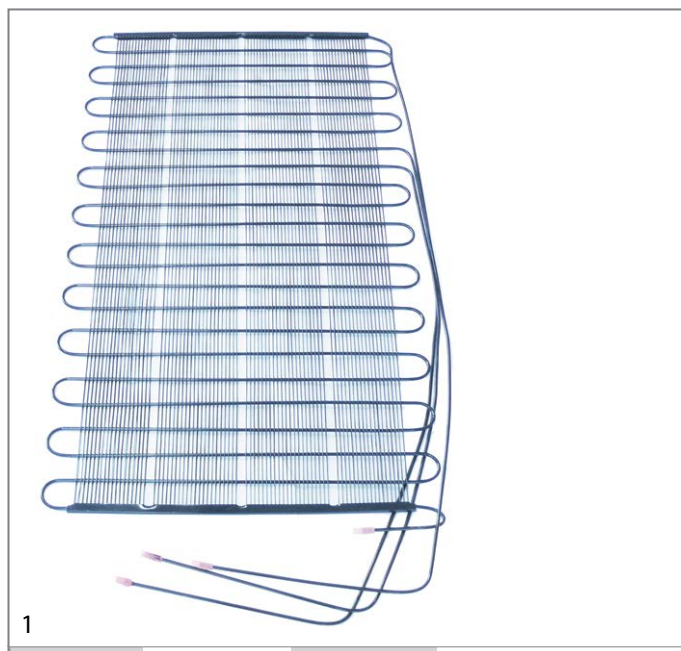

référence	750379	ref. no.	RN600.03
description	condenseur pour congélateur armoire lar. 640mm H 1165mm Q 1 pc		
Pour modèles:	HFR2600		

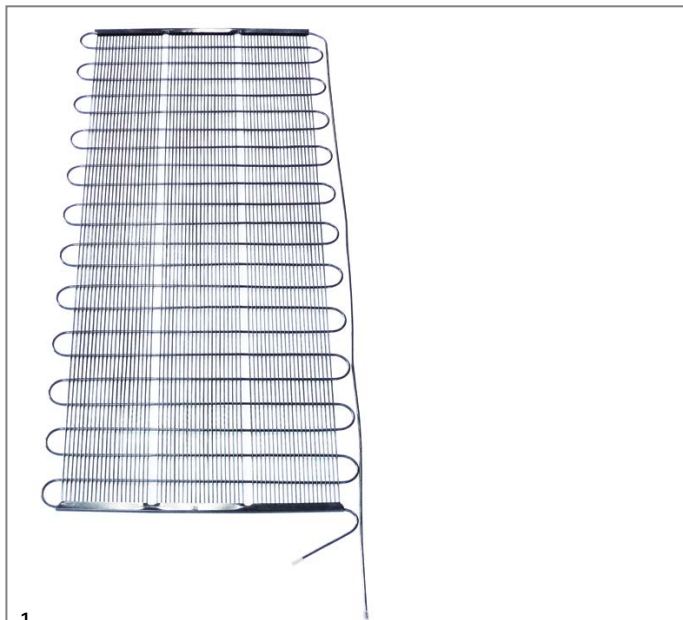

1	référence	750360	ref. no.	RC600.05
	description	condenseur pour réfrigérateur lar. 500mm H 1170mm Q 1 pc		
	Pour modèles:	HRE2600		



1	référence	750649	ref. no.	1.1.A.A09.08
	description	condenseur pour vitrine lar. 330mm P 140mm H 280mm Q 1 pc		

bacs de dégivrage et d'évaporation

bacs de dégivrage

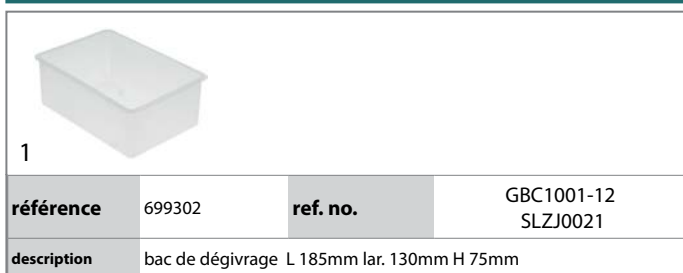

1	référence	699302	ref. no.	GBC1001-12 SLZJ0021
	description	bac de dégivrage L 185mm lar. 130mm H 75mm		

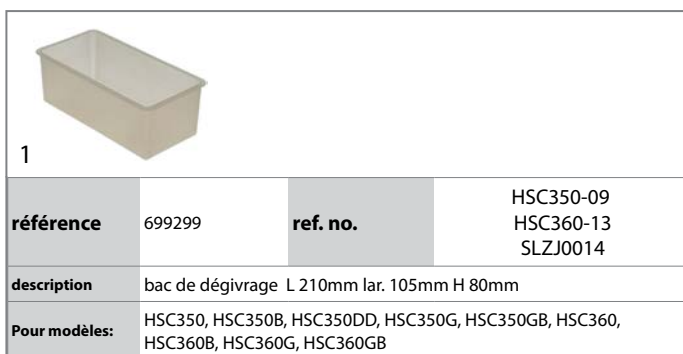

1	référence	699299	ref. no.	HSC350-09 HSC360-13 SLZJ0014
	description	bac de dégivrage L 210mm lar. 105mm H 80mm		
	Pour modèles:	HSC350, HSC350B, HSC350DD, HSC350G, HSC350GB, HSC360, HSC360B, HSC360G, HSC360GB		

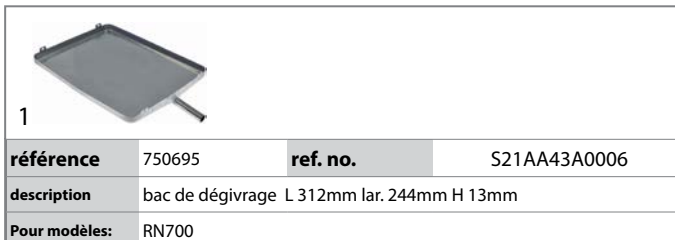

1	référence	750695	ref. no.	S21AA43A0006
	description	bac de dégivrage L 312mm lar. 244mm H 13mm		
	Pour modèles:	RN700		

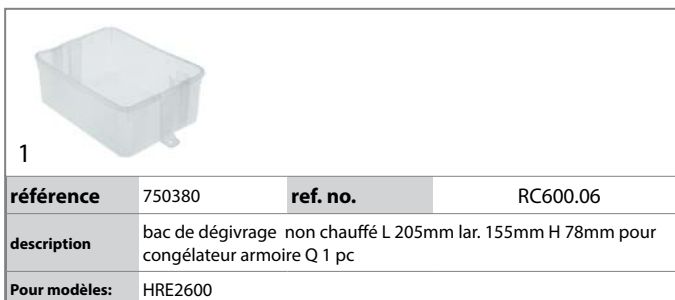

1	référence	750380	ref. no.	RC600.06
	description	bac de dégivrage non chauffé L 205mm lar. 155mm H 78mm pour congélateur armoire Q 1 pc		
	Pour modèles:	HRE2600		

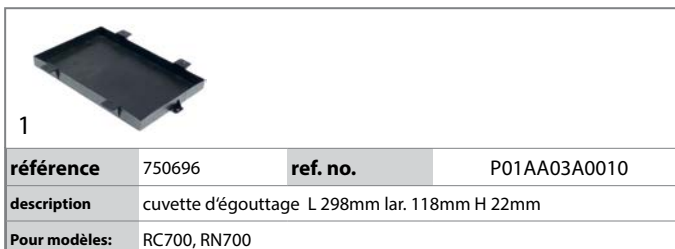

1	référence	750696	ref. no.	P01AA03A0010
	description	cuvette d'égouttage L 298mm lar. 118mm H 22mm		
	Pour modèles:	RC700, RN700		

bacs d'évaporation sans résistance

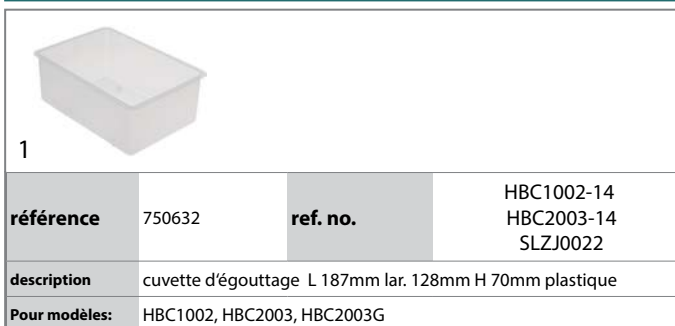

1	référence	750632	ref. no.	HBC1002-14 HBC2003-14 SLZJ0022
	description	cuvette d'égouttage L 187mm lar. 128mm H 70mm plastique		
	Pour modèles:	HBC1002, HBC2003, HBC2003G		

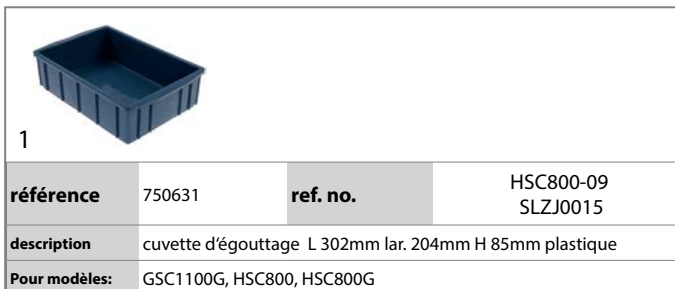

1	référence	750631	ref. no.	HSC800-09 SLZJ0015
	description	cuvette d'égouttage L 302mm lar. 204mm H 85mm plastique		
	Pour modèles:	GSC1100G, HSC800, HSC800G		



force motrice et roulements à billes

roulements à billes

roulements rigide à billes 2RS



1

référence	523510	ref. no.	4.01.6202GBT294166
description	roulement rigide à billes type 6202-2RS arbre ø 15mm ø ext. 35mm lar. 11mm avec rondelles d'étanchéité roulement rainuré à billes DIN 625-1		
Pour modèles:	HVC1001		

ressorts

ressorts de compression



1

référence	692701	ref. no.	1.1.B.B10.06
description	ressort L 4mm fil ø 1mm spires 5 D1 ø 9.5mm		



1

référence	692920	ref. no.	4.02.00000049
description	ressort de compression ø 10mm L 18mm fil ø 1mm spires 5.75 pour coupe-légumes		
Pour modèles:	HVC1001		

ressort à gaz

ressort à gaz



1

référence	701554	ref. no.	HVS1000-46 YJS820-46
description	ressort à gaz à droite 80N D1 ø 6mm D2 ø 15mm L 162mm HVS1000		
Pour modèles:	HVS1000		



1

référence	701553	ref. no.	HVS1000-21 YJS820-21
description	ressort à gaz à gauche 80N D1 ø 6mm D2 ø 15mm L 162mm HVS1000		
Pour modèles:	HVS1000		

manomètres



1

référence	542340	ref. no.	HVS1000-35 YJS820-35
description	manomètre ø 41mm gamme de pression 0-1bar raccord 5mm		
Pour modèles:	HVS1000		

tuyaux

tuyaux formés

autres



1

référence	699420	ref. no.	1.1.C.C41.13
description	tuyau formé int. ø 19mm ø ext. 24mm L 150mm		
Pour modèles:	HCV1100		

raccords, connecteurs flexible et tube

connecteurs flexibles

sans raccord fileté



1

référence	699612	ref. no.	HVS1000-15 YJS820-15
description	raccord en T plastique tuyau ø 5-5-5mm		
Pour modèles:	HVS1000		



1

référence	504817	ref. no.	HVS1000-29 YJS820-29
description	raccord en T inox tuyau ø 10-10-10mm		
Pour modèles:	HVS1000		



1

référence	504823	ref. no.	HVS1000-28 YJS820-28
description	croix inox tuyau ø 10-10-10-10mm L 57mm lar. 57mm		
Pour modèles:	HVS1000		

raccords tuyau

spécifiques au fabricant



1

référence	699615	ref. no.	HVS1000-11 YJS820-11
description	embout tuyau pour flexible DI 10mm raccord 1/4"mm forme L		
Pour modèles:	HVS1000		

technique de mesure

thermomètres

thermomètres muraux

à plies



1

référence	381411	ref. no.	A0812010004
description	thermomètre dimensions de montage 47x27mm comp. piles à l'arrière -50 jusqu'à +70°C sonde ø6x20mm longueur de câble 1500mm		
Pour modèles:	HSC300N, HSC300N-Silver		

matériels de fixation

vis

vis tête hexagonale



1

référence	699616	ref. no.	HVS1000-23 YJS820-23
description	vis filetage M10 filetage L 26mm OC 17 Q 2 pc épaisseur tête 7mm L 60mm		
Pour modèles:	HVS1000		

écrous

écrous six pans

DIN 934 / ISO 4032/8673



1

référence	560197	ref. no.	HVS1000-20 YJS820-20
description	écrou filetage M10 H 8mm OC 17 inox DIN/ISO DIN 934 / ISO 4032/8673 Q 1 pc		
Pour modèles:	HVS1000		



1

référence	506166	ref. no.	HVS1000-16 YJS820-16
description	écrou filetage M12 H 10mm OC 19 inox DIN/ISO DIN 934 / ISO 4032/8673 Q 1 pc		
Pour modèles:	HVS1000		

autres



1

référence	551380	ref. no.	DAD30010
description	écrou cage filetage M10 Q 4 pc		
Pour modèles:	HCO500		



rondelles

rondelles

autres



1

référence	560593	ref. no.	HVS1000-22 YJS820-22
description	rondelle int. ø 10.5mm ø ext. 15.8mm épaisseur 1mm inox Q 4 pc		
Pour modèles:	HVS1000		

fixations

goupilles fendues



1

référence	692923	ref. no.	4.01.D05035GBT879_512
description	goupille fendue ø 5mm L 35mm		
Pour modèles:	HVC1001		

A			
accessoires électriques	24	joint de meuble froid	49
B		joint porte	50
ballasts	9	joint thermique	50
bobines d'induction	3	joint toriques	50
boîtes de dérivation	26	joint tubulaires	49
bornes	26	L	
C		lampes	7
câbles	24	lampes four	11
câbles alimentation pour appareils	24	lampes pour réfrigérateurs	10
câbles PVC	25	LED	7
câbles rallonge	25	M	
charnières à ressort	42	matériels de fixation	60
charnières four	42	microrupteurs	6
composants du circuit frigorifique	51	microrupteurs magnétiques	6
compresseurs	16	minuteries	11
condensateurs & filtres antiparasites	24	minuteries mécaniques	11
condensateurs de démarrage	24	moteurs	23
conduits fréon	52	moteurs froids universels	20
connecteurs flexibles	59	P	
cordons chauffants	3	pas-câbles	25
É		pas-câbles à vis	25
écrous	60	pompes	24
écrous six pans	60	pompes aspirantes	24
électrovannes	16	prises/connecteurs pour appareils	24
évaporateurs	54	R	
F		raccords tuyau	60
fiches - embouts - prises femelles	24	régulateurs électroniques	12
filtres déshydrateurs	51	relais	11
fins de course	6	résistances	3
fixations	61	résistances circulaires	3
fusibles	24	résistances de dégivrage	3
G		résistances pour friteuses	3
goupilles fendues	61	résistances réfrigération	3
grilles	46	rondelles	61
grilles et crémaillères	46	roulettes et angles de protection	45
groupe 1	52	S	
groupe 4	52	serres cable	25
I		sondes	14
interrupteurs et boutons-poussoirs	5	sondes de température	14
interrupteurs et poussoirs	5	sondes universelles	14
interrupteurs/poussoirs à bascule	5	starter	9
isolations	53	T	
J		technique de mesure	60
joint arbre	51	thermostats	4
		thermostats contact	4,4
		thermostats de réglage	4
		thermostats froid	4

transformateurs	11
tubes capillaires	52
tubes de cuivre isolés	53
tubes de cuivre non isolés	52
tubes fluorescents	8, 8
tuyaux	59
tuyaux formés	59

V

vannes Schrader	51
ventilateurs	19
ventilateurs à air chaud	23
ventilateurs axiaux	19
ventilateurs froids	20, 22
ventilateurs tangentiels	22
vis	60
vis tête hexagonale	60
voyants lumineux	7
voyants lumineux complets	7