



GAS



ELEKTRO



WASSER



MECHANIK



WERKZEUG

Ersatzteile passend für

MALAG

Das komplette Sortiment finden Sie immer aktuell im GEV-Webshop

Hersteller-Kataloge

Für jeden Hersteller die wichtigsten Ersatz- und Zubehörteile übersichtlich zusammengestellt



- ✓ **Komplettes Sortiment und alle Gerätedaten immer aktuell im GEV-Webshop**
- ✓ **Alphabetischer Index am Ende des Katalog**

GEV-Webshop

www.gev-online.de

www.gev-online.ch



- 🔍 Artikel als Favoriten markieren
- 🔍 Einloggen mit E-Mail-Adresse und gewohntem Passwort
- 🔍 Komfort-Bestellung – mehrere Artikel gleichzeitig in den Warenkorb legen
- 🔍 Sofort Artikel suchen ohne Anmeldung

Heizkörper

Heizkörper für Backöfen

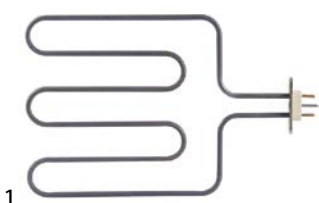

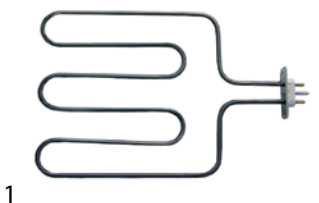

1

GEV-Nr.	418225	Vergl.-Nr.	105597 (old)
Beschreibung	Heizkörper 1000W 230V Windungen 3 EP oben		



1

GEV-Nr.	415315	Vergl.-Nr.	105597	
Beschreibung	Heizkörper 2000W 230V HK 1 L 327mm B 228mm L1 85mm L2 244mm B1 98mm B2 31mm FL 71mm FB 23mm LA 56mm Loch ø M4mm Rohr ø 6.3mm Anschluss Steckanschluss Windungen 3 Rechteckflansch Grillfunktion Backöfen			
Zubehör für	415315			
	GEV-Nr.	550404	Vergl.-Nr.	—
	Steckdose Phasen I-II 240V max. 16A Länder I mit Schraubanschluss für Heizkörper			
	GEV-Nr.	550405	Vergl.-Nr.	—
	Steckdose Flachstecker 6,3mm für Heizkörper 2-polig + Erdung			

Heizkörper für Bain-Maries



1

GEV-Nr.	415323	Vergl.-Nr.	105619 105643
Beschreibung	Heizkörper 1600W 230V HK 1 L 383mm B 96mm FL 45mm FB 12mm LA 36mm Rohr ø 6.3mm Kabellänge 290mm Rechteckflansch Loch ø M5mm Trockenheizkörper L1 14mm L2 369mm B1 72mm B2 24mm		



1

GEV-Nr.	415322	Vergl.-Nr.	105627
Beschreibung	Heizkörper 2600W 230V HK 1 L 468mm B 130mm FL 45mm FB 17mm LA 36mm AL 53mm Rohr ø 6.3mm Kabellänge 200mm Rechteckflansch Gewinde M5 Trockenheizkörper L1 13mm L2 455mm B1 105mm B2 25mm		

Heizkörper für Fritteusen

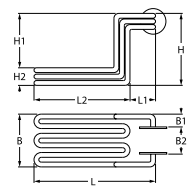
1

GEV-Nr.	418226	Vergl.-Nr.	144436
Beschreibung	Heizkörper 6500W 220V HK 3 L 370mm B 185mm H 255mm L1 90mm L2 280mm B1 39mm B2 107mm H1 343mm H2 27mm Windungen 9 Fø 43mm Schwenkflansch Kabellänge 1450mm Anschluss Kabel Tauchheizkörper Einbau ø 39mm		
Für Modelle:	EF224, FF5-224		

Heizkörper für Wärmeschränke



1

GEV-Nr.	415323	Vergl.-Nr.	105619 105643
Beschreibung	Heizkörper 1600W 230V HK 1 L 383mm B 96mm FL 45mm FB 12mm LA 36mm Rohr ø 6.3mm Kabellänge 290mm Rechteckflansch Loch ø M5mm Trockenheizkörper L1 14mm L2 369mm B1 72mm B2 24mm		

Heizstäbe



1

GEV-Nr.	480063	Vergl.-Nr.	117994
Beschreibung	Heizstab Typ E2 450W 220V B 22.5mm Länge beheizt 700mm		



1

GEV-Nr.	480064	Vergl.-Nr.	117995
Beschreibung	Heizstab Typ E2 450W 380V B 22.5mm Länge beheizt 700mm		

Pilotheizkörper





1

GEV-Nr.	415653	Vergl.-Nr.	105708	
Beschreibung	Heizkörper 600W 230V HK 1 Einbau ø 47.5mm L 280mm B 36mm H 16mm Rundflansch Anschluss Flachstecker 6,3mm Tauchheizkörper Rohr ø 6.3mm TH ø 7mm THL 220mm THA 1 Pilotheizkörper			
Ersatzteile für	415653			
	GEV-Nr.	510408	Vergl.-Nr.	—
	O-Ring EPDM Materialstärke 5.34mm ID ø 47mm VPE 1 Stück			

Tabellenfortsetzung auf der nächsten Seite



Zubehör für	415653			
	GEV-Nr.	510562	Vergl.-Nr.	—
	O-Ring Silikon Materialstärke 5.34mm ID ø 47mm VPE 1 Stück			
	GEV-Nr.	550675	Vergl.-Nr.	—
	O-Ring Viton Materialstärke 6mm ID ø 47mm VPE 1 Stück			



Quarzheizkörper





1			
GEV-Nr.	415309	Vergl.-Nr.	12050000 (14-01)
Beschreibung	Quarzheizkörper 400W 230V L 340mm ø 10mm Anschluss Steckanschluss		









Tauchheizkörper

mit Rundflansch ø 47,5mm

1				
GEV-Nr.	415581	Vergl.-Nr.	105716	
Beschreibung	Heizkörper 3000W 230V HK 3 L 268mm B 36mm H 28mm Rohr ø 6.3mm Anschluss Kabel Kabellänge 300mm Tauchheizkörper Einbau ø 47.5mm			
Zubehör für	415581			
	GEV-Nr.	510562	Vergl.-Nr.	—
	O-Ring Silikon Materialstärke 5.34mm ID ø 47mm VPE 1 Stück			
	GEV-Nr.	520235	Vergl.-Nr.	—
	Dreilochflansch LA 70.5mm Lochung ø 6.5mm ID ø 53.5mm			
	GEV-Nr.	520236	Vergl.-Nr.	—
	Flansch für Heizkörper ID ø 50mm AD ø 90mm Loch ø 6.5mm 3 Löcher			
	GEV-Nr.	521012	Vergl.-Nr.	—
	Dichtung Graphit AD ø 15mm ID ø 5mm Materialstärke 1.2mm VPE 1 Stück			
	GEV-Nr.	550002	Vergl.-Nr.	—
	Spannbügel H 10mm L 21mm B 10mm Loch ø 6.5mm für Heizkörper			
	GEV-Nr.	550362	Vergl.-Nr.	—
	Blindflansch ø 64mm Einbau ø 47.5mm			

1				
GEV-Nr.	415263	Vergl.-Nr.	105724	
Beschreibung	Heizkörper 4500W 230V HK 3 Einbau ø 47.5mm L 375mm B 38mm H 46mm Rundflansch Anschluss Flachstecker 6,3mm Tauchheizkörper Rohr ø 6.3mm TH ø 7mm THA 1 THL 240mm THP nicht anliegend			
Zubehör für	415263			
	GEV-Nr.	510408	Vergl.-Nr.	—
	O-Ring EPDM Materialstärke 5.34mm ID ø 47mm VPE 1 Stück			
	GEV-Nr.	520235	Vergl.-Nr.	—
	Dreilochflansch LA 70.5mm Lochung ø 6.5mm ID ø 53.5mm			

Zubehör für	415263			
	GEV-Nr.	520236	Vergl.-Nr.	—
	Flansch für Heizkörper ID ø 50mm AD ø 90mm Loch ø 6.5mm 3 Löcher			
	GEV-Nr.	521012	Vergl.-Nr.	—
	Dichtung Graphit AD ø 15mm ID ø 5mm Materialstärke 1.2mm VPE 1 Stück			
	GEV-Nr.	550002	Vergl.-Nr.	—
	Spannbügel H 10mm L 21mm B 10mm Loch ø 6.5mm für Heizkörper			
	GEV-Nr.	550362	Vergl.-Nr.	—
	Blindflansch ø 64mm Einbau ø 47.5mm			

1				
GEV-Nr.	415663	Vergl.-Nr.	105732	
Beschreibung	Heizkörper 6000W 230V HK 3 Einbau ø 47.5mm L 400mm B 40mm H 28mm Rundflansch Anschluss M4 Tauchheizkörper Rohr ø 6.3mm TH ø 7mm THA 2 THL 150mm THP nicht anliegend			
Ersatzteile für	415663			
	GEV-Nr.	510408	Vergl.-Nr.	—
	O-Ring EPDM Materialstärke 5.34mm ID ø 47mm VPE 1 Stück			
Zubehör für	415663			
	GEV-Nr.	510408	Vergl.-Nr.	—
	O-Ring EPDM Materialstärke 5.34mm ID ø 47mm VPE 1 Stück			
	GEV-Nr.	510562	Vergl.-Nr.	—
	O-Ring Silikon Materialstärke 5.34mm ID ø 47mm VPE 1 Stück			
	GEV-Nr.	520235	Vergl.-Nr.	—
	Dreilochflansch LA 70.5mm Lochung ø 6.5mm ID ø 53.5mm			
	GEV-Nr.	520236	Vergl.-Nr.	—
	Flansch für Heizkörper ID ø 50mm AD ø 90mm Loch ø 6.5mm 3 Löcher			
	GEV-Nr.	550002	Vergl.-Nr.	—
	Spannbügel H 10mm L 21mm B 10mm Loch ø 6.5mm für Heizkörper			
	GEV-Nr.	550362	Vergl.-Nr.	—
	Blindflansch ø 64mm Einbau ø 47.5mm			

Kochplatten

quadratisch + rechteckig

mit Überfallrand

1			
GEV-Nr.	490065	Vergl.-Nr.	161632
Beschreibung	Kochplatte Maße 220x220mm 2000W 230V mit Überfallrand Anschluss 4 Schraubklemmen Protaktor Nein quadratisch		



1

GEV-Nr.	490067	Vergl.-Nr.	161634
Beschreibung	Kochplatte Maße 220x220mm 2000W 400V mit Überfallrand Anschluss 4 Schraubklemmen Protektor Nein quadratisch		
Zubehör für	490067		
	GEV-Nr.	Vergl.-Nr.	—
	Schnurdichtung ø 10mm VPE Meterware		

1

GEV-Nr.	490057 ¹	Vergl.-Nr.	117902
Beschreibung	Kochplatte Maße 300x300mm 3000W 400V mit Überfallrand Anschluss 4 Schraubklemmen Protektor Ja quadratisch		

¹mit Protektor

1

GEV-Nr.	490066 ¹	Vergl.-Nr.	161624
Beschreibung	Kochplatte Maße 220x220mm 2600W 230V mit Überfallrand Anschluss 4 Schraubklemmen Protektor Ja quadratisch		

¹mit Protektor

1

GEV-Nr.	490071 ¹	Vergl.-Nr.	117889
Beschreibung	Kochplatte Maße 300x300mm 4000W 230V mit Überfallrand Anschluss 4 Schraubklemmen Protektor Ja quadratisch		

¹mit Protektor

1

GEV-Nr.	490068 ¹	Vergl.-Nr.	161635
Beschreibung	Kochplatte Maße 220x220mm 2600W 400V mit Überfallrand Anschluss 4 Schraubklemmen Protektor Ja quadratisch		

¹mit Protektor

1

GEV-Nr.	490074 ¹	Vergl.-Nr.	117890
Beschreibung	Kochplatte Maße 300x300mm 4000W 400V mit Überfallrand Anschluss 4 Schraubklemmen Protektor Ja quadratisch		

¹mit Protektor

1

GEV-Nr.	490056 ¹	Vergl.-Nr.	117897
Beschreibung	Kochplatte Maße 300x300mm 3000W 230V mit Überfallrand Anschluss 4 Schraubklemmen Protektor Ja quadratisch		

¹mit Protektor

rund

mit Überfallrand

für Haushalt + Großküche

1

GEV-Nr.	490016	Vergl.-Nr.	117854
Beschreibung	Kochplatte ø 180mm 2000W 230V Anschluss 4 Schraubklemmen mit 8mm Überfallrand		



1

GEV-Nr.	490020	Vergl.-Nr.	117846
Beschreibung	Kochplatte ø 220mm 2600W 230V Anschluss 4 Schraubklemmen mit 8mm Überfallrand		
Zubehör für	490020		
	GEV-Nr.	550796	Vergl.-Nr.
			—



Befestigungsplatte für Kochplatte ø220mm

mit Gussrand

mit Schraubanschluss



1

GEV-Nr.	490106	Vergl.-Nr.	HR4067021
Beschreibung	Kochplatte ø 400mm 5000W 400V Anschluss 2x 3 Schraubklemmen mit Gussrand Schraubbolzen H 42mm		



1

GEV-Nr.	375546	Vergl.-Nr.	105740
Beschreibung	Thermostat T.max. 110°C Arbeitsbereich 30-110°C 1-polig 1NO 16A Fühler ø 6mm Fühler L 130mm Kapillarrohr 900mm Kapillarrohr isoliert 900mm Stopfbuchse Achse ø 6x4,6mm Achslänge 15mm Achsstellung oben Drehwinkel 318°		



1

GEV-Nr.	375709	Vergl.-Nr.	172146
Beschreibung	Thermostat T.max. 110°C Arbeitsbereich 86-110°C 1-polig 1NO 16A Fühler ø 6mm Fühler L 265mm Kapillarrohr 860mm Kapillarrohr isoliert 800mm Stopfbuchse Achse ø 6x4,6mm Achslänge 23mm Achsstellung oben Drehwinkel 270° mit Scheibe Verschraubung M14x1 Scheibe ø 12.5mm		

Serie 55.13_



1

GEV-Nr.	375710	Vergl.-Nr.	105767
Beschreibung	Thermostat T.max. 132°C Arbeitsbereich fest 132°C 1-polig 1CO 16A Fühler ø 6mm Fühler L 86mm Kapillarrohr 1150mm Kapillarrohr isoliert 350mm Stopfbuchse Achslängemmm Achsstellung° Achsstellung Drehwinkel° Abschaltemp. 132°C Fühler CNS		

Thermostate

Regel- und Sicherheitsthermostate

EGO

Regelthermostate

Serie 55.10/19_



1

GEV-Nr.	375897	Vergl.-Nr.	172154
Beschreibung	Thermostat T.max. 110°C 1-polig 1NC 16A Fühler ø 6mm Fühler L 270mm Kapillarrohr 900mm Kapillarrohr isoliert 750mm Stopfbuchse Achse ø 6x4,6mm Achslänge 23mm Achsstellung oben° Drehwinkel 270°		



GEV-Nr. 375012 **Vergl.-Nr.** 143702

Beschreibung Thermostat T.max. 358°C Arbeitsbereich 50-358°C 1-polig 1NO 16A Fühler ø 3.1mm Fühler L 147mm Kapillarrohr 1730mm Kapillarrohr isoliert 1100mm Stopfbuchse Achslänge 23mm Achsstellung oben Drehwinkel 270°

Zubehör für 375012

 **GEV-Nr.** 110247 **Vergl.-Nr.** —
Knebel Thermostat T.max. 350°C ø 50mm Achse ø 6x4,6mm Abflachung oben schwarz Arbeitsbereich 100-350°C



GEV-Nr. 375101 **Vergl.-Nr.** 105849

Beschreibung Thermostat T.max. 360°C Arbeitsbereich 140-360°C 3-polig 3NO 16A Fühler ø 4mm Fühler L 292mm Kapillarrohr 990mm Kapillarrohr isoliert 500mm Stopfbuchse Achslänge 23mm Achsstellung oben Drehwinkel 318°

Serie 55.34_



GEV-Nr. 375188 **Vergl.-Nr.** 105813

Beschreibung Thermostat T.max. 110°C Arbeitsbereich 30-110°C 3-polig 3NO 16A Fühler ø 6mm Fühler L 131mm Kapillarrohr 1160mm Kapillarrohr isoliert 800mm Stopfbuchse Achse ø 6x4,6mm Achslänge 23mm Achsstellung oben Drehwinkel 310°



GEV-Nr. 375225 **Vergl.-Nr.** 105847

Beschreibung Thermostat T.max. 400°C Arbeitsbereich 91-400°C 3-polig 3NO 16A Fühler ø 3.9mm Fühler L 308mm Kapillarrohr 920mm Kapillarrohr isoliert 800mm Stopfbuchse Achse ø 6x4,6mm Achslänge 23mm Achsstellung oben Drehwinkel 310°

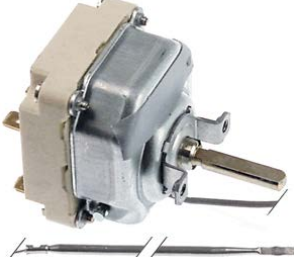

GEV-Nr. 375685 **Vergl.-Nr.** 105783

Beschreibung Thermostat T.max. 300°C Arbeitsbereich 50-300°C 3-polig 3NO 16A Fühler ø 3.1mm Fühler L 226mm Kapillarrohr 1180mm Kapillarrohr isoliert 500mm Stopfbuchse Achse ø 6x4,6mm Achslänge 23mm Achsstellung oben Drehwinkel 318°

Sicherheitsthermostate

Serie 55.31_



GEV-Nr. 375686 **Vergl.-Nr.** 174963

Beschreibung Sicherheitsthermostat Abschalttemp. 250°C 3-polig 20A Fühler ø 6mm Fühler L 219mm Kapillarrohr 1430mm Kapillarrohr isoliert 1100mm Stopfbuchse Fühler CNS



Schalter und Taster

Nockenschalter

4-Takt





GEV-Nr.	300103	Vergl.-Nr.	106062
Beschreibung	Nockenschalter 4 Schaltstellungen 1NO/2CO Schaltfolge 0-1-2-3 32A Achse ø 6x4,6mm Achslänge 23mm Anschluss Schraubanschluss Keramik		

7-Takt



GEV-Nr.	300025	Vergl.-Nr.	106070
Beschreibung	Nockenschalter 7 Schaltstellungen 1NO/2CO Schaltfolge 0-1-2-3-4-5-6 16A Achse ø 6x4,6mm Achslänge 23mm Anschluss Schraubanschluss 7-Takt Keramik		

Zubehör für	300025			
	GEV-Nr.	112172	Vergl.-Nr.	—
	Knebel universal ø 70mm schwarz ohne Adapter/Symbol			
	GEV-Nr.	112213	Vergl.-Nr.	—
	Knebelsymbol silber Schalter 7-Takt T.max.°C AD ø 63mm ID ø 45.5mm			
	GEV-Nr.	112311	Vergl.-Nr.	—
	Knebeladapter Achse ø 6x4,6mm L 0mm mit Feder			



GEV-Nr.	300106	Vergl.-Nr.	106072
Beschreibung	Nockenschalter 7 Schaltstellungen 1NO/2CO Schaltfolge 0-1-2-3-4-5-6 32A Achse ø 6x4,6mm Achslänge 23mm Anschluss Schraubanschluss 7-Takt Abflachung oben		

Vorsatzschalter



GEV-Nr.	300006	Vergl.-Nr.	143774
Beschreibung	Nockenschalter Umschalter 16A Schaltfolge 0-1-2-3-4-5 Achse ø 6x4,6mm Anschluss Flachstecker 6,3mm 3-polig Umgebungstemperatur max. 150°C		

Lampen

Signallampen

Signallampen 3-teilig (Fassung, Linse und Glimm-/Glühlampe)

Leuchtmittel

Glimmlampen



GEV-Nr.	359602	Vergl.-Nr.	105473
Beschreibung	Glimmlampe Fassung E14 230V klar ø 14mm L 30mm		

Leuchtmittel für Steck-/Schraubfassungen

Glimmlampen



GEV-Nr.	359602	Vergl.-Nr.	105473
Beschreibung	Glimmlampe Fassung E14 230V klar ø 14mm L 30mm		

Magnetventile

Magnetventile Wasser

Metall

BÜRKERT

Magnetventile Dampf (Wasser)

2-Wege

Serie 0407



1

GEV-Nr.	370364	Vergl.-Nr.	161363 161373
Beschreibung	Magnetventil 2-Wege 230VAC Anschluss 3/8" L 55mm DN 12mm Steckbuchse DIN 180°C BÜRKERT Serie 0407 Membrane PTFE p max 10bar Messing		

Pressostate

für Dampfregelung



1

GEV-Nr.	541022	Vergl.-Nr.	161357
Beschreibung	Pressostat Dampfregelung Druckanschluss vertikal Druckbereich einstellbar 0,25-4,5bar Anschluss 1/4" Druckanschluss 1/4" IG		

Gashähne





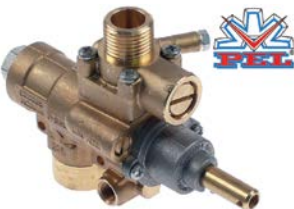







PEL

Serie 23S/V



1

GEV-Nr.	101630	Vergl.-Nr.	112623
Beschreibung	Gashahn PEL Typ 23S/V Gaseingang 1/2" IG KBD ø 0.35mm Gasausgang 1/2" AG (Rohr-ø 14mm) Thermoelementanschluss M10x1 Zündflammenanschluss M10x1 Achse ø 10mm Achslänge 25mm Abflachung		
Ersatzteile für	101630		
	GEV-Nr.	100455	Vergl.-Nr. —
	Kleinbranddüse Typ PEL23/24 Bohrung ø 0.35mm Gewinde M8x0,5		

Ersatzteile für	101630		
	GEV-Nr.	101059	Vergl.-Nr. —
	Magneteinsatz G1: M10x1 G2: M22x1 L 46mm ø 18mm passend für PEL23S M10x1		
	GEV-Nr.	102767	Vergl.-Nr. —
	Gashahnvorderteil Achse ø 10mm Achslänge 26.5mm Abflachung passend für PEL23S		
Zubehör für	101630		
	GEV-Nr.	100908	Vergl.-Nr. —
	Überwurfschraube Gewinde M10x1 für Rohr-ø 4mm VPE 1 Stück		
	GEV-Nr.	100909	Vergl.-Nr. —
	Überwurfschraube Gewinde M10x1 für Rohr-ø 6mm VPE 1 Stück		
	GEV-Nr.	100945	Vergl.-Nr. —
	Spannstift ø 3.2mm L 10mm		
	GEV-Nr.	101218	Vergl.-Nr. —
	Achsverlängerung JUNKERS		
	GEV-Nr.	101219	Vergl.-Nr. —
	Achsverlängerung L 25mm JUNKERS		
	GEV-Nr.	101246	Vergl.-Nr. —
	Schneidring für Rohr-ø 4mm VPE 1 Stück		
	GEV-Nr.	101286	Vergl.-Nr. —
	Schneidring ID ø 6mm VPE 1 Stück		
	GEV-Nr.	110064	Vergl.-Nr. —
	Knebel		
	GEV-Nr.	110066	Vergl.-Nr. —
	Knebelschraube		
	GEV-Nr.	550396	Vergl.-Nr. —
	Achsverlängerung L 25mm JUNKERS		

EGA-Alternativ

Serie GPEL22

mit Düsenausgang



1

GEV-Nr.	101662	Vergl.-Nr.	N/A
Beschreibung	Gashahn EGA-Alternativ Typ GPEL22D mit Düsenausgang (mit Düse) Gaseingang M18x1,5 (Rohr-ø 12mm) Außendüse ø 2.1mm Innendüse ø 1mm KBD ø 0.35mm Mischrohranschluss M22x1 Thermoelementanschluss M8x1 Zündflammenanschluss M10x1 Achse ø 6,5x9mm Achslänge 34/15mm Abflachung oben und unten		
Ersatzteile für	101662		
	GEV-Nr.	100259	Vergl.-Nr. —
	Kleinbranddüse Typ PEL22 Bohrung ø 0.35mm Gewinde M6x0,5		

Tabellenfortsetzung auf der nächsten Seite



Ersatzteile für		101662	
	GEV-Nr.	100338	Vergl.-Nr. —
Gasdüse Gewinde M15x1 Bohrung ø 2,10mm SW 17			
	GEV-Nr.	100343	Vergl.-Nr. —
Innendüse Bohrung ø 1mm Typ EGA/PEL22			
	GEV-Nr.	100908	Vergl.-Nr. —
Überwurfschraube Gewinde M10x1 für Rohr-ø 4mm VPE 1 Stück			
	GEV-Nr.	100927	Vergl.-Nr. —
Drehfeder L 2,8-8,0mm für Innendüse ø 3mm Bohrung ømm			
	GEV-Nr.	101058	Vergl.-Nr. 162589
Magneteinsatz L 39mm D1 ø 15.4mm D2 ø 13.5mm passend für PEL22/EGA24197 Standard			
	GEV-Nr.	101230	Vergl.-Nr. —
Thermoelementmutter G1: M8x1 G2: M18x1 Aluminium			
	GEV-Nr.	101246	Vergl.-Nr. —
Schneidring für Rohr-ø 4mm VPE 1 Stück			
	GEV-Nr.	101460	Vergl.-Nr. —
O-Ring ø 12.37mm D1 ø 2.62mm passend für PEL22			
	GEV-Nr.	101527	Vergl.-Nr. —
O-Ring Viton Materialstärke 1.78mm ID ø 6.75mm VPE 1 Stück			
	GEV-Nr.	101594	Vergl.-Nr. —
Einstellschraube für Innendüse Gewinde M10x0,75			
	GEV-Nr.	101821	Vergl.-Nr. —
Gashahnvorderteil Achse ø 9x6,5mm Achslänge 34/15mm Abflachung oben/unten passend für PEL22			
Zubehör für		101662	
	GEV-Nr.	100909	Vergl.-Nr. —
Überwurfschraube Gewinde M10x1 für Rohr-ø 6mm VPE 1 Stück			
	GEV-Nr.	100944	Vergl.-Nr. —
Überwurfmutter Gewinde M18x1,5 für Rohr ø 12mm			
	GEV-Nr.	101273	Vergl.-Nr. —
Schneidring für Rohr-ø 12mm L 9.5mm Messing VPE 1 Stück passend für universal			
	GEV-Nr.	101286	Vergl.-Nr. —
Schneidring ID ø 6mm VPE 1 Stück			
	GEV-Nr.	110217	Vergl.-Nr. 179922
Knebel Gashahn mit Zündflamme ø 64mm Achse ø 9x7mm Abflachung horizontal schwarz			

			
1			
GEV-Nr.		Vergl.-Nr.	
101764		112721 112722	
Beschreibung			
Gashahn EGA-Alternativ Typ PEL22S mit Düsenausgang (mit Düse) Gaseingang M18x1,5 (Rohr-ø 12mm) Außendüse ø 1.6mm Innendüse ø 1mm KBD ø 0.35mm Mischrohranschluss M22x1 Thermoelementanschluss M8x1 Zündflammenanschluss M10x1 Achse ø 9x6,5mm Achslänge 34/15mm Abflachung oben und unten			
Ersatzteile für		101764	
	GEV-Nr.	100259	Vergl.-Nr. —
Kleinbranddüse Typ PEL22 Bohrung ø 0.35mm Gewinde M6x0,5			
	GEV-Nr.	100337	Vergl.-Nr. —
Gasdüse Gewinde M15x1 Bohrung ø 1,60mm SW 17			
	GEV-Nr.	100343	Vergl.-Nr. —
Innendüse Bohrung ø 1mm Typ EGA/PEL22			
	GEV-Nr.	100908	Vergl.-Nr. —
Überwurfschraube Gewinde M10x1 für Rohr-ø 4mm VPE 1 Stück			
	GEV-Nr.	100927	Vergl.-Nr. —
Drehfeder L 2,8-8,0mm für Innendüse ø 3mm Bohrung ømm			
	GEV-Nr.	101058	Vergl.-Nr. 162589
Magneteinsatz L 39mm D1 ø 15.4mm D2 ø 13.5mm passend für PEL22/EGA24197 Standard			
	GEV-Nr.	101230	Vergl.-Nr. —
Thermoelementmutter G1: M8x1 G2: M18x1 Aluminium			
	GEV-Nr.	101246	Vergl.-Nr. —
Schneidring für Rohr-ø 4mm VPE 1 Stück			
	GEV-Nr.	101460	Vergl.-Nr. —
O-Ring ø 12.37mm D1 ø 2.62mm passend für PEL22			
	GEV-Nr.	101527	Vergl.-Nr. —
O-Ring Viton Materialstärke 1.78mm ID ø 6.75mm VPE 1 Stück			
	GEV-Nr.	101594	Vergl.-Nr. —
Einstellschraube für Innendüse Gewinde M10x0,75			
	GEV-Nr.	101821	Vergl.-Nr. —
Gashahnvorderteil Achse ø 9x6,5mm Achslänge 34/15mm Abflachung oben/unten passend für PEL22			
Zubehör für		101764	
	GEV-Nr.	100944	Vergl.-Nr. —
Überwurfmutter Gewinde M18x1,5 für Rohr ø 12mm			
	GEV-Nr.	101273	Vergl.-Nr. —
Schneidring für Rohr-ø 12mm L 9.5mm Messing VPE 1 Stück passend für universal			
	GEV-Nr.	101286	Vergl.-Nr. —
Schneidring ID ø 6mm VPE 1 Stück			

Tabellenfortsetzung auf der nächsten Seite







Zubehör für	101764
	GEV-Nr. 101909 Vergl.-Nr. —
	Gashahn Typ PEL22S









GEV-Nr.	101624	Vergl.-Nr.	112721 old version 112722 old version
----------------	--------	-------------------	--

Beschreibung Gashahn EGA-Alternativ Typ PEL22S mit Düsenausgang (ohne Düse) Gaseingang M18x1,5 (Rohr-ø 12mm) Außendüse ømm Innendüse ømm KBD ø 0.35mm Mischrohranschluss M22x1 Thermoelementanschluss M8x1 Zündflammenanschluss M10x1 Achse ø 9x6,5mm Achslänge 34/15mm Abflachung oben und unten

Ersatzteile für	101624
------------------------	--------

	GEV-Nr. 100259 Vergl.-Nr. —	Kleinbranddüse Typ PEL22 Bohrung ø 0.35mm Gewinde M6x0,5
	GEV-Nr. 100927 Vergl.-Nr. —	Drehfeder L 2,8-8,0mm für Innendüse ø 3mm Bohrung ømm
	GEV-Nr. 101058 Vergl.-Nr. 162589	Magneteinsatz L 39mm D1 ø 15.4mm D2 ø 13.5mm passend für PEL22/EGA24197 Standard
	GEV-Nr. 101230 Vergl.-Nr. —	Thermoelementmutter G1: M8x1 G2: M18x1 Aluminium
	GEV-Nr. 101460 Vergl.-Nr. —	O-Ring ø 12.37mm D1 ø 2.62mm passend für PEL22
	GEV-Nr. 101527 Vergl.-Nr. —	O-Ring Viton Materialstärke 1.78mm ID ø 6.75mm VPE 1 Stück
	GEV-Nr. 101594 Vergl.-Nr. —	Einstellschraube für Innendüse Gewinde M10x0,75
	GEV-Nr. 101821 Vergl.-Nr. —	Gashahnvorderteil Achse ø 9x6,5mm Achslänge 34/15mm Abflachung oben/unten passend für PEL22

Zubehör für	101624
--------------------	--------

	GEV-Nr. 100908 Vergl.-Nr. —	Überwurfschraube Gewinde M10x1 für Rohr-ø 4mm VPE 1 Stück
	GEV-Nr. 100909 Vergl.-Nr. —	Überwurfschraube Gewinde M10x1 für Rohr-ø 6mm VPE 1 Stück
	GEV-Nr. 100944 Vergl.-Nr. —	Überwurfmutter Gewinde M18x1,5 für Rohr ø 12mm
	GEV-Nr. 101246 Vergl.-Nr. —	Schneidring für Rohr-ø 4mm VPE 1 Stück
	GEV-Nr. 101273 Vergl.-Nr. —	Schneidring für Rohr-ø 12mm L 9.5mm Messing VPE 1 Stück passend für universal
	GEV-Nr. 101286 Vergl.-Nr. —	Schneidring ID ø 6mm VPE 1 Stück

Zubehör für	101624
	GEV-Nr. 110217 Vergl.-Nr. 179922
	Knebel Gashahn mit Zündflamme ø 64mm Achse ø 9x7mm Abflachung horizontal schwarz



JUNKERS-Alternativ



GEV-Nr.	101630	Vergl.-Nr.	112623
----------------	--------	-------------------	--------

Beschreibung Gashahn PEL Typ 235/V Gaseingang 1/2" IG KBD ø 0.35mm Gasausgang 1/2" AG (Rohr-ø 14mm) Thermoelementanschluss M10x1 Zündflammenanschluss M10x1 Achse ø 10mm Achslänge 25mm Abflachung

Ersatzteile für	101630
------------------------	--------

	GEV-Nr. 100455 Vergl.-Nr. —	Kleinbranddüse Typ PEL23/24 Bohrung ø 0.35mm Gewinde M8x0,5
	GEV-Nr. 101059 Vergl.-Nr. —	Magneteinsatz G1: M10x1 G2: M22x1 L 46mm ø 18mm passend für PEL235 M10x1
	GEV-Nr. 102767 Vergl.-Nr. —	Gashahnvorderteil Achse ø 10mm Achslänge 26.5mm Abflachung passend für PEL235

Zubehör für	101630
--------------------	--------

	GEV-Nr. 100908 Vergl.-Nr. —	Überwurfschraube Gewinde M10x1 für Rohr-ø 4mm VPE 1 Stück
	GEV-Nr. 100909 Vergl.-Nr. —	Überwurfschraube Gewinde M10x1 für Rohr-ø 6mm VPE 1 Stück
	GEV-Nr. 100945 Vergl.-Nr. —	Spannstift ø 3.2mm L 10mm
	GEV-Nr. 101218 Vergl.-Nr. —	Achsverlängerung JUNKERS
	GEV-Nr. 101219 Vergl.-Nr. —	Achsverlängerung L 25mm JUNKERS
	GEV-Nr. 101246 Vergl.-Nr. —	Schneidring für Rohr-ø 4mm VPE 1 Stück
	GEV-Nr. 101286 Vergl.-Nr. —	Schneidring ID ø 6mm VPE 1 Stück
	GEV-Nr. 110064 Vergl.-Nr. —	Knebel
	GEV-Nr. 110066 Vergl.-Nr. —	Knebelschraube
	GEV-Nr. 550396 Vergl.-Nr. —	Achsverlängerung L 25mm JUNKERS



Zündtechnik

Zündbrenner

JUNKERS

Serie CB 502

Zündbrenner

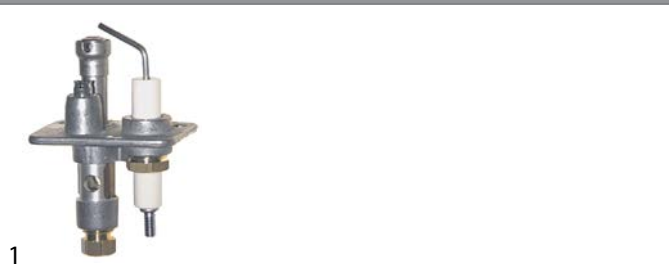

GEV-Nr.	100085	Vergl.-Nr.	112569
----------------	--------	-------------------	--------

Beschreibung Zündbrenner JUNKERS Typ CB502031 Erdgas Düsentyp Nr.6 Gasanschluss 6mm mit Primärluft

Für Modelle: GK8-40

Ersatzteile für 100085

	GEV-Nr.	100227	Vergl.-Nr.	—
Zündbrennerdüse Erdgas Gasdruck 25mbar Kennzahl 6 VPE 1 Stück passend für JUNKERS CB50203_				
	GEV-Nr.	100704	Vergl.-Nr.	112414
Zünderlektrode D1 ø 9mm Anschluss M4 D2 ø 11mm L1 17mm L2 17mm KL1 13mm KL2 4mm KL3 22mm				
	GEV-Nr.	100909	Vergl.-Nr.	—
Überwurfschraube Gewinde M10x1 für Rohr-ø 6mm VPE 1 Stück				
	GEV-Nr.	101287	Vergl.-Nr.	—
Schneidring für Rohr-ø 6mm VPE 1 Stück				
	GEV-Nr.	101292	Vergl.-Nr.	—
Überwurfschraube für Zündkerze passend für CB 502/505 VPE 1 Stück				
	GEV-Nr.	101295	Vergl.-Nr.	—
Klemmhülse für Thermoelement passend für CB 502/505 VPE 1 Stück				

Zubehör für 100085

	GEV-Nr.	100220	Vergl.-Nr.	—
Zündbrennerdüse Flüssiggas Gasdruck 50mbar Kennzahl 2 VPE 1 Stück passend für JUNKERS CB503_				
	GEV-Nr.	100221	Vergl.-Nr.	—
Zündbrennerdüse Flüssiggas Gasdruck 30mbar Kennzahl 29 VPE 1 Stück passend für JUNKERS CB50203_				
	GEV-Nr.	100222	Vergl.-Nr.	—
Zündbrennerdüse Flüssiggas Gasdruck 50mbar Kennzahl 5 VPE 1 Stück passend für JUNKERS CB50203_				
	GEV-Nr.	100223	Vergl.-Nr.	—
Zündbrennerdüse Erdgas Gasdruck 20mbar Kennzahl 3 VPE 1 Stück passend für JUNKERS CB503_				
	GEV-Nr.	100224	Vergl.-Nr.	—
Zündbrennerdüse Erdgas Gasdruck 25mbar Kennzahl 26 VPE 1 Stück passend für JUNKERS CB503_				
	GEV-Nr.	100225	Vergl.-Nr.	—
Zündbrennerdüse Flüssiggas Gasdruck 30mbar Kennzahl 39 VPE 1 Stück passend für JUNKERS CB503_				
	GEV-Nr.	100226	Vergl.-Nr.	—
Zündbrennerdüse Flüssiggas Gasdruck 50mbar Kennzahl 15 passend für JUNKERS				

Zubehör für	100085			
	GEV-Nr.	100228	Vergl.-Nr.	—
Zündbrennerdüse Stadtgas Gasdruck 8mbar Kennzahl 4 VPE 1 Stück passend für JUNKERS CB50203_				
	GEV-Nr.	101281	Vergl.-Nr.	—
Schneidring für Rohr-ø 4mm L 8.7mm VPE 1 Stück passend für CB 502/503				
	GEV-Nr.	101283	Vergl.-Nr.	—
Überwurfschraube Gewinde M10x1 für Rohr-ø 4mm VPE 1 Stück				

Serie CB 505

Zündbrenner

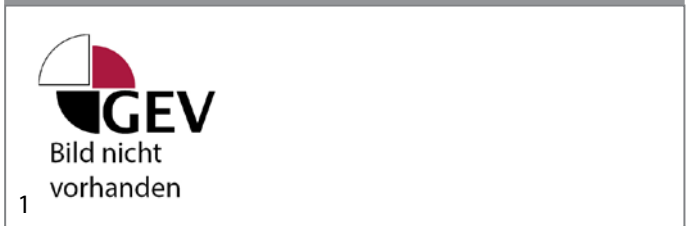

GEV-Nr.	100180	Vergl.-Nr.	172317
----------------	--------	-------------------	--------

Beschreibung Zündbrenner JUNKERS Typ 7749505104



GEV-Nr.	100134	Vergl.-Nr.	172316
----------------	--------	-------------------	--------

Beschreibung Zündbrenner JUNKERS Typ CB505101 Erdgas Düsentyp Nr.45 Gasanschluss 4mm ohne Primärluft

Ersatzteile für 100134





	GEV-Nr.	100213	Vergl.-Nr.	—
Zündbrennerdüse Erdgas Kennzahl 45 Gasdruck 20mbar L 16mm VPE 1 Stück passend für JUNKERS CB5051_				
	GEV-Nr.	100702	Vergl.-Nr.	—
Zünderlektrode D1 ø 9mm D2 ø 11mm L1 13mm L2 4mm KL1 13mm KL2 4mm KL3 22mm zum Klemmen Anschluss ø 4mm				
	GEV-Nr.	100802	Vergl.-Nr.	—
Dichtung für Zündbrenner				
	GEV-Nr.	101282	Vergl.-Nr.	—
Schneidring für Rohr-ø 4mm L 7.4mm VPE 1 Stück				
	GEV-Nr.	101283	Vergl.-Nr.	—
Überwurfschraube Gewinde M10x1 für Rohr-ø 4mm VPE 1 Stück				
	GEV-Nr.	101292	Vergl.-Nr.	—
Überwurfschraube für Zündkerze passend für CB 502/505 VPE 1 Stück				
	GEV-Nr.	101295	Vergl.-Nr.	—
Klemmhülse für Thermoelement passend für CB 502/505 VPE 1 Stück				

Zubehör für 100134

	GEV-Nr.	100210	Vergl.-Nr.	—
Zündbrennerdüse Flüssiggas Kennzahl 46 Gasdruck 30mbar L 16mm VPE 1 Stück passend für JUNKERS CB5051_				

Tabellenfortsetzung auf der nächsten Seite



Zubehör für	100134		
	GEV-Nr.	100211	Vergl.-Nr. —
Zündbrennerdüse Erdgas Kennzahl 44 Gasdruck 25mbar L 16mm VPE 1 Stück passend für JUNKERS CB5051_			
	GEV-Nr.	100212	Vergl.-Nr. —
Zündbrennerdüse Flüssiggas Kennzahl 42 Gasdruck 50mbar L 16mm VPE 1 Stück passend für JUNKERS CB5051_			
	GEV-Nr.	100909	Vergl.-Nr. —
Überwurfschraube Gewinde M10x1 für Rohr-ø 6mm VPE 1 Stück			
	GEV-Nr.	101288	Vergl.-Nr. —
Schneidring für Rohr-ø 6mm L 6mm Aluminium VPE 1 Stück AD ø 8,5mm			

Herstellerspezifische Zündbrenner

MALAG

Serie AG_ / AGE_

			
GEV-Nr.	107473	Vergl.-Nr.	-
Beschreibung	Zündbrenner Erdgas/Flüssiggas komplett		

Elektroden

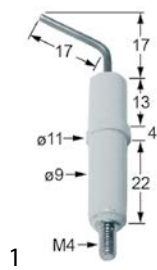
			
GEV-Nr.	100704	Vergl.-Nr.	112414
Beschreibung	Zündelectrode D1 ø 9mm Anschluss M4 D2 ø 11mm L1 17mm L2 17mm KL1 13mm KL2 4mm KL3 22mm		

Piezozünder

Sonstige

			
GEV-Nr.	nml ¹	Vergl.-Nr.	112607
Beschreibung	Piezozünder Körper Metall Anschluss F6,3x0,8 2-Lochbefestigung ø 22mm		

¹nicht mehr lieferbar

Thermoelemente

Einschraubthermoelemente

Einschraubthermoelemente Standard

mit Schraubhülse M8x1

Typ Junkers mit aluminierter Spitze

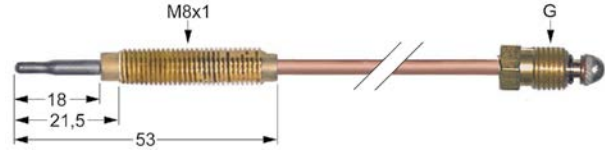
			
GEV-Nr.	102234	Vergl.-Nr.	112402
Beschreibung	Thermoelement M10x1 L 320mm M8x1		
Für Modelle:	GK8-40		

Gasbrenner

Kochstellenbrenner

Herstellerspezifische Kochstellenbrenner

MALAG

Universal

			
Bild nicht vorhanden			
GEV-Nr.	105796	Vergl.-Nr.	112275
Beschreibung	Brenner 3.8kW komplett		

			
1			
GEV-Nr.	105801	Vergl.-Nr.	112267
Beschreibung	Brenner 5.8kW komplett		
Ersatzteile für	105801		
	GEV-Nr.	105797	Vergl.-Nr. 112224
	Brennerdeckel ø 104mm 5.8kW mit Mittelloch Loch ø 39mm		
	GEV-Nr.	105798	Vergl.-Nr. 177776
	Brennerring 5.8kW klein		
	GEV-Nr.	105799	Vergl.-Nr. 177806
	Brennerring 5.8kW groß		
	GEV-Nr.	105801	Vergl.-Nr. 112267
	Brenner 5.8kW komplett		

			
1			
GEV-Nr.	106653	Vergl.-Nr.	112232
Beschreibung	Brennerdeckel 3.7kW komplett		

			
1			
GEV-Nr.	105797	Vergl.-Nr.	112224
Beschreibung	Brennerdeckel ø 104mm 5.8kW mit Mittelloch Loch ø 39mm		

			
1			
GEV-Nr.	105795	Vergl.-Nr.	199992
Beschreibung	Brennerkopf 3.7kW		

			
1			
GEV-Nr.	105800	Vergl.-Nr.	199992 old version
Beschreibung	Brennerkopf 5.8kW		

			
1			
GEV-Nr.	105794	Vergl.-Nr.	177792
Beschreibung	Brennerring 3.7kW groß		

			
1			
GEV-Nr.	105793	Vergl.-Nr.	177768
Beschreibung	Brennerring 3.7kW klein		

			
1			
GEV-Nr.	105799	Vergl.-Nr.	177806
Beschreibung	Brennerring 5.8kW groß		

			
1			
GEV-Nr.	105798	Vergl.-Nr.	177776
Beschreibung	Brennerring 5.8kW klein		

Gasdüsen

Zündbrennerdüsen

Zündbrennerdüsen EGA

			
1			
GEV-Nr.	100215	Vergl.-Nr.	162558
Beschreibung	Zündbrennerdüse Erdgas Bohrung ø 0.28mm VPE 1 Stück		



			
1			
GEV-Nr.	100214	Vergl.-Nr.	112534
Beschreibung	Zündbrennerdüse Flüssiggas Bohrung ø 0.16mm VPE 1 Stück		

Hilfsmittel Gas

Gasleitungen

Zündgasleitungen

Universal

			
1			
GEV-Nr.	102110	Vergl.-Nr.	112488
Beschreibung	Zündgasleitung Kupfer Rohr ø 4mm Wandstärke 1mm L 3000mm		
Zubehör für	102110		
	GEV-Nr.	100908	Vergl.-Nr. —
	Überwurfschraube Gewinde M10x1 für Rohr-ø 4mm VPE 1 Stück		
	GEV-Nr.	101246	Vergl.-Nr. —
	Schneidring für Rohr-ø 4mm VPE 1 Stück		

Knebel

Herstellerspezifische Knebel

MALAG



1

GEV-Nr.	110217	Vergl.-Nr.	179922
Beschreibung	Knebel Gashahn mit Zündflamme ø 64mm Achse ø 9x7mm Abflachung horizontal schwarz		



1

GEV-Nr.	110218	Vergl.-Nr.	1004243,179930
Beschreibung	Knebel Gasthermostat 1-8 ø 64mm Achse ø 9x7mm Abflachung horizontal		



1

GEV-Nr.	110210	Vergl.-Nr.	144216
Beschreibung	Knebel Schalter 0-1-0-1 ø 64mm Achse ø 6x4,6mm Abflachung unten schwarz		



1

GEV-Nr.	110211	Vergl.-Nr.	144452
Beschreibung	Knebel Schalter 4-Takt ø 64mm Achse ø 6x4,6mm Abflachung unten schwarz		



1

GEV-Nr.	110212	Vergl.-Nr.	143871
Beschreibung	Knebel Schalter 7-Takt ø 64mm Achse ø 6x4,6mm Abflachung unten schwarz		



1

GEV-Nr.	110213	Vergl.-Nr.	106100
Beschreibung	Knebel Thermostat T.max. 110°C ø 64mm Achse ø 6x4,6mm Abflachung unten schwarz Arbeitsbereich 30-110°C		



1

GEV-Nr.	110215	Vergl.-Nr.	106128
Beschreibung	Knebel Thermostat T.max. 250°C ø 64mm Achse ø 6x4,6mm Abflachung unten schwarz Arbeitsbereich 50-250°C Drehwinkel 270° Thermostat		



1

GEV-Nr.	110214	Vergl.-Nr.	106119 144208
Beschreibung	Knebel Thermostat T.max. 300°C ø 64mm Achse ø 6x4,6mm Abflachung unten schwarz Arbeitsbereich 50-300°C Thermostat		



1

GEV-Nr.	110216	Vergl.-Nr.	106135
Beschreibung	Knebel Thermostat T.max. 370°C ø 64mm Achse ø 6x4,6mm Abflachung unten schwarz Arbeitsbereich 130-370°C		



Scharniere

Backofenscharniere

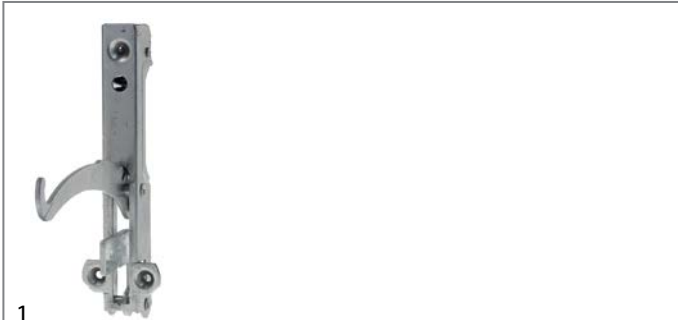



GEV-Nr.	700898 ¹	Vergl.-Nr.	143928
Beschreibung	Backofenscharnier BA 118mm Laschenbefestigung 12mm Hebellänge 113mm Nutabstand 6mm Federstärke 3.5mm Laschenposition links/rechts Federlänge 55mm L 155mm B 22mm mit Gegenhalter		

¹mit Gegenhalter

Großküchenarmaturen

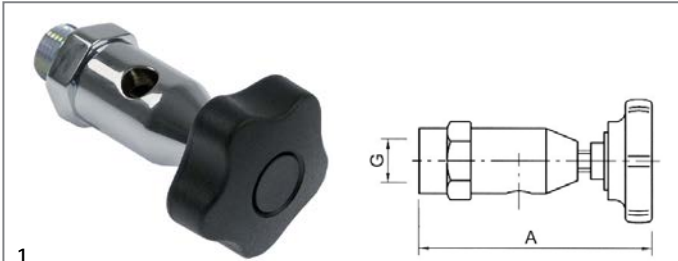
Be- und Entlüfter



GEV-Nr.	540013	Vergl.-Nr.	114405	
Beschreibung	Be- und Entlüfter Gewinde 3/8" AG SW 27 verchromt L 86mm			
Ersatzteile für	540013			
	GEV-Nr.	112777	Vergl.-Nr.	—
	Sterngriff Achse 6x6mm ø 50mm L 18mm schwarz Kunststoff			
	GEV-Nr.	540365	Vergl.-Nr.	—
	Sterngriff Achse 6x6mm ø 50mm L 18mm schwarz Thermoplast			

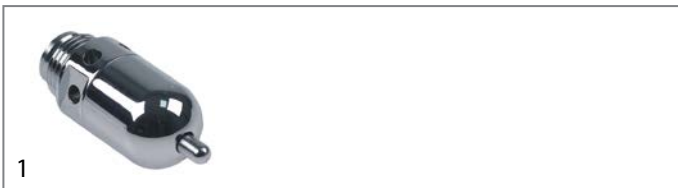

GEV-Nr.	540011	Vergl.-Nr.	113905
Beschreibung	Be- und Entlüfter Gewinde 1/2" AG Messing verchromt metallisch dichtend L 42mm ø 26mm		

GEV-Nr.	540010	Vergl.-Nr.	113891
Beschreibung	Be- und Entlüfter Gewinde 3/8" AG SW 22 verchromt metallisch dichtend L 22mm		

Probierhähne

Probierhähne

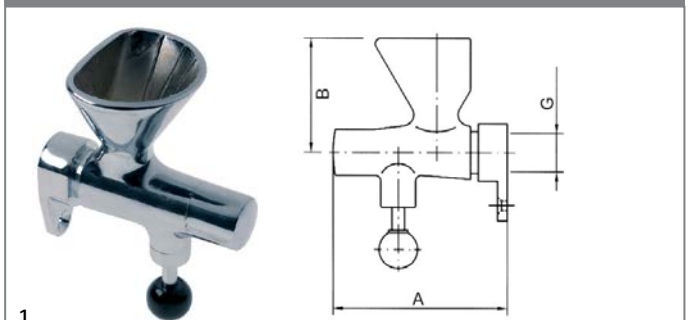

GEV-Nr.	540079	Vergl.-Nr.	114227
Beschreibung	Fülltrichter Gewinde 1/2" IG B 90mm B1 60mm		

Körbe

Frittierkörbe

MALAG

	GEV-Nr.	970436	Vergl.-Nr.	113123
Beschreibung	Frittierkorb L1 320mm B1 160mm H1 165mm			

	GEV-Nr.	970437	Vergl.-Nr.	113131
Beschreibung	Frittierkorb L1 380mm B1 320mm H1 180mm			

Federn

Zugfedern



GEV-Nr.	700897	Vergl.-Nr.	144517
Beschreibung	Zugfeder ø 18mm Gesamtlänge 164mm Drahtstärke ø 2mm L1 17mm L2 130mm L3 17mm		

B

Backofenscharniere 16

G

Gasbrenner 13

Gasdüsen 14

Gashähne 9

Gasleitungen 14

Glimmlampen 8,8

H

Heizkörper 3

Heizkörper für Backöfen 3

Heizkörper für Bain-Maries 3

Heizkörper für Fritteusen 3

Heizkörper für Wärmeschränke 3

Heizstäbe 3

K

Kochplatten 4

Kochstellenbrenner 13

L

Lampen 8

M

Magnetventile 9

N

Nockenschalter 8

P

Piezozünder 13

Pilotheizkörper 3

Pressostate 9

Q

Quarzheizkörper 4

R

Regelthermostate 6

S

Schalter und Taster 8

Sicherheitsthermostate 7

Signallampen 8

T

Tauchheizkörper 4

Thermoelemente 13

Thermostate 6

Z

Zündbrenner 12