



GAS COMPONENTS



ELECTRIC COMPONENTS



WATER TECHNOLOGY



MECHANICAL COMPONENTS



TOOLS

Spare parts suitable for

MECNOSUD

Find the complete and up-to-date range of products in our GEV Webshop



Manufacturer catalogue

The most important spare parts and accessories arranged clearly for every manufacturer

- ✓ Complete product range and all appliance data always up to date in the GEV Webshop
- ✓ Alphabetical Index at the end of the catalogue

GEV Webshop

www.gev-online.co.uk

www.gev-online.com



- 🔍 Add to Favourites
- 🔍 Sign In with email address and usual password
- 🔍 Easy-order – place several items in your basket at the same time
- 🔍 Quick Item search – no login needed



switches and momentary switches

rocker/momentary rocker switches

30x22mm

blank



1

GEV No. 301005 **Ref. No.** DLX30026

description rocker switch mounting measurements 30x22mm red 2NO 250V 16A illuminated connection male faston 6.3mm ambient temperature max. 125/55°C protection IP65 with protecting cover

accessories for 301005



GEV No. 301036 **Ref. No.** —
protective cover internal size 30x22mm for rocker switch mounting measurementsmm

microswitches

roller actuated

roller 0°



1

GEV No. 347155 **Ref. No.** FC12 MIC00308

description microswitch with roller plunger 15A 1CO connection screw thread M12x1 type Z15G1308

rotary switches

BRETER

rotary switches



1

GEV No. 347156 **Ref. No.** IMX0173
IMX0C173
IMXGC173

description rotary switch 3 1-0-2 sets of contacts 8 type LE2-16-7293 690V 16A shaft ø 8x9mm shaft L 20mm shaft star-shaped with knob connection screw

electronics

PCBs



1

GEV No. 402320 **Ref. No.** IMXNH015

description PCB



1

GEV No. 697124 **Ref. No.** Scheda Elettrica B7

description PCB 230/400V



1

GEV No. 401640 **Ref. No.** DLX30003

description PCB for dough rolling machine DL 30-40 230V

keypads

front foils



1

GEV No. 401641 **Ref. No.** DLX30006

description keypad foil dough rolling machine DL 30-40 L 100mm W 80mm

equipment-specific units

for dough mixers

chains

roller chains 06B-1 single



1

GEV No.	697127	Ref. No.	CA 3/8(42anelli-IM18T) IMX12022
description	roller chain DIN/ISO 06 B-1 splitting 3/8" / 9.525mm links 42 internal width 5.72mm rollerø 6.35mm single		

dough hooks

with mounting thread



1

GEV No.	697287	Ref. No.	IMX25021 SP25/38 spiral hook IM
description	dough hook thread M22x1.5 usable height 290mm IM25T-IM38T		

for dough roller

wipers



1

GEV No.	696339	Ref. No.	DL030032
description	wiper for dough roller L 355mm mounting pos. front		



1

GEV No.	696340	Ref. No.	DL030031
description	wiper for dough roller L 355mm mounting pos. rear DL30/DL30M		

roll units (complete)



1

GEV No.	691234	Ref. No.	DL030100
description	roller assembly L 165mm mounting pos. upper		

rollers



1

GEV No.	694293	Ref. No.	DLX40030
description	roller for dough roller L 420mm ø 48mm mounting pos. bottom in the front		

holders



1

GEV No.	692301	Ref. No.	DLX30040+DLX30054+DLX30055+DLX30056 Mor
description	lever complete hole ø 9.8mm H 21mm hole distance 32mm		

spare parts for 692301

	GEV No.	697346	Ref. No.	—
	description	ball handle thread M4 ø 20mm black		

accessories for 692301

	GEV No.	691637	Ref. No.	10303020
	description	roll pin ø 3mm L 20mm		



levers



1

GEV No.	691233	Ref. No.	DL030018
description	lever shaft intake ø 8mm L 220mm DL30		

couplings



1

GEV No.	694263	Ref. No.	DLX30035
description	coupling ø 36mm ID ø 26mm H 17mm		



1

GEV No.	694264	Ref. No.	DLX30021
description	coupling ø 42mm ID ø 25mm H 12mm		

pulleys



1

GEV No.	691230 ¹	Ref. No.	DLX30013
description	round belt pulley disc ø 94mm double shaft intake ø 14x11mm groove depth 6mm disc width 29mm groove width 10mm overall width 29mm plastic DL 30-40 drive shaft		

¹double



1

GEV No.	691229 ¹	Ref. No.	DLX30012
description	V-belt pulley disc ø 75mm double shaft intake ø 13mm 14 groove depth 6mm disc width 29mm groove width 10mm overall width 32mm plastic DL 30-40 motor		

¹double

pinions

rear mounting



1

GEV No.	694908	Ref. No.	DLX30043
description	pinion ø 47mm H 34mm mounting pos. rear ID ø 25mm edition since year of construction 2014		

front mounting



1

GEV No.	694261	Ref. No.	DLX30036
description	pinion ø 47mm teeth 19 plastic H 34mm shaft ø 17mm		

springs



1

GEV No.	693920	Ref. No.	DLX30033
description	spring for pinion ø 49mm thickness 1.5mm Qty 2 pcs		

transmission technology and ball bearings

ball bearings

deep-groove ball bearings 2RS



1

GEV No.	523551	Ref. No.	C60032RS
description	deep-groove ball bearing type 6003-2RS shaft ø 17mm ED ø 35mm W 10mm with sealing discs deep-groove ball bearing DIN 625-1		

drive belts

round belts

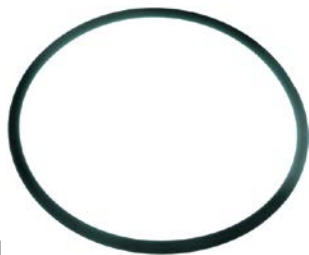

1

GEV No.	691231	Ref. No.	DL030019
description	round belt ø 8mm L 640mm		

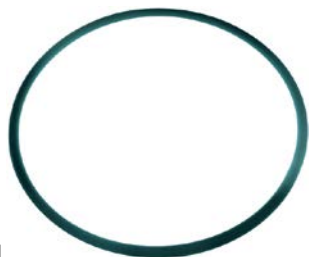

1

GEV No.	691232	Ref. No.	DL030014
description	round belt ø 8mm L 730mm		

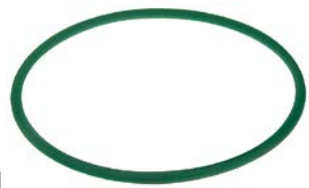

1

GEV No.	694259	Ref. No.	DL040019
description	round belt ø 8mm L 750mm mounting pos. lower		

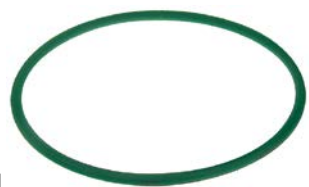

1

GEV No.	694260	Ref. No.	DL040014
description	round belt ø 8mm L 933mm mounting pos. upper		

chains

roller chains 06B-1 single



1

GEV No.	697127	Ref. No.	CA 3/8(42anelli-IM18T) IMX12022
description	roller chain DIN/ISO 06 B-1 splitting 3/8" / 9.525mm links 42 internal width 5.72mm rollerø 6.35mm single		

springs

torsion springs



1

GEV No.	694241	Ref. No.	DLX30027
description	spring ømm L2 80mm mounting pos. front wire gauge ø 2mm DL 30-40 L1mm Qty 1 pcs		



1

GEV No.	694240	Ref. No.	DLX30024
description	spring ømm L2 80mm mounting pos. rear wire gauge ø 2mm DL 30-40 L1mm Qty 1 pcs		

fastening material

fasteners

retaining rings

DIN 471



1

GEV No.	504519	Ref. No.	051D1700
description	retaining ring shaft ø 17mm thickness 1mm SS DIN 471		

roll pins



1

GEV No.	691637	Ref. No.	10303020
description	roll pin ø 3mm L 20mm		

F

fasteners	6
fastening material	6

M

microswitches	3
---------------	---

R

retaining rings	6
rocker/momentary rocker switches	3
roll pins	6
rotary switches	3

S

switches and momentary switches	3
---------------------------------	---