



GAS COMPONENTS



ELECTRIC COMPONENTS



WATER TECHNOLOGY



MECHANICAL COMPONENTS



TOOLS

Spare parts suitable for

MULTINOX

Find the complete and up-to-date range of products in our GEV Webshop



Manufacturer catalogue

The most important spare parts and accessories arranged clearly for every manufacturer

- ✓ Complete product range and all appliance data always up to date in the GEV Webshop
- ✓ Alphabetical Index at the end of the catalogue

GEV Webshop

www.gev-online.co.uk

www.gev-online.com



- 🔍 Add to Favourites
- 🔍 Sign In with email address and usual password
- 🔍 Easy-order – place several items in your basket at the same time
- 🔍 Quick Item search – no login needed





heating elements

ceramic heaters

245x60mm



1

GEV No.	415102	Ref. No.	563001013
description	ceramic emitter 400W 230V cable beaded cord L 245mm W 60mm H 35mm		
spare parts for	415102		
	GEV No.	415109	Ref. No. —
	spring clip		
accessories for	415102		
	GEV No.	415110	Ref. No. —
	reflector L 245mm W 95mm H 31mm thickness 0.75mm hole ø 15x40mm		

heating elements for convection





1

GEV No.	418317	Ref. No.	563000900
description	heating element 1450W 240V heating circuits 1 ID ø 185mm ED ø 200mm Lmm H 30mm L1 12mm W1 31mm H1 25mm H2 10mm flange length 70mm flange width 22mm hole distance 56mm connection male faston 6.3mm tube ø 6.3mm convection heating element mounting thread M4 rectangular flange		
accessories for	418317		
	GEV No.	510368	Ref. No. —
	gasket L 70mm W 23.5mm hole ø 5mm hole distance 56mm FIBER thickness 2mm for heating element		



1

GEV No.	415966	Ref. No.	563000800
description	heating element 2500W 230V heating circuits 1 ID ø 176mm ED ø 188mm L 210mm H 28mm L1 22mm W1 30mm H1 3mm H2 25mm flange length 70mm flange width 22mm hole distance 56mm connection male faston 6.3mm tube ø 6.3mm convection heating element hole ø 5mm rectangular flange		
spare parts for	415966		
	GEV No.	510368	Ref. No. —
	gasket L 70mm W 23.5mm hole ø 5mm hole distance 56mm FIBER thickness 2mm for heating element		

accessories for	415966		
	GEV No.	510368	Ref. No. —
	gasket L 70mm W 23.5mm hole ø 5mm hole distance 56mm FIBER thickness 2mm for heating element		

energy regulators

EGO

1-circuit



1

GEV No.	380015	Ref. No.	564010400
description	energy regulator 230V 13A single-circuit turn direction right shaft ø 6x4.6mm shaft L 23mm mounting thread M4 power release 6-100% no. 50.57021.010		

thermostats

bi-metal thermostats

safety bi-metal thermostats



1

GEV No.	375755	Ref. No.	564011000
description	bi-metal safety thermostat switch-off temp. 105°C 1NC 1-pole 16A connection F6.3		
accessories for	375755		
	GEV No.	550389	Ref. No. —
	bracket for contact thermostat		

control and safety thermostats

various

control thermostats

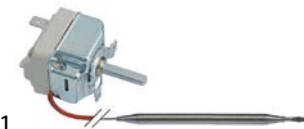

1

GEV No.	375756	Ref. No.	564010000
description	thermostat t.max. 90°C temperature range 30-90°C 1-pole 1CO probe ø 6mm probe L 126mm capillary pipe 900mm shaft ø 6x4.6mm shaft position upper rotation 270°		



lamps

indicator lights

indicator lights 2-piece (lens and indicator lamp)

indicator light lenses

ø10mm (type SRZ-3)



1

GEV No.	359123	Ref. No.	568000200
description	indicator light housings mounting measurements ø10mm green round Qty 1 pcs		
accessories for	359123		
	GEV No.	359132	Ref. No. 568000300
description	indicator lamp green 250V connection male faston 6.3mm protection IP54 ambient temperature max. 85°C		

indicator lamps for socket type SRZ / SDK / SDY / SFK



1

GEV No.	359132	Ref. No.	568000300
description	indicator lamp green 250V connection male faston 6.3mm protection IP54 ambient temperature max. 85°C		

fans

hot air fans

miscellaneous

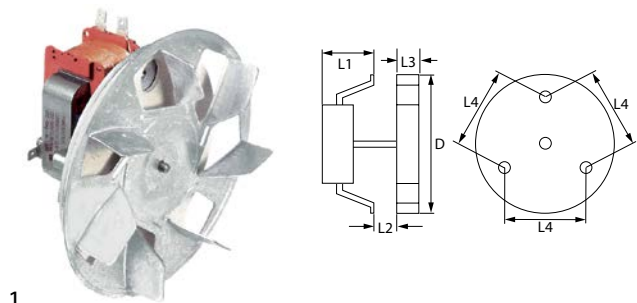

1

GEV No.	601273	Ref. No.	569010100
description	hot air fan 220-240V 32W 50/60Hz L1 60mm L2 10mm L3 25mm L4 87mm fan wheel ø 155mm FIME type C20X0E01/15CLH		

accessories

miscellaneous



1

GEV No.	550879	Ref. No.	569011000
description	insulation ø 130mm thickness 3mm hole ø 20mm for hot air fan		

electric accessories

terminals

connection terminals with screw/faston connections



1

GEV No.	550278	Ref. No.	566050000
description	power terminal block 3-pole max. 40A max 400V connection ø6mm ² / F6.3 temp.-resist. 150°C cross section 6mm ²		

knobs

accessories

rosettes



1

GEV No.	111915	Ref. No.	564010800
description	rosette ø 37mm knob knob ø 30mm		



measuring equipment

thermometers

built-in thermometers

ø52mm



1

GEV No.	541413	Ref. No.	564001700
description	thermometer mounting ø 52mm t.max. 120°C 0 up to +120°C probe ø 6mm probe L 36mm capillary pipe 1500mm		

B

bi-metal thermostats 3

C

ceramic heaters 3

E

electric accessories 4

energy regulators 3

F

fans 4

H

heating elements 3

heating elements for convection 3

hot air fans 4

I

indicator lights 4

L

lamps 4

M

measuring equipment 5

S

safety bi-metal thermostats 3

T

terminals 4

thermostats 3