



COMPONENTES GAS



COMPONENTES ELÉCTRICOS



TECNOLOGÍA DEL AGUA



COMPONENTES MECÁNICOS



HERRAMIENTAS

Repuestos adaptables a

NUOVASIMONELLI

Encuentre nuestra gama siempre actualizada en la tienda online de GEV



Catálogo de fabricantes

Las piezas de repuesto y accesorios más importantes de cada fabricante reunidas y ordenadas de manera práctica

- ✓ En la tienda online GEV encontrará el surtido completo y toda la información actualizada de máquinas y aparatos
- ✓ Índice alfabético al final del catálogo

Tienda online GEV

www.gev-online.es
www.gev-online.com







- 🔍 marcar artículos como favoritos
- 🔍 acceso mediante su e-mail y su contraseña habitual
- 🔍 ponga en la cesta de la compra, múltiples artículos a la vez
- 🔍 búsqueda de artículos inmediata sin necesidad conectarse









resistencias

resistencias de máquinas de café





			
código	417193	referencia	14100035
descripción	cartucho calentador 14W 230V ø 12mm L 64mm empalme cable longitud del cable 230mm		
Para modelos:	Master1		



			
código	417194	referencia	14100037
descripción	cartucho calentador 600W 230V espirales 1 L 74mm ø 10mm rosca 3/8" longitud del cable 250mm resistencia de inmersión fijación atornillada		
Para modelos:	Master1		
accesorios para	417194		
	código	referencia	—
	518393		
	junta plana FIBER ø ext. 24mm int.ø 17mm espesor 2mm UE 1 pzs		
	código	referencia	—
	528885		
	junta plana PTFE ø ext. 26mm int.ø 17mm espesor 2mm UE 1 pzs para SPAZIALE		

			
código	417132	referencia	14100008
descripción	resistencia 1200W 230V espirales 1 ø 88mm H 42mm B1 70mm H1 20mm H2 22mm distancia de sujeción 62mm rosca 1/4" cobre espirales 2 tubo ø 8mm resistencia de inmersión sujeción 2 orificios empalme M4		
accesorios para	417132		
	código	referencia	18010386
	361182		
	tuerca rosca 1/4" H 5mm latón niquelado EC 17 UE 1 pzs		
	código	referencia	—
	510417		
	junta plana fibra ø ext. 20mm int.ø 14mm espesor 2mm UE 1 pzs		
	código	referencia	—
	520228		
	arandela dentada int.ø 15.3mm ø ext. 24mm acero UE 1 pzs para rosca M14		
	código	referencia	—
	550262		
	junta plana cobre ø ext. 20mm int.ø 14mm espesor 2mm		

			
código	417195	referencia	14100040
descripción	resistencia 1200W 230V espirales 1 rosca 1" L 155mm An 22mm H 22mm tubo ø 8.5mm ø casquillo portasondas 7mm longitud casquillo portasondas 160mm casquillo portasondas 1 casquillo termostato descentrado, ceñido empalme conector Faston 6,3mm resistencia de inmersión brida roscada EC 30		
Para modelos:	Oscar		
accesorios para	417195		
	código	referencia	—
	510404		
	junta plana fibra ø ext. 44mm int.ø 34mm espesor 2mm UE 1 pzs		



accesorios para	417195		
	código	referencia	—
	528018		
	junta plana PTFE ø ext. 41mm int.ø 33mm espesor 3mm tamaño 1" UE 1 pzs		

			
código	417054	referencia	14100009
descripción	resistencia 1400W 230V espirales 1 ø 70mm H 60mm H1 18mm H2 42mm distancia de sujeción 40mm rosca 1/4" espirales 4 tubo ø 8.5mm resistencia de inmersión sujeción 2 orificios empalme M3		
Para modelos:	Beach		
accesorios para	417054		
	código	referencia	18010386
	361182		
	tuerca rosca 1/4" H 5mm latón niquelado EC 17 UE 1 pzs		
	código	referencia	—
	510417		
	junta plana fibra ø ext. 20mm int.ø 14mm espesor 2mm UE 1 pzs		
	código	referencia	—
	520228		
	arandela dentada int.ø 15.3mm ø ext. 24mm acero UE 1 pzs para rosca M14		
	código	referencia	—
	527169		
	tuerca hexagonal rosca M3 H 2.8mm EC 5.5 latón UE 1 pzs		
	código	referencia	—
	550262		
	junta plana cobre ø ext. 20mm int.ø 14mm espesor 2mm		
	código	referencia	—
	560110		
	arandela int.ø 3.2mm ø ext. 7mm espesor 0.5mm inox UE 20 pzs DIN 125A para rosca M3		
	código	referencia	—
	560130		
	tuerca hexagonal rosca M3 H 2.4mm EC 5.5 inox DIN/ISO DIN 934 / ISO 4032/8673 UE 20 pzs		



			
código	417052	referencia	14100024 14100084
descripción	resistencia 1800W 230V espirales 3 montaje ø 54mm dist. del agujero 54/76mm L 165mm An 31mm H 46mm L1 20mm L2 36mm L3 120mm H1 26mm H2 20mm tubo ø 8.5mm empalme M4 resistencia de inmersión brida 6 orificios		
Para modelos:	MAC2000, MacDigit, Personal, Program		
accesorios para	417052		
	código	referencia	—
	528805		
	junta plana PTFE ø ext. 68mm int.ø 55mm espesor 2.4mm UE 1 pzs para NUOVA SIMONELLI		

			
código	415202	referencia	14100038 14100054
descripción	resistencia 2000W 230V espirales 1 rosca 1" L 170mm An 22mm H 23mm tubo ø 8mm empalme conector Faston 6,3mm resistencia de inmersión brida roscada		
accesorios para	415202		
	código	510404	referencia —
junta plana fibra ø ext. 44mm int.ø 34mm espesor 2mm UE 1 pzs			
	código	510422	referencia —
junta cobre ø ext. 37.7mm int.ø 32.5mm espesor 2.7mm para rosca 1"			
	código	520233	referencia —
tuerca rosca 1" H 6mm latón EC 47 UE 1 pzs			



			
código	417490	referencia	14100054
descripción	resistencia 2300W 230V espirales 1 rosca 1" L 172mm An 22mm H 25mm tubo ø 8.5mm empalme conector Faston 6,3mm EC 30 aparatos de café acero inoxidable		
Para modelos:	Caffetteria-Italiana		



			
código	417131	referencia	14100027
descripción	resistencia 2700W 230V espirales 3 montaje ø 54mm dist. del agujero 77mm L 182mm An 32mm H 52mm L1 120mm L2 36mm L3 120mm H1 25mm H2 27mm agujero ø 8mm tubo ø 8mm empalme M4 resistencia de inmersión brida 6 orificios		
Para modelos:	Premier, Premier5		
accesorios para	417131		
	código	528804	referencia —
junta plana fibra ø ext. 66mm int.ø 56mm espesor 2mm UE 1 pzs			

			
código	417053	referencia	14100011
descripción	resistencia 3000W 230V espirales 3 montaje ø 54mm dist. del agujero 55mm L 330mm An 38mm H 55mm L1 22mm L2 66mm L3 237mm H1 26mm H2 29mm agujero ø 8mm tubo ø 8.5mm empalme M3 resistencia de inmersión brida 6 orificios		
Para modelos:	Appia-2-3gr, Appia-2GR, Athena-Leva, Aurelia, MAC2000, MacDigit, Program		
accesorios para	417053		
	código	527169	referencia —
tuerca hexagonal rosca M3 H 2.8mm EC 5.5 latón UE 1 pzs			
	código	560110	referencia —
arandela int.ø 3.2mm ø ext. 7mm espesor 0.5mm inox UE 20 pzs DIN 125A para rosca M3			
	código	560130	referencia —
tuerca hexagonal rosca M3 H 2.4mm EC 5.5 inox DIN/ISO DIN 934 / ISO 4032/8673 UE 20 pzs			

			
código	417182	referencia	14100004
descripción	resistencia 3400W 230V espirales 3 montaje ø 54mm dist. del agujero 55mm L 340mm An 39mm H 24mm agujero ø 8mm tubo ø 8.5mm empalme 1/8" resistencia de inmersión brida 6 orificios		
Para modelos:	Optima		
accesorios para	417182		
	código	528804	referencia —
junta plana fibra ø ext. 66mm int.ø 56mm espesor 2mm UE 1 pzs			



			
código	417184	referencia	14100031
descripción	resistencia 4500W 230V espirales 2 montaje ø 54mm dist. del agujero 55mm L 335mm An 37mm H 51mm L1 35mm L2 50mm L3 255mm H1 23mm H2 28mm agujero ø 8mm tubo ø 8.5mm empalme M3 resistencia de inmersión brida 6 orificios		
Para modelos:	Aurelia, Aurelia-2GR, Aurelia-3GR, Aurelia-4GR, Premier, Premier5		
accesorios para	417184		
	código	527169	referencia —
tuerca hexagonal rosca M3 H 2.8mm EC 5.5 latón UE 1 pzs			
	código	560110	referencia —
arandela int.ø 3.2mm ø ext. 7mm espesor 0.5mm inox UE 20 pzs DIN 125A para rosca M3			
	código	560130	referencia —
tuerca hexagonal rosca M3 H 2.4mm EC 5.5 inox DIN/ISO DIN 934 / ISO 4032/8673 UE 20 pzs			

			
código	417292	referencia	14100012
descripción	resistencia 5000W 220V espirales 3 montaje ø 55mm dist. del agujero 77mm L 575mm An 36mm H 60mm L1 25mm L2 60mm L3 490mm H1 24mm H2 36mm agujero ø 8mm tubo ø 8.3mm empalme M3 resistencia de inmersión brida 6 orificios		
Para modelos:	Appia-2GR, Appia-3GR, Athena-Leva, Aurelia, Aurelia-2GR, Aurelia-3GR, Aurelia-4GR, MAC2000, MacDigit, Program		
accesorios para	417292		
	código	526402	referencia 02060015
junta plana PTFE ø ext. 67mm int.ø 54mm espesor 2mm UE 1 pzs			

			
código	417130	referencia	14100012
descripción	resistencia 5000W 230V espirales 3 montaje ø 54mm dist. del agujero 30mm L 522mm An 27mm H 38mm agujero ø 7.5mm empalme M3 resistencia de inmersión brida 8 orificios		
accesorios para	417130		
	código	527169	referencia —
tuerca hexagonal rosca M3 H 2.8mm EC 5.5 latón UE 1 pzs			

Continúa en la página siguiente



accesorios para	417130			
	código	560110	referencia	—
	arandela int.ø 3.2mm ø ext. 7mm espesor 0.5mm inox UE 20 pzs DIN 125A para rosca M3			
	código	560130	referencia	—
	tuerca hexagonal rosca M3 H 2.4mm EC 5.5 inox DIN/ISO DIN 934 / ISO 4032/8673 UE 20 pzs			



				
código	417293	referencia	14100084	
descripción	resistencia INCOLOY 1800W 230V espirales 3 montaje ø 55mm dist. del agujero 77mm L 155mm An 36mm H 50mm L1 20mm L2 55mm L3 80mm H1 24mm H2 26mm agujero ø 8mm tubo ø 8.5mm empalme M4 brida 6 orificios			
Para modelos:	Appia-1GR			

				
código	417228	referencia	14100050 14100088	
descripción	resistencia INCOLOY 2600W 230V espirales 1 rosca 1¼" L 155mm ø 35mm tubo ø 6.3mm ø casquillo portasondas 7.5mm longitud casquillo portasondas 150mm casquillo portasondas 1 casquillo termostato descentrado, ceñido empalme conector Faston 6,3mm resistencia de inmersión brida roscada EC 37 An 52mm H 52mm			
Para modelos:	2GR-Compact, Appia-2GR-compact, Caffetteria-Italiana			
repuestos para	417228			
	código	510405	referencia	18010760
	junta plana fibra ø ext. 56mm int.ø 42mm espesor 2mm para rosca 1¼" UE 1 pzs			
accesorios para	417228			
	código	528021	referencia	—
	junta plana PTFE ø ext. 53mm int.ø 42.5mm espesor 3mm UE 1 pzs núm. Ref. 12001/02286 para Astoria/Aurora/Brasilía/Wega			

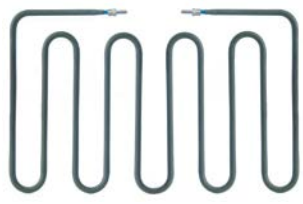
resistencias para grill de contacto

				
código	416590	referencia	15320004	
descripción	resistencia 1150W 230V L 192mm An 304mm H 18mm B1 98mm B2 108mm longitud de empalme 24mm tubo ø 6.3mm espirales 5 empalme M4 pos. de montaje abajo resistencia seca			





cartuchos calentadores

				
código	417194	referencia	14100037	
descripción	cartucho calentador 600W 230V espirales 1 L 74mm ø 10mm rosca 3/8" longitud del cable 250mm resistencia de inmersión fijación atornillada			
Para modelos:	Master1			
accesorios para	417194			
	código	518393	referencia	—
	junta plana FIBER ø ext. 24mm int.ø 17mm espesor 2mm UE 1 pzs			
	código	528885	referencia	—
	junta plana PTFE ø ext. 26mm int.ø 17mm espesor 2mm UE 1 pzs para SPAZIALE			

				
código	417193	referencia	14100035	
descripción	cartucho calentador 14W 230V ø 12mm L 64mm empalme cable longitud del cable 230mm			
Para modelos:	Master1			

resistencias de inmersión

brida 2 orificios 74mm

				
código	415191	referencia	18000003	
descripción	resistencia 2300W 220V espirales 1 montaje ø 42mm L 240mm An 29mm H 27mm L1 35mm L2 35mm L3 170mm tubo ø 8.5mm dist. del agujero 74mm agujero ø 8mm empalme M4 resistencia de inmersión brida 2 orificios H1 8mm H2 23mm longitud brida 94mm anchura brida 58mm			
accesorios para	415191			
	código	521103	referencia	—
	tuerca rosca M4 H 3mm EC 7 latón UE 20 pzs			
	código	521104	referencia	—
	arandela int.ø 4.3mm ø ext. 8mm espesor 0.5mm latón UE 20 pzs para rosca M4			
	código	560111	referencia	—
	arandela int.ø 4.3mm ø ext. 9mm espesor 0.8mm inox UE 20 pzs DIN 125A para rosca M4			
	código	560131	referencia	—
	tuerca hexagonal rosca M4 H 3.2mm EC 7 inox DIN/ISO DIN 934 / ISO 4032/8673 UE 20 pzs			

brida 3 orificios \varnothing 35,0mm

código 416210 **referencia** 18011020

descripción resistencia 2200W 230V espirales 1 montaje \varnothing 35mm L 253mm An 25mm H 25mm tubo \varnothing 6.5mm dist. del agujero 44mm agujero \varnothing 10mm empalme M5 resistencia de inmersión brida 3 orificios longitud de empalme 16mm

accesorios para 416210

código	507048	referencia	—
---------------	--------	-------------------	---



junta int. \varnothing 30mm silicona espesor 3mm agujero \varnothing 10mm dist. del agujero 41mm para resistencia sistemas de lavado

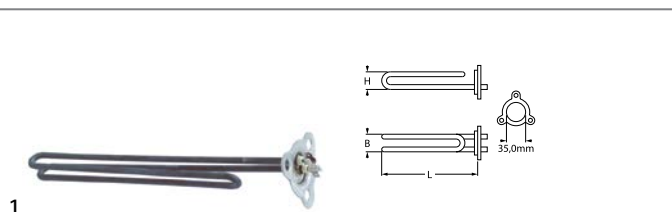

código 416211 **referencia** 18010296

descripción resistencia 2700W 230V espirales 1 montaje \varnothing 35mm L 300mm An 25mm H 24mm tubo \varnothing 6.3mm dist. del agujero 44mm agujero \varnothing 10mm empalme conector Faston 6,3mm resistencia de inmersión brida 3 orificios longitud de empalme 15mm

accesorios para 416211

código	507048	referencia	—
---------------	--------	-------------------	---



junta int. \varnothing 30mm silicona espesor 3mm agujero \varnothing 10mm dist. del agujero 41mm para resistencia sistemas de lavado

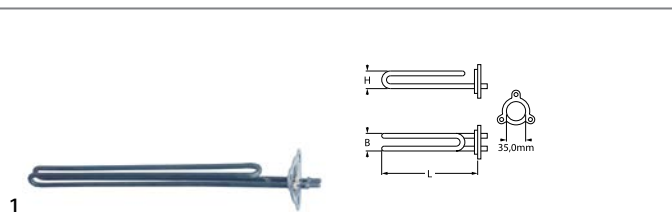

código 416212 **referencia** 18010028.1

descripción resistencia 3000W 230V espirales 1 montaje \varnothing 35mm L 330mm An 28.5mm H 25mm tubo \varnothing 6.25mm dist. del agujero 44mm agujero \varnothing 10mm empalme M5 resistencia de inmersión brida 3 orificios longitud de empalme 15mm

Para modelos: KIARA6

accesorios para 416212

código	507048	referencia	—
---------------	--------	-------------------	---

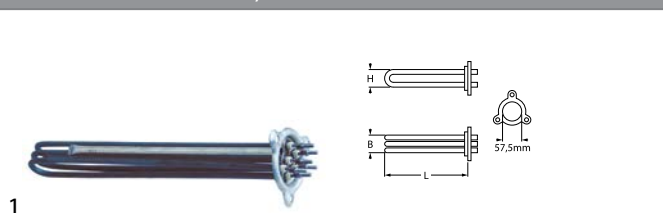

junta int. \varnothing 30mm silicona espesor 3mm agujero \varnothing 10mm dist. del agujero 41mm para resistencia sistemas de lavado

brida 3 orificios \varnothing 57,5mm



código 416213 **referencia** 18010743

descripción resistencia 4500W 230V montaje \varnothing 57.5mm espirales 3 L 383mm An 50mm H 38mm casquillo portasondas 1 \varnothing casquillo portasondas 8mm longitud casquillo portasondas 290mm casquillo termostato descentrado, no ceñido tubo \varnothing 8mm dist. del agujero 70mm agujero \varnothing 8mm empalme M5 brida 3 orificios resistencia de inmersión

Para modelos: KIARA6

accesorios para 416213

código	550002	referencia	—
---------------	--------	-------------------	---



estribo de fijación H 10mm L 21mm An 10mm agujero \varnothing 6.5mm para resistencia

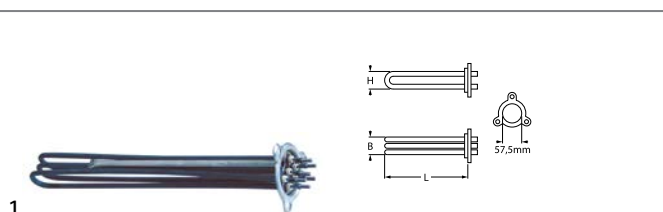

código 416214 **referencia** 18010744

descripción resistencia 6000W 230V montaje \varnothing 57.5mm espirales 3 L 410mm An 32mm H 50mm \varnothing casquillo portasondas 8.5mm longitud casquillo portasondas 270mm casquillo termostato arriba centrado no ajustado tubo \varnothing 8.5mm dist. del agujero 70mm agujero \varnothing 10mm longitud de empalme 30mm empalme M5 brida 3 orificios resistencia de inmersión

Para modelos: KIARA6

repuestos para 416214

código	510409	referencia	18010746
---------------	--------	-------------------	----------



junta tórica EPDM espesor 5.34mm int. \varnothing 56.52mm UE 1 pzs

accesorios para 416214

código	510409	referencia	18010746
---------------	--------	-------------------	----------



junta tórica EPDM espesor 5.34mm int. \varnothing 56.52mm UE 1 pzs

código	520332	referencia	—
---------------	--------	-------------------	---





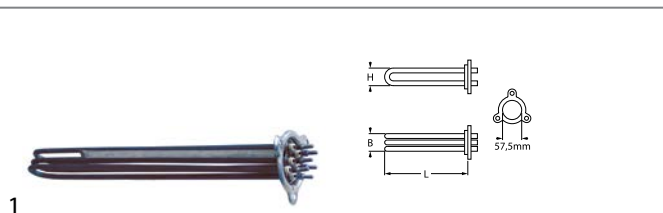

tapa de protección para resistencia





código 416215 **referencia** 18010745



descripción resistencia 9000W 230V montaje \varnothing 57.5mm espirales 3 L 410mm An 35mm H 52mm casquillo portasondas 1 \varnothing casquillo portasondas 7.5mm longitud casquillo portasondas 290mm casquillo termostato descentrado, no ceñido tubo \varnothing 8mm dist. del agujero 70mm agujero \varnothing 8mm empalme M5 brida 3 orificios resistencia de inmersión

1"			
			
código	415195	referencia	18000004
descripción	resistencia 2500W 230V espirales 1 rosca 1" L 200mm An 20mm H 20mm tubo ø 8.5mm empalme conector Faston 6,3mm resistencia de inmersión brida roscada		
accesorios para	415195		
	código	510404	referencia —
	junta plana fibra ø ext. 44mm int.ø 34mm espesor 2mm UE 1 pzs		
	código	510422	referencia —
	junta cobre ø ext. 37.7mm int.ø 32.5mm espesor 2.7mm para rosca 1"		
	código	520233	referencia —
	tuerca rosca 1" H 6mm latón EC 47 UE 1 pzs		

1 1/4"			
			
código	416218	referencia	18010716
descripción	resistencia 4500W 230V espirales 3 rosca 1 1/4" L 275mm An 95mm H 45mm L1 40mm L2 25mm L3 210mm B1 32mm B2 29mm H1 23mm H2 22mm empalme conector Faston 6,3mm resistencia de inmersión brida roscada		
repuestos para	416218		
	código	510405	referencia 18010760
	junta plana fibra ø ext. 56mm int.ø 42mm espesor 2mm para rosca 1 1/4" UE 1 pzs		
accesorios para	416218		
	código	507333	referencia —
	junta plana goma ø ext. 52mm int.ø 41.5mm espesor 3mm UE 1 pzs núm. Ref. G50403GT para IME/Omniwash		
	código	528021	referencia —
	junta plana PTFE ø ext. 53mm int.ø 42.5mm espesor 3mm UE 1 pzs núm. Ref. 12001/02286 para Astoria/Aurora/Brasilia/Wega		

			
código	416216	referencia	18010044.0
descripción	resistencia 1800W 230V espirales 1 L 330mm An 48mm H 32mm rosca M12x1 distancia de sujeción 40mm tubo ø 8.5mm empalme conector Faston 6,3mm sujeción 2 orificios resistencia de inmersión		
accesorios para	416216		
	código	507332	referencia 02060029
	junta plana fibra ø ext. 18mm int.ø 12mm espesor 2mm UE 1 pzs		
	código	511923	referencia 18010515
	tapa de protección para resistencia rosca M12		
	código	550681	referencia —
	tuerca rosca M12x1,25 H 5mm EC 17 latón UE 1 pzs		

			
código	416217	referencia	18010385
descripción	resistencia 2500W 230V espirales 1 L 410mm An 147mm H 27mm rosca M12x1 distancia de sujeción 35mm tubo ø 8.3mm empalme conector Faston 6,3mm sujeción 2 orificios resistencia de inmersión L1 195mm L2 215mm B1 96mm B2 43mm		
Para modelos:	KIARA6		
accesorios para	416217		
	código	507332	referencia 02060029
	junta plana fibra ø ext. 18mm int.ø 12mm espesor 2mm UE 1 pzs		

			
código	416219	referencia	18010044.1 18011021
descripción	resistencia 800W 230V espirales 1 L 317mm An 55mm H 32mm rosca M12x1 distancia de sujeción 46.5mm tubo ø 8.5mm empalme conector Faston 6,3mm sujeción 2 orificios resistencia de inmersión		
accesorios para	416219		
	código	507332	referencia 02060029
	junta plana fibra ø ext. 18mm int.ø 12mm espesor 2mm UE 1 pzs		
	código	520229	referencia —
	tuerca rosca M12x1 H 4mm EC 16 acero zincado UE 1 pzs		

accesorios

tuercas hexagonales

			
código	361182	referencia	18010386
descripción	tuerca rosca 1/4" H 5mm latón níquelado EC 17 UE 1 pzs		
Para modelos:	KIARA6		

			
código	520234	referencia	18010648
descripción	tuerca rosca 3/4" H 5mm latón EC 30 UE 1 pzs		
Para modelos:	KIARA6		



anillos de junta

juntas de fibra

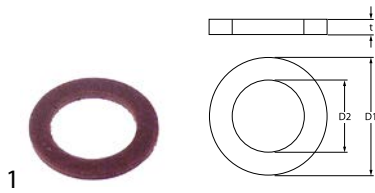

código	507332	referencia	02060029
descripción	junta plana fibra ø ext. 18mm int.ø 12mm espesor 2mm UE 1 pzs		
Para modelos:	KIARA6		

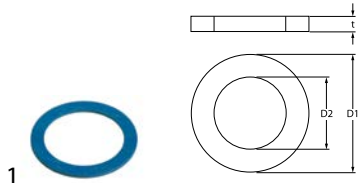

código	510405	referencia	18010760
descripción	junta plana fibra ø ext. 56mm int.ø 42mm espesor 2mm para rosca 1¼" UE 1 pzs		

juntas de goma

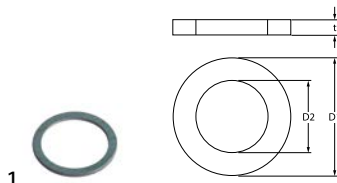

código	521124	referencia	18000026
descripción	junta plana goma ø ext. 52mm int.ø 42mm espesor 6mm UE 1 pzs		

juntas tóricas

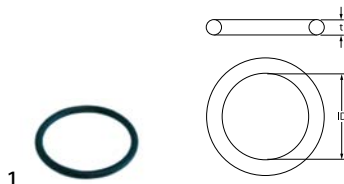

código	510409	referencia	18010746
descripción	junta tórica EPDM espesor 5.34mm int.ø 56.52mm UE 1 pzs		

tapas protectoras



código	511923	referencia	18010515
descripción	tapa de protección para resistencia rosca M12		

termostatos

termostatos de superficie

termostatos de superficie de seguridad



código	390295	referencia	09500006
descripción	termómetro de superficie de seguridad		
Para modelos:	Appia-2GR, Appia-2GR-compact, Appia-3GR, Aurelia, Aurelia-2GR, Aurelia-3GR, Aurelia-4GR, Master1		



código	375754	referencia	09500002
descripción	termómetro de superficie de seguridad dist. del agujero 23.5mm temp. desconexión 125°C 1NC 1 polos 16A empalme F6,3 sujeción 2 orificios		
Para modelos:	Jazz, Microbar		



código	390197	referencia	09500004
descripción	termómetro de superficie de seguridad dist. del agujero 23.8mm temp. desconexión 135°C 1NC 1 polos 16A empalme F6,3 sujeción 2 orificios		
Para modelos:	Appia-1gr, Appia-2-3gr, Appia-2GR, Appia-3GR, Aurelia, Aurelia-2GR, Aurelia-3GR, Aurelia-4GR, Caffetteria-Italiana, Jazz, MAC2000, MacDigit, Master1, Oscar, Premier, Program		



código	390455	referencia	18010789
descripción	termómetro de superficie de seguridad dist. del agujero 40mm temp. desconexión 100°C 2NC 2 polos 16A empalme F6,3 sujeción 2 orificios		
Para modelos:	KIARA6		



			
1			
código	390456	referencia	18010955
descripción	termómetro de superficie de seguridad dist. del agujero 40mm temp. desconexión 85°C 2NC 2 polos 16A empalme F6,3 sujeción 2 orificios		



termostatos de control y seguridad

IMIT / TEMPOMATIC / ARATHERMO

termostatos de regulación

			
1			
código	390186	referencia	18010042
descripción	termóstato T máx 52°C margen de trabajo ajuste fijo 52°C 1 polos 1CO 16A sonda ø 6.5mm sonda L 95mm capilar 1000mm aislamiento del capilar 1000mm prensaestopas eje Lmm contactos 1CO		
Para modelos:	KIARA6		

			
1			
código	390457	referencia	18010043
descripción	termóstato T máx 85°C margen de trabajo 0-90°C 1 polos 1CO 16A sonda ø 6.5mm sonda L 110mm capilar 1000mm aislamiento del capilar 950mm prensaestopas eje ø 6x4,6mm eje L 19mm posición del eje arriba posición del eje +135° ángulo de rotación 270° material de bulbo cobre		
Para modelos:	KIARA6		

			
1			
código	390006	referencia	18010043
descripción	termóstato T máx 86°C margen de trabajo 0-86°C 1 polos 1CO 16A sonda ø 6.5mm sonda L 95mm capilar 1500mm aislamiento del capilar 1500mm prensaestopas eje ø 6x4,6mm eje L 19mm ángulo de rotación 270°		
accesorios para	390006		
	código	110100	referencia 18010388
	pomo termostato T máx 90°C 0-90°C ø 42mm eje ø 6x4,6mm parte plana -135° negro		
	código	110105	referencia —
	roseta pomo ø 42mm ø 56mm marca cero		

interruptores y pulsadores



interruptores/pulsadores basculantes

19x22mm



			
1			
código	346549	referencia	04200057
descripción	interruptor basculante medida de montaje 19x22mm negro 2NO 250V 10A 0-I empalme conector Faston 4,8mm protección IP40		
Para modelos:	2GR-Compact, Appia-1gr, Appia-2-3gr, Appia-2GR, Appia-2GR-compact, Appia-3GR, Aurelia, Aurelia-2GR, Aurelia-3GR, Aurelia-4GR		

			
1			
código	347275	referencia	04200056
descripción	interruptor basculante medida de montaje 19x22mm negro 1NO/NO 250V 10A 0-I/0-II empalme conector Faston 4,8mm protección IP40		
Para modelos:	Appia-2-3gr, Appia-2GR, Appia-2GR-compact, Appia-3GR, Aurelia, Aurelia-2GR, Aurelia-3GR, Aurelia-4GR		

30x22mm

			
1			
código	301001	referencia	04200011
descripción	interruptor basculante medida de montaje 30x22mm rojo 2NO 250V 16A iluminado 0-I empalme conector Faston 6,3mm temperatura ambiente máx. 125/55°C protección IP65		
Para modelos:	2GR-Compact, Appia-1gr, Appia-2-3gr, Appia-2GR, Appia-2GR-compact, Appia-3GR, Jazz, MAC2000, Microbar, Premier		
accesorios para	301001		
	código	301036	referencia —
	cubierta protectora dimensión interior 30x22mm para interruptor basculante medida de montaje mm		

			
1			
código	301135	referencia	18010786
descripción	pulsador basculante medida de montaje 30x22mm naranja 2NO 24V 16A iluminado empalme conector Faston 6,3mm temperatura ambiente máx. 100/55°C protección IP40		

			
1			
código	301018	referencia	18010589
descripción	pulsador basculante medida de montaje 30x22mm naranja 2NO 250V 16A iluminado 0-I empalme conector Faston 6,3mm temperatura ambiente máx. 125/55°C protección IP65		
accesorios para	301018		
	código	301036	referencia —
	cubierta protectora dimensión interior 30x22mm para interruptor basculante medida de montaje mm		





			
1			
código	301015	referencia	04200027
descripción	interruptor basculante medida de montaje 30x22mm rojo 2CO 250V 16A iluminado empalme conector Faston 6,3mm temperatura ambiente máx. 125/55°C protección IP40		



			
1			
código	301133	referencia	18010058
descripción	pulsador basculante medida de montaje 30x22mm naranja 2NO 250V 16A iluminado regeneración empalme conector Faston 6,3mm temperatura ambiente máx. 85/125°C protección IP40		

			
1			
código	301278	referencia	18010785
descripción	interruptor basculante medida de montaje 30x22mm verde 2CO 24V 6A iluminado empalme conector Faston 6,3mm temperatura ambiente máx. 85°C protección IP40		



			
1			
código	301134	referencia	18010420
descripción	pulsador basculante medida de montaje 30x22mm naranja 2NO 250V 16A iluminado salida empalme conector Faston 6,3mm temperatura ambiente máx. 100/55°C protección IP40		

			
1			
código	301017	referencia	18010053
descripción	interruptor basculante medida de montaje 30x22mm verde 2CO 250V 16A iluminado empalme conector Faston 6,3mm temperatura ambiente máx. 125/55°C protección IP40		
accesorios para	301017		
	código	301036	referencia —
	cubierta protectora dimensión interior 30x22mm para interruptor basculante medida de montaje		

			
1			
código	301132	referencia	18010225
descripción	pulsador basculante medida de montaje 30x22mm verde 2NO 250V 16A iluminado aclarado caliente/frío empalme conector Faston 6,3mm temperatura ambiente máx. 85°C protección IP40		

			
1			
código	301188	referencia	16300122
descripción	interruptor basculante medida de montaje 30x22mm negro 2NO/2NO 250V 16A IO II empalme conector Faston 6,3mm temperatura ambiente máx. 125/55°C protección IP40		
accesorios para	301188		
	código	301036	referencia —
	cubierta protectora dimensión interior 30x22mm para interruptor basculante medida de montaje		

34,2x12,6mm			
			
1			
código	301131	referencia	18010609
descripción	pulsador basculante medida de montaje 34,2x12,6mm naranja 2NO 250V 16A iluminado aclarado caliente/frío empalme conector Faston 6,3mm		

			
1			
código	347465	referencia	18010826
descripción	pulsador basculante medida de montaje 30x22mm naranja 2NO 250V 16A iluminado empalme conector Faston 6,3mm temperatura ambiente máx. 100/55°C protección IP44		
accesorios para	347465		
	código	301036	referencia —
	cubierta protectora dimensión interior 30x22mm para interruptor basculante medida de montaje		

interruptores pulsantes y pulsadores			
27,2x22,2mm			
			
1			
código	345033 ¹	referencia	04200030
descripción	interruptor pulsante medida de montaje 27,2x22,2mm rojo 2NO 250V 16A iluminado empalme conector Faston 6,3mm temperatura ambiente máx. 85°C protección IP40		
Para modelos:	MacDigit, Optima, Premier5, Program		

¹iluminado



			
1			
código	345090 ¹	referencia	04200032
descripción	pulsador medida de montaje 27,2x22,2mm rojo 2NO 250V 16A iluminado empalme conector Faston 6,3mm temperatura ambiente máx. 85°C protección IP40		
Para modelos:	MacDigit		

¹iluminado

ø25mm			
			
1			
código	345162 ¹	referencia	04200039
descripción	interruptor pulsante montaje ø 25mm amarillo 2NO 250V 16A iluminado empalme conector Faston 6,3mm temperatura ambiente máx. 85°C protección IP40		
Para modelos:	Beach		

¹iluminado

			
1			
código	346121	referencia	04200038
descripción	pulsador montaje ø 25mm rojo 2NO 250V 16A iluminado empalme conector Faston 6,3mm temperatura ambiente máx. 85°C protección IP40		

accesorios

teclas

			
1			
código	112017	referencia	05000176
descripción	pulsador montaje ø 19mm eje 3,5x3,5mm gris		
Para modelos:	Oscar		

microinterruptores

accionado por palanca

			
1			
código	346169	referencia	04200043
descripción	microinterruptor con manilla empalme conector Faston		
Para modelos:	Caffetteria-Italiana, Jazz, Master1, Microbar		

			
1 imagen no disponible			
código	346168	referencia	04200042
descripción	microinterruptor con manilla		
Para modelos:	Master1		

			
1			
código	345270	referencia	04200042
descripción	microinterruptor con manilla 250V 16A 1CO empalme conector Faston 6,3mm temperatura ambiente máx. 85°C distancia de sujeción 25mm tipo C99ZP3 fuerza de accionamiento: 30g longitud de palanca 140mm		

accionados por palanca de rodillo

con piezas de montaje

			
1			
código	345370	referencia	16000019
descripción	microinterruptor con palanca de rodillo 250V 16A 1CO empalme conector Faston 6,3mm L 27mm temperatura ambiente máx. 125°C distancia de sujeción 24mm fuerza de accionamiento: 45g longitud de palanca 26.5mm		

accionados por pistón

			
1			
código	345528	referencia	18010145 18010625
descripción	microinterruptor 250V 4A 1CO empalme conector Faston 6,3mm temperatura ambiente máx. 125°C distancia de sujeción 22mm con varilla blanco		
Para modelos:	KIARA6		

M10

			
1			
código	345156	referencia	04200041
descripción	microinterruptor con varilla rosca M10x1 rosca L 13mm 250V 16A 1CO empalme conector Faston 6,3mm carrera 6mm distancia de sujeción 25mm L 46mm L1 13mm temperatura ambiente máx. 85°C tipo C4AZN3 fuerza de accionamiento: 340g		



con tecla

interruptores de enganche rápido



1

código	346772	referencia	15030009
descripción	microinterruptor con tecla 250V 5A 1CO empalme conector Faston 4,8mm L 24x27mm temperatura ambiente máx. 85°C fuerza de accionamiento: 160g		



1

código	346166	referencia	04200063
descripción	microinterruptor medida de montaje 28,5/13,5mm montaje ømm 1NO 250V 4A empalme conector Faston 6,3mm temperatura ambiente máx. 85°C protección IP40 con varilla fuerza de accionamiento: 150g		
Para modelos:	Caffetteria-Italiana, Master1, Microbar		

accesorios



1

código	507041	referencia	18010045
descripción	parte delantera para microinterruptor		
Para modelos:	KIARA6		



1

código	507037	referencia	18010045 18010398
descripción	parte trasera para microinterruptor		

interruptores de sistema ROLD

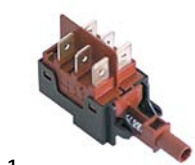

1

código	345651	referencia	18011025
descripción	elemento de conmutación 2CO 250V 16A empalme conector Faston 6,3mm		
Para modelos:	KIARA6MON, KIARA6TRI		



1

código	346165	referencia	04200051
descripción	elemento de conmutación 2NO 250V 16A empalme conector Faston 6,3mm		
Para modelos:	Oscar		



1

código	347466	referencia	40900005
descripción	tecla ø 11.9mm eje ø 3,6x3,6mm oro eje L 9mm		



1

código	345524	referencia	18010953
descripción	tecla ø 23mm rojo CON.-DESC.		



1

código	345650	referencia	18011026
descripción	unidad de pulsador 2CO 250V 16A empalme conector Faston 6,3mm		
Para modelos:	KIARA6MON, KIARA6TRI		

interruptores de flotador



1

código	345371	referencia	16000475
descripción	interruptor de flotador con varilla 250V 16A 1CO conector Faston 6,3mm L 60mm temperatura ambiente máx. 125°C distancia de sujeción 22mm tipo EF83161.5 fuerza de accionamiento: 20g azul/negro		

flotadores



1

código	695044	referencia	16000520
descripción	flotador		



conmutadores giratorios

BREMAS

serie A1700



código	347085	referencia	04200015
descripción	conmutador giratorio 2 0-1 juegos de contactos 2 tipo CA0170002V 400V 20A eje ø 5x5mm eje L 18mm eje cuadrado empalme atornillado		
Para modelos:	Premier, Premier5		



código	346004	referencia	04200015
descripción	conmutador giratorio 20A eje L 23mm 2 posiciones de conmutación 2 polos eje 5x5mm atornillado		

BRETER

conmutadores giratorios



código	346071	referencia	04200023
descripción	conmutador giratorio 2 0-1 juegos de contactos 4 tipo 11284 600V 16A eje cuadrado empalme atornillado		



código	346070	referencia	04200015
descripción	conmutador giratorio empalme borne roscado		

GIOVENZANA

conmutadores giratorios



código	347404	referencia	04200023
descripción	conmutador giratorio 0-1 20A eje ø 5x5mm eje L 23mm ø 44/48mm L 49mm 2 posiciones de conmutación 4 polos ángulo de rotación 60°		
Para modelos:	Athena-Leva, MAC2000, MacDigit, Program		



código	346901	referencia	04200022
descripción	conmutador giratorio 2 0-1 juegos de contactos 4 tipo C052 690V 32A eje ø 5x5mm eje L 25mm eje cuadrado empalme atornillado		
Para modelos:	Athena-Leva, MAC2000, MacDigit, Premier, Premier5, Program		



código	346069	referencia	04200022
descripción	conmutador giratorio 20A 2 posiciones de conmutación 4 polos		

VM



código	346097	referencia	04200020 40402001
descripción	conmutador giratorio 3 0-1-2 juegos de contactos 3 tipo P600184 400V 40A eje ø 5x5mm eje L 23mm eje cuadrado empalme atornillado		
Para modelos:	Athena-Leva, Optima		

interruptores magnéticos

65x20mm

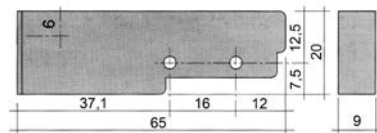
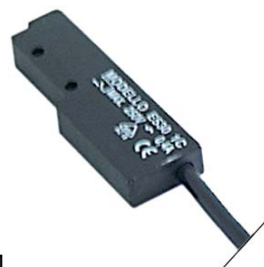

código	345116	referencia	18010706
descripción	interruptor magnético L 65mm An 20mm 1NO 250V 0.4A P máx. 100W empalme cable longitud del cable 3000mm		
accesorios para	345116		
	código	referencia	—
	345399		imán ø 3.3mm L 40mm H 8mm An 13mm dist. del agujero 30mm M3



aparatos de mando y aviso

SIEMENS

serie 3SB ø22mm antiguo

selectores giratorios



código	345526	referencia	18010772 18010777
descripción	selector giratorio medida de montaje ø22mm secuencia de conmutación 0-1 con enclavamiento negro		

serie 3SB ø22mm nuevo



código	346631	referencia	18010778
descripción	bloque de contacto SIEMENS 3SB3400-0C 1NC máx. 400V 10A negro		

lámparas

lámparas de señalización

lámparas de señalización 2 piezas (lente y elemento)

casquillos para lámparas de señalización

ø10mm (tipo SRZ-2)



código	359358	referencia	18010776
descripción	casquillo para lámpara de señalización medida de montaje ø10mm naranja cuadrado		



código	359359	referencia	18010771
descripción	casquillo para lámpara de señalización medida de montaje ø10mm verde cuadrado		

elementos de señalización para casquillo tipo SRZ / SDK / SDY / SFK



código	359129	referencia	18010788
descripción	elemento de señalización 24V claro empalme conector Faston 6,3mm		

lámparas de señalización completas

ø 9mm



código	359421	referencia	04200052
descripción	lámpara de señalización ø 9mm 230V rojo empalme conector Faston 6,3mm		
Para modelos:	Oscar		

27,2x22,2mm



código	359209	referencia	04200031
descripción	lámpara de señalización medida de montaje 27,2x22,2mm 230V rojo empalme conector Faston 6,3mm resis.a la temp. 125°C		
Para modelos:	MacDigit, Program		

30x22mm



código	359155	referencia	04200012
descripción	lámpara de señalización medida de montaje 30x22mm 230V rojo empalme conector Faston 6,3mm resis.a la temp. 125°C tipo RL2		
Para modelos:	Appia-1gr, Appia-2-3gr, Appia-2GR, Appia-3GR, MAC2000		



código	301138	referencia	18010408 18010612
descripción	lámpara de señalización medida de montaje 30x22mm 230V rojo/verde empalme conector Faston 6,3mm resis.a la temp. 125/55°C tipo RL2		



elementos ciegos



1			
código	359776	referencia	18010951
descripción	revestimiento ø 10mm ciclo		



1			
código	359774	referencia	18010949
descripción	revestimiento ø 10mm tanque		



1			
código	359775	referencia	18010950
descripción	revestimiento ø 13mm calentador de agua montaje ø 10mm		

LEDs

elementos de señalización

otros



1			
código	359229	referencia	04500038
descripción	lámpara de señalización LED		

temporizadores

temporizadores de programa



1			
código	360217	referencia	18010714
descripción	temporizador CDC 7807DV motores 2 cámaras 7 tiempo de funcionamiento 6s / 3min aliment. 24V N° fabricante 7807DV tipo de motor M37RN/M37LN		
repuestos para	360217		
	código	360324	referencia —
	motor CDC piñón ø 5.4mm dientes 12 aliment. 24V tensión AC sentido de rotación derecho ø motor 37mm tipo motor M37RN		
	código	360325	referencia —
	motor CDC piñón ø 5.4mm dientes 12 aliment. 24V tensión AC sentido de rotación izquierdo ø motor 37mm tipo motor M37LN		



1			
código	360040	referencia	18000094
descripción	temporizador CDC 9003F motores 1 cámaras 3 tiempo de funcionamiento 6min aliment. 230V eje ø 6x4,6mm eje L 21mm N° fabricante 9003F3 / PRCIH5 tipo de motor M48R ATS		
repuestos para	360040		
	código	360118	referencia —
	motor CDC piñón ø 4.9mm dientes 10 aliment. 230V tensión AC 50/60Hz sentido de rotación derecho ø motor 47mm H 19.3mm tipo motor M48R ATS para temporizador longitud del cable 260mm 1,9/2,5W		
accesorios para	360040		
	código	110197	referencia —
	pomo interruptor marca cero ø 42mm eje ø 6x4,6mm parte plana ajustable negro		

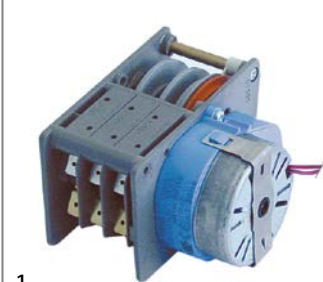

1			
código	360219	referencia	18010591
descripción	temporizador FIBER P25 motores 1 cámaras 3 tiempo de funcionamiento 120s aliment. 230V eje ømm eje Lmm N° fabricante P255J03H3C1 tipo de motor M51BJ0R6400		
repuestos para	360219		
	código	360673	referencia —
	kit de motor piñón ø 6.8mm dientes 15 aliment. 230V tensión AC 50/60Hz sentido de rotación en sentido horario ø motor 48mm H 18.5mm tipo motor UDS40NE1RNZ165 longitud del cable 150mm con soporte		

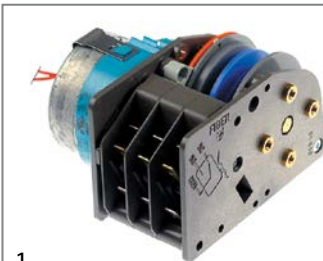

1			
código	360249	referencia	18011030
descripción	temporizador FIBER P25 motores 1 cámaras 3 tiempo de funcionamiento 150s aliment. 230V eje ømm eje Lmm N° fabricante P255J03H4U7 tipo de motor M51BJ0R6400 / 230V		
repuestos para	360249		
	código	360673	referencia —
	kit de motor piñón ø 6.8mm dientes 15 aliment. 230V tensión AC 50/60Hz sentido de rotación en sentido horario ø motor 48mm H 18.5mm tipo motor UDS40NE1RNZ165 longitud del cable 150mm con soporte		

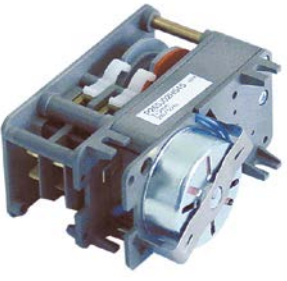
1

código	360228	referencia	18010421
descripción	temporizador FIBER P26 motores 1 cámaras 2 tiempo de funcionamiento 180s aliment. 230V eje ømm eje Lmm N° fabricante P265J02H545 tipo de motor M61B40R6400		
Para modelos:	KIARA6MON, KIARA6TRI		

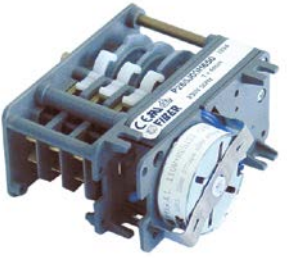

1

código	360222	referencia	18010593
descripción	temporizador FIBER P26 motores 1 cámaras 3 tiempo de funcionamiento 4min aliment. 230V eje ømm eje Lmm N° fabricante P265J03H649 tipo de motor M61B40R6400		
Para modelos:	KIARA6MON, KIARA6TRI		

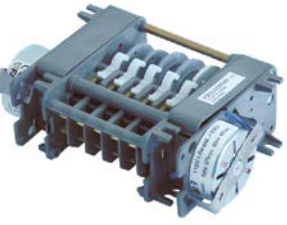

1

código	360218	referencia	18010593
descripción	temporizador FIBER P26 motores 2 cámaras 5 tiempo de funcionamiento 40s/4min aliment. 230V eje ømm eje Lmm N° fabricante P265J05KN48 tipo de motor M61B40R6400 / M61B40L6400		

contactores

ISKRA (FANAL)

contactores de potencia



1

código	380415	referencia	18010823 18011029
descripción	contactor de potencia AC1 16A 230VAC (AC3/400V) 8,5A/5,5kW contactos principales 3NO contactos auxiliares 1NC empalme conector Faston 6,3mm tipo FANAL DSL7 01 tipo ISKRA K07MF 01		
Para modelos:	KIARA6MON, KIARA6TRI		



1

código	380411	referencia	18010705
descripción	contactor de potencia AC1 20A 24VAC (AC3/400V) 8,5A/5,5kW contactos principales 3NO contactos auxiliares 1NC empalme empalme atornillado tipo FANAL DSL7 10 tipo ISKRA K07M 01		

relés

relés de potencia

con lengüeta de sujeción



1

código	380366	referencia	04200046
descripción	relé de potencia 16A 2CO empalme conector Faston lengüeta de sujeción 230V tensión AC		
Para modelos:	Master1		





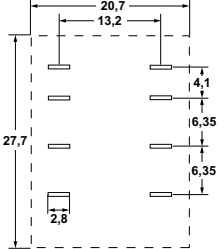

1

código	380365	referencia	04200044
descripción	relé de potencia 230VAC 12A 2CO empalme conector Faston 4,8mm lengüeta de sujeción		
Para modelos:	Master1		
accesorios para	380365		
	código	380476	referencia —
	zócalo de relé medidas 78x27x33,5mm 250V tensión AC 10A FINDER N° fabricante 96.72		

con contactos enchufables
contacto enchufable 2,0mm

1

código	380129	referencia	15010055
descripción	relé de potencia 24VAC 12A 2CO empalme F2 conexión enchufable 94.92.3 250V empalme 2mm		
accesorios para	380129		
	código	380341	referencia —
	zócalo de relé 4 polos contactos 12 300V tensión AC 6A Italiana Relè N° fabricante ZMD4		
	código	380378	referencia —
	zócalo de relé 2 polos 55/85 medidas 70,5x30x27mm 250V tensión AC 10A FINDER N° fabricante 94.72		
	código	380384	referencia —
	zócalo de relé 2 polos contactos conector Faston 2,8mm 250V tensión AC 10A An 23mm para		
	código	380399	referencia —
	zócalo de relé 4 polos medidas 76.2x27x86.1mm 250V tensión AC 1A FINDER N° fabricante 94.94.3		

portarelés



1

código	380137	referencia	09000011
descripción	zócalo de relé 8 polos empalme enchufable redondo 8 polos medidas 65x28x40mm 380V tensión AC 10A Italiana Relè N° fabricante ZVE8		
Para modelos:	Athena-Leva, Beach, Personal		
accesorios para	380137		
	código	380805	referencia —
	estribo de retención		

relés de nivel

GICAR



1

código	400240	referencia	09000015
descripción	relé de nivel 230V tensión AC 50/60Hz 8 polos 5A empalme enchufable redondo 8 polos tipo RL30/1E-2C/8		
Para modelos:	2GR-Compact, Appia-1GR, Appia-2GR, Appia-3GR, Athena-Leva, Beach, MAC2000, MacDigit, Personal, Premier, Premier5, Program		

otros



1

código	400596	referencia	04900195
descripción	relé de nivel 230V tensión AC empalme conector Faston 6,3mm tipo MFC-2SN		





relés de temporización

relés de temporización



1

código	360223	referencia	18010793
descripción	relé de temporización CDC Sc815 margen de tiempo 6s 24VAC/DC 10A 1CO empalme empalme enchufable redondo 8 polos		
accesorios para	360223		
	código	360230	referencia
			—
		zócalo	



1

código	379659	referencia	04900561
descripción	sensor de temperatura NTC cable silicóna sonda -40 a +110°C cable -50 a +180°C empalme conector rosca 1/8" bulbo ø8x50mm longitud de cable 0.4m		
Para modelos:	Jazz, Microbar		



1

código	698662	referencia	04900775 04900775.1
descripción	sensor de temperatura NTC cable silicóna sonda -40 a +150°C cable -40 a +120°C empalme conector rosca 1/8" longitud de cable 0.465m sonda L 20mm		

electrónicas

placas electrónicas



1

código	402401	referencia	04900712
descripción	display L 100mm An 47mm con teclado		
Para modelos:	Aurelia, Aurelia-2GR, Aurelia-3GR, Aurelia-4GR		



1

código	400369	referencia	04900035
descripción	placa de teclado		



1

código	400370	referencia	04900036
descripción	placa de teclado		



1

código	400371	referencia	04900037
descripción	placa de teclado		



1

código	400372	referencia	04900042
descripción	placa de teclado		
Para modelos:	Program		

transformadores

transformadores abiertos

con borne de empalme



1

código	400134	referencia	18010792
descripción	transformador primaria 230/400VAC secundaria 24VAC 100VA secundaria 5A H 95mm L 85mm An 85mm empalme atornillado 50/60Hz tipo USE10BB		

sensores

sensores específicos del fabricante

sensores



1

código	379470	referencia	04900720
descripción	sensor Pt1000 cable silicóna sonda -100 a 450°C cable -50 a +180°C empalme conector rosca bulbo ø3-6x140mm longitud de cable 1m		
Para modelos:	2GR-Compact, Appia-1gr, Appia-2GR-compact, Aurelia, Aurelia-2GR, Aurelia-3GR, Aurelia-4GR		



1

código	379474	referencia	04900154
descripción	sensor de temperatura NTC cable silicóna sonda -40 a +110°C cable -50 a +180°C empalme conector Faston 6,3mm rosca 1/4" bulbo ø8x30mm longitud de cable 0.3m		
Para modelos:	Aurelia, Aurelia-2GR, Aurelia-3GR, Aurelia-4GR, Caffetteria-Italiana		

			
1			
código	400373	referencia	04900044
descripción	placa de teclado		
Para modelos:	Program		

			
1			
código	400374	referencia	04900043
descripción	placa de teclado		
Para modelos:	Program		

			
1			
código	400454	referencia	04900051
descripción	placa de teclado		

			
1			
código	400455	referencia	04900052
descripción	placa de teclado		

			
1			
código	400456	referencia	04900053
descripción	placa de teclado		

			
1			
código	400461	referencia	04900090
descripción	placa de teclado		
Para modelos:	MAC2000, MacDigit, Program		

			
1			
código	400462	referencia	04900081
descripción	placa de teclado		
Para modelos:	MAC2000, MacDigit, Program		

			
1			
código	400552	referencia	04900116
descripción	placa de teclado		
Para modelos:	MacDigit, Program		

 imagen no disponible			
1			
código	400554	referencia	04900067
descripción	placa de teclado		
Para modelos:	MacDigit, Personal, Program		

			
1			
código	400591	referencia	04900120
descripción	placa de teclado		
Para modelos:	Master1		

			
1			
código	400599	referencia	04900153
descripción	placa de teclado con Display		

			
1			
código	402412	referencia	04900707
descripción	placa de teclado L 100mm An 37mm		
Para modelos:	Aurelia, Aurelia-2GR, Aurelia-3GR, Aurelia-4GR		

			
1			
código	402399	referencia	04900742
descripción	placa de teclado L 135mm An 34mm		
Para modelos:	2GR-Compact, Appia-2GR-compact		



			
1			
código	402413	referencia	04900704
descripción	placa de teclado L 135mm An 37mm		
Para modelos:	Aurelia, Aurelia-2GR, Aurelia-3GR, Aurelia-4GR		

			
1			
código	402394	referencia	04900705
descripción	placa de teclado L 136mm An 37mm		
Para modelos:	Aurelia, Aurelia-2GR, Aurelia-3GR, Aurelia-4GR		

			
1			
código	402398	referencia	04900738
descripción	placa de teclado L 160mm An 34mm		
Para modelos:	Appia-2-3gr, Appia-2GR, Appia-3GR		

			
1			
código	402395	referencia	04900706
descripción	placa de teclado L 160mm An 37mm		
Para modelos:	Aurelia, Aurelia-2GR, Aurelia-3GR, Aurelia-4GR		

			
1			
código	402400	referencia	04900744
descripción	placa de teclado L 182mm An 34mm		
Para modelos:	2GR-Compact, Appia-2GR-compact		

			
1			
código	402396	referencia	04900735
descripción	placa de teclado L 210mm An 15mm		
Para modelos:	Appia-1gr		

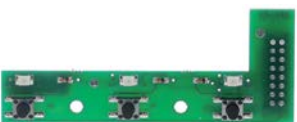
			
1			
código	402397	referencia	04900737
descripción	placa de teclado L 84mm An 33mm		
Para modelos:	Appia-2-3gr, Appia-2GR, Appia-3GR		

			
1			
código	400592	referencia	04900121
descripción	placa de teclado para NUOVA SIMONELLI con Display		
Para modelos:	Master1		

			
1			
código	400466	referencia	04900045
descripción	placa electrónica		
Para modelos:	Program		

			
1			
código	400467	referencia	04900046 04900047
descripción	placa electrónica		
Para modelos:	Program		

			
1			
código	400597	referencia	04900152
descripción	placa electrónica 3/4 grupos para NUOVA SIMONELLI		

			
1			
código	400594	referencia	04900123
descripción	placa electrónica con Display		
Para modelos:	Master1		



1 

código	402410	referencia	04900733
descripción	placa electrónica L 118mm An 132mm aliment. 230V 12V		
Para modelos:	Appia-2-3gr, Appia-3GR		

1 

código	402408	referencia	04900730
descripción	placa electrónica L 122mm An 65mm 12V tipo NEWAPP1A1220V alimentación 230Vc.a.		
Para modelos:	Appia-1gr		

1 

código	402406	referencia	04900717
descripción	placa electrónica L 132mm An 116mm 12V tipo AVR2S220V alimentación 230Vc.a.		
Para modelos:	Aurelia, Aurelia-2GR		

1 

código	402407	referencia	04900718
descripción	placa electrónica L 132mm An 116mm 12V tipo AVR4S220V alimentación 230Vc.a.		
Para modelos:	Aurelia, Aurelia-3GR, Aurelia-4GR		

1 

código	402405	referencia	04900716
descripción	placa electrónica L 132mm An 116mm 12V tipo AVR4V220V alimentación 230Vc.a.		
Para modelos:	Aurelia, Aurelia-2GR, Aurelia-3GR, Aurelia-4GR		

1 

código	402402	referencia	04900713
descripción	placa electrónica L 160mm An 132mm 12V tipo AVR2VIP220V alimentación 230Vc.a.		
Para modelos:	Aurelia-2GR		

1 

código	402404	referencia	04900715
descripción	placa electrónica L 162mm An 74mm 12V tipo ECO2VR220V alimentación 230Vc.a.		
Para modelos:	Aurelia, Aurelia-2GR		

1 

código	403679	referencia	04900732
descripción	placa electrónica máquina de café Appia L 130mm An 115mm		
Para modelos:	Appia-2-3gr, Appia-2GR		



		
1		
código	403624	referencia 04900732
descripción	placa electrónica máquina de café Appia L 162mm An 74mm	

		
1		
código	402409	referencia 04900732 old
descripción	placa electrónica máquina de café Appia L 164mm An 75mm 12V tipo ECO2AAPPIA220V alimentación 230Vc.a.	

		
1		
código	402411	referencia 04900740
descripción	placa electrónica máquina de café Appia L 75mm An 164mm 12V tipo ECO2COMP220V alimentación 230Vc.a.	

		
1		
código	402403	referencia 04900714
descripción	placa electrónica máquina de café Aurelia L 160mm An 132mm 12V tipo AVR4VIP220V alimentación 230Vc.a.	
Para modelos:	Aurelia-2GR, Aurelia-3GR, Aurelia-4GR	

			
1			
código	403762	referencia	04900740
descripción	placa electrónica máquina de café L 122mm An 106mm		
Para modelos:	2GR-Compact, Appia-2GR-compact		

			
1			
código	402877	referencia	04900653
descripción	placa electrónica para máquina de café Microbar L 180mm An 110mm		
Para modelos:	Microbar		

			
1			
código	400459	referencia	04900112
descripción	placa electrónica sistemas de dosificación		
Para modelos:	Premier		

			
1			
código	403253	referencia	15030005
descripción	platina de red molino de café MYTHOS aliment. 115V con carcasa 110V		

unidades centrales

			
1			
código	400476	referencia	04900117
descripción	caja electrónica		



1

código	400363	referencia	04900082
descripción	caja electrónica 2 grupos para máquina de café		
Para modelos:	MAC2000, MacDigit		



1

código	400364	referencia	04900031
descripción	caja electrónica 2 grupos para máquina de café 230V		
Para modelos:	Optima		



1

código	400367	referencia	04900113
descripción	caja electrónica 2 grupos para máquina de café 230V tipo ECO2PREM		
Para modelos:	Premier, Premier5		



1

código	400472	referencia	04900126
descripción	caja electrónica 3 grupos para máquina de café 230V tipo ECO3PREM		
Para modelos:	Premier, Premier5		



1

código	400473	referencia	04900084
descripción	caja electrónica 3-4 grupos		
Para modelos:	MAC2000, MacDigit		



1

código	400471	referencia	04900055 04900055.1
descripción	caja electrónica 4 grupos para máquina de café 230V		



1

código	400572	referencia	04900162
descripción	caja electrónica para máquina de café 230V		
Para modelos:	MAC2000		



1

código	400593	referencia	04900122
descripción	caja electrónica para máquina de café 230V		



electronica de dosificación

GICAR



1

código	402393	referencia	04900195
descripción	electronica de dosificación 2 grupos 230V 50/60Hz tipo RL30/2S/3R		
Para modelos:	Oscar		



1

código	400590	referencia	05000134.0
descripción	membrana de teclado		
Para modelos:	Master1		



1

código	400458	referencia	78016004
descripción	membrana de teclado 3 grupos		
Para modelos:	Premier5		

teclados

membranas de teclado



1

código	400587	referencia	05000131.0
descripción	membrana de teclado		



1

código	400588	referencia	05000132.0
descripción	membrana de teclado		
Para modelos:	Master1		



1

código	400589	referencia	05000133.0
descripción	membrana de teclado		

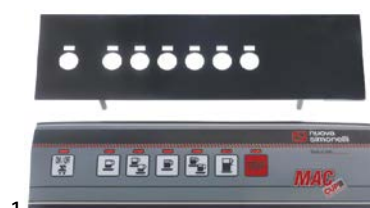

1

código	402591	referencia	79016082
descripción	membrana de teclado con panel de manejo L 310mm An 88mm tazas 7		

teclados de membrana



1

código	401896	referencia	04900668.1
descripción	teclado de membrana tazas 8 apto para NUOVA SIMONELLI L 145mm An 69mm		
Para modelos:	Microbar		

unidades de teclado



1

código	400463	referencia	04900033 04900034
descripción	unidad de teclado		
Para modelos:	Beach, Optima		



paneles de mando



1

código	525009	referencia	78016020
descripción	panel de mando L 594mm gris H 75mm 2 grupos		
Para modelos:	Premier		



1

código	525016	referencia	78016021
descripción	panel de mando L 594mm gris H 75mm 2 grupos		
Para modelos:	Premier		



1

código	525014	referencia	78016030
descripción	panel de mando L 824mm gris H 75mm 3 grupos		
Para modelos:	Premier		



1

código	525015	referencia	78016031
descripción	panel de mando L 824mm gris H 75mm 3 grupos		
Para modelos:	Premier		



1

código	502253	referencia	18010846
descripción	panel de mando sistemas de lavado L 310mm An 133mm H 7mm negro		

accesorios



1

código	112612	referencia	04900707.S
descripción	barra de teclas tazas 1 L 32mm An 37mm		
Para modelos:	Aurelia-2GR, Aurelia-3GR, Aurelia-4GR		



1

código	112609	referencia	04900704.S
descripción	barra de teclas tazas 4 L 114mm An 37mm		
Para modelos:	Aurelia-2GR, Aurelia-3GR, Aurelia-4GR		



1

código	112610	referencia	04900705.S
descripción	barra de teclas tazas 4 L 114mm An 37mm		
Para modelos:	Aurelia-2GR, Aurelia-3GR, Aurelia-4GR		



1

código	112607	referencia	04900702
descripción	barra de teclas tazas 4 L 70mm An 10mm		
Para modelos:	Aurelia, Aurelia-2GR, Aurelia-3GR, Aurelia-4GR		



1

código	112608	referencia	04900703
descripción	barra de teclas tazas 4 L 70mm An 10mm		
Para modelos:	Aurelia, Aurelia-2GR, Aurelia-3GR, Aurelia-4GR		



1

código	112611	referencia	04900706.S
descripción	barra de teclas tazas 5 L 132mm An 37mm		
Para modelos:	Aurelia-2GR, Aurelia-3GR, Aurelia-4GR		

válvulas magnéticas

válvulas magnéticas agua

RPE

válvulas magnéticas con reducciones

triple



1

código	370240	referencia	18010079
descripción	válvula magnética triple recto 230VAC entrada 3/4" salida 11,5mm T máx 90°C RPE plástico reducción salida B 0,32-0,42l/min reducción salida B verde		
Para modelos:	KIARA6		



TP



1

código	370021	referencia	18010078
---------------	--------	-------------------	----------

descripción	válvula magnética doble recto 230VAC entrada 3/4" salida 11,5mm DN10 TP reducción entrada A blanco		
--------------------	--	--	--

Para modelos:	KIARA6
----------------------	--------

repuestos para	370021
-----------------------	--------



código	371013	referencia	—
---------------	--------	-------------------	---

descripción	bobina magnética TP 230VAC 50/60Hz		
--------------------	------------------------------------	--	--

accesorios para	370021
------------------------	--------



código	371220	referencia	—
---------------	--------	-------------------	---

descripción	reducción TP velocidad de flujo 3l/min rojo tolerancia ±15%		
--------------------	---	--	--



código	371221	referencia	—
---------------	--------	-------------------	---

descripción	reducción TP velocidad de flujo 5.5l/min amarillo tolerancia ±15%		
--------------------	---	--	--



código	371222	referencia	—
---------------	--------	-------------------	---

descripción	reducción TP velocidad de flujo 6l/min gris tolerancia ±15%		
--------------------	---	--	--



código	371223	referencia	—
---------------	--------	-------------------	---

descripción	reducción TP velocidad de flujo 10l/min blanco tolerancia ±15%		
--------------------	--	--	--



código	371224	referencia	—
---------------	--------	-------------------	---

descripción	reducción TP velocidad de flujo 12l/min bronce tolerancia ±15%		
--------------------	--	--	--



código	371225	referencia	—
---------------	--------	-------------------	---

descripción	reducción TP velocidad de flujo 16l/min marrón claro tolerancia ±15%		
--------------------	--	--	--



código	371226	referencia	—
---------------	--------	-------------------	---

descripción	reducción TP velocidad de flujo 20l/min rojo tolerancia ±15%		
--------------------	--	--	--



código	371230	referencia	—
---------------	--------	-------------------	---

descripción	reducción TP velocidad de flujo 0.25l/min rojo tolerancia ±25%		
--------------------	--	--	--



código	371231	referencia	—
---------------	--------	-------------------	---

descripción	reducción TP velocidad de flujo 0.35l/min violeta tolerancia ±25%		
--------------------	---	--	--



código	371232	referencia	—
---------------	--------	-------------------	---

descripción	reducción TP velocidad de flujo 0.5l/min naranja tolerancia ±25%		
--------------------	--	--	--



código	371233	referencia	—
---------------	--------	-------------------	---

descripción	reducción TP velocidad de flujo 0.8l/min blanco tolerancia ±25%		
--------------------	---	--	--



código	371234	referencia	—
---------------	--------	-------------------	---

descripción	reducción TP velocidad de flujo 1l/min azul claro tolerancia ±25%		
--------------------	---	--	--



código	371235	referencia	—
---------------	--------	-------------------	---

descripción	reducción TP velocidad de flujo 1.2l/min marrón tolerancia ±25%		
--------------------	---	--	--



código	371236	referencia	—
---------------	--------	-------------------	---

descripción	reducción TP velocidad de flujo 1.5l/min marrón claro tolerancia ±25%		
--------------------	---	--	--

accesorios para	370021
------------------------	--------



código	371237	referencia	—
---------------	--------	-------------------	---

descripción	reducción TP velocidad de flujo 2.5l/min amarillo tolerancia ±25%		
--------------------	---	--	--



código	371238	referencia	—
---------------	--------	-------------------	---

descripción	reducción TP velocidad de flujo 3.4l/min verde oscuro tolerancia ±25%		
--------------------	---	--	--



código	371239	referencia	—
---------------	--------	-------------------	---

descripción	reducción TP velocidad de flujo 5l/min negro tolerancia ±25%		
--------------------	--	--	--



código	371240	referencia	—
---------------	--------	-------------------	---

descripción	reducción TP velocidad de flujo 8l/min azul tolerancia ±20%		
--------------------	---	--	--

válvulas magnéticas con reducciones



1

código	370245	referencia	18010751
---------------	--------	-------------------	----------

descripción	válvula magnética simple recto 24VAC entrada 3/4" salida 11,5mm reducción entrada A 16l/min T máx 90°C TP plástico reducción entrada A marrón claro		
--------------------	---	--	--

metal

ASCO

recambios y accesorios

juntas tóricas



1

código	371095	referencia	02290016
---------------	--------	-------------------	----------

descripción	junta tórica Viton espesor 1.78mm int.ø 6.07mm UE 1 pzs		
--------------------	---	--	--

Para modelos:	2GR-Compact, Appia-1gr, Appia-2-3gr, Appia-2GR, Appia-2GR-compact, Appia-3GR, Aurelia, Aurelia-2GR, Aurelia-3GR, Aurelia-4GR, Beach, Caffetteria-Italiana, MAC2000, MacDigit, Master1, Optima, Oscar, Personal, Premier, Premier5, Program		
----------------------	--	--	--



CEME

válvulas magnéticas



1

código	370632	referencia	04100067
descripción	válvula magnética latón 3vías 230VAC empalme 1/8" L 28mm CEME serie 53 p máx. 12bar p mín. 0.1bar		



1

código	370238	referencia	04100038
descripción	válvula magnética latón 3vías aparatos de café		
Para modelos:	Oscar		

LUCIFER

recambios y accesorios

cuerpos de válvula



1

código	370061	referencia	NS0401
descripción	cuerpo de válvula magnética LUCIFER-PARKER 3vías cono exterior		

ODE

2 vías



1

código	370235	referencia	04100012 04100022 (old version)
descripción	válvula magnética 2vías 220/230 entrada 1/4" salida 1/4" empalme 1/4" L 40mm DN 2.5mm conector hembra DIN -20° a 130°C serie 21A2K0R25-XC membrana FKM (agua) p máx. 30bar p mín. 0bar 50/60Hz latón		
Para modelos:	2GR-Compact, Appia-1gr, Appia-2-3gr, Appia-2GR, Appia-2GR-compact, Appia-3GR, Athena-Leva, Aurelia, Aurelia-2GR, Aurelia-3GR, Aurelia-4GR, Beach, Caffetteria-Italiana, MAC2000, MacDigit, Master1, Optima, Personal, Premier, Premier5, Program		

3 vías



1

código	370862	referencia	04100011
descripción	válvula magnética 3vías 230VAC empalme 1/8" DN 1.2mm conector hembra DIN -20° a 130°C ODE serie 31A3AV15		
Para modelos:	Caffetteria-Italiana, Master1		



1

código	370839	referencia	04100054
descripción	válvula magnética latón 3vías 230VAC empalme 1/8" L 30mm DN 2.3mm ODE serie 31JN1XPV23 p máx. 5bar p mín. 0.1bar		
Para modelos:	Microbar		



1

código	370838	referencia	04100046
descripción	válvula magnética latón 3vías 230VAC empalme 1/8" L 30mm ODE serie 31JN1XPV12 p máx. 15bar p mín. 0.1bar		
Para modelos:	Jazz, Microbar		

válvulas magnéticas vapor (agua)

serie 21J



1



código	370232	referencia	04100042
descripción	válvula magnética latón 2vías 230VAC empalme 1/8" L 30mm DN 2.3mm -10 a 140°C membrana FKM p máx. 18bar		
Para modelos:	Caffetteria-Italiana, Jazz, Master1, Microbar		



serie 31A



1

código	370237	referencia	04100009	
descripción	válvula magnética 3vías 230VAC entrada 1/8" salida 1/8" empalme 1/8" DN 2.5mm conector hembra DIN -10 a 140°C ODE serie 31A tipo de bobina BDA membrana FKM (agua/vapor) p máx. 6bar p mín. 0.1bar			
Para modelos:	Master1			
repuestos para	370237			
	código	371150	referencia	—
	bobina magnética ODE 230VAC 16VA tipo de bobina BDV soporte ø 13.5mm 7500hm			
accesorios para	370237			
	código	371090	referencia	—
	enchufe tipo de conector DIN 43650A atornillado			

serie 4144XPV



1

código	370233	referencia	04100008 04100045 04100066
descripción	válvula magnética 2vías 230VAC empalme 1/8" DN 1.7mm -10 a 140°C membrana FKM (agua/vapor) p máx. 15bar p mín. 0bar latón		
Para modelos:	2GR-Compact, Appia-1gr, Appia-2GR-compact, Aurelia-2GR, Aurelia-3GR, Aurelia-4GR, Master1		

PARKER

2 vías

serie VE-140



1





código	370821	referencia	04100022	
descripción	válvula magnética 2vías 208-240 entrada 1/4" salida 1/4" empalme 1/4" L 40mm DN 3mm conector hembra DIN -10 a 140°C serie VE-140 tipo de bobina ZB09 membrana rubí p máx. 8bar latón			
Para modelos:	Aurelia-2GR, Aurelia-3GR, Aurelia-4GR, Caffetteria-Italiana			
repuestos para	370821			
	código	371029	referencia	—
	bobina magnética PARKER 230VAC 9VA tipo de bobina ZB09 soporte ø 14mm H 33mm An 34mm P 43mm			

3 vías

serie VE-128



1

código	370057	referencia	04100017	
descripción	válvula magnética 3vías 230VAC cuerpo cono exterior DN 1.2mm conector hembra DIN -20° a 140°C PARKER serie VE-128 tipo de bobina ZB09 membrana rubí p máx. 10bar latón brida 32x32mm			
Para modelos:	Appia-1gr, Appia-2-3gr, Appia-2GR, Appia-2GR-compact, Appia-3GR, Aurelia, Aurelia-2GR, Aurelia-3GR, Aurelia-4GR, Beach, MAC2000, MacDigit, Optima, Personal, Premier, Premier5, Program			
repuestos para	370057			
	código	370062	referencia	—
	cuerpo de válvula magnética PARKER 3vías cono exterior			
	código	371029	referencia	—
	bobina magnética PARKER 230VAC 9VA tipo de bobina ZB09 soporte ø 14mm H 33mm An 34mm P 43mm			
accesorios para	370057			
	código	371090	referencia	—
	enchufe tipo de conector DIN 43650A atornillado			
	código	371095	referencia	02290016
	junta tórica Viton espesor 1.78mm int.ø 6.07mm UE 1 pzs			
	código	371100	referencia	—
	junta tórica silicona espesor 1.78mm int.ø 6.07mm UE 1 pzs			

serie VE-141



1

código	374076	referencia	04100063
descripción	válvula magnética 230VAC entrada 1/4" salida 1/4" empalme 1/4" L 40mm DN 2.5mm T máx 140°C conector hembra DIN -20° a 130°C tipo de bobina ZB09 membrana FKM (agua) p máx. 0bar p mín. 7bar 50Hz		

diversas válvulas magnéticas



1

código	370634	referencia	04100005
descripción	válvula magnética 2vías 230VAC entrada 1/4" salida 1/4" L 35mm CEME serie 66 p máx. 4.5bar 50/60Hz latón		
Para modelos:	Appia-2GR-compact, Oscar		



1

código	370236	referencia	04100024
descripción	válvula magnética 2vías 230VAC entrada 1/4" salida 1/4" regulable		
Para modelos:	2GR-Compact, Appia-1gr, Appia-2-3gr, Appia-2GR, Appia-2GR-compact, Appia-3GR, Aurelia, Aurelia-2GR, Aurelia-3GR, Aurelia-4GR, Caffetteria-Italiana, Master1		
accesorios para	370236		
	código	696700	referencia
			04100024.P
	manilla ø 25mm agujero ø 5,3x6mm L 7.5mm		

Válvulas magnéticas - accesorios



1

código	371095	referencia	02290016
descripción	junta tórica Viton espesor 1.78mm int.ø 6.07mm UE 1 pzs		
Para modelos:	2GR-Compact, Appia-1gr, Appia-2-3gr, Appia-2GR, Appia-2GR-compact, Appia-3GR, Aurelia, Aurelia-2GR, Aurelia-3GR, Aurelia-4GR, Beach, Caffetteria-Italiana, MAC2000, MacDigit, Master1, Optima, Oscar, Personal, Premier, Premier5, Program		



1

código	528952	referencia	06200036 98021000
descripción	placa de montaje para válvula magnética		
Para modelos:	Beach, MAC2000, MacDigit, Optima, Program		
accesorios para	528952		
	código	528954	referencia
			07300022
	boquilla agujero ø 0.8mm rosca M6 rosca L 6mm latón		

presostatos

para sistemas de lavado

ø51mm con conector codificado



1

código	541784	referencia	18010169
descripción	presostato margen de presión 50/20mbar ø 51mm conexión de presión horizontal sistemas de lavado empalme presión ø 5.5mm a 250 V 10A		
Para modelos:	KIARA6MON, KIARA6TRI		



1

código	541875	referencia	18010442
descripción	presostato margen de presión 90/30mbar empalme conector codificado ø 51mm empalme presión ø 6mm a 250 V 10A		

ø58mm con conector Faston 6,3mm

con empalme horizontal



1

código	541010	referencia	18000041
descripción	presostato margen de presión 50/30mbar empalme 6mm ø 58mm conexión de presión horizontal sistemas de lavado		



1

código	541165	referencia	18010422
descripción	presostato margen de presión 60/30mbar empalme 6mm ø 58mm conexión de presión horizontal sistemas de lavado empalme presión ø 6mm		
Para modelos:	KIARA6MON, KIARA6TRI		

para aparatos de café

ø35mm



código	541131	referencia	09200014old
descripción	presostato ø 35mm margen de presión ajustable 0,2-0,9bar conexión de presión vertical aparatos de café empalme 1 polo empalme de presión 1/4"		

otros



código	541477	referencia	09200014
descripción	presostato margen de presión 0.6bar empalme 1/4" 16A 1 polos tipo aparatos de café		
Para modelos:	Oscar		



código	541021	referencia	09200006 NS1201
descripción	presostato margen de presión ajustable 0,5-1,4bar empalme 1/4" 30A 3 polos tipo P302 aparatos de café SIRAI		
Para modelos:	Appia-1gr, Appia-2-3gr, Appia-2GR, Appia-3GR, Athena-Leva, Aurelia-2GR, Aurelia-3GR, Aurelia-4GR, Beach, Caffetteria-Italiana, MAC2000, MacDigit, Master1, Optima, Oscar, Personal, Premier, Premier5, Program		

accesorios para 541021



código	550262	referencia	—
descripción	junta plana cobre ø ext. 20mm int.ø 14mm espesor 2mm		



código	890100	referencia	—
descripción	cinta de PTFE rail L 12m An 12mm -200 a +260°C homologación DIN-DVGW, KTW termorresistente, elástico para rosca fina espesor 0.1mm		

electródos



código	400020	referencia	09000005
descripción	electrodo de nivel 1/4" longitud total 150mm sonda L 124mm largo del bulbo asilado 26mm empalme conector Faston 6,3mm acero inoxidable ø 2.5mm		



código	400595	referencia	73003011
descripción	electrodo de nivel 1/4" longitud total 72mm sonda L 42mm largo del bulbo asilado 26mm empalme conector Faston 6,3mm latón ø 2.5mm		
Para modelos:	Oscar		



código	698661	referencia	09000007
descripción	electrodo de nivel roscada longitud total 88mm sonda L 34mm ø 2.5mm rosca M10x1 G2: 1/4"		

flujómetros y sensores de caudal

flujómetros

GICAR



código	400004	referencia	04900027
descripción	flujómetro rosca 1/4" acero inoxidable con LED conexión enchufable homologación NSF		
Para modelos:	2GR-Compact, Appia-1gr, Appia-2-3gr, Appia-2GR, Appia-2GR-compact, Appia-3GR, Aurelia, Aurelia-2GR, Aurelia-3GR, Aurelia-4GR, MAC2000, MacDigit, Master1, Microbar, Optima, Personal, Premier, Premier5, Program		

accesorios para 400004

código	400256	referencia	—
descripción	conector GICAR para flujómetro		

motores

motorreductores

para máquina de hielo en cubitos

para paleta



1

código	500407	referencia	16000018
descripción	motorreductor LIP tipo 123MR 8W 220/240V tensión AC 50/60Hz 50rev/min sentido de rotación en sentido anti-horario eje ø 4mm soporte de eje ø 6.2mm ancho de ranura 2.3mm eje L 8mm árbol ø 4mm An 74mm		

para expendedoras de bebidas



1

código	500909	referencia	16300028 16300077
descripción	motorreductor KENTA tipo CD79F 60/68W 115/230V 50/60Hz 33/40rev/min árbol ø 6x12mm L 220mm An 70mm H 105mm para expendedora de bebidas		

para máquinas de café automáticas



1

código	500316	referencia	04600001
descripción	motorreductor LIP tipo 066C 73W 220/240V tensión AC 50/60Hz 12rev/min L 110mm An 70mm H 85mm para máquina de café		
Para modelos:	Caffetteria-Italiana, Master1		

motores

para molinos de café

completo



1

código	500315	referencia	04500031
descripción	motor 250W 230V 50Hz fases 1 árbol ø 12mm longitud árbol 36mm rosca M10L 1360rev/min tipo D001302 ø 120mm H 190mm condensador 10µF RPM 0.25kW		

bombas

bombas de lavado y aclarado

ALBA (C&A)

bombas



1

código	500941	referencia	18010101 18010843
descripción	bomba entrada ø 30mm salida ø 30mm tipo IM32591 230V 50Hz fases 1 0.45kW 0.6PS L 200mm dirección de rodadura derecho condensador 12.5µF presión secundaria 11mm presión secundaria abierto ALBA PUMPS (C&A)		
repuestos para	500941		
	código	referencia	18010104
	condensador de servicio capacidad 12.5µF 450V tolerancia 5%Hz temperatura ambiente máx. -25 a + 85°C ø 35mm L 70mm M8 plástico empalme conector Faston 6,3mm 45S.C3DS.12,5 protección		
	código	referencia	—
	junta tórica EPDM espesor 3.53mm int.ø 107.5mm UE 1 pzs		
	código	referencia	18010061
	sello mecánico para árbol ø 11mm anillo deslizante ø ext. 24mm anillo deslizante H 13mm contraarandela montaje ø 26mm altura contraarandela 8mm contraarandela ø int. 14mm		



1	código	500940	referencia	18010835
	descripción	bomba entrada ø 45mm salida ø 40mm tipo C2031 230V 50Hz fases 1 0.75kW 1PS L 200mm dirección de rodadura derecho empalme conexión enchufable condensador 12.5µF presión secundaria 10mm presión secundaria abierto ALBA PUMPS (C&A)		
	Para modelos:	KIARA6		
	repuestos para	500940		
		código	365014	referencia 18010104
		condensador de servicio capacidad 12.5µF 450V tolerancia 5%Hz temperatura ambiente máx. -25 a + 85°C ø 35mm L 70mm M8 plástico empalme conector Faston 6,3mm 45S.C3DS.12,5 protección		
		código	509021	referencia —
		rotor ø 102mm H 32mm soporte de eje ø 9/8mm dirección de rodadura derecho		
		código	510693	referencia —
		sello mecánico para árbol ø 12mm anillo deslizante ø ext. 24mm anillo deslizante H 15.5mm anillo deslizante ø int. 11mm contraarandela montaje ø 24mm altura contraarandela 8mm contraarandela ø int. 13.5mm		
		código	521531	referencia —
		cubierta de bomba ALBA PUMPS (C&A) entrada ø 45mm salida ø 40mm sentido de rotación derecho ø 153mm int.ø 127mm altura interior 24mm		
		código	521709	referencia —
		junta tórica EPDM espesor 3mm int.ø 126mm UE 1 pzs		

bombas de salida

ASKOLL

1			
código	500347	referencia	18010653
descripción	bomba de desagüe 230V 34W		
Para modelos:	KIARA6		

PLASET



1	código	500514	referencia	18010378
	descripción	bomba de desagüe entrada ø 30mm salida ø 22mm 230V 34W		

bombas de aumento de presión II

motores de bomba

clips conexión



1	código	500317	referencia	04500033
	descripción	motor de boma RPM tipo C004320 120W 230V 50/60Hz empalme abrazadera condensador 6µF		
	Para modelos:	2GR-Compact, Appia-1gr, Appia-2-3gr, Appia-2GR, Appia-2GR-compact, Caffetteria-Italiana, MAC2000, Master1, Premier		

cabezas de bomba

FLUID-O-TECH



1	código	500318	referencia	01300004
	descripción	bomba		
	Para modelos:	2GR-Compact, Appia-1gr, Appia-2GR-compact, Caffetteria-Italiana, Master1		





1	código	499153	referencia	01300004
	descripción	cabezal de bomba CB054 FLUID-O-TECH L 62mm 50l/h empalme 3/8" GAS con modulador latón empalme de abrazadera para máquina de café eje ø 5x11mm NSF		



			
1			
código	500174	referencia	01300005
descripción	cabezal de bomba PA104 FLUID-O-TECH L 82mm 100l/h empalme 3/8" GAS con bypass latón empalme de abrazadera para máquina de café eje ø 4,8x11mm NSF		
Para modelos:	Appia-2-3gr, Appia-2GR, Appia-3GR, Aurelia, Aurelia-2GR, Aurelia-3GR, Aurelia-4GR, Beach, MAC2000, MacDigit, Optima, Premier, Premier5, Program		
accesorios para	500174		
		código	520126 referencia —
	abrazadera para motor/bomba		

			
1			
código	500211	referencia	01300004
descripción	cabezal de bomba PO054 FLUID-O-TECH L 82mm 50l/h empalme 3/8" GAS con bypass latón empalme de abrazadera para máquina de café eje ø 11mm		

			
1			
código	500064	referencia	01300006
descripción	cabezal de bomba PO204 FLUID-O-TECH L 82mm 200l/h empalme 3/8" GAS con bypass latón empalme de abrazadera para máquina de café eje ø 4,8x11mm		
Para modelos:	Appia-2-3gr, Appia-3GR, Aurelia, Aurelia-2GR, Aurelia-3GR, Aurelia-4GR, MAC2000, Premier		
accesorios para	500064		
		código	520126 referencia —
	abrazadera para motor/bomba		



accesorios

			
1			
código	365015	referencia	04000043 15050009
descripción	condensador de servicio capacidad 10µF 400V tolerancia 5%Hz temperatura ambiente máx. -25 a + 85°C ø 35,5mm L 59mm M8 plástico empalme conector Faston 6,3mm protección		
Para modelos:	Appia-3GR, Aurelia-2GR, Aurelia-3GR, Aurelia-4GR, MAC2000		

			
1			
código	365012	referencia	04000010
descripción	condensador de servicio capacidad 6.3µF 450V tolerancia 5% 50Hz temperatura ambiente máx. -25 a + 85°C ø 30mm L 61mm M8 plástico empalme conector Faston 6,3mm protección		
Para modelos:	Caffetteria-Italiana, Master1		

bombas de vibración

			
1			
código	500319	referencia	04800005
descripción	bomba magnética 230V 53W 50Hz entrada ø 7 salida ø 1/8" F CEME tipo ET500 L 123mm latón		
Para modelos:	Jazz, Microbar, Oscar		

			
1			
código	500124	referencia	04800005
descripción	bomba magnética tipo EX5 230V 48W 50/60Hz entrada ø 6 salida ø 1/8" F cierre plana ULKA latón L 123mm		
accesorios para	500124		
		código	520152 referencia —
	empalme de tubo Santoprene boquilla ø 7mm longitud boquilla 14mm		

Continúa en la página siguiente



accesorios para	500124			
	código	520330	referencia	—
	soporte goma medidas 69x44x4mm			

condensadores y filtros antiparasitarios

condensadores de servicio

plástico



1

código	365015	referencia	04000043 15050009
descripción	condensador de servicio capacidad 10µF 400V tolerancia 5%Hz temperatura ambiente máx. -25 a + 85°C ø 35.5mm L 59mm M8 plástico empalme conector Faston 6,3mm protección		
Para modelos:	Appia-3GR, Aurelia-2GR, Aurelia-3GR, Aurelia-4GR, MAC2000		



1

código	365014	referencia	18010104
descripción	condensador de servicio capacidad 12.5µF 450V tolerancia 5%Hz temperatura ambiente máx. -25 a + 85°C ø 35mm L 70mm M8 plástico empalme conector Faston 6,3mm 45S.C3DS.12,5 protección		
Para modelos:	KIARA6MON, KIARA6TRI		



1

código	365012	referencia	04000010
descripción	condensador de servicio capacidad 6.3µF 450V tolerancia 5% 50Hz temperatura ambiente máx. -25 a + 85°C ø 30mm L 61mm M8 plástico empalme conector Faston 6,3mm protección		
Para modelos:	Caffetteria-Italiana, Master1		

filtros

filtros antiparasitarios



1

código	365046	referencia	18010415
descripción	filtro antiparasitario tipo 10S7E-G1474253105-Q 115/250V 50/60Hz conductor 2 con T empalme conector Faston 6,3mm L 40mm ø 40mm Hmm Anmm M8 plástico UE 1 pzs		
Para modelos:	KIARA6MON, KIARA6TRI		

fusibles

fusibles finos



1

código	358022	referencia	16300112
descripción	fusible fino medida ø10x38mm 4A nominal 500V tipo Gg rápido UE 1 pzs		

fusibles térmicos



1

código	358012	referencia	09500014
descripción	fusible térmico temp. desconexión 167°C nominalA longitud del cable 160mm		
Para modelos:	Appia-2GR-compact, Oscar		

accesorios eléctricos

conectores - acoplamientos - enchufes

diversos



1

código	550999	referencia	04000035
descripción	conector máx. 30A máx. 250V 2 polos		
Para modelos:	Appia-2GR, Appia-3GR, Aurelia-2GR, Aurelia-3GR, Aurelia-4GR		



cables

cables de PVC

1



código	550223	referencia	04000090 04000540
descripción	cable de PVC 5 polos 2.5mm ² L 3000mm blanco conductor cable de cobre aislam. PVC temperatura constante 70°C t máx 70°C nominal 300/500V tensión de prueba 2000V		
Para modelos:	Appia-2GR, Appia-3GR, Aurelia-2GR, Aurelia-3GR, Aurelia-4GR, MAC2000		

terminales

regletas de bornes a tornillo/con contactos de enchufe

1



código	550278	referencia	04000310
descripción	borne de conexión 3 polos máx. 40A máx. 400V empalme ø6mm ² / F6,3 resis.a la temp. 150°C sección nominal 6mm ²		

1



código	550411	referencia	18010390
descripción	borne de conexión 6 polos máx. 40A máx. 450V empalme ø6mm ² / F6,3 resis.a la temp. 150°C sección nominal 6mm ²		
Para modelos:	KIARA6MON, KIARA6TRI		

electroimanes

1



código	370631	referencia	04100052
descripción	electroimán 230V tensión AC 50Hz L 23mm An 19mm H 29mm		
Para modelos:	Microbar		

componentes específicos

para máquina de hielo en cubitos

conductos hielo

mallas antideslizantes

1



código	692097	referencia	16000515
descripción	malla antideslizante para máquina de hielo en cubitos L 160mm An 170mm H 60mm		

parte mecánica para cubetas

cubetas

1



código	695359	referencia	16000440
descripción	cubeta para máquina de hielo L 180mm An 180mm H 60mm EUROFRIGOR		

portafiltro

portafiltros standard

portafiltro sin salida

1



código	525992	referencia	N/A
descripción	portafiltro apto para NUOVA SIMONELLI sin salida sujeción ø 82mm caño 3/8" int.ø 61mm altura caña 11mm posición de cañas diagonal cantidad de cañas 2 palanca recto latón cromado		

portafiltros cortos



código	527132	referencia	49800002
descripción	portafiltro sujeción ø 80mm agujero ø 8mm int.ø 62mm		



código	529071	referencia	98005001
descripción	portafiltro sujeción ø 82mm caño 3/8" int.ø 61mm manilla M10x1,5 altura cuña 11mm posición de cuñas diagonal cantidad de cuñas 2 palanca recto latón cromado		
Para modelos:	MAC2000, MacDigit, Optima, Oscar, Premier, Premier5, Program		



código	526799	referencia	06200086
descripción	portafiltro sujeción ø 82mm caño 3/8" int.ø 61mm manilla M10x1,5 altura cuña 7mm posición de cuñas diagonal cantidad de cuñas 2 palanca inclinada latón cromado		
Para modelos:	2GR-Compact, Appia-1gr, Appia-2-3gr, Appia-2GR, Appia-2GR-compact, Appia-3GR, Aurelia-2GR, Aurelia-3GR, Aurelia-4GR, Oscar		

manillas

con rosca exterior



código	111053	referencia	N/A
descripción	manilla ø 36mm rosca M10x1,5 rosca L 15mm L 126mm negro		

con taladro



código	525036	referencia	05000840
descripción	manilla ø 33mm L 117mm negro tamaño orificio 12.5mm		
Para modelos:	2GR-Compact, Appia-1gr, Appia-2-3gr, Appia-2GR, Appia-2GR-compact, Appia-3GR, Aurelia, Aurelia-2GR, Aurelia-3GR, Aurelia-4GR, Oscar		



código	527133	referencia	05080014
descripción	manilla ø 34mm tamaño orificio hexagonal 20mm L 102mm negro		
Para modelos:	MAC2000, Oscar, Premier, Premier5		

tapas terminales



código	525037	referencia	05000842
descripción	tapa terminal ø 38mm negro		
Para modelos:	2GR-Compact, Appia-1gr, Appia-2-3gr, Appia-2GR, Appia-2GR-compact, Appia-3GR, Aurelia, Aurelia-2GR, Aurelia-3GR, Aurelia-4GR, Oscar		

casquillos



código	525038	referencia	05000844
descripción	casquillo ø 38mm L 31mm negro		
Para modelos:	2GR-Compact, Appia-1gr, Appia-2-3gr, Appia-2GR, Appia-2GR-compact, Appia-3GR, Aurelia, Aurelia-2GR, Aurelia-3GR, Aurelia-4GR		

tornillos



código	525029	referencia	07300601
descripción	perno roscado rosca M10 L 85mm rosca L 12mm EC 13 inox		
Para modelos:	2GR-Compact, Appia-1gr, Appia-2-3gr, Appia-2GR, Appia-2GR-compact, Appia-3GR, Aurelia, Aurelia-2GR, Aurelia-3GR, Aurelia-4GR		

caños

con rosca 3/8"



código	529007	referencia	06200008
descripción	salida de portafiltro rosca 3/8" 2 vías curvado/corto distancia de la boca de salida 45mm		
Para modelos:	2GR-Compact, Appia-1gr, Appia-2-3gr, Appia-2GR, Appia-2GR-compact, Appia-3GR, Aurelia, Aurelia-2GR, Aurelia-3GR, Aurelia-4GR, Beach, MAC2000, MacDigit, Optima, Premier, Premier5, Program		



filtros			
para 1 taza			
			
1			
código	527135	referencia	03000321
descripción	filtro de café ø 70mm montaje ø 61.2mm H 21mm tazas 1 cantidad de café 6g		
Para modelos:	2GR-Compact, Appia-1gr, Appia-2-3gr, Appia-2GR, Appia-2GR-compact, Appia-3GR, Aurelia, Aurelia-2GR, Aurelia-3GR, Aurelia-4GR, MAC2000, MacDigit, Optima, Oscar, Premier, Premier5, Program		

para 2 tazas			
			
1			
código	527136	referencia	03000073 03000322 40300030
descripción	filtro de café ø 70mm montaje ø 61mm H 22mm tazas 2		
Para modelos:	2GR-Compact, Appia-1gr, Appia-2-3gr, Appia-2GR, Appia-2GR-compact, Appia-3GR, Aurelia, Aurelia-2GR, Aurelia-3GR, Aurelia-4GR, MAC2000, MacDigit, Optima, Oscar, Premier, Premier5, Program		

filtros ciegos			
			
1			
código	529023	referencia	03000107
descripción	filtro ciego ø 70mm montaje ø 60mm H 18mm		
Para modelos:	Appia-2GR, Appia-3GR, Aurelia-2GR, Aurelia-3GR, Aurelia-4GR, MAC2000, MacDigit, Optima, Oscar, Premier, Premier5, Program		

resortes para portafiltro			
			
1			
código	529079	referencia	08000017
descripción	resorte de portafiltro L 70mm An 60mm espesor de hilo 1.3mm para portafiltro de expreso		
Para modelos:	2GR-Compact, Appia-1gr, Appia-2-3gr, Appia-2GR, Appia-2GR-compact, Appia-3GR, Athena-Leva, Aurelia, Aurelia-2GR, Aurelia-3GR, Aurelia-4GR, MAC2000, MacDigit, Optima, Oscar, Premier, Premier5, Program		

unidades de infusión			
filtros de ducha			
plano			
			
1			
código	527107	referencia	03000067
descripción	filtro para máquina de café ø 34mm agujero ø 4.5mm		
Para modelos:	Master1		

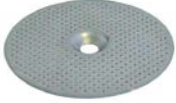
			
1			
código	527108	referencia	03000069
descripción	filtro para máquina de café ø 40mm agujero ø 4.5mm plano		
Para modelos:	Caffetteria-Italiana, Master1, Microbar		

con reborde y orificio central			
			
1			
código	527128	referencia	03000066
descripción	filtro para máquina de café		

			
1			
código	529144	referencia	03000066
descripción	filtro para máquina de café ø 56.5mm H 4.5mm agujero ø 5.3mm		
Para modelos:	Appia-1gr, Appia-2-3gr, Appia-2GR, Appia-2GR-compact, Appia-3GR, Aurelia, Aurelia-2GR, Aurelia-3GR, Aurelia-4GR, MAC2000, MacDigit, Optima, Oscar, Premier, Premier5, Program		

juntas pra portafiltro			
plano			
con muesca exterior			
			
1			
código	528405	referencia	02280020.C
descripción	junta portafiltro D1 ø 73mm D2 ø 58mm H 7mm con muescas exteriores UE 1 pzs		
Para modelos:	Appia-1gr, Appia-2-3gr, Appia-2GR-compact, Oscar		

estándar



1

código	528069	referencia	02280025
descripción	junta portafiltro D1 ø 72.5mm D2 ø 58mm H 4.5mm UE 1 pzs		
Para modelos:	Beach		



1

código	528047	referencia	02280020
descripción	junta portafiltro D1 ø 73mm D2 ø 58mm H 7mm UE 1 pzs		
Para modelos:	MAC2000, MacDigit, Optima, Premier, Premier5, Program		

con cono



1

código	528036	referencia	40200004
descripción	junta portafiltro con cono D1 ø 70.5mm D2 ø 56mm H1 8.9mm H2 5.8mm UE 1 pzs		
Para modelos:	Aurelia, Aurelia-2GR, Aurelia-3GR, Aurelia-4GR		



1

código	525021	referencia	02280020.V
descripción	junta portafiltro con cono D1 ø 71mm D2 ø 56mm H1 8.2mm H2 5mm UE 1 pzs		
Para modelos:	Appia-1GR, Appia-2GR, Appia-3GR, Oscar		

juntas tóricas



1

código	510409	referencia	18010746
descripción	junta tórica EPDM espesor 5.34mm int.ø 56.52mm UE 1 pzs		

unidades de infusión con válvula magnética

unidades de infusión específicas del fabricante



1

código	525010	referencia	70004010
descripción	unidad de infusión para NUOVA SIMONELLI		
Para modelos:	MAC2000, Optima, Program		

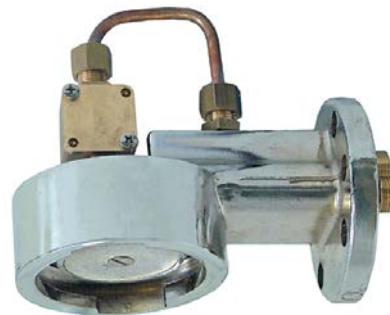

1

código	525011	referencia	70004011
descripción	unidad de infusión para NUOVA SIMONELLI		
Para modelos:	MAC2000, MacDigit, Optima, Program		



1

código	525012	referencia	78004000
descripción	unidad de infusión para NUOVA SIMONELLI		
Para modelos:	MAC2000		



1

código	525013	referencia	73004015
descripción	unidad de infusión para NUOVA SIMONELLI		
Para modelos:	Oscar		

juntas



1

código	532554	referencia	18010559
descripción	junta tórica silicona espesor 1.5mm int.ø 4.1mm UE 1 pzs		

boquillas



1

código	528831	referencia	07300174
descripción	boquilla		
Para modelos:	MAC2000, Premier, Premier5		



1

código	528954	referencia	07300022
descripción	boquilla agujero ø 0.8mm rosca M6 rosca L 6mm latón		
Para modelos:	Jazz, MAC2000, MacDigit, Optima, Program		



1

código	525018	referencia	07300127
descripción	boquilla agujero ø 2.5mm rosca M8 rosca L 8mm latón		
Para modelos:	Appia-1GR, Appia-2-3gr, Appia-2GR, Appia-3GR, Aurelia, Aurelia-2GR, Aurelia-3GR, Aurelia-4GR		



1

código	525017	referencia	07300226
descripción	boquilla agujero ø 2mm rosca M8 rosca L 8mm latón		
Para modelos:	Appia-1GR, Appia-2GR, Appia-2GR-compact, Appia-3GR, Aurelia-2GR, Aurelia-3GR, Aurelia-4GR		



1

código	525019	referencia	07300225
descripción	boquilla agujero ø 3mm rosca M8 rosca L 8mm latón		
Para modelos:	Appia-1gr, Appia-2-3gr, Appia-2GR, Appia-2GR-compact, Appia-3GR, Aurelia, Aurelia-2GR, Aurelia-3GR, Aurelia-4GR		



1

código	525020	referencia	07300184
descripción	boquilla agujero ø 4mm rosca M8 rosca L 8mm latón		
Para modelos:	MAC2000, Premier, Premier5		

piezas sueltas

boquillas

portaboquillas



1

código	528830	referencia	07300173
descripción	portaboquillas		
Para modelos:	MAC2000, Premier, Premier5		

juntas



1

código	528158	referencia	02060022
descripción	junta plana		
Para modelos:	MAC2000, MacDigit, Optima, Program		

distribuidores de agua

distribuidores de agua

grupo 3



1

código	525027	referencia	07300183
descripción	distribuidor de agua ø 57.4mm H 7.5mm 8 orificios agujero ø 2mm sujeción ø 6.6mm latón		
Para modelos:	Appia-2-3gr, Aurelia-2GR, Aurelia-3GR, Aurelia-4GR, MAC2000, Oscar, Premier, Premier5		



1

código	525028	referencia	07300183.5
descripción	distribuidor de agua ø 57.4mm H 9.5mm 8 orificios agujero ø 2mm latón		
Para modelos:	Appia-1gr, Appia-2GR, Appia-2GR-compact, Appia-3GR, Aurelia, Aurelia-2GR, Aurelia-3GR, Aurelia-4GR		

2 piezas



1

código	525033	referencia	98004000
descripción	brida agujero ø 22mm ø 72.5mm		
Para modelos:	MAC2000, MacDigit, Optima, Program		



1

código	529143	referencia	07300124
descripción	distribuidor de agua agujero ø 7mm 2mm latón ø 21.5mm		
Para modelos:	MAC2000, MacDigit, Optima, Program		

válvulas de seguridad

válvulas de seguridad

1/4"



1

código	527125	referencia	98013020
descripción	válvula de seguridad empalme 1/4" presión de intervención 1.8bar		
Para modelos:	2GR-Compact, Appia-1gr, Appia-2GR-compact, MAC2000, Oscar		

1/8"



1

código	525032	referencia	98120001
descripción	válvula de seguridad empalme 1/8" presión de intervención 16.5bar		
Para modelos:	2GR-Compact, Appia-1gr, Appia-2-3gr, Appia-2GR, Appia-2GR-compact, Appia-3GR, Microbar, Oscar		

3/8"



1

código	529346	referencia	98013001
descripción	válvula de seguridad empalme 3/8" H presión de intervención 1.8bar precintado		
Para modelos:	Appia-2GR, Appia-3GR, Athena-Leva, Aurelia-2GR, Aurelia-3GR, Aurelia-4GR, Caffetteria-Italiana, MAC2000, MacDigit, Premier, Premier5, Program		



1

código	527977	referencia	98013022
descripción	válvula de seguridad empalme 3/8" presión de intervención 1.8bar homologación CE 0036		



1

código	531134	referencia	9825000000040
descripción	válvula de seguridad Kit empalme 3/8" presión de intervención 1.8bar homologación CE 0035 precintado		

válvulas de expansión



1

código	529378	referencia	72012007
descripción	válvula de expansión G1: 1/4" M G2: 1/4" M L 37mm		
Para modelos:	Aurelia-2GR, Aurelia-3GR, Aurelia-4GR, Beach, MAC2000, MacDigit, Master1, Optima, Premier, Premier5, Program		

con racor para tubo flexible



código	527127	referencia	73012002
descripción	válvula de expansión G1: 1/8" M tubo ø 5mm L 28mm		
Para modelos:	Caffetteria-Italiana, Microbar, Oscar		

cubetas de desagüe

cubetas de desagüe



código	525025	referencia	05000018
descripción	cubeta de desagüe L 100mm An 80mm H 60mm		
Para modelos:	2GR-Compact, Appia-1gr, Appia-2-3gr, Appia-2GR, Appia-2GR-compact, Appia-3GR, Aurelia		



código	525024	referencia	05000403
descripción	cubeta de desagüe L 100mm An 80mm ø 40mm		
Para modelos:	Premier		

aireadores y purgadores



código	529303	referencia	01000023
descripción	aireador/purgador empalme 1/4" sólo vapor		
Para modelos:	2GR-Compact, Appia-1gr, Appia-2-3gr, Appia-2GR, Appia-2GR-compact, Appia-3GR, Athena-Leva, Aurelia, Aurelia-2GR, Aurelia-3GR, Aurelia-4GR, Caffetteria-Italiana, MAC2000, Master1, Optima, Premier, Premier5		
repuestos para	529303		



código	528687	referencia	—
descripción	junta tórica Viton espesor 1.78mm int.ø 3.69mm UE 1 pzs		

calentadores de agua

calentadores de agua para máquinas de espresso



código	525050	referencia	75030046
descripción	calentador de agua		
Para modelos:	MAC2000, MacDigit		

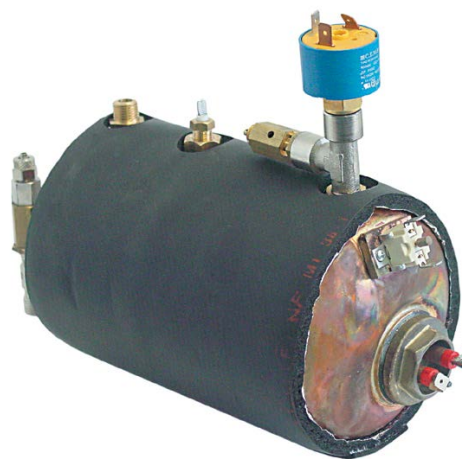



código	525054	referencia	7903004
descripción	calentador de agua		
repuestos para	525054		

código	541131	referencia	09200014old
descripción	presostato ø 35mm margen de presión ajustable 0,2-0,9bar conexión de presión vertical aparatos de café empalme 1 polo empalme de presión 1/4"		





1

código	525493	referencia	73003004
descripción	calentador de agua 1200W 230V ø 120mm L 200mm		
Para modelos:	Oscar		
repuestos para	525493		
	código	358012	referencia 09500014
	fusible térmico temp. desconexión 167°C nominal A longitud del cable 160mm		
	código	417195	referencia 14100040
	resistencia 1200W 230V espirales 1 rosca 1" L 155mm An 22mm H 22mm tubo ø 8.5mm ø casquillo portasondas 7mm longitud casquillo portasondas 160mm casquillo portasondas 1 casquillo termostato descentrado, ceñido empalme conector Faston 6,3mm resistencia de inmersión brida roscada EC 30		
	código	541477	referencia 09200014
	presostato margen de presión 0.6bar empalme 1/4" 16A 1 polos tipo aparatos de café		

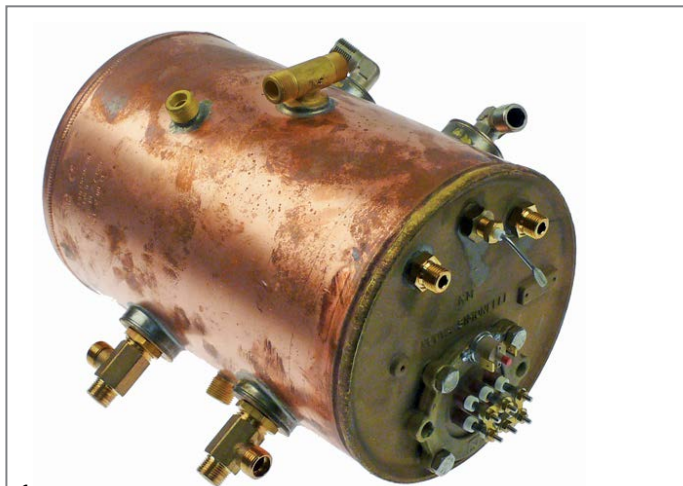

1

código	531205	referencia	78030092
descripción	calentador de agua 2700W 230V ø 180mm L 280mm brida brida 4 orificios unidades de infusión 2 grupos		



1

código	525051	referencia	79030023
descripción	calentador de agua unidades de infusión 2		
Para modelos:	MAC2000		

juntas

con agujero



1

código	528809	referencia	02060026
descripción	junta para calentador de agua D1 ø 140mm D2 ø 110mm espesor 2mm 5 orificios grafito para NUOVA SIMONELLI núm. Ref. 0206026		

accesorios

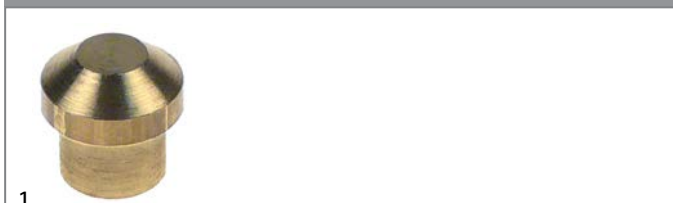

1

código	525035	referencia	07300097
descripción	tapa terminal ø 14mm L 14mm		
Para modelos:	2GR-Compact, Appia-1gr, Appia-2-3gr, Appia-2GR, Appia-2GR-compact, Appia-3GR, Aurelia, Aurelia-2GR, Aurelia-3GR, Aurelia-4GR		

grifos de vapor/agua

grifos de vapor/agua

grifos de vapor/agua



1

código	529663	referencia	98006000 98007000 98008000
descripción	vapor/grifo		
Para modelos:	Beach, Optima		



<p>1</p>			
código	529765	referencia	75006031 75006032
descripción	vapor/grifo		
Para modelos:	Caffetteria-Italiana, MAC2000		

grifos de vapor

grifos de vapor completos

<p>1</p>			
código	527117	referencia	80006000
descripción	grifo de vapor completo		
Para modelos:	Master1		

<p>1</p>			
código	527129	referencia	73006010
descripción	grifo de vapor con tubo vapor		
Para modelos:	Oscar		

<p>1</p>			
código	525055	referencia	73006010
descripción	grifo de vapor entrada 3/8" tubo latón cromado longitud de tubo 170mm tubo ø 8mm		

<p>1</p>			
código	525049	referencia	78006003
descripción	grifo de vapor entrada 3/8" tubo latón cromado longitud de tubo 210mm tubo ø 10mm		
Para modelos:	Premier		
repuestos para	525049		
	código	referencia	75006015
	528829	boquilla de vapor rosca 1/8" ø 16mm L 28mm 4 orificios taladro ø 1.5mm inox	

<p>1</p>			
código	529662	referencia	75006005
descripción	grifo de vapor pos. de montaje izquierdo		
Para modelos:	MacDigit, Program		

<p>1</p>			
código	525057	referencia	98006020
descripción	grifo de vapor pos. de montaje izquierdo/derecho sin manilla entrada 3/8" tubo inox longitud de tubo 210mm tubo ø 10mm		
Para modelos:	2GR-Compact, Appia-2GR, Appia-3GR, Aurelia-2GR, Aurelia-3GR, Aurelia-4GR		
accesorios para	525057		
	código	referencia	98006022
	525031	palanca con soporte pos. de montaje izquierdo	
	código	referencia	98006021
	525041	palanca con soporte pos. de montaje derecho	

piezas sueltas

soportes juntas



1			
código	525034	referencia	98008004
descripción	pistón para grifo de vapor / agua hexagonal 20 L 11mm		
Para modelos:	2GR-Compact, Appia-1gr, Appia-2GR, Appia-2GR-compact, Appia-3GR, Aurelia, Aurelia-2GR, Aurelia-3GR, Aurelia-4GR, Beach, Caffetteria-Italiana, MAC2000, MacDigit, Optima, Oscar, Personal, Premier, Premier5, Program		

tuercas de racor



1			
código	528827	referencia	07300296
descripción	tuerca de racor		

uniones roscadas



1			
código	528816	referencia	07300113
descripción	armella		
Para modelos:	Caffetteria-Italiana, MAC2000, MacDigit, Master1, Optima, Personal, Premier, Premier5, Program		



1			
código	528819	referencia	07300107
descripción	tornillo		
Para modelos:	Caffetteria-Italiana, MAC2000, MacDigit, Master1, Optima, Personal, Premier, Premier5, Program		

grifos

grifos



1			
código	529661	referencia	75006004 75006005 75006009 75007000 75007007 78005000 78006000
descripción	grifo		
Para modelos:	MAC2000, MacDigit, Personal, Premier5, Program		



1			
código	525056	referencia	78007004
descripción	grifo entrada 3/8" tubo latón cromado longitud de tubo 95mm tubo ø 10mm		
Para modelos:	Premier		

tubos de vapor/agua

tubos de vapor



1			
código	527119	referencia	80006006 80006007
descripción	tubo de vapor		
Para modelos:	Master1		



1			
código	529769	referencia	75006024 75006037
descripción	tubo de vapor		



1			
código	529882	referencia	75006035
descripción	tubo de vapor		
Para modelos:	MAC2000		
accesorios para	529882		

	código	528828	referencia	07300030 98006B02
boquilla de vapor ø 15mm L 25mm 4 orificios				



			
1			
código	529664	referencia	75006010
descripción	tubo de vapor 1 grupo		
Para modelos:	MacDigit, Personal, Program		

			
1			
código	529665	referencia	75006008
descripción	tubo de vapor 2-4 grupos		
Para modelos:	MacDigit, Program		

			
1			
código	529815	referencia	75006012
descripción	tubo de vapor inox		
Para modelos:	Appia-1gr, Appia-2-3gr		

			
1			
código	525047	referencia	78006005
descripción	tubo de vapor rosca 1/8" L 200mm tubo ø 10mm		
Para modelos:	Athena-Leva, Premier		

			
1			
código	525023	referencia	75006037.1
descripción	tubo de vapor rosca 3/8" inox		
Para modelos:	2GR-Compact, Appia-1gr, Appia-2-3gr, Appia-2GR, Appia-3GR, Aurelia-2GR, Aurelia-3GR, Aurelia-4GR		

			
1			
código	525048	referencia	98006010
descripción	tubo de vapor rosca 3/8" L 190mm tubo ø 10mm inox		
Para modelos:	Aurelia, Aurelia-3GR		

			
1			
código	527130	referencia	73006002
descripción	tubo de vapor rosca M10x1 L 170mm tubo ø 8mm		
Para modelos:	Oscar		

			
1			
código	529864	referencia	75006037
descripción	tubo de vapor sin boquilla		
Para modelos:	Appia-2GR-compact, Aurelia		

			
1			
código	529866	referencia	78006001
descripción	tubo de vapor sin boquilla		
Para modelos:	Premier5		

boquillas para tubos de vapor

			
1			
código	529865	referencia	75006038
descripción	boquilla		
Para modelos:	2GR-Compact, Appia-1gr, Appia-2-3gr, Appia-2GR, Appia-2GR-compact, Appia-3GR, Aurelia, Aurelia-2GR, Aurelia-3GR, Aurelia-4GR		

			
1			
código	528828	referencia	07300030 98006B02
descripción	boquilla de vapor ø 15mm L 25mm 4 orificios		
Para modelos:	MacDigit, Optima, Premier5, Program		

			
1			
código	527131	referencia	73006003 73006003.12
descripción	boquilla de vapor rosca 1/8" ø 15mm L 27mm 4 orificios taladro ø 1.2mm latón cromado		
Para modelos:	Oscar		

			
1			
código	528829	referencia	75006015 75006015+07300466
descripción	boquilla de vapor rosca 1/8" ø 16mm L 28mm 4 orificios taladro ø 1.5mm inox		
Para modelos:	Athena-Leva, Caffetteria-Italiana, Master1, Premier		

boquillas para tubos de agua

boquillas para tubos de agua



1

código	527121	referencia	75006016
descripción	boquilla para tubo de agua		
Para modelos:	Master1		

tubos de agua



1

código	527120	referencia	80007005
descripción	tubo de agua		
Para modelos:	MAC2000, Master1		



1

código	529767	referencia	75007008
descripción	tubo de agua		
Para modelos:	MAC2000, MacDigit, Personal, Program		



1

código	529768	referencia	75007005
descripción	tubo de agua		
Para modelos:	MacDigit, Program		



1

código	527118	referencia	80007000
descripción	tubo de agua con adaptador		
Para modelos:	Master1		



1

código	525044	referencia	78007005
descripción	tubo de agua L 100mm taladro ø 4mm tubo ø 10mm		
Para modelos:	Premier		



1

código	529668	referencia	75007005 78007001
descripción	tubo de agua L 145mm taladro ø 12mm tubo ø 8mm		
Para modelos:	Premier, Premier5		



1

código	525045	referencia	98007007
descripción	tubo de agua rosca 3/8" ø 24mm L 120mm tubo ø 10mm EC 22 inox		
Para modelos:	2GR-Compact, Appia-1GR, Appia-2GR, Appia-3GR, Aurelia-2GR, Aurelia-3GR, Aurelia-4GR		



1

código	525046	referencia	98007009
descripción	tubo de agua rosca 3/8" ø 24mm L 65mm tubo ø 8mm EC 22 inox		
Para modelos:	2GR-Compact, Appia-2GR, Appia-3GR, Aurelia-2GR, Aurelia-3GR, Aurelia-4GR		

accesorios

casquillos



1

código	528824	referencia	07300293
descripción	casquillo D1 ø 8.5mm D2 ø 12mm H 6mm latón int.ø 7mm		
Para modelos:	2GR-Compact, Appia-1gr, Appia-2-3gr, Appia-2GR, Appia-2GR-compact, Appia-3GR, Athena-Leva, Aurelia, Aurelia-2GR, Aurelia-3GR, Aurelia-4GR, Caffetteria-Italiana, Oscar, Premier		





1

código	528825	referencia	07300294
descripción	casquillo inox		





muelles			
			
1			
código	528823	referencia	08000027
descripción	resorte de compresión ø 11.8mm L 16mm espesor de hilo 1.5mm		
Para modelos:	2GR-Compact, Appia-1gr, Appia-2-3gr, Appia-2GR, Appia-2GR-compact, Appia-3GR, Athena-Leva, Aurelia, Aurelia-2GR, Aurelia-3GR, Aurelia-4GR, Caffetteria-Italiana, Oscar, Premier		

manillas de tubo			
			
1			
código	525042	referencia	05000001
descripción	manilla de tubo para tubo ø 10mm ø 13.5mm L 50mm goma		
Para modelos:	2GR-Compact, Appia-1gr, Appia-2-3gr, Appia-2GR, Appia-2GR-compact, Appia-3GR, Aurelia, Aurelia-2GR, Aurelia-3GR, Aurelia-4GR, Caffetteria-Italiana, Premier		

			
1			
código	525043	referencia	05000002
descripción	manilla de tubo para tubo ø 8mm ø 13.5mm L 50mm goma		
Para modelos:	Microbar, Oscar		

tuercas de racor			
			
1			
código	528826	referencia	07300295
descripción	tuerca de racor rosca 3/8" L 21mm agujero ø 12.5mm latón cromado		
Para modelos:	2GR-Compact, Appia-1gr, Appia-2-3gr, Appia-2GR, Appia-2GR-compact, Appia-3GR, Aurelia, Aurelia-2GR, Aurelia-3GR, Aurelia-4GR, Caffetteria-Italiana, Oscar, Premier		

uniones roscadas			
			
1			
código	528821	referencia	07300292
descripción	boquilla doble G1: 3/8" G2: M8 L 18mm acero inoxidable EC 22		
Para modelos:	2GR-Compact, Appia-1gr, Appia-2-3gr, Appia-2GR, Appia-2GR-compact, Appia-3GR, Aurelia, Aurelia-2GR, Aurelia-3GR, Aurelia-4GR		

			
1			
código	531133	referencia	07300466
descripción	boquilla doble para tubo de vapor rosca 1/8" L 16mm ø 12mm int.ø 5mm		

filtros finos			
			
1			
código	528832	referencia	98004001
descripción	filtro fino plano ø 8mm		
Para modelos:	Appia-1GR, Appia-2GR, Appia-3GR, Aurelia, Aurelia-2GR, Aurelia-3GR, Aurelia-4GR, Beach, MAC2000, MacDigit, Master1, Optima, Premier, Premier5, Program		

válvulas de llenado			
			
1			
código	528811	referencia	02590009
descripción	junta		
Para modelos:	Appia-2GR, Appia-3GR, Beach, MacDigit, Master1, Optima, Program		

mirillas de nivel			
			
1			
código	529419	referencia	02260024 964
descripción	junta D1 ø 19mm D2 ø 11.5mm H 10.5mm tubo nivel de agua para NUOVA SIMONELLI núm. Ref. 02260024		
Para modelos:	Optima		

mirillas completas			
			
1			
código	525039	referencia	75010001
descripción	tubo nivel de agua L 145mm ø 12mm rosca 3/8"		
Para modelos:	Athena-Leva, MAC2000, Personal, Premier, Premier5, Program		

			
1			
código	525040	referencia	98010030
descripción	tubo nivel de agua L 195mm ø 12mm rosca 3/8"		
Para modelos:	Appia-1GR, Appia-3GR, Aurelia-2GR, Aurelia-3GR, Aurelia-4GR		

tubos de mirilla



1

código	529421	referencia	09000009
descripción	tubo nivel de agua ø 12mm H 112mm int.ø 7.6mm		
Para modelos:	Appia-1gr, Appia-2-3gr, Appia-2GR, Appia-3GR, Athena-Leva, Aurelia, Aurelia-2GR, Aurelia-3GR, Aurelia-4GR, MAC2000, MacDigit, Personal, Premier, Premier5, Program		



1

código	526370	referencia	09000009
descripción	tubo nivel de agua ø 12mm H 112mm int.ø 9mm rojo		



1

código	529418	referencia	09000010
descripción	tubo nivel de agua ø 12mm H 135mm		
Para modelos:	Beach, Optima		

válvulas de retención

completo



1

código	529395	referencia	98003016 98003018
descripción	válvula de retención entrada 1/4" salida 1/4" L 50mm		
Para modelos:	2GR-Compact, Appia-1gr, Appia-2GR-compact, Athena-Leva, Caffetteria-Italiana, MAC2000, MacDigit, Master1, Premier, Premier5, Program		

otros

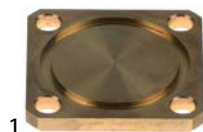

1

código	525026	referencia	07300166
descripción	brida L 32mm An 32mm		
Para modelos:	Aurelia, Aurelia-2GR, Aurelia-3GR, Aurelia-4GR, MAC2000, MacDigit, Program		

uniones roscadas

boquillas dobles



1

código	520682	referencia	07300017
descripción	boquilla doble latón rosca 1/4" - 3/8" UE 1 pzs		
Para modelos:	2GR-Compact, Appia-1gr, Appia-2-3gr, Appia-2GR, Appia-2GR-compact, Appia-3GR, Athena-Leva, Aurelia, Aurelia-2GR, Aurelia-3GR, Aurelia-4GR, Caffetteria-Italiana, Master1, Premier, Premier5		

piezas angulares



1

código	531101	referencia	07300068
descripción	pieza angular G1: 3/8" G2: 3/8" L 34mm latón UE 1 pzs		
Para modelos:	2GR-Compact, Appia-1gr, Appia-2-3gr, Appia-2GR, Appia-2GR-compact, Appia-3GR, Athena-Leva, Aurelia, Aurelia-2GR, Aurelia-3GR, Aurelia-4GR, Caffetteria-Italiana, MAC2000, Master1, Premier, Premier5		

muelas

muelas rectas

estándar



1

código	527244	referencia	15800045
descripción	par de muelas sentido de rotación derecho D1 ø 50mm int.ø 30mm H 7.5mm distancia entre dientes 2.5mm agujero ø 4.5mm taladro ø 7.5mm fijación ø 40 recto apto para GAGGIA, BABY		
Para modelos:	Microbar		



1

código	527113	referencia	15050001
descripción	par de muelas sentido de rotación derecho D1 ø 64mm int.ø 37.5mm H 9mm distancia entre dientes 4mm agujero ø 6mm taladro ø 8.5mm fijación ø 49 recto		



portamuelas



1

código	527115	referencia	15000043
descripción	portamuelas pos. de montaje abajo		



1

código	527114	referencia	15000044
descripción	portamuelas pos. de montaje arriba		

recipientes de dosificación

palancas

palancas



1

código	111126	referencia	05000039
descripción	palanca izquierdo		
Para modelos:	MAC2000, MacDigit, Master1, Personal, Premier5, Program		

contenedores para café en grano

tapas de recipientes



1

código	527112	referencia	15000050
descripción	tapa para contenedor para café en grano		
Para modelos:	Caffetteria-Italiana		

contenedores para café en grano



1

código	527111	referencia	01100002
---------------	--------	-------------------	----------

descripción contenedor para café en grano

Para modelos: Caffetteria-Italiana

accesorios para 527111

código	527112	referencia	15000050
---------------	--------	-------------------	----------



tapa para contenedor para café en grano



1

código	531165	referencia	15010002
---------------	--------	-------------------	----------

descripción contenedor para café en grano completo ø 208mm H 280mm soporte ø 52mm

para máquinas de café automáticas

unidades de infusión

unidades de infusión

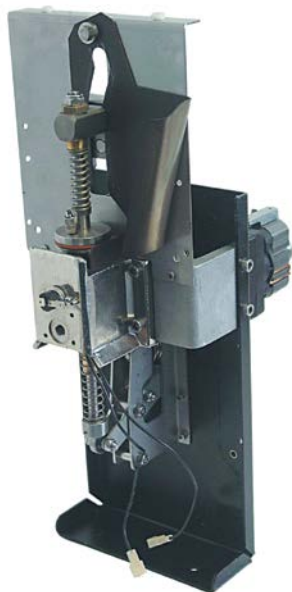

1

código	527101	referencia	80004041
descripción	unidad de infusión completo		
Para modelos:	Master1		

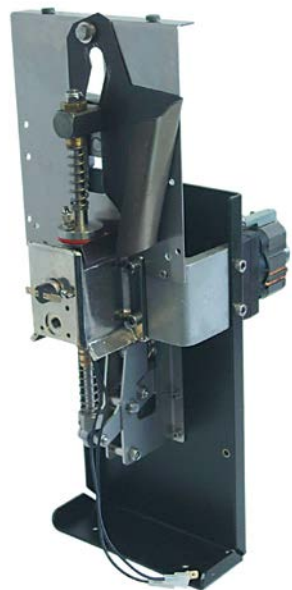

1

código	527140	referencia	80004001
descripción	unidad de infusión completo		
Para modelos:	Master1		

salidas de café

salidas de café



1

código	527102	referencia	80004007
descripción	salida de café		

pistones

pistones



1

código	527105	referencia	80004004
descripción	pistón abajo ø 36mm con cámara		
Para modelos:	Master1		



1

código	527106	referencia	80004044
descripción	pistón abajo ø 43mm con cámara		
Para modelos:	Master1		

1

código	527103	referencia	80004006
descripción	pistón arriba ø 36mm		
Para modelos:	Master1		



1

código	527104	referencia	80004046
descripción	pistón arriba ø 43mm		
Para modelos:	Master1		

unidades molienda

unidades molienda

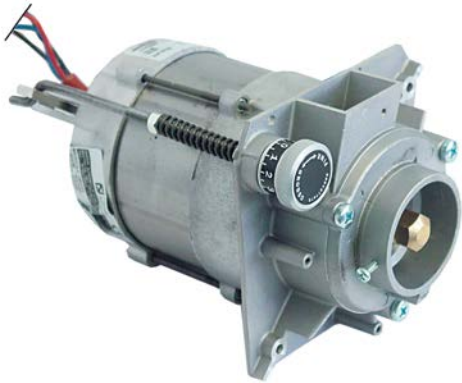

1

código	527110	referencia	01100001
descripción	unidad molidora completo para NUOVA SIMONELLI		
Para modelos:	Master1		

componentes mecánicos



1

código	527109	referencia	80004005
descripción	mecánico completo		
Para modelos:	Master1		

batidores de leche



1

código	527116	referencia	01000112
descripción	batidor de leche para NUOVA SIMONELLI Master1		
Para modelos:	Master1		

otros



1

código	696700	referencia	04100024.P
descripción	manilla ø 25mm agujero ø 5,3x6mm L 7.5mm		

para expendedoras de bebidas

tornillos sin fin



1

código	650054	referencia	16300107
descripción	tornillo sin fin para expendedora de bebidas		

para sartén basculante

otros



1

código	523510	referencia	15010034 15100086
descripción	rodamiento de bolas radial tipo 6202-2RS árbol ø 15mm ø ext. 35mm An 11mm con arandelas de junta cojinete ranurado DIN 625-1		

para lavavajillas

contenedores

tapas de recipientes



1

código	507050	referencia	18010414
descripción	tapa para contenedor de sal		
Para modelos:	KIARA6		



1

código	507020	referencia	18010284
descripción	tapa de recipientes apto para recipiente abrillantador		
Para modelos:	KIARA6		

recipientes de dosificación









1

código	507016	referencia	18010224
descripción	recipiente abrillantador		
Para modelos:	KIARA6		
repuestos para	507016		
	código	referencia	
	507020	18010284	
	tapa de recipientes apto para recipiente abrillantador		

recipientes de sal



1

código	510929	referencia	18010059 18010520
descripción	recipiente de sal ø 120mm H 117mm tubo ø 10mm montaje ø 70mm altura total 157mm		
Para modelos:	KIARA6		
repuestos para	510929		
	código	referencia	—
	506015	—	
	junta tórica EPDM espesor 3.53mm int.ø 39.69mm UE 1 pzs		
	código	referencia	18010413
	510018	18010413	
	tuerca ø 92mm H 10.5mm para contenedor de sal int.ø 64mm		
	código	referencia	18010512
	524177	18010512	
	tapa ø 69mm H 20mm para contenedor de sal int.ø 50mm		
accesorios para	510929		
	código	referencia	—
	510071	—	
	junta plana goma ø ext. 81mm int.ø 68mm espesor 3mm para contenedor de sal UE 1 pzs		
	código	referencia	—
	510654	—	
	junta H 6mm D1 ø 82mm D2 ø 68mm		
	código	referencia	—
	510883	—	
	junta goma ø ext. 86mm int.ø 66mm espesor 2mm para contenedor de sal UE 1 pzs		



1

código	524177	referencia	18010512
descripción	tapa ø 69mm H 20mm para contenedor de sal int.ø 50mm		
Para modelos:	KIARA6		
accesorios para	524177		
	código	referencia	—
	524148	—	
	junta tórica EPDM espesor 3.53mm int.ø 40.86mm UE 1 pzs		



1

código	510018	referencia	18010413
descripción	tuerca ø 92mm H 10.5mm para contenedor de sal int.ø 64mm		
Para modelos:	KIARA6		



1

código	507047	referencia	18011061
descripción	calentador de agua ø 160mm L 440mm		

calentadores de agua

calentadores de agua para lavavajillas



1

código	507107	referencia	18010027 18011017
descripción	calentador de agua		



1

código	507108	referencia	18010130
descripción	calentador de agua		



1

código	507111	referencia	18010832
descripción	calentador de agua		



1

código	507112	referencia	18010801
descripción	calentador de agua ø 150mm L 425mm		
Para modelos:	KIARA6		

platos giratorios

platos giratorios



1

código	507321	referencia	18010030
descripción	plato giratorio ø 292mm		

cartuchos descalcificadores

columnas descalcificadoras



1

código	530000	referencia	18010522
descripción	descalcificador cuádruple L 380mm An 180mm		

cajas y paneles frontales

paneles



1

código	502188	referencia	18010770
descripción	panel de mando LTM1600 L 400mm An 50mm H 159mm negro		



1

código	502253	referencia	18010846
descripción	panel de mando sistemas de lavado L 310mm An 133mm H 7mm negro		

mecanismos de capota para lavavajillas

soporte de muelle



1

código	507156	referencia	18010725
descripción	soporte de muelle mecanismo de campana		

varillaje



1

código	507158	referencia	18010726
descripción	barra de tracción para muelle de campana		

cámaras de aire

cámaras de aire



1

código	507171	referencia	18010077	
descripción	cámara de aire			
Para modelos:	KIARA6			
accesorios para	507171			
	código	507052	referencia	18010648
	tuerca hexagonal rosca 3/4" UE 1 pzs			
	código	507078	referencia	18010227 18010750
	junta plana goma ø ext. 25mm int.ø 14.5mm espesor 2.5mm UE 1 pzs			
	código	507080	referencia	18010371
	junta plana goma ø ext. 39mm int.ø 25mm espesor 1.5mm UE 1 pzs			
	código	507172	referencia	18010217
	codo de empalme para cámara de aire			
	código	507173	referencia	18010226
	tuerca para codo de empalme para cámara de aire			



1

código	524917	referencia	LTM1600
descripción	cámara de aire ø 60.5mm H 110mm rosca 3/4" tubo ø 6mm plástico		

accesorios para cámaras de aire



1

código	507172	referencia	18010217
descripción	codo de empalme para cámara de aire		
Para modelos:	KIARA6		



1

código	507173	referencia	18010226
descripción	tuerca para codo de empalme para cámara de aire		
Para modelos:	KIARA6		

mecánica de puertas

topes de puerta



1

código	507490	referencia	18011009
descripción	tope de puerta H 10mm silicona L 33mm An 15mm		

árboles de puerta



1

código	507039	referencia	18010045	
descripción	para árbol de puerta			
accesorios para	507039			
	código	507040	referencia	18010045
	anillo truarc E D1 ø 4mm D2 ø 9mm inox DIN 6799 espesor 0.7mm			



1

código	507026	referencia	18011052	
descripción	para árbol de puerta L 175mm			
Para modelos:	KIARA6			
accesorios para	507026			
	código	507015	referencia	—
	anillo truarc E D1 ø 7mm D2 ø 14mm inox DIN 6799 espesor 0.9mm para árbol ø 8-11mm			





1				
código	507022	referencia	18010004	
descripción	para árbol de puerta ø 8mm L 90mm			
accesorios para	507022			
	código	507015	referencia	—
	anillo truar. E D1 ø 7mm D2 ø 14mm inox DIN 6799 espesor 0.9mm para árbol ø 8-11mm			

1			
código	346945	referencia	18010171
descripción	pieza angular		

cierres

1			
código	507011	referencia	18010003
descripción	cierre de puerta completo cierre de puerta		
Para modelos:	KIARA6		

1			
código	507031	referencia	18011011
descripción	placa de sujeción para puerta		

1			
código	506157	referencia	18000017
descripción	cierre de puerta traba		

uniones roscadas

1			
código	507057	referencia	18010188
descripción	tuerca rosca 1½" H 14mm EC 60 ø 65mm		
Para modelos:	KIARA6		

otros

1			
código	507012	referencia	18010812
descripción	anillo distnciador casquillo		
Para modelos:	KIARA6		

1			
código	507058	referencia	18010099
descripción	unión roscada rosca 1¼" H 14mm EC 55		
Para modelos:	KIARA6		

1			
código	507034	referencia	18010394
descripción	escuadra de sujeción para microinterruptor		
Para modelos:	KIARA6		

sistemas de lavado y aclarado

1			
código	507224	referencia	18010472
descripción	anillo deslizante		
Para modelos:	KIARA6		



1

código	507177	referencia	18010023
descripción	empalme de tubo latón recto		



1

código	517414	referencia	18010640
descripción	soporte de brazo de aclarado ø 20mm H 44mm rosca 1/4"/M10x1 EC 23		



1

código	507235	referencia	18010496
descripción	tubo de lavado		
Para modelos:	KIARA6		



1

código	507054	referencia	18010180 18010614
descripción	tuerca rosca 3/8" H 10mm latón EC 20 UE 1 pzs		
Para modelos:	KIARA6		



1

código	507175	referencia	18010335
descripción	unión roscada para brazo de aclarado		

pomos

grifos de vapor/agua

grifos de vapor/agua



1

código	111127	referencia	98008006
descripción	pomo ø 48mm negro		
Para modelos:	Beach, Optima		

otros



1

código	112016	referencia	05000174
descripción	pomo universal ø 49mm eje ø 8x6,5mm		
Para modelos:	Oscar		

manillas y volantes

manillas



1

código	111316	referencia	05000815
descripción	corredera eje ø 6mm		
Para modelos:	2GR-Compact, Appia-1gr, Appia-2-3gr, Appia-2GR, Appia-2GR-compact, Appia-3GR, Aurelia, Aurelia-2GR, Aurelia-3GR, Aurelia-4GR		



1

código	111132	referencia	05000022
descripción	palanca		
Para modelos:	Caffetteria-Italiana, MAC2000, Premier		



			
1			
código	525041	referencia	98006021
descripción	palanca con soporte pos. de montaje derecho		
Para modelos:	2GR-Compact, Appia-2GR, Appia-3GR, Aurelia-2GR, Aurelia-3GR, Aurelia-4GR		

			
1			
código	525031	referencia	98006022
descripción	palanca con soporte pos. de montaje izquierdo		
Para modelos:	2GR-Compact, Appia-2GR, Appia-3GR		

accesorios

			
1			
código	525030	referencia	07300355
descripción	soporte L 41mm An 26mm int.ø 16.5mm latón		
Para modelos:	2GR-Compact, Appia-1gr, Appia-2-3gr, Appia-2GR, Appia-2GR-compact, Appia-3GR, Aurelia, Aurelia-2GR, Aurelia-3GR, Aurelia-4GR, Caffetteria-Italiana, MAC2000, Premier		

grifería para cocinas industriales

grifos de vaciado

accesorios

			
1			
código	540222	referencia	18010148
descripción	junta tórica EPDM espesor 2.62mm int.ø 47.3mm UE 1 pzs		
Para modelos:	KIARA6		

pies para aparatos y tapas terminales

pies de aparatos insertables

			
1			
código	802040	referencia	15050013
descripción	pie de aparato ø 20mm H 10mm montaje ø 11mm altura total 23mm goma UE 1 pzs		

DERBY RUOTE

recambios y accesorios

otros

			
1			
código	700134	referencia	00300018
descripción	tuerca inox rosca M8 autobloqueo		
Para modelos:	Master1		

cestos

cestos de lavado

cestos de plástico redondos

			
1			
código	970812	referencia	18010068 18010069
descripción	cesta para vajillas diversas ø ext. 367mm H 173mm soporte ø 280mm tipo de maneta de malla gruesa		

cestos de plástico octogonal

cestas de lavado

			
1			
código	971078	referencia	18010901
descripción	cesta para vajillas diversas L 400mm An 400mm H 150mm		

accesorios

cubiertos



código	970349	referencia	18010579
descripción	complemento para cubiertos L 130mm An 57mm ømm H 110mm		

juntas

juntas tóricas

EPDM

ø1,78mm

código	524421	referencia	15100176
descripción	junta tórica EPDM espesor 1.78mm int.ø 2.78mm UE 1 pzs		

código	529491	referencia	02280012
descripción	junta tórica EPDM espesor 1.78mm int.ø 23.52mm UE 1 pzs		
Para modelos:	Aurelia, Aurelia-2GR, Aurelia-3GR, Aurelia-4GR, MAC2000, MacDigit, Program		

código	517035	referencia	18010555
descripción	junta tórica EPDM espesor 1.78mm int.ø 4.48mm UE 1 pzs		

código	505045	referencia	02280007
descripción	junta tórica EPDM espesor 1.78mm int.ø 5.28mm UE 1 pzs		
Para modelos:	Beach		

código	510303	referencia	18010162
descripción	junta tórica EPDM espesor 1.78mm int.ø 6.75mm UE 1 pzs		
Para modelos:	KIARA6		

código	525022	referencia	02280033
descripción	junta tórica EPDM espesor 1.78mm int.ø 75.92mm UE 1 pzs		
Para modelos:	Aurelia, Aurelia-2GR, Aurelia-3GR, Aurelia-4GR		

código	530293	referencia	02280010
descripción	junta tórica EPDM espesor 1.78mm int.ø 8.73mm UE 1 pzs		
Para modelos:	Beach, Caffetteria-Italiana, MAC2000, MacDigit, Master1, Optima, Personal, Premier, Premier5, Program		

código	361304	referencia	02280032
descripción	junta tórica EPDM int.ø 11.11mm espesor 1.78mm UE 1 pzs para tipo DIB3E/DIB5E		
Para modelos:	2GR-Compact, Appia-1gr, Appia-2-3gr, Appia-2GR, Appia-2GR-compact, Appia-3GR, Athena-Leva, Aurelia, Aurelia-2GR, Aurelia-3GR, Aurelia-4GR, Beach, Caffetteria-Italiana, MAC2000, MacDigit, Personal, Premier, Premier5, Program		

ø2,00mm

código	361080	referencia	02280037
descripción	junta tórica EPDM espesor 2mm int.ø 16mm UE 1 pzs		
Para modelos:	2GR-Compact, Appia-1GR, Appia-2GR, Appia-3GR, Aurelia-2GR, Aurelia-3GR, Aurelia-4GR		



ø2,62mm

código	528223	referencia	02280004
descripción	junta tórica EPDM espesor 2.62mm int.ø 11.91mm UE 1 pzs		
Para modelos:	2GR-Compact, Appia-1gr, Appia-2-3gr, Appia-2GR, Appia-2GR-compact, Appia-3GR, Athena-Leva, Aurelia, Aurelia-2GR, Aurelia-3GR, Aurelia-4GR, Caffetteria-Italiana, Microbar, Oscar, Premier		

código	507314	referencia	18010033
descripción	junta tórica EPDM espesor 2.62mm int.ø 32.99mm		
accesorios para	507314		
	código	referencia	18010033
	junta tórica EPDM espesor 2.62mm int.ø 32.99mm		

código	507313	referencia	02280011
descripción	junta tórica EPDM espesor 2.62mm int.ø 13.95mm UE 1 pzs		
Para modelos:	2GR-Compact, Appia-1gr, Appia-2-3gr, Appia-2GR, Appia-2GR-compact, Appia-3GR, Athena-Leva, Aurelia, Aurelia-2GR, Aurelia-3GR, Aurelia-4GR, Caffetteria-Italiana, MAC2000, MacDigit, Master1, Optima, Oscar, Personal, Premier, Premier5, Program		

código	507315	referencia	18010035
descripción	junta tórica EPDM espesor 2.62mm int.ø 42.52mm		
Para modelos:	KIARA6		

código	507309	referencia	18010302
descripción	junta tórica EPDM espesor 2.62mm int.ø 17.13mm UE 1 pzs		
Para modelos:	KIARA6		

código	512111	referencia	18010342
descripción	junta tórica EPDM espesor 2.62mm int.ø 45.69mm UE 1 pzs		
Para modelos:	KIARA6		

código	504590	referencia	18010207
descripción	junta tórica EPDM espesor 2.62mm int.ø 18.72mm UE 1 pzs		
Para modelos:	KIARA6		

código	540222	referencia	18010148
descripción	junta tórica EPDM espesor 2.62mm int.ø 47.3mm UE 1 pzs		
Para modelos:	KIARA6		

código	505073	referencia	18010322
descripción	junta tórica EPDM espesor 2.62mm int.ø 20.63mm UE 1 pzs		

ø3,53mm

código	523012	referencia	17000032
descripción	junta tórica EPDM espesor 3.53mm int.ø 57.15mm UE 1 pzs		



código	532130	referencia	17000032
descripción	junta tórica EPDM espesor 3.53mm int.ø 68.26mm UE 10 pzs		
Para modelos:	Athena-Leva		



código	532588	referencia	02000003
descripción	junta tórica silicona espesor 1.78mm int.ø 12.42mm UE 1 pzs		
Para modelos:	Master1		

ø5,34mm



código	510409	referencia	18010746
descripción	junta tórica EPDM espesor 5.34mm int.ø 56.52mm UE 1 pzs		

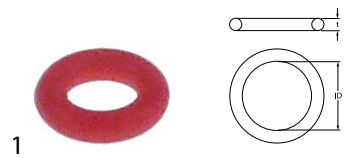

código	526403	referencia	02280014
descripción	junta tórica silicona espesor 1.78mm int.ø 3.69mm UE 1 pzs		
Para modelos:	Appia-1gr, Appia-2-3gr, Appia-2GR, Appia-2GR-compact, Appia-3GR, Aurelia, Aurelia-2GR, Aurelia-3GR, Aurelia-4GR, Beach, Caffetteria-Italiana, MAC2000, MacDigit, Master1, Optima, Oscar, Personal, Premier, Premier5, Program		



código	508109	referencia	18010602
descripción	junta tórica EPDM espesor 5.34mm int.ø 69.22mm UE 1 pzs		
Para modelos:	KIARA6		

ø2,62mm



código	532246	referencia	02280018
descripción	junta tórica silicona espesor 2.62mm int.ø 13.95mm UE 10 pzs		
Para modelos:	Oscar		

silicona

ø1.50mm

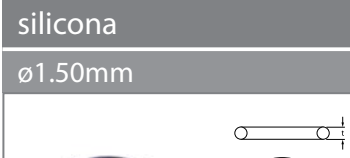

código	532554	referencia	18010559
descripción	junta tórica silicona espesor 1.5mm int.ø 4.1mm UE 1 pzs		

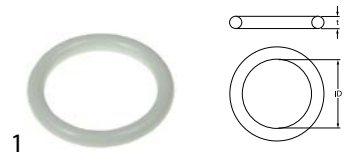

código	532513	referencia	16300040
descripción	junta tórica silicona espesor 2.62mm int.ø 15.88mm UE 1 pzs para alimentos blanco		

ø1,78mm



código	529422	referencia	2280032
descripción	junta tórica silicona espesor 1.78mm int.ø 11.11mm UE 1 pzs		
Para modelos:	Appia-2GR-compact		

ø3,53mm

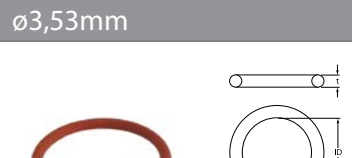

código	527123	referencia	02290020
descripción	junta tórica silicona espesor 3.53mm int.ø 34.52mm UE 1 pzs		
Para modelos:	Caffetteria-Italiana, Master1, Microbar, Oscar		

1			
código	532317	referencia	02290021
descripción	junta tórica silicona espesor 3.53mm int.ø 34.52mm UE 10 pzs		
Para modelos:	Microbar		

Viton			
ø1,78mm			
1			
código	371095	referencia	02290016
descripción	junta tórica Viton espesor 1.78mm int.ø 6.07mm UE 1 pzs		
Para modelos:	2GR-Compact, Appia-1gr, Appia-2-3gr, Appia-2GR, Appia-2GR-compact, Appia-3GR, Aurelia, Aurelia-2GR, Aurelia-3GR, Aurelia-4GR, Beach, Caffetteria-Italiana, MAC2000, MacDigit, Master1, Optima, Oscar, Personal, Premier, Premier5, Program		

ø2,62mm			
1			
código	528291	referencia	02280016
descripción	junta tórica Viton espesor 2.62mm int.ø 11.91mm UE 1 pzs		
Para modelos:	Caffetteria-Italiana		

ø3,53mm			
1			
código	528155	referencia	02280009
descripción	junta tórica Viton espesor 3.53mm int.ø 32.93mm UE 1 pzs		
Para modelos:	Caffetteria-Italiana, Master1		

anillos de junta

juntas de fibra

1			
código	507332	referencia	02060029
descripción	junta plana fibra ø ext. 18mm int.ø 12mm espesor 2mm UE 1 pzs		
Para modelos:	KIARA6		

1			
código	510405	referencia	18010760
descripción	junta plana fibra ø ext. 56mm int.ø 42mm espesor 2mm para rosca 1¼" UE 1 pzs		

juntas de goma

1			
código	507075	referencia	18010936
descripción	junta plana goma ø ext. 15mm int.ø 10mm espesor 2mm UE 1 pzs		
Para modelos:	KIARA6		

1			
código	507078	referencia	18010227 18010750
descripción	junta plana goma ø ext. 25mm int.ø 14.5mm espesor 2.5mm UE 1 pzs		
Para modelos:	KIARA6		

1			
código	507080	referencia	18010371
descripción	junta plana goma ø ext. 39mm int.ø 25mm espesor 1.5mm UE 1 pzs		
Para modelos:	KIARA6		

1			
código	521124	referencia	18000026
descripción	junta plana goma ø ext. 52mm int.ø 42mm espesor 6mm UE 1 pzs		



1

código	507045	referencia	18010150
descripción	junta plana goma ø ext. 78mm int.ø 68mm espesor 3mm UE 1 pzs		
Para modelos:	KIARA6		

juntas de PTFE



1

código	528157	referencia	02060021
descripción	junta plana ø ext. 33.5mm int.ø 24mm espesor 1.5mm		
Para modelos:	MAC2000, MacDigit, Optima, Program		



1

código	526400	referencia	02060021
descripción	junta plana PTFE ø ext. 33mm int.ø 24.5mm espesor 1.5mm UE 1 pzs		



1

código	526402	referencia	02060015
descripción	junta plana PTFE ø ext. 67mm int.ø 54mm espesor 2mm UE 1 pzs		
Para modelos:	Appia-1gr, Appia-2-3gr, Appia-2GR, Appia-3GR, Athena-Leva, Aurelia, Aurelia-2GR, Aurelia-3GR, Aurelia-4GR, MAC2000, MacDigit, Optima, Personal, Premier, Premier5, Program		

juntas de silicona



1

código	507335	referencia	18010029
descripción	junta plana silicona ø ext. 42mm int.ø 29mm espesor 3.5mm UE 1 pzs		
Para modelos:	KIARA6		

juntas especiales

juntas de grupo



1

código	528156	referencia	02060019
descripción	junta de grupo L 102mm An 31mm espesor 3mm fibra para NUOVA SIMONELLI		
Para modelos:	MAC2000, MacDigit, Optima, Program		



1

código	526372	referencia	02060019
descripción	junta de grupo L 92mm An 30mm espesor 2mm dist. del agujero 72mm PTFE		

juntas patra brazos de lavado



1

código	507255	referencia	18010173
descripción	junta D1 ø 45mm D2 ø 85mm espesor 2mm corcho con 4 orificios roscados soporte brazo de lavado núm. Ref. LS02		
Para modelos:	KIARA6		

técnica de accionamiento y rodamientos de bolas

rodamientos de bolas

cojinetes a bolas 2RS



1

código	523509	referencia	15100044
descripción	rodamiento de bolas radial tipo 6201-2RS árbol ø 12mm ø ext. 32mm An 10mm con arandelas de junta cojinete ranurado DIN 625-1		



1

código	523510	referencia	15010034 15100086
descripción	rodamiento de bolas radial tipo 6202-2RS árbol ø 15mm ø ext. 35mm An 11mm con arandelas de junta cojinete ranurado DIN 625-1		





			
1			
código	523504	referencia	08000052
descripción	rodamiento de bolas radial tipo 626-2RS árbol ø 6mm ø ext. 19mm An 6mm con arandelas de junta cojinete ranurado DIN 625-1		



muelles

muelles de torsión

			
1			
código	507027	referencia	18011032
descripción	resorte de torsión ø 17mm L2 38mm espesor de hilo 2mm pos. de montaje derecho L1 10mm L3 70mm UE 1 pzs para puerta		

			
1			
código	507028	referencia	18011031
descripción	resorte de torsión ø 17mm L2 70mm espesor de hilo 2mm pos. de montaje izquierdo L1 10mm L3 38mm para puerta		

			
1			
código	690081	referencia	15320007
descripción	resorte de torsión ø 19.4mm L2 36mm espesor de hilo 3.3mm pos. de montaje izquierdo L1 42mm L3 36mm UE 1 pzs		
accesorios para	690081		
		código	690080
		referencia	15320008
		descripción	resorte de torsión ø 19.4mm L2 37mm espesor de hilo 3.4mm pos. de montaje derecho L1 42mm L3 37mm UE 1 pzs

			
1			
código	690080	referencia	15320008
descripción	resorte de torsión ø 19.4mm L2 37mm espesor de hilo 3.4mm pos. de montaje derecho L1 42mm L3 37mm UE 1 pzs		
accesorios para	690080		
		código	690081
		referencia	15320007
		descripción	resorte de torsión ø 19.4mm L2 36mm espesor de hilo 3.3mm pos. de montaje izquierdo L1 42mm L3 36mm UE 1 pzs

			
1			
código	507029	referencia	18011007
descripción	resorte de torsión pos. de montaje derecho para puerta		

			
1			
código	507030	referencia	18011006
descripción	resorte de torsión pos. de montaje izquierdo para puerta		

resortes de compresión

			
1			
código	528810	referencia	08000005 08000007
descripción	resorte de compresión ø 11.5mm L 25mm espesor de hilo 1.8mm		
Para modelos:	2GR-Compact, Appia-1gr, Appia-2GR, Appia-2GR-compact, Appia-3GR, Aurelia, Aurelia-2GR, Aurelia-3GR, Aurelia-4GR, Beach, Caffetteria-Italiana, MAC2000, MacDigit, Master1, Optima, Oscar, Personal, Premier, Premier5, Program		

			
1			
código	528823	referencia	08000027
descripción	resorte de compresión ø 11.8mm L 16mm espesor de hilo 1.5mm		
Para modelos:	2GR-Compact, Appia-1gr, Appia-2-3gr, Appia-2GR, Appia-2GR-compact, Appia-3GR, Athena-Leva, Aurelia, Aurelia-2GR, Aurelia-3GR, Aurelia-4GR, Caffetteria-Italiana, Oscar, Premier		

		
1		
código	528817	referencia 08000013
descripción	resorte de compresión ø 20,4/15,9mm L 17mm espesor de hilo 1.7mm cónico	
Para modelos:	Caffetteria-Italiana, MAC2000, MacDigit, Master1, Optima, Personal, Premier, Premier5, Program	

		
1		
código	507038	referencia 18010045
descripción	resorte de compresión ø 8.8mm L 31mm espesor de hilo 0.7mm	

		
1		
código	528818	referencia 08000030
descripción	resorte de compresión ø 9.8mm L 15mm espesor de hilo 1.1mm	

resortes de tracción

		
1		
código	507157	referencia 18010932
descripción	muelle de tracción ø 37mm longitud total 875mm espesor de hilo 4.5mm L1 305mm L2 570mm para campana	

manómetros

		
1		
código	541233	referencia 09100003
descripción	manómetro escala doble ø 60mm margen de presión 0-2,5 / 0-15bar empalme lado posterior rosca 1/8"	
Para modelos:	2GR-Compact, Appia-1gr, Appia-2-3gr, Appia-2GR, Appia-2GR-compact, Appia-3GR, Aurelia, Aurelia-2GR, Aurelia-3GR, Aurelia-4GR, Beach, MAC2000, MacDigit, Master1, Optima, Premier, Premier5, Program	

		
1		
código	541410	referencia N/A
descripción	manómetro escala doble ø 60mm margen de presión 0-2,5 / 0-15bar empalme lado posterior rosca 1/8"	

		
1		
código	541222	referencia N/A
descripción	manómetro escala doble ø 60mm margen de presión 0-2,5 / 0-16bar empalme lado posterior rosca 1/8"	

		
1		
código	541226	referencia N/A
descripción	manómetro escala doble ø 60mm margen de presión 0-2,5 / 0-16bar empalme lado posterior rosca 1/8"	

		
1		
código	541227	referencia N/A
descripción	manómetro escala doble ø 60mm margen de presión 0-2,5 / 0-16bar empalme lado posterior rosca 1/8"	

dosificadores

bombas de membrana

autoaspirantes

SEKO

piezas de repuesto





		
1		
código	361304	referencia 02280032
descripción	junta tórica EPDM int.ø 11.11mm espesor 1.78mm UE 1 pzs para tipo DIB3E/DIB5E	
Para modelos:	2GR-Compact, Appia-1gr, Appia-2-3gr, Appia-2GR, Appia-2GR-compact, Appia-3GR, Athena-Leva, Aurelia, Aurelia-2GR, Aurelia-3GR, Aurelia-4GR, Beach, Caffetteria-Italiana, MAC2000, MacDigit, Personal, Premier, Premier5, Program	





autoaspirantes con presión secundaria

OMNIWASH



código	361054	referencia	18010067
descripción	dosificador abrillantador empalme presión ø 6mm conector para succión ø 6mm presión secundaria 10mm		
repuestos para	361054		
	código	361308	referencia 18010066
	descripción	membrana abrillantador empalme presión ømm conector para succión ømm presión secundariamm	
	código	361348	referencia 18010072
	descripción	válvula labial abrillantador empalme presión ømm conector para succión ømm presión secundariamm	
accesorios para	361054		
	código	520252	referencia —
	descripción	tubo de nylon int.ø 6mm ø ext. 8mm L 5m grosor de la pared 1mm p de trabajo 10bar p de reventamiento 50bar T máx 100°C blanco	
	código	520278	referencia —
	descripción	tubo flexible de PVC int.ø 6mm ø ext. 8mm L 2m grosor de la pared 1mm T máx 60°C transparente	

	código	361308	referencia 18010066
	descripción	membrana abrillantador empalme presión ømm conector para succión ømm presión secundariamm	

	código	361348	referencia 18010072
	descripción	válvula labial abrillantador empalme presión ømm conector para succión ømm presión secundariamm	

SEKO

	código	361304	referencia 02280032
	descripción	junta tórica EPDM int.ø 11.1mm espesor 1.78mm UE 1 pzs para tipo DIB3E/DIB5E	
Para modelos:	2GR-Compact, Appia-1gr, Appia-2-3gr, Appia-2GR, Appia-2GR-compact, Appia-3GR, Athena-Leva, Aurelia, Aurelia-2GR, Aurelia-3GR, Aurelia-4GR, Beach, Caffetteria-Italiana, MAC2000, MacDigit, Personal, Premier, Premier5, Program		

accesorios

racores de tubo flexible

metal

	código	361171	referencia 07300362
	descripción	racor tubular recto latón niquelado rosca 1/4" tubo ø 4/6mm UE 1 pzs	
Para modelos:	2GR-Compact, Appia-2-3gr, Appia-2GR, Appia-2GR-compact, Appia-3GR, Microbar, Oscar		

	código	361173	referencia 07300376
	descripción	racor tubular recto latón niquelado rosca 1/8" tubo ø 4/6mm UE 1 pzs	
Para modelos:	Microbar, Oscar		

	código	361182	referencia 18010386
	descripción	tuerca rosca 1/4" H 5mm latón niquelado EC 17 UE 1 pzs	
Para modelos:	KIARA6		

	código	361181	referencia 00300005
	descripción	tuerca rosca 1/8" H 4.5mm latón niquelado EC 14 UE 1 pzs	
Para modelos:	2GR-Compact, Appia-1gr, Appia-2-3gr, Appia-2GR, Appia-2GR-compact, Appia-3GR, Aurelia-2GR, Aurelia-3GR, Aurelia-4GR, MAC2000, Master1, Microbar		



tubos flexibles

tubos flexibles de entrada

tubos flexibles de entrada de PVC



1

código	520010	referencia	18010170
descripción	tubo flexible de entrada PVC recto-curvado DN13 empalmes 3/4" L 1500mm p de trabajo 10bar p de reventamiento 32bar T máx 90°C azul homologación VDE cierre plana		
accesorios para	520010		
	código	520053	referencia —
	filtro empalme 3/4" D1 ø 26mm D2 ø 15mm UE 10 pzs goma espesor 8mm		
	código	520054	referencia —
	junta plana goma ø ext. 23.5mm int.ø 14mm espesor 2.3mm UE 10 pzs		

tubos de salida



1

código	507329	referencia	18010379
descripción	manguera de desagüe DN19 L 1500mm A ø interno 19mm A ø externo 24mm B ø interno 21mm B ø externo 28mm tubo ø ext. 24mm		
Para modelos:	KIARA6		



1

código	507207	referencia	18010155
descripción	manguera de desagüe DN24 L 1500mm A ø interno 24mm A ø externo 28mm B ø interno 24mm B ø externo 28mm tubo ø ext. 28mm		



1

código	507211	referencia	18010156
descripción	manguera de desagüe DN26 L 1500mm A ø interno 33mm A ø externo 40mm B ø interno 32mm B ø externo 40mm tubo ø ext. 35mm		
Para modelos:	KIARA6		

tubos flexibles industriales

tubos Niplaflex



1

código	530562	referencia	18010021
descripción	tubo de presión int.ø 13mm ø ext. 21mm L 5m p de trabajo 10bar p de reventamiento 30bar T máx 110°C		

tubos de presostato



1

código	530560	referencia	18011018
descripción	tubo de presostato int.ø 5mm ø ext. 9mm L 5m p de trabajo 30bar p de reventamiento 90bar resis.a la temp. 60°C		

tubos formados

forma L



1

código	507090	referencia	18010039
descripción	tubo formado sistemas de lavado L-Form núm. Ref. GA18		



1

código	507095	referencia	18010137
descripción	tubo formado sistemas de lavado L-Form núm. Ref. GA38		





1

código	507097	referencia	18010819
descripción	tubo formado sistemas de lavado L-Form núm. Ref. GA538		
Para modelos:	KIARA6		



1

código	507103	referencia	18010739
descripción	tubo formado sistemas de lavado L-Form núm. Ref. GASA8		



1

código	507205	referencia	18010037
descripción	tubo formado sistemas de lavado L-Form núm. Ref. GS120 int. ø tubo 25mm		



1

código	507213	referencia	18010831
descripción	tubo formado sistemas de lavado L-Form núm. Ref. GS520		
Para modelos:	KIARA6		



1

código	507216	referencia	18010829
descripción	tubo formado sistemas de lavado L-Form núm. Ref. GSMPS5		
Para modelos:	KIARA6		

con derivación



1

código	507327	referencia	18010822
descripción	tubo formado sistemas de lavado núm. Ref. GLMSIC4 con derivación		
Para modelos:	KIARA6		

forma S



1

código	507241	referencia	18010740
descripción	tubo formado forma S sistemas de lavado		

otros



1

código	507149	referencia	18010124
descripción	tubo formado sistemas de lavado núm. Ref. GL4T22		

guarniciones, empalmes para mangueras y tubos

empalmes de tubos

sin racor



1

código	504583	referencia	18010749
descripción	pieza Y plástico tubo ø 12-12-12mm		



1

código	507174	referencia	18010825
descripción	pieza T plástico tubo ø 4-4-4mm 3 vías		
Para modelos:	KIARA6MON, KIARA6TRI		

guarniciones

boquillas dobles



1

código	520662	referencia	07300012
descripción	boquilla doble latón rosca 1/4" - 1/4" UE 1 pzs		
Para modelos:	Appia-2-3gr, Appia-2GR, Appia-3GR, Aurelia, Caffetteria-Italiana, MAC2000, MacDigit, Oscar, Premier, Program		



1

código	520682	referencia	07300017
descripción	boquilla doble latón rosca 1/4" - 3/8" UE 1 pzs		
Para modelos:	2GR-Compact, Appia-1gr, Appia-2-3gr, Appia-2GR, Appia-2GR-compact, Appia-3GR, Athena-Leva, Aurelia, Aurelia-2GR, Aurelia-3GR, Aurelia-4GR, Caffetteria-Italiana, Master1, Premier, Premier5		



1

código	520663	referencia	07300015
descripción	boquilla doble latón rosca 3/8" - 3/8" UE 1 pzs		
Para modelos:	Caffetteria-Italiana, MAC2000, Premier, Premier5		

piezas angulares



1

código	531101	referencia	07300068
descripción	pieza angular G1: 3/8" G2: 3/8" L 34mm latón UE 1 pzs		
Para modelos:	2GR-Compact, Appia-1gr, Appia-2-3gr, Appia-2GR, Appia-2GR-compact, Appia-3GR, Athena-Leva, Aurelia, Aurelia-2GR, Aurelia-3GR, Aurelia-4GR, Caffetteria-Italiana, MAC2000, Master1, Premier, Premier5		

piezas T

latón niquelado



1

código	520385	referencia	07300718
descripción	pieza T rosca 1/8" H - 1/8" H - 1/8" H latón niquelado L 35mm		



1

código	520806	referencia	07300209
descripción	pieza T rosca 3/8" M - 3/8" M - 3/8" H latón niquelado L 52.5mm		
Para modelos:	Athena-Leva, MAC2000, Premier, Premier5		



empalmes de tubo

plástico



1			
código	519277	referencia	05000015
descripción	empalme de tubo plástico acodado rosca 1/4" tubo ø 10mm UE 1 pzs		
Para modelos:	Master1		

latón niquelado



1			
código	361171	referencia	07300362
descripción	racor tubular recto latón niquelado rosca 1/4" tubo ø 4/6mm UE 1 pzs		
Para modelos:	2GR-Compact, Appia-2-3gr, Appia-2GR, Appia-2GR-compact, Appia-3GR, Microbar, Oscar		



1			
código	361173	referencia	07300376
descripción	racor tubular recto latón niquelado rosca 1/8" tubo ø 4/6mm UE 1 pzs		
Para modelos:	Microbar, Oscar		

específico del fabricante



1			
código	507061	referencia	18010757
descripción	codo roscado		
Para modelos:	KIARA6		
accesorios para	507061		

	código	507075	referencia	18010936
	descripción	junta plana goma ø ext. 15mm int.ø 10mm espesor 2mm UE 1 pzs		

	código	507330	referencia	—
	descripción	tuerca rosca M10x1 H 7mm EC 13 acero inoxidable UE 1 pzs		

1			
código	507105	referencia	18010461
descripción	distribuidor 4 vías tubo ø 13-13-13-13mm plástico		
Para modelos:	KIARA6		

1			
código	507210	referencia	18010136
descripción	empalme de tubo		
Para modelos:	KIARA6		

1			
código	507194	referencia	18010718
descripción	empalme de tubo rosca 3/8" acodado L 23mm		

componentes para el circuito agua

reductores de presión

reductores de presión

específico del fabricante

1			
código	541185	referencia	01000163
descripción	regulador de presión Metal Work serie Bit MRA empalme 1/4" preajustable margen de ajuste 0-8bar p máx. 13bar T máx 50°C plástico rosca 1/4"		
Para modelos:	Microbar		



material auxiliar

silicona

siliconas para uso alimentario



1

código	890113	referencia	11600003
descripción	silicona S27 para alimentos cartucho 310ml transparente		
descripción	<p>OTTOSEAL S 27 - cartucho 300ml - transparente</p> <p>Se utiliza para el sellado en el sector alimenticio, por ej. en lecherías, carnicerías, fábricas de bebidas y alimentos, cocinas industriales etc. así como entre los revestimientos cerámicos en el sector del agua potable. - Sellador de silicona de 1 componente, reticulación de acetato</p> <p>- Probado para aplicaciones en el sector alimenticio y de agua potable - Buena resistencia química, por ej. a los ácidos y álcalis diluidos - Alta resistencia a la entalladura y al desgarró - Muy buena resistencia a la intemperie, al envejecimiento y a los rayos UV - Aprobado por KTW y DVGW - Resistencia a temperaturas de -40°C a +180°C</p>		
Para modelos:	2GR-Compact, Appia-2-3gr, Appia-2GR-compact, Aurelia, Aurelia-2GR, Aurelia-3GR, Aurelia-4GR		

abrazaderas

abrazaderas de alambre doble



1

código	560344	referencia	18010911
descripción	abrazadera de tubo ø 7-9mm espesor de hilo 1mm UE 1 pzs		

sistemas de medición

termómetros

termómetros incorporados



1

código	541086	referencia	18010767
descripción	termómetro medida de montaje 58x25,5mm 0 a +120°C capilar 2000mm sonda ø 6mm sonda L 23mm		

material de sujeción

tornillos

tornillos de chapa



1

código	560498	referencia	15030055
descripción	tornillo ø 2.2mm L 6.5mm zincado UE 1 pzs soporte Phillips para plástico		

tornillos de cabeza avellanada



1

código	560220	referencia	00300021
descripción	tornillo de cabeza avellanada rosca M6 L 20mm inox DIN 963/ISO 2009 UE 20 pzs soporte ranura ø cabezal 11mm		
Para modelos:	Appia-1gr, Appia-2-3gr, Appia-2GR, Appia-2GR-compact, Appia-3GR, Aurelia, Aurelia-2GR, Aurelia-3GR, Aurelia-4GR, Beach, Optima, Oscar, Premier, Premier5, Program		

tornillos de cabeza plana



1

código	560371	referencia	00000089
descripción	tornillo de cabeza plana rosca M4 rosca L 12mm inox DIN 7985/ISO 7045 UE 1 pzs soporte Phillips ø cabezal 8mm espesor cabezal 3mm		
Para modelos:	Appia-1gr, Appia-2-3gr, Appia-2GR, Appia-2GR-compact, Appia-3GR, Aurelia, Aurelia-2GR, Aurelia-3GR, Aurelia-4GR, Master1		

tuercas hexagonales



1

código	510990	referencia	00000094
descripción	tornillo de cabeza hexagonal rosca M8 rosca L 20mm inox EC 13 UE 1 pzs DIN 933 / ISO 4017		
Para modelos:	Appia-1gr, Appia-2-3gr, Appia-2GR, Appia-3GR, Athena-Leva, Aurelia, Aurelia-2GR, Aurelia-3GR, Aurelia-4GR		



tornillos de cabeza cilíndrica

DIN 912/ISO 4762



1

código	560452	referencia	00000164
descripción	tornillo de cabeza cilíndrica rosca M3 rosca L 16mm L 19mm inox UE 1 pzs DIN 912/ISO 4762		
Para modelos:	Microbar		

tuercas

tuercas hexagonales

DIN 934 / ISO 4032/8673



1

código	517174	referencia	37320800
descripción	tuerca rosca M8 H 6.5mm EC 13 inox DIN/ISO DIN 934 / ISO 4032/8673 UE 1 pzs		



1

código	560129	referencia	00000003
descripción	tuerca hexagonal rosca M5 H 4mm EC 8 inox DIN/ISO DIN 934 / ISO 4032/8673 UE 1 pzs		
Para modelos:	Jazz		

DIN 985



1

código	560141	referencia	00300023
descripción	tuerca hexagonal rosca M5 H 5.4mm inox EC 8 UE 20 pzs DIN/ISO DIN 985 autobloqueo		

tuercas hexagonales pulgadas



1

código	361182	referencia	18010386
descripción	tuerca rosca 1/4" H 5mm latón niquelado EC 17 UE 1 pzs		
Para modelos:	KIARA6		



1

código	361181	referencia	00300005
descripción	tuerca rosca 1/8" H 4.5mm latón niquelado EC 14 UE 1 pzs		
Para modelos:	2GR-Compact, Appia-1gr, Appia-2-3gr, Appia-2GR, Appia-2GR-compact, Appia-3GR, Aurelia-2GR, Aurelia-3GR, Aurelia-4GR, MAC2000, Master1, Microbar		



1

código	520234	referencia	18010648
descripción	tuerca rosca 3/4" H 5mm latón EC 30 UE 1 pzs		
Para modelos:	KIARA6		



1

código	507054	referencia	18010180 18010614
descripción	tuerca rosca 3/8" H 10mm latón EC 20 UE 1 pzs		
Para modelos:	KIARA6		



1

código	507052	referencia	18010648
descripción	tuerca hexagonal rosca 3/4" UE 1 pzs		

arandelas

arandelas

otros



1

código	507114	referencia	18010332
descripción	arandela D1 ø 30mm D2 ø 17mm espesor 3mm		

sujeciones

abrazaderas

abrazaderas de alambre doble



1

código	560344	referencia	18010911
descripción	abrazadera de tubo ø 7-9mm espesor de hilo 1mm UE 1 pzs		

anillos truarc

DIN 6799



1



código	507040	referencia	18010045
descripción	anillo truarc E D1 ø 4mm D2 ø 9mm inox DIN 6799 espesor 0.7mm		



1



código	518557	referencia	08000015
descripción	anillo truarc E D1 ø 5mm D2 ø 11mm inox DIN 6799 espesor 0.7mm		
Para modelos:	2GR-Compact, Appia-1gr, Appia-2GR, Appia-2GR-compact, Appia-3GR, Aurelia, Aurelia-2GR, Aurelia-3GR, Aurelia-4GR, Caffetteria-Italiana, MAC2000, MacDigit, Master1, Microbar, Personal, Premier, Premier5, Program		

consumibles

sellantes y pegamentos

siliconas para uso alimentario



1

código	890113	referencia	11600003
descripción	silicona S27 para alimentos cartucho 310ml transparente		
descripción	<p>OTTOSEAL S 27 - cartucho 300ml - transparente</p> <p>Se utiliza para el sellado en el sector alimenticio, por ej. en lecherías, carnicerías, fábricas de bebidas y alimentos, cocinas industriales etc. así como entre los revestimientos cerámicos en el sector del agua potable. - Sellador de silicona de 1 componente, reticulación de acetato</p> <p>- Probado para aplicaciones en el sector alimenticio y de agua potable - Buena resistencia química, por ej. a los ácidos y álcalis diluidos - Alta resistencia a la entalladura y al desgarro - Muy buena resistencia a la intemperie, al envejecimiento y a los rayos UV - Aprobado por KTW y DVGW - Resistencia a temperaturas de -40°C a +180°C</p>		
Para modelos:	2GR-Compact, Appia-2-3gr, Appia-2GR-compact, Aurelia, Aurelia-2GR, Aurelia-3GR, Aurelia-4GR		

detergentes

limpiadores para batidores de leche



1

código	802111	referencia	13200012
descripción	limpiadores para batidores de leche botella PULY MILK Plus homologación NSF 1000ml		

fusibles

fusibles finos

ø10x38mm 500V



1

código	358022	referencia	16300112
descripción	fusible fino medida ø10x38mm 4A nominal 500V tipo Gg rápido UE 1 pzs		

fusibles térmicos



1

código	358012	referencia	09500014
descripción	fusible térmico temp. desconexión 167°C nominalA longitud del cable 160mm		
Para modelos:	Appia-2GR-compact, Oscar		

A

abrazaderas	70, 72
abrazaderas de alambre doble	70, 72
accesorios eléctricos	34
anillos de junta	61
anillos truarco	72
aparatos de mando y aviso	14
arandelas	71

B

bombas	31
bombas de aumento de presión II	32
bombas de lavado y aclarado	31
bombas de salida	32
bombas de vibración	33
boquillas dobles	68

C

cables	35
cables de PVC	35
cartuchos calentadores	5
componentes para el circuito agua	69
condensadores de servicio	34
condensadores y filtros antiparasitarios	34
conectores - acoplamientos - enchufes	34
conmutadores giratorios	13
consumibles	72
contactores	16

D

detergentes	72
dosificadores	64

E

electródos	30
electroimanes	35
empalmes de tubo	69
empalmes de tubos	68

F

filtros	34
flujómetros	30
fusibles	34, 72
fusibles finos	72
fusibles térmicos	72

G

guarniciones	68
--------------	----

I

interruptores de flotador	12
interruptores de sistema ROLD	12

interruptores magnéticos	13
interruptores pulsantes y pulsadores	10
interruptores y pulsadores	9
interruptores/pulsadores basculantes	9

J

juntas patra brazos de lavado	62
juntas tóricas	58

L

lámparas	14
lámparas de señalización	14
lámparas de señalización completas	14
LEDs	15
limpiadores para batidores de leche	72

M

material de sujeción	70
microinterruptores	11
motores	31

P

presostatos	29
-------------	----

R

racores de tubo flexible	65
reductores de presión	69, 69
relés	16
relés de temporización	18
resistencias	3
resistencias de inmersión	5
resistencias de máquinas de café	3
resistencias para grill de contacto	5
ruedas para aparatos y esquinas protectoras	57

S

sellantes y pegamentos	72
sensores	18
silicona	70, 72
siliconas para uso alimentario	70, 72
sistemas de medición	70
sujeciones	72

T

temporizadores	15
temporizadores de programa	15
terminales	35
termostatos	8
termostatos de regulación	9
termostatos de superficie	8
termostatos de superficie de seguridad	8
tornillos	70
tornillos de cabeza avellanada	70

tornillos de cabeza cilíndrica	71
tornillos de cabeza plana	70
tornillos de chapa	70
transformadores	18
tubos de presostato	66
tubos de salida	66
tubos flexibles	66
tubos flexibles de entrada	66
tubos flexibles de entrada de PVC	66
tubos flexibles industriales	66
tubos formados	66
tubos Niplaflex	66
tuercas	71
tuercas hexagonales	70, 71

V

válvulas magnéticas	25
---------------------	----