



GAS



ELEKTRO



WASSER



MECHANIK



WERKZEUG

Ersatzteile passend für

SAECO

Das komplette Sortiment finden Sie immer aktuell im GEV-Webshop

Hersteller-Kataloge

Für jeden Hersteller die wichtigsten Ersatz- und Zubehörteile übersichtlich zusammengestellt



- ✓ **Komplettes Sortiment und alle Gerätedaten immer aktuell im GEV-Webshop**
- ✓ **Alphabetischer Index am Ende des Katalog**

GEV-Webshop

www.gev-online.de

www.gev-online.ch



- 🔍 Artikel als Favoriten markieren
- 🔍 Einloggen mit E-Mail-Adresse und gewohntem Passwort
- 🔍 Komfort-Bestellung – mehrere Artikel gleichzeitig in den Warenkorb legen
- 🔍 Sofort Artikel suchen ohne Anmeldung



Heizkörper



Heizkörper für Kaffeemaschinen

 <p>1</p>			
GEV-Nr.	526625	Vergl.-Nr.	11003362
Beschreibung	Heizkörper 4370/4760W 220/240V HK 3 Einbau ø 40mm LA 51mm L 315mm B 33mm H 33mm Loch ø 9mm THL 140mm TH ø 6.5mm THA 1 THP mittig, nicht-anliegend Rohr ø 8mm Anschluss Flachstecker 6,3mm Tauchheizkörper Kupfer		

Thermostate

Anlegethermostate

Anlege-Sicherheitsthermostate

 <p>1</p>			
GEV-Nr.	390369	Vergl.-Nr.	189427500 189428200 189428600 189428700
Beschreibung	Sicherheits-Anlegethermostat Lamm Abschalttemp. 175°C 1NC 1-polig 16A Anschluss F6,3		
Zubehör für	390369		
 <p>GEV-Nr. 504736 Vergl.-Nr. — Halter für Anlegethermostat</p>			

Pumpen

Vibrationspumpen

 <p>Bild nicht vorhanden</p> <p>1</p>			
GEV-Nr.	501516	Vergl.-Nr.	11000122 9070.042.00A
Beschreibung	Vibrationspumpe Typ EX5GW 230V 48W 50Hz Eingang ø 6 Ausgang ø 1/8" ULKA		

Gerätespezifische Bauteile

für Kaffeemühlen

Mahlscheiben

Mahlscheiben gerade

Standard

 <p>1</p>			
GEV-Nr.	527243	Vergl.-Nr.	N/A
Beschreibung	Mahlscheibenpaar Drehrichtung links D1 ø 43mm ID ø 25mm H 7mm Zahnabstand 3mm Loch ø 3.2mm Bohrung ø 6mm Befestigung ø 35 passend für SAECO		

Mahlscheiben konisch

 <p>1</p>			
GEV-Nr.	527248	Vergl.-Nr.	N/A old model
Beschreibung	Mahlscheibenpaar Drehrichtung rechts D1 ø 40mm D2 ø 32mm H 20mm Achse ø 10mm mit Nut passend für SAECO		

 <p>Bild nicht vorhanden</p> <p>1</p>			
GEV-Nr.	531196	Vergl.-Nr.	226473500 226477700 9141.039 9141.040
Beschreibung	Mahlscheibenpaar Drehrichtung rechts D1 ø 40mm D2 ø 32mm H 20mm Achse ø 10mm passend für SAECO		

für Kaffevollautomaten

Sonstige

 <p>1</p>			
GEV-Nr.	650243	Vergl.-Nr.	144650300 NV99001
Beschreibung	Wasserfilter ø 6mm L 60mm		



Dichtungen

O-Ringe

EPDM

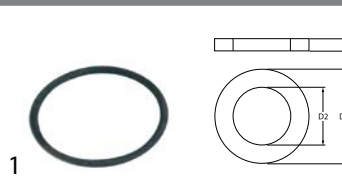

1

GEV-Nr.	532017	Vergl.-Nr.	NM02.030
Beschreibung	O-Ring EPDM Materialstärke 1.78mm ID ø 26.7mm VPE 10 Stück		

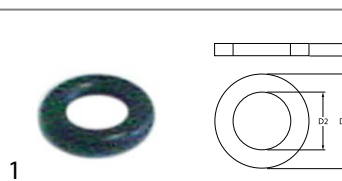

1

GEV-Nr.	532003	Vergl.-Nr.	NM02.028
Beschreibung	O-Ring EPDM Materialstärke 1.78mm ID ø 3.69mm VPE 10 Stück		

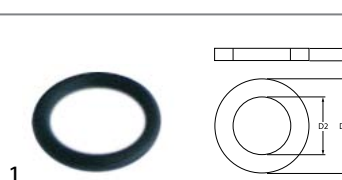

1

GEV-Nr.	510902	Vergl.-Nr.	NM02.012
Beschreibung	O-Ring EPDM Materialstärke 2mm ID ø 9.5mm VPE 1 Stück		

Silikon

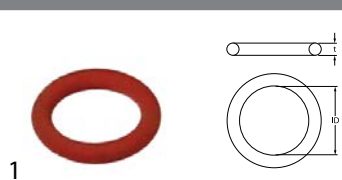

1

GEV-Nr.	532190	Vergl.-Nr.	140321462 NM01.003
Beschreibung	O-Ring Silikon Materialstärke 1.78mm ID ø 4.48mm VPE 10 Stück		



1

GEV-Nr.	532716	Vergl.-Nr.	NM01.057
Beschreibung	O-Ring Silikon Materialstärke 2mm ID ø 5mm VPE 10 Stück		



1

GEV-Nr.	532715	Vergl.-Nr.	140320459 NM01.008
Beschreibung	O-Ring Silikon Materialstärke 2mm ID ø 8mm VPE 10 Stück		

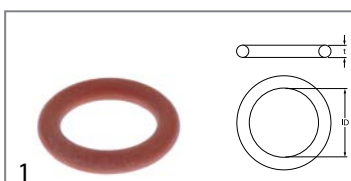

1

GEV-Nr.	532717	Vergl.-Nr.	140320762 NM01.035
Beschreibung	O-Ring Silikon Materialstärke 2mm ID ø 9mm VPE 10 Stück		

Manometer



1

GEV-Nr.	541715	Vergl.-Nr.	5024005000
Beschreibung	Manometer ø 41mm Druckbereich 0-3bar Gewinde 1/4" Markierung 1,8-3 Kapillarrohr 430mm		

Hilfsmittel

Schellen

Einohrklemmen



1

GEV-Nr.	520752	Vergl.-Nr.	12000361 12000892
Beschreibung	Einohrklemme ø 7,8-9,5mm Breite 5mm Bandstärke 0.6mm VPE 20 Stück CNS W4		

Befestigungsmaterialien

Befestigungen

Schellen

Einohrklemmen



1

GEV-Nr.	520752	Vergl.-Nr.	12000361 12000892
Beschreibung	Einohrklemme ø 7,8-9,5mm Breite 5mm Bandstärke 0.6mm VPE 20 Stück CNS W4		

A

Anlege-Sicherheitsthermostate	3
Anlegethermostate	3

B

Befestigungen	4
Befestigungsmaterialien	4

E

Einohrklemmen	4, 4
---------------	------

H

Heizkörper	3
Heizkörper für Kaffeemaschinen	3

O

O-Ringe	4
---------	---

P

Pumpen	3
--------	---

S

Schellen	4, 4
----------	------

T

Thermostate	3
-------------	---

V

Vibrationspumpen	3
------------------	---