



COMPONENTES GAS



COMPONENTES ELÉCTRICOS



TECNOLOGÍA DEL AGUA



COMPONENTES MECÁNICOS



HERRAMIENTAS

Repuestos adaptables a

SILKO

Encuentre nuestra gama siempre actualizada en la tienda online de GEV



Catálogo de fabricantes

Las piezas de repuesto y accesorios más importantes de cada fabricante reunidas y ordenadas de manera práctica

- ✓ En la tienda online GEV encontrará el surtido completo y toda la información actualizada de máquinas y aparatos
- ✓ Índice alfabético al final del catálogo

Tienda online GEV

www.gev-online.es
www.gev-online.com



- 🔍 marcar artículos como favoritos
- 🔍 acceso mediante su e-mail y su contraseña habitual
- 🔍 ponga en la cesta de la compra, múltiples artículos a la vez
- 🔍 búsqueda de artículos inmediata sin necesidad conectarse

resistencias

resistencias para hornos

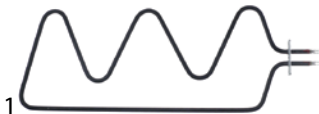

código	420111	referencia	CR0681390
descripción	resistencia 1500W 230V espirales 1 L 555mm An 210mm L1 70mm L2 485mm B1 88mm B2 33mm longitud brida 70mm anchura brida 22mm dist. del agujero 56mm agujero ø 5mm tubo ø 8,5mm empalme conector Faston 6,3mm longitud de empalme 17mm espirales 3 brida de empalme resistencia seca para horno		
Para modelos:	ECE7-E, ECE94E, ECG94E, ECG96E, ECV94E		

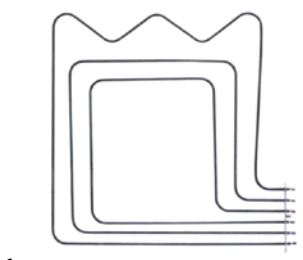

código	415131	referencia	0101506 SIR0101506
descripción	resistencia 2500W 240V L 515mm An 512mm L1 55mm L2 460mm B1 386mm B2 126mm longitud brida 160mm anchura brida 22mm dist. del agujero 144mm agujero ø 6mm tubo ø 6.3mm empalme conector Faston 6,3mm espirales 3 brida rectangular		

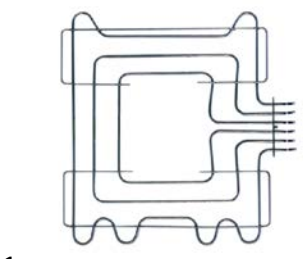

código	415252	referencia	0101505 SIR0101505
descripción	resistencia 2750W 230/400V espirales 3 L 529mm An 620mm L1 30mm L2 499mm B1 247mm B2 127mm longitud brida 160mm anchura brida 22mm dist. del agujero 145mm agujero ø 7mm tubo ø 6.3mm empalme M4 brida rectangular resistencia seca		
Para modelos:	CCG9046P, CCG90662P, CCG9146, CCG9146-1, CCG91662, CCG91662-1, CCG91663, CCG91663-1, CCQ9046, CCQ9046V, CCQ90663, CE94EPQ, CFS9060, CFS9062, CFS9066, CG94EPS, CG96EPS, CTE9146, CTT9046, CTT90663R, CV94EPS, HE94EPS, HEY4EPS, TE94EPS, TG94EPS		

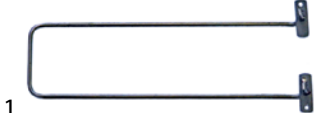

código	415341	referencia	0101556 SIR0101556
descripción	resistencia 735W 230V L 387mm An 108mm H 25mm longitud de lengüeta 55mm anchura de lengüeta 29mm dist. del agujero 140mm agujero ø 5mm tubo ø 6.3mm longitud de empalme 30mm empalme M4 espirales 1 resistencia seca lengüeta de sujeción		
Para modelos:	CCG60652, CCG60653, CCT6046		



código	415395	referencia	0101553 SIR0101553
descripción	resistencia 800W 240V L 540mm An 60mm longitud brida 100mm anchura brida 22mm dist. del agujero 85mm tubo ø 6.3mm longitud de empalme 10mm espirales 1 agujero ø 5mm empalme conector Faston 6,3mm brida rectangular resistencia seca		

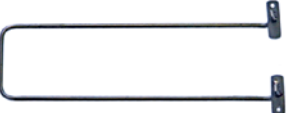

código	415294	referencia	0101554 SIR0101554 SIR0101554
descripción	resistencia 900W 230V L 468mm An 112mm H 23mm longitud de lengüeta 60mm anchura de lengüeta 20mm dist. del agujero 153mm agujero ø 6mm tubo ø 6.3mm espirales 1 resistencia seca espirales 1 brida rectangular horno		
Para modelos:	CCG7046, CCG7046P, CCG70662P, CCG70663, CCG7246, CCG72662, CCG72663, CCQ7046, CCQ70663, CCT7046, CCT70663, CCT7246V, CE84EPQ, CG74EPS, CG76EPS, CG84EPS, CV74EPS, FORNO-ELETRICO-700, FORNO-ELETRICO-809		



resistencias para baño maría









código	415091	referencia	1037039513 MA1037039513	
descripción	resistencia 1000W 230V espirales 1 L 295mm An 85mm longitud de empalme 20mm empalme M3 tubo ø 6.5mm sujeción 2 orificios rosca M14x1 resistencia de inmersión/seca bañomaria/calienta patatas L1 145mm L2 150mm H 18mm distancia de sujeción 79mm			
Para modelos:	CCW6220, CME6220, CME6230, CME6240, CSP6220, CW62TPS, ERP72, ME62TPS, ME63TPS, ME64TPS, RP62TPS			
repuestos para	415091			
	código	510417	referencia	—
		junta plana fibra ø ext. 20mm int.ø 14mm espesor 2mm UE 1 pzs		
accesorios para	415091			
	código	520228	referencia	—
		arandela dentada int.ø 15.3mm ø ext. 24mm acero UE 1 pzs para rosca M14		
	código	521133	referencia	—
		tuerca rosca M14x1,5 H 6mm EC 19 acero zincado UE 1 pzs		
	código	527169	referencia	—
		tuerca hexagonal rosca M3 H 2.8mm EC 5.5 latón UE 1 pzs		
	código	550261	referencia	—
		tuerca rosca M14x1 H 4mm EC 19 inox UE 1 pzs		
	código	550262	referencia	—
		junta plana cobre ø ext. 20mm int.ø 14mm espesor 2mm		

Continúa en la página siguiente





accesorios para	415091			
	código	560110	referencia	—
	arandela int.ø 3.2mm ø ext. 7mm espesor 0.5mm inox UE 20 pzs DIN 125A para rosca M3			
	código	560130	referencia	—
	tuerca hexagonal rosca M3 H 2.4mm EC 5.5 inox DIN/ISO DIN 934 / ISO 4032/8673 UE 20 pzs			

				
código	415130	referencia	0109060 SIR0109060	
descripción	resistencia 1500W 230V espirales 1 L 412mm An 50mm empalme M3 tubo ø 8.5mm sujeción 2 orificios rosca 3/8" resistencia de inmersión distancia de sujeción 42mm			
Para modelos:	CCW6020, CME6020, CME6040, CME7020, CME7220, ME72TPS			
accesorios para	415130			
	código	361183	referencia	—
	tuerca rosca 3/8" H 6mm latón niquelado EC 20 UE 1 pzs			
	código	521137	referencia	—
	junta plana fibra ø ext. 20mm int.ø 18mm espesor 1.5mm para rosca 3/8" UE 1 pzs			
	código	527169	referencia	—
	tuerca hexagonal rosca M3 H 2.8mm EC 5.5 latón UE 1 pzs			
	código	560110	referencia	—
	arandela int.ø 3.2mm ø ext. 7mm espesor 0.5mm inox UE 20 pzs DIN 125A para rosca M3			
	código	560130	referencia	—
	tuerca hexagonal rosca M3 H 2.4mm EC 5.5 inox DIN/ISO DIN 934 / ISO 4032/8673 UE 20 pzs			

				
código	415992	referencia	1634200 MA1634200	
descripción	resistencia 1800W 230V espirales 1 L 495mm An 90mm longitud brida 124mm anchura brida 30mm dist. del agujero 108mm longitud de empalme 33mm empalme M5 tubo ø 10mm brida rectangular agujero ø 4mm resistencia seca baño maría			
Para modelos:	EME7, EME92A, EME92G, EME92T, EME94A, EME94G, EME94T			

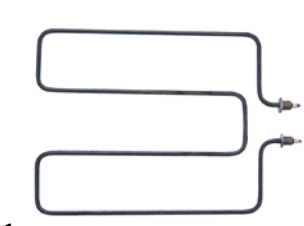
				
código	415143	referencia	0101530 SIR0101530	
descripción	resistencia 2000W 230V espirales 1 L 436mm An 33mm empalme M5 tubo ø 8.5mm brida de expansión resistencia de inmersión brida 40x16mm			



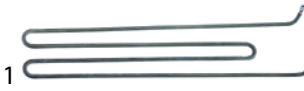

				
código	415844	referencia	0109061 SIR0109061	
descripción	resistencia 2600W 230V espirales 1 L 410mm An 300mm longitud de empalme 10mm empalme M4 tubo ø 8.5mm sujeción 2 orificios rosca 3/8" resistencia de inmersión L1 27mm L2 383mm B1 120mm B2 60mm distancia de sujeción 50mm			
Para modelos:	CME6030			
repuestos para	415844			
	código	521137	referencia	—
	junta plana fibra ø ext. 20mm int.ø 18mm espesor 1.5mm para rosca 3/8" UE 1 pzs			
accesorios para	415844			
	código	361183	referencia	—
	tuerca rosca 3/8" H 6mm latón niquelado EC 20 UE 1 pzs			

resistencias para sartenes

				
código	416698	referencia	1037317700 MA1037317700	
descripción	resistencia 1350W 230V L 460mm An 95mm empalme M4 tubo ø 6.3mm resistencia seca plancha multiuso H 40mm distancia de empalme 89mm			
Para modelos:	CM72APS, CM82APS, ECM73, ECM93A			

resistencias para calentadores de patatas



				
código	416832	referencia	0109049 SIR0109049 SIR0109049	
descripción	resistencia 650W 230V espirales 1 L 276mm An 73mm longitud brida 115mm anchura brida 25mm dist. del agujero 98mm longitud de empalme 24mm empalme conector Faston 6,3mm tubo ø 8.5mm brida rectangular agujero ø 5mm resistencia seca			
Para modelos:	CS654, CSP6020, CSP7020, RP72TPS			

			
código	415091	referencia	1037039513 MA1037039513
descripción	resistencia 1000W 230V espirales 1 L 295mm An 85mm longitud de empalme 20mm empalme M3 tubo ø 6.5mm sujeción 2 orificios rosca M14x1 resistencia de inmersión/seca bañomaria/calienta patatas L1 145mm L2 150mm H 18mm distancia de sujeción 79mm		
Para modelos:	CCW6220, CME6220, CME6230, CME6240, CSP6220, CW62TPS, ERP72, ME62TPS, ME63TPS, ME64TPS, RP62TPS		
accesorios para	415091		
	código	520228	referencia —
	arandela dentada int.ø 15.3mm ø ext. 24mm acero UE 1 pzs para rosca M14		
	código	521133	referencia —
	tuerca rosca M14x1,5 H 6mm EC 19 acero zincado UE 1 pzs		
	código	527169	referencia —
	tuerca hexagonal rosca M3 H 2.8mm EC 5.5 latón UE 1 pzs		
	código	550261	referencia —
	tuerca rosca M14x1 H 4mm EC 19 inox UE 1 pzs		
	código	550262	referencia —
	junta plana cobre ø ext. 20mm int.ø 14mm espesor 2mm		
	código	560110	referencia —
	arandela int.ø 3.2mm ø ext. 7mm espesor 0.5mm inox UE 20 pzs DIN 125A para rosca M3		
	código	560130	referencia —
	tuerca hexagonal rosca M3 H 2.4mm EC 5.5 inox DIN/ISO DIN 934 / ISO 4032/8673 UE 20 pzs		

resistencias para freidora

empalme en el borde

con rosca

			
código	416813	referencia	0105154
descripción	resistencia 10500W 230/400V espirales 3 pos. de montaje derecho L 320mm An 240mm H 32mm longitud pletina 21mm longitud pletina 1 2mm longitud pletina 2 19mm pletina ø2 63mm pletina ø2 57.5mm racor termostato 2x M10x1 casquillo termostato arriba/abajo L1 20mm L2 300mm B1 204mm B2 33mm rosca M54x1,5 espirales 5 tubo ø 8.5mm longitud del cable 460mm brida giratoria freidora freidora longitud de empalme 90mm 2		
Para modelos:	FE72112, FE74212		
accesorios para	416813		
	código	550449	referencia —
	llave especial para tuerca anillo		
	código	550496	referencia 0105021 CM099200 MACM099200 SIR0105021
	junta tórica Viton espesor 3.53mm int.ø 50.39mm UE 1 pzs		

accesorios para	416813		
	código	550662	referencia 0105152 0108054 0108738 CM021600 MACM021600 SIR0108054 SIR0108738
	tuerca anillo rosca M54x1,5 H 7mm		

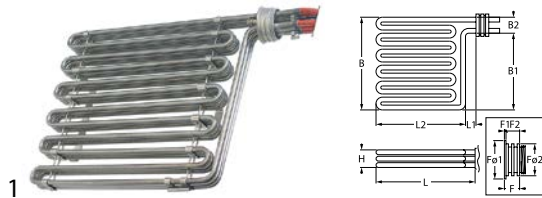
			
código	416814	referencia	0105151 CM032401 CM032401R MACM032401 MACM032401R SIR0105151

descripción	resistencia 16500W 230/400V espirales 3 pos. de montaje derecho L 400mm An 315mm H 36mm longitud pletina 23mm longitud pletina 1 2mm longitud pletina 2 21mm pletina ø2 63mm pletina ø2 57.5mm racor termostato 2x M10x1 casquillo termostato descentrado L1 15mm L2 378mm B1 282mm B2 33mm rosca M54x1,5 espirales 6 para O.R ø 50.39mm tubo ø 8.5mm longitud del cable 280mm empalme cable brida giratoria resistencia de inmersión freidora longitud de empalme 75mm 2		
Para modelos:	FE82118, FE82T18, FE84218, FE84T18, FE92118, FE94218, FEY2118, FEY4218		

accesorios para	416814		
	código	106605	referencia 0105033 CM012401 MACM012401 SIR0105033
	tornillo de racor rosca M10x1 sonda ø máx. 4.5mm		

	código	528687	referencia 0105034 CM097900 MACM097900 SIR0105034
	junta tórica Viton espesor 1.78mm int.ø 3.69mm UE 1 pzs		

	código	550496	referencia 0105021 CM099200 MACM099200 SIR0105021
	junta tórica Viton espesor 3.53mm int.ø 50.39mm UE 1 pzs		

	código	550662	referencia 0105152 0108054 0108738 CM021600 MACM021600 SIR0108054 SIR0108738
	tuerca anillo rosca M54x1,5 H 7mm		



empalme excéntrico

con rosca

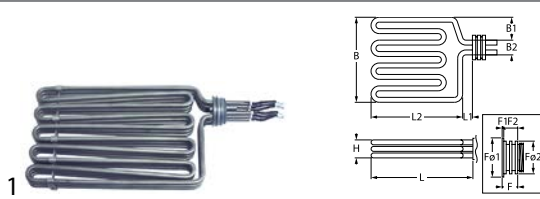

código	416070	referencia	0108057 SIR0108057
---------------	--------	-------------------	-----------------------

descripción resistencia 10200W 230/400V espirales 3 L 300mm An 180mm H 33mm longitud pletina 19.5mm longitud pletina 1 9.5mm longitud pletina 2 9.8mm pletina ø2 62mm pletina ø2 57mm ø casquillo portasondas 6.5mm racor termostato 2x M10x1 casquillo termostato arriba/abajo L1 18mm L2 282mm B1 30mm B2 35mm rosca M54x1,5 espirales 5 tubo ø 8.5mm longitud del cable 450mm brida giratoria resistencia de inmersión freidora longitud de empalme 130mm 2

Para modelos: CFE70115, CFE70115-2, CFE70115-M, CFE70215, CFE70215-2, CFE70215-M

repuestos para 416070

código	510243	referencia	—
---------------	--------	-------------------	---



junta tórica Viton espesor 3.53mm int.ø 55.56mm UE 1 pzs

código	550496	referencia	0105021 CM099200 MACM099200 SIR0105021
---------------	--------	-------------------	---



junta tórica Viton espesor 3.53mm int.ø 50.39mm UE 1 pzs

accesorios para 416070

código	510243	referencia	—
---------------	--------	-------------------	---



junta tórica Viton espesor 3.53mm int.ø 55.56mm UE 1 pzs

código	550662	referencia	0105152 0108054 0108738 CM021600 MACM021600 SIR0108054 SIR0108738
---------------	--------	-------------------	---



tuerca anillo rosca M54x1,5 H 7mm

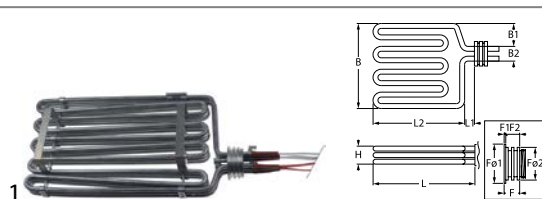

código	420113	referencia	CR0583860 CR0583860R
---------------	--------	-------------------	-------------------------

descripción resistencia 12000W 230V espirales 3 L 385mm An 205mm H 32mm longitud pletina 21mm longitud pletina 1 2mm longitud pletina 2 19mm pletina ø2 63mm pletina ø2 54mm racor termostato 2x M10x1 casquillo termostato arriba/abajo L1 20mm L2 365mm B1 45mm B2 32mm rosca M54x1,5 tubo ø 8.5mm longitud del cable 300mm brida giratoria resistencia de inmersión con alojamiento sonda ø 4mm para freidora

Para modelos: EFE72115, EFE74215, EFE92115, EFE94215

accesorios para 420113

código	532681	referencia	CR0582140
---------------	--------	-------------------	-----------



junta tórica Viton espesor 3.53mm int.ø 66.27mm UE 1 pzs

código	550496	referencia	0105021 CM099200 MACM099200 SIR0105021
---------------	--------	-------------------	---



junta tórica Viton espesor 3.53mm int.ø 50.39mm UE 1 pzs

accesorios para 420113

código	550662	referencia	0105152 0108054 0108738 CM021600 MACM021600 SIR0108054 SIR0108738
---------------	--------	-------------------	---



tuerca anillo rosca M54x1,5 H 7mm

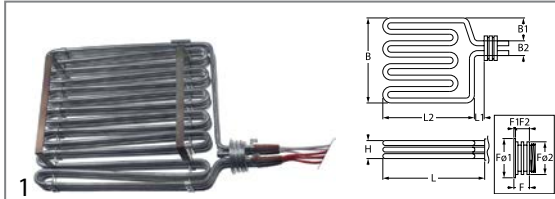

código	420112	referencia	CR0583740 CR0583740R
---------------	--------	-------------------	-------------------------

descripción resistencia 18000W 400V espirales 3 L 387mm An 305mm H 34mm longitud pletina 21mm longitud pletina 1 2.5mm longitud pletina 2 18.5mm pletina ø2 63mm pletina ø2 54mm racor termostato 2x M10x1 casquillo termostato arriba/abajo L1 25mm L2 362mm B1 45mm B2 32mm rosca M54x1,5 tubo ø 8.5mm longitud del cable 350mm brida giratoria resistencia de inmersión con alojamiento sonda ø 4mm para freidora

Para modelos: EFE92122, EFE92122K, EFE94222, EFE94222K

accesorios para 420112

código	550496	referencia	0105021 CM099200 MACM099200 SIR0105021
---------------	--------	-------------------	---



junta tórica Viton espesor 3.53mm int.ø 50.39mm UE 1 pzs

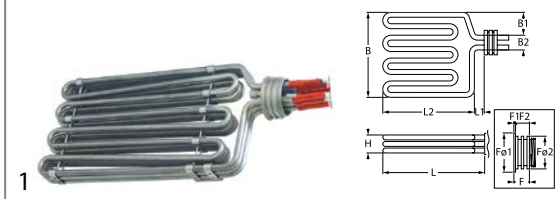

código	416812	referencia	1037316601 1037316601R MA1037316601 MA1037316601R
---------------	--------	-------------------	--

descripción resistencia 9000W 230/400V espirales 3 pos. de montaje derecho L 360mm An 170mm H 35mm longitud pletina 21mm longitud pletina 1 2mm longitud pletina 2 19mm pletina ø2 63mm pletina ø2 57.5mm ø casquillo portasondas 6.5mm racor termostato 2x M10x1 casquillo termostato arriba/abajo L1 25mm L2 335mm B1 40mm B2 33mm rosca M54x1,5 tubo ø 8.7mm longitud del cable 250mm brida giratoria resistencia de inmersión con alojamiento sonda ø 4mm freidora código 3000 2

Para modelos: EFE72110, EFE73210, EFE93210, FE72T10, FE74T10

accesorios para 416812

código	550496	referencia	0105021 CM099200 MACM099200 SIR0105021
---------------	--------	-------------------	---



junta tórica Viton espesor 3.53mm int.ø 50.39mm UE 1 pzs

código	550662	referencia	0105152 0108054 0108738 CM021600 MACM021600 SIR0108054 SIR0108738
---------------	--------	-------------------	---



tuerca anillo rosca M54x1,5 H 7mm

empalme centrado

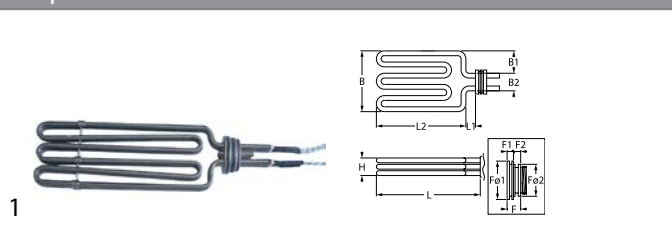

código	415297	referencia	0108058 BN4185326002136 SI0108058 SIR0108058
descripción	resistencia 6800W 230/400V espirales 3 L 299mm An 107mm H 35mm longitud pletina 19.5mm longitud pletina 1 9.5mm longitud pletina 2 9.8mm pletina ø2 62mm pletina ø2 57mm ø casquillo portasondas 8.5mm racor termostato 2x M10x1 casquillo termostato arriba/abajo L1 16mm L2 283mm B1 30mm B2 77mm rosca M54x1,5 tubo ø 8.5mm longitud del cable 450mm brida giratoria resistencia de inmersión		
Para modelos:	CFE70110, CFE70110-2, CFE70210, CFE70210-2, CFE70210-M, CFE72210, CFE72215, CFE90210, CFE90210-2, FE72210, FE92210		
accesorios para	415297		
	código	510243	referencia —
	junta tórica Viton espesor 3.53mm int.ø 55.56mm UE 1 pzs		
	código	510245	referencia 0108055 SIR0108055
	junta tórica Viton espesor 3.53mm int.ø 50.8mm UE 1 pzs		
	código	550447	referencia —
	tuerca anillo rosca M54x1,5		

sujeción 2 orificios

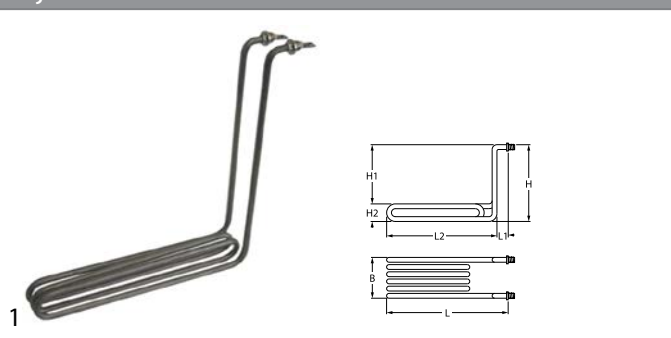

código	415207	referencia	0108020 SIR0108020
descripción	resistencia 2185W 230V espirales 1 L 325mm An 35mm H 320mm L1 29mm L2 292mm H1 275mm H2 42mm rosca 1/4" distancia de sujeción 27mm tubo ø 8.5mm sujeción 2 orificios empalme M5 longitud de empalme 22mm resistencia para freidora espirales 3		
accesorios para	415207		
	código	361182	referencia —
	tuerca rosca 1/4" H 5mm latón níquelado EC 17 UE 1 pzs		
	código	510417	referencia —
	junta plana fibra ø ext. 20mm int.ø 14mm espesor 2mm UE 1 pzs		
	código	520228	referencia —
	arandela dentada int.ø 15.3mm ø ext. 24mm acero UE 1 pzs para rosca M14		
	código	550262	referencia —
	junta plana cobre ø ext. 20mm int.ø 14mm espesor 2mm		

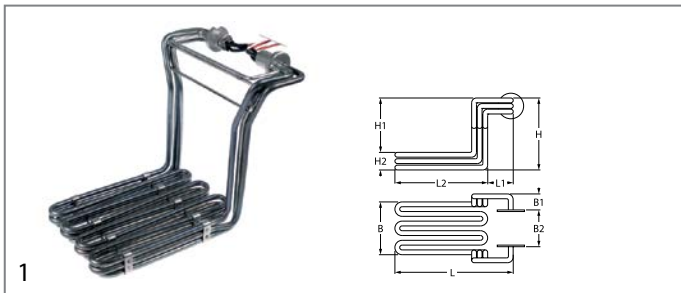



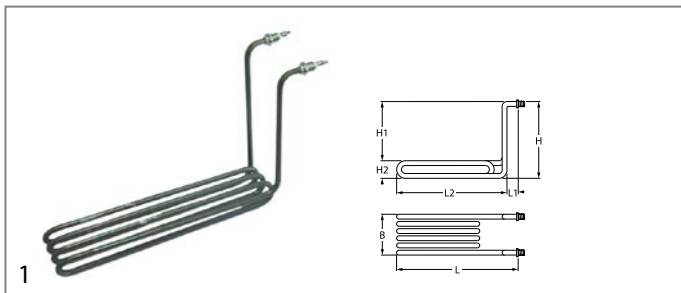

código	415257	referencia	0109025 SIR0109025
descripción	resistencia 6000W 230/400V espirales 3 L 300mm An 182mm H 252mm L1 65mm L2 235mm B1 59mm B2 134mm B3 250mm H1 220mm H2 32mm espirales 12 brida ø 40mm brida orientable longitud del cable 380mm resistencia para freidora montaje ø 25mm		
Para modelos:	CFE60110, CFE60210, CFE70110-0, CFE72110-0, FE72T10		





código	416055	referencia	0109021 SIR0109021
descripción	resistencia 3000W 230V espirales 1 L 335mm An 65mm H 223mm L1 20mm L2 315mm H1 180mm H2 40mm rosca 1/4" distancia de sujeción 57mm tubo ø 8.5mm sujeción 2 orificios empalme M4 longitud de empalme 26mm resistencia de inmersión espirales 4		
Para modelos:	CFE60110-5, CFE60110-9, CFE60210-5, CFE60210-9		
accesorios para	416055		
	código	361182	referencia —
	tuerca rosca 1/4" H 5mm latón níquelado EC 17 UE 1 pzs		
	código	510417	referencia —
	junta plana fibra ø ext. 20mm int.ø 14mm espesor 2mm UE 1 pzs		
	código	520228	referencia —
	arandela dentada int.ø 15.3mm ø ext. 24mm acero UE 1 pzs para rosca M14		
	código	521103	referencia —
	tuerca rosca M4 H 3mm EC 7 latón UE 20 pzs		

Continúa en la página siguiente













accesorios para	416055		
	código	521104	referencia —
	arandela int.ø 4.3mm ø ext. 8mm espesor 0.5mm latón UE 20 pzs para rosca M4		
	código	550262	referencia —
	junta plana cobre ø ext. 20mm int.ø 14mm espesor 2mm		
	código	560111	referencia —
	arandela int.ø 4.3mm ø ext. 9mm espesor 0.8mm inox UE 20 pzs DIN 125A para rosca M4		
	código	560131	referencia —
	tuerca hexagonal rosca M4 H 3.2mm EC 7 inox DIN/ISO DIN 934 / ISO 4032/8673 UE 20 pzs		

	código	416054	referencia	0109022 SIR0109022
	descripción	resistencia 1700W 230V espirales 1 L 320mm An 70mm H 215mm L1 25mm L2 295mm H1 177mm H2 38mm rosca 1/4" distancia de sujeción 62mm tubo ø 8.5mm sujeción 2 orificios empalme M4 resistencia de inmersión espirales 3		
	Para modelos:	CFE60110-5, CFE60110-9, CFE60210-5, CFE60210-9		
accesorios para	416054			
	código	361182	referencia	—
	tuerca rosca 1/4" H 5mm latón niquelado EC 17 UE 1 pzs			
	código	510417	referencia	—
	junta plana fibra ø ext. 20mm int.ø 14mm espesor 2mm UE 1 pzs			
	código	520228	referencia	—
	arandela dentada int.ø 15.3mm ø ext. 24mm acero UE 1 pzs para rosca M14			
	código	521103	referencia	—
	tuerca rosca M4 H 3mm EC 7 latón UE 20 pzs			
	código	521104	referencia	—
	arandela int.ø 4.3mm ø ext. 8mm espesor 0.5mm latón UE 20 pzs para rosca M4			
	código	550262	referencia	—
	junta plana cobre ø ext. 20mm int.ø 14mm espesor 2mm			
	código	560111	referencia	—
	arandela int.ø 4.3mm ø ext. 9mm espesor 0.8mm inox UE 20 pzs DIN 125A para rosca M4			
	código	560131	referencia	—
	tuerca hexagonal rosca M4 H 3.2mm EC 7 inox DIN/ISO DIN 934 / ISO 4032/8673 UE 20 pzs			



	código	415712	referencia	0101499 SIR0101499
	descripción	resistencia 1800W 230V espirales 1 L 294mm An 48mm H 290mm sujeción 2 orificios resistencia de inmersión L1 30mm L2 30mm L3 234mm H1 70mm H2 170mm H3 50mm tubo ø 6.3mm rosca 1/8" distancia de sujeción 40mm		

resistencias para plancha grills

	código	415076	referencia	1037300713 MA1037300713
	descripción	resistencia 1300W 230V espirales 1 L 490mm An 78mm H 70mm tubo ø 6.3mm B1 17mm B2 44mm empalme M4 longitud de empalme 20mm resistencia seca		
accesorios para	415076			
	código	521103	referencia	—
	tuerca rosca M4 H 3mm EC 7 latón UE 20 pzs			
	código	521104	referencia	—
	arandela int.ø 4.3mm ø ext. 8mm espesor 0.5mm latón UE 20 pzs para rosca M4			
	código	560111	referencia	—
	arandela int.ø 4.3mm ø ext. 9mm espesor 0.8mm inox UE 20 pzs DIN 125A para rosca M4			
	código	560131	referencia	—
	tuerca hexagonal rosca M4 H 3.2mm EC 7 inox DIN/ISO DIN 934 / ISO 4032/8673 UE 20 pzs			

	código	415369	referencia	0101529 SIR0101529
	descripción	resistencia 1350W 230V espirales 1 L 435mm An 46mm Hmm tubo ø 8.5mm sujeción 2 orificios empalme M5 rosca 1/4" distancia de sujeción 38mm plancha grill resistencia seca		
accesorios para	415369			
	código	361182	referencia	—
	tuerca rosca 1/4" H 5mm latón niquelado EC 17 UE 1 pzs			
	código	510417	referencia	—
	junta plana fibra ø ext. 20mm int.ø 14mm espesor 2mm UE 1 pzs			
	código	520228	referencia	—
	arandela dentada int.ø 15.3mm ø ext. 24mm acero UE 1 pzs para rosca M14			
	código	550262	referencia	—
	junta plana cobre ø ext. 20mm int.ø 14mm espesor 2mm			

Continúa en la página siguiente

accesorios para	415369								
	<table border="1"> <tr> <th>código</th> <td>560112</td> <th>referencia</th> <td>—</td> </tr> <tr> <td colspan="4">arandela int.ø 5.3mm ø ext. 10mm espesor 1mm inox UE 20 pzs DIN 125A para rosca M5</td> </tr> </table>	código	560112	referencia	—	arandela int.ø 5.3mm ø ext. 10mm espesor 1mm inox UE 20 pzs DIN 125A para rosca M5			
código	560112	referencia	—						
arandela int.ø 5.3mm ø ext. 10mm espesor 1mm inox UE 20 pzs DIN 125A para rosca M5									
	<table border="1"> <tr> <th>código</th> <td>560132</td> <th>referencia</th> <td>—</td> </tr> <tr> <td colspan="4">tuerca hexagonal rosca M5 H 4mm EC 8 inox DIN/ISO DIN 934 / ISO 4032/8673 UE 20 pzs</td> </tr> </table>	código	560132	referencia	—	tuerca hexagonal rosca M5 H 4mm EC 8 inox DIN/ISO DIN 934 / ISO 4032/8673 UE 20 pzs			
código	560132	referencia	—						
tuerca hexagonal rosca M5 H 4mm EC 8 inox DIN/ISO DIN 934 / ISO 4032/8673 UE 20 pzs									

	1		
código	415651	referencia	0109041 SI0109041 SIR0109041
descripción	resistencia 1500W 230V espirales 1 L 425mm An 72mm H 53mm tubo ø 8.5mm L1 22mm empalme conector Faston 6,3mm distancia de empalme 52mm resistencia seca		
Para modelos:	BE72ALC, BE72ALL, BE72ARR, BE72GLC, BE72GLL, BE72GRR, BE72TLC, BE72TLL, BE72TRR, BE74ALC, BE74ALL, BE74ALR, BE74ARC, BE74ARR, BE74GLC, BE74GLL, BE74GLR, BE74GMC, BE74GRR, BE74TLC, BE74TLL, BE74TLR, BE74TMC, BE74TRR, CGE6020, CGE6020C, CGE6020R, CGE6030, CGE6030C, CGE6030R, CGE6040, CGE6040C, CGE6040R, CGE7020, CGE7020C, CGE7020R, CGE7021, CGE7021C, CGE7021R, CGE7022, CGE7022C, CGE7022R, CGE7040, CGE7040C, CGE7040LR, CGE7040LRC, CGE7040R, CGE7041, CGE7041C, CGE7041LR...(Otros modelos se puede ver en la tienda web)		

	1		
código	415296	referencia	0101563 SI0101563 SIR0101563
descripción	resistencia 1580W 230V espirales 1 L 460mm An 65mm H 71mm tubo ø 8.5mm L1 20mm L2 440mm empalme conector Faston 6,3mm plancha grill distancia de empalme 57mm resistencia seca		
Para modelos:	BE72ALC, BE72ALL, BE72ARR, BE72GLC, BE72GLL, BE72GRR, BE72TLC, BE72TLL, BE72TRR, BE74ALC, BE74ALL, BE74ALR, BE74ARC, BE74ARR, BE74GLC, BE74GLL, BE74GLR, BE74GMC, BE74GRR, BE74TLC, BE74TLL, BE74TLR, BE74TMC, BE74TRR, CGE6020, CGE6020C, CGE6020R, CGE6030, CGE6030C, CGE6030R, CGE6040, CGE6040C, CGE6040R, CGE7020, CGE7020C, CGE7020R, CGE7021, CGE7021C, CGE7021R, CGE7022, CGE7022C, CGE7022R, CGE7040, CGE7040C, CGE7040LR, CGE7040LRC, CGE7040R, CGE7041, CGE7041C, CGE7041LR...(Otros modelos se puede ver en la tienda web)		

	1		
código	420103	referencia	CR0689240
descripción	resistencia 1800W 230V espirales 1 L 460mm An 90mm H 78mm tubo ø 8.5mm L1 33mm empalme M5 longitud de empalme 18mm para plancha grill distancia de empalme 81.5mm resistencia seca		
Para modelos:	EBE7		

	1		
código	420105	referencia	CR0731580
descripción	resistencia 2000W 230V espirales 1 L 480mm An 90mm H 42mm tubo ø 8.5mm IRCA L1 50mm L2 430mm B1 49mm B2 20mm brida de empalme empalme M5 dist. del agujero 89mm longitud brida 100mm anchura brida 35mm agujero ø 6mm espirales 2 resistencia seca		
Para modelos:	EGVE7		

	1		
código	415254	referencia	0101520 SIR0101520
descripción	resistencia 2000W 230V espirales 1 L 550mm An 93mm H 72mm tubo ø 8.5mm empalme M5 longitud de empalme 22mm resistencia seca		
Para modelos:	BE94ALC, BE94ALL, BE94ALR, BE94AMC, BE94ARC, BE94ARR, BE94GLC, BE94GLL, BE94GLR, BE94GMC, BE94GRC, BE94GRR, BE94TLC, BE94TLL, BE94TLR, BE94TMC, BE94TRC, BE94TRR, CGE9040-0, CGE9040-1, CGE9040-2, CGE9040-3, CGE9040-4, CGE9040-5, CGE9041-0, CGE9041-1, CGE9041-2, CGE9041-3, CGE9041-4, CGE9041-5, CGE9042-0, CGE9042-1, CGE9042-2, CGE9042-3, CGE9042-4, CGE9042-5		

	1		
código	415253	referencia	0101521 SI0101521 SIR0101521
descripción	resistencia 2000W 240V espirales 1 L 548mm An 72mm H 70mm tubo ø 8.5mm empalme M5 longitud de empalme 23mm distancia de empalme 65mm resistencia seca		
Para modelos:	BE92ALC, BE92ALL, BE92ARC, BE92ARR, BE92GLC, BE92GLL, BE92GRC, BE92GRR, BE92TLC, BE92TLL, BE92TRC, BE92TRR, CGE9020-0, CGE9020-1, CGE9020-2, CGE9020-3, CGE9021-0, CGE9021-1, CGE9021-2, CGE9021-3, CGE9022-0, CGE9022-1, CGE9022-2, CGE9022-3		

	1		
código	420102	referencia	CR0730070
descripción	resistencia 2500W 230V espirales 1 L 465mm An 155mm H 79mm tubo ø 8.8mm L1 30mm empalme M5 longitud de empalme 18mm para plancha grill distancia de empalme 146mm resistencia seca		
Para modelos:	EBE7		

	1		
código	420109	referencia	CR0582840
descripción	resistencia 2500W 230V espirales 1 L 635mm An 90mm H 80mm L1 30mm empalme M5 distancia de empalme 81.5mm tubo ø 8.5mm longitud de empalme 18mm resistencia seca para plancha grill		
Para modelos:	EBE92AL, EBE92ALC, EBE92AR, EBE92ARC, EBE92GL, EBE92GLC, EBE92GR, EBE92GRC, EBE92TL, EBE92TLC, EBE92TR, EBE92TRC, EBE94AL, EBE94ALC, EBE94ALR, EBE94AMC, EBE94AR, EBE94GL, EBE94GLC, EBE94GLR, EBE94GMC, EBE94GR, EBE94TL, EBE94TLC, EBE94TLR, EBE94TMC, EBE94TR		

	1		
código	420415	referencia	CR0937830
descripción	resistencia 2600W 230V espirales 1 L 480mm An 90mm H 42mm tubo ø 8.5mm L1 50mm L2 430mm B1 49mm B2 20mm brida de empalme empalme M5 dist. del agujero 89mm longitud brida 100mm anchura brida 35mm agujero ø 6mm espirales 2 resistencia seca		

código	420110	referencia	CR0685730
descripción	resistencia 3500W 230V espirales 1 L 635mm An 140mm H 80mm tubo ø 8.5mm L1 35mm empalme M5 longitud de empalme 18mm para plancha grill distancia de empalme 131.5mm resistencia seca		
Para modelos:	EBE93AL, EBE93ALC, EBE93ALR, EBE93AMC, EBE93GL, EBE93GLC, EBE93GLR, EBE93GMC, EBE93TL, EBE93TLC, EBE93TLR, EBE93TMC		

resistencias para placas de cocina grandes



código	418718	referencia	0101519 SI0101519 SIR0101519
descripción	resistencia 1500W 230V espirales 1 L 265mm An 100mm H 70mm tubo ø 6mm pos. de montaje espirales 3		
Para modelos:	CTE9141, CTE9142, CTE9142S, CTE9146, TE94, TE94APS, TE94EPS, TE94GPS, TE94APS		

resistencias para refrigeración

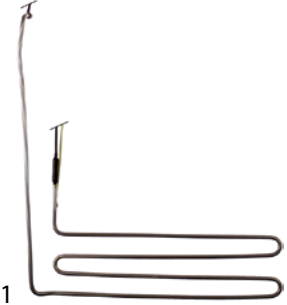

resistencias de descongelación





código	418752	referencia	1666355 BN1666355 FR6621230
descripción	resistencia 350W 230V L 395mm An 450mm L1 45mm L2 360mm B1 360mm B2 95mm longitud del cable 1000mm tubo ø 6mm descongelación empalme con cable		

resistencias para sartenes basculantes



código	415076	referencia	1037300713 MA1037300713	
descripción	resistencia 1300W 230V espirales 1 L 490mm An 78mm H 70mm tubo ø 6.3mm B1 17mm B2 44mm empalme M4 longitud de empalme 20mm resistencia seca			
accesorios para	415076			
	código	521103	referencia	—
	tuerca rosca M4 H 3mm EC 7 latón UE 20 pzs			
	código	521104	referencia	—
	arandela int.ø 4.3mm ø ext. 8mm espesor 0.5mm latón UE 20 pzs para rosca M4			

accesorios para	415076			
	código	560111	referencia	—
	arandela int.ø 4.3mm ø ext. 9mm espesor 0.8mm inox UE 20 pzs DIN 125A para rosca M4			
	código	560131	referencia	—
	tuerca hexagonal rosca M4 H 3.2mm EC 7 inox DIN/ISO DIN 934 / ISO 4032/8673 UE 20 pzs			



código	420107	referencia	CR0732870
descripción	resistencia 3300W 230V L 380mm An 185mm H 29mm empalme M5 resistencia seca espirales 1 tubo ø 8.5mm L1 35mm L2 345mm B1 48mm B2 90mm brida de empalme longitud brida 170mm anchura brida 30mm agujero ø 6mm espirales 3		
Para modelos:	ESE74		



código	415250	referencia	0101527 SI0101527 SIR0101527
descripción	resistencia grill 1650W 230V L 490mm An 42mm H 45mm empalme M4 resistencia seca espirales 1 tubo ø 8.5mm sujeción 2 orificios rosca 1/4" distancia de sujeción 37mm		
Para modelos:	CBE9060, CBE9060C, CGE9020, CGE9020C, CGE9020R, CGE9020RC, CGE9021, CGE9021C, CGE9021R, CGE9021RC, CGE9022, CGE9022C, CGE9022R, CGE9022RC, CGE9040, CGE9040C, CGE9040LR, CGE9040LRC, CGE9040R, CGE9040RC, CGE9041, CGE9041C, CGE9041LR, CGE9041LRC, CGE9041R, CGE9041RC, CGE9042, CGE9042C, CGE9042LR, CGE9042LRC, CGE9042R, CGE9042RC, SE84CRA, SE84CRM, SE84FRA, SE84FRM, SE84IRA, SE84IRM, SE94CRA, SE94CRM, SE94FRA, SE94FRM, SE94IRA, SE94IRM		



código	420104	referencia	CR0683221
descripción	resistencia para sartén basculante 5000W 230V L 555mm An 180mm H 30mm empalme M5 resistencia seca espirales 1 tubo ø 8.5mm L1 25mm L2 530mm B1 45mm B2 90mm brida de empalme longitud brida 170mm anchura brida 30mm agujero ø 6.3mm espirales 3		
Para modelos:	ESE94CRA, ESE94CRM, ESE94FRA, ESE94FRM, ESE96CRA, ESE96FRA		





código	420106	referencia	CR0684240
descripción	resistencia para sartén basculante 6350W 230V L 550mm An 320mm H 24mm empalme M5 resistencia seca espirales 1 tubo ø 8.5mm L1 45mm L2 505mm B1 48mm B2 225mm brida de empalme longitud brida 305mm anchura brida 30mm agujero ø 6mm espirales 4		
Para modelos:	ESE94CRA, ESE94CRM, ESE94FRA, ESE94FRM, ESE96CRA, ESE96FRA		



1

código	415298	referencia	0101526 SIO101526 SIR0101526
descripción	resistencia sartén basculante 3400W 230V L 315mm An 195mm H 85mm empalme M5 resistencia seca espirales 1 tubo ø 10mm B1 68mm B2 58mm		
Para modelos:	CBE7050, CBE7050C, SE74CRM, SE74FRM, SE74IRM		

accesorios para 415902

	código	521133	referencia	—
		tuerca rosca M14x1,5 H 6mm EC 19 acero zincado UE 1 pzs		
	código	550261	referencia	—
		tuerca rosca M14x1 H 4mm EC 19 inox UE 1 pzs		
	código	550262	referencia	—
		junta plana cobre ø ext. 20mm int.ø 14mm espesor 2mm		

resistencias para cuecepasta



1

código	415295	referencia	0108111 SIR0108111	
descripción	resistencia 1840W 230V L 275mm An 70mm sujeción 2 orificios empalme M4 rosca 1/4" tubo ø 8.5mm distancia de sujeción 62mm cocedora de pasta resistencia de inmersión			
Para modelos:	CNE70130, CNE70160, CNE72130, CNE72160, CNE90130, CNE90130-S, CNE90160, CNE90160S, CNE90160-S, CNE90230, DE72125, DE74170, DE94170, DEY4160			
accesorios para	415295			
	código	361182	referencia	—
		tuerca rosca 1/4" H 5mm latón niquelado EC 17 UE 1 pzs		
	código	510417	referencia	—
		junta plana fibra ø ext. 20mm int.ø 14mm espesor 2mm UE 1 pzs		
	código	520228	referencia	—
		arandela dentada int.ø 15.3mm ø ext. 24mm acero UE 1 pzs para rosca M14		
	código	550262	referencia	—
		junta plana cobre ø ext. 20mm int.ø 14mm espesor 2mm		







1

código	420096	referencia	CR0731030 CR0731030R
descripción	resistencia 5600W 230V espirales 3 L 255mm An 210mm H 32mm brida giratoria rosca M54x1,5 tubo ø 8.4mm L1 60mm L2 195mm B1 180mm B2 30mm longitud del cable 1200mm espirales 2 longitud pletina 1 2mm longitud pletina 2 20mm longitud pletina 21mm pletina ø2 63mm pletina ø2 54mm para cocedora de pasta resistencia de inmersión		
Para modelos:	EDE72128, EDE74228		



1

código	415977	referencia	0105199 MA1870000R SIR0105199	
descripción	resistencia 5670W 230V espirales 3 L 292mm An 225mm H 26mm brida giratoria tubo ø 6.3mm ø casquillo portasondas 9mm longitud casquillo portasondas 185mm L1 42mm L2 250mm B1 197mm B2 28mm longitud del cable 460mm casquillo portasondas 1 longitud de empalme 50mm longitud pletina 1 9mm longitud pletina 2 15.5mm longitud pletina 24.5mm pletina ø2 43.8mm pletina ø2 39.7mm casquillo termostato centrado, ajustado cocedora de pasta racor termostato M10x1			
Para modelos:	DE72128, DE74228			
accesorios para	415977			
	código	514016	referencia	0105170 MA1814500 SIR0105170
		junta plana PTFE ø ext. 45mm int.ø 40mm espesor 4mm UE 1 pzs núm. Ref. 1036500400/1814500 para MARENO		
	código	514017	referencia	0105169 0105246 1814400 MA1814400 SIR0105169 SIR0105246
		junta tórica silicona espesor 3.53mm int.ø 32.93mm UE 1 pzs		
	código	514018	referencia	—
		casquillo		
	código	514020	referencia	—
		casquillo		



1







código	415902	referencia	0109035 SIR0109035	
descripción	resistencia 2510W 230V L 295mm An 115mm Hmm sujeción 2 orificios empalme conector Faston 6,3mm rosca M14x1 tubo ø 8.5mm			
Para modelos:	CNE6030			
accesorios para	415902			
	código	510417	referencia	—
		junta plana fibra ø ext. 20mm int.ø 14mm espesor 2mm UE 1 pzs		
	código	520228	referencia	—
		arandela dentada int.ø 15.3mm ø ext. 24mm acero UE 1 pzs para rosca M14		

accesorios para 415977

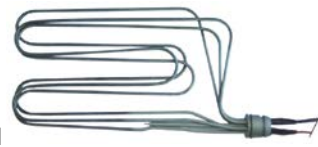

	código	514016	referencia	0105170 MA1814500 SIR0105170
		junta plana PTFE ø ext. 45mm int.ø 40mm espesor 4mm UE 1 pzs núm. Ref. 1036500400/1814500 para MARENO		
	código	514017	referencia	0105169 0105246 1814400 MA1814400 SIR0105169 SIR0105246
		junta tórica silicona espesor 3.53mm int.ø 32.93mm UE 1 pzs		
	código	514018	referencia	—
		casquillo		
	código	514020	referencia	—
		casquillo		

Continúa en la página siguiente





accesorios para		415977	
	código	514021	referencia —
	junta tórica silicona espesor 3.53mm int.ø 49.21mm UE 1 pzs		
	código	514022	referencia —
	tuerca rosca 1½" H 12mm inox EC 59 UE 1 pzs		
	código	540435	referencia —
	barra roscada rosca M10 hueco		
	código	540436	referencia —
	tuerca hexagonal rosca M10x1,25 H 4mm EC 13 latón UE 1 pzs		
	código	540438	referencia —
	tuerca alargada rosca M10 L 25mm EC 13 latón UE 1 pzs		
	código	540439	referencia —
	casquillo separador		

			
1			
código	415991	referencia	0105168 1869900 MA1869900 MA1869900R SIR0105168
descripción	resistencia 8499W 230V espirales 3 L 405mm An 225mm H 25mm brida giratoria tubo ø 6.3mm ø casquillo portasondas 9mm longitud casquillo portasondas 223mm L1 40mm L2 365mm B1 196mm B2 29mm longitud del cable 1250mm casquillo portasondas 1 longitud de empalme 48mm longitud pletina 1 9mm longitud pletina 2 15.5mm longitud pletina 24.5mm pletina ø2 43.8mm pletina ø2 39.7mm apto para serie 900 casquillo termostato centrado, ajustado cocedora de pasta racor termostato M10x1		
Para modelos:	DE82140, DE82142, DE82T42, DE84240, DE84242, DE84T42, DE92142, DE94242, DEY2142, DEY4242		
accesorios para		415991	
	código	514016	referencia 0105170 MA1814500 SIR0105170
	junta plana PTFE ø ext. 45mm int.ø 40mm espesor 4mm UE 1 pzs núm. Ref. 1036500400/1814500 para MARENO		
	código	514017	referencia 0105169 0105246 1814400 MA1814400 SIR0105169 SIR0105246
	junta tórica silicona espesor 3.53mm int.ø 32.93mm UE 1 pzs		
	código	514018	referencia —
	casquillo		
	código	514019	referencia —
	barra roscada rosca M8 L 45mm latón		
	código	514020	referencia —
	casquillo		
	código	514021	referencia —
	junta tórica silicona espesor 3.53mm int.ø 49.21mm UE 1 pzs		

accesorios para		415991	
	código	514022	referencia —
	tuerca rosca 1½" H 12mm inox EC 59 UE 1 pzs		
	código	540435	referencia —
	barra roscada rosca M10 hueco		
	código	540436	referencia —
	tuerca hexagonal rosca M10x1,25 H 4mm EC 13 latón UE 1 pzs		
	código	540438	referencia —
	tuerca alargada rosca M10 L 25mm EC 13 latón UE 1 pzs		
	código	540439	referencia —
	casquillo separador		

			
1			
código	420098	referencia	CR0582040 CR0582040R
descripción	resistencia 8500W 230V espirales 3 L 378mm An 210mm H 32mm brida giratoria rosca M54x1,5 tubo ø 8.4mm L1 68mm L2 310mm B1 178mm B2 32mm longitud del cable 1250mm espirales 3 longitud pletina 1 2mm longitud pletina 2 19mm longitud pletina 21mm pletina ø2 63mm pletina ø2 54mm para cocedora de pasta resistencia de inmersión		
Para modelos:	EDE92142, EDE93142, EDE94242		
accesorios para		420098	
	código	514419	referencia CR0586210
	soporte para resistencia L 68mm An 20mm H 28mm		
	código	550496	referencia 0105021 CM099200 MACM099200 SIR0105021
	junta tórica Viton espesor 3.53mm int.ø 50.39mm UE 1 pzs		

 <p>1</p>			
código	415971	referencia	1870100 1870100R MA1870100 MA1870100R
descripción	resistencia 9000W 230/415V espirales 3 L 245mm An 320mm H 25mm brida giratoria tubo ø 6.3mm ø casquillo portasondas 7mm longitud casquillo portasondas 210mm L1 55mm L2 190mm B1 28mm B2 292mm longitud del cable 600mm casquillo portasondas 1 longitud de empalme 35mm longitud pletina 1 9mm longitud pletina 2 15.5mm longitud pletina 24.5mm pletina ø2 43.8mm pletina ø2 39.7mm pos. de montaje izquierdo apto para serie 600 casquillo termostato centrado, ajustado cocedora de pasta racor termostato M10x1		
Para modelos:	CNE6230, DE63128		
accesorios para	415971		
	código	514016	referencia 0105170 MA1814500 SIR0105170
	junta plana PTFE ø ext. 45mm int.ø 40mm espesor 4mm UE 1 pzs núm. Ref. 1036500400/1814500 para MARENO		
	código	514017	referencia 0105169 0105246 1814400 MA1814400 SIR0105169 SIR0105246
	junta tórica silicona espesor 3.53mm int.ø 32.93mm UE 1 pzs		
	código	514018	referencia —
	casquillo		
	código	514019	referencia —
	barra roscada rosca M8 L 45mm latón		
	código	514020	referencia —
	casquillo		
	código	514021	referencia —
	junta tórica silicona espesor 3.53mm int.ø 49.21mm UE 1 pzs		
	código	514022	referencia —
	tuerca rosca 1½" H 12mm inox EC 59 UE 1 pzs		
	código	540435	referencia —
	barra roscada rosca M10 hueco		
	código	540436	referencia —
	tuerca hexagonal rosca M10x1,25 H 4mm EC 13 latón UE 1 pzs		
	código	540438	referencia —
	tuerca alargada rosca M10 L 25mm EC 13 latón UE 1 pzs		
	código	540439	referencia —
	casquillo separador		

 <p>1</p>			
código	420097	referencia	CR0688330
descripción	resistencia 9000W 230V espirales 3 L 250mm An 325mm H 32mm brida giratoria rosca M54x1,5 tubo ø 8.3mm L1 200mm L2 50mm B1 293mm B2 32mm longitud del cable 1200mm espirales 2 longitud pletina 1 2mm longitud pletina 2 19mm longitud pletina 21mm pletina ø2 63mm pletina ø2 54mm para cocedora de pasta resistencia de inmersión		
Para modelos:	EDE73142		
accesorios para	420097		
	código	504230	referencia —
	tornillo prisionero rosca M5 L 8mm A2-A2L DIN 914/ISO 4027 EC 2.5 UE 1 pzs		
	código	550496	referencia 0105021 CM099200 MACM099200 SIR0105021
	junta tórica Viton espesor 3.53mm int.ø 50.39mm UE 1 pzs		
	código	550662	referencia 0105152 0108054 0108738 CM021600 MACM021600 SIR0108054 SIR0108738
	tuerca anillo rosca M54x1,5 H 7mm		



resistencias fry top

 <p>1</p>			
código	420467	referencia	CR0681360 CR0842340
descripción	resistencia 3300W 230V L 620mm An 95mm H 40mm B1 20mm B2 48mm L1 15mm L2 30mm L3 575mm longitud brida 100mm anchura brida 35mm dist. del agujero 88mm empalme M5 espirales 1 tubo ø 8.5mm longitud de empalme 45mm agujero ø 6.5mm brida rectangular resistencia seca		
Para modelos:	EGVE92, EGVE94		

 <p>1</p>			
código	415762	referencia	0101522 SIR0101522
descripción	resistencia 850W 230V L 450mm An 45mm H 85mm rosca 1/4" distancia de sujeción 37mm tubo ø 8.6mm empalme M4 longitud de empalme 23mm sujeción 2 orificios resistencia seca		
Para modelos:	CRE6-20, CRE6-30		
accesorios para	415762		
	código	361182	referencia —
	tuerca rosca 1/4" H 5mm latón niquelado EC 17 UE 1 pzs		
	código	510417	referencia —
	junta plana fibra ø ext. 20mm int.ø 14mm espesor 2mm UE 1 pzs		

Continúa en la página siguiente





accesorios para	415762			
	código	520228	referencia	—
	arandela dentada int.ø 15.3mm ø ext. 24mm acero UE 1 pzs para rosca M14			
	código	550262	referencia	—
	junta plana cobre ø ext. 20mm int.ø 14mm espesor 2mm			

1 				
código	415250	referencia	0101527 SI0101527 SIR0101527	
descripción	resistencia grill 1650W 230V L 490mm An 42mm H 45mm empalme M4 resistencia seca espirales 1 tubo ø 8.5mm sujeción 2 orificios rosca 1/4" distancia de sujeción 37mm			
Para modelos:	CBE9060, CBE9060C, CGE9020, CGE9020C, CGE9020R, CGE9020RC, CGE9021, CGE9021C, CGE9021R, CGE9021RC, CGE9022, CGE9022C, CGE9022R, CGE9022RC, CGE9040, CGE9040C, CGE9040LR, CGE9040LRC, CGE9040R, CGE9040RC, CGE9041, CGE9041C, CGE9041LR, CGE9041LRC, CGE9041R, CGE9041RC, CGE9042, CGE9042C, CGE9042LR, CGE9042LRC, CGE9042R, CGE9042RC, SE84CRA, SE84CRM, SE84FRA, SE84FRM, SE84IRA, SE84IRM, SE94CRA, SE94CRM, SE94FRA, SE94FRM, SE94IRA, SE94IRM			

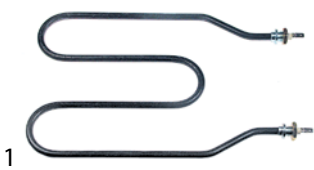
resistencias para calentadores de platos

1 				
código	416828	referencia	0101532 SIR0101532	
descripción	resistencia 1000W 240V sujeción 2 orificios rosca 1/4" L 295mm An 206mm empalme conector Faston 6,3mm L1 85mm L3 205mm resistencia seca tubo ø 8.5mm B1 30mm B2 146mm distancia de sujeción 138mm para armario caliente			
Para modelos:	CCG1045, CCG10652, CCG10653, CCG1085, CCG10852, CCG9046, CCG90663, CCG91653, CCG91653-1, CCG91663, CCG91663-1, CCQ9046, CCQ90663, CTT9045, CTT9046, CTT90652R, CTT90653R, CTT90663R			

1 				
código	416827	referencia	0101494 SI0101494 SIR0101494	
descripción	resistencia 1100W 240V sujeción 2 orificios rosca M10x1 L 375mm An 90mm espirales 1 empalme conexión enchufable 4mm L1 25mm L2 25mm L3 325mm resistencia seca tubo ø 6.3mm B1 23mm B2 44mm distancia de sujeción 38mm para armario caliente			
Para modelos:	CCG6045, CCG60652, CCG60653, CCG7045, CCG7046, CCG70652, CCG70653, CCG70663, CCG72653, CCG72663, CCQ7046, CCQ70663, CCT7046, CCT70663, CTT72653, CTT72653L			
accesorios para	416827			
	código	101860	referencia	—
	tuerca rosca M10x1 H 4mm EC 14 latón cromado UE 1 pzs			

cables de calefacción

empalme ambos lados

con faston macho

1 				
código	417576	referencia	FR6621641 FR996456	
descripción	cable de calefacción 45.3W 230V L 5000mm			

radiadores cerámicos

245x60mm

1 				
código	415104	referencia	0109050 SIR0109050	
descripción	radiador cerámico 1000W 230V cable cables perlizados L 245mm An 60mm H 35mm			
Para modelos:	BER12, BER14, BER16, BER18, BER20, CNG70130, CNG70160, CNG70230, CNG72160, CNG72230, CPI70150, CPI90100AP, CPI90100A-P, CPI90100P, CPI90100-P, CPI90150AP, CPI90150A-P, CPI90150P, CPI90150-P, CSP6020, CSP7020, DG72125, DG74155, DG74225, PE9NI10, PE9NI15, PG7NI05, PG8AD10, PG8AD15, PG8AI10, PG8AI15, PG8ND10, PG8ND15, PG8NI10, PG8NI15, PG9AI10, PG9AI15, PG9NI10, PG9NI15, RP72TPS			
repuestos para	415104			
	código	415109	referencia	—
	resorte de fijación			
accesorios para	415104			
	código	415110	referencia	—
	reflector L 245mm An 95mm H 31mm espesor 0.75mm agujero ø 15x40mm			

1 				
código	415103	referencia	0109051 SIR0109051	
descripción	radiador cerámico 650W 230V cable cables perlizados L 245mm An 60mm H 35mm			
Para modelos:	CSP6020, CSP7020, RP72TPS			
repuestos para	415103			
	código	415109	referencia	—
	resorte de fijación			
accesorios para	415103			
	código	415110	referencia	—
	reflector L 245mm An 95mm H 31mm espesor 0.75mm agujero ø 15x40mm			

resistencias de inmersión

brida 3 orificios ø 57,5mm

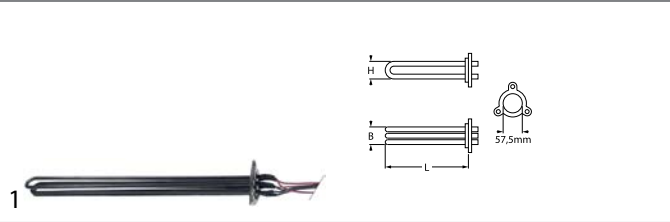

código	420101	referencia	CR0589130 CR0589130R
descripción	resistencia 10500W 400V espirales 3 L 580mm An 36mm H 42mm tubo ø 8.4mm casquillo portasondas 0 longitud del cable 700mm resistencia de inmersión brida 3 orificios dist. del agujero 73mm montaje ø 57.5mm agujero ø 10mm		
Para modelos:	EPE9110, EPE9110A, EPE9115, EPE9115A		
accesorios para	420101		
		código	521146 referencia —
			junta tórica Viton espesor 5.34mm int.ø 56.52mm UE 1 pzs

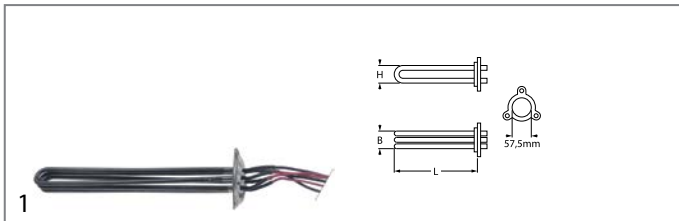

código	420099	referencia	CR0735010 CR0735010R
descripción	resistencia 4800W 230V espirales 3 L 390mm An 36mm H 41mm tubo ø 8.4mm casquillo portasondas 0 longitud del cable 700mm resistencia de inmersión brida 3 orificios dist. del agujero 73mm montaje ø 57.5mm agujero ø 10mm		
Para modelos:	EPE7105		

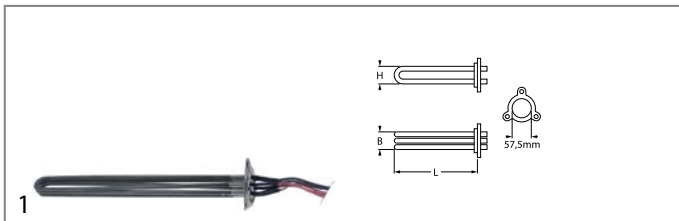

código	420100	referencia	CR0737000
descripción	resistencia 8400W 230V espirales 3 L 490mm An 36mm H 40mm tubo ø 8.4mm casquillo portasondas 0 longitud del cable 700mm resistencia de inmersión brida 3 orificios dist. del agujero 73mm montaje ø 57.5mm agujero ø 10mm		
Para modelos:	EPE7108		

1"



código	420074	referencia	CR0682160 CR0682160R
descripción	resistencia 260W 230V espirales 1 L 242mm An 18mm H 6.25mm tubo ø 6.25mm ø casquillo portasondas 5mm longitud casquillo portasondas 230mm casquillo portasondas 1 casquillo termostato centrado, ajustado empalme conector Faston 6,3mm longitud de empalme 35mm resistencia de inmersión brida roscada EC 32 rosca 1"		
Para modelos:	EPE7105, EPE7108, EPE9110, EPE9110A, EPE9115, EPE9115A, EPG7105, EPG7108, EPG9115, EPG9115A, EPG9110, EPG9110A		
repuestos para	420074		
		código	503158 referencia —
			junta plana FIBER ø ext. 44mm int.ø 33mm espesor 2mm UE 1 pzs
accesorios para	420074		
		código	507532 referencia —
			tuerca rosca 1" H 10mm EC 40 latón UE 1 pzs

1½"



código	415256	referencia	0101493 SI0101493 SIR0101493
descripción	resistencia 7500W 230V espirales 3 L 480mm An 34mm H 32mm tubo ø 6.3mm ø casquillo portasondas 7mm longitud casquillo portasondas 310mm casquillo portasondas 1 casquillo termostato no ajustado empalme conector Faston 6,3mm longitud de empalme 52mm resistencia de inmersión brida roscada rosca 1½"		
Para modelos:	CPE90100, CPE90100A, CPE90150, CPE90150A, PE8A110, PE8A115, PE8N110, PE8N115, PE9A110, PE9A115, PE9N110, PE9N115		
repuestos para	415256		
		código	510406 referencia —
			junta plana fibra ø ext. 60mm int.ø 48mm espesor 3mm para rosca 1½" UE 1 pzs
accesorios para	415256		
		código	510424 referencia —
			junta cobre ø ext. 55mm int.ø 48mm espesor 2.2mm Centellen para rosca 1½"
		código	520211 referencia —
			reducción rosca 2" M - 1½" H latón
		código	520212 referencia —
			tuerca hexagonal rosca 1½" latón EC 60 H 8mm
		código	550361 referencia —
			brida ciega ø 58mm rosca 1½"



2"



1

código	415299	referencia	0101495 SIR0101495
descripción	resistencia 6000W 230V espirales 3 L 320mm An 40mm H 44mm tubo ø 8.5mm ø casquillo portasondas 5mm longitud casquillo portasondas 280mm empalme M4 resistencia de inmersión brida roscada rosca 2"		
Para modelos:	CPE70150, CPE7-150, PE7NI05		
accesorios para	415299		
	código	510407	referencia —
	junta plana fibra ø ext. 78mm int.ø 60mm espesor 2mm para resistencia para rosca 2" UE 1 pzs		



1

código	415255	referencia	0101810 SIR0101810
descripción	resistencia 2520W 220V L 443mm An 64mm rosca 1/4" distancia de sujeción 46mm tubo ø 8.5mm sujeción 2 orificios resistencia de inmersión empalme M4		
accesorios para	415255		
	código	521103	referencia —
	tuerca rosca M4 H 3mm EC 7 latón UE 20 pzs		
	código	521104	referencia —
	arandela int.ø 4.3mm ø ext. 8mm espesor 0.5mm latón UE 20 pzs para rosca M4		
	código	560111	referencia —
	arandela int.ø 4.3mm ø ext. 9mm espesor 0.8mm inox UE 20 pzs DIN 125A para rosca M4		
	código	560131	referencia —
	tuerca hexagonal rosca M4 H 3.2mm EC 7 inox DIN/ISO DIN 934 / ISO 4032/8673 UE 20 pzs		

2 empalmes

recto



1

código	416817	referencia	CR0682150
descripción	resistencia 4000W 230V espirales 1 L 619mm An 150mm Hmm tubo ø 8.5mm longitud del cable 790mm longitud de empalme 18mm marmita apto para serie 900		
Para modelos:	EPE9D10, EPE9D15		

resistencias circulación de aire



1

código	415251	referencia	0101564 65010200 LA65010200 LAR65010200 SIR0101564
descripción	resistencia 2500W 230V espirales 1 int.ø 178mm ø ext. 190mm L 242mm H 35mm L1 46mm B1 31mm H1 10mm H2 25mm longitud brida 70mm anchura brida 22mm dist. del agujero 56mm empalme conector Faston 6,3mm horizontal tubo ø 6.3mm resistencia circulación de aire agujero ø 5mm brida rectangular		
Para modelos:	BAC100, BAC100-A, BAC102, BAC120, BAC120-A, BAC122, BAC140, BAC140-A, BAC142, BAC160, BAC160-A, BAC162, BAC180, BAC180-A, BAC182, BAC200, BAC200-A, BAC202, BAM16D, BAM16S, BAM18D, BAM18S, BAM20D, BAM20S		
repuestos para	415251		
	código	510368	referencia —
	junta L 70mm An 23.5mm agujero ø 5mm dist. del agujero 56mm FIBER espesor 2mm para resistencia		

resistencias radiantes

cuadrado



1

código	490008	referencia	0101468 SIR0101468
descripción	resistencia radiante L 300mm An 300mm 4000W 400V espirales 2 empalmes 3 cuadrado tipo de empalme conector Faston 6,3mm sin detector de ollas EGO		
Para modelos:	CCQ9020, CCQ9020V, CCQ9020-V, CCQ9021, CCQ9021-V, CCQ9022, CCQ9022-V, CCQ9040, CCQ9040V, CCQ9040-V, CCQ9041, CCQ9041-V, CCQ9042, CCQ9042V, CCQ9042-V, CCQ9046, CCQ9046V, CCQ9046-V, CCQ9121V, CCQ9122V, CCQ9141V, CV92APS, CV92GPS, CV94APS, CV94EPS, CV94GPS, CVY2TPS, CVY4TPS		
repuestos para	490008		
	código	499157	referencia —
	tubo de protección para sensor de temperatura cerámica L 297mm ø ext. 7mm int.ø 5mm		

a 1 circuito



1

código	490024	referencia	0101465 SIR0101465
descripción	resistencia radiante ø 165mm 1200W 230V espirales 1 regulación de energía con avisador de temperatura con resistencia en espiral empalmes 2+2 tipo de empalme conector Faston 6,3mm EGO		
Para modelos:	CCT6020V, CCT6040V, CCT7020-V, CCT7021-V, CCT7022-V, CCT7040-V, CCT7041-V, CCT7042-V, CCT7046-V, CCT7220V, CCT7221V, CCT7222V, CCT7240V, CCT7241V, CCT7242V, CCT7246V, CV72APS, CV72GPS, CV72TPS, CV74APS, CV74EPS, CV74GPS, CV74TPS		



1

código	490025	referencia	0101466 SIR0101466
descripción	resistencia radiante ø 200mm 1700W 230V espirales 1 regulación de energía con avisador de temperatura con resistencia en espiral empalmes 2+2 tipo de empalme conector Faston 6,3mm EGO		
Para modelos:	CCT6020V, CCT6040V, CCT7020-V, CCT7021-V, CCT7022-V, CCT7040-V, CCT7041-V, CCT7042-V, CCT7046-V, CCT7220V, CCT7221V, CCT7222V, CCT7240V, CCT7241V, CCT7242V, CCT7246V, CV72APS, CV72GPS, CV72TPS, CV74APS, CV74EPS, CV74GPS, CV74TPS		

accesorios

tuercas anillos



1

código	550662	referencia	0105152 0108054 0108738 CM021600 MACM021600 SIR0108054 SIR0108738	
descripción	tuerca anillo rosca M54x1,5 H 7mm			
Para modelos:	CFE70110, CFE70110-2, CFE70115, CFE70115-2, CFE70115-M, CFE70210, CFE70210-2, CFE70210-M, CFE70215, CFE70215-2, CFE70215-M, CFE72210, CFE72215, CFE90120, CFE90120-2, CFE90210, CFE90210-2, CFE90220, CFE90220-2, EDE72128, EDE73142, EDE74228, EDE92142, EDE93142, EDE94242, EFE72110, EFE72115, EFE73210, EFE74215, EFE92115, EFE92122, EFE92122K, EFE93210, EFE94215, EFE94222, EFE94222K, FE72112, FE72210, FE72T10, FE74212, FE74T10, FE82118, FE82T18, FE84218, FE84T18, FE92118, FE92210, FE94218, FEY2118, FEY4218			
accesorios para	550662			
	código	550449	referencia	—
	llave especial para tuerca anillo			

anillos de junta

juntas de fibra

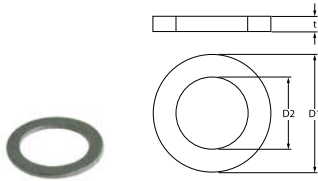

1

código	510404	referencia	CR0682770
descripción	junta plana fibra ø ext. 44mm int.ø 34mm espesor 2mm UE 1 pzs		

juntas de PTFE

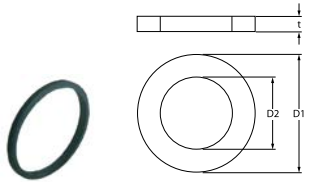

1

código	514016	referencia	0105170 MA1814500 SIR0105170
descripción	junta plana PTFE ø ext. 45mm int.ø 40mm espesor 4mm UE 1 pzs núm. Ref. 1036500400/1814500 para MARENO		
Para modelos:	DE72128, DE74228, DE82140, DE84240, DE92142, DE94242, DEY2142, DEY4242		

juntas tóricas

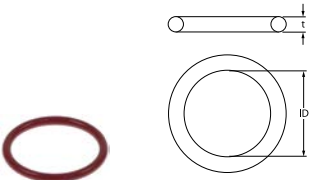

1

código	514017	referencia	0105169 0105246 1814400 MA1814400 SIR0105169 SIR0105246
descripción	junta tórica silicona espesor 3.53mm int.ø 32.93mm UE 1 pzs		
Para modelos:	CNE6230, DE63128, DE72128, DE74228, DE82140, DE82142, DE82T42, DE84240, DE84242, DE84T42, DE92142, DE94242, DEY2142, DEY4242		

código	550496	referencia	0105021 CM099200 MACM099200 SIR0105021
descripción	junta tórica Viton espesor 3.53mm int.ø 50.39mm UE 1 pzs		
Para modelos:	CFE62110/1, CFE62210/1, EDE72128, EDE73142, EDE74228, EDE92142, EDE93142, EDE94242, EFE72110, EFE72115, EFE73210, EFE74215, EFE92115, EFE92122, EFE92122K, EFE93210, EFE94215, EFE94222, EFE94222K, FE62T10, FE64T10, FE72112, FE72206, FE72T10, FE74212, FE74T10, FE82118, FE82206, FE82T18, FE84218, FE84T18, FE92118, FE92206, FE94218, FEY2118, FEY2206, FEY4218		

código	510245	referencia	0108055 SIR0108055
descripción	junta tórica Viton espesor 3.53mm int.ø 50.8mm UE 1 pzs		
Para modelos:	CFE70110, CFE70110-2, CFE70115, CFE70115-2, CFE70115-M, CFE70210, CFE70210-2, CFE70210-M, CFE70215, CFE70215-2, CFE70215-M, CFE72210, CFE72215, CFE90120, CFE90120-2, CFE90210, CFE90210-2, CFE90220, CFE90220-2, FE72210, FE92210		

código	514419	referencia	CR0586210
descripción	soporte para resistencia L 68mm An 20mm H 28mm		
Para modelos:	EDE72128, EDE74228, EDE92142, EDE93142, EDE94242		

placas de cocción

cuadrada y rectangular

con borde integrado

código	490065	referencia	0101474 SIR0101474
descripción	placa de cocción medidas 220x220mm 2000W 230V con borde integrado empalme 4 bornes de rosca protector no cuadrado		

código	490066 ¹	referencia	0101475 1712913 CR1078117R MA1712913 SIR0101475
descripción	placa de cocción medidas 220x220mm 2600W 230V con borde integrado empalme 4 bornes de rosca protector presente cuadrado		
Para modelos:	CCQ7020, CCQ7021, CCQ7022, CCQ7040, CCQ7041, CCQ7042, CCQ7046, CCQ7061, CCQ7062, CCQ70663, CCQ7220, CCQ7221, CCQ7222, CCQ7240, CCQ7241, CCQ7242, CCQ7246, CCQ7261, CCQ7262, CCT7020, CCT7021, CCT7022, CCT7040, CCT7041, CCT7042, CCT7046, CCT7061, CCT7062, CCT70663, CE72APQ, CE72APT, CE72GPQ, CE72GPT, CE72TPQ, CE72TPT, CE74APQ, CE74APT, CE74EPQ, CE74EPT, CE74GPQ, CE74GPT, CE74TPQ, CE74TPT, CE76APQ, CE76EPT, ECE74-Q		

¹con protector

código	490176 ¹	referencia	0109190 SI0109190 SIR0109190
descripción	placa de cocción medidas 220x220mm 2600W 440V con borde integrado empalme 4 bornes de rosca protector presente		

¹con protector

código	490056 ¹	referencia	0101467 SIR0101467
descripción	placa de cocción medidas 300x300mm 3000W 230V con borde integrado empalme 4 bornes de rosca protector presente cuadrado		
Para modelos:	CCQ9020, CCQ9021, CCQ9022, CCQ9040, CCQ9041, CCQ9042, CCQ9046, CCQ9060, CCQ9061, CCQ9062, CCQ90663		

¹con protector



			
1			
código	490071 ¹	referencia	0101476 1937300 MA1937300 MA1937300R SIR0101476
descripción	placa de cocción medidas 300x300mm 4000W 230V con borde integrado empalme 4 bornes de rosca protector presente cuadrado		
Para modelos:	CCQ9020, CCQ9021, CCQ9022, CCQ9040, CCQ9041, CCQ9042, CCQ9046, CE82APQ, CE82GPQ, CE82TPQ, CE84APQ, CE84EPQ, CE84GPQ, CE84TPQ, CE92APQ, CE92GPQ, CE92TPQ, CE94APQ, CE94EPQ, CE94GPQ, CE94TPQ, CEY2TPQ, CEY4TPQ, ECE92A, ECE92G, ECE92T, ECE94A, ECE94E, ECE94G, ECE94T		

¹con protector

redondas

con borde integrado

para cocinas domésticas y industriales

			
1			
código	490018	referencia	0101487 SIR0101487
descripción	placa de cocción ø 220mm 2000W 230V empalme 4 bornes de rosca con borde de 8 mm		

			
1			
código	490020	referencia	0101482 1832313 MA1832313 SIR0101482
descripción	placa de cocción ø 220mm 2600W 230V empalme 4 bornes de rosca con borde de 8 mm		
Para modelos:	CCQ7020, CCQ7021, CCQ7022, CCQ7040, CCQ7041, CCQ7042, CCQ7046, CCQ7061, CCQ7062, CCQ70663, CCT6020, CCT6040, CCT6046, CCT7020, CCT7021, CCT7022, CCT7040, CCT7041, CCT7042, CCT7046, CCT7061, CCT7062, CCT70663, CCT7220, CCT7221, CCT7222, CCT7240, CCT7241, CCT7242, CCT7246, CCT7261, CCT7262, CCT72662, CE72APQ, CE72APT, CE72GPQ, CE72GPT, CE72TPQ, CE72TPT, CE74APQ, CE74APT, CE74EPQ, CE74EPT, CE74GPQ, CE74GPT, CE74TPQ, CE74TPT, CE76APT, CE76EPQ, CE76EPT...(Otros modelos se puede ver en la tienda web)		
accesorios para	490020		
	código	550796	referencia
	 placa de sujeción para placa ø220mm		

reguladores de energía

EGO

a 1 circuito

			
1			
código	380015	referencia	0105171 0108203 0108231 426710 65080250 LA65080250 LAR65080250 SIR0105171 SIR0108203 SIR0108231
descripción	regulador de energía 230V 13A circuito simple sentido de rotación derecho eje ø 6x4,6mm eje L 23mm rosca de sujeción M4 liberación potencia 6-100% N° 50.57021.010		
Para modelos:	BER12, BER14, BER16, BER18, BER20, CBE6030, CCQ9020, CCQ9020-V, CCQ9021, CCQ9021-V, CCQ9022, CCQ9022-V, CCQ9040, CCQ9040-V, CCQ9041, CCQ9041-V, CCQ9042, CCQ9042-V, CCQ9046, CCQ9046-V, CCT6020V, CCT6040V, CCT7020-V, CCT7021-V, CCT7022-V, CCT7040-V, CCT7041-V, CCT7042-V, CCT7046-V, CCT7220V, CCT7221V, CCT7222V, CCT7240V, CCT7241V, CCT7242V, CCT7246V, CNE6230, CPD90100, CPD90100A, CPD90150, CPD90150A, CRE6-20, CRE6220, CRE6230, CRE6-30, CSE-045, CSE-048, CSE-050, CSE-053, CSE-060...(Otros modelos se puede ver en la tienda web)		

a 2 circuitos

			
1			
código	380027	referencia	CM293900 MACM293900
descripción	regulador de energía EGO 230V 13A doble circuito sentido de rotación derecho eje ø 6x4,6mm eje L 23mm rosca de sujeción M4 liberación potencia 6-70% N° 50.55021.100		
Para modelos:	CV72APS, CV72GPS, CV72TPS, CV74APS, CV74EPS, CV74GPS, CV74TPS, CV82APS, CV82GPS, CV82TPS, CV84APS, CV84EPS, CV84GPS, CV84TPS, CV92APS, CV92GPS, CV94APS, CV94GPS, CVY2TPS, CVY4TPS, DE72128, DE74228, DE82140, DE82142, DE82T42, DE84240, DE84242, DE84T42, DE92142, DE94242, DEY2142, DEY4242, ECV74, EDE72128, EDE73142, EDE74228, EDE92142, EDE93142, EDE94242, EDG72128, EDG73142, EDG74228, EDG92142, EDG93142, EDG94242, EPE7105, EPE7108, EPE9D10, EPE9D15, EPE9110...(Otros modelos se puede ver en la tienda web)		



termostatos

termostatos de control y seguridad

EGO

termostatos de regulación

serie 55.10/19_



código	375055	referencia	0101383 SIR0101383
descripción	termóstato T máx 110°C margen de trabajo 30-110°C 1 polos 1CO 16A sonda ø 6mm sonda L 130mm capilar 1500mm aislamiento del capilar mm prensaestopas eje L 23mm posición del eje arriba ángulo de rotación 318° 250V		
Para modelos:	CNE70160, CNE72160, DE74170		



código	375548	referencia	CR0682740
descripción	termóstato T máx 142°C margen de trabajo ajuste fijo 142°C 1 polos 1CO 16A sonda ø 4mm sonda L 157mm capilar 870mm aislamiento del capilar 870mm prensaestopas eje ø 6x4,6mm eje Lmm posición del eje		
Para modelos:	EPE7105, EPE7108, EPE9110, EPE9110A, EPE9115, EPE9115A, EPG7D05, EPG7105, EPG7108, EPG9115, EPG9115A, EPG9110A, EPGB9110A		



código	375341	referencia	0102492 SIR0102492
descripción	termóstato T máx 150°C margen de trabajo 60-150°C 1 polos 1NO 16A sonda ø 3mm sonda L 219mm capilar 900mm aislamiento del capilar 900mm prensaestopas eje ø 6x4,6mm eje L 23mm posición del eje arriba ángulo de rotación 270°		
Para modelos:	CNE90160, CNE90160S, CNE90160-S, CPE90100, CPE90100A, CPE90150, CPE90150A, CPI90100, CPI90100A, CPI90150, CPI90150A, DE94170, DEY4160, PE9A110, PE9A115, PE9N110, PE9N115		



código	375063	referencia	0101385 0109054 SIR0101385 SIR0109054
descripción	termóstato T máx 170°C margen de trabajo 70-170°C 1 polos 1NO 16A sonda ø 11mm sonda L 28mm capilar 900mm aislamiento del capilar 900mm prensaestopas eje L 23mm posición del eje arriba ángulo de rotación 270° sonda roscada rosca sonda M14x1		
Para modelos:	CFG60110, CFG60210		
accesorios para	375063		
	código	510417	referencia —
		junta plana fibra ø ext. 20mm int.ø 14mm espesor 2mm UE 1 pzs	
	código	510420	referencia —
		junta cobre ø ext. 19.9mm int.ø 14.3mm espesor 2mm UE 1 pzs	
	código	521133	referencia —
		tuerca rosca M14x1,5 H 6mm EC 19 acero zincado UE 1 pzs	



código	375270	referencia	0101377 SIO101377 SIR0101377
descripción	termóstato T máx 295°C margen de trabajo 45-295°C 1 polos 1NO 16A sonda ø 4mm sonda L 100mm capilar 900mm aislamiento del capilar 350mm prensaestopas eje L 23mm posición del eje arriba ángulo de rotación 270°		
Para modelos:	CBE7050, CBE7050C, CBE9060, CBE9060C, CBG9060C-I, CGE9020, CGE9020C, CGE9020R, CGE9020RC, CGE9021, CGE9021C, CGE9021R, CGE9021RC, CGE9022, CGE9022C, CGE9022R, CGE9022RC, CGE9040, CGE9040C, CGE9040LR, CGE9040LRC, CGE9040R, CGE9040RC, CGE9041, CGE9041C, CGE9041LR, CGE9041LRC, CGE9041R, CGE9041RC, CGE9042, CGE9042C, CGE9042LR, CGE9042LRC, CGE9042R, CGE9042RC, SE74CRM, SE74FRM, SE74IRM, SE84CRA, SE84CRM, SE84FRA, SE84FRM, SE84IRA, SE84IRM, SE94CRA, SE94CRM, SE94FRA, SE94FRM, SE94IRA, SE94IRM		



código	375184	referencia	0101382 1037102300 MA1037102300 SIR0101382
descripción	termóstato T máx 298°C margen de trabajo 55-294°C 1 polos 1NO 16A sonda ø 3.1mm sonda L 226mm capilar 870mm aislamiento del capilar 350mm prensaestopas eje L 23mm posición del eje arriba material de bulbo inox		
Para modelos:	SE86CRA, SE86FRA, SE86IRA, SE96CRA, SE96FRA, SE96IRA, SG86CRA, SG86FRA, SG86IRA, SG96CRA, SG96FRA, SG96IRA		



código	375332	referencia	0101390 1037118000 MA1037118000 SIR0101390
descripción	termóstato T máx 55°C margen de trabajo ajuste fijo 55°C 1 polos 1CO 16A sonda ø 9/15mm sonda L 22mm capilar 1500mm aislamiento del capilar 800mm prensaestopas		
Para modelos:	CRE6-20, CRE6220, CRE6230, CRE6-30, GE62TPS, GE63TPS		



código	375945	referencia	CR0734520
descripción	termóstato T máx 470°C margen de trabajo 90-470°C 1 polos 1NO 16A sonda ø 3.9mm sonda L 163mm capilar 870mm aislamiento del capilar 600mm eje ø 4,5x6mm eje L 23mm posición del eje arriba ángulo de rotación 270°		
Para modelos:	ETE74		



código	390040	referencia	0101376 0101403 MA7800300 SIR0101376 SIR0101403
descripción	termóstato T máx 90°C margen de trabajo 30-90°C 1 polos 1CO 16A sonda ø 6mm sonda L 130mm capilar 2040mm aislamiento del capilar 1940mm prensaestopas eje ø 6x4,6mm eje L 23mm posición del eje arriba ángulo de rotación 270° material de bulbo inox		
Para modelos:	BAC100, BAC100-A, BAC102, BAC120, BAC120-A, BAC122, BAC140, BAC140-A, BAC142, BAC160, BAC160-A, BAC162, BAC180, BAC180-A, BAC182, BAC200, BAC200-A, BAC202, BAM16D, BAM16S, BAM18D, BAM18S, BAM20D, BAM20S, CCG6045, CCG60652, CCG60653, CCG7045, CCG7046, CCG70652, CCG70653, CCG70663, CCG72653, CCG72663, CCQ7046, CCQ70663, CCT7046, CCT70663, CCW6020, CME1021, CME1022, CME6020, CME6030, CME6040, CME7020, CME7021, CME7022, CME7041, CME7042, CME7220...(Otros modelos se puede ver en la tienda web)		



código	375247	referencia	TERMO001
descripción	termóstato T máx 500°C margen de trabajo 75-500°C 1 polos 1NO 16A sonda ø 4mm sonda L 228mm capilar 900mm aislamiento del capilar 900mm prensaestopas eje ø 6x4,6mm eje L 23mm posición del eje arriba ángulo de rotación 270°		

E-G-O



código	375539	referencia	0101396 SIR0101396
descripción	termóstato T máx 90°C margen de trabajo 30-90°C 1 polos 1NO 16A sonda ø 6mm sonda L 130mm capilar 2450mm aislamiento del capilarmm prensaestopas eje ø 6x4,6mm eje L 23mm posición del eje arriba ángulo de rotación 270°		
Para modelos:	CCG1045, CCG10652, CCG10653, CCG1085, CCG10852, CCG9046, CCG90663, CCG91653, CCG91653-1, CCG91663, CCG91663-1, CCG9046, CCG90663, CTT9045, CTT9046, CTT90652R, CTT90653R, CTT90663R		

serie 55.13_

E-G-O

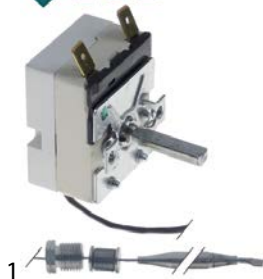

código	375492	referencia	0108014 SIR0108014
descripción	termóstato T máx 190°C margen de trabajo 94-190°C 1 polos 1NO 16A sonda ø 6mm sonda L 94mm capilar 1090mm aislamiento del capilar 960mm prensaestopas M10x1 eje ø 6x4,6mm eje L 23mm posición del eje arriba ángulo de rotación 310° material de bulbo inox		
Para modelos:	CFE70110, CFE70110-2, CFE70115, CFE70115-2, CFE70210, CFE70210-2, CFE70215, CFE70215-2, CFE72210, CFE72215, CFE90120, CFE90120-2, CFE90210, CFE90210-2, CFE90220, CFE90220-2, FE72210, FE92210		

serie 55.14_

E-G-O



código	375874	referencia	1037117700 MA1037117700
descripción	termóstato T máx 90°C margen de trabajo 30-90°C 1 polos 16A sonda ø 6mm sonda L 74mm capilar 900mm aislamiento del capilar 800mm prensaestopas M10x1 eje ø 6x4,6mm eje L 23mm posición del eje 180° posición del eje ángulo de rotación 270°		
Para modelos:	CCW6220, CME6220, CME6230, CME6240, CSP6220, CW62TPS, ERP72, ME62TPS, ME63TPS, ME64TPS, RP62TPS		

serie 55.34_

E-G-O

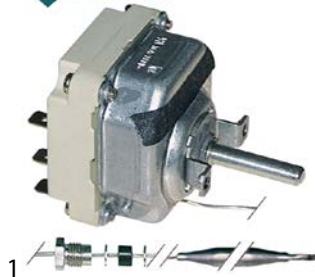

código	375021	referencia	0108112 SIR0108112
descripción	termóstato T máx 110°C margen de trabajo 32-110°C 3 polos 3CO 16A sonda ø 6mm sonda L 138mm capilar 2980mm aislamiento del capilar 2200mm prensaestopas M9x1 eje ø 6x4,6mm eje L 23mm posición del eje arriba ángulo de rotación 270°		
Para modelos:	CNE70130, CNE72130, CNE90130, CNE90130-S, CNE90140, CNE90140-S, CNE90230, CNE90240, DE72125, DE92140, DE94240		

E-G-O

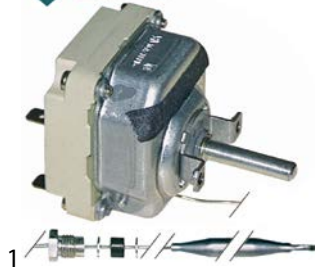

código	375143	referencia	0101388 SIR0101388
descripción	termóstato T máx 110°C margen de trabajo 32-110°C 3 polos 3NO 16A sonda ø 6mm sonda L 138mm capilar 1480mm aislamiento del capilar 1100mm prensaestopas M9x1 eje ø 6x4,6mm eje L 23mm posición del eje arriba ángulo de rotación 270°		

E-G-O



código	375097	referencia	0109055 SIR0109055
descripción	termóstato T máx 195°C margen de trabajo 95-195°C 3 polos 3NO 16A sonda ø 6mm sonda L 117mm capilar 1780mm aislamiento del capilar 1400mm prensaestopas M9x1 eje ø 6x4,6mm eje L 23mm posición del eje arriba ángulo de rotación 270°		
Para modelos:	CFE60110, CFE60110-5, CFE60110-9, CFE60210, CFE60210-5, CFE60210-9, CFE70110-0, CFE72110-0, FE72T10		



código	375559	referencia	CR0686120
descripción	termóstato T máx 230°C margen de trabajo 95-230°C 3 polos 3NO 16A sonda ø 4mm sonda L 128mm capilar 1250mm aislamiento del capilar 1000mm prensaestopas eje ø 6x4,6mm eje L 23mm posición del eje arriba ángulo de rotación 270°		
Para modelos:	EGVE7, EGVE92, EGVE94		



código	375268	referencia	0101373 SI0101373 SIR0101373
descripción	termóstato T máx 295°C margen de trabajo 75-295°C 3 polos 3NO 16A sonda ø 4mm sonda L 92mm capilar 900mm aislamiento del capilar 350mm prensaestopas eje ø 6x4,6mm eje L 23mm posición del eje arriba ángulo de rotación 270°		
Para modelos:	BE72ALC, BE72ALL, BE72ARR, BE72GLC, BE72GLL, BE72GRR, BE72TLC, BE72TLL, BE72TRR, BE74ALC, BE74ALL, BE74ALR, BE74ARC, BE74ARR, BE74GLC, BE74GLL, BE74GLR, BE74GMC, BE74GRR, BE74TLC, BE74TLL, BE74TLR, BE74TMC, BE74TRR, CGE6020, CGE6020C, CGE6020R, CGE6030, CGE6030C, CGE6030R, CGE6040, CGE6040C, CGE6040R, CGE7020, CGE7020C, CGE7020R, CGE7021, CGE7021C, CGE7021R, CGE7022, CGE7022C, CGE7022R, CGE7040, CGE7040C, CGE7040LR, CGE7040LRC, CGE7040R, CGE7041, CGE7041C, CGE7041LR...(Otros modelos se puede ver en la tienda web)		



código	375272	referencia	0101424 SI0101424 SIR0101424
descripción	termóstato T máx 240°C margen de trabajo 55-240°C 3 polos 3NO 16A sonda ø 4mm sonda L 91mm capilar 880mm aislamiento del capilar 350mm prensaestopas eje ø 6x4,6mm ángulo de rotación 270°		
Para modelos:	BE92ALC, BE92ALL, BE92ARC, BE92ARR, BE92GLC, BE92GLL, BE92GRC, BE92GRR, BE94ALC, BE94ALL, BE94ALR, BE94AMC, BE94ARC, BE94ARR, BE94GLC, BE94GLL, BE94GLR, BE94GMC, BE94GRC, BE94GRR, BEY2TLC, BEY2TLL, BEY2TRC, BEY2TRR, BEY4TLC, BEY4TLL, BEY4TLR, BEY4TMC, BEY4TRC, BEY4TRR, CGE9020-0, CGE9020-1, CGE9020-2, CGE9020-3, CGE9021-0, CGE9021-1, CGE9021-2, CGE9021-3, CGE9022-0, CGE9022-1, CGE9022-2, CGE9022-3, CGE9040-0, CGE9040-1, CGE9040-2, CGE9040-3, CGE9040-4, CGE9040-5, CGE9041-0, CGE9041-1...(Otros modelos se puede ver en la tienda web)		



código	375192	referencia	1309115 MA1309115
descripción	termóstato T máx 300°C margen de trabajo 50-300°C 3 polos 3NO 16A sonda ø 3mm sonda L 219mm capilar 900mm aislamiento del capilar 350mm prensaestopas eje ø 6x4,6mm eje L 23mm posición del eje arriba ángulo de rotación 270°		
Para modelos:	CBE6220, CM72APS, CM82APS, ECE7-E, ECE94E, ECG94E, ECG96E, ECM73, ECM93A, ECV94E, SE62TPS		

E·G·O



código	375412	referencia	0101384 BN6A044600 is not the 55.34064.030 SIR0101384
descripción	termóstato T máx 320°C margen de trabajo 50-320°C 3 polos 3NO 16A sonda ø 3.1mm sonda L 226mm capilar 1480mm aislamiento del capilar 1400mm prensaestopas eje ø 6x4,6mm eje L 23mm posición del eje arriba ángulo de rotación 318°		
Para modelos:	BE72ALC, BE72ALL, BE72ARR, BE72GLC, BE72GLL, BE72GRR, BE72TLC, BE72TLL, BE72TRR, BE74ALC, BE74ALL, BE74ALR, BE74ARC, BE74ARR, BE74GLC, BE74GLL, BE74GLR, BE74GMC, BE74GRR, BE74TLC, BE74TLL, BE74TLR, BE74TMC, BE74TRR, CCG60652, CCG60653, CCG7046, CCG7046P, CCG70662P, CCG70663, CCG7246, CCG72662, CCG72663, CCG9046P, CCG90662P, CCG9146, CCG9146-1, CCG91662, CCG91662-1, CCG91663, CCG91663-1, CCQ7046, CCQ70663, CCQ9046, CCQ9046V, CCQ90663, CCT6046, CCT7046, CCT70663, CCT7246V...(Otros modelos se puede ver en la tienda web)		

E·G·O



código	375944	referencia	CR0582770
descripción	termóstato T máx 350°C margen de trabajo 100-350°C 3 polos 3NOA sonda ø 3mm sonda L 147mm capilar 900mm aislamiento del capilarmm prensaestopas eje ø 6x4,6mm eje L 26mm posición del eje arriba ángulo de rotación 270° material de bulbo inox		
Para modelos:	EBE7, EBE92AL, EBE92ALC, EBE92AR, EBE92ARC, EBE92GL, EBE92GLC, EBE92GR, EBE92GRC, EBE92TL, EBE92TLC, EBE92TR, EBE92TRC, EBE93AL, EBE93ALC, EBE93ALR, EBE93AMC, EBE93GL, EBE93GLC, EBE93GLR, EBE93GMC, EBE93TL, EBE93TLC, EBE93TLR, EBE93TMC, EBE94AL, EBE94ALC, EBE94ALR, EBE94AMC, EBE94AR, EBE94GL, EBE94GLC, EBE94GLR, EBE94GMC, EBE94GR, EBE94TL, EBE94TLC, EBE94TLR, EBE94TMC, EBE94TR		

E·G·O

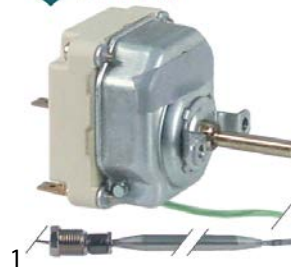

código	375411	referencia	0101406 1037035015 MA1037035015 SIR0101406
descripción	termóstato T máx 93°C margen de trabajo 30-93°C 3 polos 3NO 16A sonda ø 6mm sonda L 129mm capilar 1480mm aislamiento del capilar 1100mm prensaestopas M10x1 eje ø 6x4,6mm eje L 23mm posición del eje arriba ángulo de rotación 270°		
Para modelos:	CME9040, CME9041, CME9042, EME7, EME92A, EME92G, EME92T, EME94A, EME94G, EME94T, ME84GPS, ME94APS, ME94GPS, MEY4TPS		

termostatos de seguridad

serie 55.10/19_

E·G·O



código	375376	referencia	0108038 SIR0108038
descripción	termóstato de seguridad capilar 870mm sonda ø 6mm 1 polos sonda L 133mm 0.5A aislamiento del capilarmm prensaestopas M10x1 temp. desconexión 224°C bulbo		
Para modelos:	CFG70115, CFG70215, CFG72215, CFG90120, CFG90210, CFG90210S, CFG90220, FG92210, FGY2210		



E·G·O



código	375278	referencia	0101394 SIR0101394
descripción	termóstato de seguridad temp. desconexión 142°C 1 polos 16A sonda ø 6mm sonda L 74mm capilar 900mm aislamiento del capilar 900mm prensaestopas bulbo		
Para modelos:	CNE70160, CNE72160, DE74170		





1

código	375166	referencia	0101386 SIR0101386
descripción	termostato de seguridad temp. desconexión 230°C 1 polos 0.5A sonda ø 11mm sonda L 16.5mm capilar 850mm aislamiento del capilar 850mm prensaestopas bulbo sonda roscada rosca sonda M14x1		
accesorios para	375166		
	código	referencia	—
	521133		
	tuerca rosca M14x1,5 H 6mm EC 19 acero zincado UE 1 pzs		
	código	referencia	—
	532520		
	junta tórica silicona espesor 2.62mm int.ø 15.08mm UE 1 pzs		
	código	referencia	—
	550261		
	tuerca rosca M14x1 H 4mm EC 19 inox UE 1 pzs		



1

código	375282	referencia	0109053 SIR0109053
descripción	termostato de seguridad temp. desconexión 230°C 1 polos 16A sonda ø 11mm sonda L 28mm capilar 850mm aislamiento del capilar 830mm prensaestopas bulbo sonda roscada rosca sonda M14x1		
Para modelos:	CFG60110, CFG60210		
accesorios para	375282		
	código	referencia	—
	507313		
	junta tórica EPDM espesor 2.62mm int.ø 13.95mm UE 1 pzs		
	código	referencia	—
	510420		
	junta cobre ø ext. 19.9mm int.ø 14.3mm espesor 2mm UE 1 pzs		
	código	referencia	—
	521133		
	tuerca rosca M14x1,5 H 6mm EC 19 acero zincado UE 1 pzs		



1

código	375352	referencia	0109056 SIR0109056
descripción	termostato de seguridad temp. desconexión 245°C 1 polos 1NC 16A sonda ø 6mm sonda L 130mm capilar 1200mm aislamiento del capilar 1200mm prensaestopas bulbo		
Para modelos:	CFE60110, CFE60110-5, CFE60110-9, CFE60210, CFE60210-5, CFE60210-9, CFE70110-0, CFE72110-0, FE72T10		



1

código	375285	referencia	0101387 SIR0101387
descripción	termostato de seguridad temp. desconexión 327°C 1 polos 1NC 16A sonda ø 6mm sonda L 77mm capilar 870mm aislamiento del capilar 870mm prensaestopas bulbo inox		

serie 55.14_



1

código	375260	referencia	0108011 SIR0108011
descripción	termostato de seguridad temp. desconexión 240°C 1 polos 16A sonda ø 6mm sonda L 77mm capilar 1280mm aislamiento del capilar 1050mm prensaestopas M10x1 bulbo inox		

serie 55.32_

E-G-O



código	375537	referencia	0101395 SIR0101395
descripción	termostato de seguridad temp. desconexión 120°C 1 polos 0.5A sonda ø 4mm sonda L 120mm capilar 2500mm aislamiento del capilar 2500mm prensaestopas bulbo inox		
Para modelos:	CCG1045, CCG10652, CCG10653, CCG1085, CCG10852, CCG9046, CCG90663, CCG91653, CCG91653-1, CCG91663, CCG91663-1, CCQ9046, CCQ90663, CTT9045, CTT9046, CTT90652R, CTT90653R, CTT90663R		

E-G-O



código	375947	referencia	CR0585120
descripción	termostato de seguridad temp. desconexión 120°C 3 polos 20A sonda ø 6mm sonda L 94mm capilar 900mm aislamiento del capilar 850mm prensaestopas temperatura de conexión 111°C bulbo		
Para modelos:	EME7, EME92A, EME92G, EME92T, EME94A, EME94G, EME94T		

E-G-O



código	375275	referencia	0101404 SIR0101404
descripción	termostato de seguridad temp. desconexión 125°C 1 polos 0.5A sonda ø 4mm sonda L 120mm capilar 900mm aislamiento del capilar 900mm prensaestopas bulbo inox		
Para modelos:	CCG6045, CCG60652, CCG60653, CCG7045, CCG7046, CCG70652, CCG70653, CCG70663, CCG72653, CCG72663, CCQ7046, CCQ70663, CCT7046, CCT70663, CTT72653, CTT72653L		

E-G-O



código	375541	referencia	0101407 SIR0101407
descripción	termostato de seguridad temp. desconexión 125°C 3 polos 0.5A sonda ø 4mm sonda L 120mm capilar 900mm aislamiento del capilar 900mm prensaestopas bulbo inox		
Para modelos:	CME9020, CME9021, CME9022, CME9040, CME9041, CME9042, ME82GPS, ME84GPS, ME92APS, ME92GPS, ME94APS, ME94GPS, MEY2TPS, MEY4TPS		

E-G-O



código	375199	referencia	1878900 MA1878900
descripción	termostato de seguridad temp. desconexión 132°C 3 polos 2x20/1x0,5A sonda ø 6mm sonda L 77mm capilar 890mm aislamiento del capilarmm prensaestopas M10x1 bulbo inox		
Para modelos:	CNE6230, DE63128, DE72128, DE74228, DE82140, DE82142, DE82T42, DE84240, DE84242, DE84T42, DE92142, DE94242, DEY2142, DEY4242, EDE92142, EDE93142, EDE94242		

E-G-O

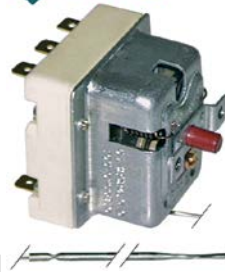

código	375281	referencia	0102493 SI0102493 SIR0102493
descripción	termostato de seguridad temp. desconexión 150°C 3 polos 0.5A sonda ø 3mm sonda L 188mm capilar 1100mm aislamiento del capilarmm prensaestopas bulbo inox		
Para modelos:	CNE90160, CNE90160S, CNE90160-S, CPE70150, CPE7-150, CPE90100, CPE90100A, CPE90150, CPE90150A, CPI70150, CPI90100, CPI90100A, CPI90100AP, CPI90100A-P, CPI90100P, CPI90100-P, CPI90150, CPI90150A, CPI90150AP, CPI90150A-P, CPI90150P, CPI90150-P, DE94170, DEY4160, PE7NI05, PE8AI10, PE8AI15, PE8NI10, PE8NI15, PE9AI10, PE9AI15, PE9NI10, PE9NI15, PG7ND05, PG7NI05, PG8AD10, PG8AD15, PG8AI10, PG8AI15, PG8ND10, PG8ND15, PG8NI10, PG8NI15, PG9AD10, PG9AD15, PG9AI10, PG9AI15, PG9ND10, PG9ND15, PG9NI10...(Otros modelos se puede ver en la tienda web)		



código	375277	referencia	0108113 SIR0108113
descripción	termostato de seguridad temp. desconexión 150°C 3 polos 3NC 20A sonda ø 6mm sonda L 79mm capilar 900mm aislamiento del capilar 700mm prensaestopas bulbo		
Para modelos:	CNE70130, CNE72130, CNE90130, CNE90130-S, CNE90140, CNE90140-S, CNE90230, CNE90240, DE72125, DE92140, DE94240		



código	375359	referencia	0105030 CM097700 SIR0105030
descripción	termostato de seguridad temp. desconexión 230°C 3 polos 2x20/1x0,5A sonda ø 4mm sonda L 120mm capilar 900mm aislamiento del capilar 900mm prensaestopas bulbo marmita		
Para modelos:	CFE62110/1, CFE62210/1, FE62T10, FE64T10, FE72112, FE72206, FE74212, FE82118, FE82206, FE82T18, FE84218, FE84T18, FE92118, FE92206, FE94218, FEY2118, FEY2206, FEY4218, FG72115, FG72206, FG74215, FG82122, FG82206, FG82T22, FG84222, FG84T22, FG92122, FG92206, FG94222, FGY2122, FGY2206, FGY4222		



código	375984	referencia	0108066
descripción	termostato de seguridad temp. desconexión 225°C 3 polos 3NC 20A sonda ø 6mm sonda L 94mm capilar 900mm aislamiento del capilar 670mm prensaestopas M10x1 bulbo inox		
Para modelos:	CFE90120, CFE90120-2, CFE90220, CFE90220-2		



código	375538	referencia	0108025 (NML)
descripción	termostato de seguridad temp. desconexión 230°C 3 polos bulbo		



código	375445	referencia	CM097701 MACM097701
descripción	termostato de seguridad temp. desconexión 230°C 3 polos 2x20/1x0,5A sonda ø 4mm sonda L 120mm capilar 900mm aislamiento del capilar 700mm prensaestopas bulbo		
Para modelos:	EFE72110, EFE72115, EFE73210, EFE74215, EFE92115, EFE92122, EFE92122K, EFE93210, EFE94215, EFE94222, EFE94222K, EFG72108, EFG72110, EFG72115, EFG73208T, EFG73210, EFG74215, EFG92115, EFG92115S, EFG92123, EFG92123K, EFG93210, EFG94215, EFG94215S, EFG94223, EFG94223K		



código	375258	referencia	0108065 SIR0108065
descripción	termostato de seguridad temp. desconexión 232°C 3 polos 20A sonda ø 6mm sonda L 94mm capilar 900mm aislamiento del capilar 670mm prensaestopas M10x1 bulbo inox		
Para modelos:	CFE70110, CFE70110-2, CFE70115, CFE70115-2, CFE70115-M, CFE70210, CFE70210-2, CFE70210-M, CFE70215, CFE70215-2, CFE70215-M, CFE72210, CFE72215, CFE90210, CFE90210-2, FE72210, FE92210		

E-G-O



código	375536	referencia	0108061 SIR0108061
descripción	termostato de seguridad temp. desconexión 245°C 3 polos 20A sonda ø 6mm sonda L 75mm capilar 900mm aislamiento del capilar 670mm prensaestopas M10x1 bulbo inox		

E-G-O

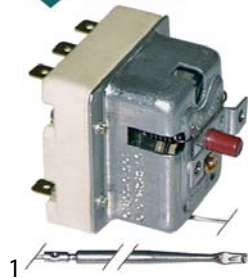

código	375284	referencia	0101425 SI0101425 SIR0101425
descripción	termostato de seguridad temp. desconexión 280°C 3 polos 20A sonda ø 4mm sonda L 120mm capilar 900mm aislamiento del capilar 900mm prensaestopas bulbo		
Para modelos:	BE92ALC, BE92ALL, BE92ARC, BE92ARR, BE92GLC, BE92GLL, BE92GRC, BE92GRR, BE94ALC, BE94ALL, BE94ALR, BE94AMC, BE94ARC, BE94ARR, BE94GLC, BE94GLL, BE94GLR, BE94GMC, BE94GRC, BE94GRR, BE92TLC, BE92TLL, BE92TRC, BE92TRR, BE94TLC, BE94TLL, BE94TLR, BE94TMC, BE94TRC, BE94TRR, BG92ALC, BG92ARC, BG92GLC, BG92GRC, BG94ALC, BG94AMC, BG94ARC, BG94GLC, BG94GMC, BG94GRC, BGY2TLC, BGY2TRC, BGY4TLC, BGY4TMC, BGY4TRC, CGE9020-0, CGE9020-1, CGE9020-2, CGE9020-3, CGE9021-0...(Otros modelos se puede ver en la tienda web)		

E-G-O

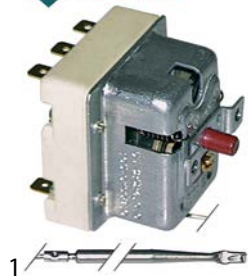

código	375279	referencia	0101372 SIR0101372
descripción	termostato de seguridad temp. desconexión 345°C 3 polos 20A sonda ø 4mm sonda L 120mm capilar 900mm aislamiento del capilar 900mm prensaestopas bulbo inox		
Para modelos:	BE72ALC, BE72ALL, BE72ARR, BE72GLC, BE72GLL, BE72GRR, BE72TLC, BE72TLL, BE72TRR, BE74ALC, BE74ALL, BE74ALR, BE74ARC, BE74ARR, BE74GLC, BE74GLL, BE74GLR, BE74GMC, BE74GRR, BE74TLC, BE74TLL, BE74TLR, BE74TMC, BE74TRR, CGE6020, CGE6020C, CGE6020R, CGE6030, CGE6030C, CGE6030R, CGE6040, CGE6040C, CGE6040R, CGE7020, CGE7020C, CGE7020R, CGE7021, CGE7021C, CGE7021R, CGE7022, CGE7022C, CGE7022R, CGE7040, CGE7040C, CGE7040LR, CGE7040LRC, CGE7040R, CGE7041, CGE7041C, CGE7041LR...(Otros modelos se puede ver en la tienda web)		

E-G-O

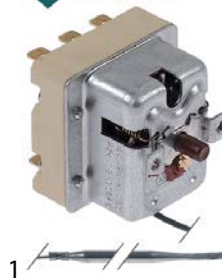

código	375392	referencia	0101375 SIR0101375
descripción	termostato de seguridad temp. desconexión 360°C 3 polos 1CO/2NC 20A sonda ø 4mm sonda L 120mm capilar 1490mm aislamiento del capilar 1450mm prensaestopas bulbo inox		
Para modelos:	BE72ALC, BE72ALL, BE72ARR, BE72GLC, BE72GLL, BE72GRR, BE72TLC, BE72TLL, BE72TRR, BE74ALC, BE74ALL, BE74ALR, BE74ARC, BE74ARR, BE74GLC, BE74GLL, BE74GLR, BE74GMC, BE74GRR, BE74TLC, BE74TLL, BE74TLR, BE74TMC, BE74TRR, BG72GLC, BG72TLC, BG74GLC, BG74GMC, CBE7050, CBE7050C, CBE9060, CBE9060C, CBG9060C-1, CCG60652, CCG60653, CCG7046, CCG7046P, CCG70662P, CCG70663, CCG7246, CCG72662, CCG72663, CCG9046P, CCG90662P, CCG9146, CCG9146-1, CCG91662, CCG91662-1, CCG91663, CCG91663-1...(Otros modelos se puede ver en la tienda web)		

E-G-O



código	375187	referencia	0105052 1878500 MA1878500
descripción	termostato de seguridad temp. desconexión 360°C 3 polos 3NC 2x20/1x0,5A sonda ø 6mm sonda L 79mm capilar 890mm aislamiento del capilarmm prensaestopas bulbo inox		
Para modelos:	BG62TLC, BG63TLC, BG64TLC, BG74TRR, BG82GLC, BG82TLC, BG84ALC, BG84AMC, BG84GLC, BG84GMC, BG84TLC, BG84TMC, CGG6220C, CGG6230C, CGG6240C, CM72APS, CM82APS, EBE7, EBE92AL, EBE92ALC, EBE92AR, EBE92ARC, EBE92GL, EBE92GLC, EBE92GR, EBE92GRC, EBE92TL, EBE92TLC, EBE92TR, EBE92TRC, EBE93AL, EBE93ALC, EBE93ALR, EBE93AMC, EBE93GL, EBE93GLC, EBE93GLR, EBE93GMC, EBE93TL, EBE93TLC, EBE93TLR, EBE93TMC, EBE94AL, EBE94ALC, EBE94ALR, EBE94AMC, EBE94AR, EBE94GL, EBE94GLC, EBE94GLR...(Otros modelos se puede ver en la tienda web)		



imagen no disponible

código	375283	referencia	0101401 SIR0101401
descripción	termostato de seguridad temp. desconexión 360°C 3 polos aislamiento del capilarmm prensaestopas bulbo		
Para modelos:	CGG6020C, CGG6030C, CGG6040C		



código	375890	referencia	0101371 SIR0101371
descripción	termostato de seguridad temp. desconexión 650°C 3 polos temperatura de conexión 624°C		
Para modelos:	CTE9141, CTE9142, CTE9142S, CTE9146, TE94APS, TE94EPS, TE94GPS, TE94APS		



código	375946	referencia	CR0581280
descripción	termostato T máx 350°C margen de trabajo 100-350°C 1 polos 1NO 16A sonda ø 3mm sonda L 145mm capilar 900mm aislamiento del capilar 800mm prensaestopas eje ø 4,5x6mm eje L 25mm posición del eje arriba ángulo de rotación 275° interruptor auxiliar 2NC		
Para modelos:	ESE74, ESE94CRA, ESE94CRM, ESE94FRA, ESE94FRM, ESE96CRA, ESE96FRA, ESG94CRA, ESG94CRM, ESG94FRA, ESG94FRM, ESG96CRA, ESG96FRA		

termostatos de regulación con interruptor auxiliar

serie 55.10/19_



código	375180	referencia	0109170 CR0589660 SIR0109170
descripción	termostato T máx 185°C margen de trabajo 99-185°C 1 polos 1NO 0.5A sonda ø 4mm sonda L 235mm capilar 870mm aislamiento del capilar 700mm prensaestopas eje ø 6x4,6mm eje L 23mm posición del eje arriba ángulo de rotación 270° interruptor auxiliar 2NO		
Para modelos:	EFE72110, EFE72115, EFE73210, EFE74215, EFE92115, EFE92122, EFE93210, EFE94215, EFE94222		



código	375140	referencia	CR0688650
descripción	termostato T máx 650°C margen de trabajo 50°C/50-600°C/70-650°C 3 polos 3NO 16A sonda ø 4mm sonda L 228mm capilar 1200mm aislamiento del capilar 1200mm prensaestopas eje ø 6x4,6mm eje L 23mm posición del eje izquierdo ángulo de rotación 318° interruptor auxiliar 2NO		
Para modelos:	ECV92A, ECV92G, ECV92T, ECV94A, ECV94E, ECV94G, ECV94T		



código	375331	referencia	0105028 CM097800 MACM097800 SIR0105028
descripción	termostato T máx 189°C margen de trabajo 62-189°C 1 polos 1NO 0.5A sonda ø 4mm sonda L 116mm capilar 900mm aislamiento del capilar 700mm prensaestopas eje ø 6x4,6mm eje L 23mm posición del eje arriba ángulo de rotación 270° interruptor auxiliar 2NO		
Para modelos:	CFE62110/1, CFE62210/1, FE62T10, FE64T10, FE72112, FE72206, FE72T10, FE74212, FE74T10, FE82118, FE82206, FE82T18, FE84218, FE84T18, FE92118, FE92206, FE94218, FEY2118, FEY2206, FEY4218, FG82122, FG82T22, FG84222, FG84T22, FG92122, FG94222, FGY2122, FGY4222		

accesorios

clips para bulbo

resortes de fijación

para termostato de seguridad



código	551080	referencia	0105032 1033515800 MA1033515800 SIR0105032
descripción	clip para bulbo para tubo ø 8.5mm para sonda ø 4mm UE 1 pzs		
Para modelos:	CFE62110/1, CFE62210/1, EFE72110, EFE72115, EFE73210, EFE74215, EFE92115, EFE92122, EFE92122K, EFE93210, EFE94215, EFE94222, EFE94222K, FE62T10, FE64T10, FE72112, FE72206, FE72T10, FE74212, FE74T10, FE82118, FE82206, FE84218, FE92118, FE92206, FE94218, FEY2118, FEY2206, FEY4218		



	código	357082	referencia	CR0685490
1	descripción	resorte de fijación para sonda L 22mm An 19mm		
Para modelos:	EGVE7			

accesorios para prensaestopas

tornillos de fijación

	código	106605	referencia	0105033 CM012401 MACM012401 SIR0105033
1	descripción	tornillo de racor rosca M10x1 sonda ø máx. 4.5mm		
Para modelos:	CFE62110/1, CFE62210/1, EFE72115, EFE74215, EFE92115, EFE92122, EFE92122K, EFE93210, EFE94215, EFE94222, EFE94222K, EFG72108, EFG72110, EFG72115, EFG73208T, EFG73210, EFG74215, EFG92115, EFG92115S, EFG92123, EFG92123K, EFG93210, EFG94215, EFG94215S, EFG94223, EFG94223K, FE62T10, FE64T10, FE72112, FE72206, FE72T10, FE74212, FE74T10, FE82118, FE82206, FE82T18, FE84218, FE84T18, FE92118, FE92206, FE94218, FEY2118, FEY2206, FEY4218, FG72115, FG72206, FG74215, FG82122, FG82206, FG82T22... (Otros modelos se puede ver en la tienda web)			



estribos de unión

	código	550060	referencia	0101378 921200 MA921200 SIR0101378
1	descripción	estribo de unión largo para termostato UE 1 pzs		
Para modelos:	BE72ALC, BE72ALL, BE72ARR, BE72GLC, BE72GLL, BE72GRR, BE72TLC, BE72TLL, BE72TRR, BE74ALC, BE74ALL, BE74ALR, BE74ARC, BE74ARR, BE74GLC, BE74GLL, BE74GLR, BE74GMC, BE74GRR, BE74TLC, BE74TLL, BE74TLR, BE74TMC, BE74TRR, BE82ALC, BE82ALL, BE82ARR, BE82GLC, BE82GLL, BE82GRR, BE82TLC, BE82TLL, BE82TRR, BE84ALC, BE84ALL, BE84ALR, BE84AMC, BE84ARR, BE84GLC, BE84GLL, BE84GLR, BE84GMC, BE84GRR, BE84TLC, BE84TLL, BE84TLR, BE84TMC, BE84TRR, BE92ALC, BE92ALL... (Otros modelos se puede ver en la tienda web)			

interruptores y pulsadores
interruptores/pulsadores basculantes

30x22mm

	código	347791	referencia	4640500 MA4640500
1	descripción	interruptor basculante medida de montaje 30x22mm verde 2NO 230V 20A iluminado 0-I empalme conector Faston 6,3mm temperatura ambiente máx. 125/55°C protección IP65 con protección en goma		
Para modelos:	CCW6220, CME6220, CME6230, CME6240, CRE6220, CRE6230, CSP6220, CW62TPS, GE62TPS, GE63TPS, ME62TPS, ME63TPS, ME64TPS, RP62TPS			

	código	301003	referencia	0109015 SIR0109015	
1	descripción	interruptor basculante medida de montaje 30x22mm verde 2NO 250V 16A iluminado 0-I empalme conector Faston 6,3mm temperatura ambiente máx. 125/55°C protección IP65			
Para modelos:	BAC100, BAC100-A, BAC102, BAC120, BAC120-A, BAC122, BAC140, BAC140-A, BAC142, BAC160, BAC160-A, BAC162, BAC180, BAC180-A, BAC182, BAC200, BAC200-A, BAC202, BAM16D, BAM16S, BAM18D, BAM18S, BAM20D, BAM20S, CCW6020, CFG60110, CFG60210, CME6020, CME6030, CME6040, CME7020, CME7021, CME7022, CME7041, CME7042, CME7220, CME7221, CME7222, CME7241, CME7242, CRE6-20, CRE6-30, CSP6020, CSP7020, ME72APS, ME72GPS, ME72TPS, ME74APS, ME74GPS, RP72TPS... (Otros modelos se puede ver en la tienda web)				
accesorios para	301003	código	301036	referencia	—
	cubierta protectora dimensión interior 30x22mm para interruptor basculante medida de montaje mm				

interruptores pulsantes y pulsadores

ø25mm

	código	345038	referencia	0101188 CR0410290 SIR0101188
1	descripción	pulsador montaje ø 25mm negro 2NO 250V 16A empalme conector Faston 6,3mm temperatura ambiente máx. 85°C protección IP40		
Para modelos:	CCG1045, CCG10652, CCG10653, CCG1085, CCG10852, CCG7001, CCG7020, CCG7021, CCG7022, CCG7040, CCG7041, CCG7042, CCG7045, CCG7046, CCG7061, CCG7062, CCG70652, CCG70653, CCG70663, CCG7201, CCG7220, CCG7221, CCG7222, CCG7240, CCG7241, CCG7242, CCG7245, CCG7246, CCG7261, CCG7262, CCG72652, CCG72653, CCG72662, CCG72663, CCG9046, CCG90663, CCG9145, CCG9145-1, CCG91652, CCG91652-1, CCG91653, CCG91653-1, CCG9185, CCG9185-1, CCG91852, CCG91852-1, CFS9050, CFS9052, CFS9055, CG76GPS... (Otros modelos se puede ver en la tienda web)			

	código	345039	referencia	CR0410310	
1	descripción	cubierta protectora redondo ø ext. 33mm dimensiones exteriores 23mm dimensión interior 21mm H 12mm claro montaje ø 25mm			
Para modelos:	EME92A, EME92G, EME92T, EME94A, EME94G, EME94T, ESE94CRA, ESE94CRM, ESE94FRA, ESE94FRM, ESE96CRA, ESE96FRA, ESG94CRA, ESG94CRM, ESG94FRA, ESG94FRM, ESG96CRA, ESG96FRA				
accesorios para	345039	código	345001	referencia	—
	pulsador montaje ø 25mm amarillo 1NO/lámpara 250V 16A cubierta empalme conector Faston 6,3mm temperatura ambiente máx. 85°C protección IP65				

microinterruptores

accionado por palanca



1

código	345345	referencia	0108059 SIR0108059
descripción	microinterruptor con manilla 250V 16A 1CO empalme conector Faston 6,3mm L 78mm temperatura ambiente máx. 85°C distancia de sujeción 22mm tipo X662-88-J27 fuerza de accionamiento: 40g longitud de palanca 69mm		
Para modelos:	CFE70110, CFE70110-2, CFE70115, CFE70115-2, CFE70115-M, CFE70210, CFE70210-2, CFE70210-M, CFE70215, CFE70215-2, CFE70215-M, CFE72210, CFE72215, CFE90120, CFE90120-2, CFE90210, CFE90210-2, CFE90220, CFE90220-2, FE72210, FE92210		



1

código	345254	referencia	0105025 1037111300 MA1037111300 SIR0105025
descripción	microinterruptor con manilla 250V 16A 1CO empalme conector Faston 6,3mm temperatura ambiente máx. 120°C distancia de sujeción 22mm fuerza de accionamiento: 60g longitud de palanca 58mm		
Para modelos:	CFE62110/1, CFE62210/1, EFE72110, EFE72115, EFE73210, EFE74215, EFE92115, EFE92122, EFE92122K, EFE93210, EFE94215, EFE94222, EFE94222K, ESE74, ESE94CRA, ESE94CRM, ESE94FRA, ESE94FRM, ESE96CRA, ESE96FRA, ESG94CRA, ESG94CRM, ESG94FRA, ESG94FRM, ESG96CRA, ESG96FRA, FE62T10, FE64T10, FE72112, FE72206, FE72T10, FE74212, FE74T10, FE82118, FE82206, FE82T18, FE84218, FE84T18, FE92118, FE92206, FE94218, FEY2118, FEY2206, FEY4218		



1

código	345044	referencia	0101181 SIR0101181
descripción	microinterruptor con manilla 250V 16A 1CO empalme conector Faston 6,3mm temperatura ambiente máx. 85°C distancia de sujeción 25mm tipo C99ZP3 fuerza de accionamiento: 25g longitud de palanca 71mm		
Para modelos:	CBE7050, CBE7050C, SE74CRM, SE74FRM, SE74IRM, SE84CRM, SE84FRM, SE84IRM		

accionados por pistón

M12



1

código	345350	referencia	0101180 0103452 LAR65260530 LAR65260540 SIR0101180 SIR0103452
descripción	microinterruptor con varilla distancia de sujeción 22mm rosca M12x0,75 rosca L 16mm 250V 16A 1CO empalme conector Faston 6,3mm carrera 4mm temperatura ambiente máx. 125°C tipo EF83161.3 fuerza de accionamiento: 66g		
Para modelos:	CFE60110, CFE60210, CFE70110-0, CFE72110-0, FE72T10		
accesorios para	345350		
		código	345351 referencia —
	tuerca rosca M12x0,75 H 1.6mm EC 14 latón cromado UE 1 pzs		

con tecla

encendido gas



1

código	100010	referencia	0101184 SIR0101184
descripción	microinterruptor con tecla 250V 10A 1CO empalme conector Faston 6,3mm temperatura ambiente máx. 85°C distancia de sujeción 22mm fuerza de accionamiento: 360g rosca L 15mm rosca M10x0,75		
Para modelos:	CME7021, CME7022, CME7041, CME7042, CME7221, CME7222, CME7241, CME7242, ME72APS, ME72GPS, ME74APS, ME74GPS		

interruptores posicionales

SIEMENS

serie 3SE2

interruptores de posición completos



1

código	345349	referencia	0101177 SIR0101177
descripción	interruptor de posición con manilla		
Para modelos:	CBE9060, CBE9060C, CBG9060C-I, SE84CRA, SE84FRA, SE84IRA, SE94CRA, SE94CRM, SE94FRA, SE94FRM, SE94IRA, SE94IRM, SG84CRA, SG84IRA, SG94CRA, SG94FRA, SG94IRA		



commutadores de levas

conect./desc.



código	300088	referencia	0108007 SIR0108007
descripción	commutador de levas 2 posiciones de conmutación 4NO secuencia de conmutación 0-1 16A eje ø 6x4,6mm eje L 23mm empalme conector Faston 6,3mm cerámica		
Para modelos:	CFE70115, CFE70115-2, CFE70115-M, CFE70210-M, CFE70215, CFE70215-2, CFE70215-M, CFE72215, CFE90210, CFE90210-2, FE92210		

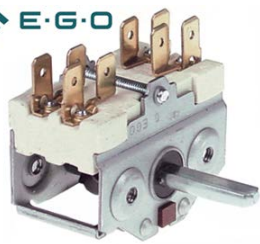

código	300074	referencia	0101380 SI0101380 SIR0101380
descripción	commutador de levas 4 posiciones de control 2NO secuencia de conmutación 0-1-0-1 16A eje ø 6x4,6mm eje L 23mm empalme conector Faston 6,3mm cerámica		
Para modelos:	CBE9060, CBE9060C, CBG9060C-I, CCG1045, CCG10652, CCG10653, CCG1085, CCG10852, CCG60652, CCG60653, CCG7045, CCG7046, CCG70652, CCG70653, CCG70663, CCG72653, CCG72663, CCG9046, CCG90663, CCG91653, CCG91653-1, CCG91663, CCG91663-1, CCQ7046, CCQ70663, CCQ9046, CCQ90663, CCT7046, CCT70663, CGE9020, CGE9020C, CGE9020R, CGE9020RC, CGE9021, CGE9021C, CGE9021R, CGE9021RC, CGE9022, CGE9022C, CGE9022R, CGE9022RC, CGE9040, CGE9040C, CGE9040LR, CGE9040LRC, CGE9040R, CGE9040RC, CGE9041, CGE9041C, CGE9041LR...(Otros modelos se puede ver en la tienda web)		



código	300021	referencia	1230100 MA1230100
descripción	commutador de levas 4 posiciones de control 4NO secuencia de conmutación 0-1-0-1 16A eje ø 6x4,6mm eje L 23mm empalme atornillado cerámica		
Para modelos:	EFE92122K, EFE94222K, EFG92123K, EFG94223K, EME7, EME92A, EME92G, EME92T, EME94A, EME94G, EME94T, ERP72		



código	300095	referencia	0109058 SIR0109058
descripción	commutador de levas CON.-DESC. empalme borne roscado		
Para modelos:	CFE60110-5, CFE60110-9, CFE60210-5, CFE60210-9		

4 posiciones



código	300104	referencia	0101400 SIR0101400
descripción	commutador de levas 4 posiciones de control 3NO/1CO secuencia de conmutación 0-1-2-3 32A eje ø 6x4,6mm eje L 23mm empalme atornillado cerámica		
Para modelos:	CNE6030		

7 posiciones



código	300025	referencia	0101423 1616100 MA1616100 SIR0101423
descripción	commutador de levas 7 posiciones de conmutación 1NO/2CO secuencia de conmutación 0-1-2-3-4-5-6 16A eje ø 6x4,6mm eje L 23mm empalme atornillado 7 posiciones cerámica		
Para modelos:	CCQ7020, CCQ7021, CCQ7022, CCQ7040, CCQ7041, CCQ7042, CCQ7046, CCQ7061, CCQ7062, CCQ70663, CCQ7220, CCQ7221, CCQ7222, CCQ7240, CCQ7241, CCQ7242, CCQ7246, CCQ7261, CCQ7262, CCQ9020, CCQ9021, CCQ9022, CCQ9040, CCQ9041, CCQ9042, CCQ9046, CCQ9060, CCQ9061, CCQ9062, CCQ90663, CCT6020, CCT6040, CCT6046, CCT7020, CCT7021, CCT7022, CCT7040, CCT7041, CCT7042, CCT7046, CCT7061, CCT7062, CCT70663, CCT7220, CCT7221, CCT7222, CCT7240, CCT7241, CCT7242, CCT7246...(Otros modelos se puede ver en la tienda web)		

accesorios para	300025	código	112172	referencia	—	
			pomo universal ø 70mm negro sin adaptador/símbolo			
			código	112213	referencia	—
			símbolo para pomo plata interruptor 7 posiciones T máx°C°C ø ext. 63mm int.ø 45.5mm			

Continúa en la página siguiente

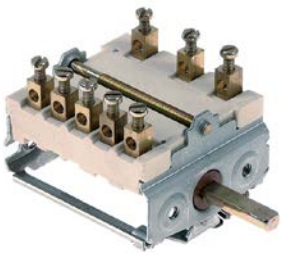

accesorios para	300025			
	código	112311	referencia	—
	adaptador de pomo eje ø 6x4,6mm L 0mm con muelle			

			
1			
código	300106	referencia	0101399 1937800 MA1937800 SIR0101399
descripción	conmutador de levas 7 posiciones de conmutación 1NO/2CO secuencia de conmutación 0-1-2-3-4-5-6 32A eje ø 6x4,6mm eje L 23mm empalme atornillado 7 posiciones parte plana arriba		
Para modelos:	CCQ9020, CCQ9021, CCQ9022, CCQ9040, CCQ9041, CCQ9042, CCQ9046, CE82APQ, CE82GPQ, CE82TPQ, CE84APQ, CE84EPQ, CE84PQ, CE84TPQ, CE92APQ, CE92GPQ, CE92TPQ, CE94APQ, CE94EPQ, CE94GPQ, CE94TPQ, CEY2TPQ, CEY4TPQ		

3 posiciones de conmutación			
			
1			
código	347015	referencia	0101420 SIR0101420
descripción	conmutador de levas 3-posiciones de conmutación secuencia de conmutación 0-1-2 eje ø 6x4,6mm empalme empalme atornillado		
Para modelos:	CTE9141, CTE9142, CTE9142S, CTE9146, TE94APS, TE94EPS, TE94GPS, TEY4APS		

4 posiciones de conmutación			
			
1			
código	300081	referencia	0101397 1309000 MA1309000 SIR0101397
descripción	conmutador de levas 4 posiciones de control 3NO/2CO secuencia de conmutación 0-1-2-3 16A eje ø 6x4,6mm eje L 23mm empalme atornillado		
Para modelos:	CCG60652, CCG60653, CCG7046, CCG7046P, CCG70662P, CCG70663, CCG7246, CCG72662, CCG72663, CCG9146, CCG9146-1, CCG91662, CCG91662-1, CCG91663-1, CCQ7046, CCQ70663, CCT7046, CCT70663, CCT7246V, CE84EPQ, CG74EPS, CG76EPS, CG84EPS, CV74EPS, ECE7-E, ECE94E, ECG94E, ECG96E, ECV94E		

			
1			
código	300239	referencia	CR0581810
descripción	interruptor auxiliar 4 posiciones de control 4NO secuencia de conmutación 0-1-2-3 16A eje ø 6x4,6mm eje L 23mm empalme conector Faston 6,3mm plástico		
Para modelos:	EDE72128, EDE73142, EDE74228, EDE92142, EDE93142, EDE94242, EDG72128, EDG73142, EDG74228, EDG92142, EDG93142, EDG94242, EPE50, EPE7108, EPE9D10, EPE9D15, EPE9I10, EPE9I10A, EPE9I15, EPE9I15A, EPG50, EPG7108, EPG9D10, EPG9D10A, EPG9D15, EPG9D15A, EPG9I15, EPG9I15A, EPGB9I10, EPGB9I10A		

interruptor auxiliar				
				
1				
código	300080	referencia	0101379 65085010 710300 MA710300 R65085010 SIR0101379	
descripción	conmutador de levas 2 posiciones de conmutación 4NO 16A secuencia de conmutación 0-1 eje ø 6x4,6mm eje L 23mm empalme atornillado interruptor cerámica temperatura ambiente máx. 150°C			
Para modelos:	BE82ALC, BE82ALL, BE82ARR, BE82GLC, BE82GLL, BE82GRR, BE82TLC, BE82TLL, BE82TRR, BE84ALC, BE84ALL, BE84ALR, BE84AMC, BE84ARR, BE84GLC, BE84GLL, BE84GLR, BE84GMC, BE84GRR, BE84TLC, BE84TLL, BE84TLR, BE84TMC, BE84TRR, BE92ALC, BE92ALL, BE92ARC, BE92ARR, BE92GLC, BE92GLL, BE92GRC, BE92GRR, BE94ALC, BE94ALL, BE94ALR, BE94AMC, BE94ARC, BE94ARR, BE94GLC, BE94GLL, BE94GLR, BE94GMC, BE94GRC, BE94GRR, BEY2TLC, BEY2TLL, BEY2TRC, BEY2TRR, BEY4TLC, BEY4TLL...(Otros modelos se puede ver en la tienda web)			
accesorios para	300080			
	código	551456	referencia	—
	junta para interruptor ø ext. 14mm int.ø 2.5mm espesor 3.5mm blanco			



1

código	300002	referencia	0101398 6A046001 BN6A046001 SIR0101398
descripción	conmutador de levas 2 posiciones de conmutación 4NO 16A secuencia de conmutación 0-1 eje ø 6x4,6mm eje L 23mm empalme conector Faston 6,3mm cerámica		
Para modelos:	BE72ALC, BE72ALL, BE72ARR, BE72GLC, BE72GLL, BE72GRR, BE72TLC, BE72TLL, BE72TRR, BE74ALC, BE74ALL, BE74ALR, BE74ARC, BE74ARR, BE74GLC, BE74GLL, BE74GLR, BE74GMC, BE74GRR, BE74TLC, BE74TLL, BE74TLR, BE74TMC, BE74TRR, CCG9046P, CCG90662P, CCG9146, CCG9146-1, CCG91662, CCG91662-1, CCG91663, CCG91663-1, CCQ9046, CCQ9046V, CCQ90663, CE94EPQ, CFS9060, CFS9062, CFS9066, CG94EPS, CG96EPS, CGE6020, CGE6020C, CGE6020R, CGE6030, CGE6030C, CGE6030R, CGE6040, CGE6040C, CGE6040R... (Otros modelos se puede ver en la tienda web)		

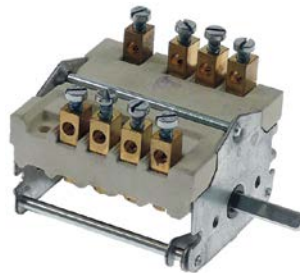

1

código	300180	referencia	CR0686110
descripción	conmutador de levas 2 posiciones de conmutación interruptor 32A secuencia de conmutación 0-1 eje ø 6x4,6mm eje L 23mm empalme atornillado cerámica		
Para modelos:	EBE7, EBE92AL, EBE92ALC, EBE92AR, EBE92ARC, EBE92GL, EBE92GLC, EBE92GR, EBE92GRC, EBE92TL, EBE92TLC, EBE92TR, EBE92TRC, EBE93AL, EBE93ALC, EBE93ALR, EBE93AMC, EBE93GL, EBE93GLC, EBE93GLR, EBE93GMC, EBE93TL, EBE93TLC, EBE93TLR, EBE93TMC, EBE94AL, EBE94ALC, EBE94ALR, EBE94AMC, EBE94AR, EBE94GL, EBE94GLC, EBE94GLR, EBE94GMC, EBE94GR, EBE94TL, EBE94TLC, EBE94TLR, EBE94TMC, EBE94TR, EGVE92, EGVE94		



2

código	300166	referencia	0108026 SIR0108026
descripción	conmutador de levas 2 posiciones de conmutación 4NO 16A secuencia de conmutación 0-1 eje ø 6x4,6mm eje L 23mm empalme conector Faston 6,3mm cerámica 4 polos temperatura ambiente máx. 318°C		
Para modelos:	CFE70110, CFE70110-2, CFE70210, CFE70210-2, CFE72210, CNE70130, CNE72130, DE72125, FE72210		



1

código	300091	referencia	0109057 SIR0109057
descripción	interruptor auxiliar EGO 2 posiciones de conmutación 2NO 16A secuencia de conmutación 0-1 eje ø 6x4,6mm eje L 23mm empalme atornillado cerámica		
Para modelos:	CFE60110, CFE60210		

conmutadores giratorios

BREMAS

serie A3200



1

código	345817	referencia	0108008 SIR0108008
descripción	conmutador giratorio 2 0-1 juegos de contactos 4 tipo CS0327690 600V 32A eje ø 5x5mm eje L 26mm eje cuadrado empalme atornil- lado		
Para modelos:	CFE70115, CFE70115-2, CFE70215, CFE70215-2, CFE72215, CFE90120, CFE90120-2, CFE90220, CFE90220-2		

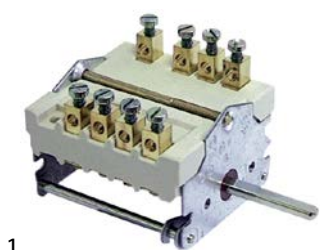

1

código	300107	referencia	0108074 SIR0108074
descripción	conmutador de levas 2 posiciones de conmutación interruptor 32A secuencia de conmutación 0-1 eje ø 6x4,6mm eje L 23mm empalme atornillado cerámica		
Para modelos:	CFE70110, CFE70110-2, CFE70210, CFE70210-2, CFE90210, CFE90210- 2		

aparatos de mando y aviso

MOELLER/EATON

interruptor completo

interruptores pulsantes y pulsadores



1			
código	346172	referencia	0101392 SIR0101392
descripción	pulsador medida de montaje ø22mm rojo completo		
Para modelos:	CPE70150, CPE7-150, PE7NI05		

SIEMENS

serie 3SB ø22mm antiguo

selectores giratorios



1			
código	345526	referencia	0102505 SI0102505 SIR0102505
descripción	selector giratorio medida de montaje ø22mm secuencia de conmutación 0-1 con enclavamiento negro		
Para modelos:	CPE90100, CPE90100A, CPE90150, CPE90150A, PE7NI05, PE8AI10, PE8AI15, PE8NI10, PE8NI15, PE9AI10, PE9AI15, PE9NI10, PE9NI15		

serie 3SB ø22mm nuevo



1			
código	346630	referencia	CR0413790
descripción	bloque de contacto SIEMENS 3SB3400-0B 1NO máx. 400V 10A negro		
accesorios para	346630		
	código	347520	referencia —
	tecla medida de montaje ø22mm sin iluminación negro		



1			
código	346602	referencia	CR0687390
descripción	bloque de contacto SIEMENS 3SB3400-0D 2NO máx. 400V 10A negro		
Para modelos:	ESE94CRA, ESE94CRM, ESE94FRA, ESE94FRM, ESE96CRA, ESE96FRA, ESG94CRA, ESG94CRM, ESG94FRA, ESG94FRM, ESG96CRA, ESG96FRA		

interruptor completo



1			
código	346174	referencia	0102474 SIR0102474
descripción	pulsador medida de montaje ø22mm		
Para modelos:	CBG9060C-I, CPD90100, CPD90100A, CPD90150, CPD90150A, CPI90100, CPI90100A, CPI90150, CPI90150A, PG9AD10, PG9AD15, PG9AI10, PG9AI15, PG9ND10, PG9ND15, PG9NI10, PG9NI15		







1			
código	345316	referencia	0102475 SIR0102475
descripción	pulsador medida de montaje ø22mm completo		
Para modelos:	CBE9060, CBE9060C, CBG9060C-I, SE94CRA, SE94CRM, SE94FRA, SE94FRM, SE94IRA, SE94IRM		



selectores giratorios



1			
código	346629	referencia	CR0413380
descripción	selector giratorio medida de montaje ø22mm negro a impulso secuencia de conmutación 1-0-2		
Para modelos:	ESE94CRA, ESE94CRM, ESE94FRA, ESE94FRM, ESE96CRA, ESE96FRA, ESG94CRA, ESG94CRM, ESG94FRA, ESG94FRM, ESG96CRA, ESG96FRA, SE84CRA, SE84FRA, SE84IRA, SE94CRA, SE94FRA, SE94IRA, SG84CRA, SG84IRA, SG94CRA, SG94FRA, SG94IRA		

accesorios para	346629		
	código	346602	referencia CR0687390
	bloque de contacto SIEMENS 3SB3400-0D 2NO máx. 400V 10A negro		
	código	346603	referencia —
	bloque de contacto SIEMENS 3SB3400-0E 2NC máx. 400V 10A negro		
	código	346630	referencia CR0413790
	bloque de contacto SIEMENS 3SB3400-0B 1NO máx. 400V 10A negro		
	código	346631	referencia —
	bloque de contacto SIEMENS 3SB3400-0C 1NC máx. 400V 10A negro		
	código	346632	referencia —
	bloque de contacto SIEMENS 3SB3400-0D 1NC/1NO máx. 400V 10A negro		

lámparas

			
1			
código	359606	referencia	0102476 SIR0102476
descripción	lámpara de neón casquillo Ba9s 220V 2W claro ø 10mm L 28mm		
Para modelos:	CPD90100, CPD90100A, CPD90150, CPD90150A, CPI90100, CPI90100A, CPI90150, CPI90150A		
accesorios para	359606		
	código	359832	referencia —
portalámparas medida de montaje ø16,2mm casquillo Ba9s empalme conector Faston 6,3mm			
	código	359853	referencia —
portalámparas medida de montaje ø18,2mm casquillo Ba9s empalme conector Faston 6,3mm			

lámparas de señalización completas

ø10mm

con casquillo roscado

			
1			
código	359379	referencia	CR0587500
descripción	lámpara de señalización ø 10mm 230V amarillo empalme conector Faston 6,3mm casquillo portalámpara roscado		
Para modelos:	EBE7, EBE92AL, EBE92ALC, EBE92AR, EBE92ARC, EBE92GL, EBE92GLC, EBE92GR, EBE92GRC, EBE92TL, EBE92TLC, EBE92TR, EBE92TRC, EBE93AL, EBE93ALC, EBE93ALR, EBE93AMC, EBE93GL, EBE93GLC, EBE93GLR, EBE93GMC, EBE93TL, EBE93TLC, EBE93TLR, EBE93TMC, EBE94AL, EBE94ALC, EBE94ALR, EBE94AMC, EBE94AR, EBE94GL, EBE94GLC, EBE94GLR, EBE94GMC, EBE94GR, EBE94TL, EBE94TLC, EBE94TLR, EBE94TMC, EBE94TR, ECE74E, ECE74-Q, ECE92A, ECE92G, ECE92T, ECE94A, ECE94E, ECE94G, ECE94T, ECG94E...(Otros modelos se puede ver en la tienda web)		

codificadores y potenciómetros

			
1			
código	402055	referencia	0101932 SIR0101932
descripción	potenciómetro 22KOhm		
Para modelos:	CTE9141, CTE9142, CTE9142S, CTE9146, TE94APS, TE94EPS, TE94GPS, TEY4APS		

			
1			
código	359380	referencia	CR0682520
descripción	lámpara de señalización ø 10mm 230V rojo empalme conector Faston 6,3mm casquillo portalámpara roscado		
Para modelos:	ECV92A, ECV92G, ECV92T, ECV94A, ECV94E, ECV94G, ECV94T, EPE7105, EPE7108, EPE9110, EPE9110A, EPE9115, EPE9115A, EPG7105, EPG7108, EPG9115, EPG9115A, EPGB9110, EPGB9110A, ETE74		



lámparas

lámparas de señalización

lámparas de señalización 3 piezas (casquillo, lente y bombilla)

lámparas

lámparas de descarga

			
1			
código	359606	referencia	0102476 SIR0102476
descripción	lámpara de neón casquillo Ba9s 220V 2W claro ø 10mm L 28mm		
Para modelos:	CPD90100, CPD90100A, CPD90150, CPD90150A, CPI90100, CPI90100A, CPI90150, CPI90150A		
accesorios para	359606		
	código	359832	referencia —
portalámparas medida de montaje ø16,2mm casquillo Ba9s empalme conector Faston 6,3mm			
	código	359853	referencia —
portalámparas medida de montaje ø18,2mm casquillo Ba9s empalme conector Faston 6,3mm			

			
1			
código	359378	referencia	1037300810 MA1037300810
descripción	lámpara de señalización ø 10mm 230V verde empalme conector Faston 6,3mm casquillo portalámpara roscado		
Para modelos:	BE62TLC, BE62TLL, BE62TRR, BE63TLC, BE63TLL, BE63TLR, BE65TLC, BE65TLL, BE65TLR, CBE6220, CCT6220, CCT6220V, CCT6230, CCT6230V, CE62TPT, CE64TPT, CFE62110/1, CFE62210/1, CGE6220, CGE6220C, CGE6220R, CGE6230, CGE6230C, CGE6230LR, CGE6250, CGE6250LR, CGE6250LRC, CV62TPS, CV64TPS, FE62T10, FE64T10, SE62TPS		

con casquillo enchufable

			
1			
código	359140	referencia	1037300910 MA1037300910
descripción	lámpara de señalización ø 10mm amarillo 230V empalme conector Faston 6,3mm UE 1 pzs		
Para modelos:	BE62TLC, BE62TLL, BE62TRR, BE63TLC, BE63TLL, BE63TLR, BE65TLC, BE65TLL, BE65TLR, CCW6220, CFE62110/1, CFE62210/1, CGE6220, CGE6220C, CGE6220R, CGE6230, CGE6230C, CGE6230LR, CGE6250, CGE6250LR, CGE6250LRC, CME6220, CME6230, CME6240, CNE6230, CRE6220, CRE6230, CSP6220, CW62TPS, DE63128, ECE7-E, FE62T10, FE64T10, GE62TPS, GE63TPS, ME62TPS, ME63TPS, ME64TPS, RP62TPS, SG86CRA, SG86FRA, SG86IRA, SG96CRA, SG96FRA, SG96IRA		



ø12mm			
con casquillo roscado			
			
1			
código	359048	referencia	0101170 SIR0101170
descripción	lámpara de señalización ø 12mm 230V amarillo empalme conector Faston 6,3mm		

			
1			
código	359027	referencia	0101171 SIR0101171
descripción	lámpara de señalización ø 12mm 250V verde empalme conector Faston 6,3mm		



			
1			
código	359290	referencia	0101167 65270220 LA65270220 LAR65270220 SIR0101167
descripción	lámpara de señalización ø 12mm 400V amarillo empalme conector Faston 6,3mm		
Para modelos:	BAC100, BAC100-A, BAC102, BAC120, BAC120-A, BAC122, BAC140, BAC140-A, BAC142, BAC160, BAC160-A, BAC162, BAC180, BAC180-A, BAC182, BAC200, BAC200-A, BAC202, BAM16D, BAM16S, BAM18D, BAM18S, BAM20D, BAM20S, BE72ALC, BE72ALL, BE72ARR, BE72GLC, BE72GLL, BE72GRR, BE72TLC, BE72TLL, BE72TRR, BE74ALC, BE74ALL, BE74ALR, BE74ARC, BE74ARR, BE74GLC, BE74GLL, BE74GLR, BE74GMC, BE74GRR, BE74TLC, BE74TLL, BE74TLR, BE74TMC, BE74TRR, BE82ALC, BE82ALL...(Otros modelos se puede ver en la tienda web)		

			
1			
código	359292	referencia	0101168 SIR0101168
descripción	lámpara de señalización ø 12mm 400V rojo empalme conector Faston 6,3mm		

			
1			
código	359291	referencia	0101169 SI0101169 SIR0101169
descripción	lámpara de señalización ø 12mm 400V verde empalme conector Faston 6,3mm		
Para modelos:	BE72ALC, BE72ALL, BE72ARR, BE72GLC, BE72GLL, BE72GRR, BE72TLC, BE72TLL, BE72TRR, BE74ALC, BE74ALL, BE74ALR, BE74ARC, BE74ARR, BE74GLC, BE74GLL, BE74GLR, BE74GMC, BE74GRR, BE74TLC, BE74TLL, BE74TLR, BE74TMC, BE74TRR, BE82ALC, BE82ALL, BE82ARR, BE82GLC, BE82GLL, BE82GRR, BE82TLC, BE82TLL, BE82TRR, BE84ALC, BE84ALL, BE84ALR, BE84AMC, BE84ARR, BE84GLC, BE84GLL, BE84GLR, BE84GMC, BE84GRR, BE84TLC, BE84TLL, BE84TLR, BE84TMC, BE84TRR, BE92ALC, BE92ALL...(Otros modelos se puede ver en la tienda web)		

lámpade

lámparas de descarga

			
1			
código	359606	referencia	0102476 SIR0102476
descripción	lámpara de neón casquillo Ba9s 220V 2W claro ø 10mm L 28mm		
Para modelos:	CPD90100, CPD90100A, CPD90150, CPD90150A, CPI90100, CPI90100A, CPI90150, CPI90150A		
accesorios para	359606		
	código	359832	referencia —
	portalámparas medida de montaje ø16,2mm casquillo Ba9s empalme conector Faston 6,3mm		
	código	359853	referencia —
	portalámparas medida de montaje ø18,2mm casquillo Ba9s empalme conector Faston 6,3mm		

señalizadores de alarma

zumbadores

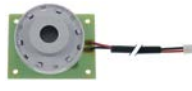
			
1			
código	350086	referencia	LA65301440 LAR65301440 RA919008 SIRRA919008
descripción	zumbador 12VDC empalme cable 200mm placa electrónica zumbador 20dB		
Para modelos:	CTE9141, CTE9142, CTE9142S, CTE9146, DP018T, DP112T, DPC20T, DPC40T, DX018T, DX110T, DX112T, DXC20T, DXC40T, MDP112T, MDPC20T, MDPC40T, MDX112T, MDXC20T, MDXC40T, MZP110T, MZPC20T, MZPC40T, MZX110T, MZXC20T, MZXC40T, TE94APS, TE94EPS, TE94GPS, TEY4APS, ZP018S, ZP018T, ZP110T, ZP112T, ZPC20T, ZPC40T, ZX018S, ZX018T, ZX105A, ZX105D, ZX110A, ZX110T, ZX112S, ZX210A, ZXC20T, ZXC40A, ZXC40T		

contactores

ABB

contactores de potencia

			
1			
código	381011	referencia	0101332 SI0101332 SIR0101332
descripción	contactor de potencia AC1 16A 230VAC (AC3/400V) 9A/4kW contactos principales 2NO/2NC contactos auxiliares empalme empalme atornillado tipo B6-22-00		
Para modelos:	CTE9141, CTE9142, CTE9142S, CTE9146, TE94APS, TE94EPS, TE94GPS, TEY4APS		



GENERAL ELECTRIC (AEG)

contactores de potencia



1

código	380263	referencia	0101330 SIR0101330
descripción	contactor de potencia AC1 32A 230VAC (AC3/400V) 17A/7,5kW contactos principales 4NO contactos auxiliares empalme empalme atornillado tipo AEG LS7K 400A tipo GE CL00A 310		
Para modelos:	CBE7050, CBE7050C, CBE9060, CBE9060C, CFE60110, CFE60210, CFE70110-0, CFE72110-0, CGE9020, CGE9020C, CGE9020R, CGE9020RC, CGE9021, CGE9021C, CGE9021R, CGE9021RC, CGE9022, CGE9022C, CGE9022R, CGE9022RC, CGE9040, CGE9040C, CGE9040LR, CGE9040LRC, CGE9040R, CGE9040RC, CGE9041, CGE9041C, CGE9041LR, CGE9041LRC, CGE9041R, CGE9041RC, CGE9042, CGE9042C, CGE9042LR, CGE9042LRC, CGE9042R, CGE9042RC, CNE70160, CNE72160, CNE90160, CNE90160S, CNE90160-S, CPE90100, CPE90100A, CPE90150, CPE90150A, CRE6-20, CRE6-30, DE74170...(Otros modelos se puede ver en la tienda web)		

ISKRA (FANAL)

contactores de potencia



1



código	380219	referencia	0101328 SIR0101328
descripción	contactor de potencia AC1 25A 230VAC (AC3/400V) 17A/7,5kW contactos principales 3NO contactos auxiliares 1NC empalme empalme atornillado tipo FANAL DSL16 01 tipo ISKRA KNL16 01		
accesorios para	380219		
	código	381379	referencia —
	limitador de corriente empalme atornillado margen de ajuste 11,3-16A para contactores KNL16 tipo BR16 11,3-16A		

LOVATO

contactores de potencia



1

código	380855	referencia	0108075 SIR0108075
descripción	contactor de potencia AC1 25A 230VAC (AC3/400V) 4.2kW contactos principales 3NO contactos auxiliares 1NO		
Para modelos:	CFE70110, CFE70110-2, CFE70115, CFE70115-2, CFE70115-M, CFE70210, CFE70210-2, CFE70210-M, CFE70215, CFE70215-2, CFE70215-M, CFE72210, CFE72215, CFE90120, CFE90120-2, CFE90210, CFE90210-2, CFE90220, CFE90220-2, FE72210, FE92210		
accesorios para	380855		
	código	380055	referencia —
	elemento RC tensión AC/DC apto para BF09-32 nominal 240V		
	código	380118	referencia —
	contacto auxiliar contactos 1NO/1NC AC1 10A para contactores serie BF empalme atornillado tipo G480/11		

SIEMENS

contactores de potencia



1

código	381387	referencia	CM187301 MACM187301
descripción	contactor de potencia AC1 22A 230VAC (AC3/400V) 4kW contactos principales 3NO contactos auxiliares 1NO empalme empalme atornillado tipo 3RT2016-1AP01		



código	380389	referencia	CM187300 MACM187300
descripción	contactor de potencia AC1 22A 230VAC (AC3/400V) 9A/4kW contactos principales 3NO contactos auxiliares 1NO empalme empalme atornillado tipo 3RT10-16-1AP01		
Para modelos:	CFE62110/1, CFE62210/1, CNE6230, CRE6220, CRE6230, DE63128, DE72128, DE74228, DE82140, DE82142, DE82T42, DE84240, DE84242, DE84T42, DE92142, DE94242, DEY2142, DEY4242, EDE72128, EDE74228, EDE92142, EDE93142, EDE94242, EFE72110, EFE72115, EFE73210, EFE74215, EFE92115, EFE92122, EFE92122K, EFE93210, EFE94215, EFE94222, EFE94222K, EPE7I05, EPE7I08, EPE9D10, EPE9D15, EPE9I10, EPE9I10A, EPE9I15, EPE9I15A, ESE74, FE62T10, FE64T10, FE72112, FE72206, FE74212, FE82206, FE92206... (Otros modelos se puede ver en la tienda web)		



código	380390	referencia	0105031 CM187400 CM187401 MACM187400 MACM187401 SIR0105031
descripción	contactor de potencia AC1 40A 230VAC (AC3/400V) 12A/5,5kW contactos principales 3NO contactos auxiliares empalme empalme atornillado tipo 3RT10-24-1AL20 50/60Hz		
Para modelos:	EFE92122, EFE92122K, EFE94222, EFE94222K, ESE94CRA, ESE94CRM, ESE94FRA, ESE94FRM, ESE96CRA, ESE96FRA, FE82118, FE82T18, FE84218, FE84T18, FE92118, FE94218, FEY2118, FEY4218, SE86CRA, SE86FRA, SE86IRA, SE96CRA, SE96FRA, SE96IRA		

relés

relés de potencia

con lengüeta de sujeción

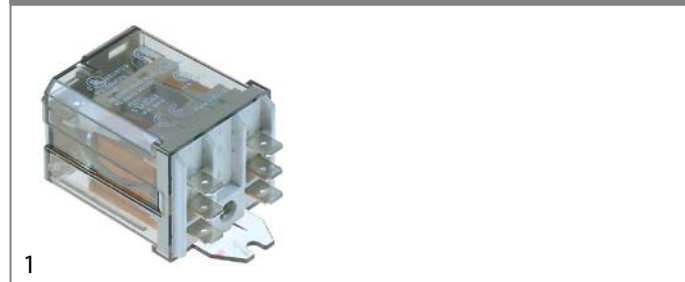

código	380815	referencia	CR0687240
descripción	relé de potencia 230VAC 16A 2NO empalme conector Faston 6,3mm brida medidas 36x38x68mm		
Para modelos:	ESE94CRA, ESE94CRM, ESE94FRA, ESE94FRM, ESE96CRA, ESE96FRA, ESG94CRA, ESG94CRM, ESG94FRA, ESG94FRM, ESG96CRA, ESG96FRA		

con contactos enchufables

conectores redondos, 8 contactos

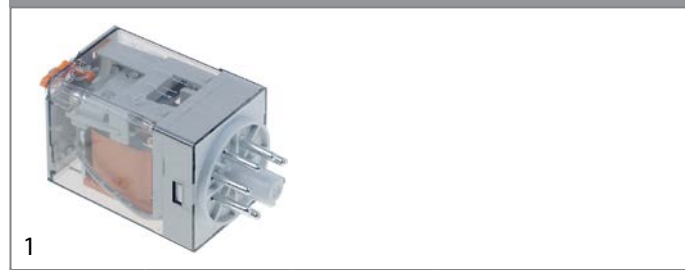

código	380951	referencia	0683840 CR0683840
descripción	relé de potencia FINDER 230VAC 10A 2CO empalme empalme enchufable redondo 8 polos N° fabricante 60.12.4.101.0040 90.26/ ZVE8 250V		
Para modelos:	EPE7I05, EPE7I08, EPE9I10, EPE9I10A, EPE9I15, EPE9I15A, EPG7I05, EPG7I08, EPG9I15, EPG9I15A, EPG9I10, EPG9I10A		

portarelés



código	380638	referencia	2609500 MA2609500
descripción	zócalo de relé 8 polos medidas 51x41x23mm 250V 10A FINDER N° fabricante 90.26		
Para modelos:	EPE7I05, EPE7I08, EPE9I10, EPE9I10A, EPE9I15, EPE9I15A, EPG7I05, EPG7I08, EPG9I15, EPG9I15A, EPG9I10, EPG9I10A		



relés de nivel

GICAR



1			
código	400018	referencia	0102477 SIO102477 SIR0102477
descripción	relé de nivel 230V tensión AC empalme F6,3 tipo RL30/3ES/F/G		
Para modelos:	CPE90100, CPE90100A, CPE90150, CPE90150A, CPI90100, CPI90100A, CPI90150, CPI90150A, PE7NI05, PE8AI10, PE8AI15, PE8NI10, PE8NI15, PE9AI10, PE9AI15, PE9NI10, PE9NI15		

controladores electrónicos

EVCO - EVERY CONTROL

controladores universales

versión empotrada



1			
código	400175	referencia	0108072 SIR0108072
descripción	controlador electrónico EVERY CONTROL		
Para modelos:	CFE70115-M, CFE70210-M, CFE70215-M		

transformadores

transformadores encapsulados

con empalme atornillado



1			
código	402950	referencia	CR0684780
descripción	transformador primaria 230V secundaria 24V 100VA empalme atornillado 50/60Hz tipo 192		
Para modelos:	ESE94CRA, ESE94CRM, ESE94FRA, ESE94FRM, ESE96CRA, ESE96FRA, ESG94CRA, ESG94CRM, ESG94FRA, ESG94FRM, ESG96CRA, ESG96FRA		

controladores de punto de refrigeración

versión empotrada



1			
código	379820	referencia	1681114 BN1681114
descripción	controlador electrónico EVERY CONTROL tipo EVC20S35N7ALX30 medida de montaje 165x45mm aliment. 230V tensión AC NTC salidas de relé 3 NO-16A(5) NO-8A(4) CO-8A(4) NTC NTC DI para frigorífico dimensiones frontalesmm profundidad de montaje 56mm protección IP00 presente presente presente -40° a 105°C display 4 dígitos		



1			
código	379850	referencia	1681118 936092 BN1681118 FR936092
descripción	controlador electrónico EVERY CONTROL tipo EVC20S35N7ALX40 medida de montaje 165x45mm aliment. 230V tensión AC NTC salidas de relé 4 NO-16A(5) NO-8A(4) CO-8A(4) NTC NTC DI DI para frigorífico dimensiones frontalesmm profundidad de montaje 56mm protección IP00 presente presente presente -40 a +99°C display 4 dígitos		

sensores

sensores universales

sondas de temperatura



código	379064	referencia	995562 FR995562
descripción	sensor de temperatura PTC 1kOhm cable silicona sonda -50 a +150°C cable -50 a +180°C bulbo ø6x40mm longitud de cable 3m sin racor de dos hilos		

sondas al corazón

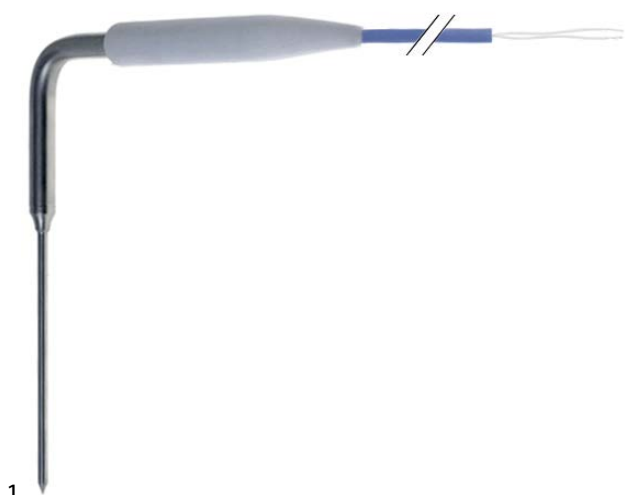

código	378392	referencia	996452 FR996452
descripción	sensor al corazón Pt1000 universal acodado sonda -40 a +120°C cable -10 a 100°C cable PVC bulbo ø4x100mm longitud de cable 5m de dos hilos resistencia a +0°C 10000hm para abatidor de temperatura		

sensores específicos del fabricante

sensores



código	379711	referencia	RA932001 SIRA932001 SIRRA932001
descripción	sensor de temperatura PTC 1kOhm cable silicona sonda -50 a +150°C cable -50 a +180°C empalme conector codificado rosca bulbo ø6x40mm longitud de cable 3.5m		
Para modelos:	10-teglie-GN-MISTI-FR-STD, 10-teglie-GN-MISTI-FR-TOP, 10-teglie-GN-MISTI-IT-STD, 10-teglie-GN-MISTI-IT-TOP, 10-teglie-GN-MISTI-TX-STD, 10-teglie-GN-positivi-FR-STD, 10-teglie-GN-positivi-FR-TOP, 10-teglie-GN-positivi-IT, 10-teglie-GN-positivi-IT-STD, 10-teglie-GN-positivi-IT-TOP, 10-teglie-GN-positivi-TX-STD, 12-teglie-PA-MISTI-FR-STD, 12-teglie-PA-MISTI-FR-TOP, 12-teglie-PA-MISTI-IT-STD, 12-teglie-PA-MISTI-IT-TOP, 12-teglie-PA-positivi-FR-STD, 12-teglie-PA-positivi-FR-TOP, 12-teglie-PA-positivi-IT-STD, 12-teglie-PA-positivi-IT-TOP, 14-teglie-GN-MISTI-FR-dep-STD, 14-teglie-GN-MISTI-FR-dep-TOP, 14-teglie-GN-MISTI-FR-STD, 14-teglie-GN-MISTI-FR-TOP, 14-teglie-GN-MISTI-IT-dep-STD, 14-teglie-GN-MISTI-IT-dep-TOP, 14-teglie-GN-MISTI-IT-STD, 14-teglie-GN-MISTI-IT-TOP, 14-teglie-GN-MISTI-TX-STD, 14-teglie-GN-positivi-FR, 14-teglie-GN-positivi-FR-dep-STD, 14-teglie-GN-positivi-FR-dep-TOP, 14-teglie-GN-positivi-FR-STD, 14-teglie-GN-positivi-FR-TOP, 14-teglie-GN-positivi-IT-dep-STD, 14-teglie-GN-positivi-IT-dep-TOP, 14-teglie-GN-positivi-IT-STD, 14-teglie-GN-positivi-IT-TOP, 14-teglie-GN-positivi-TX-STD, 15-teglie-PA-MISTI-FR-STD, 15-teglie-PA-MISTI-TX-STD, 17-teglie-PA-MISTI-FR-dep, 17-teglie-PA-MISTI-FR-dep-TOP, 17-teglie-PA-MISTI-FR-STD, 17-teglie-PA-MISTI-FR-TOP, 17-teglie-PA-MISTI-IT-dep, 17-teglie-PA-MISTI-IT-dep-TOP, 17-teglie-PA-MISTI-IT-STD, 17-teglie-PA-MISTI-IT-TOP, 17-teglie-PA-positivi-FR-dep-STD, 17-teglie-PA-positivi-FR-dep-TOP...(Otros modelos se puede ver en la tienda web)		



código	378129	referencia	0100167 SIR0100167
descripción	sensor de temperatura termopar K (NiCr-Ni) cable Vetrotex sonda -50 a 1150°C cable -50 a +350°C empalme de dos hilos rosca M8 bulbo ø3-5x140mm longitud de cable 2.1m		
Para modelos:	CTE9141, CTE9142, CTE9142S, CTE9146, TE94APS, TE94EPS, TE94GPS, TEY4APS		



sondas al corazón

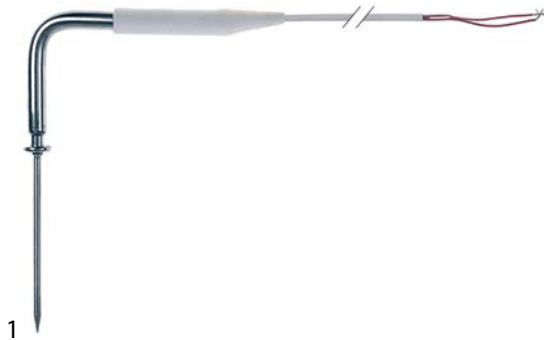

1

código	379544	referencia	RA930013 SIRA930013 SIRRA930013
descripción	sensor al corazón Pt1000 cable silicona sonda -40 a +120°C cable -50 a +180°C empalme de dos hilos bulbo ø4x100mm rosca longitud de cable 3.6m asidero ø 16mm longitud de asidero 120mm		
Para modelos:	10-teglike-GN-MISTI-FR-STD, 10-teglike-GN-MISTI-IT-STD, 10-teglike-GN-MISTI-TX-STD, 10-teglike-GN-positivi-FR-STD, 10-teglike-GN-positivi-IT, 10-teglike-GN-positivi-IT-STD, 10-teglike-GN-positivi-TX-STD, 12-teglike-PA-MISTI-FR-STD, 12-teglike-PA-MISTI-IT-STD, 12-teglike-PA-positivi-FR-STD, 12-teglike-PA-positivi-IT-STD, 14-teglike-GN-MISTI-FR-dep-STD, 14-teglike-GN-MISTI-FR-STD, 14-teglike-GN-MISTI-IT-dep-STD, 14-teglike-GN-MISTI-IT-STD, 14-teglike-GN-MISTI-TX-STD, 14-teglike-GN-positivi-FR-STD, 14-teglike-GN-positivi-FR-dep-STD, 14-teglike-GN-positivi-FR-STD, 14-teglike-GN-positivi-IT-dep-STD, 14-teglike-GN-positivi-IT-STD, 14-teglike-GN-positivi-TX-STD, 15-teglike-PA-MISTI-FR-STD, 15-teglike-PA-MISTI-TX-STD, 17-teglike-PA-MISTI-FR-dep, 17-teglike-PA-MISTI-FR-STD, 17-teglike-PA-MISTI-IT-dep, 17-teglike-PA-MISTI-IT-STD, 17-teglike-PA-positivi-FR-dep-STD, 17-teglike-PA-positivi-FR-STD, 17-teglike-PA-positivi-IT-dep-STD, 17-teglike-PA-positivi-IT-STD, 20-teglike-GN-misti-FR-STD, 20-teglike-GN-positivi-FR-STD, 20-teglike-GN-positivi-IT-STD, 21-teglike-PA-MISTI-TX-STD		

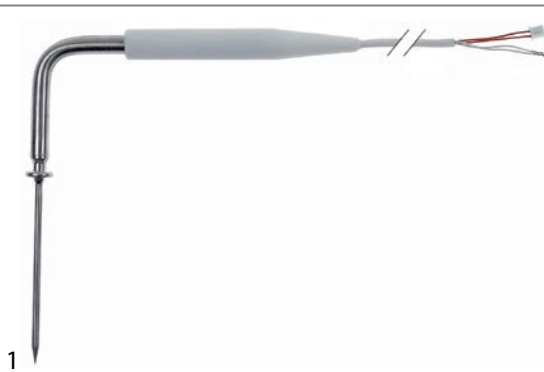

1

código	379757	referencia	RA930014 SIRA930014 SIRRA930014
descripción	sensor al corazón Pt1000 cable silicona sonda -40 a +120°C cable -50 a +180°C empalme de dos hilos bulbo ø4x100mm rosca longitud de cable 3.6m asidero ø 16mm longitud de asidero 125mm		
Para modelos:	10-teglike-GN-MISTI-FR-TOP, 10-teglike-GN-MISTI-IT-TOP, 10-teglike-GN-positivi-FR-TOP, 10-teglike-GN-positivi-IT-TOP, 12-teglike-PA-MISTI-FR-TOP, 12-teglike-PA-MISTI-IT-TOP, 12-teglike-PA-positivi-FR-TOP, 12-teglike-PA-positivi-IT-TOP, 14-teglike-GN-MISTI-FR-dep-TOP, 14-teglike-GN-MISTI-FR-TOP, 14-teglike-GN-MISTI-IT-dep-TOP, 14-teglike-GN-MISTI-IT-TOP, 14-teglike-GN-positivi-FR-dep-TOP, 14-teglike-GN-positivi-FR-TOP, 14-teglike-GN-positivi-IT-dep-TOP, 14-teglike-GN-positivi-IT-TOP, 17-teglike-PA-MISTI-FR-dep-TOP, 17-teglike-PA-MISTI-FR-TOP, 17-teglike-PA-MISTI-IT-dep-TOP, 17-teglike-PA-MISTI-IT-TOP, 17-teglike-PA-positivi-FR-dep-TOP, 17-teglike-PA-positivi-FR-TOP, 17-teglike-PA-positivi-IT-dep-TOP, 17-teglike-PA-positivi-IT-TOP, 20-teglike-GN-positivi-FR-TOP, 20-teglike-GN-positivi-IT-TOP		

electrónicas

placas electrónicas



1

código	400687	referencia	CM295800 MACM295800
descripción	placa de teclado freidora EFE....K		
Para modelos:	EFE92122K, EFE94222K, EFG92123K, EFG94223K		



1

código	402056	referencia	0101930 SIR0101930
descripción	placa electrónica		
Para modelos:	CTE9141, CTE9142, CTE9142S, CTE9146, TE94APS, TE94EPS, TE94GPS, TEY4APS		

teclados

membranas de teclado



1

código	504294	referencia	CR0588380
descripción	membrana de teclado apto para serie 900 L 92mm An 54mm tazas 4		
Para modelos:	EFE92122K, EFE94222K		

válvulas magnéticas

válvulas magnéticas agua

ELBI

acodado



1

código	370833	referencia	CR0682320 CR0682320R
descripción	válvula magnética simple acodado 230VAC entrada 3/4" salida 11,5mm reducción entrada A 18,5-20l/min DN10 ELBI		
Para modelos:	EME92A, EME92G, EME92T, EME94A, EME94G, EME94T, EPE50, EPE7108, EPE9D10, EPE9D15, EPE9I10, EPE9I10A, EPE9I15, EPE9I15A, EPG50, EPG7108, EPG9D10, EPG9D10A, EPG9D15, EPG9D15A, EPG9I15, EPG9I15A, EPG9I10, EPG9I10A, ESE94CRA, ESE94CRM, ESE94FRA, ESE94FRM, ESE96CRA, ESE96FRA, ESG94CRA, ESG94CRM, ESG94FRA, ESG94FRM, ESG96CRA, ESG96FRA		

RPE

válvulas magnéticas con reducciones

doble



1

código	374000	referencia	CR0586050 CR0586050R CR1220370R
descripción	válvula magnética doble recto 230VAC entrada 3/4" salida 11,5mm reducción entrada A 10-12l/min DN10 T máx 90°C RPE reducción entrada A blanco reducción salida A 0,32-0,42l/min reducción salida A verde oscuro		
Para modelos:	EDE72128, EDE73142, EDE74228, EDE92142, EDE93142, EDE94242, EDG72128, EDG73142, EDG74228, EDG92142, EDG93142, EDG94242		
accesorios para	374000		
	código	referencia	—
	371256	referencia	—
	reducción RPE velocidad de flujo 10-12l/min margen de presión 0,5-10bar blanco		

TP







1

código	370015	referencia	0101341 SIR0101341
descripción	válvula magnética simple acodado 230VAC entrada 3/4" salida 11,5mm DN10 TP		
Para modelos:	CBE9060, CBE9060C, CBG9060C-I, CME7021, CME7022, CME7041, CME7042, CME7221, CME7222, CME7241, CME7242, CRE6-20, CRE6-30, ME72APS, ME72GPS, ME74APS, ME74GPS, PE8A110, PE8A115, PE8N110, PE8N115, PE9A110, PE9A115, PE9N110, PE9N115, SE94CRA, SE94CRM, SE94FRA, SE94FRM, SE94IRA, SE94IRM, SG94CRA, SG94FRA, SG94IRA		
accesorios para	370015		
	código	referencia	—
	371220	referencia	—
	reducción TP velocidad de flujo 3l/min rojo tolerancia ±15%		
	371221	referencia	—
	reducción TP velocidad de flujo 5.5l/min amarillo tolerancia ±15%		
	371222	referencia	—
	reducción TP velocidad de flujo 6l/min gris tolerancia ±15%		
	371223	referencia	—
	reducción TP velocidad de flujo 10l/min blanco tolerancia ±15%		
	371224	referencia	—
	reducción TP velocidad de flujo 12l/min bronce tolerancia ±15%		
	371225	referencia	—
	reducción TP velocidad de flujo 16l/min marrón claro tolerancia ±15%		
	371226	referencia	—
	reducción TP velocidad de flujo 20l/min rojo tolerancia ±15%		
	371230	referencia	—
	reducción TP velocidad de flujo 0.25l/min rojo tolerancia ±25%		
	371231	referencia	—
	reducción TP velocidad de flujo 0.35l/min violeta tolerancia ±25%		
	371232	referencia	—
	reducción TP velocidad de flujo 0.5l/min naranja tolerancia ±25%		
	371233	referencia	—
	reducción TP velocidad de flujo 0.8l/min blanco tolerancia ±25%		
	371234	referencia	—
	reducción TP velocidad de flujo 1l/min azul claro tolerancia ±25%		
	371235	referencia	—
	reducción TP velocidad de flujo 1.2l/min marrón tolerancia ±25%		
	371236	referencia	—
	reducción TP velocidad de flujo 1.5l/min marrón claro tolerancia ±25%		

Continúa en la página siguiente



accesorios para 370015			
código	371237	referencia	—
	reducción TP velocidad de flujo 2.5l/min amarillo tolerancia ±25%		
código	371238	referencia	—
	reducción TP velocidad de flujo 3.4l/min verde oscuro tolerancia ±25%		
código	371239	referencia	—
	reducción TP velocidad de flujo 5l/min negro tolerancia ±25%		
código	371240	referencia	—
	reducción TP velocidad de flujo 8l/min azul tolerancia ±20%		

metal			
SIRAI			
2 vías			
serie L139-B			
			
1			
código	370700	referencia	0102486 LAR65110100 SIR0102486
descripción	válvula magnética latón 2vías 230VAC entrada 1/4" salida 1/4" empalme 1/4" L 40mm DN 4.5mm T máx 90°C -10 a +90°C SIRAI serie L139 tipo de bobina Z130A p máx. 8bar p mín. 0bar juego de válvulas L139B08 50Hz		
Para modelos:	CPE90100, CPE90100A, CPE90150, CPE90150A, CPI90100, CPI90100A, CPI90150, CPI90150A, PE9A110, PE9A115, PE9NI10, PE9NI15		

presostatos

para sistemas de lavado

ø58mm con conector Faston 6,3mm

con empalme horizontal

				
1				
código	541830	referencia	CR0585951	
descripción	presostato margen de presión 260/230mbar empalme 6mm ø 58mm empalme presión ø 6mm			
Para modelos:	EDE72128, EDE73142, EDE74228, EDE92142, EDE93142, EDE94242, EDG72128, EDG73142, EDG74228, EDG92142, EDG93142, EDG94242			
accesorios para	541830			
	código	541831	referencia	CR0731840
	soporte metal para presóstato distancia de sujeción 38.5mm			

accesorios			
			
1			
código	541831	referencia	CR0731840
descripción	soporte metal para presóstato distancia de sujeción 38.5mm		

para sistemas de gas

			
1			
código	541051	referencia	0102485 SIR0102485
descripción	presostato ø 45mm margen de presión ajustable 10-50mbar conexión de presión vertical sistemas de gas empalme 1/4" empalme presión ø 1/4"mm		
Para modelos:	CBG9060C-I, CPD90100, CPD90100A, CPD90150, CPD90150A, CPI90100, CPI90100A, CPI90150, CPI90150A		

para regulación vapor

			
1			
código	541795	referencia	CR0587800
descripción	presostato ø 45mm conexión de presión vertical regulación vapor margen de presión -1 a +1bar empalme conector Faston 6,3mm BECK empalme de presión 3/8"		
Para modelos:	EPE7105, EPE7108, EPE9110, EPE9110A, EPE9115, EPE9115A, EPG7105, EPG7108, EPG9115, EPG9115A, EPG9110, EPG9110A		

electródos

			
1			
código	400171	referencia	0102478 65324720 LAR65324720 SIR0102478
descripción	electrodo de nivel 1/4" longitud total 350mm sonda L 325mm largo del bulbo asilado 26mm empalme conector Faston 6,3mm acero inoxidable ø 2.5mm		
Para modelos:	CPE90100, CPE90100A, CPE90150, CPE90150A, CPI90100, CPI90100A, CPI90150, CPI90150A, PE7NI05, PE8A110, PE8A115, PE8NI10, PE8NI15, PE9A110, PE9A115, PE9NI10, PE9NI15		

ventiladores

ventilador axial

importación



1

código	601080 ¹	referencia	CM303000 MACM303000
descripción	ventilador axial L 119mm An 119mm H 38mm 230VAC 50/60Hz 23/20W cojinete rodamiento de bolas empalme conector Faston 2,8mm metal ADDA rodete ventilador ø 110mm resis.a la temp. 70°C		
Para modelos:	EFG92123K, EFG94223K, ETE74		
accesorios para	601080		
	código	550898	referencia —
	cable de conexión longitud del cable 2000mm empalme F 2,8 distancia de empalme 7.9mm para ventilador axial		
	código	692519	referencia —
	rejilla de protección L 120mm An 120mm plástico		

¹con rodamiento de bolas

ventiladores para frigoríficos

ventiladores de refrigeración

ebm-papst

serie A2E

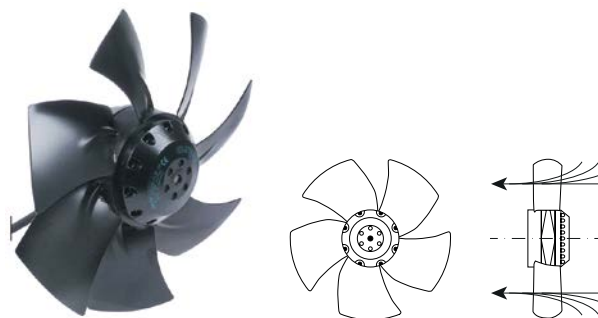

1

código	601750	referencia	RA880002 SIRA880002 SIRRA880002
descripción	ventilador A2E250-AL06-09 rodete ventilador ø 250mm palas 7 230V 50/60Hz 120/160W 2500rev/min longitud del cable 200mm ebm-papst aspirante condensador apropiado 3µF		
Para modelos:	14-teglie-GN-MISTI-FR-dep-STD, 14-teglie-GN-MISTI-FR-dep-TOP, 14-teglie-GN-MISTI-FR-STD, 14-teglie-GN-MISTI-FR-TOP, 14-teglie-GN-MISTI-IT-dep-STD, 14-teglie-GN-MISTI-IT-dep-TOP, 14-teglie-GN-MISTI-IT-STD, 14-teglie-GN-MISTI-IT-TOP, 14-teglie-GN-MISTI-TX-STD, 14-teglie-GN-positivi-FR, 14-teglie-GN-positivi-FR-dep-STD, 14-teglie-GN-positivi-FR-dep-TOP, 14-teglie-GN-positivi-FR-STD, 14-teglie-GN-positivi-FR-TOP, 14-teglie-GN-positivi-IT-dep-STD, 14-teglie-GN-positivi-IT-dep-TOP, 14-teglie-GN-positivi-IT-STD, 14-teglie-GN-positivi-IT-TOP, 14-teglie-GN-positivi-TX-STD, 15-teglie-PA-MISTI-FR-STD, 17-teglie-PA-MISTI-FR-dep, 17-teglie-PA-MISTI-FR-dep-TOP, 17-teglie-PA-MISTI-FR-STD, 17-teglie-PA-MISTI-FR-TOP, 17-teglie-PA-MISTI-IT-dep, 17-teglie-PA-MISTI-IT-dep-TOP, 17-teglie-PA-MISTI-IT-STD, 17-teglie-PA-MISTI-IT-TOP, 17-teglie-PA-positivi-FR-dep-STD, 17-teglie-PA-positivi-FR-dep-TOP, 17-teglie-PA-positivi-FR-STD, 17-teglie-PA-positivi-FR-TOP, 17-teglie-PA-positivi-IT-dep-STD, 17-teglie-PA-positivi-IT-dep-TOP, 17-teglie-PA-positivi-IT-STD, 17-teglie-PA-positivi-IT-TOP, 20-teglie-GN-misti-FR-STD, 20-teglie-GN-misti-FR-TOP, 20-teglie-GN-misti-IT-STD, 20-teglie-GN-misti-IT-TOP, 20-teglie-GN-positivi-FR-STD, 20-teglie-GN-positivi-FR-TOP, 20-teglie-GN-positivi-IT-STD, 20-teglie-GN-positivi-IT-TOP, 21-teglie-PA-MISTI-TX-STD, 3-teglie-GN-positivi-FR-STD, 3-teglie-GN-positivi-TX-STD, 5-teglie-GN-positivi-FR-dep-STD, 5-teglie-GN-positivi-FR-STD, 5-teglie-GN-positivi-FR-TOP...(Otros modelos se puede ver en la tienda web)		
accesorios para	601750		
	código	365137	referencia —
	condensador capacidad 3µF 450V tolerancia 5% 50/60Hz temperatura ambiente máx. -25 a + 85°C ø 25mm L 56mm M8 plástico empalme cable 250mm 416.17.77GF protección		



serie A4E

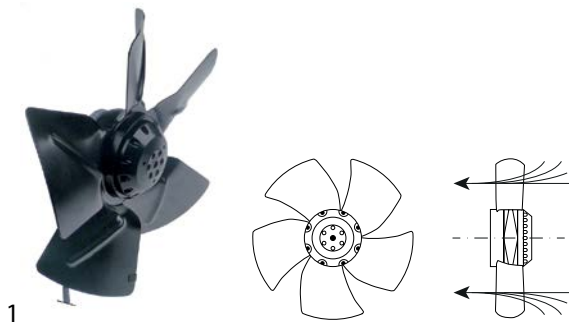

código	601623	referencia	RA880046 SIRA880046 SIRRA880046
descripción	ventilador A4E315-AC08-19 rodete ventilador ø 315mm palas 5 230V 50Hz 95W 1370rev/min longitud del cable 450mm ebm-papst aspirante condensador apropiado 3µF		
Para modelos:	10-teglike-GN-MISTI-FR-STD, 10-teglike-GN-MISTI-FR-TOP, 10-teglike-GN-MISTI-IT-STD, 10-teglike-GN-MISTI-IT-TOP, 10-teglike-GN-MISTI-TX-STD, 10-teglike-GN-positivi-FR-STD, 10-teglike-GN-positivi-FR-TOP, 10-teglike-GN-positivi-IT, 10-teglike-GN-positivi-IT-STD, 10-teglike-GN-positivi-IT-TOP, 10-teglike-GN-positivi-TX-STD, 12-teglike-PA-MISTI-FR-STD, 12-teglike-PA-MISTI-FR-TOP, 12-teglike-PA-MISTI-IT-STD, 12-teglike-PA-MISTI-IT-TOP, 12-teglike-PA-positivi-FR-STD, 12-teglike-PA-positivi-FR-TOP, 12-teglike-PA-positivi-IT-STD, 12-teglike-PA-positivi-IT-TOP, 15-teglike-PA-MISTI-TX-STD, 3-teglike-GN-misti-FR-STD, 3-teglike-GN-misti-TX-STD, 5-teglike-dep-GN-misti-FR-STD, 5-teglike-dep-GN-misti-IT-STD, 5-teglike-GN-misti-FR-STD, 5-teglike-GN-misti-FR-TOP, 5-teglike-GN-misti-IT-STD, 5-teglike-GN-misti-IT-TOP, 5-teglike-GN-misti-TX-STD, 5-teglike-PA-misti-FR-STD, 6-teglike-PA-misti-FR-STD, 6-teglike-PA-misti-FR-TOP, 6-teglike-PA-misti-IT-STD, 6-teglike-PA-misti-IT-TOP, 6-teglike-PA-misti-TX-STD		
accesorios para	601623		
	código	365137	referencia —
	condensador capacidad 3µF 450V tolerancia 5% 50/60Hz temperatura ambiente máx. -25 a +85°C ø 25mm L 56mm M8 plástico empalme cable 250mm 416.17.77GF protección		

ventiladores tangenciales

COPREL

con bobinas moldeadas



código	601434	referencia	FR6670311 FR935581
descripción	ventilador tangencial COPREL FFR rodillo ø 60mm L rodillo 300mm espesor de núcleo laminado 30mm posición del motor derecho 230V/50Hz 43W refrigeración cojinete goma empalme cable 1800mm tipo de bobina moldeado -10 a +60°C		

ventiladores de aire caliente

otros

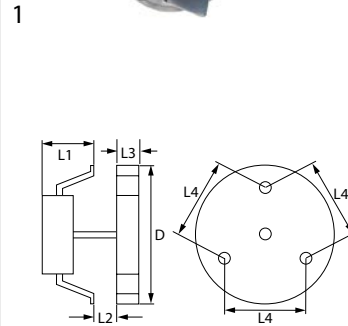
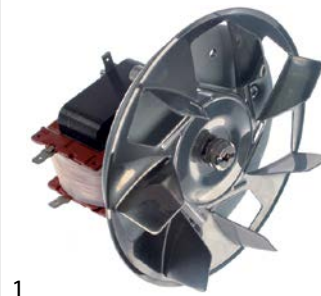

código	601696	referencia	0101342 4330800 MA4330800 SIR0101342
descripción	ventilador de aire caliente 230V 40W 50/60Hz L1 70mm L2 11mm L3 29mm L4 87mm rodete ventilador ø 155mm con rodamiento de bolas		
Para modelos:	BAC100, BAC100-A, BAC102, BAC120, BAC120-A, BAC122, BAC140, BAC140-A, BAC142, BAC160, BAC160-A, BAC162, BAC180, BAC180-A, BAC182, BAC200, BAC200-A, BAC202, BAM16D, BAM16S, BAM18D, BAM18S, BAM20D, BAM20S		
repuestos para	601696		
	código	550879	referencia —
	aislamiento ø 130mm espesor 3mm agujero ø 20mm para ventilador aire caliente		
	código	601261	referencia —
	rodete ventilador ø 154mm An 25mm soporte de eje ø 6x5mm cromado palas 7		



motores

motorreductores

para sartén basculante



1

código	600000	referencia	CM056300 MACM056300
descripción	motorreductor NERI tipo M63B4 120W 230V tensión DC 50Hz 1360rev/min árbol ø 14mm L 308mm An 140mm H 170mm para sartén basculante		
Para modelos:	SE84CRA, SE84FRA, SE84IRA, SE86CRA, SE86FRA, SE86IRA, SE94CRA, SE94FRA, SE94IRA, SE96CRA, SE96FRA, SE96IRA, SG84CRA, SG84IRA, SG94CRA, SG94FRA, SG94IRA		

fusibles

fusibles térmicos



1

código	358095	referencia	CR0841170
descripción	fusible térmico temp. desconexión 110°C nominal 10A UE 1 pzs		
Para modelos:	ETE74		

accesorios eléctricos

cables

accesorios

pasacables

racores para cables

uniones roscadas



1

código	550971	referencia	1037115100 MA1037115100
descripción	racor para cables rosca PG16 ø cable 14mm montaje ø 22.5mm UE 1 pzs plástico EC 27		
Para modelos:	BE62TLC, BE62TLL, BE62TRR, BE63TLC, BE63TLL, BE63TLR, BE65TLC, BE65TLL, BE65TLR, CBE6220, CGE6220, CGE6220C, CGE6220R, CGE6230, CGE6230C, CGE6230LR, CGE6250, CGE6250LR, CGE6250LRC, CME6220, CME6230, CME6240, CRE6220, CRE6230, CSP6220, ECIW72, EDE72128, EDE73142, EDE74228, EDG72128, EDG73142, EDG74228, EFE72110, EFE73210, ERP72, GE62TPS, GE63TPS, ME62TPS, ME63TPS, ME64TPS, RP62TPS, SE62TPS		

tuercas de fijación



1

código	550972	referencia	1037115200 MA1037115200
descripción	tuerca rosca PG16 EC 30 plástico UE 1 pzs espesor 6mm montaje ømm ø cablemm		
Para modelos:	BE62TLC, BE62TLL, BE62TRR, BE63TLC, BE63TLL, BE63TLR, BE65TLC, BE65TLL, BE65TLR, CBE6220, CGE6220, CGE6220C, CGE6220R, CGE6230, CGE6230C, CGE6230LR, CGE6250, CGE6250LR, CGE6250LRC, CME6220, CME6230, CME6240, CRE6220, CRE6230, CSP6220, ECIW72, EDE72128, EDE73142, EDE74228, EDG72128, EDG73142, EDG74228, EFE72110, EFE73210, ERP72, GE62TPS, GE63TPS, ME62TPS, ME63TPS, ME64TPS, RP62TPS, SE62TPS		

terminales

bornes de porcelana



1

código	550115	referencia	1037117600 MA1037117600
descripción	conector de porcelana 2 polos 10mm ² máx. 30A máx. 450V L 37mm An 37mm H 23mm distancia de sujeciónmm UE 1 pzs		
Para modelos:	ERP72		

regletas de bornes a tornillo/con contactos de enchufe



1

código	550534 ¹	referencia	CR0588180
descripción	borne de conexión 3 polos máx. 40A máx. 450V empalme ø6mm ² / F6,3 resis.a la temp. 150°C sección nominal 6mm ² distancia de sujeción 67mm con lengüeta de puesta a tierra		
Para modelos:	EDG72128, EDG73142, EDG74228, EDG92142, EDG93142, EDG94242, EPG7D05, EPG7I05, EPG7I08, EPG9D10, EPG9D10A, EPG9D15, EPG9D15A, EPG9I15, EPG9I15A, EPG9I10, EPG9I10A, EPGD05, ERP72, ESG94CRA, ESG94CRM, ESG94FRA, ESG94FRM, ESG96CRA, ESG96FRA		

¹con lengüeta de puesta a tierra

			
1			
código	550411	referencia	1037104000 MA1037104000
descripción	borne de conexión 6 polos máx. 40A máx. 450V empalme $\phi 6\text{mm}^2$ / F6,3 resis.a la temp. 150°C sección nominal 6mm ²		
Para modelos:	BE62TLC, BE62TLL, BE62TRR, BE63TLC, BE63TLL, BE63TLR, BE65TLC, BE65TLL, BE65TLR, CBE6220, CCT6220, CCT6220V, CCT6230, CCT6230V, CCW6220, CE62TPT, CE64TPT, CFE62110/1, CFE62210/1, CGE6220, CGE6220C, CGE6220R, CGE6230, CGE6230C, CGE6230LR, CGE6250, CGE6250LR, CGE6250LRC, CME6220, CME6230, CME6240, CRE6220, CRE6230, CSP6220, CV62TPS, CV64TPS, CW62TPS, EME7, FE62T10, FE64T10, GE62TPS, GE63TPS, ME62TPS, ME63TPS, ME64TPS, RP62TPS, SE62TPS		

			
1			
código	693955	referencia	1878400 MA1878400
descripción	clema cable de tierra		
Para modelos:	BE62TLC, BE62TLL, BE62TRR, BE63TLC, BE63TLL, BE63TLR, BE65TLC, BE65TLL, BE65TLR, CBE6220, CCT6220V, CCT6230V, CCW6220, CGE6220, CGE6220C, CGE6220R, CGE6230, CGE6230C, CGE6230LR, CGE6250, CGE6250LR, CGE6250LRC, CME6220, CME6230, CME6240, CRE6220, CRE6230, CSP6220, CV62TPS, CV64TPS, CW62TPS, EBE7, EBE92AL, EBE92ALC, EBE92AR, EBE92ARC, EBE92GL, EBE92GLC, EBE92GR, EBE92GRC, EBE92TL, EBE92TLC, EBE92TR, EBE92TRC, EBE93AL, EBE93ALC, EBE93ALR, EBE93AMC, EBE93GL, EBE93GLC, EBE93GRC, EBE93GRL, EBE93TMC, EBE94AL, EBE94ALC, EBE94ALR, EBE94AMC, EBE94AR, EBE94GL, EBE94GLC, EBE94GLR, EBE94GMC, EBE94GR, EBE94TL, EBE94TLC, EBE94TLR, EBE94TMC, EBE94TR, ECE74E, ECE74-Q, ECE92A, ECE92G, ECE92T, ECE94A, ECE94E, ECE94G, ECE94T, ECM73...(Otros modelos se puede ver en la tienda web)		

			
2			
código	550977 ¹	referencia	CR0588170
descripción	borne de conexión 6 polos máx. 40A máx. 450V empalme $\phi 6\text{mm}^2$ / F6,3 resis.a la temp. 150°C sección nominal 6mm ² con lengüeta de puesta a tierra		
Para modelos:	EBE7, EBE92AL, EBE92ALC, EBE92AR, EBE92ARC, EBE92GL, EBE92GLC, EBE92GR, EBE92GRC, EBE92TL, EBE92TLC, EBE92TR, EBE92TRC, EBE93AL, EBE93ALC, EBE93ALR, EBE93AMC, EBE93GL, EBE93GLC, EBE93GRL, EBE93GMC, EBE93TL, EBE93TLC, EBE93TLR, EBE93TMC, EBE94AL, EBE94ALC, EBE94ALR, EBE94AMC, EBE94AR, EBE94GL, EBE94GLC, EBE94GLR, EBE94GMC, EBE94GR, EBE94TL, EBE94TLC, EBE94TLR, EBE94TMC, EBE94TR, ECE74E, ECE74-Q, ECE92A, ECE92G, ECE92T, ECE94A, ECE94E, ECE94G, ECE94T, ECM73...(Otros modelos se puede ver en la tienda web)		

¹con lengüeta de puesta a tierra

bloques de bornes

otros

			
1			
código	551079	referencia	20802799 MA20802799
descripción	borne seccionable 6mm ² amarillo/verde para barra DIN 35mm H 35mm 1 polos		
Para modelos:	ECI72, ECI74, ECIW72, EPE7108		

grifos de gas





PEL

serie 20S



			
1			
código	101094	referencia	0100730 SIR0100730
descripción	grifo de gas PEL tipo 20S entrada gas M16x1,5 (tubo ϕ 10mm) boquilla bypass ϕ 0.35mm salida gas M16x1,5 (tubo ϕ 10/8mm) conexión termpar M8x1 conexión de piloto eje ϕ 8x6,5mm eje L 22/15mm parte plana abajo		
Para modelos:	CCG1041, CCG1042, CCG1045, CCG1061, CCG1062, CCG10652, CCG10653, CCG1081, CCG1082, CCG1085, CCG10852, CCG6020, CCG6040, CCG6045, CCG6046, CCG7001, CCG7020, CCG7021, CCG7022, CCG7040, CCG7041, CCG7042, CCG7045, CCG7046, CCG7061, CCG7062, CCG70652, CCG70653, CCG70663, CCG7201, CCG7220, CCG7221, CCG7222, CCG7240, CCG7241, CCG7242, CCG7245, CCG7246, CCG7261, CCG7262, CCG72652, CCG72653, CCG72662, CCG72663, CCG9020, CCG9021, CCG9022, CCG9040, CCG9041, CCG9042...(Otros modelos se puede ver en la tienda web)		
repuestos para	101094		
	código	100408	referencia —
boquilla bypass tipo PEL20/21 taladro ϕ 0.35mm rosca M5x0,5			
	código	101060	referencia 0100752 SI0100752 SIR0100752
grupo magnético estándar L 39mm D1 ϕ 15.4mm D2 ϕ 11mm apto para PEL20-21/JUNKERS/EGA			
	código	101205	referencia 0100753 SI0100753 SIR0100753
parte delantera de grifo de gas eje ϕ 8x6,5mm eje L 22/15mm parte plana arriba/abajo apto para PEL20			
	código	101230	referencia —
tuerca de termpar G1: M8x1 G2: M18x1 aluminio			
accesorios para	101094		
	código	101278	referencia 0100775 86720 MA86720 SIR0100775
anillo cortante para tubo ϕ 10mm UE 1 pzs			













Continúa en la página siguiente



accesorios para	101094		
	código	101300	referencia 0100774 SIR0100774
	tuerca de racor rosca M16x1,5 tubo ø 10mm		
	código	101450	referencia —
	anillo cortante para tuboø 8mm L 12.7mm UE 1 pzs ø ext. 10mm		
	código	101451	referencia —
	tuerca de racor rosca M16x1,5 tubo ø 8mm		
	código	110081	referencia —
	pomo ø 70mm eje ø 8x6,5mm parte plana universal		
	código	110083	referencia —
	símbolo para pomo grifo de gas sin llama piloto plata		

serie 21S			
			
1			
código	101824	referencia	CR0580450
descripción	grifo de gas PEL tipo 21S entrada gas brida de tubo ø21mm boquilla bypass ø 0.9mm salida gas M16x1,5 (tubo ø 10/8mm) conexión termopar M9x1 conexión de piloto M10x1 eje ø 8x6,5mm eje L 22/15mm parte plana arriba entrada de tubo ø 9mm		
Para modelos:	EBG7, EBG92AL, EBG92AR, EBG92GL, EBG92GR, EBG92TL, EBG92TR, EBG93AL, EBG93ALR, EBG93GL, EBG93GLR, EBG93TL, EBG93TLR, EBG94AL, EBG94ALR, EBG94AR, EBG94GL, EBG94GLR, EBG94GR, EBG94TL, EBG94TLR, EBG94TR, ECG7, ECG92A, ECG92G, ECG92T, ECG94A, ECG94E, ECG94F, ECG94G, ECG94T, ECG96A, ECG96E, ECG96F, ECG96G, ECG96H, ECG96T, ECG98A, ECG98F, ECG98G, ETG74GL-R		

			
1			
código	101397	referencia	0100731 CM226800 MACM226800 SIR0100731
descripción	grifo de gas PEL tipo 21S entrada gas M16x1,5 (tubo ø 10mm) boquilla bypass ø 0.35mm salida gas M16x1,5 (tubo ø 10/8mm) conexión termopar M9x1 conexión de piloto M10x1 eje ø 8x6,5mm eje L 22/15mm parte plana abajo		
Para modelos:	BG82ALL, BG82ARR, BG82GLL, BG82GRR, BG82TLL, BG82TRR, BG84ALL, BG84ALR, BG84ARR, BG84GLL, BG84GLR, BG84GRR, BG84TLL, BG84TLR, BG84TRR, CCG1041P, CCG1042P, CCG1045P, CCG1061P, CCG1062P, CCG10652P, CCG1081P, CCG1082P, CCG1085P, CCG7001P, CCG7020P, CCG7021P, CCG7022P, CCG7040P, CCG7041P, CCG7042P, CCG7045P, CCG7046P, CCG7061P, CCG7062P, CCG70652P, CCG70662P, CCG9020P, CCG9021P, CCG9022P, CCG9040P, CCG9041P, CCG9042P, CCG9045P, CCG9046P, CCG9060P, CCG9061P, CCG9062P, CCG90652P, CCG90662P...(Otros modelos se puede ver en la tienda web)		
repuestos para	101397		
	código	100408	referencia —
	boquilla bypass tipo PEL20/21 taladro ø 0.35mm rosca M5x0,5		

repuestos para	101397		
	código	101060	referencia 0100752 SIO100752 SIR0100752
	grupo magnético estándar L 39mm D1 ø 15.4mm D2 ø 11mm apto para PEL20-21/JUNKERS/EGA		
	código	101206	referencia —
	parte delantera de grifo de gas eje ø 8x6,5mm eje L 22/15mm parte plana arriba/abajo apto para PEL21		
	código	101231	referencia —
	tuerca de termopar G1: M9x1 G2: M18x1		
accesorios para	101397		
	código	100908	referencia 0100777 673500 MA673500 SIR0100777
	tornillo de racor rosca M10x1 para tuboø 4mm UE 1 pzs		
	código	100909	referencia 0100744 SIR0100744
	tornillo de racor rosca M10x1 para tuboø 6mm UE 1 pzs		
	código	101246	referencia 0100778 673600 MA673600 SIR0100778
	anillo cortante para tuboø 4mm UE 1 pzs		
	código	101278	referencia 0100775 86720 MA86720 SIR0100775
	anillo cortante para tuboø 10mm UE 1 pzs		
	código	101286	referencia 0100743 0100745 LAG2070023 LAR62070023 SIR0100743
	anillo cortante int.ø 6mm UE 1 pzs		
	código	101300	referencia 0100774 SIR0100774
	tuerca de racor rosca M16x1,5 tubo ø 10mm		
	código	101450	referencia —
	anillo cortante para tuboø 8mm L 12.7mm UE 1 pzs ø ext. 10mm		
	código	101451	referencia —
	tuerca de racor rosca M16x1,5 tubo ø 8mm		
	código	110081	referencia —
	pomo ø 70mm eje ø 8x6,5mm parte plana universal		
	código	112206	referencia —
	símbolo para pomo plata grifo de gas PEL21/22/23 T máx°C ø ext. 63mm int.ø 45.5mm		



código	101913	referencia	1031501300 MA1031501300
descripción	grifo de gas PEL tipo 21S entrada gas M16x1,5 (tubo ø 10mm) boquilla bypass ø 0.9mm salida gas M16x1,5 (tubo ø 10/8mm) conexión termopar M8x1 conexión de piloto M10x1 eje ø 6x4,6mm eje L 35/28mm parte plana derecho		
Para modelos:	CCG6220/1, CCG6230/1, CCG6245-1, CCG62652-1, CG62TPS, CG64FPS, CG64TPS, CG66FPS, CRG6220, CRG6240, GG62TGP, GG64TGP		
repuestos para	101913		
	código	100528	referencia 1033720200 1889000 MA1033720200 MA1889000
boquilla bypass tipo PEL20/21 taladro ø 0.9mm rosca M5x0,5			
	código	101060	referencia 0100752 S10100752 SIR0100752
grupo magnético estándar L 39mm D1 ø 15.4mm D2 ø 11mm apto para PEL20-21/JUNKERS/EGA			
	código	101230	referencia
tuerca de termopar G1: M8x1 G2: M18x1 aluminio			
accesorios para	101913		
	código	100908	referencia 0100777 673500 MA673500 SIR0100777
tornillo de racor rosca M10x1 para tuboø 4mm UE 1 pzs			
	código	100909	referencia 0100744 SIR0100744
tornillo de racor rosca M10x1 para tuboø 6mm UE 1 pzs			
	código	101246	referencia 0100778 673600 MA673600 SIR0100778
anillo cortante para tuboø 4mm UE 1 pzs			
	código	101278	referencia 0100775 86720 MA86720 SIR0100775
anillo cortante para tuboø 10mm UE 1 pzs			
	código	101286	referencia 0100743 0100745 LA62070023 LAR62070023 SIR0100743
anillo cortante int.ø 6mm UE 1 pzs			
	código	101300	referencia 0100774 SIR0100774
tuerca de racor rosca M16x1,5 tubo ø 10mm			
	código	101450	referencia
anillo cortante para tuboø 8mm L 12.7mm UE 1 pzs ø ext. 10mm			
	código	101451	referencia
tuerca de racor rosca M16x1,5 tubo ø 8mm			
	código	110078	referencia
pomo sin símbolo ø 70mm eje ø 6x4,6mm parte plana universal			
	código	112206	referencia
símbolo para pomo plata grifo de gas PEL21/22/23 T máx°C ø ext. 63mm int.ø 45.5mm			

serie 22S/O

código	101086	referencia	0100732 1888600 MA1888600 SIR0100732
descripción	grifo de gas PEL tipo 22S/O entrada gas M20x1,5 (tubo ø 12mm) boquilla bypass ø 0.35mm salida gas M20x1,5 (tubo ø 12/10mm) conexión termopar M9x1 conexión de piloto M10x1 eje ø 10x8mm eje L 25/17mm parte plana abajo		
Para modelos:	BG92ALL, BG92ARR, BG92GLL, BG92GRR, BG94ALL, BG94ALR, BG94ARR, BG94GLL, BG94GLR, BG94GRR, BGY2TLL, BGY2TRR, BGY4TLL, BGY4TLR, BGY4TRR, CCG9020-0, CCG9020-2, CCG9021-0, CCG9021-2, CCG9022-0, CCG9022-2, CCG9040-0, CCG9040-2, CCG9040-4, CCG9041-0, CCG9041-2, CCG9041-4, CCG9042-0, CCG9042-2, CCG9042-4, CPD70150, CPI70150, CRG7022, CRG7042, CRG7222, CRG7242, CRG9022, CRG9022S, CRG9042, CRG9042S, CSG-063, CSG-076, CTT7040, CTT7041, CTT7042, CTT7045, CTT70652L, CTT70653L, CTT72653L, DG72128...(Otros modelos se puede ver en la tienda web)		
repuestos para	101086		
	código	100259	referencia
boquilla bypass tipo PEL22 taladro ø 0.35mm rosca M6x0,5			
	código	101058	referencia 0100757 SIR0100757
grupo magnético L 39mm D1 ø 15.4mm D2 ø 13.5mm apto para PEL22/EGA24197 estándar			
	código	101201	referencia
parte delantera de grifo de gas eje ø 10x8mm eje L 25/17mm parte plana arriba/abajo apto para PEL22			
	código	101231	referencia
tuerca de termopar G1: M9x1 G2: M18x1			
	código	101240	referencia
empalme de gas rosca M20x1.5 tubo ø 12/10mm para grifos de gas PEL con junta y tronillos horizontal			
	código	101460	referencia
junta tórica ø 12.37mm D1 ø 2.62mm apto para PEL22			
	código	101461	referencia
tornillo Kit apto para PEL22 UE 4 pzs			
accesorios para	101086		
	código	100908	referencia 0100777 673500 MA673500 SIR0100777
tornillo de racor rosca M10x1 para tuboø 4mm UE 1 pzs			
	código	100909	referencia 0100744 SIR0100744
tornillo de racor rosca M10x1 para tuboø 6mm UE 1 pzs			
	código	101241	referencia
empalme de gas rosca M20x1.5 tubo ø 12/10mm para grifos de gas PEL vertical			
	código	101246	referencia 0100778 673600 MA673600 SIR0100778
anillo cortante para tuboø 4mm UE 1 pzs			

Continúa en la página siguiente



accesorios para		101086	
	código	101248	referencia 673300 MA673300
anillo cortante para tuboø 12mm UE 1 pzs apto para PEL			
	código	101249	referencia 0100780 SIR0100780
anillo cortante para tuboø 10mm UE 1 pzs			
	código	101250	referencia 673200 MA673200
tuerca de racor rosca M20x1.5 para ø de tubo 10mm			
	código	101251	referencia 673100 MA673100
tuerca de racor rosca M20x1.5 para ø de tubo 12mm			
	código	101286	referencia 0100743 0100745 LA62070023 LAR62070023 SIR0100743
anillo cortante int.ø 6mm UE 1 pzs			
	código	110080	referencia —
pomo ø 70mm eje ø 10x8mm parte plana universal			
	código	112206	referencia —
símbolo para pomo plata grifo de gas PEL21/22/23 T máx°C ø ext. 63mm int.ø 45.5mm			





serie 22S/V



código	101457	referencia	100513
descripción	grifo de gas alternativa a UNKERS tipo CH110 entrada gas M20x1,5 (tubo ø 12mm) boquilla bypass ø 0.35mm salida gas M20x1,5 (tubo ø 12/10mm) conexión termopar M8x1 conexión de piloto M10x1 eje ø 10mm eje L 25mm parte plana con salida para tubo		
repuestos para	101457		
	código	100259	referencia —
boquilla bypass tipo PEL22 taladro ø 0.35mm rosca M6x0,5			
	código	100908	referencia 0100777 673500 MA673500 SIR0100777
tornillo de racor rosca M10x1 para tuboø 4mm UE 1 pzs			
	código	101058	referencia 0100757 SIR0100757
grupo magnético L 39mm D1 ø 15.4mm D2 ø 13.5mm apto para PEL22/EGA24197 estándar			
	código	101200	referencia —
parte delantera de grifo de gas eje ø 10mm eje L 25mm parte plana apto para 22S/O			
	código	101230	referencia —
tuerca de termopar G1: M8x1 G2: M18x1 aluminio			
	código	101241	referencia —
empalme de gas rosca M20x1.5 tubo ø 12/10mm para grifos de gas PEL vertical			

repuestos para		101457	
	código	101246	referencia 0100778 673600 MA673600 SIR0100778
anillo cortante para tuboø 4mm UE 1 pzs			
	código	101460	referencia —
junta tórica ø 12.37mm D1 ø 2.62mm apto para PEL22			
	código	101461	referencia —
tornillo Kit apto para PEL22 UE 4 pzs			
accesorios para		101457	
	código	100945	referencia —
pasador elástico ø 3.2mm L 10mm			
	código	101218	referencia —
alargador de eje JUNKERS			
	código	101219	referencia —
alargador de eje L 25mm JUNKERS			
	código	101231	referencia —
tuerca de termopar G1: M9x1 G2: M18x1			
	código	101248	referencia 673300 MA673300
anillo cortante para tuboø 12mm UE 1 pzs apto para PEL			
	código	101249	referencia 0100780 SIR0100780
anillo cortante para tuboø 10mm UE 1 pzs			
	código	101250	referencia 673200 MA673200
tuerca de racor rosca M20x1.5 para ø de tubo 10mm			
	código	101251	referencia 673100 MA673100
tuerca de racor rosca M20x1.5 para ø de tubo 12mm			
	código	101290	referencia —
tuerca de termopar G1: M10x1 G2: M18x1 apto para PEL20/21			
	código	110064	referencia —
pomo			
	código	110066	referencia —
tornillo de pomo			
	código	550396	referencia —
alargador de eje L 25mm JUNKERS			

			
1			
código	101087	referencia	0100733 SIR0100733
descripción	grifo de gas PEL tipo 22S/V entrada gas M20x1,5 (tubo ø 12mm) boquilla bypass ø 0.35mm salida gas M20x1,5 (tubo ø 12/10mm) conexión termopar M9x1 conexión de piloto M10x1 eje ø 10x8mm eje L 25/17mm parte plana arriba		
repuestos para	101087		
	código	100259	referencia —
	boquilla bypass tipo PEL22 taladro ø 0.35mm rosca M6x0,5		
	código	101058	referencia 0100757 SIR0100757
	grupo magnético L 39mm D1 ø 15.4mm D2 ø 13.5mm apto para PEL22/EGA24197 estándar		
	código	101201	referencia —
	parte delantera de grifo de gas eje ø 10x8mm eje L 25/17mm parte plana arriba/abajo apto para PEL22		
	código	101231	referencia —
	tuerca de termopar G1: M9x1 G2: M18x1		
	código	101241	referencia —
	empalme de gas rosca M20x1.5 tubo ø 12/10mm para grifos de gas PEL vertical		
	código	101460	referencia —
	junta tórica ø 12.37mm D1 ø 2.62mm apto para PEL22		
	código	101461	referencia —
	tornillo Kit apto para PEL22 UE 4 pzs		
accesorios para	101087		
	código	100908	referencia 0100777 673500 MA673500 SIR0100777
	tornillo de racor rosca M10x1 para tuboø 4mm UE 1 pzs		
	código	100909	referencia 0100744 SIR0100744
	tornillo de racor rosca M10x1 para tuboø 6mm UE 1 pzs		
	código	101240	referencia —
	empalme de gas rosca M20x1.5 tubo ø 12/10mm para grifos de gas PEL con junta y tronillos horizontal		
	código	101246	referencia 0100778 673600 MA673600 SIR0100778
	anillo cortante para tuboø 4mm UE 1 pzs		
	código	101248	referencia 673300 MA673300
	anillo cortante para tuboø 12mm UE 1 pzs apto para PEL		
	código	101249	referencia 0100780 SIR0100780
	anillo cortante para tuboø 10mm UE 1 pzs		
	código	101250	referencia 673200 MA673200
	tuerca de racor rosca M20x1.5 para ø de tubo 10mm		

accesorios para	101087		
	código	101251	referencia 673100 MA673100
	tuerca de racor rosca M20x1.5 para ø de tubo 12mm		
	código	101286	referencia 0100743 0100745 LA62070023 LAR62070023 SIR0100743
	anillo cortante int.ø 6mm UE 1 pzs		
	código	110080	referencia —
	pomo ø 70mm eje ø 10x8mm parte plana universal		
	código	112206	referencia —
	símbolo para pomo plata grifo de gas PEL21/22/23 T máx°C ø ext. 63mm int.ø 45.5mm		

serie 23S/O



			
1			
código	101092	referencia	0100736 SIR0100736
descripción	grifo de gas PEL tipo 23S/O entrada gas M28x1,5 (tubo ø 20mm) boquilla bypass ø 0.35mm salida gas M24x1,5 (tubo ø 16mm) conexión termopar M10x1 conexión de piloto M10x1 eje ø 10x8mm eje L 25/17mm parte plana arriba		
Para modelos:	CNG70160, CNG72160, CNG90160, CNG90160S, CNG90160-S, CPD90100AP, CPD90100A-P, CPD90100P, CPD90150AP, CPD90150A-P, CPD9015-P, CPI90100AP, CPI90100A-P, CPI90100P, CPI90100-P, CPI90150AP, CPI90150A-P, CPI90150P, CPI90150-P, DG74155, DG94160, DGY4160, PG8AD10, PG8AD15, PG8AI10, PG8AI15, PG8ND10, PG8ND15, PG8NI10, PG8NI15, PG9AD10, PG9AD15, PG9AI10, PG9AI15, PG9ND10, PG9ND15, PG9NI10, PG9NI15		
repuestos para	101092		
	código	100455	referencia —
	boquilla bypass tipo PEL23/24 taladro ø 0.35mm rosca M8x0,5		
	código	101059	referencia —
	grupo magnético G1: M10x1 G2: M22x1 L 46mm ø 18mm apto para PEL23S M10x1		
	código	101204	referencia —
	parte delantera de grifo de gas eje ø 10x8mm eje L 25/17mm parte plana arriba/abajo apto para PEL23S		
	código	101244	referencia —
	empalme de gas rosca M24x1,5 tubo ø 12/16mm horizontal para grifos de gas PEL		
	código	101463	referencia —
	tornillo apto para PEL23S UE 4 pzs		
	código	528455	referencia —
	junta tórica Viton espesor 2.62mm int.ø 18.72mm UE 1 pzs		
accesorios para	101092		
	código	100908	referencia 0100777 673500 MA673500 SIR0100777
	tornillo de racor rosca M10x1 para tuboø 4mm UE 1 pzs		







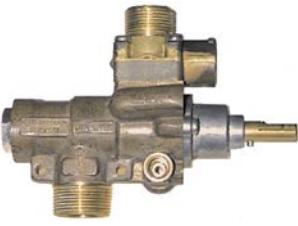









Continúa en la página siguiente



accesorios para		101092	
	código	100909	referencia 0100744 SIR0100744
tornillo de racor rosca M10x1 para tuboø 6mm UE 1 pzs			
	código	101246	referencia 0100778 673600 MA673600 SIR0100778
anillo cortante para tuboø 4mm UE 1 pzs			
	código	101252	referencia —
tuerca de racor rosca M24x1,5 para ø de tubo 12mm			
	código	101253	referencia —
tuerca de racor rosca M24x1,5 PEL para ø de tubo 16mm			
	código	101254	referencia —
tuerca de racor rosca M28x1.5 tubo ø 20mm			
	código	101255	referencia —
anillo cortante para tuboø 12mm UE 1 pzs			
	código	101256	referencia —
anillo cortante para tuboø 16mm UE 1 pzs			
	código	101257	referencia —
anillo cortante para tuboø 20mm UE 1 pzs			
	código	101286	referencia 0100743 0100745 LA62070023 LAR62070023 SIR0100743
anillo cortante int.ø 6mm UE 1 pzs			
	código	110080	referencia —
pomo ø 70mm eje ø 10x8mm parte plana universal			
	código	112206	referencia —
símbolo para pomo plata grifo de gas PEL21/22/23 T máx°C ø ext. 63mm int.ø 45.5mm			

serie 23S/V

			
1			
código	101093	referencia	0100734 SIR0100734
descripción	grifo de gas PEL tipo 23S/V entrada gas M28x1,5 (tubo ø 20mm) boquilla bypass ø 0.35mm conexión termopar M10x1 conexión de piloto M10x1 eje ø 10x8mm eje L 25/17mm parte plana abajo		
Para modelos:	CNG50150, CNG50160, CTT1041, CTT1042, CTT1045, CTT9040, CTT9041, CTT9042, CTT9045, CTT9046, CTT90652R, CTT90663R, DGP4150, DGPT160, TG94APS, TG94EPS, TG94FPS, TG94GPS, TG96FPS, TGP4APS, TGP4FPS, TGP4GPS, TGY4TPS		
repuestos para	101093		
	código	100455	referencia —
boquilla bypass tipo PEL23/24 taladro ø 0.35mm rosca M8x0,5			
	código	101059	referencia —
grupo magnético G1: M10x1 G2: M22x1 L 46mm ø 18mm apto para PEL23S M10x1			

repuestos para		101093	
	código	101204	referencia —
parte delantera de grifo de gas eje ø 10x8mm eje L 25/17mm parte plana arriba/abajo apto para PEL23S			
	código	101245	referencia —
empalme de gas rosca M24x1,5 tubo ø 12/16mm vertical para grifos de gas PEL			
	código	101463	referencia —
tornillo apto para PEL23S UE 4 pzs			
	código	528455	referencia —
junta tórica Viton espesor 2.62mm int.ø 18.72mm UE 1 pzs			
accesorios para		101093	
	código	100908	referencia 0100777 673500 MA673500 SIR0100777
tornillo de racor rosca M10x1 para tuboø 4mm UE 1 pzs			
	código	100909	referencia 0100744 SIR0100744
tornillo de racor rosca M10x1 para tuboø 6mm UE 1 pzs			
	código	101246	referencia 0100778 673600 MA673600 SIR0100778
anillo cortante para tuboø 4mm UE 1 pzs			
	código	101252	referencia —
tuerca de racor rosca M24x1,5 para ø de tubo 12mm			
	código	101253	referencia —
tuerca de racor rosca M24x1,5 PEL para ø de tubo 16mm			
	código	101254	referencia —
tuerca de racor rosca M28x1.5 tubo ø 20mm			
	código	101255	referencia —
anillo cortante para tuboø 12mm UE 1 pzs			
	código	101256	referencia —
anillo cortante para tuboø 16mm UE 1 pzs			
	código	101257	referencia —
anillo cortante para tuboø 20mm UE 1 pzs			
	código	101286	referencia 0100743 0100745 LA62070023 LAR62070023 SIR0100743
anillo cortante int.ø 6mm UE 1 pzs			
	código	110080	referencia —
pomo ø 70mm eje ø 10x8mm parte plana universal			
	código	112206	referencia —
símbolo para pomo plata grifo de gas PEL21/22/23 T máx°C ø ext. 63mm int.ø 45.5mm			



compatible JUNKERS



1

código	101457	referencia	100513
descripción	grifo de gas alternativa a UNKERS tipo CH110 entrada gas M20x1,5 (tubo ø 12mm) boquilla bypass ø 0.35mm salida gas M20x1,5 (tubo ø 12/10mm) conexión termopar M8x1 conexión de piloto M10x1 eje ø 10mm eje L 25mm parte plana con salida para tubo		
repuestos para	101457		
	código	100259	referencia —
	boquilla bypass tipo PEL22 taladro ø 0.35mm rosca M6x0,5		
	código	100908	referencia 0100777 673500 MA673500 SIR0100777
	tornillo de racor rosca M10x1 para tuboø 4mm UE 1 pzs		
	código	101058	referencia 0100757 SIR0100757
	grupo magnético L 39mm D1 ø 15.4mm D2 ø 13.5mm apto para PEL22/EGA24197 estándar		
	código	101200	referencia —
	parte delantera de grifo de gas eje ø 10mm eje L 25mm parte plana apto para 22S/O		
	código	101230	referencia —
	tuerca de termopar G1: M8x1 G2: M18x1 aluminio		
	código	101241	referencia —
	empalme de gas rosca M20x1.5 tubo ø 12/10mm para grifos de gas PEL vertical		
	código	101246	referencia 0100778 673600 MA673600 SIR0100778
	anillo cortante para tuboø 4mm UE 1 pzs		
	código	101460	referencia —
	junta tórica ø 12.37mm D1 ø 2.62mm apto para PEL22		
	código	101461	referencia —
	tornillo Kit apto para PEL22 UE 4 pzs		
accesorios para	101457		
	código	100945	referencia —
	pasador elástico ø 3.2mm L 10mm		
	código	101218	referencia —
	alargador de eje JUNKERS		
	código	101219	referencia —
	alargador de eje L 25mm JUNKERS		
	código	101231	referencia —
	tuerca de termopar G1: M9x1 G2: M18x1		
	código	101248	referencia 673300 MA673300
	anillo cortante para tuboø 12mm UE 1 pzs apto para PEL		

accesorios para	101457		
	código	101249	referencia 0100780 SIR0100780
	anillo cortante para tuboø 10mm UE 1 pzs		
	código	101250	referencia 673200 MA673200
	tuerca de racor rosca M20x1.5 para ø de tubo 10mm		
	código	101251	referencia 673100 MA673100
	tuerca de racor rosca M20x1.5 para ø de tubo 12mm		
	código	101290	referencia —
	tuerca de termopar G1: M10x1 G2: M18x1 apto para PEL20/21		
	código	110064	referencia —
	pomo		
	código	110066	referencia —
	tornillo de pomo		
	código	550396	referencia —
	alargador de eje L 25mm JUNKERS		

termostatos para gas

SIT

serie 630 Eurosit



1

código	103310	referencia	CR0979080
descripción	termostato de gas tipo serie 630 Eurosit 110-190°C		







1



código	101413	referencia	0100880 KVL0008 SIR0100880 SIRKVL0008
descripción	termostato de gas tipo serie 630 Eurosit T máx 100°C 30-100°C entrada gas 3/8" salida gas 3/8" conexión termopar M9x1 conexión de piloto M10x1 sonda ø 5mm sonda L 122mm capilar 1050mm SIT		
Para modelos:	CMG7021, CMG7022, CMG7041, CMG7042, CMG9021, CMG9022, CMG9041, CMG9042, MG92APS, MG92GPS, MG94APS, MG94GPS		
accesorios para	101413		
	código	100904	referencia 1394700 MA1394700
	tornillo de apriete M10x1 para tuboø 4mm UE 1 pzs		



Continúa en la página siguiente



accesorios para	101413			
	código	100905	referencia	—
	tornillo de apriete M10x1 para tuboø 6mm UE 1 pzs			
	código	101273	referencia	—
	anillo cortante para tuboø 12mm L 9.5mm latón UE 1 pzs apto para universal			
	código	101276	referencia	—
	tornillo de racor rosca 3/8" tubo ø 12mm UE 1 pzs			
	código	101333	referencia	—
	tapón rosca 3/8" con junta tórica			

				
código	103076	referencia	CR0508680	
descripción	termostato de gas tipo serie 630 Eurosit T máx 190°C 110-190°C entrada gas 3/8" salida gas 3/8" conexión termopar M9x1 conexión de piloto M10x1 sonda ø 4mm sonda L 202mm capilar 1050mm SIT			
Para modelos:	EFG72108, EFG72110, EFG72115, EFG73208T, EFG73210, EFG74215, EFG92115, EFG92115S, EFG92123, EFG93210, EFG94215, EFG94215S, EFG94223			

				
código	101409	referencia	0100879 1031504800 MA1031504800 SIR0100879	
descripción	termostato de gas tipo serie 630 Eurosit T máx 280°C 40-280°C entrada gas 3/8" salida gas 3/8" conexión termopar M9x1 conexión de piloto M10x1 sonda ø 4mm sonda L 72mm capilar 1050mm SIT			
Para modelos:	BG62TLC, BG63TLC, BG64TLC, BG72GLC, BG72TLC, BG74GLC, BG74GMC, BG74TLC, BG74TMC, BG92ALC, BG92ARC, BG92GLC, BG92GRC, BG94ALC, BG94AMC, BG94ARC, BG94GLC, BG94GMC, BG94GRC, BGY2TLC, BGY2TRC, BGY4TLC, BGY4TMC, BGY4TRC, CCG7001, CCG7001P, CCG7201, CG76HPS, CG86HPS, CGG6020C, CGG6030C, CGG6040C, CGG6220C, CGG6230C, CGG6240C, CGG7020C, CGG7021C, CGG7040C, CGG7040LRC, CGG7041C, CGG7041LRC, CGG7221C, CGG7240C, CGG7240LRC, CGG7241C, CGG9020-1, CGG9020-3, CGG9021-1, CGG9021-3, CGG9022-1...(Otros modelos se puede ver en la tienda web)			
repuestos para	101409			
	código	101333	referencia	—
	tapón rosca 3/8" con junta tórica			
accesorios para	101409			
	código	100904	referencia	1394700 MA1394700
	tornillo de apriete M10x1 para tuboø 4mm UE 1 pzs			

accesorios para	101409			
	código	100905	referencia	—
	tornillo de apriete M10x1 para tuboø 6mm UE 1 pzs			
	código	101273	referencia	—
	anillo cortante para tuboø 12mm L 9.5mm latón UE 1 pzs apto para universal			
	código	101276	referencia	—
	tornillo de racor rosca 3/8" tubo ø 12mm UE 1 pzs			

				
código	101915	referencia	BN826920012 KVL0007	
descripción	termostato de gas tipo serie 630 Eurosit T máx 320°C 80-320°C entrada gas 3/8" salida gas 3/8" conexión termopar M9x1 conexión de piloto M10x1 sonda ø 4mm sonda L 72mm capilar 1050mm SIT			
Para modelos:	BG72GLC, BG72TLC, BG74GLC, BG74GMC, CGG6020C, CGG6030C, CGG6040C, CGG7020C, CGG7040C, CGG7040LRC, CGG7041C, CGG7041LRC, CGG7221C, CGG7241C			
accesorios para	101915			
	código	100825	referencia	—
	eje de grifo de gas eje ø 8x6,5mm eje L 22/14mm apto para EUROSIT			
	código	100904	referencia	1394700 MA1394700
	tornillo de apriete M10x1 para tuboø 4mm UE 1 pzs			
	código	100905	referencia	—
	tornillo de apriete M10x1 para tuboø 6mm UE 1 pzs			
	código	100949	referencia	—
	junta apto para serie 630 Eurosit			
	código	101273	referencia	—
	anillo cortante para tuboø 12mm L 9.5mm latón UE 1 pzs apto para universal			
	código	101276	referencia	—
	tornillo de racor rosca 3/8" tubo ø 12mm UE 1 pzs			
	código	101333	referencia	—
	tapón rosca 3/8" con junta tórica			
	código	101390	referencia	—
	eje de grifo de gas eje ø 6x4,6mm eje L 32/15mm grifo de gas con llama piloto apto para ZANUSSI, MARENO para termostato de gas EUROSIT			
	código	101392	referencia	—
	adaptador apto para serie 630 Eurosit			
	código	110357	referencia	—
	eje de grifo de gas eje ø 8x6,5mm eje L 36/12mm apto para serie 630 Eurosit			

Continúa en la página siguiente



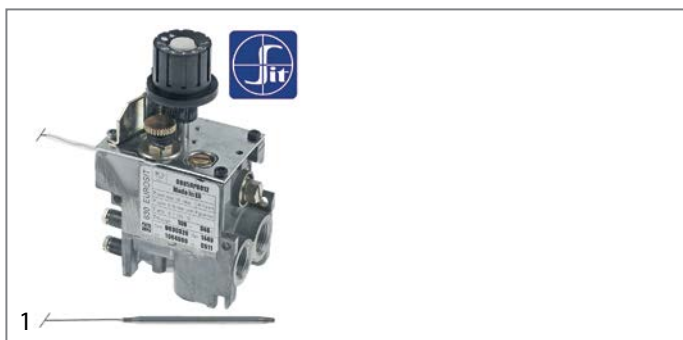

accesorios para 101915			
	código	110358	referencia —
adaptador eje ø 10x8mm eje L 29/18mm apto para serie 630 Eurosit			





código	101125	referencia	0100873 1887600 KVL0001 KVL0003 KVL0004 KVL0006 MA1887600 SIR0100873 SIRKVL0001 SIRKVL0003 SIRKVL0004 SIRKVL0006
---------------	--------	-------------------	---

descripción termostato de gas tipo serie 630 Eurosit T máx 340°C 100-340°C entrada gas 3/8" salida gas 3/8" conexión termopar M9x1 conexión de piloto M10x1 sonda ø 4mm sonda L 72mm capilar 1050mm SIT

Para modelos: BG62TLC, BG62TLL, BG62TRR, BG63TLC, BG63TLL, BG63TLR, BG64TLC, BG64TLL, BG64TLR, BG72GLL, BG72GRR, BG72TLL, BG72TRR, BG74GLL, BG74GLR, BG74GRR, BG74TLL, BG74TLR, BG74TRR, BG82GLC, BG82TLC, BG84ALC, BG84AMC, BG84GLC, BG84GMC, BG84TLC, BG84TMC, CBG7050, CBG7050C, CBG9060CP, CBG9060C-P, CBG9060P, CCG1045, CCG1045P, CCG10652, CCG10652P, CCG10653, CCG1085, CCG10852, CCG1085P, CCG6045, CCG7045, CCG7045P, CCG70652, CCG70652P, CCG70653, CCG7245, CCG72652, CCG72653, CCG9045P... (Otros modelos se puede ver en la tienda web)

accesorios para 101125			
	código	100825	referencia —
eje de grifo de gas eje ø 8x6,5mm eje L 22/14mm apto para EUROSIT			
	código	100904	referencia 1394700 MA1394700
tornillo de apriete M10x1 para tubo ø 4mm UE 1 pzs			
	código	100905	referencia —
tornillo de apriete M10x1 para tubo ø 6mm UE 1 pzs			
	código	100949	referencia —
junta apto para serie 630 Eurosit			
	código	101273	referencia —
anillo cortante para tubo ø 12mm L 9.5mm latón UE 1 pzs apto para universal			
	código	101276	referencia —
tornillo de racor rosca 3/8" tubo ø 12mm UE 1 pzs			
	código	101333	referencia —
tapón rosca 3/8" con junta tórica			
	código	101390	referencia —
eje de grifo de gas eje ø 6x4,6mm eje L 32/15mm grifo de gas con llama piloto apto para ZANUSSI, MARENO para termostato de gas EUROSIT			

accesorios para 101125			
	código	101392	referencia —
adaptador apto para serie 630 Eurosit			
	código	110357	referencia —
eje de grifo de gas eje ø 8x6,5mm eje L 36/12mm apto para serie 630 Eurosit			
	código	110358	referencia —
adaptador eje ø 10x8mm eje L 29/18mm apto para serie 630 Eurosit			

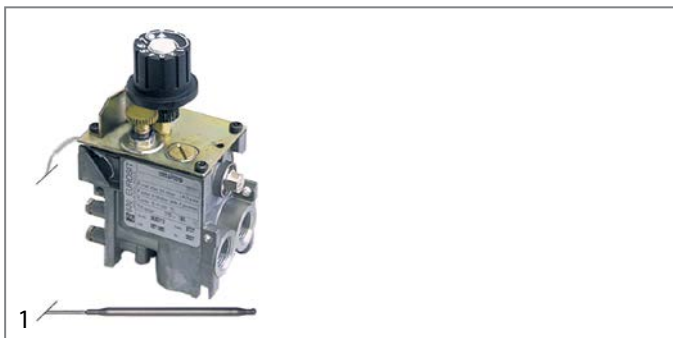

código	101700	referencia	CR0585670
descripción	termostato de gas tipo serie 630 Eurosit T máx 340°C 100-340°C entrada gas 3/8" salida gas 3/8" conexión termopar M9x1 conexión de piloto M10x1 sonda ø 4mm sonda L 72mm capilar 1050mm SIT		
Para modelos:	EBG7-CROMO, EBG92ALC, EBG92ARC, EBG92GLC, EBG92GRC, EBG92TLC, EBG92TRC, EBG93ALC, EBG93AMC, EBG93GLC, EBG93GMC, EBG93TLC, EBG93TMC, EBG94ALC, EBG94AMC, EBG94GLC, EBG94GMC, EBG94TLC, EBG94TMC, ECG7-FG, ECG94F, ECG96F, ECG96H, ECG98F, ESG74, ETG74, ETG94F, ETG94FL, ETG96F, ETG96FC, ETG96FL		

accesorios para 101700			
	código	100904	referencia 1394700 MA1394700
tornillo de apriete M10x1 para tubo ø 4mm UE 1 pzs			
	código	100905	referencia —
tornillo de apriete M10x1 para tubo ø 6mm UE 1 pzs			
	código	101273	referencia —
anillo cortante para tubo ø 12mm L 9.5mm latón UE 1 pzs apto para universal			
	código	101276	referencia —
tornillo de racor rosca 3/8" tubo ø 12mm UE 1 pzs			
	código	101333	referencia —
tapón rosca 3/8" con junta tórica			

serie 710 Minisit

código	101131	referencia	0108030 SIR0108030
descripción	termostato de gas sin tapa, botón ni codo SIT tipo MINISIT 710 T máx 190°C 50-190°C entrada gas 1/2" salida gas 3/8" conexión termopar M9x1 conexión de piloto M10x1 sonda ø 5mm sonda L 98mm capilar 1200mm tipo de sensor tipo A2 regulador de presión no regulador de presiónmbar prensaestopas		
Para modelos:	CFG70115, CFG70215, CFG72215, CFG90120, CFG90210, CFG90210S, CFG90220, FG92210, FGY2210		
repuestos para	101131		
	código	101053	referencia —
	grupo magnético G1: M9x1 G2: M24x1 L 45mm ø 17mm apto para Minisit		
	código	102103	referencia —
	sensor 60-200°C sonda ø 5mm sonda L 98mm capilar 1050mm T máx 200°C freidora tipo de sensor tipo A2 apto para MINISIT 710		
accesorios para	101131		
	código	100809	referencia —
	junta tórica EPDM espesor 2mm int.ø 21mm UE 1 pzs		
	código	100820	referencia —
	conducción para prensaestopas M M14x1,5 H M10x0,75 sonda ø máx. 6.5mm EC 22		
	código	100904	referencia 1394700 MA1394700
	tornillo de apriete M10x1 para tuboø 4mm UE 1 pzs		
	código	100905	referencia —
	tornillo de apriete M10x1 para tuboø 6mm UE 1 pzs		
	código	101054	referencia —
	grupo magnético G1: M10x1 G2: M24x1 L 45mm ø 17mm apto para Minisit		
	código	101136	referencia 0100857 SIO100857 SIR0100857
	encendedor piezoeléctrico apto para Minisit con tapa ømm empalme F6,3x0,8		
	código	101137	referencia —
	tapa sin piezoencendedor		
	código	101267	referencia —
	reducción H 3/8" M 1/2" L 21mm		
	código	101268	referencia —
	empalme de gas rosca 3/8" acodado con junta tórica MINISIT 710		
	código	101269	referencia —
	empalme de gas rosca 1/2" acodado con junta tórica MINISIT 710		
	código	101270	referencia —
	unión roscada H 3/8" M 3/8" L 28mm		

accesorios para	101131		
	código	101272	referencia —
	unión roscada H 1/2" M 3/8" L 57mm		
	código	101273	referencia —
	anillo cortante para tuboø 12mm L 9.5mm latón UE 1 pzs apto para universal		
	código	101274	referencia —
	anillo cortante para tuboø 16mm UE 1 pzs		
	código	101275	referencia —
	tornillo de racor rosca 1/2" para tuboø 16mm UE 1 pzs		
	código	101276	referencia —
	tornillo de racor rosca 3/8" tubo ø 12mm UE 1 pzs		
	código	110068	referencia 0100856 1393500 MA1393500 SIR0100856
	pomo apto para Minisit ø 37mm		

código	101912 ¹	referencia	0100871 SIR0100871
descripción	termostato de gas SIT tipo MINISIT 710 T máx 190°C 50-190°C entrada gas 1/2" salida gas 3/8" conexión termopar M9x1 conexión de piloto M10x1 sonda ø 14.4mm sonda L 14.5mm capilar 1050mm tipo de sensor tipo F1 regulador de presión presente regulador de presión 3-18mbar prensaestopas		
repuestos para	101912		
	código	101053	referencia —
	grupo magnético G1: M9x1 G2: M24x1 L 45mm ø 17mm apto para Minisit		
accesorios para	101912		
	código	100809	referencia —
	junta tórica EPDM espesor 2mm int.ø 21mm UE 1 pzs		
	código	100904	referencia 1394700 MA1394700
	tornillo de apriete M10x1 para tuboø 4mm UE 1 pzs		
	código	100905	referencia —
	tornillo de apriete M10x1 para tuboø 6mm UE 1 pzs		
	código	101054	referencia —
	grupo magnético G1: M10x1 G2: M24x1 L 45mm ø 17mm apto para Minisit		
	código	101136	referencia 0100857 SIO100857 SIR0100857
	encendedor piezoeléctrico apto para Minisit con tapa ømm empalme F6,3x0,8		

¹rosca de sonda 1/4"
Continúa en la página siguiente





accesorios para	101912			
	código	101137	referencia	—
	tapa sin piezoencendedor			
	código	101267	referencia	—
	reducción H 3/8" M 1/2" L 21mm			
	código	101268	referencia	—
	empalme de gas rosca 3/8" acodado con junta tórica MINISIT 710			
	código	101269	referencia	—
	empalme de gas rosca 1/2" acodado con junta tórica MINISIT 710			
	código	101270	referencia	—
	unión roscada H 3/8" M 3/8" L 28mm			
	código	101272	referencia	—
	unión roscada H 1/2" M 3/8" L 57mm			
	código	101273	referencia	—
	anillo cortante para tuboø 12mm L 9.5mm latón UE 1 pzs apto para universal			
	código	101274	referencia	—
	anillo cortante para tuboø 16mm UE 1 pzs			
	código	101275	referencia	—
	tornillo de racor rosca 1/2" para tuboø 16mm UE 1 pzs			
	código	101276	referencia	—
	tornillo de racor rosca 3/8" tubo ø 12mm UE 1 pzs			
	código	110068	referencia	0100856 1393500 MA1393500 SIR0100856
	pomo apto para Minisit ø 37mm			
	código	361182	referencia	—
	tuerca rosca 1/4" H 5mm latón niquelado EC 17 UE 1 pzs			
	código	532520	referencia	—
	junta tórica silicona espesor 2.62mm int.ø 15.08mm UE 1 pzs			



código	101438	referencia	0100856 SIR0100855	
descripción	termostato de gas SIT tipo MINISIT 710 T máx 340°C 100-340°C entrada gas 1/2" salida gas 3/8" conexión termopar M9x1 conexión de piloto M10x1 sonda ø 5mm sonda L 68mm capilar 1050mm tipo de sensor tipo B1 regulador de presión presente regulador de presión 3-18mbar prensaestopas			
repuestos para	101438			
	código	101053	referencia	—
	grupo magnético G1: M9x1 G2: M24x1 L 45mm ø 17mm apto para Minisit			

repuestos para	101438			
	código	102102	referencia	—
	sensor 100-340°C sonda ø 5mm sonda L 68mm capilar 1750mm T máx 340°C horno/grill tipo de sensor tipo B1 apto para MINISIT 710			
accesorios para	101438			
	código	100809	referencia	—
	junta tórica EPDM espesor 2mm int.ø 21mm UE 1 pzs			
	código	100904	referencia	1394700 MA1394700
	tornillo de apriete M10x1 para tuboø 4mm UE 1 pzs			
	código	100905	referencia	—
	tornillo de apriete M10x1 para tuboø 6mm UE 1 pzs			
	código	101054	referencia	—
	grupo magnético G1: M10x1 G2: M24x1 L 45mm ø 17mm apto para Minisit			
	código	101136	referencia	0100857 SIO100857 SIR0100857
	encendedor piezoeléctrico apto para Minisit con tapa ømm empalme F6,3x0,8			
	código	101137	referencia	—
	tapa sin piezoencendedor			
	código	101267	referencia	—
	reducción H 3/8" M 1/2" L 21mm			
	código	101268	referencia	—
	empalme de gas rosca 3/8" acodado con junta tórica MINISIT 710			
	código	101269	referencia	—
	empalme de gas rosca 1/2" acodado con junta tórica MINISIT 710			
	código	101270	referencia	—
	unión roscada H 3/8" M 3/8" L 28mm			
	código	101272	referencia	—
	unión roscada H 1/2" M 3/8" L 57mm			
	código	101273	referencia	—
	anillo cortante para tuboø 12mm L 9.5mm latón UE 1 pzs apto para universal			
	código	101274	referencia	—
	anillo cortante para tuboø 16mm UE 1 pzs			
	código	101275	referencia	—
	tornillo de racor rosca 1/2" para tuboø 16mm UE 1 pzs			
	código	101276	referencia	—
	tornillo de racor rosca 3/8" tubo ø 12mm UE 1 pzs			
	código	110068	referencia	0100856 1393500 MA1393500 SIR0100856
	pomo apto para Minisit ø 37mm			









accesorios			
sensores			
			
código	102104 ¹	referencia	0100853
descripción	sensor 110-190°C sonda ø 11mm rosca sonda 1/4" sonda L 26mm capilar 1050mm T máx 190°C freidora tipo de sensor tipo F3 apto para MINISIT 710		
accesorios para	102104		
	código	361182	referencia —
	tuerca rosca 1/4" H 5mm latón niquelado EC 17 UE 1 pzs		
	código	510420	referencia —
	junta cobre ø ext. 19.9mm int.ø 14.3mm espesor 2mm UE 1 pzs		
	código	529251	referencia —
	junta tórica EPDM espesor 2.62mm int.ø 15.08mm UE 1 pzs		

¹rosca de sonda 1/4"

PEL

serie 24ST



			
código	101076	referencia	0100724 SIR0100724
descripción	termostato de gas PEL tipo 24ST 120-320°C entrada gas M20x1,5 (tubo ø 12mm) boquilla bypass ø 0.35mm salida gas M20x1,5 (tubo ø 12/10mm) conexión termopar M9x1 conexión de piloto M10x1 capilar 1200mm sonda ø 6mm sonda L 100mm eje ø 10x8mm eje L 27/17mm parte plana arriba		
repuestos para	101076		
	código	100455	referencia —
	boquilla bypass tipo PEL23/24 taladro ø 0.35mm rosca M8x0,5		
	código	101058	referencia 0100757 SIR0100757
	grupo magnético L 39mm D1 ø 15.4mm D2 ø 13.5mm apto para PEL22/EGA24197 estándar		
	código	106200	referencia —
	tuerca rosca M9x1 apto para PEL24/25S		
accesorios para	101076		
	código	100908	referencia 0100777 673500 MA673500 SIR0100777
	tornillo de racor rosca M10x1 para tuboø 4mm UE 1 pzs		
	código	100909	referencia 0100744 SIR0100744
	tornillo de racor rosca M10x1 para tuboø 6mm UE 1 pzs		

accesorios para	101076		
	código	101246	referencia 0100778 673600 MA673600 SIR0100778
	anillo cortante para tuboø 4mm UE 1 pzs		
	código	101248	referencia 673300 MA673300
	anillo cortante para tuboø 12mm UE 1 pzs apto para PEL		
	código	101249	referencia 0100780 SIR0100780
	anillo cortante para tuboø 10mm UE 1 pzs		
	código	101250	referencia 673200 MA673200
	tuerca de racor rosca M20x1.5 para ø de tubo 10mm		
	código	101251	referencia 673100 MA673100
	tuerca de racor rosca M20x1.5 para ø de tubo 12mm		
	código	101286	referencia 0100743 0100745 LA62070023 LAR62070023 SIR0100743
	anillo cortante int.ø 6mm UE 1 pzs		
	código	110079	referencia —
	símbolo para pomo termostato de gas 1-8 plata		
	código	110080	referencia —
	pomo ø 70mm eje ø 10x8mm parte plana universal		

válvulas de gas y centralitas de gas automáticas

válvulas de control de gas

HONEYWELL









			
código	106012	referencia	LAR63020170
descripción	válvula de gas tipo VK4115V 220-240V 50/60Hz entrada gas brida 32x32mm salida gas brida 32x32mm conexión termopar conexión de piloto margen de presión 15-60mbar máx. 60mbar tipo de operador HONEYWELL brida 32x32mm		
Para modelos:	GMT06D, GVT10D		
accesorios para	106012		
	código	102845	referencia —
	empalme de gas acodado 1/2" brida 32x32mm dist. del agujero 24x24mm Tandem		
	código	102846	referencia —
	empalme de gas recto 1/2" brida 32x32mm dist. del agujero 24x24mm apto para Tandem		



SIT







ELETTROSIT











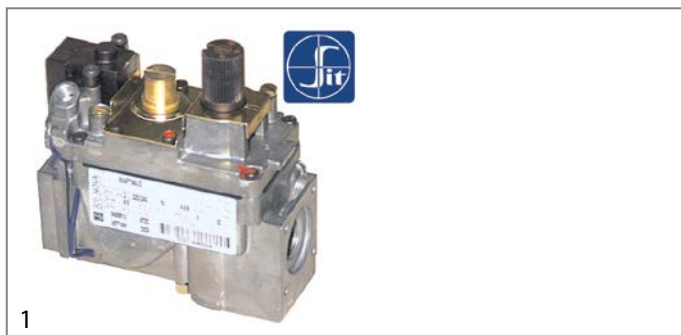



1			
código	101127	referencia	0100883 LAR63025030 SIR0100883
descripción	válvula de gas SIT tipo ELETTROSIT aliment. 230V entrada gas 3/4" salida gas 3/4" conexión termopar M9x1 conexión de piloto M10x1 lateral núm. Ref. 0.810.175		
repuestos para	101127		
	código	101312	referencia 0109011 CR0507660 LAR63060010 R63060010 SIR0109011
	microinterruptor		
	código	101352	referencia
	bobina magnética aliment. 230V 50Hz apto para ELETTROSIT		
accesorios para	101127		
	código	100006	referencia
	encendedor piezoeléctrico apto para ELETTROSIT cuerpo plástico soplado empalme ø2,4mm ø 14mm		
	código	100904	referencia 1394700 MA1394700
	tornillo de apriete M10x1 para tubo ø 4mm UE 1 pzs		
	código	100905	referencia
	tornillo de apriete M10x1 para tubo ø 6mm UE 1 pzs		
	código	101301	referencia
	empalme de gas rosca 1/2" recto ELETTROSIT atornillado con junta tórica		
	código	101303	referencia
	empalme de gas recto rosca 3/4" ELETTROSIT		
	código	101309	referencia
	extensión		

NOVASIT



1			
código	101187	referencia	0105082 MA1870800 SIR0105082
descripción	válvula de gas SIT serie Novasit 820 aliment. 0.17VHz entrada gas 1/2" salida gas 1/2" conexión termopar M9x1 conexión de piloto M10x1 presión de encendido margen de presión 5-50mbar conexión del presostato ciego núm. Ref. 0.820.301 alimentación operador Millivolt		
Para modelos:	FG82122, FG84222, FG92122, FG94222, FGY2122, FGY4222		
repuestos para	101187		
	código	101065	referencia
	grupo magnético con cable L 44mm D1 ø 30mm D2 ø 20mm apto para NOVASIT		
accesorios para	101187		
	código	100110	referencia
	piloto de encendido SIT tipo serie 190 3 llamas boquilla ømm empalme de gasmm		
	código	101305	referencia
	empalme de gas recto 1/2" brida 45x45mm ELETTROSIT/V4400/4600/4605 para SIT/HONEYWELL dist. del agujero 36x36mm		
	código	101306	referencia
	empalme de gas acodado brida 45x45mm dist. del agujero 36x36mm 1/2" ELETTROSIT/V4400/4600/4605 atornillado con junta tórica para SIT/HONEYWELL		
	código	101307	referencia
	empalme de gas recto brida 45x45mm dist. del agujero 36x36mm 3/4" ELETTROSIT/V4400/4600/4605 atornillado con junta tórica para SIT/HONEYWELL		
	código	101308	referencia
	empalme de gas acodado brida 45x45mm dist. del agujero 36x36mm 3/4" ELETTROSIT/V4400/4600/4605 atornillado con junta tórica para SIT/HONEYWELL		
	código	102116	referencia 0105109 SIR0105109
	termogenerador ROBERTSHAW L 900mm sonda ø 9mm sonda L 57mm 250-750mV unión roscada 7/16"		





código	101162	referencia	0109010 MA2863300 SIR0109010
descripción	válvula de gas SIT serie Novasit 820 aliment. 230V 50Hz entrada gas 1/2" salida gas 1/2" conexión termopar M9x1 conexión de piloto M10x1 presión de encendido 3-5mbar margen de presión 3-30mbar conexión del presostato ciego núm. Ref. 0.820.010		
Para modelos:	CFG60110, CFG60210		
repuestos para	101162		
	código	101065	referencia —
	grupo magnético con cable L 44mm D1 ø 30mm D2 ø 20mm apto para NOVASIT		
	código	101313	referencia —
	bobina magnética 230V 50Hz		
accesorios para	101162		
	código	100006	referencia —
	encendedor piezoeléctrico apto para ELETTROSIT cuerpo plástico soplado empalme ø2,4mm ø 14mm		
	código	101305	referencia —
	empalme de gas recto 1/2" brida 45x45mm ELETTROSIT/V4400/4600/4605 para SIT/HONEYWELL dist. del agujero 36x36mm		
	código	101306	referencia —
	empalme de gas acodado brida 45x45mm dist. del agujero 36x36mm 1/2" ELETTROSIT/V4400/4600/4605 atornillado con junta tórica para SIT/HONEYWELL		
	código	101307	referencia —
	empalme de gas recto brida 45x45mm dist. del agujero 36x36mm 3/4" ELETTROSIT/V4400/4600/4605 atornillado con junta tórica para SIT/HONEYWELL		
	código	101308	referencia —
	empalme de gas acodado brida 45x45mm dist. del agujero 36x36mm 3/4" ELETTROSIT/V4400/4600/4605 atornillado con junta tórica para SIT/HONEYWELL		
	código	101312	referencia 0109011 CR0507660 LAR63060010 R63060010 SIR0109011
	microinterruptor		
	código	101314	referencia —
	bobina magnética 24V 50Hz		
	código	101317	referencia 1874000 1880600 MA1874000 MA1880600
	conector con cable L 1000mm apto para NOVASIT		
	código	101318	referencia —
	tapa para solenoide apto para NOVASIT		



código	101908	referencia	1871200 MA1871200
descripción	válvula de gas SIT serie Novasit 820 aliment. 230V 50Hz entrada gas 1/2" salida gas 1/2" conexión termopar M9x1 conexión de piloto M10x1 presión de encendido 3-5mbar margen de presión 3-30mbar conexión del presostato ciego núm. Ref. 0.820.018 salida quemador de encendido M10x1 presión entrada máx. 60bar margen de ajuste 3-30bar		
Para modelos:	EDG72128, EDG73142, EDG74228, EDG92142, EDG93142, EDG94242, EFG92123K, EFG94223K, EPG7D05, EPG7I05, EPG7I08, EPG9D10, EPG9D10A, EPG9D15, EPG9D15A, EPG9I15, EPG9I15A, EPG9B9I10, EPG9B9I10A, EPGD05, ESG94CRA, ESG94CRM, ESG94FRA, ESG94FRM, ESG96CRA, ESG96FRA, SG86CRA, SG86FRA, SG86IRA, SG96CRA, SG96FRA, SG96IRA		
repuestos para	101908		
	código	101065	referencia —
	grupo magnético con cable L 44mm D1 ø 30mm D2 ø 20mm apto para NOVASIT		
	código	101313	referencia —
	bobina magnética 230V 50Hz		
accesorios para	101908		
	código	100006	referencia —
	encendedor piezoeléctrico apto para ELETTROSIT cuerpo plástico soplado empalme ø2,4mm ø 14mm		
	código	101305	referencia —
	empalme de gas recto 1/2" brida 45x45mm ELETTROSIT/V4400/4600/4605 para SIT/HONEYWELL dist. del agujero 36x36mm		
	código	101306	referencia —
	empalme de gas acodado brida 45x45mm dist. del agujero 36x36mm 1/2" ELETTROSIT/V4400/4600/4605 atornillado con junta tórica para SIT/HONEYWELL		
	código	101307	referencia —
	empalme de gas recto brida 45x45mm dist. del agujero 36x36mm 3/4" ELETTROSIT/V4400/4600/4605 atornillado con junta tórica para SIT/HONEYWELL		
	código	101308	referencia —
	empalme de gas acodado brida 45x45mm dist. del agujero 36x36mm 3/4" ELETTROSIT/V4400/4600/4605 atornillado con junta tórica para SIT/HONEYWELL		
	código	101312	referencia 0109011 CR0507660 LAR63060010 R63060010 SIR0109011
	microinterruptor		
	código	101314	referencia —
	bobina magnética 24V 50Hz		
	código	101317	referencia 1874000 1880600 MA1874000 MA1880600
	conector con cable L 1000mm apto para NOVASIT		





Continúa en la página siguiente

accesorios para	101908		
	código	101318	referencia
			—
	tapa para solenoide apto para NOVASIT		

accesorios			
			
código	101317	referencia	1874000 1880600 MA1874000 MA1880600
descripción	conector con cable L 1000mm apto para NOVASIT		
Para modelos:	EDG72128, EDG74228, EFG92123K, EFG94223K, EPG7D05, EPG7I05, EPG7I08, EPG9D10, EPG9D10A, EPG9D15, EPG9D15A, EPG9I15, EPG9I15A, EPGB9I10, EPGB9I10A, EPGD05, ESG94CRA, ESG94CRM, ESG94FRA, ESG94FRM, ESG96CRA, ESG96FRA, SG86CRA, SG86FRA, SG86IRA, SG96CRA, SG96FRA, SG96IRA		









			
código	101312	referencia	0109011 CR0507660 LAR63060010 SIR0109011
descripción	microinterruptor		
Para modelos:	CFG60110, CFG60210, EDG72128, EDG74228, EFG92123K, EFG94223K, EPG7D05, EPG7I05, EPG7I08, EPG9D10, EPG9D10A, EPG9D15, EPG9D15A, EPG9I15, EPG9I15A, EPGB9I10, EPGB9I10A, EPGD05, ESG94CRA, ESG94CRM, ESG94FRA, ESG94FRM, ESG96CRA, ESG96FRA		

TANDEM			
			
código	101684	referencia	0102481 SIR0102481
descripción	válvula de gas aliment. 230V 50Hz entrada gas 1/2" salida gas 1/2" conexión de piloto nivel encendido lento estándar tiempo de encendido 3-7s margen de presión 3-50mbar alim. para modulador tipo SIT núm. Ref. 0.830.034		
Para modelos:	CBG9060C-I, CPD90100, CPD90100A, CPD90150, CPD90150A, CPI90100, CPI90100A, CPI90150, CPI90150A		
repuestos para	101684		
	código	101379	referencia
			—
	bobina magnética aliment. 230V 50Hz apto para Tandem		

accesorios para	101684		
	código	101274	referencia
			—
	anillo cortante para tuboø 16mm UE 1 pzs		
	código	101275	referencia
			—
	tornillo de racor rosca 1/2" para tuboø 16mm UE 1 pzs		
	código	102845	referencia
			—
	empalme de gas acodado 1/2" brida 32x32mm dist. del agujero 24x24mm Tandem		
	código	102846	referencia
			—
	empalme de gas recto 1/2" brida 32x32mm dist. del agujero 24x24mm apto para Tandem		
	código	102847	referencia
			—
	junta tórica		









encendidos y tempares



pilotos de encendido

SIT			
serie 100			
			
código	106904	referencia	0100821 SIR0100821
descripción	piloto de encendido SIT tipo serie 100 1 llama boquilla ø 0.2mm empalme de gas 6mm		
repuestos para	106904		
	código	100245	referencia
			0100829 1415100 MA1415100 SIR0100829
	boquilla de quemador piloto gas licuado código 20 taladro ø 0.2mm UE 1 pzs rosca M8x0,75		
	código	100855	referencia
			—
	portapilotos triple		
	código	100885	referencia
			0101151 SIR0101151
	casquillo de mezcla de aire para quemador piloto UE 1 pzs		
	código	100916	referencia
			—
	resorte de compresión para quemador piloto UE 1 pzs		
	código	100917	referencia
			—
	junta para quemador piloto UE 1 pzs aluminio		
	código	100918	referencia
			—
	tornillo para quemador piloto		
	código	107160	referencia
			—
	parte superior de quemador piloto SIT 1 llama Hmm Lmm UE 1 pzs		
	código	107166	referencia
			—
	cabezal de quemador piloto SIT 1 llama Hmm Lmm UE 1 pzs		

Continúa en la página siguiente













repuestos para 106904				
	código	107701	referencia	—
parte inferior de quemador piloto SIT serie 100 boquilla ø 0.2mm				
accesorios para 106904				
	código	100246	referencia	—
boquilla de quemador piloto gas natural taladro ø 0.35mm UE 1 pzs rosca M8x0,75				
	código	100904	referencia	1394700 MA1394700
tornillo de apriete M10x1 para tuboø 4mm UE 1 pzs				
	código	100905	referencia	—
tornillo de apriete M10x1 para tuboø 6mm UE 1 pzs				
	código	102110	referencia	—
tubo piloto cobre diámetro ø 4mm grosor de la pared 1mm L 3000mm				
	código	102111	referencia	—
tubo piloto cobre diámetro ø 6mm grosor de la pared 1mm L 3000mm				
	código	107171	referencia	0101153 0105143 1842300 MA1842300 SIR0101153 SIR0105143
boquilla de quemador piloto SIT gas natural/licuado taladro ø 0.25mm UE 1 pzs				
	código	107700	referencia	0101152 SIO101152 SIR0101152
parte inferior de quemador piloto SIT serie 100 boquilla ø 0.25mm				
	código	107702	referencia	—
parte inferior de quemador piloto SIT serie 100 boquilla ø 0.35mm				

 <p>1</p>				
código	106906	referencia	0100822 0100824 6A013200 BN6A013200 LAR63050020 SIR0100822 SIR0100824	
descripción	piloto de encendido SIT tipo serie 100 3 llamas boquilla ø 0.2mm empalme de gas 6mm			
Para modelos:	BG92ALC, BG92ALL, BG92ARC, BG92ARR, BG92GLC, BG92GLL, BG92GRC, BG92GRR, BG94ALC, BG94ALL, BG94ALR, BG94AMC, BG94ARC, BG94ARR, BG94GLC, BG94GLL, BG94GLR, BG94GMC, BG94GRC, BG94GRR, BG94TLC, BG94TLL, BG94TRC, BG94TRR, BG94TLR, BG94TLL, BG94TLR, BG94TMC, BG94TRC, BG94TRR, CBG7050, CBG9060CP, CBG9060C-P, CBG9060P, CCG6045, CCG7045, CCG7045P, CCG70652, CCG70652P, CCG70653, CCG7245, CCG72652, CCG72653, CFG70115, CFG70215, CFG72215, CFG90120, CFG90210, CFG90210S, CFG90220...(Otros modelos se puede ver en la tienda web)			
repuestos para 106906				
	código	100245	referencia	0100829 1415100 MA1415100 SIR0100829
boquilla de quemador piloto gas licuado código 20 taladro ø 0.2mm UE 1 pzs rosca M8x0,75				

repuestos para 106906				
	código	100855	referencia	—
portapilotos triple				
	código	100885	referencia	0101151 SIR0101151
casquillo de mezcla de aire para quemador piloto UE 1 pzs				
	código	100916	referencia	—
resorte de compresión para quemador piloto UE 1 pzs				
	código	100917	referencia	—
junta para quemador piloto UE 1 pzs aluminio				
	código	100918	referencia	—
tornillo para quemador piloto				
	código	107162	referencia	—
parte superior de quemador piloto SIT 3 llamas Hmm Lmm UE 1 pzs				
	código	107701	referencia	—
parte inferior de quemador piloto SIT serie 100 boquilla ø 0.2mm				
accesorios para 106906				
	código	100245	referencia	0100829 1415100 MA1415100 SIR0100829
boquilla de quemador piloto gas licuado código 20 taladro ø 0.2mm UE 1 pzs rosca M8x0,75				
	código	100246	referencia	—
boquilla de quemador piloto gas natural taladro ø 0.35mm UE 1 pzs rosca M8x0,75				
	código	100904	referencia	1394700 MA1394700
tornillo de apriete M10x1 para tuboø 4mm UE 1 pzs				
	código	100905	referencia	—
tornillo de apriete M10x1 para tuboø 6mm UE 1 pzs				
	código	102110	referencia	—
tubo piloto cobre diámetro ø 4mm grosor de la pared 1mm L 3000mm				
	código	102111	referencia	—
tubo piloto cobre diámetro ø 6mm grosor de la pared 1mm L 3000mm				
	código	107171	referencia	0101153 0105143 1842300 MA1842300 SIR0101153 SIR0105143
boquilla de quemador piloto SIT gas natural/licuado taladro ø 0.25mm UE 1 pzs				
	código	107700	referencia	0101152 SIO101152 SIR0101152
parte inferior de quemador piloto SIT serie 100 boquilla ø 0.25mm				
	código	107702	referencia	—
parte inferior de quemador piloto SIT serie 100 boquilla ø 0.35mm				

			
código	106907	referencia	CR0588730
descripción	piloto de encendido SIT tipo serie 100 3 llamas boquilla ø 0.35mm empalme de gas 6mm		
Para modelos:	EGVG92, EGVG94, EGVV7		
repuestos para	106907		
	código	100246	referencia —
	boquilla de quemador piloto gas natural taladro ø 0.35mm UE 1 pzs rosca M8x0,75		
	código	100855	referencia —
	portapilotos triple		
	código	100885	referencia 0101151 SIR0101151
	casquillo de mezcla de aire para quemador piloto UE 1 pzs		
	código	100916	referencia —
	resorte de compresión para quemador piloto UE 1 pzs		
	código	100917	referencia —
	junta para quemador piloto UE 1 pzs aluminio		
	código	100918	referencia —
	tornillo para quemador piloto		
	código	107162	referencia —
	parte superior de quemador piloto SIT 3 llamas Hmm Lmm UE 1 pzs		
	código	107702	referencia —
	parte inferior de quemador piloto SIT serie 100 boquilla ø 0.35mm		
accesorios para	106907		
	código	100245	referencia 0100829 1415100 MA1415100 SIR0100829
	boquilla de quemador piloto gas licuado código 20 taladro ø 0.2mm UE 1 pzs rosca M8x0,75		
	código	100904	referencia 1394700 MA1394700
	tornillo de apriete M10x1 para tubo ø 4mm UE 1 pzs		
	código	100905	referencia —
	tornillo de apriete M10x1 para tubo ø 6mm UE 1 pzs		
	código	102110	referencia —
	tubo piloto cobre diámetro ø 4mm grosor de la pared 1mm L 3000mm		
	código	102111	referencia —
	tubo piloto cobre diámetro ø 6mm grosor de la pared 1mm L 3000mm		
	código	107171	referencia 0101153 0105143 1842300 MA1842300 SIR0101153 SIR0105143
	boquilla de quemador piloto SIT gas natural/licuado taladro ø 0.25mm UE 1 pzs		

accesorios para	106907		
	código	107700	referencia 0101152 SIO101152 SIR0101152
	parte inferior de quemador piloto SIT serie 100 boquilla ø 0.25mm		
	código	107701	referencia —
	parte inferior de quemador piloto SIT serie 100 boquilla ø 0.2mm		

accesorios			
parte inferior de piloto de encendido			
			
código	107700	referencia	0101152 SIO101152 SIR0101152
descripción	parte inferior de quemador piloto SIT serie 100 boquilla ø 0.25mm		
Para modelos:	CCG1041P, CCG1042P, CCG1045P, CCG1061P, CCG1062P, CCG10652P, CCG1081P, CCG1082P, CCG1085P, CCG1085P, CCG7001P, CCG7020P, CCG7021P, CCG7022P, CCG7040P, CCG7041P, CCG7042P, CCG7045P, CCG7046P, CCG7061P, CCG7062P, CCG70652P, CCG70662P, CCG9020P, CCG9021P, CCG9022P, CCG9040P, CCG9041P, CCG9042P, CCG9045P, CCG9046P, CCG9060P, CCG9061P, CCG9062P, CCG90652P, CCG90662P, CCG9081P, CCG9082P, CCG9085P, CCG9085-P, CG72APS, CG72GPS, CG72TPS, CG74APS, CG74EPS, CG74FPS, CG74GPS, CG74TPS, CG76APS, CG76EPS, CG76FPS...(Otros modelos se puede ver en la tienda web)		
repuestos para	107700		
	código	100916	referencia —
	resorte de compresión para quemador piloto UE 1 pzs		
	código	100917	referencia —
	junta para quemador piloto UE 1 pzs aluminio		
	código	100918	referencia —
	tornillo para quemador piloto		
	código	102742	referencia —
	boquilla de quemador piloto gas licuado código 25 taladro ø 0.25mm UE 1 pzs		
accesorios para	107700		
	código	100245	referencia 0100829 1415100 MA1415100 SIR0100829
	boquilla de quemador piloto gas licuado código 20 taladro ø 0.2mm UE 1 pzs rosca M8x0,75		
	código	100246	referencia —
	boquilla de quemador piloto gas natural taladro ø 0.35mm UE 1 pzs rosca M8x0,75		
	código	100904	referencia 1394700 MA1394700
	tornillo de apriete M10x1 para tubo ø 4mm UE 1 pzs		
	código	100905	referencia —
	tornillo de apriete M10x1 para tubo ø 6mm UE 1 pzs		
	código	102110	referencia —
	tubo piloto cobre diámetro ø 4mm grosor de la pared 1mm L 3000mm		

Continúa en la página siguiente



accesorios para	107700
código	102111
referencia	—
tubo piloto cobre diámetro ø 6mm grosor de la pared 1mm L 3000mm	

boquillas piloto

			
código	100245	referencia	0100829 1415100 MA1415100 SIR0100829
descripción	boquilla de quemador piloto gas licuado código 20 taladro ø 0.2mm UE 1 pzs rosca M8x0,75		
Para modelos:	BG92ALC, BG92ALL, BG92ARC, BG92ARR, BG92GLC, BG92GLL, BG92GRC, BG92GRR, BG94ALC, BG94ALL, BG94ALR, BG94AMC, BG94ARC, BG94ARR, BG94GLC, BG94GLL, BG94GLR, BG94GMC, BG94GRC, BG94GRR, BGY2TLC, BGY2TLL, BGY2TRC, BGY2TRR, BGY4TLC, BGY4TLL, BGY4TLR, BGY4TMC, BGY4TRC, BGY4TRR, CBG7050, CBG7050C, CBG9060CP, CBG9060P, CCG1041P, CCG1042P, CCG1045P, CCG1061P, CCG1062P, CCG10652P, CCG1081P, CCG1082P, CCG1085P, CCG6045, CCG7001P, CCG7020P, CCG7021P, CCG7022P, CCG7040P, CCG7041P...(Otros modelos se puede ver en la tienda web)		

			
código	102972	referencia	0100823 1996200 CR0684580 MA1996200 SIR0100823
descripción	boquilla de quemador piloto gas natural código 40 taladro ø 0.4mm UE 1 pzs		
Para modelos:	BG92ALC, BG92ALL, BG92ARC, BG92ARR, BG92GLC, BG92GLL, BG92GRC, BG92GRR, BG94ALC, BG94ALL, BG94ALR, BG94AMC, BG94ARC, BG94ARR, BG94GLC, BG94GLL, BG94GLR, BG94GMC, BG94GRC, BG94GRR, BGY2TLC, BGY2TLL, BGY2TRC, BGY2TRR, BGY4TLC, BGY4TLL, BGY4TLR, BGY4TMC, BGY4TRC, BGY4TRR, CBG7050, CBG7050C, CBG9060CP, CBG9060P, CCG6045, CCG7045P, CCG70652P, CCG7245, CCG72652, CCG72653, CG74FPS, CG76FPS, CG84FPS, CG86FPS, CG88APS, CG88FPS, CG88GPS, CG9020-0, CG9020-1, CG9020-2...(Otros modelos se puede ver en la tienda web)		

electródos de encendido

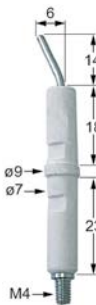
			
código	100706	referencia	0100832 224211 MA224211 SIR0100832
descripción	electrodo de encendido empalme M4 UE 1 pzs		
Para modelos:	CBG7050, CBG9060CP, CBG9060C-P, CBG9060P, CCG6045, CCG7045, CCG7045P, CCG70652, CCG70652P, CCG70653, CCG7245, CCG72652, CCG72653, CFG70115, CFG70215, CFG72215, CFG90120, CFG90210, CFG90210S, CFG90220, CG74FPS, CG76FPS, CG84FPS, CG86FPS, CG88APS, CG88FPS, CG88GPS, CNG50150, CNG50160, CNG70130, CNG70160, CNG70230, CNG72160, CNG72230, CNG90130, CNG90130-S, CNG90140, CNG90140-S, CNG90160, CNG90160S, CNG90160-S, CNG90230, CNG90240, CTT652L, CTT653L, CTT7040L, CTT7040R, CTT7041L, CTT7041R, CTT7042L...(Otros modelos se puede ver en la tienda web)		











otros

			
código	100885	referencia	0101151 SIR0101151
descripción	casquillo de mezcla de aire para quemador piloto UE 1 pzs		
Para modelos:	CCG1041P, CCG1042P, CCG1045P, CCG1061P, CCG1062P, CCG10652P, CCG1081P, CCG1082P, CCG1085P, CCG7001P, CCG7001P, CCG7020P, CCG7021P, CCG7022P, CCG7040P, CCG7041P, CCG7042P, CCG7045P, CCG7046P, CCG7061P, CCG7062P, CCG70652P, CCG70662P, CCG7201, CCG9020P, CCG9021P, CCG9022P, CCG9040P, CCG9041P, CCG9042P, CCG9045P, CCG9046P, CCG9060P, CCG9061P, CCG9062P, CCG90652P, CCG90662P, CCG9081P, CCG9082P, CCG9085P, CCG9085-P, CG72APS, CG72GPS, CG72TPS, CG74APS, CG74EPS, CG74FPS, CG74GPS, CG74TPS, CG76APS...(Otros modelos se puede ver en la tienda web)		







serie 140 - 145 -150

			
código	106943 ¹	referencia	1887700 MA1887700
descripción	piloto de encendido SIT tipo serie 140 1 llama boquilla ømm empalme de gasmm		
Para modelos:	CRG6220, CRG6240, EGL72, EGL74, FG72206, FG82206, FG92206, FGY2206, GG62TGP, GG64TGP, GL72AGC, GL72AGP, GL72GGC, GL72GGP, GL72TGC, GL72TGP, GL74AGC, GL74AGP, GL74GGC, GL74GGP, GL74TGC, GL74TGP, GL92AGM, GL92AGM-2, GL92GGM, GL94AGM, GL94AGM-2, GL94GGM, GLY2AGC, GLY2TGM, GLY4AGC, GLY4TGM		
repuestos para	106943		
	código	100907	referencia
			0100742 0100817 1891700 MA1891700 SIR0100742 SIR0100817
	unión roscada rosca M10x1 UE 1 pzs tipo SEF 1 ømm para termopar		





¹con unión roscada para termopar

			
código	107114 ¹	referencia	0109047 1031504700 CM029000 MA1031504700 MACM029000 SIR0109047
descripción	piloto de encendido SIT tipo serie 140 2 llamas boquilla ømm empalme de gasmm		
Para modelos:	BG62TLC, BG62TLL, BG62TRR, BG63TLC, BG63TLL, BG63TLR, BG64TLC, BG64TLL, BG64TLR, BG72GLC, BG72GLL, BG72GRR, BG72TLC, BG72TLL, BG72TRR, BG74GLC, BG74GLL, BG74GLR, BG74GMC, BG74GRR, BG74TLL, BG74TLR, BG74TRR, CGE6020, CGE6020R, CGG6020, CGG6020C, CGG6020R, CGG6030, CGG6030C, CGG6030R, CGG6040, CGG6040C, CGG6040R, CGG6220, CGG6220C, CGG6220R, CGG6230, CGG6230C, CGG6230LR, CGG6240, CGG6240C, CGG6240LR, CGG7020, CGG7020C, CGG7020R, CGG7021, CGG7021C, CGG7021R, CGG7040... (Otros modelos se puede ver en la tienda web)		
repuestos para	107114		
	código	100907	referencia 0100742 0100817 1891700 MA1891700 SIR0100742 SIR0100817
unión roscada rosca M10x1 UE 1 pzs tipo SEF 1 ømm para termopar			
accesorios para	107114		
	código	100204	referencia 1888000 MA1888000
boquilla de quemador piloto SIT gas licuado código 14 taladro ø 0,18/0,20mm UE 1 pzs apto para serie 140			
	código	100205	referencia 1033722000 BN822140380 MA1033722000
boquilla de quemador piloto SIT gas licuado código 19 taladro ø 0.23/0.26mm UE 1 pzs apto para SIT serie 150			
	código	100206	referencia —
boquilla de quemador piloto SIT gas natural código 36 taladro ø 0,60/0,55mm UE 1 pzs apto para SIT serie 150			
	código	100207	referencia 1887800 MA1887800
boquilla de quemador piloto SIT gas natural código 27 taladro ø 0,40/0,38mm apto para SIT serie 140			
	código	100216	referencia —
boquilla de quemador piloto SIT gas natural código 38 taladro ø 0.45mm UE 1 pzs apto para SIT serie 150			
	código	100701	referencia 0100830 0100831 0108194 1888300 1949900 MA1888300 MA1949900 SIR0100830 SIR0100831 SIR0108194
electrodo de encendido empalme M4 UE 1 pzs			
	código	100801	referencia —
junta para quemador piloto UE 1 pzs			
	código	100897	referencia 1888100 MA1888100
anillo cortante para tuboø 4mm UE 1 pzs para quemador piloto			

¹con unión roscada para termopar

accesorios para	107114		
	código	100898	referencia —
anillo cortante para tuboø 6mm UE 1 pzs para quemador piloto			
	código	100906	referencia 0100807 1888400 MA1888400 SIR0100807
unión roscada rosca M10x1 para electrodo de encendido latón UE 1 pzs EC 10			
	código	100908	referencia 0100777 673500 MA673500 SIR0100777
tornillo de racor rosca M10x1 para tuboø 4mm UE 1 pzs			
	código	100909	referencia 0100744 SIR0100744
tornillo de racor rosca M10x1 para tuboø 6mm UE 1 pzs			
	código	102110	referencia —
tubo piloto cobre diámetro ø 4mm grosor de la pared 1mm L 3000mm			
	código	102111	referencia —
tubo piloto cobre diámetro ø 6mm grosor de la pared 1mm L 3000mm			



serie 160













			
código	100109	referencia	CM040800 MACM040800
descripción	piloto de encendido SIT tipo serie 160 1 llama boquilla ømm empalme de gasmm		
Para modelos:	DG72128, DG74228, DG82140, DG82142, DG82T42, DG84240, DG84242, DG84T42, DG92142, DG94242, DGY2142, DGY4242, ECG7-FG, ECG94F, ECG96F, ECG96H, ECG98F, EC-MAXI-OVEN-GAS, EDG72128, EDG74228, EDG92142, EDG93142, EDG94242, EFG72108, EFG72110, EFG72115, EFG73208T, EFG73210, EFG74215, EFG92115, EFG92115S, EFG92123, EFG92123K, EFG93210, EFG94215, EFG94215S, EFG94223, EFG94223K, EPG7D05, EPG7I05, EPG7I08, EPG9D10, EPG9D10A, EPG9D15, EPG9D15A, EPG9I15, EPG9I15A, EPG9I10, EPG9I10A, EPGD05...(Otros modelos se puede ver en la tienda web)		
repuestos para	100109		
	código	100907	referencia 0100742 0100817 1891700 MA1891700 SIR0100742 SIR0100817
unión roscada rosca M10x1 UE 1 pzs tipo SEF 1 ømm para termopar			
accesorios para	100109		
	código	100202	referencia —
boquilla de quemador piloto gas natural código 41 UE 1 pzs boquilla ø 0.41mm			
	código	100203	referencia —
boquilla de quemador piloto gas licuado código 25 UE 1 pzs boquilla ø 0.25mm			













Continúa en la página siguiente





accesorios para 100109				0100830 0100831 0108194 1888300 1949900 MA1888300 MA1949900 SIR0100830 SIR0100831 SIR0108194
	código	100701	referencia	
electrodo de encendido empalme M4 UE 1 pzs				
	código	100801	referencia	—
junta para quemador piloto UE 1 pzs				
	código	100869	referencia	—
boquilla de quemador piloto gas natural código 51 UE 1 pzs apto para serie 160 boquilla ø 0.51mm				
	código	100906	referencia	0100807 1888400 MA1888400 SIR0100807
unión roscada rosca M10x1 para electrodo de encendido latón UE 1 pzs EC 10				
	código	100908	referencia	0100777 673500 MA673500 SIR0100777
tornillo de racor rosca M10x1 para tuboø 4mm UE 1 pzs				
	código	100909	referencia	0100744 SIR0100744
tornillo de racor rosca M10x1 para tuboø 6mm UE 1 pzs				
	código	101282	referencia	—
anillo cortante para tuboø 4mm L 7.4mm UE 1 pzs				
	código	101287	referencia	—
anillo cortante para tuboø 6mm UE 1 pzs				
	código	102110	referencia	—
tubo piloto cobre diámetro ø 4mm grosor de la pared 1mm L 3000mm				
	código	102111	referencia	—
tubo piloto cobre diámetro ø 6mm grosor de la pared 1mm L 3000mm				
	código	107650	referencia	0100802 CR0410100 SIR0100802
boquilla de quemador piloto SIT gas licuado código 30 UE 1 pzs				

 <p>1</p>				
código	100053	referencia		0100800 0100825 SIO100800 SIR0100800 SIR0100825
descripción	piloto de encendido SIT tipo serie 160 2 llamas boquilla ømm empalme de gasmm			
repuestos para	100053			
	código	100907	referencia	0100742 0100817 1891700 MA1891700 SIR0100742 SIR0100817
unión roscada rosca M10x1 UE 1 pzs tipo SEF 1 ømm para termopar				









accesorios para 100053				
	código	100202	referencia	—
boquilla de quemador piloto gas natural código 41 UE 1 pzs boquilla ø 0.41mm				
	código	100203	referencia	—
boquilla de quemador piloto gas licuado código 25 UE 1 pzs boquilla ø 0.25mm				
	código	100701	referencia	0100830 0100831 0108194 1888300 1949900 MA1888300 MA1949900 SIR0100830 SIR0100831 SIR0108194
electrodo de encendido empalme M4 UE 1 pzs				
	código	100801	referencia	—
junta para quemador piloto UE 1 pzs				
	código	100869	referencia	—
boquilla de quemador piloto gas natural código 51 UE 1 pzs apto para serie 160 boquilla ø 0.51mm				
	código	100906	referencia	0100807 1888400 MA1888400 SIR0100807
unión roscada rosca M10x1 para electrodo de encendido latón UE 1 pzs EC 10				
	código	100908	referencia	0100777 673500 MA673500 SIR0100777
tornillo de racor rosca M10x1 para tuboø 4mm UE 1 pzs				
	código	100909	referencia	0100744 SIR0100744
tornillo de racor rosca M10x1 para tuboø 6mm UE 1 pzs				
	código	101282	referencia	—
anillo cortante para tuboø 4mm L 7.4mm UE 1 pzs				
	código	101287	referencia	—
anillo cortante para tuboø 6mm UE 1 pzs				
	código	102110	referencia	—
tubo piloto cobre diámetro ø 4mm grosor de la pared 1mm L 3000mm				
	código	102111	referencia	—
tubo piloto cobre diámetro ø 6mm grosor de la pared 1mm L 3000mm				
	código	107650	referencia	0100802 CR0410100 SIR0100802
boquilla de quemador piloto SIT gas licuado código 30 UE 1 pzs				

			
código	100054	referencia	0100799 0100826 SIR0100799 SIR0100826
descripción	piloto de encendido SIT tipo serie 160 2 llamas boquilla ømm empalme de gasmm		
repuestos para	100054		
	código	100907	referencia 0100742 0100817 1891700 MA1891700 SIR0100742 SIR0100817
unión roscada rosca M10x1 UE 1 pzs tipo SEF 1 ømm para termopar			
accesorios para	100054		
	código	100202	referencia —
boquilla de quemador piloto gas natural código 41 UE 1 pzs boquilla ø 0.41mm			
	código	100203	referencia —
boquilla de quemador piloto gas licuado código 25 UE 1 pzs boquilla ø 0.25mm			
	código	100701	referencia 0100830 0100831 0108194 1888300 1949900 MA1888300 MA1949900 SIR0100830 SIR0100831 SIR0108194
electrodo de encendido empalme M4 UE 1 pzs			
	código	100801	referencia —
junta para quemador piloto UE 1 pzs			
	código	100869	referencia —
boquilla de quemador piloto gas natural código 51 UE 1 pzs apto para serie 160 boquilla ø 0.51mm			
	código	100906	referencia 0100807 1888400 MA1888400 SIR0100807
unión roscada rosca M10x1 para electrodo de encendido latón UE 1 pzs EC 10			
	código	100908	referencia 0100777 673500 MA673500 SIR0100777
tornillo de racor rosca M10x1 para tubo ø 4mm UE 1 pzs			
	código	100909	referencia 0100744 SIR0100744
tornillo de racor rosca M10x1 para tubo ø 6mm UE 1 pzs			
	código	101282	referencia —
anillo cortante para tubo ø 4mm L 7.4mm UE 1 pzs			
	código	101287	referencia —
anillo cortante para tubo ø 6mm UE 1 pzs			
	código	102110	referencia —
tubo piloto cobre diámetro ø 4mm grosor de la pared 1mm L 3000mm			

accesorios para	100054		
	código	102111	referencia —
tubo piloto cobre diámetro ø 6mm grosor de la pared 1mm L 3000mm			
	código	107650	referencia 0100802 CR0410100 SIR0100802
boquilla de quemador piloto SIT gas licuado código 30 UE 1 pzs			













POLIDORO











pilotos de encendido

			
código	100051	referencia	0108109 SIR0108109
descripción	piloto de encendido POLIDORO 3 llamas código empalme de gasmm		
Para modelos:	CRG7022, CRG7042, CRG7222, CRG7242, CRG9022, CRG9022S, CRG9042, CRG9042S, GL92AGC, GL94AGC, GLY2AGC, GLY4AGC		
repuestos para	100051		
	código	100907	referencia 0100742 0100817 1891700 MA1891700 SIR0100742 SIR0100817
unión roscada rosca M10x1 UE 1 pzs tipo SEF 1 ømm para termopar			
accesorios para	100051		
	código	100000	referencia —
boquilla de quemador piloto POLIDORO gas licuado código 22 taladro ø 0.22mm UE 1 pzs			
	código	100208	referencia —
boquilla de quemador piloto POLIDORO gas licuado código 20 taladro ø 0.2mm UE 1 pzs			
	código	100209	referencia 0101048 SIO101048 SIR0101048
boquilla de quemador piloto POLIDORO gas natural código 40 taladro ø 0.4mm UE 1 pzs			
	código	100701	referencia 0100830 0100831 0108194 1888300 1949900 MA1888300 MA1949900 SIR0100830 SIR0100831 SIR0108194
electrodo de encendido empalme M4 UE 1 pzs			
	código	100906	referencia 0100807 1888400 MA1888400 SIR0100807
unión roscada rosca M10x1 para electrodo de encendido latón UE 1 pzs EC 10			
	código	100907	referencia 0100742 0100817 1891700 MA1891700 SIR0100742 SIR0100817
unión roscada rosca M10x1 UE 1 pzs tipo SEF 1 ømm para termopar			

Continúa en la página siguiente



accesorios para 100051			
	código	100908	referencia 0100777 673500 MA673500 SIR0100777
tornillo de racor rosca M10x1 para tuboø 4mm UE 1 pzs			
	código	100909	referencia 0100744 SIR0100744
tornillo de racor rosca M10x1 para tuboø 6mm UE 1 pzs			
	código	102110	referencia —
tubo piloto cobre diámetro ø 4mm grosor de la pared 1mm L 3000mm			
	código	102111	referencia —
tubo piloto cobre diámetro ø 6mm grosor de la pared 1mm L 3000mm			
	código	102508	referencia —
tornillo de racor rosca M10x1 para tuboø 4mm UE 5 pzs			
	código	102509	referencia —
tornillo de racor rosca M10x1 para tuboø 6mm UE 5 pzs			
	código	102699	referencia —
boquilla de quemador piloto POLIDORO gas natural código 25.2 taladro ø 2x0,25mm UE 1 pzs 2 taladros			
	código	102795	referencia —
anillo cortante para tuboø 4mm UE 1 pzs			
	código	102797	referencia —
anillo cortante para tuboø 6mm UE 1 pzs			
	código	106703	referencia —
boquilla de quemador piloto POLIDORO gas natural código 27.2 taladro ø 2x0,27mm UE 1 pzs			
	código	106704	referencia —
boquilla de quemador piloto POLIDORO gas licuado código 16.2 taladro ø 2x0,16mm UE 1 pzs			
	código	106763	referencia —
boquilla de quemador piloto POLIDORO gas natural código 27.2A taladro ø 2x 0,27mm UE 1 pzs			
	código	106859	referencia —
boquilla de quemador piloto POLIDORO gas licuado código 24 taladro ø 0.24mm UE 1 pzs			

			
código	100076	referencia	0101047 SIR0101047
descripción	piloto de encendido POLIDORO 3 llamas gas natural código 29.2 empalme de gas 6mm		
Para modelos:	CCG1045, CCG1045P, CCG10652, CCG10652P, CCG10653, CCG1085, CCG10852, CCG1085P, CCG7001, CCG7001P, CCG7201, CCG9045P, CCG9046, CCG90652P, CCG90663, CCG9085P, CCG9085-P, CCG9145, CCG9145-1, CCG91652, CCG91652-1, CCG91653, CCG91653-1, CCG9185, CCG9185-1, CCG91852, CCG91852-1, CFS9050, CFS9052, CFS9055, CG76HPS, CG86HPS, CG94FPS, CG96FPS, CG98FPS, CGG9020, CGG9020C, CGG9020R, CGG9020RC, CGG9021, CGG9021C, CGG9021R, CGG9021RC, CGG9040, CGG9040C, CGG9040LR, CGG9040LRC, CGG9040R, CGG9040RC, CGG9041...(Otros modelos se puede ver en la tienda web)		
repuestos para 100076			
	código	100907	referencia 0100742 0100817 1891700 MA1891700 SIR0100742 SIR0100817
unión roscada rosca M10x1 UE 1 pzs tipo SEF 1 ømm para termopar			
accesorios para 100076			
	código	100000	referencia —
boquilla de quemador piloto POLIDORO gas licuado código 22 taladro ø 0.22mm UE 1 pzs			
	código	100208	referencia —
boquilla de quemador piloto POLIDORO gas licuado código 20 taladro ø 0.2mm UE 1 pzs			
	código	100209	referencia 0101048 SIR0101048
boquilla de quemador piloto POLIDORO gas natural código 40 taladro ø 0.4mm UE 1 pzs			
	código	100701	referencia 0100830 0100831 0108194 1888300 1949900 MA1888300 MA1949900 SIR0100830 SIR0100831 SIR0108194
electrodo de encendido empalme M4 UE 1 pzs			
	código	100906	referencia 0100807 1888400 MA1888400 SIR0100807
unión roscada rosca M10x1 para electrodo de encendido latón UE 1 pzs EC 10			
	código	100907	referencia 0100742 0100817 1891700 MA1891700 SIR0100742 SIR0100817
unión roscada rosca M10x1 UE 1 pzs tipo SEF 1 ømm para termopar			
	código	100908	referencia 0100777 673500 MA673500 SIR0100777
tornillo de racor rosca M10x1 para tuboø 4mm UE 1 pzs			
	código	100909	referencia 0100744 SIR0100744
tornillo de racor rosca M10x1 para tuboø 6mm UE 1 pzs			

Continúa en la página siguiente



accesorios para		100076
	102110	referencia —
	tubo piloto cobre diámetro ø 4mm grosor de la pared 1mm L 3000mm	
	102111	referencia —
	tubo piloto cobre diámetro ø 6mm grosor de la pared 1mm L 3000mm	
	102508	referencia —
	tornillo de racor rosca M10x1 para tuboø 4mm UE 5 pzs	
	102509	referencia —
	tornillo de racor rosca M10x1 para tuboø 6mm UE 5 pzs	
	102699	referencia —
	boquilla de quemador piloto POLIDORO gas natural código 25.2 taladro ø 2x0,25mm UE 1 pzs 2 taladros	
	102795	referencia —
	anillo cortante para tuboø 4mm UE 1 pzs	
	102797	referencia —
	anillo cortante para tuboø 6mm UE 1 pzs	
	106703	referencia —
	boquilla de quemador piloto POLIDORO gas natural código 27.2 taladro ø 2x0,27mm UE 1 pzs	
	106704	referencia —
	boquilla de quemador piloto POLIDORO gas licuado código 16.2 taladro ø 2x0,16mm UE 1 pzs	
	106763	referencia —
	boquilla de quemador piloto POLIDORO gas natural código 27.2A taladro ø 2x 0,27mm UE 1 pzs	
	106859	referencia —
	boquilla de quemador piloto POLIDORO gas licuado código 24 taladro ø 0.24mm UE 1 pzs	



pilotos de encendido específicos del fabricante









SILKO

serie 650 / 700 / 809 / 909 / 1100



	107700	referencia	0101152 S10101152 SIR0101152
descripción	parte inferior de quemador piloto SIT serie 100 boquilla ø 0.25mm		
Para modelos:	CCG1041P, CCG1042P, CCG1045P, CCG1061P, CCG1062P, CCG10652P, CCG1081P, CCG1082P, CCG1085P, CCG7001P, CCG7020P, CCG7021P, CCG7022P, CCG7040P, CCG7041P, CCG7042P, CCG7045P, CCG7046P, CCG7061P, CCG7062P, CCG70652P, CCG70662P, CCG9020P, CCG9021P, CCG9022P, CCG9040P, CCG9041P, CCG9042P, CCG9045P, CCG9046P, CCG9060P, CCG9061P, CCG9062P, CCG90652P, CCG90662P, CCG9081P, CCG9082P, CCG9085P, CCG9085-P, CG72APS, CG72GPS, CG72TPS, CG74APS, CG74EPS, CG74FPS, CG74GPS, CG74TPS, CG76APS, CG76EPS, CG76FPS...(Otros modelos se puede ver en la tienda web)		
repuestos para	107700		
	100916	referencia	—
	resorte de compresión para quemador piloto UE 1 pzs		

repuestos para		107700	
	100917	referencia —	
	junta para quemador piloto UE 1 pzs aluminio		
	100918	referencia —	
	tornillo para quemador piloto		
	102742	referencia —	
	boquilla de quemador piloto gas licuado código 25 taladro ø 0.25mm UE 1 pzs		
accesorios para 107700			
	100245	referencia	0100829 1415100 MA1415100 SIR0100829
	boquilla de quemador piloto gas licuado código 20 taladro ø 0.2mm UE 1 pzs rosca M8x0,75		
	100246	referencia	—
	boquilla de quemador piloto gas natural taladro ø 0.35mm UE 1 pzs rosca M8x0,75		
	100904	referencia	1394700 MA1394700
	tornillo de apriete M10x1 para tuboø 4mm UE 1 pzs		
	100905	referencia	—
	tornillo de apriete M10x1 para tuboø 6mm UE 1 pzs		
	102110	referencia	—
	tubo piloto cobre diámetro ø 4mm grosor de la pared 1mm L 3000mm		
	102111	referencia	—
	tubo piloto cobre diámetro ø 6mm grosor de la pared 1mm L 3000mm		

			
código	100145	referencia	0109087 SIR0109087
descripción	piloto de encendido SIT tipo serie 100 3 llamas boquilla ø 0.2mm empalme de gasmm		
Para modelos:	CFG60110, CFG60210		
repuestos para	100145		
	100245	referencia	0100829 1415100 MA1415100 SIR0100829
	boquilla de quemador piloto gas licuado código 20 taladro ø 0.2mm UE 1 pzs rosca M8x0,75		
	100837	referencia	—
	parte superior de quemador piloto 3 llamas H 24mm L 48mm UE 1 pzs		
	100855	referencia	—
	portapilotos triple		
	100881	referencia	—
	parte inferior de quemador piloto PRO-GAS serie 100 boquilla ø 0.2mm		





Continúa en la página siguiente



repuestos para 100145			
	código	100885	referencia 0101151 SIR0101151
casquillo de mezcla de aire para quemador piloto UE 1 pzs			
	código	100916	referencia —
resorte de compresión para quemador piloto UE 1 pzs			
	código	100917	referencia —
junta para quemador piloto UE 1 pzs aluminio			
	código	100918	referencia —
tornillo para quemador piloto			
accesorios para 100145			
	código	100246	referencia —
boquilla de quemador piloto gas natural taladro ø 0.35mm UE 1 pzs rosca M8x0,75			
	código	100882	referencia —
parte inferior de quemador piloto PRO-GAS serie 100 boquilla ø 0.25mm			
	código	100883	referencia —
parte inferior de quemador piloto PRO-GAS serie 100 boquilla ø 0.35mm			
	código	100904	referencia 1394700 MA1394700
tornillo de apriete M10x1 para tubo ø 4mm UE 1 pzs			
	código	100905	referencia —
tornillo de apriete M10x1 para tubo ø 6mm UE 1 pzs			
	código	102110	referencia —
tubo piloto cobre diámetro ø 4mm grosor de la pared 1mm L 3000mm			
	código	102111	referencia —
tubo piloto cobre diámetro ø 6mm grosor de la pared 1mm L 3000mm			
	código	102742	referencia —
boquilla de quemador piloto gas licuado código 25 taladro ø 0.25mm UE 1 pzs			

serie 700 / 900 / NP70 / NP90

			
1			
código	103074	referencia	CR0586451
descripción	venturi para ø de tapa de quemador 102mm con piloto de encendido apto para serie 900		
Para modelos:	ECG92A, ECG92G, ECG92T, ECG94A, ECG94E, ECG94F, ECG94G, ECG94T, ECG96A, ECG96E, ECG96F, ECG96G, ECG96H, ECG96T, ECG98A, ECG98F, ECG98G		

			
1			
código	107422	referencia	CR0586441
descripción	venturi para ø de tapa de quemador 64mm con piloto de encendido apto para serie 900		
Para modelos:	ECG7, ECG92A, ECG92G, ECG92T, ECG94A, ECG94E, ECG94F, ECG94G, ECG94T, ECG96A, ECG96E, ECG96F, ECG96G, ECG96H, ECG96T, ECG98A, ECG98F, ECG98G		
accesorios para 107422			
	código	103071	referencia CR0580010
tapa de quemador ø 64mm H 26mm apto para serie 900			
	código	103072	referencia CR0580030
cabezal de quemador para ø de tapa de quemador 64mm H 37mm apto para serie 900			
	código	103075	referencia CR0581700
portabojas ø 34mm H 150mm apto para serie 900			
	código	103083	referencia 8204760 SIR8204760 SIR8204760
junta L 77mm An 69mm espesor 2mm grafito para venturi apto para serie 900			

accesorios en general

portabujas

			
1			
código	107206	referencia	9300544 SIR9300544 SIR9300544
descripción	portabujas para bujía para tipo de quemador E		
Para modelos:	CCG9020, CCG9021, CCG9022, CCG9040, CCG9041, CCG9042, CCG9046, CCG9060, CCG9061, CCG9062, CCG90663, CCG9081, CCG9082, CCG9120, CCG9121, CCG9122, CCG9140, CCG9140-1, CCG9141, CCG9141-1, CCG9142, CCG9142-1, CCG9145, CCG9145-1, CCG9146, CCG9146-1, CCG9160, CCG9160-1, CCG9161, CCG9161-1, CCG9162, CCG9162-1, CCG91652, CCG91652-1, CCG91653, CCG91653-1, CCG91662, CCG91662-1, CCG91663, CCG91663-1, CCG9181, CCG9181-1, CCG9182, CCG9182-1, CCG9185, CCG9185-1, CCG91852, CCG91852-1, CFF1GPA, CFF1GPS		



electródos



código	100728	referencia	0101221 SIR0101221
descripción	electrodo de encendido D1 ø 10mm longitud del cable 1420mm para apretar		

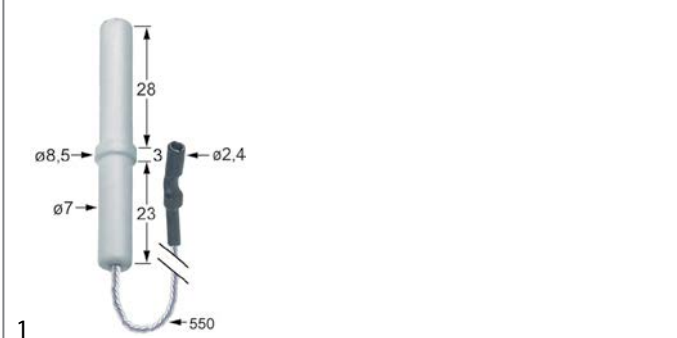

código	100745	referencia	9300542 SI9300542 SIR9300542
descripción	electrodo de encendido D1 ø 7mm D2 ø 8.5mm empalme F2,8x0,8 longitud del cable 550mm LC1 29mm LC2 3mm LC3 23mm para apretar		
Para modelos:	CCG1041, CCG1042, CCG1045, CCG1061, CCG1062, CCG10652, CCG10653, CCG1081, CCG1082, CCG1085, CCG10852, CCG7001, CCG7020, CCG7021, CCG7022, CCG7040, CCG7041, CCG7042, CCG7045, CCG7046, CCG7061, CCG7062, CCG70652, CCG70653, CCG70663, CCG7201, CCG7220, CCG7221, CCG7222, CCG7240, CCG7241, CCG7242, CCG7245, CCG7246, CCG7261, CCG7262, CCG72652, CCG72653, CCG72662, CCG72663, CCG9020, CCG9021, CCG9022, CCG9040, CCG9041, CCG9042, CCG9046, CCG9060, CCG9061, CCG9062...(Otros modelos se puede ver en la tienda web)		

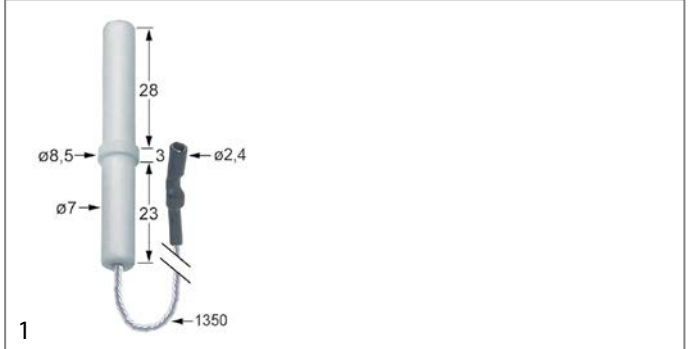

código	100747	referencia	9300540 SI9300540 SIR9300540
descripción	electrodo de encendido D1 ø 7mm D2 ø 8.5mm longitud del cable 1350mm LC1 28mm LC2 3mm LC3 23mm ø empalme 2.4mm		
Para modelos:	CCG1041, CCG1042, CCG1045, CCG1061, CCG1062, CCG10652, CCG10653, CCG1081, CCG1082, CCG1085, CCG10852, CCG7001, CCG7020, CCG7021, CCG7022, CCG7040, CCG7041, CCG7042, CCG7045, CCG7046, CCG7061, CCG7062, CCG70652, CCG70653, CCG70663, CCG7201, CCG7220, CCG7221, CCG7222, CCG7261, CCG7262, CCG72652, CCG72653, CCG72662, CCG72663, CCG9020, CCG9021, CCG9022, CCG9040, CCG9041, CCG9042, CCG9046, CCG9060, CCG9061, CCG9062, CCG90663, CCG9081, CCG9082, CCG9120, CCG9121...(Otros modelos se puede ver en la tienda web)		

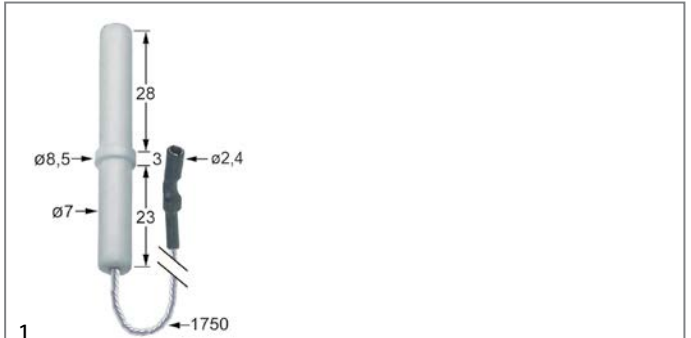

código	100732	referencia	9300539 SI9300539 SIR9300539
descripción	electrodo de encendido D1 ø 7mm D2 ø 8.5mm longitud del cable 1750mm LC1 28mm LC2 3mm LC3 23mm para apretar ø empalme 2.4mm		
Para modelos:	CCG1041, CCG1042, CCG1045, CCG1061, CCG1062, CCG10652, CCG10653, CCG1081, CCG1082, CCG1085, CCG10852, CCG9020, CCG9021, CCG9022, CCG9040, CCG9041, CCG9042, CCG9046, CCG9060, CCG9061, CCG9062, CCG90663, CCG9081, CCG9082, CCG9120, CCG9121, CCG9122, CCG9140, CCG9140-1, CCG9141, CCG9141-1, CCG9142, CCG9142-1, CCG9145, CCG9145-1, CCG9146, CCG9146-1, CCG9160, CCG9160-1, CCG9161, CCG9161-1, CCG9162, CCG9162-1, CCG91652, CCG91652-1, CCG91653, CCG91653-1, CCG91662, CCG91662-1, CCG91663...(Otros modelos se puede ver en la tienda web)		

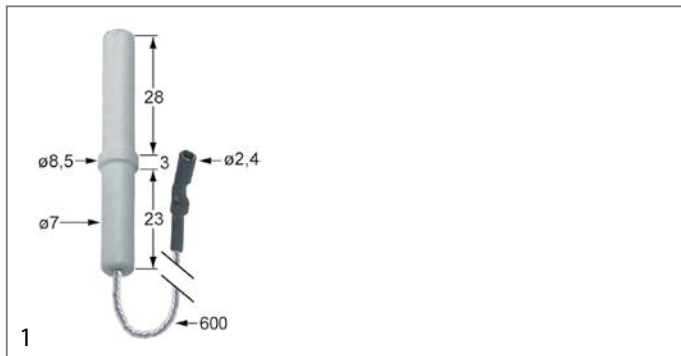

código	100733	referencia	0100834 SI0100834 SIR0100834
descripción	electrodo de encendido D1 ø 7mm D2 ø 8.5mm longitud del cable 600mm LC1 28mm LC2 3mm LC3 23mm para apretar ø empalme 2.4mm		
Para modelos:	CFF1GPA, CFF1GPS, CFF1TPA, CFF1TPS, CFF2TPA, CFF2TPS, CFF3TPA, CFF3TPS		

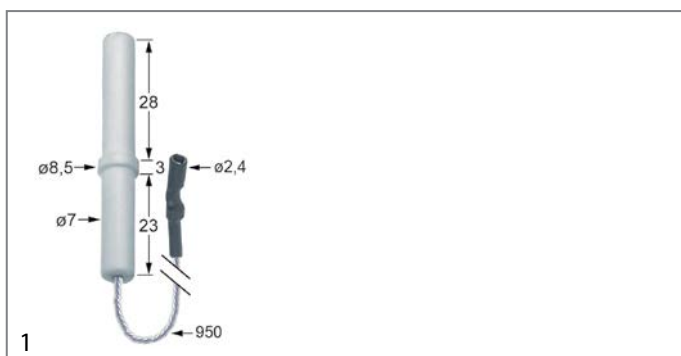

código	100746	referencia	9300541 SI9300541 SIR9300541
descripción	electrodo de encendido D1 ø 7mm D2 ø 8.5mm longitud del cable 950mm LC1 28mm LC2 3mm LC3 23mm ø empalme 2.4mm		
Para modelos:	CCG1041, CCG1042, CCG1045, CCG1061, CCG1062, CCG10652, CCG10653, CCG1081, CCG1082, CCG1085, CCG10852, CCG7001, CCG7020, CCG7021, CCG7022, CCG7040, CCG7041, CCG7042, CCG7045, CCG7046, CCG7061, CCG7062, CCG70652, CCG70653, CCG70663, CCG7201, CCG7261, CCG7262, CCG72652, CCG72653, CCG72662, CCG72663, CCG9020, CCG9021, CCG9022, CCG9040, CCG9041, CCG9042, CCG9046, CCG9060, CCG9061, CCG9062, CCG90663, CCG9081, CCG9082, CCG9120, CCG9121, CCG9122, CCG9140, CCG9140-1...(Otros modelos se puede ver en la tienda web)		



código	100709	referencia	0100369 BN6A001457 SI0100369 SIR0100369
descripción	electrodo de encendido D1 ø 7mm D2 ø 9mm empalme M4 L1 13mm L2 13mm L3 23mm LC1 18mm LC2 3mm LC3 23mm para apretar		
Para modelos:	BG92ALC, BG92ALL, BG92ARC, BG92ARR, BG92GLC, BG92GLL, BG92GRC, BG92GRR, BG94ALC, BG94ALL, BG94ALR, BG94AMC, BG94ARC, BG94ARR, BG94GLC, BG94GLL, BG94GLR, BG94GMC, BG94GRC, BG94GRR, BGY2TLC, BGY2TLL, BGY2TRC, BGY2TRR, BGY4TLC, BGY4TLL, BGY4TLR, BGY4TMC, BGY4TRC, BGY4TRR, CCG9020-0, CCG9020-1, CCG9020-2, CCG9020-3, CCG9021-0, CCG9021-1, CCG9021-2, CCG9021-3, CCG9022-0, CCG9022-1, CCG9022-2, CCG9022-3, CCG9040-0, CCG9040-1, CCG9040-2, CCG9040-3, CCG9040-4, CCG9040-5, CCG9041-0, CCG9041-1...(Otros modelos se puede ver en la tienda web)		

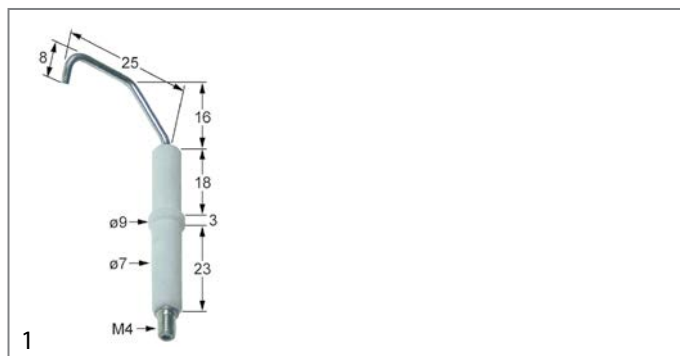

código	100822	referencia	0109027 SIR0109027
descripción	electrodo de encendido D1 ø 7mm D2 ø 9mm empalme M4 L1 16mm L2 25mm L3 8mm LC1 18mm LC2 3mm LC3 23mm para apretar		
Para modelos:	CFG60110, CFG60210		

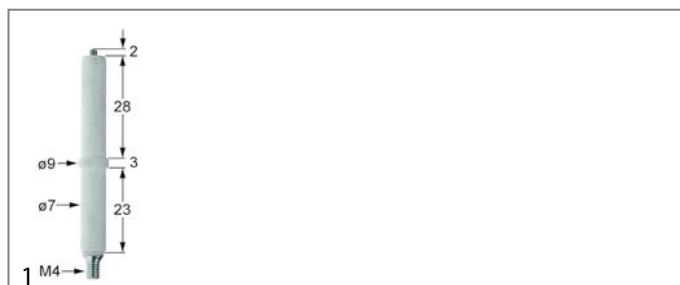

código	102314	referencia	CR0687080
descripción	electrodo de encendido D1 ø 7mm D2 ø 9mm empalme M4 L1 2mm LC1 28mm LC2 3mm LC3 23mm para apretar		
Para modelos:	ECG7, ECG92A, ECG92G, ECG92T, ECG94A, ECG94E, ECG94F, ECG94G, ECG94T, ECG96A, ECG96E, ECG96F, ECG96G, ECG96H, ECG96T, ECG98A, ECG98F, ECG98G		

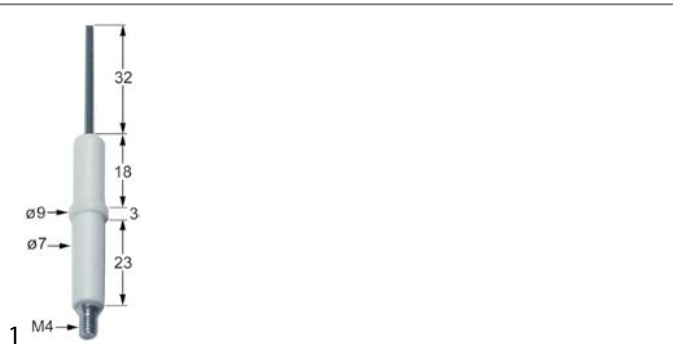

código	100701	referencia	0100830 0100831 0108194 1888300 1949900 MA1888300 MA1949900 SIR0100830 SIR0100831 SIR0108194
---------------	--------	-------------------	---

descripción electrodo de encendido empalme M4 UE 1 pzs

Para modelos: BG62TLC, BG62TLL, BG62TRR, BG63TLC, BG63TLL, BG63TLR, BG64TLC, BG64TLL, BG64TLR, BG72GLC, BG72GLL, BG72GRR, BG72TLC, BG72TLL, BG72TRR, BG74GLC, BG74GLL, BG74GLR, BG74GMC, BG74GRR, BG74TLL, BG74TLR, BG74TRR, BG82ALL, BG82ARR, BG82GLC, BG82GLL, BG82GRR, BG82TLC, BG82TLL, BG82TRR, BG84ALC, BG84ALL, BG84ALR, BG84AMC, BG84ARR, BG84GLC, BG84GLL, BG84GLR, BG84GMC, BG84GRR, BG84TLC, BG84TLL, BG84TLR, BG84TMC, BG84TRR, CCG1045, CCG10652, CCG10653, CCG1085...(Otros modelos se puede ver en la tienda web)

accesorios para 100701

	código	100906	referencia	0100807 1888400 MA1888400 SIR0100807
---	---------------	--------	-------------------	---

unión roscada rosca M10x1 para electrodo de encendido latón UE 1 pzs EC 10

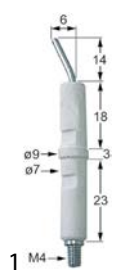

código	100706	referencia	0100832 224211 MA224211 SIR0100832
---------------	--------	-------------------	---

descripción electrodo de encendido empalme M4 UE 1 pzs

Para modelos: CBG7050, CBG9060CP, CBG9060C-P, CBG9060P, CCG6045, CCG7045, CCG7045P, CCG70652, CCG70652P, CCG70653, CCG7245, CCG72652, CCG72653, CFG70115, CFG70215, CFG72215, CFG90120, CFG90210, CFG90210S, CFG90220, CG74FPPS, CG76FPPS, CG84FPPS, CG86FPPS, CG88APS, CG88FPPS, CG88GPS, CNG50150, CNG50160, CNG70130, CNG70160, CNG70230, CNG72160, CNG72230, CNG90130, CNG90130-S, CNG90140, CNG90140-S, CNG90160, CNG90160S, CNG90160-S, CNG90230, CNG90240, CTT652L, CTT653L, CTT7040L, CTT7040R, CTT7041L, CTT7041R, CTT7042L...(Otros modelos se puede ver en la tienda web)

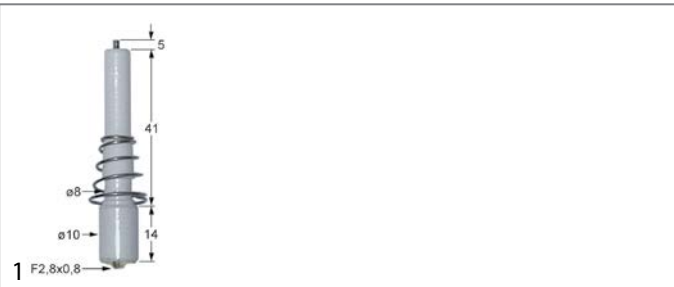

código	100729	referencia	0100833 SIR0100833
descripción	electrodo de encendido L1 5mm D1 ø 8mm D2 ø 10mm LC1 41mm LC2 14mm empalme F 2,8x0,8mm para apretar con muelle		
Para modelos:	CCG6020, CCG6040, CCG6045, CCG6046		

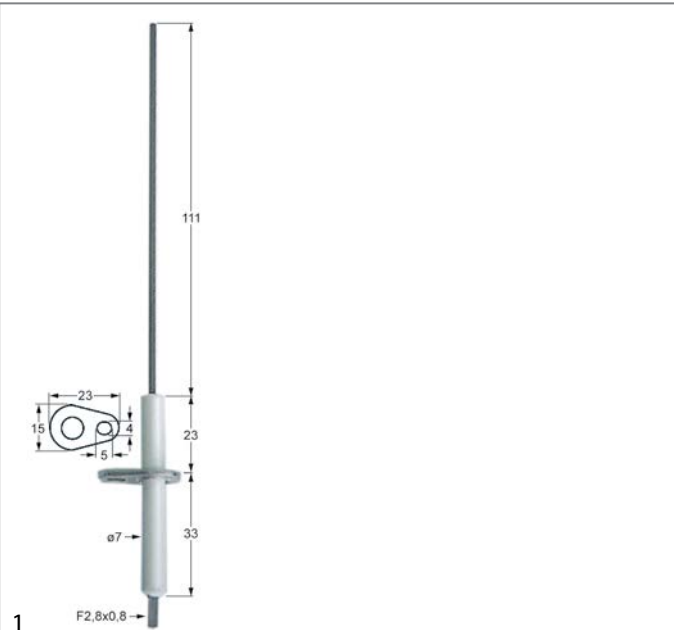

código	400172	referencia	0102479 63050060 LA63050060 LAR63050060 SIR0102479
---------------	--------	-------------------	--

descripción electrodo de encendido longitud brida 23mm anchura brida 15mm D1 ø 7mm L1 111mm LC1 23mm LC2 33mm empalme F2,8x0,8 con brida

Para modelos: CBG9060C-I, CPD90100, CPD90100A, CPD90150, CPD90150A, CPI90100, CPI90100A, CPI90150, CPI90150A





			
código	101454	referencia	0100620 0100741 SI0100620 SIR0100620 SIR0100741
descripción	tornillo de racor para bujía rosca M10x1 int.ø 7mm L 15mm		
Para modelos:	CCG1041, CCG1042, CCG1045, CCG1045P, CCG1061, CCG1062, CCG10652, CCG10652P, CCG10653, CCG1081, CCG1082, CCG1085, CCG10852, CCG1085P, CCG7001, CCG7001P, CCG7020, CCG7021, CCG7022, CCG7040, CCG7041, CCG7042, CCG7045, CCG7046, CCG7061, CCG7062, CCG70652, CCG70653, CCG70663, CCG7201, CCG7220, CCG7221, CCG7222, CCG7240, CCG7241, CCG7242, CCG7245, CCG7246, CCG7261, CCG7262, CCG72652, CCG72653, CCG72662, CCG72663, CCG9020, CCG9021, CCG9022, CCG9040, CCG9041, CCG9042...(Otros modelos se puede ver en la tienda web)		

			
código	100906	referencia	0100807 1888400 MA1888400 SIR0100807
descripción	unión roscada rosca M10x1 para electrodo de encendido latón UE 1 pzs EC 10		
Para modelos:	BG62TLC, BG62TLL, BG62TRR, BG63TLC, BG63TLL, BG63TLR, BG64TLC, BG64TLL, BG64TLR, BG72GLC, BG72GLL, BG72GRR, BG72TLC, BG72TLL, BG72TRR, BG74GLC, BG74GLL, BG74GLR, BG74GMC, BG74GRR, BG74TLC, BG74TLL, BG74TLR, BG74TMC, BG74TRR, BG82ALL, BG82ARR, BG82GLC, BG82GLL, BG82GRR, BG82TLC, BG82TLL, BG82TRR, BG84ALC, BG84ALL, BG84ALR, BG84AMC, BG84ARR, BG84GLC, BG84GLL, BG84GLR, BG84GMC, BG84GRR, BG84TLC, BG84TLL, BG84TLR, BG84TMC, BG84TRR, CG86HPS, CGG6220...(Otros modelos se puede ver en la tienda web)		

			
código	100176	referencia	0101628 SIR0101628
descripción	cable de encendido longitud del cable 1000mm empalme ø2,4mm / ø4mm temperatura constante 200°C		
Para modelos:	CNG90160, CNG90160S, CNG90160-S, CPD70150, CPI70150, DG94160, DGY4160, PG7ND05, PG7NI05, PG8AD10, PG8AD15, PG8AI10, PG8AI15, PG8ND10, PG8ND15, PG8NI10, PG8NI15, SG74CRM, SG74IRM, SG84CRA, SG84CRM, SG84IRA, SG84IRM		

			
código	100026	referencia	0100858 BN2532997 SIR0100858
descripción	cable de encendido longitud del cable 1000mm empalme ø4mm / F6,3mm		
Para modelos:	CFG70115, CFG70215, CFG72215, CFG90120, CFG90210, CFG90210S, CFG90220, FG92210, FGY2210		

			
código	102158	referencia	0101632 SIR0101632
descripción	cable de encendido longitud del cable 1750mm empalme ø4mm / F2,8mm		
Para modelos:	CCG6045, CCG7001, CCG7001P, CCG7045, CCG7045P, CCG70652, CCG70652P, CCG70653, CCG7201, CCG7245, CCG72652, CCG72653, CFG60110, CFG60210, CG74FPS, CG76FPS, CG76HPS, CTT7045, CTT7045L, CTT7045R, CTT70652, CTT70652L, CTT72653, CTT72653L, TG74FPL, TG74FPR, TG74FPS, TG76FPC, TG76FPS		

			
código	100197	referencia	0101681 BN8220191 SIR0101681
descripción	cable de encendido longitud del cable 600mm empalme F2,8mm / ø2,4mm		
Para modelos:	CCG6020, CCG6040, CCG6045, CCG6046		

			
código	100186	referencia	1936300 MA1936300
descripción	cable de encendido longitud del cable 600mm empalme ø2,4mm / ojal M4		
Para modelos:	BG62TLC, BG62TLL, BG62TRR, BG63TLC, BG63TLL, BG63TLR, BG64TLC, BG64TLL, BG64TLR, BMG-40, BMG-60, CFG62110, CFG62210, CGG6220, CGG6220C, CGG6220R, CGG6230, CGG6230C, CGG6230LR, CGG6240, CGG6240C, CGG6240LR, CRG6220, CRG6240, EBG7, EBG7-CROMO, EBG92AL, EBG92ALC, EBG92AR, EBG92ARC, EBG92GL, EBG92GLC, EBG92GR, EBG92GRC, EBG92TL, EBG92TLC, EBG92TR, EBG92TRC, EBG93AL, EBG93ALC, EBG93ALR, EBG93AMC, EBG93GL, EBG93GLC, EBG93GLR, EBG93GMC, EBG93TL, EBG93TLC, EBG93TLR, EBG93TMC...(Otros modelos se puede ver en la tienda web)		

			
código	100199	referencia	0101631 SIR0101631
descripción	cable de encendido longitud del cable 600mm empalme ø4mm / F2,8mm		

cables de encendido

cables prefabricados

			
código	102164	referencia	9303415 SIR9303415
descripción	cable de encendido longitud del cable 1000mm empalme F6,3mm / ojal M4		
Para modelos:	CPD90100AP, CPD90100A-P, CPD90100P, CPD90150AP, CPD90150A-P, CPD90150-P, CPI90100AP, CPI90100A-P, CPI90100P, CPI90150AP, CPI90150A-P, CPI90150-P, PG8AD10, PG8AD15, PG8AI10, PG8AI15, PG8NI10, PG8NI15, PG9AD10, PG9AD15, PG9AI10, PG9AI15, PG9ND10, PG9ND15, PG9NI10, PG9NI15		

			
código	100019	referencia	0108189 0109082 1936400 9303461 BN4185326050610 CR0688770 MA1936400 SIR0109082 SIR9303461
descripción	cable de encendido longitud del cable 900mm empalme ø2,4mm / ø4mm		
Para modelos:	BG72GLC, BG72GLL, BG72GRR, BG72TLC, BG72TLL, BG72TRR, BG74GLC, BG74GLL, BG74GLR, BG74GMC, BG74GRR, BG74TLL, BG74TLR, BG74TRR, BG82ALL, BG82ARR, BG82GLC, BG82GLL, BG82GRR, BG82TLC, BG82TLL, BG82TRR, BG84ALC, BG84ALL, BG84ALR, BG84AMC, BG84ARR, BG84GLC, BG84GLL, BG84GLR, BG84GMC, BG84GRR, BG84TLC, BG84TLL, BG84TLR, BG84TMC, BG84TRR, BG92ALC, BG92ALL, BG92ARC, BG92ARR, BG92GLC, BG92GLL, BG92GRC, BG92GRR, BG94ALC, BG94ALL, BG94ALR, BG94AMC, BG94ARC...(Otros modelos se puede ver en la tienda web)		

			
código	102155	referencia	0101629 9303074 SI9303074 SIR0101629 SIR9303074
descripción	cable de encendido longitud del cable 900mm empalme ø4mm / F2,8mm		
Para modelos:	CCG9046, CCG90663, CCG9145, CCG9145-1, CCG91652, CCG91652-1, CCG91653, CCG91653-1, CCG9185, CCG9185-1, CCG91852, CCG91852-1, CFS9050, CFS9052, CFS9055, CCG9020, CCG9020C, CG9020R, CCG9020RC, CCG9021, CCG9021C, CCG9021R, CCG9021RC, CCG9040, CCG9040C, CCG9040LR, CCG9040LRC, CCG9040R, CCG9040RC, CCG9041, CCG9041C, CCG9041LR, CCG9041LRC, CCG9041R, CCG9041RC, CNG50150, CNG50160, CTT1041, CTT1042, CTT1045, CTT652L, CTT653L, CTT7040, CTT7040L, CTT7040R, CTT7041, CTT7041L, CTT7041R, CTT7042, CTT7042L...(Otros modelos se puede ver en la tienda web)		

encendedores piezoeléctricos

diámetro de montaje 18mm

			
código	100003	referencia	0100898 1936100 MA1936100 SIR0100898
descripción	encendedor piezoeléctrico cuerpo metal soplado montaje ø 18mm empalme F2,8x0,8		
Para modelos:	BG62TLC, BG62TLL, BG62TRR, BG63TLC, BG63TLL, BG63TLR, BG64TLC, BG64TLL, BG64TLR, BG72ALL, BG72ARR, BG72GLL, BG72GRR, BG72TLL, BG72TRR, BG74ALL, BG74ALR, BG74ARC, BG74GLL, BG74GLR, BG74GRR, BG74TLL, BG74TLR, BG74TRR, BMG-40, BMG-60, CCG6245-1, CCG62652-1, CFG62110, CFG62210, CG64FPS, CG66FPS, CCG6220, CCG6220C, CCG6220R, CCG6230, CCG6230C, CCG6230LR, CCG6240, CCG6240C, CCG6240LR, CRG6220, CRG6240, DG72128, DG74228, DG82140, DG82142, DG82T42, DG84240, DG84242...(Otros modelos se puede ver en la tienda web)		

			
código	100009	referencia	0100895 BN6A041105 SIR0100895
descripción	encendedor piezoeléctrico cuerpo plástico soplado montaje ø 18mm empalme ø2,4mm dimensiones frontales 26mm M18x1,5		
Para modelos:	BG72GLC, BG72GLL, BG72GRR, BG72TLC, BG72TLL, BG72TRR, BG74GLC, BG74GLL, BG74GLR, BG74GMC, BG74GRR, BG74TLL, BG74TLR, BG74TRR, BG82ALL, BG82ARR, BG82GLC, BG82GLL, BG82GRR, BG82TLC, BG82TLL, BG82TRR, BG84ALC, BG84ALL, BG84ALR, BG84AMC, BG84ARR, BG84GLC, BG84GLL, BG84GLR, BG84GMC, BG84GRR, BG84TLC, BG84TLL, BG84TLR, BG84TMC, BG84TRR, CBG7050, CBG7050C, CCG6020, CCG6040, CCG6045, CCG6046, CFF1GPA, CFF1GPS, CFF1TPA, CFF1TPS, CFF2TPA, CFF2TPS, CFF3TPA...(Otros modelos se puede ver en la tienda web)		
accesorios para	100009		
	código	101339	referencia —
	 tapa para piezoencendedor		
	código	106869	referencia 0108555 CM136000 MACM136000 SIR0108555
	 tapa para piezoencendedor int.ø 22mm ø ext. 35mm H 25mm		
	código	107931	referencia —
	 tapa para piezoencendedor int.ø 21mm ø ext. 36mm		

diámetro de montaje 22mm

			
código	100008	referencia	0100893 SI0100893 SIR0100893
descripción	encendedor piezoeléctrico cuerpo plástico soplado montaje ø 22mm empalme ø2mm longitud del cable mm		
Para modelos:	BG92ALC, BG92ALL, BG92ARC, BG92ARR, BG92GLC, BG92GLL, BG92GRC, BG92GRR, BG94ALC, BG94ALL, BG94ALR, BG94AMC, BG94ARC, BG94ARR, BG94GLC, BG94GLL, BG94GLR, BG94GMC, BG94GRC, BG94GRR, BGY2TLC, BGY2TLL, BGY2TRC, BGY2TRR, BGY4TLC, BGY4TLL, BGY4TLR, BGY4TMC, BGY4TRC, BGY4TRR, CBG9060CP, CBG9060C-P, CBG9060P, CCG1045P, CCG10652P, CCG1085P, CCG9045P, CCG90652P, CCG9085P, CCG9085-P, CG84FPS, CG86FPS, CG86HPS, CG88APS, CG88FPS, CG88GPS, CG94FPS, CG96FPS, CG98FPS, CCG9020-0...(Otros modelos se puede ver en la tienda web)		





otros			
			
1			
código	fdp ¹	referencia	0100857 SI0100857 SIR0100857
descripción	encendedor piezoeléctrico apto para Minisit con tapa ømm empalme F6,3x0,8		
Para modelos:	CFG70115, CFG70215, CFG72215, CFG90120, CFG90210, CFG90210S, CFG90220, FG92210, FGY2210		
repuestos para	101136		
			
código	100001	referencia	0102509 SIR0102509
encendedor piezoeléctrico apto para Minisit empalme F6,3x0,8 ømm			

¹fuera de producción

			
1			
código	fdp ¹	referencia	0102509 SIR0102509
descripción	encendedor piezoeléctrico apto para Minisit empalme F6,3x0,8 ømm		
Para modelos:	CPD90100AP, CPD90100A-P, CPD90100P, CPD90150AP, CPD90150A-P, CPD9015-P, CPI90100AP, CPI90100A-P, CPI90100P, CPI90100-P, CPI90150AP, CPI90150A-P, CPI90150P, CPI90150-P, PG9AD10, PG9AD15, PG9AI10, PG9AI15, PG9ND10, PG9ND15, PG9NI10, PG9NI15		



¹fuera de producción

accesorios			
			
1			
código	106868	referencia	CM136100 MACM136100
descripción	arandela para piezoencendedor int.ø 18mm ø ext. 32mm H 4mm		
Para modelos:	EC-MAXI-OVEN-GAS, EFG93210, EGL72, EGL74, EVG7		

			
1			
código	106869	referencia	0108555 CM136000 MACM136000 SIR0108555
descripción	tapa para piezoencendedor int.ø 22mm ø ext. 35mm H 25mm		
Para modelos:	EBG7, EBG7-CROMO, EBG92AL, EBG92ALC, EBG92AR, EBG92ARC, EBG92GL, EBG92GLC, EBG92GR, EBG92GRC, EBG92TL, EBG92TLC, EBG92TR, EBG92TRC, EBG93AL, EBG93ALC, EBG93ALR, EBG93AMC, EBG93GL, EBG93GLC, EBG93GLR, EBG93GMC, EBG93TL, EBG93TLC, EBG93TLR, EBG93TMC, EBG94AL, EBG94ALC, EBG94ALR, EBG94AMC, EBG94AR, EBG94GL, EBG94GLC, EBG94GLR, EBG94GMC, EBG94GR, EBG94TL, EBG94TLC, EBG94TLR, EBG94TMC, EBG94TR, ECG7, ECG7-FG, ECG92A, ECG92G, ECG92T, ECG94A, ECG94E, ECG94F, ECG94G...(Otros modelos se puede ver en la tienda web)		

unidades de encendido			
			
1			
código	102485	referencia	2971400 BN6A050100 MA2971400
descripción	grupo de encendido salidas 2 220-240VAC 0.6VA 50-60Hz		
Para modelos:	EDG73142, EDG92142, EDG93142, EDG94242, EFG92123K, EFG94223K, EPG7D05, EPG7I05, EPG7I08, EPG9D10, EPG9D10A, EPG9D15, EPG9D15A, EPG9I15, EPG9I15A, EPG9I10A, EPG9I10A, EPGD05, ESG94CRA, ESG94CRM, ESG94FRA, ESG94FRM, ESG96CRA, ESG96FRA		

			
1			
código	101002	referencia	0101193 0101196 0101197 SIR0101193 SIR0101196 SIR0101197
descripción	grupo de encendido salidas 2 230VAC medidas 88x23x34mm distancia de sujeción 73mm entrada F6,3x0,8 salida F2,8x0,8 0.6VA 50/60Hz		
Para modelos:	CCG1041, CCG1042, CCG1045, CCG1061, CCG1062, CCG10652, CCG10653, CCG1081, CCG1082, CCG1085, CCG10852, CCG7001, CCG7020, CCG7021, CCG7022, CCG7040, CCG7041, CCG7042, CCG7045, CCG7046, CCG7061, CCG7062, CCG70652, CCG70653, CCG70663, CCG7201, CCG7220, CCG7221, CCG7222, CCG7240, CCG7241, CCG7242, CCG7245, CCG7246, CCG7261, CCG7262, CCG72652, CCG72653, CCG72662, CCG72663, CCG9020, CCG9021, CCG9022, CCG9040, CCG9041, CCG9042, CCG9046, CCG9060, CCG9061, CCG9062...(Otros modelos se puede ver en la tienda web)		

			
1			
código	101023	referencia	0101194 SI0101194 SIR0101194
descripción	grupo de encendido salidas 4 230VAC medidas 111x28x34mm distancia de sujeción 98mm entrada F6,3x0,8 salida F2,8x0,8 tipo ZAG4 0.3VA 50-60Hz		
Para modelos:	CCG7001, CCG7020, CCG7021, CCG7022, CCG7040, CCG7041, CCG7042, CCG7045, CCG7046, CCG7061, CCG7062, CCG70652, CCG70653, CCG70663, CCG7201, CCG7240, CCG7241, CCG7242, CCG7245, CCG7246, CCG7261, CCG7262, CCG72652, CCG72653, CCG72662, CCG72663, CCG9020, CCG9021, CCG9022, CCG9040, CCG9041, CCG9042, CCG9046, CCG9060, CCG9061, CCG9062, CCG90663, CCG9081, CCG9082, CCG9140, CCG9140-1, CCG9141, CCG9141-1, CCG9142, CCG9142-1, CCG9145, CCG9145-1, CCG9146, CCG9146-1, CCG9160...(Otros modelos se puede ver en la tienda web)		
accesorios para	101023		
			
código	103257	referencia	—
descripción	grupo de encendido salidas 4 230VAC medidas 111x28x34mm distancia de sujeción 98mm entrada F6,3x0,8 salida F2,8x0,8 tipo FZ4 juego 6 piezas 0.3VA 50-60Hz		



1

código	101024	referencia	0101195 SIR0101195
descripción	grupo de encendido salidas 6 230VAC medidas 112x22x34mm distancia de sujeción 98mm entrada F6,3x0,8 salida F2,8x0,8 tipo ZAG6 0.3VA 50/60Hz T máx -20 a +125°C		
Para modelos:	CCG1041, CCG1042, CCG1045, CCG1061, CCG1062, CCG10652, CCG10653, CCG1081, CCG1082, CCG1085, CCG10852, CCG7001, CCG7020, CCG7021, CCG7022, CCG7040, CCG7041, CCG7042, CCG7045, CCG7046, CCG7061, CCG7062, CCG70652, CCG70653, CCG70663, CCG7201, CCG7261, CCG7262, CCG72652, CCG72653, CCG72662, CCG72663, CCG9020, CCG9021, CCG9022, CCG9040, CCG9041, CCG9042, CCG9046, CCG9060, CCG9061, CCG9062, CCG90663, CCG9081, CCG9082, CCG9160, CCG9160-1, CCG9161, CCG9161-1, CCG9162...(Otros modelos se puede ver en la tienda web)		

interruptores de encendido



1

código	345038	referencia	0101188 CR0410290 SIR0101188
descripción	pulsador montaje ø 25mm negro 2NO 250V 16A empalme conector Faston 6,3mm temperatura ambiente máx. 85°C protección IP40		
Para modelos:	CCG1045, CCG10652, CCG10653, CCG1085, CCG10852, CCG7001, CCG7020, CCG7021, CCG7022, CCG7040, CCG7041, CCG7042, CCG7045, CCG7046, CCG7061, CCG7062, CCG70652, CCG70653, CCG70663, CCG7201, CCG7220, CCG7221, CCG7222, CCG7240, CCG7241, CCG7242, CCG7245, CCG7246, CCG7261, CCG7262, CCG72652, CCG72653, CCG72662, CCG72663, CCG9046, CCG90663, CCG9145, CCG9145-1, CCG91652, CCG91652-1, CCG91653, CCG91653-1, CCG9185, CCG9185-1, CCG91852, CCG91852-1, CFS9050, CFS9052, CFS9055, CG76GPS...(Otros modelos se puede ver en la tienda web)		

termopares

termopares insertables

termopares insertables estándar

con casquillo de enchufe ø6(6,5)mm

termopares SIT

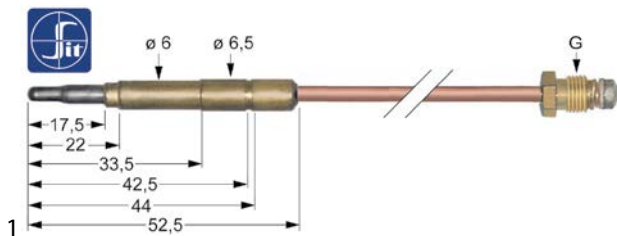

1

código	107619	referencia	0100816 SIR0100816
descripción	termopar SIT M10x1 L 1000mm conexión para conector ø6,0(6,5)mm		
Para modelos:	CPD90100AP, CPD90100A-P, CPD90100P, CPD90150AP, CPD90150A-P, CPD9015-P, PG9AD10, PG9AD15, PG9ND10, PG9ND15		

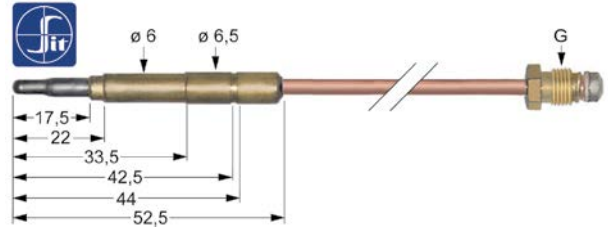

1

código	107621	referencia	0100815 SIO100815 SIR0100815
descripción	termopar SIT M10x1 L 1500mm conexión para conector ø6,0(6,5)mm		

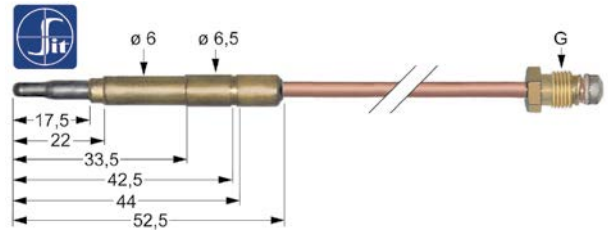

1

código	107614	referencia	0100818 63040030 LAR63040030 SIO100818 SIR0100818
descripción	termopar SIT M9x1 L 1500mm conexión para conector ø6,0(6,5)mm		
Para modelos:	CCG6045, CCG7001P, CCG7045, CCG7045P, CCG70652, CCG70652P, CCG70653, CCG7201, CCG7245, CCG72652, CCG72653, CG74FPS, CG76FPS, CG76HPS, CG84FPS, CG86FPS, CG86HPS, CG88APS, CG88FPS, CG88GPS, CPD90100AP, CPD90100P, CPD90150AP, CPD9015-P, CTT7045, CTT7045L, CTT7045R, CTT70652, CTT70652L, CTT72653, CTT72653L, PG8ND10, PG8ND15, PG9AD10, PG9AD15, PG9ND10, PG9ND15, TG74FPL, TG74FPR, TG74FPS, TG76FPC, TG76FPS, TG84FPS		

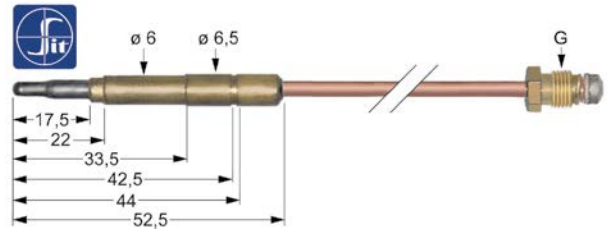

1

código	107608	referencia	0100808 1031504300 6A011912 BN6A011912 MA1031504300 SIR0100808
descripción	termopar SIT M9x1 L 500mm conexión para conector ø6,0(6,5)mm		
Para modelos:	BG62TLC, BG62TLL, BG62TRR, BG63TLC, BG63TLL, BG63TLR, BG64TLC, BG64TLL, BG64TLR, BG72GLC, BG72GLL, BG72GRR, BG72TLC, BG72TLL, BG72TRR, BG74GLC, BG74GLL, BG74GLR, BG74GMC, BG74GRR, BG74TLL, BG74TLR, BG74TRR, BG92ALC, BG92ALL, BG92ARC, BG92ARR, BG92GLC, BG92GLL, BG92GRC, BG92GRR, BGY2TLC, BGY2TLL, BGY2TRC, BGY2TRR, CBG9060CP, CBG9060C-P, CBG9060P, CCG1041, CCG1041P, CCG1042, CCG1042P, CCG1045, CCG1045P, CCG1061, CCG1061P, CCG1062, CCG1062P, CCG10652, CCG10652P...(Otros modelos se puede ver en la tienda web)		

código	107611	referencia	0100809 0105056 CM029100 MACM029100 SIR0100809
descripción	termopar SIT M9x1 L 850mm conexión para conector ø6,0(6,5)mm		
Para modelos:	BG74TRR, BG82ALL, BG82ARR, BG82GLC, BG82GLL, BG82GRR, BG82TLC, BG82TLL, BG82TRR, BG84ALC, BG84ALL, BG84ALR, BG84AMC, BG84ARR, BG84GLC, BG84GLL, BG84GLR, BG84GMC, BG84GRR, BG84TLC, BG84TLL, BG84TLR, BG84TMC, BG84TRR, BG94ALC, BG94ALL, BG94ALR, BG94AMC, BG94ARC, BG94ARR, BG94GLC, BG94GLL, BG94GLR, BG94GMC, BG94GRC, BG94GRR, BGY4TLC, BGY4TLL, BGY4TLR, BGY4TMC, BGY4TRC, BGY4TRR, CBG7050, CCG1041P, CCG1042P, CCG1045, CCG1045P, CCG1061P, CCG1062P, CCG10652... (Otros modelos se puede ver en la tienda web)		

código	102247	referencia	1950100 MA1950100
descripción	termopar con interruptor M9x1 L 600mm clavija ø6,0mm cable 700mm		
Para modelos:	EBG7-CROMO, EBG92ALC, EBG92ARC, EBG92GLC, EBG92GRC, EBG92TLC, EBG92TRC, EBG93ALC, EBG93AMC, EBG93GLC, EBG93GMC, EBG93TLC, EBG93TMC, EBG94ALC, EBG94AMC, EBG94GLC, EBG94GMC, EBG94TLC, EBG94TMC, EFG72108, EFG72110, EFG72115, EFG73208T, EFG73210, EFG74215, EFG92115, EFG92115S, EFG92123, EFG92123K, EFG93210, EFG94215, EFG94215S, EFG94223, EFG94223K, EFG72115, FEG72206, FEG74215, FG82122, FG82206, FG82T22, FG84222, FG84T22, FG92122, FG92206, FG94222, FGY2122, FGY2206, FGY4222, SG86CRA, SG86FRA... (Otros modelos se puede ver en la tienda web)		

termopares insertables con interrupción

código	107177	referencia	0100797 0100810 SIR0100797 SIR0100810
descripción	termopar SIT con interruptor M9x1 L 600mm clavija ø6,0mm F 6,3mm		
Para modelos:	CFG60110, CFG60210, CFG70115, CFG70215, CNG70130, CNG70160, CNG70230, CNG72160, CNG72230, CPI70150, CPI90100AP, CPI90100A-P, CPI90100-P, CPI90150AP, CPI90150A-P, CPI90150-P, DG72125, DG74155, DG74225, PG7NI05, PG8AD10, PG8AD15, PG8AI10, PG8AI15, PG8ND10, PG8ND15, PG8NI10, PG8NI15, PG9AD10, PG9AD15, PG9AI10, PG9AI15, PG9ND10, PG9ND15, PG9NI10, PG9NI15		

termopares roscados

termopares roscados estándar

con casquillo roscado M8x1

SIT

código	107627	referencia	641500 MA641500
descripción	termopar SIT M8x1 L 220mm M8x1		

código	107636	referencia	0100812 SIR0100812	
descripción	termopar SIT M9x1 L 600mm M8x1			
Para modelos:	CCG6020, CCG6040, CCG6045, CCG6046			
accesorios para	107636			
	código	102067	referencia	—
	tuerca rosca M8x1 H 3mm latón UE 1 pzs tipo SEF 1			



termogeneradores

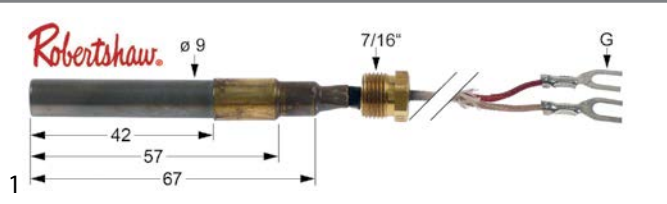

código	102116	referencia	0105109 SIR0105109
descripción	termogenerador ROBERTSHAW L 900mm sonda ø 9mm sonda L 57mm 250-750mV unión roscada 7/16"		
Para modelos:	FG82122, FG84222, FG92122, FG94222, FGY2122, FGY4222		

accesorios

interruptores



código	101265	referencia	0100835 63040210 LAR63040210 SIR0100835
descripción	interruptor rosca M9x1		
Para modelos:	BG92ALC, BG92ARC, BG92GLC, BG92GRC, BG94ALC, BG94AMC, BG94ARC, BG94GLC, BG94GMC, BG94GRC, BGY2TLC, BGY2TRC, BGY4TLC, BGY4TMC, BGY4TRC, CFG90120, CFG90210, CFG90210S, CFG90220, CCG9020-1, CCG9020-3, CCG9021-1, CCG9021-3, CCG9022-1, CCG9022-3, CCG9040-1, CCG9040-3, CCG9040-5, CCG9041-1, CCG9041-3, CCG9041-5, CCG9042-1, CCG9042-3, CCG9042-5, FG92210, FGY2210		

otros



código	107207	referencia	9300545 S19300545 SIR9300545
descripción	soporte para termopar para tipo de quemador E		
Para modelos:	CCG9020, CCG9021, CCG9022, CCG9040, CCG9041, CCG9042, CCG9046, CCG9060, CCG9061, CCG9062, CCG90663, CCG9081, CCG9082, CCG9120, CCG9121, CCG9122, CCG9140, CCG9140-1, CCG9141, CCG9141-1, CCG9142, CCG9142-1, CCG9145, CCG9145-1, CCG9146, CCG9146-1, CCG9160, CCG9160-1, CCG9161, CCG9161-1, CCG9162, CCG9162-1, CCG91652, CCG91652-1, CCG91653, CCG91653-1, CCG91662, CCG91662-1, CCG91663, CCG91663-1, CCG9181, CCG9181-1, CCG9182, CCG9182-1, CCG9185, CCG9185-1, CCG91852, CCG91852-1, CFF1GPA, CFF1GPS		

quemadores de gas

quemadores de cocina

quemadores de cocina universales

GEV



código	103067	referencia	0100247 SIR0100247	
descripción	anillo de quemador para ø de tapa de quemador 100mm			
Para modelos:	CCG6020, CCG6040, CCG6045, CCG6046			
accesorios para	103067			
	código	103068	referencia	0100248 SIR0100248
	tapa de quemador ø 100mm			
	código	104102	referencia	0100261 SIR0100261
	cabezal de quemador para ø de tapa de quemador 100mm ø ext. 130			
	código	104103	referencia	0100258 SIR0100258
	soporte de quemador apto para quemador ø100mm con portaboquillas			







código	103065	referencia	0100249 1032009500 MA1032009500 SIR0100249	
descripción	anillo de quemador para ø de tapa de quemador 80mm			
Para modelos:	CCG6020, CCG6040, CCG6045, CCG6046			
accesorios para	103065			
	código	103066	referencia	0100250 SIR0100250
	tapa de quemador ø 80mm			
	código	104100	referencia	0100259 SIR0100259
	cabezal de quemador para ø de tapa de quemador 80mm			
	código	104101	referencia	0100260 SIR0100260
	soporte de quemador para ø de tapa de quemador 80mm con portaboquillas con casquillo mezclador			







código	104102	referencia	0100261 SIR0100261
descripción	cabezal de quemador para ø de tapa de quemador 100mm ø ext. 130		
Para modelos:	CCG6020, CCG6040, CCG6045, CCG6046		



 <p>1</p>			
código	104100	referencia	0100259 SIR0100259
descripción	cabezal de quemador para ø de tapa de quemador 80mm		
Para modelos:	CCG6020, CCG6040, CCG6045, CCG6046		
accesorios para	104100		
	código	103065	referencia 0100249 1032009500 MA1032009500 SIR0100249
anillo de quemador para ø de tapa de quemador 80mm			
	código	103066	referencia 0100250 SIR0100250
tapa de quemador ø 80mm			
	código	104103	referencia 0100258 SIR0100258
soporte de quemador apto para quemador ø100mm con portaboquillas			

 <p>1</p>			
código	104103	referencia	0100258 SIR0100258
descripción	soporte de quemador apto para quemador ø100mm con portaboquillas		
Para modelos:	CCG6020, CCG6040, CCG6045, CCG6046		
accesorios para	104103		
	código	103067	referencia 0100247 SIR0100247
anillo de quemador para ø de tapa de quemador 100mm			
	código	103068	referencia 0100248 SIR0100248
tapa de quemador ø 100mm			
	código	104102	referencia 0100261 SIR0100261
cabezal de quemador para ø de tapa de quemador 100mm ø ext. 130			

 <p>1</p>			
código	104101	referencia	0100260 SIR0100260
descripción	soporte de quemador para ø de tapa de quemador 80mm con portaboquillas con casquillo mezclador		
Para modelos:	CCG6020, CCG6040, CCG6045, CCG6046		
accesorios para	104101		
	código	103065	referencia 0100249 1032009500 MA1032009500 SIR0100249
anillo de quemador para ø de tapa de quemador 80mm			
	código	103066	referencia 0100250 SIR0100250
tapa de quemador ø 80mm			
	código	104100	referencia 0100259 SIR0100259
cabezal de quemador para ø de tapa de quemador 80mm			



 <p>1</p>			
código	103068	referencia	0100248 SIR0100248
descripción	tapa de quemador ø 100mm		
Para modelos:	CCG6020, CCG6040, CCG6045, CCG6046		
accesorios para	103068		
	código	103067	referencia 0100247 SIR0100247
anillo de quemador para ø de tapa de quemador 100mm			
	código	104102	referencia 0100261 SIR0100261
cabezal de quemador para ø de tapa de quemador 100mm ø ext. 130			
	código	104103	referencia 0100258 SIR0100258
soporte de quemador apto para quemador ø100mm con portaboquillas			

 <p>1</p>			
código	103066	referencia	0100250 SIR0100250
descripción	tapa de quemador ø 80mm		
Para modelos:	CCG6020, CCG6040, CCG6045, CCG6046		
accesorios para	103066		
	código	103065	referencia 0100249 1032009500 MA1032009500 SIR0100249
anillo de quemador para ø de tapa de quemador 80mm			
	código	104100	referencia 0100259 SIR0100259
cabezal de quemador para ø de tapa de quemador 80mm			
	código	104101	referencia 0100260 SIR0100260
soporte de quemador para ø de tapa de quemador 80mm con portaboquillas con casquillo mezclador			

quemadores de cocina específicos del fabricante

SILKO

serie 650 (1)

 <p>1</p>			
código	103067	referencia	0100247 SIR0100247
descripción	anillo de quemador para ø de tapa de quemador 100mm		
Para modelos:	CCG6020, CCG6040, CCG6045, CCG6046		
accesorios para	103067		
	código	103068	referencia 0100248 SIR0100248
tapa de quemador ø 100mm			
	código	104102	referencia 0100261 SIR0100261
cabezal de quemador para ø de tapa de quemador 100mm ø ext. 130			

Continúa en la página siguiente







accesorios para 103067	
	código 104103 referencia 0100258 SIR0100258
soporte de quemador apto para quemador ø100mm con portaboquillas	





	
código 103065	referencia 0100249 1032009500 MA1032009500 SIR0100249
descripción anillo de quemador para ø de tapa de quemador 80mm	
Para modelos: CCG6020, CCG6040, CCG6045, CCG6046	
accesorios para 103065	
	código 103066 referencia 0100250 SIR0100250
tapa de quemador ø 80mm	
	código 104100 referencia 0100259 SIR0100259
cabezal de quemador para ø de tapa de quemador 80mm	
	código 104101 referencia 0100260 SIR0100260
soporte de quemador para ø de tapa de quemador 80mm con portaboquillas con casquillo mezclador	

	
código 104102	referencia 0100261 SIR0100261
descripción cabezal de quemador para ø de tapa de quemador 100mm ø ext. 130	
Para modelos: CCG6020, CCG6040, CCG6045, CCG6046	

	
código 104100	referencia 0100259 SIR0100259
descripción cabezal de quemador para ø de tapa de quemador 80mm	
Para modelos: CCG6020, CCG6040, CCG6045, CCG6046	
accesorios para 104100	
	código 103065 referencia 0100249 1032009500 MA1032009500 SIR0100249
anillo de quemador para ø de tapa de quemador 80mm	
	código 103066 referencia 0100250 SIR0100250
tapa de quemador ø 80mm	
	código 104103 referencia 0100258 SIR0100258
soporte de quemador apto para quemador ø100mm con portaboquillas	

	
código 104103	referencia 0100258 SIR0100258
descripción soporte de quemador apto para quemador ø100mm con portaboquillas	
Para modelos: CCG6020, CCG6040, CCG6045, CCG6046	
accesorios para 104103	
	código 103067 referencia 0100247 SIR0100247
anillo de quemador para ø de tapa de quemador 100mm	
	código 103068 referencia 0100248 SIR0100248
tapa de quemador ø 100mm	
	código 104102 referencia 0100261 SIR0100261
cabezal de quemador para ø de tapa de quemador 100mm ø ext. 130	





	
código 104101	referencia 0100260 SIR0100260
descripción soporte de quemador para ø de tapa de quemador 80mm con portaboquillas con casquillo mezclador	
Para modelos: CCG6020, CCG6040, CCG6045, CCG6046	
accesorios para 104101	
	código 103065 referencia 0100249 1032009500 MA1032009500 SIR0100249
anillo de quemador para ø de tapa de quemador 80mm	
	código 103066 referencia 0100250 SIR0100250
tapa de quemador ø 80mm	
	código 104100 referencia 0100259 SIR0100259
cabezal de quemador para ø de tapa de quemador 80mm	

	
código 103068	referencia 0100248 SIR0100248
descripción tapa de quemador ø 100mm	
Para modelos: CCG6020, CCG6040, CCG6045, CCG6046	
accesorios para 103068	
	código 103067 referencia 0100247 SIR0100247
anillo de quemador para ø de tapa de quemador 100mm	
	código 104102 referencia 0100261 SIR0100261
cabezal de quemador para ø de tapa de quemador 100mm ø ext. 130	
	código 104103 referencia 0100258 SIR0100258
soporte de quemador apto para quemador ø100mm con portaboquillas	



 <p>1</p>			
código	103066	referencia	0100250 SIR0100250
descripción	tapa de quemador ø 80mm		
Para modelos:	CCG6020, CCG6040, CCG6045, CCG6046		
accesorios para	103066		
	código	103065	referencia
			0100249 1032009500 MA1032009500 SIR0100249
anillo de quemador para ø de tapa de quemador 80mm			
	código	104100	referencia
			0100259 SIR0100259
cabezal de quemador para ø de tapa de quemador 80mm			
	código	104101	referencia
			0100260 SIR0100260
soporte de quemador para ø de tapa de quemador 80mm con portaboquillas con casquillo mezclador			

serie 650, 700, 909 (2)

 <p>1</p>			
código	104009	referencia	0100234 SIR0100234
descripción	cabezal de quemador ø 130mm		
accesorios para	104009		
	código	103008	referencia
			0100244 SIR0100244
tapa de quemador ø 90mm			
	código	104010	referencia
			—
soporte de quemador con portaboquillas			
	código	104011	referencia
			0100256 SIR0100256
venturi			
	código	104012	referencia
			0100257 SIR0100257
casquillo de mezcla de aire ø 38mm H 35mm			



 <p>1</p>			
código	104008	referencia	0100232 SIR0100232
descripción	cabezal de quemador para ø de tapa de quemador 90mm		
accesorios para	104008		
	código	103008	referencia
			0100244 SIR0100244
tapa de quemador ø 90mm			
	código	104010	referencia
			—
soporte de quemador con portaboquillas			
	código	104011	referencia
			0100256 SIR0100256
venturi			





accesorios para	104008		
	código	104012	referencia
			0100257 SIR0100257
casquillo de mezcla de aire ø 38mm H 35mm			





 <p>1</p>			
código	104012	referencia	0100257 SIR0100257
descripción	casquillo de mezcla de aire ø 38mm H 35mm		
accesorios para	104012		
	código	103008	referencia
			0100244 SIR0100244
tapa de quemador ø 90mm			
	código	103009	referencia
			0100246 SIR0100246
tapa de quemador ø 130mm			
	código	104008	referencia
			0100232 SIR0100232
cabezal de quemador para ø de tapa de quemador 90mm			
	código	104009	referencia
			0100234 SIR0100234
cabezal de quemador ø 130mm			
	código	104010	referencia
			—
soporte de quemador con portaboquillas			
	código	104011	referencia
			0100256 SIR0100256
venturi			



 <p>1</p>			
código	105294	referencia	0100255 2510603 BN2510603 SIR0100255
descripción	soporte de quemador con portaboquillas		
accesorios para	105294		
	código	104056	referencia
			—
casquillo de mezcla de aire			
	código	105291	referencia
			—
cabezal de quemador para ø de tapa de quemador 70mm 3.5kW			
	código	105292	referencia
			—
tapa de quemador ø 70mm 3.5kW			
	código	105293	referencia
			—
venturi			
	código	105296	referencia
			—
cubierta para quemador piloto apto para serie 700 UE 1 pzs			



			
1			
código	103009	referencia	0100246 SIR0100246
descripción	tapa de quemador ø 130mm		
accesorios para	103009		
	código	104009	referencia 0100234 SIR0100234
cabezal de quemador ø 130mm			
	código	104010	referencia —
soporte de quemador con portaboquillas			
	código	104011	referencia 0100256 SIR0100256
venturi			
	código	104012	referencia 0100257 SIR0100257
casquillo de mezcla de aire ø 38mm H 35mm			

			
1			
código	103008	referencia	0100244 SIR0100244
descripción	tapa de quemador ø 90mm		
accesorios para	103008		
	código	104008	referencia 0100232 SIR0100232
cabezal de quemador para ø de tapa de quemador 90mm			
	código	104010	referencia —
soporte de quemador con portaboquillas			
	código	104011	referencia 0100256 SIR0100256
venturi			
	código	104012	referencia 0100257 SIR0100257
casquillo de mezcla de aire ø 38mm H 35mm			



			
1			
código	104011	referencia	0100256 SIR0100256
descripción	venturi		
accesorios para	104011		
	código	103008	referencia 0100244 SIR0100244
tapa de quemador ø 90mm			
	código	103009	referencia 0100246 SIR0100246
tapa de quemador ø 130mm			
	código	104008	referencia 0100232 SIR0100232
cabezal de quemador para ø de tapa de quemador 90mm			

accesorios para	104011		
	código	104009	referencia 0100234 SIR0100234
cabezal de quemador ø 130mm			
	código	104010	referencia —
soporte de quemador con portaboquillas			
	código	104012	referencia 0100257 SIR0100257
casquillo de mezcla de aire ø 38mm H 35mm			

serie 700, 909, 1100 (1)

			
1			
código	104294	referencia	0100216 0100300 SI0100300 SIR0100216 SIR0100300
descripción	cabezal de quemador E para ø de tapa de quemador 120mm 8.3kW		
Para modelos:	CCG1041, CCG1042, CCG1045, CCG1061, CCG1062, CCG10652, CCG10653, CCG1081, CCG1082, CCG1085, CCG10852, CCG9020, CCG9021, CCG9022, CCG9040, CCG9041, CCG9042, CCG9046, CCG9060, CCG9061, CCG9062, CCG90663, CCG9081, CCG9082, CCG9120, CCG9121, CCG9122, CCG9140, CCG9140-1, CCG9141, CCG9141-1, CCG9145, CCG9145-1, CCG9146, CCG9146-1, CCG9160, CCG9160-1, CCG9161, CCG9161-1, CCG9162, CCG9162-1, CCG91652, CCG91652-1, CCG91653, CCG91653-1, CCG91662, CCG91662-1, CCG91663, CCG91663-1, CCG9181...(Otros modelos se puede ver en la tienda web)		

			
1			
código	104106	referencia	0100209 0100299 SI0100299 SIR0100209 SIR0100299
descripción	cabezal de quemador para ø de tapa de quemador 100mm 5.5kW para bujía		
Para modelos:	CCG1041, CCG1042, CCG1045, CCG1061, CCG1062, CCG10652, CCG10653, CCG1081, CCG1082, CCG1085, CCG10852, CCG7001, CCG7020, CCG7021, CCG7022, CCG7040, CCG7041, CCG7042, CCG7045, CCG7046, CCG7061, CCG7062, CCG70652, CCG70653, CCG70663, CCG7201, CCG7220, CCG7221, CCG7222, CCG7240, CCG7241, CCG7242, CCG7245, CCG7246, CCG7261, CCG7262, CCG72652, CCG72653, CCG72662, CCG72663, CCG9020, CCG9021, CCG9022, CCG9040, CCG9041, CCG9042, CCG9046, CCG9060, CCG9061, CCG9062...(Otros modelos se puede ver en la tienda web)		









accesorios para	104106		
	código	100907	referencia 0100742 0100817 1891700 MA1891700 SIR0100742 SIR0100817
unión roscada rosca M10x1 UE 1 pzs tipo SEF 1 ømm para termopar			
	código	101452	referencia LB839-00 SIRLB839-00
portabujía para tipo de quemador C/D apto para serie 900			

Continúa en la página siguiente











accesorios para 104106			
	código	101453	referencia LB838-00 SIRLB838-00
soporte para termopar cocina de gas para tipo de quemador C/D apto para serie 900			
	código	101454	referencia 0100620 0100741 SI0100620 SIR0100620 SIR0100741
tornillo de racor para bujía rosca M10x1 int.ø 7mm L 15mm			
	código	103070	referencia 0100251 SI0100251 SIR0100251
tapa de quemador ø 95mm 6.4kW con orificio central			
	código	104107	referencia 0100207 0100302 SI0100302 SIR0100207 SIR0100302
parte inferior de quemador para ø de tapa de quemador 100mm 6.4kW			
	código	104108	referencia 0100767 MA1031504900 SIR0100767
portaboquillas soporte de boquilla M10x1 tubo ø 10mm entrada gas M16x1,5 salida gas M14x1			



			
código	106994	referencia	0100224 SI0100224 SIR0100224
descripción	cabezal de quemador para ø de tapa de quemador 120mm 7kW		
Para modelos:	CCG1041P, CCG1042P, CCG1045P, CCG1061P, CCG1062P, CCG10652P, CCG1081P, CCG1082P, CCG1085P, CCG9020P, CCG9021P, CCG9022P, CCG9040P, CCG9041P, CCG9042P, CCG9045P, CCG9046P, CCG9060P, CCG9061P, CCG9062P, CCG90652P, CCG90662P, CCG9081P, CCG9082P, CCG9085P, CCG9085-P, CG82APS, CG82GPS, CG82TPS, CG84APS, CG84EPS, CG84FPS, CG84GPS, CG84TPS, CG86APS, CG86FPS, CG86GPS, CG86HPS, CG86TPS, CG88APS, CG88FPS, CG88GPS, CG92APS, CG92GPS, CG94APS, CG94EPS, CG94FPS, CG94GPS, CG96APS, CG96EPS...(Otros modelos se puede ver en la tienda web)		
accesorios para 106994			
	código	105300	referencia 0100253 SI0100253 SIR0100253
tapa de quemador ø 120mm 7kW con orificio central int.ø 64mm			







			
código	104104	referencia	0100208 0100298 SI0100298 SIR0100208 SIR0100298
descripción	cabezal de quemador para ø de tapa de quemador 80mm 3.5kW código 100212		
Para modelos:	CCG7001, CCG7020, CCG7021, CCG7022, CCG7040, CCG7041, CCG7042, CCG7045, CCG7046, CCG7061, CCG7062, CCG70652, CCG70653, CCG70663, CCG7201, CCG7220, CCG7221, CCG7222, CCG7240, CCG7241, CCG7242, CCG7245, CCG7246, CCG7261, CCG7262, CCG72652, CCG72653, CCG72662, CCG72663, CCG9020, CCG9021, CCG9022, CCG9040, CCG9041, CCG9042, CCG9046, CCG9060, CCG9061, CCG9062, CCG90663, CCG9081, CCG9082, CCG9140, CCG9141, CCG9142, CCG9145, CCG9146, CCG9160, CCG9161, CCG9162...(Otros modelos se puede ver en la tienda web)		
accesorios para 104104			
	código	100907	referencia 0100742 0100817 1891700 MA1891700 SIR0100742 SIR0100817
unión roscada rosca M10x1 UE 1 pzs tipo SEF 1 ømm para termopar			
	código	101452	referencia LB839-00 SIRLB839-00
portabujía para tipo de quemador C/D apto para serie 900			
	código	101453	referencia LB838-00 SIRLB838-00
soporte para termopar cocina de gas para tipo de quemador C/D apto para serie 900			
	código	101454	referencia 0100620 0100741 SI0100620 SIR0100620 SIR0100741
tornillo de racor para bujía rosca M10x1 int.ø 7mm L 15mm			
	código	103069	referencia 0100252 SI0100252 SIR0100252
tapa de quemador ø 80mm 4.3kW con orificio central			
	código	104105	referencia 0100206 0100301 SI0100301 SIR0100206 SIR0100301
parte inferior de quemador para ø de tapa de quemador 80mm 3.5kW			
	código	104108	referencia 0100767 MA1031504900 SIR0100767
portaboquillas soporte de boquilla M10x1 tubo ø 10mm entrada gas M16x1,5 salida gas M14x1			



			
1			
código	107882	referencia	0100223 SI0100223 SIR0100223
descripción	cabezal de quemador para ø de tapa de quemador 95mm 5.5kW		
Para modelos:	CCG1041P, CCG1042P, CCG1045P, CCG1061P, CCG1062P, CCG10652P, CCG1081P, CCG1082P, CCG1085P, CCG7001P, CCG7020P, CCG7021P, CCG7022P, CCG7040P, CCG7041P, CCG7042P, CCG7045P, CCG7046P, CCG7061P, CCG7062P, CCG70652P, CCG70662P, CCG9020P, CCG9021P, CCG9022P, CCG9040P, CCG9041P, CCG9042P, CCG9045P, CCG9046P, CCG9060P, CCG9061P, CCG9062P, CCG90652P, CCG90662P, CCG9081P, CCG9082P, CCG9085P, CCG9085-P, CG72APS, CG72GPS, CG72TPS, CG74APS, CG74EPS, CG74FPS, CG74GPS, CG74TPS, CG76APS, CG76EPS, CG76FPS...(Otros modelos se puede ver en la tienda web)		
accesorios para	107882		
	código	103070	referencia 0100251 SI0100251 SIR0100251
tapa de quemador ø 95mm 6.4kW con orificio central			



			
1			
código	104107	referencia	0100207 0100302 SI0100302 SIR0100207 SIR0100302
descripción	parte inferior de quemador para ø de tapa de quemador 100mm 6.4kW		
Para modelos:	CCG1041, CCG1041P, CCG1042, CCG1042P, CCG1045, CCG1045P, CCG1061, CCG1061P, CCG1062, CCG1062P, CCG10652, CCG10652P, CCG10653, CCG1081, CCG1081P, CCG1082, CCG1082P, CCG1085, CCG10852, CCG1085P, CCG7001, CCG7001P, CCG7020, CCG7020P, CCG7021, CCG7021P, CCG7022, CCG7022P, CCG7040, CCG7040P, CCG7041, CCG7041P, CCG7042, CCG7042P, CCG7045, CCG7045P, CCG7046, CCG7046P, CCG7061, CCG7061P, CCG7062, CCG7062P, CCG70652, CCG70652P, CCG70653, CCG70662P, CCG70663, CCG7201, CCG7220, CCG7221...(Otros modelos se puede ver en la tienda web)		
accesorios para	104107		
	código	100907	referencia 0100742 0100817 1891700 MA1891700 SIR0100742 SIR0100817
unión roscada rosca M10x1 UE 1 pzs tipo SEF 1 ømm para termopar			
	código	101452	referencia LB839-00 SIRLB839-00
portabujía para tipo de quemador C/D apto para serie 900			
	código	101453	referencia LB838-00 SIRLB838-00
soporte para termopar cocina de gas para tipo de quemador C/D apto para serie 900			
	código	101454	referencia 0100620 0100741 SI0100620 SIR0100620 SIR0100741
tornillo de racor para bujía rosca M10x1 int.ø 7mm L 15mm			
	código	103070	referencia 0100251 SI0100251 SIR0100251
tapa de quemador ø 95mm 6.4kW con orificio central			

accesorios para	104107		
	código	104106	referencia 0100209 0100299 SI0100299 SIR0100209 SIR0100299
cabezal de quemador para ø de tapa de quemador 100mm 5.5kW para bujía			
	código	104108	referencia 0100767 MA1031504900 SIR0100767
portabojillas soporte de boquilla M10x1 tubo ø 10mm entrada gas M16x1,5 salida gas M14x1			

			
1			
código	104105	referencia	0100206 0100301 SI0100301 SIR0100206 SIR0100301
descripción	parte inferior de quemador para ø de tapa de quemador 80mm 3.5kW		
Para modelos:	CCG7001, CCG7001P, CCG7020, CCG7020P, CCG7021, CCG7021P, CCG7022, CCG7022P, CCG7040, CCG7040P, CCG7041, CCG7041P, CCG7042, CCG7042P, CCG7045, CCG7045P, CCG7046, CCG7046P, CCG7061, CCG7061P, CCG7062, CCG7062P, CCG70652, CCG70652P, CCG70653, CCG70662P, CCG70663, CCG7201, CCG7220, CCG7221, CCG7222, CCG7240, CCG7241, CCG7242, CCG7245, CCG7246, CCG7261, CCG7262, CCG72652, CCG72653, CCG72662, CCG72663, CCG9020, CCG9021, CCG9022, CCG9040, CCG9040P, CCG9041, CCG9041P, CCG9042...(Otros modelos se puede ver en la tienda web)		
accesorios para	104105		
	código	100907	referencia 0100742 0100817 1891700 MA1891700 SIR0100742 SIR0100817
unión roscada rosca M10x1 UE 1 pzs tipo SEF 1 ømm para termopar			
	código	101452	referencia LB839-00 SIRLB839-00
portabujía para tipo de quemador C/D apto para serie 900			
	código	101453	referencia LB838-00 SIRLB838-00
soporte para termopar cocina de gas para tipo de quemador C/D apto para serie 900			
	código	101454	referencia 0100620 0100741 SI0100620 SIR0100620 SIR0100741
tornillo de racor para bujía rosca M10x1 int.ø 7mm L 15mm			
	código	103069	referencia 0100252 SI0100252 SIR0100252
tapa de quemador ø 80mm 4.3kW con orificio central			
	código	104104	referencia 0100208 0100298 SI0100298 SIR0100208 SIR0100298
cabezal de quemador para ø de tapa de quemador 80mm 3.5kW código 100212			

Continúa en la página siguiente



accesorios para	104105		
	código	104108	referencia 0100767 MA1031504900 SIR0100767
	portabojas soporte de boquilla M10x1 tubo ø 10mm entrada gas M16x1,5 salida gas M14x1		
	código	105297	referencia —
	cabezal de quemador para ø de tapa de quemador 80mm 4.3kW para quemador piloto		

	código	104108	referencia 0100767 MA1031504900 SIR0100767
	portabojas soporte de boquilla M10x1 tubo ø 10mm entrada gas M16x1,5 salida gas M14x1		
Para modelos:	BG72GLC, BG72GLL, BG72GRR, BG72TLC, BG72TLL, BG72TRR, BG74GLC, BG74GLL, BG74GLR, BG74GMC, BG74GRR, BG74TLC, BG74TLL, BG74TLR, BG74TMC, BG74TRR, CCG1041, CCG1041P, CCG1042, CCG1042P, CCG1045, CCG1045P, CCG1061, CCG1061P, CCG1062, CCG1062P, CCG10652, CCG10652P, CCG10653, CCG1081, CCG1081P, CCG1082, CCG1082P, CCG1085, CCG10852, CCG1085P, CCG6045, CCG7001, CCG7001P, CCG7020, CCG7020P, CCG7021, CCG7021P, CCG7022, CCG7022P, CCG7040, CCG7040P, CCG7041, CCG7041P, CCG7042...(Otros modelos se puede ver en la tienda web)		

accesorios para	104108		
	código	102382	referencia —
	tuerca rosca M14x1 H 3.5mm EC 18 latón UE 1 pzs		

	código	104105	referencia 0100206 0100301 SIO100301 SIR0100206 SIR0100301
	parte inferior de quemador para ø de tapa de quemador 80mm 3.5kW		

	código	104107	referencia 0100207 0100302 SIO100302 SIR0100207 SIR0100302
	parte inferior de quemador para ø de tapa de quemador 100mm 6.4kW		

	código	105300	referencia 0100253 SIO100253 SIR0100253
	tapa de quemador ø 120mm 7kW con orificio central int.ø 64mm		

Para modelos:	CCG1041, CCG1041P, CCG1042, CCG1042P, CCG1045, CCG1045P, CCG1061, CCG1061P, CCG1062, CCG1062P, CCG10652, CCG10652P, CCG10653, CCG1081, CCG1081P, CCG1082, CCG1082P, CCG1085, CCG10852, CCG1085P, CCG9020, CCG9020P, CCG9021, CCG9021P, CCG9022, CCG9022P, CCG9040, CCG9040P, CCG9041, CCG9041P, CCG9042, CCG9042P, CCG9045P, CCG9046, CCG9046P, CCG9060, CCG9060P, CCG9061, CCG9061P, CCG9062, CCG9062P, CCG90652P, CCG90662P, CCG90663, CCG9081, CCG9081P, CCG9082, CCG9082P, CCG9085P, CCG9085-P...(Otros modelos se puede ver en la tienda web)		
----------------------	--	--	--

accesorios para	105300		
	código	100907	referencia 0100742 0100817 1891700 MA1891700 SIR0100742 SIR0100817
	unión roscada rosca M10x1 UE 1 pzs tipo SEF 1 ømm para termopar		

accesorios para	105300		
	código	101452	referencia LB839-00 SIRLB839-00
	portabujía para tipo de quemador C/D apto para serie 900		

	código	101453	referencia LB838-00 SIRLB838-00
	soporte para termopar cocina de gas para tipo de quemador C/D apto para serie 900		

	código	101454	referencia 0100620 0100741 SIO100620 SIR0100620 SIR0100741
	tornillo de racor para bujía rosca M10x1 int.ø 7mm L 15mm		

	código	104108	referencia 0100767 MA1031504900 SIR0100767
	portabojas soporte de boquilla M10x1 tubo ø 10mm entrada gas M16x1,5 salida gas M14x1		

	código	104294	referencia 0100216 0100300 SIO100300 SIR0100216 SIR0100300
	cabezal de quemador E para ø de tapa de quemador 120mm 8.3kW		

	código	105301	referencia 0100217 0100303 SIO100303 SIR0100217 SIR0100303
	venturi para ø de tapa de quemador 120mm 7kW		

	código	103069	referencia 0100252 SIO100252 SIR0100252
	tapa de quemador ø 80mm 4.3kW con orificio central		

Para modelos:	CCG7001, CCG7001P, CCG7020, CCG7020P, CCG7021, CCG7021P, CCG7022, CCG7022P, CCG7040, CCG7040P, CCG7041, CCG7041P, CCG7042, CCG7042P, CCG7045, CCG7045P, CCG7046, CCG7046P, CCG7061, CCG7061P, CCG7062, CCG7062P, CCG70652, CCG70652P, CCG70653, CCG70662P, CCG70663, CCG7201, CCG7220, CCG7221, CCG7222, CCG7240, CCG7241, CCG7242, CCG7245, CCG7246, CCG7261, CCG7262, CCG72652, CCG72653, CCG72662, CCG72663, CCG9020, CCG9021, CCG9022, CCG9040, CCG9040P, CCG9041, CCG9041P, CCG9042P...(Otros modelos se puede ver en la tienda web)		
----------------------	---	--	--

accesorios para	103069		
	código	100907	referencia 0100742 0100817 1891700 MA1891700 SIR0100742 SIR0100817
	unión roscada rosca M10x1 UE 1 pzs tipo SEF 1 ømm para termopar		

	código	101452	referencia LB839-00 SIRLB839-00
	portabujía para tipo de quemador C/D apto para serie 900		

	código	101453	referencia LB838-00 SIRLB838-00
	soporte para termopar cocina de gas para tipo de quemador C/D apto para serie 900		

	código	101454	referencia 0100620 0100741 SIO100620 SIR0100620 SIR0100741
	tornillo de racor para bujía rosca M10x1 int.ø 7mm L 15mm		



Continúa en la página siguiente



accesorios para 103069					0100208 0100298 SIO100298 SIR0100208 SIR0100298
	código	104104	referencia		
cabezal de quemador para ø de tapa de quemador 80mm 3.5kW código 100212					
	código	104105	referencia		0100206 0100301 SIO100301 SIR0100206 SIR0100301
parte inferior de quemador para ø de tapa de quemador 80mm 3.5kW					
	código	104108	referencia		0100767 MA1031504900 SIR0100767
portaboquillas soporte de boquilla M10x1 tubo ø 10mm entrada gas M16x1,5 salida gas M14x1					
	código	105297	referencia		—
cabezal de quemador para ø de tapa de quemador 80mm 4.3kW para quemador piloto					

1 					0100251 SIO100251 SIR0100251
código	103070	referencia			
descripción tapa de quemador ø 95mm 6.4kW con orificio central					
Para modelos: CCG1041, CCG1041P, CCG1042, CCG1042P, CCG1045, CCG1045P, CCG1061, CCG1061P, CCG1062, CCG1062P, CCG10652, CCG10652P, CCG10653, CCG1081, CCG1081P, CCG1082, CCG1082P, CCG1085, CCG10852, CCG1085P, CCG7001, CCG7001P, CCG7020, CCG7020P, CCG7021, CCG7021P, CCG7022, CCG7022P, CCG7040, CCG7040P, CCG7041, CCG7041P, CCG7042, CCG7042P, CCG7045, CCG7045P, CCG7046, CCG7046P, CCG7061, CCG7061P, CCG7062, CCG7062P, CCG70652, CCG70652P, CCG70653, CCG70662P, CCG70663, CCG7201, CCG7220, CCG7221...(Otros modelos se puede ver en la tienda web)					

accesorios para 103070					0100742 0100817 1891700 MA1891700 SIR0100742 SIR0100817
	código	100907	referencia		
unión roscada rosca M10x1 UE 1 pzs tipo SEF 1 ømm para termopar					
	código	101452	referencia		LB839-00 SIRLB839-00
portabujía para tipo de quemador C/D apto para serie 900					
	código	101453	referencia		LB838-00 SIRLB838-00
soporte para termopar cocina de gas para tipo de quemador C/D apto para serie 900					
	código	101454	referencia		0100620 0100741 SIO100620 SIR0100620 SIR0100741
tornillo de racor para bujía rosca M10x1 int.ø 7mm L 15mm					
	código	104106	referencia		0100209 0100299 SIO100299 SIR0100209 SIR0100299
cabezal de quemador para ø de tapa de quemador 100mm 5.5kW para bujía					

accesorios para 103070					0100207 0100302 SIO100302 SIR0100207 SIR0100302
	código	104107	referencia		
parte inferior de quemador para ø de tapa de quemador 100mm 6.4kW					
	código	104108	referencia		0100767 MA1031504900 SIR0100767
portaboquillas soporte de boquilla M10x1 tubo ø 10mm entrada gas M16x1,5 salida gas M14x1					





código	105301	referencia			0100217 0100303 SIO100303 SIR0100217 SIR0100303
descripción venturi para ø de tapa de quemador 120mm 7kW					
Para modelos: CCG1041, CCG1041P, CCG1042, CCG1042P, CCG1045, CCG1045P, CCG1061, CCG1061P, CCG1062, CCG1062P, CCG10652, CCG10652P, CCG10653, CCG1081, CCG1081P, CCG1082, CCG1082P, CCG1085, CCG10852, CCG1085P, CCG9020, CCG9020P, CCG9021, CCG9021P, CCG9022, CCG9022P, CCG9040, CCG9040P, CCG9041, CCG9041P, CCG9042, CCG9042P, CCG9045P, CCG9046, CCG9046P, CCG9060, CCG9060P, CCG9061, CCG9061P, CCG9062, CCG9062P, CCG90652P, CCG90662P, CCG90663, CCG9081, CCG9081P, CCG9082, CCG9082P, CCG9085P, CCG9085-P...(Otros modelos se puede ver en la tienda web)					

accesorios para 105301					0101151 SIR0101151
	código	100885	referencia		
casquillo de mezcla de aire para quemador piloto UE 1 pzs					
	código	100907	referencia		0100742 0100817 1891700 MA1891700 SIR0100742 SIR0100817
unión roscada rosca M10x1 UE 1 pzs tipo SEF 1 ømm para termopar					
	código	101454	referencia		0100620 0100741 SIO100620 SIR0100620 SIR0100741
tornillo de racor para bujía rosca M10x1 int.ø 7mm L 15mm					
	código	104108	referencia		0100767 MA1031504900 SIR0100767
portaboquillas soporte de boquilla M10x1 tubo ø 10mm entrada gas M16x1,5 salida gas M14x1					
	código	104294	referencia		0100216 0100300 SIO100300 SIR0100216 SIR0100300
cabezal de quemador E para ø de tapa de quemador 120mm 8.3kW					
	código	105300	referencia		0100253 SIO100253 SIR0100253
tapa de quemador ø 120mm 7kW con orificio central int.ø 64mm					

Continúa en la página siguiente





accesorios para 105301					
	<table border="1"> <tr> <td>código</td> <td>106994</td> <td>referencia</td> <td>0100224 SI0100224 SIR0100224</td> </tr> </table> <p>cabezal de quemador para ø de tapa de quemador 120mm 7kW</p>	código	106994	referencia	0100224 SI0100224 SIR0100224
código	106994	referencia	0100224 SI0100224 SIR0100224		
	<table border="1"> <tr> <td>código</td> <td>107206</td> <td>referencia</td> <td>9300544 SI9300544 SIR9300544</td> </tr> </table> <p>portabujía para bujía para tipo de quemador E</p>	código	107206	referencia	9300544 SI9300544 SIR9300544
código	107206	referencia	9300544 SI9300544 SIR9300544		
	<table border="1"> <tr> <td>código</td> <td>107207</td> <td>referencia</td> <td>9300545 SI9300545 SIR9300545</td> </tr> </table> <p>soporte para termopar para tipo de quemador E</p>	código	107207	referencia	9300545 SI9300545 SIR9300545
código	107207	referencia	9300545 SI9300545 SIR9300545		

serie 900					
	<table border="1"> <tr> <td>código</td> <td>103073</td> <td>referencia</td> <td>CR0580040</td> </tr> </table> <p>descripción cabezal de quemador para ø de tapa de quemador 102mm H 37mm apto para serie 900</p> <p>Para modelos: ECG92A, ECG92G, ECG92T, ECG94A, ECG94E, ECG94F, ECG94G, ECG94T, ECG96A, ECG96E, ECG96F, ECG96G, ECG96H, ECG96T, ECG98A, ECG98F, ECG98G</p>	código	103073	referencia	CR0580040
código	103073	referencia	CR0580040		

	<table border="1"> <tr> <td>código</td> <td>103072</td> <td>referencia</td> <td>CR0580030</td> </tr> </table> <p>descripción cabezal de quemador para ø de tapa de quemador 64mm H 37mm apto para serie 900</p> <p>Para modelos: ECG7, ECG92A, ECG92G, ECG92T, ECG94A, ECG94E, ECG94F, ECG94G, ECG94T, ECG96A, ECG96E, ECG96F, ECG96G, ECG96H, ECG96T, ECG98A, ECG98F, ECG98G</p>	código	103072	referencia	CR0580030
código	103072	referencia	CR0580030		

	<table border="1"> <tr> <td>código</td> <td>103083</td> <td>referencia</td> <td>8204760 SI8204760 SIR8204760</td> </tr> </table> <p>descripción junta L 77mm An 69mm espesor 2mm grafito para venturi apto para serie 900</p> <p>Para modelos: ECG92A, ECG92G, ECG92T, ECG94A, ECG94E, ECG94F, ECG94G, ECG94T, ECG96A, ECG96E, ECG96F, ECG96G, ECG96H, ECG96T, ECG98A, ECG98F, ECG98G</p>	código	103083	referencia	8204760 SI8204760 SIR8204760
código	103083	referencia	8204760 SI8204760 SIR8204760		

	<table border="1"> <tr> <td>código</td> <td>103075</td> <td>referencia</td> <td>CR0581700</td> </tr> </table> <p>descripción portabojillas ø 34mm H 150mm apto para serie 900</p> <p>Para modelos: ECG7, ECG92A, ECG92G, ECG92T, ECG94A, ECG94E, ECG94F, ECG94G, ECG94T, ECG96A, ECG96E, ECG96F, ECG96G, ECG96H, ECG96T, ECG98A, ECG98F, ECG98G</p>	código	103075	referencia	CR0581700
código	103075	referencia	CR0581700		

	<table border="1"> <tr> <td>código</td> <td>103064</td> <td>referencia</td> <td>CR0580020</td> </tr> </table> <p>descripción tapa de quemador ø 102mm H 28mm apto para serie 900</p> <p>Para modelos: ECG92A, ECG92G, ECG92T, ECG94A, ECG94E, ECG94F, ECG94G, ECG94T, ECG96A, ECG96E, ECG96F, ECG96G, ECG96H, ECG96T, ECG98A, ECG98F, ECG98G</p>	código	103064	referencia	CR0580020
código	103064	referencia	CR0580020		



	<table border="1"> <tr> <td>código</td> <td>103071</td> <td>referencia</td> <td>CR0580010</td> </tr> </table> <p>descripción tapa de quemador ø 64mm H 26mm apto para serie 900</p> <p>Para modelos: ECG7, ECG92A, ECG92G, ECG92T, ECG94A, ECG94E, ECG94F, ECG94G, ECG94T, ECG96A, ECG96E, ECG96F, ECG96G, ECG96H, ECG96T, ECG98A, ECG98F, ECG98G</p>	código	103071	referencia	CR0580010
código	103071	referencia	CR0580010		

	<table border="1"> <tr> <td>código</td> <td>103074</td> <td>referencia</td> <td>CR0586451</td> </tr> </table> <p>descripción venturi para ø de tapa de quemador 102mm con piloto de encendido apto para serie 900</p> <p>Para modelos: ECG92A, ECG92G, ECG92T, ECG94A, ECG94E, ECG94F, ECG94G, ECG94T, ECG96A, ECG96E, ECG96F, ECG96G, ECG96H, ECG96T, ECG98A, ECG98F, ECG98G</p>	código	103074	referencia	CR0586451
código	103074	referencia	CR0586451		

	<table border="1"> <tr> <td>código</td> <td>107422</td> <td>referencia</td> <td>CR0586441</td> </tr> </table> <p>descripción venturi para ø de tapa de quemador 64mm con piloto de encendido apto para serie 900</p> <p>Para modelos: ECG7, ECG92A, ECG92G, ECG92T, ECG94A, ECG94E, ECG94F, ECG94G, ECG94T, ECG96A, ECG96E, ECG96F, ECG96G, ECG96H, ECG96T, ECG98A, ECG98F, ECG98G</p>	código	107422	referencia	CR0586441				
código	107422	referencia	CR0586441						
	<table border="1"> <tr> <td>accesorios para</td> <td>107422</td> <td></td> <td></td> </tr> <tr> <td>código</td> <td>103071</td> <td>referencia</td> <td>CR0580010</td> </tr> </table> <p>tapa de quemador ø 64mm H 26mm apto para serie 900</p>	accesorios para	107422			código	103071	referencia	CR0580010
accesorios para	107422								
código	103071	referencia	CR0580010						

Continúa en la página siguiente



accesorios para	107422		
	código	103072	referencia CR0580030
	cabezal de quemador para ø de tapa de quemador 64mm H 37mm apto para serie 900		
	código	103075	referencia CR0581700
	porta-boquillas ø 34mm H 150mm apto para serie 900		
	código	103083	referencia 8204760 S18204760 SIR8204760
	junta L 77mm An 69mm espesor 2mm grafito para venturi apto para serie 900		

parrillas de quemador



código	210187	referencia	6200291
descripción	rejilla de quemador An 365mm L 585mm		
Para modelos:	CCG6020, CCG6040, CCG6045, CCG6046		



código	210156	referencia	0101807 0101808 SI0101807 SIR0101807 SIR0101808
descripción	rejilla de quemador An 380mm L 575mm		
Para modelos:	CCG7001, CCG7001P, CCG7020, CCG7020P, CCG7021, CCG7021P, CCG7022, CCG7022P, CCG7040, CCG7040P, CCG7041, CCG7041P, CCG7042, CCG7042P, CCG7045, CCG7045P, CCG7046, CCG7046P, CCG7061, CCG7061P, CCG7062, CCG7062P, CCG70652, CCG70652P, CCG70653, CCG70662P, CCG70663, CCG7201, CCG7220, CCG7221, CCG7222, CCG7240, CCG7241, CCG7242, CCG7245, CCG7246, CCG7261, CCG7262, CCG72652, CCG72653, CCG72662, CCG72663, CG72APS, CG72GPS, CG72TPS, CG74APS, CG74EPS, CG74FPS, CG74GPS, CG74TPS...(Otros modelos se puede ver en la tienda web)		

estrellas reductoras



código	210050	referencia	0101080 SI0101080 SIR0101080
descripción	estrella reductora L 260mm An 260mm acero cromado apto para universal		
Para modelos:	CCG1041, CCG1042, CCG1045, CCG1061, CCG1062, CCG10652, CCG10653, CCG1081, CCG1082, CCG1085, CCG10852, CCG7001, CCG7001P, CCG7020, CCG7021, CCG7022, CCG7040, CCG7041, CCG7042, CCG7045, CCG7046, CCG7061, CCG7062, CCG70652, CCG70653, CCG70663, CCG7201, CCG7220, CCG7221, CCG7222, CCG7240, CCG7241, CCG7242, CCG7245, CCG7246, CCG7261, CCG7262, CCG72652, CCG72653, CCG72662, CCG72663, CCG9020, CCG9021, CCG9022, CCG9040, CCG9041, CCG9042, CCG9046, CCG9060, CCG9061...(Otros modelos se puede ver en la tienda web)		



código	210001	referencia	MA86400 N/A
descripción	estrella reductora L 265mm An 265mm inox apto para universal		

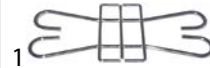

código	210004	referencia	0101082 SIR0101082
descripción	estrella reductora L 360mm An 160mm serie 700		

bandejas colectoras



código	210250	referencia	LB847-00 SIRLB847-00
descripción	bandeja colectoras L 550mm An 355mm H 70mm		
Para modelos:	CCG7001P, CCG7020, CCG7020P, CCG7021, CCG7021P, CCG7022, CCG7022P, CCG7040, CCG7040P, CCG7041, CCG7041P, CCG7042, CCG7042P, CCG7045, CCG7045P, CCG7046, CCG7046P, CCG7061, CCG7061P, CCG7062, CCG7062P, CCG70652, CCG70652P, CCG70653, CCG70662P, CCG70663, CCG7201, CCG7221, CCG7222, CCG7240, CCG7241, CCG7242, CCG7245, CCG7246, CCG7261, CCG7262, CCG72652, CCG72653, CCG72662, CCG72663, CG72APS, CG72GPS, CG72TPS, CG74APS, CG74EPS, CG74FPS, CG74GPS, CG74TPS, CG76APS, CG76EPS...(Otros modelos se puede ver en la tienda web)		



accesorios

estrellas reductoras



código	210050	referencia	0101080 SIO101080 SIR0101080
---------------	--------	-------------------	------------------------------------

descripción estrella reductora L 260mm An 260mm acero cromado apto para universal

Para modelos: CCG1041, CCG1042, CCG1045, CCG1061, CCG1062, CCG10652, CCG10653, CCG1081, CCG1082, CCG1085, CCG10852, CCG7001, CCG7001P, CCG7020, CCG7021, CCG7022, CCG7040, CCG7041, CCG7042, CCG7045, CCG7046, CCG7061, CCG7062, CCG70652, CCG70653, CCG70663, CCG7201, CCG7220, CCG7221, CCG7222, CCG7240, CCG7241, CCG7242, CCG7245, CCG7246, CCG7261, CCG7262, CCG72652, CCG72653, CCG72662, CCG72663, CCG9020, CCG9021, CCG9022, CCG9040, CCG9041, CCG9042, CCG9046, CCG9060, CCG9061...(Otros modelos se puede ver en la tienda web)



código	210001	referencia	MA86400 N/A
---------------	--------	-------------------	----------------

descripción estrella reductora L 265mm An 265mm inox apto para universal



código	210004	referencia	0101082 SIR0101082
---------------	--------	-------------------	-----------------------

descripción estrella reductora L 360mm An 160mm serie 700

parrillas de quemador



código	210163	referencia	0101829 SIR0101829
---------------	--------	-------------------	-----------------------

descripción rejilla de quemador



código	210151	referencia	1032101100 1032101101 MA1032101100 MA1032101101
---------------	--------	-------------------	--

descripción rejilla de quemador An 295mm L 545mm cocina de gas

Para modelos: CCG6230/1, CG64TPS



código	210150	referencia	1032101000 1032101001 MA1032101000 MA1032101001
---------------	--------	-------------------	--

descripción rejilla de quemador An 340mm L 545mm

Para modelos: CCG6220/1, CCG6245-1, CCG62652-1, CG62TPS, CG64FPS, CG66FPS



código	210187	referencia	6200291
---------------	--------	-------------------	---------

descripción rejilla de quemador An 365mm L 585mm

Para modelos: CCG6020, CCG6040, CCG6045, CCG6046



código	210156	referencia	0101807 0101808 SIO101807 SIR0101807 SIR0101808
---------------	--------	-------------------	---

descripción rejilla de quemador An 380mm L 575mm

Para modelos: CCG7001, CCG7001P, CCG7020, CCG7020P, CCG7021, CCG7021P, CCG7022, CCG7022P, CCG7040, CCG7040P, CCG7041, CCG7041P, CCG7042, CCG7042P, CCG7045, CCG7045P, CCG7046, CCG7046P, CCG7061, CCG7061P, CCG7062, CCG7062P, CCG70652, CCG70652P, CCG70653, CCG70662P, CCG70663, CCG7201, CCG7220, CCG7221, CCG7222, CCG7240, CCG7241, CCG7242, CCG7245, CCG7246, CCG7261, CCG7262, CCG72652, CCG72653, CCG72662, CCG72663, CG72APS, CG72GPS, CG72TPS, CG74APS, CG74EPS, CG74FPS, CG74G-PS, CG74TPS...(Otros modelos se puede ver en la tienda web)



bandejas colectoras





1

código	210250	referencia	LB847-00 SIRLB847-00
descripción	bandeja colectoras L 550mm An 355mm H 70mm		
Para modelos:	CCG7001P, CCG7020, CCG7020P, CCG7021, CCG7021P, CCG7022, CCG7022P, CCG7040, CCG7040P, CCG7041, CCG7041P, CCG7042, CCG7042P, CCG7045, CCG7045P, CCG7046, CCG7046P, CCG7061, CCG7061P, CCG7062, CCG7062P, CCG70652, CCG70652P, CCG70653, CCG70662P, CCG70663, CCG7201, CCG7221, CCG7222, CCG7240, CCG7241, CCG7242, CCG7245, CCG7246, CCG7261, CCG7262, CCG72652, CCG72653, CCG72662, CCG72663, CG72APS, CG72GPS, CG72TPS, CG74APS, CG74EPS, CG74FPS, CG74GPS, CG74TPS, CG76APS, CG76EPS...(Otros modelos se puede ver en la tienda web)		

mezcladores de aire



1

código	104012	referencia	0100257 SIR0100257	
descripción	casquillo de mezcla de aire ø 38mm H 35mm			
accesorios para	104012			
	código	104008	referencia	0100232 SIR0100232
	cabezal de quemador para ø de tapa de quemador 90mm			
	código	104011	referencia	0100256 SIR0100256
	venturi			

quemadores tubulares

quemadores tubulares



1

código	105543	referencia	0100267 LA63010010 LAR63010010 SIR0100267
descripción	quemador tubular 1 fila ø 40mm Anmm Hmm L 420mm anchura brida 43mm longitud brida 43mm baño maría		



1

código	105253	referencia	0100284 SIO100284 SIR0100284
descripción	quemador tubular 1 fila ø 40mm Anmm Hmm L 547mm plancha grill brida ø 61mm		
Para modelos:	BG92ALC, BG92ALL, BG92ARC, BG92ARR, BG92GLC, BG92GLL, BG92GRC, BG92GRR, BG94ALC, BG94ALL, BG94ALR, BG94AMC, BG94ARC, BG94ARR, BG94GLC, BG94GLL, BG94GLR, BG94GMC, BG94GRC, BG94GRR, BGY2TLC, BGY2TLL, BGY2TRC, BGY2TRR, BGY4TLC, BGY4TLL, BGY4TLR, BGY4TMC, BGY4TRC, BGY4TRR, CGG9020-0, CGG9020-1, CGG9020-2, CGG9020-3, CGG9021-0, CGG9021-1, CGG9021-2, CGG9021-3, CGG9022-0, CGG9022-1, CGG9022-2, CGG9022-3, CGG9040-0, CGG9040-1, CGG9040-2, CGG9040-3, CGG9040-4, CGG9040-5, CGG9041-0, CGG9041-1...(Otros modelos se puede ver en la tienda web)		



1

código	105260	referencia	0109045 SIR0109045
descripción	quemador tubular 2 filas L 450mm An 300mm ømm H 50mm 8.5KW plancha grill		
Para modelos:	CGG6030, CGG6030C, CGG6030R		



1

código	105491	referencia	0105050 MACM033503
descripción	quemador tubular 2 filas L 665mm An 190mm ømm H 55mm plancha grill cromado		
Para modelos:	BG74TRR, BG82ALL, BG82ARR, BG82GLC, BG82GLL, BG82GRR, BG82TLC, BG82TLL, BG82TRR, BG84ALC, BG84ALL, BG84ALR, BG84AMC, BG84ARR, BG84GLC, BG84GLL, BG84GLR, BG84GMC, BG84GRR, BG84TLC, BG84TLL, BG84TLR, BG84TMC, BG84TRR		



1

código	105549	referencia	0108175 SIR0108175
descripción	quemador tubular 3 filas		
Para modelos:	CRG9022, CRG9022S, CRG9042, CRG9042S, GL92AGC, GL94AGC, GLY2AGC, GLY4AGC		



1			
código	105548	referencia	0108191 SIR0108191
descripción	quemador tubular 3 filas L 415mm An 248mm ømm H 145mm grill de piedra volcánica		
Para modelos:	CRG7022, CRG7042, CRG7222, CRG7242		

1			
código	105498	referencia	CM088200 MACM088200
descripción	quemador tubular ø 50mm Anmm Hmm L 308mm anchura brida 71mm brida ø 75mm cocedora de pasta		
Para modelos:	DG72128, DG74228, EPG7D05, EPG7I05, EPG7I08, EPGD05		

1			
código	105537	referencia	0100277 SI0100277 SIR0100277
descripción	quemador tubular acodado L 570mm An 310mm ømm Hmm horno		
Para modelos:	CCG7045, CCG7045P, CCG70652, CCG70652P, CCG70653, CCG7245, CCG72652, CCG72653, CG74FPS, CG76FPS, CG84FPS, CG86FPS, CG88APS, CG88FPS, CG88GPS, CTT7045, CTT7045L, CTT7045R, CTT70652, CTT70652L, CTT72653, CTT72653L, TG74FPL, TG74FPR, TG74FPS, TG76FPC, TG76FPS, TG84FPS		

1			
código	105547	referencia	0100268 SIR0100268
descripción	quemador tubular ø 50mm Anmm Hmm L 432mm anchura brida 71mm freidora brida ø 75mm		

1			
código	105542	referencia	0108100 SIR0108100
descripción	quemador tubular ø 40mm Anmm Hmm L 300mm anchura brida 43mm longitud brida 43mm cocedora de pasta		

1			
código	105523	referencia	0105117 CM088100 MACM088100
descripción	quemador tubular ø 50mm Anmm Hmm L 475mm brida ø 75mm		
Para modelos:	DG82140, DG82142, DG82T42, DG84240, DG84242, DG84T42, DG92142, DG94242, DGY2142, DGY4242, EDG73142, EDG92142, EDG93142, EDG94242, EPG9D10, EPG9D10A, EPG9D15, EPG9D15A, EPG9I15, EPG9I15A, EPGB9I10, EPGB9I10A		

1			
código	105257	referencia	0100280 SI0100280 SIR0100280
descripción	quemador tubular ø 40mm Anmm Hmm L 397mm marmita brida ø 61mm distancia de sujeción 45mm		
Para modelos:	CBG9060C-I, CBG9060CP, CBG9060C-P, CBG9060P, CCG6045, CMG7041, CMG7042, CMG9021, CMG9022, CMG9041, CMG9042, CPD70150, CPD90100, CPD90100A, CPD90100AP, CPD90100A-P, CPD90100P, CPD90150, CPD90150A, CPD90150AP, CPD90150A-P, CPD9015-P, CPI70150, CPI90100, CPI90100A, CPI90100AP, CPI90100A-P, CPI90100P, CPI90100-P, CPI90150, CPI90150A, CPI90150AP, CPI90150A-P, CPI90150P, CPI90150-P, MG92APS, MG92GPS, MG94APS, MG94GPS, PG7ND05, PG7NI05, PG8AD10, PG8AD15, PG8AI10, PG8AI15, PG8ND10, PG8ND15, PG8NI10, PG8NI15, PG9AD10...(Otros modelos se puede ver en la tienda web)		

1			
código	103077	referencia	CR0684490
descripción	quemador tubular ø 50mm Anmm Hmm L 490mm anchura brida 52mm longitud brida 75mm freidora		
Para modelos:	EFG72110, EFG72115, EFG73210, EFG74215, EFG92115, EFG92115S, EFG93210, EFG94215, EFG94215S		



			
1			
código	105250	referencia	0101051 SIR0101051
descripción	quemador tubular ø 50mm Anmm Hmm L 610mm anchura brida 71mm cocina de gas brida ø 75mm		
Para modelos:	CCG9045P, CCG9046, CCG90652P, CCG90663, CCG9085P, CCG9085-P, CCG9145, CCG9145-1, CCG91652, CCG91652-1, CCG91653, CCG91653-1, CCG9185, CCG9185-1, CCG91852, CCG91852-1, CFS9050, CFS9052, CFS9055, CG86HPS, CG94FPS, CG96FPS, CG98FPS, CTT9045, CTT90652R, CTT90653R, CTT90663R, HG94FPS, HGY4FPS, TG94FPS, TG96FPS		

			
1			
código	105254	referencia	0100296 SIR0100296
descripción	quemador tubular ø 60mm Anmm Hmm L 315mm anchura brida 67mm longitud brida 67mm cocedora de pasta		
Para modelos:	CNG70130, CNG70230, CNG72230, CNG90130, CNG90130-S, CNG90140, CNG90140-S, CNG90230, CNG90240, DG72125, DG74225, DG92140, DG94240		

			
1			
código	105255	referencia	0109046 SIR0109046
descripción	quemador tubular ømm An 41mm H 34mm L 490mm anchura brida 70mm 5.5kW plancha grill		
Para modelos:	BG72GLC, BG72GLL, BG72GRR, BG72TLC, BG72TLL, BG72TRR, BG74GLC, BG74GLL, BG74GLR, BG74GMC, BG74GRR, BG74TLC, BG74TLL, BG74TLR, BG74TMC, BG74TRR, CGE6020, CGE6020R, CGG6020, CGG6020C, CGG6020R, CGG6040, CGG6040C, CGG6040R, CGG7020, CGG7020C, CGG7020R, CGG7021, CGG7021C, CGG7021R, CGG7040, CGG7040C, CGG7040LR, CGG7040LRC, CGG7040R, CGG7041, CGG7041C, CGG7041LR, CGG7041LRC, CGG7041R, CGG7220R, CGG7221, CGG7221C, CGG7240, CGG7240C, CGG7240LR, CGG7240LRC, CGG7240R, CGG7241, CGG7241C...(Otros modelos se puede ver en la tienda web)		

			
1			
código	105256	referencia	0100279 SIR0100279
descripción	quemador tubular sartén basculante		
Para modelos:	CBG7050, CBG7050C, SG74CRM, SG74IRM		

quemadores tubulares

			
1			
código	105528	referencia	0108046 SIR0108046
descripción	quemador tubular L 295mm An 55mm H 70mm pos. de montaje centro/derecha para freidora ovalado		
Para modelos:	CFG70115, CFG70215, CFG72215, CFG90120, CFG90220		

			
1			
código	105261	referencia	0109016 SIR0109016
descripción	quemador tubular ø 74mm L 180mm An 75mm H 60mm para freidora redondo		
Para modelos:	CFG60110, CFG60210		





			
1			
código	105544	referencia	0108045 SIR0108045
descripción	quemador tubular para freidora ovalado		
Para modelos:	CFG70115, CFG70215, CFG72215, CFG90120, CFG90210, CFG90210S, CFG90220, FG92210, FGY2210		



quemadores para placas radiantes





			
código	105251	referencia	0100294 SI0100294 SIR0100294
descripción	quemador para placas radiantes ø 120mm H 102mm L 340mm		
Para modelos:	CTT1041, CTT1042, CTT1045, CTT7040, CTT7041, CTT7042, CTT7045, CTT70652L, CTT70653L, CTT72653L, CTT9040, CTT9041, CTT9042, CTT9045, CTT9046, CTT90652R, CTT90663R, ETG94A, ETG94AL, ETG94F, ETG94FL, ETG94G, ETG94GL, ETG94T, ETG94TPL, ETG96F, ETG96FC, ETG96FL, TG74APS, TG74FPS, TG74GPS, TG74TPS, TG76FPS, TG94APS, TG94EPS, TG94FPS, TG94GPS, TG96FPS, TGP4APS, TGP4FPS, TGP4GPS, TGY4TPS		

			
código	105534	referencia	0100282 SI0100282 SIR0100282
descripción	quemador para placas radiantes ø 122mm H1 27mm H2 63mm L 285mm		
Para modelos:	CTT652L, CTT653L, CTT7040L, CTT7040R, CTT7041L, CTT7041R, CTT7042L, CTT7042R, CTT7045L, CTT7045R, CTT70652, CTT70653, CTT72653, TG74APL, TG74APR, TG74FPL, TG74GPL, TG74GPR, TG74TPL, TG74TPR, TG76FPC		

accesorios para	105534			
	código	101278	referencia	0100775 86720 MA86720 SIR0100775
anillo cortante para tubo ø 10mm UE 1 pzs				
	código	101300	referencia	0100774 SIR0100774
tuerca de racor rosca M16x1,5 tubo ø 10mm				
	código	102773	referencia	0101046 SIR0101046
boquilla de gas rosca M10x1 EC 11 taladro ø 1.65mm G20-25				
	código	106285	referencia	0100907 SI0100907 SIR0100907
boquilla de gas rosca M10x1 EC 11 taladro ø 1.15mm				
	código	106503	referencia	—
boquilla de gas rosca M10x1 EC 11 taladro ø 1.1mm				

accesorios

portaboquillas

				
código	104108	referencia	0100767 MA1031504900 SIR0100767	
descripción	portaboquillas soporte de boquilla M10x1 tubo ø 10mm entrada gas M16x1,5 salida gas M14x1			
Para modelos:	BG72GLC, BG72GLL, BG72GRR, BG72TLC, BG72TLL, BG72TRR, BG74GLC, BG74GLL, BG74GLR, BG74GMC, BG74GRR, BG74TLC, BG74TLL, BG74TLR, BG74TMC, BG74TRR, CCG1041, CCG1041P, CCG1042, CCG1042P, CCG1045, CCG1045P, CCG1061, CCG1061P, CCG1062, CCG1062P, CCG10652, CCG10652P, CCG10653, CCG1081, CCG1081P, CCG1082, CCG1082P, CCG1085, CCG10852, CCG1085P, CCG6045, CCG7001, CCG7001P, CCG7020, CCG7020P, CCG7021, CCG7021P, CCG7022, CCG7022P, CCG7040, CCG7040P, CCG7041, CCG7041P, CCG7042...(Otros modelos se puede ver en la tienda web)			
accesorios para	104108			
	código	102382	referencia	—
tuerca rosca M14x1 H 3.5mm EC 18 latón UE 1 pzs				
	código	104105	referencia	0100206 0100301 SI0100301 SIR0100206 SIR0100301
parte inferior de quemador para ø de tapa de quemador 80mm 3.5kW				
	código	104107	referencia	0100207 0100302 SI0100302 SIR0100207 SIR0100302
parte inferior de quemador para ø de tapa de quemador 100mm 6.4kW				

boquillas de gas

inyectores principales

boquillas de gas M7x1

			
código	100976	referencia	0101052 SIR0101052
descripción	boquilla de gas rosca M7x1 EC 10 taladro ø 0.7mm		
Para modelos:	CCG6020, CCG6040, CCG6045, CCG6046		



			
1			
código	100517	referencia	0101043 SIR0101043
descripción	boquilla de gas rosca M7x1 EC 10 taladro ø 0.8mm		
Para modelos:	CCG6020, CCG6040, CCG6045, CCG6046		

			
1			
código	100519	referencia	0101044 SIR0101044
descripción	boquilla de gas rosca M7x1 EC 10 taladro ø 0.95mm		
Para modelos:	CCG6020, CCG6040, CCG6045, CCG6046		

			
1			
código	104547	referencia	0101059 SIR0101059
descripción	boquilla de gas rosca M7x1 EC 10 taladro ø 1.25mm		
Para modelos:	CCG6020, CCG6040, CCG6045, CCG6046		

			
1			
código	100520	referencia	0101029 SIR0101029
descripción	boquilla de gas rosca M7x1 EC 10 taladro ø 1.2mm		

			
1			
código	100523	referencia	0101038 SIR0101038
descripción	boquilla de gas rosca M7x1 EC 10 taladro ø 1.4mm		

			
1			
código	104548	referencia	0101058 SIR0101058
descripción	boquilla de gas rosca M7x1 EC 10 taladro ø 1.5mm		
Para modelos:	CCG6020, CCG6040, CCG6045, CCG6046		

boquillas de gas M9x1

			
1			
código	100500	referencia	0100917 SIR0100917
descripción	boquilla de gas rosca M9x1 EC 10 taladro ø 0.85mm		

			
1			
código	100501	referencia	0100918 SIR0100918
descripción	boquilla de gas rosca M9x1 EC 10 taladro ø 0.95mm		

			
1			
código	100504	referencia	0100912 SIR0100912
descripción	boquilla de gas rosca M9x1 EC 10 taladro ø 1.15mm		

			
1			
código	100507	referencia	0100940 SIR0100940
descripción	boquilla de gas rosca M9x1 EC 10 taladro ø 1.35mm		

			
1			
código	100508	referencia	0100921 SIR0100921
descripción	boquilla de gas rosca M9x1 EC 10 taladro ø 1.45mm		



			
1			
código	100510	referencia	0100922 SIR0100922
descripción	boquilla de gas rosca M9x1 EC 10 taladro ø 1.8mm		

			
1			
código	100502	referencia	0100919 SIR0100919
descripción	boquilla de gas rosca M9x1 EC 10 taladro ø 1mm		

boquillas de gas M 10x1

			
1			
código	100635	referencia	0100933 0100955 SI0100955 SIR0100955
descripción	boquilla de gas rosca M10x1 EC 11 taladro ø 0.85mm interior puntiagudo		
Para modelos:	CBG7050, CBG7050C, SG74IRM		

			
1			
código	100646	referencia	0100971 SIR0100971
descripción	boquilla de gas rosca M10x1 EC 11 taladro ø 1.2mm interior puntiagudo		

			
1			
código	100641	referencia	0100953 SIR0100953
descripción	boquilla de gas rosca M10x1 EC 11 taladro ø 1.35mm interior puntiagudo		
Para modelos:	CBG7050, CBG7050C, CPD90100, CPD90100A, CPD90100AP, CPD90100A-P, CPD90100P, CPD90150, CPD90150A, CPD90150AP, CPD90150A-P, CPD9015-P, CPI90100, CPI90100A, CPI90100AP, CPI90100A-P, CPI90100P, CPI90100-P, CPI90150, CPI90150A, CPI90150AP, CPI90150A-P, CPI90150P, CPI90150-P, PG9AD10, PG9AD15, PG9AI10, PG9AI15, PG9ND10, PG9ND15, PG9NI10, PG9NI15, SG74IRM		

			
1			
código	106306	referencia	0100987 0102029 SIR0100987 SIR0102029
descripción	boquilla de gas rosca M10x1 EC 11 taladro ø 1.45mm código 145		
Para modelos:	CCG9045P, CCG9046, CCG90652P, CCG90663, CCG9085P, CCG9085-P, CCG9145, CCG9145-1, CCG91652, CCG91652-1, CCG91653, CCG91653-1, CCG9185, CCG9185-1, CCG91852, CCG91852-1, CFS9050, CFS9052, CFS9055, CG94FPS, CG96FPS, CG98FPS, CCG9040, CCG9040C, CCG9040LR, CCG9040LRC, CCG9040R, CCG9040RC, CCG9041, CCG9041C, CCG9041LR, CCG9041LRC, CCG9041R, CG9041RC, CTT9045, CTT90652R, CTT90653R, CTT90663R, HG94FPS, HGY4FPS, TG94FPS, TG96FPS		

			
1			
código	100642	referencia	0102024 SI0102024 SIR0102024
descripción	boquilla de gas rosca M10x1 EC 11 taladro ø 1.4mm interior puntiagudo		
Para modelos:	CBG7050, CBG7050C, CCG7001, CCG7001P, CCG7201, CG76HPS, CG86HPS, PG8AD10, PG8AD15, PG8AI10, PG8AI15, PG8ND10, PG8ND15, PG8NI10, PG8NI15, SG74IRM		

			
1			
código	106595	referencia	CR0508730
descripción	boquilla de gas rosca M10x1 taladro ø 0.83mm L 30mm EC 12		
Para modelos:	EFG72108, EFG73208T		

			
1			
código	100150	referencia	1491100 MA1491100
descripción	boquilla de gas rosca M10x1 taladro ø 0.95mm L 30mm EC 12		
Para modelos:	EFG72108, EFG73208T		

			
1			
código	100670	referencia	1695400 MA1695400
descripción	boquilla de gas rosca M10x1 taladro ø 0.9mm L 30mm EC 12		
Para modelos:	EFG72108, EFG73208T		

			
1			
código	101974	referencia	2715400 MA2715400
descripción	boquilla de gas rosca M10x1 taladro ø 1.35mm L 30mm EC 12		
Para modelos:	BMG-40, BMG-60, CFG62110, CFG62210, EFG72108, EFG72115, EFG73208T, EFG74215, EFG92115, EFG92115S, EFG94215, EFG94215S, FG62T08, FG64T08		

1 componentes gas

			
1			
código	100156	referencia	1421700 MA1421700
descripción	boquilla de gas rosca M10x1 taladro ø 1.3mm L 30mm EC 12		
Para modelos:	EGL72, EGL74, EPG7D05, EPG7I08, ETG74		

			
1			
código	100155	referencia	2902500 MA2902500
descripción	boquilla de gas rosca M10x1 taladro ø 1.45mm L 30mm EC 12		
Para modelos:	BMG-40, BMG-60, ECG7-FG, ECG94F, ECG96F, ECG96H, ECG98F, EDG72128, EDG74228, EFG72108, EFG73208T, EFG92123K, EFG94223K, EPG7I05, EPG9D10, EPG9D10A, EPG9D15, EPG9D15A, EPG9I15, EPG9I15A, EPG9I10, EPG9I10A, EPGD05, ETG94F, ETG94FL, ETG96F, ETG96FC, ETG96FL		

			
1			
código	100816	referencia	2715300 MA2715300
descripción	boquilla de gas rosca M10x1 taladro ø 1.5mm EC 12		
Para modelos:	BMG-40, BMG-60, EFG72108, EFG73208T, EFG92123K, EFG94223K, EPG7D05, EPG7I08, ETG74, ETG94A, ETG94AL, ETG94F, ETG94FL, ETG94G, ETG94GL, ETG94T, ETG94TPL, ETG96F, ETG96FC, ETG96FL		

			
1			
código	100153	referencia	1631200 MA1631200
descripción	boquilla de gas rosca M10x1 taladro ø 1.6mm L 30mm EC 12		
Para modelos:	BMG-40, BMG-60, EC-MAXI-OVEN-GAS, EFG72108, EFG72110, EFG73208T, EFG73210, EFG92123K, EFG93210, EFG94223K, EPG7I05, EPGD05		

			
1			
código	106401	referencia	795800 MA795800
descripción	boquilla de gas rosca M10x1 taladro ø 2.2mm L 30mm EC 12		
Para modelos:	BMG-40, BMG-60, EFG72115, EFG74215, EFG92115, EFG92115S, EFG94215, EFG94215S, EGL72, EGL74, ETG74		

			
1			
código	102702	referencia	0101027 SIR0101027
descripción	boquilla de gas rosca M10x1 EC 11 taladro ø 0.85mm		
Para modelos:	CCG6020, CCG6040, CCG6045, CCG6046		

			
1			
código	102705	referencia	0102011 SIR0102011
descripción	boquilla de gas rosca M10x1 EC 11 taladro ø 0.8mm		
Para modelos:	CCG7001, CCG7020, CCG7021, CCG7022, CCG7040, CCG7041, CCG7042, CCG7045, CCG7046, CCG7061, CCG7062, CCG70652, CCG70653, CCG70663, CCG7201, CCG7220, CCG7221, CCG7222, CCG7240, CCG7241, CCG7242, CCG7245, CCG7246, CCG7261, CCG7262, CCG72652, CCG72653, CCG72662, CCG72663, CCG9020, CCG9021, CCG9022, CCG9040, CCG9041, CCG9042, CCG9046, CCG9060, CCG9061, CCG9062, CCG90663, CCG9081, CCG9082, CCG9140, CCG9141, CCG9142, CCG9145, CCG9146, CCG9160, CCG9161, CCG9162...(Otros modelos se puede ver en la tienda web)		

			
1			
código	100420	referencia	0100909 0102013 SIR0100909 SIR0102013
descripción	boquilla de gas rosca M10x1 EC 11 taladro ø 0.95mm		
Para modelos:	CCG1041, CCG1041P, CCG1042, CCG1042P, CCG1045, CCG1045P, CCG1061, CCG1061P, CCG1062, CCG1062P, CCG10652, CCG10652P, CCG10653, CCG1081, CCG1081P, CCG1082, CCG1082P, CCG1085, CCG10852, CCG1085P, CCG6045, CCG7001P, CCG7020P, CCG7021P, CCG7022P, CCG7040P, CCG7041P, CCG7042P, CCG7045P, CCG7046P, CCG7061P, CCG7062P, CCG70652P, CCG70662P, CCG7201, CCG7220, CCG7221, CCG7222, CCG7240, CCG7241, CCG7242, CCG7245, CCG7246, CCG7261, CCG7262, CCG72652, CCG72653, CCG72662, CCG72663, CCG9020...(Otros modelos se puede ver en la tienda web)		

			
1			
código	106295	referencia	0102010 SIO102010 SIR0102010
descripción	boquilla de gas rosca M10x1 EC 11 taladro ø 0.9mm código 90		
Para modelos:	CCG7001, CCG7001P, CCG7020, CCG7020P, CCG7021, CCG7021P, CCG7022, CCG7022P, CCG7040, CCG7040P, CCG7041, CCG7041P, CCG7042, CCG7042P, CCG7045, CCG7045P, CCG7046, CCG7046P, CCG7061, CCG7061P, CCG7062, CCG7062P, CCG70652, CCG70652P, CCG70653, CCG70662P, CCG70663, CCG7201, CCG7220, CCG7221, CCG7222, CCG7240, CCG7241, CCG7242, CCG7245, CCG7246, CCG7261, CCG7262, CCG72652, CCG72653, CCG72662, CCG72663, CCG9020, CCG9021, CCG9022, CCG9040, CCG9040P, CCG9041, CCG9041P, CCG9042...(Otros modelos se puede ver en la tienda web)		





			
1			
código	106494	referencia	0100944 SIR0100944
descripción	boquilla de gas rosca M10x1 EC 11 taladro ø 1.05mm		
Para modelos:	BG72GLC, BG72GLL, BG72GRR, BG72TLC, BG72TLL, BG72TRR, BG74GLC, BG74GLL, BG74GLR, BG74GMC, BG74GRR, BG74TLC, BG74TLL, BG74TLR, BG74TMC, BG74TRR, CGG7020, CGG7020C, CGG7020R, CGG7021, CGG7021C, CGG7021R, CGG7040, CGG7040C, CGG7040LR, CGG7040LRC, CGG7040R, CGG7041, CGG7041C, CGG7041LR, CGG7041LRC, CGG7041R, CGG7220R, CGG7221, CGG7221C, CGG7240, CGG7240C, CGG7240LR, CGG7240LRC, CGG7240R, CGG7241, CGG7241LR, CGG7241R		

			
1			
código	102704	referencia	0101034 SIO101034 SIR0101034
descripción	boquilla de gas rosca M10x1 EC 11 taladro ø 1.2mm		
Para modelos:	BG72ALL, BG72ARR, BG72GLC, BG72GLL, BG72GRR, BG72TLC, BG72TLL, BG72TRR, BG74ALL, BG74ALR, BG74ARC, BG74GLC, BG74GLL, BG74GLR, BG74GMC, BG74GRR, BG74TLC, BG74TLL, BG74TLR, BG74TMC, BG74TRR, BG92ALC, BG92ALL, BG92ARC, BG92ARR, BG92GLC, BG92GLL, BG92GRC, BG92GRR, BG94ALC, BG94ALL, BG94ALR, BG94AMC, BG94ARC, BG94ARR, BG94GLC, BG94GLL, BG94GLR, BG94GMC, BG94GRC, BG94GRR, BGY2TLC, BGY2TLL, BGY2TRC, BGY2TRR, BGY4TLC, BGY4TLL, BGY4TLR, BGY4TMC, BGY4TRC... (Otros modelos se puede ver en la tienda web)		

			
2			
código	106285	referencia	0100907 SIO100907 SIR0100907
descripción	boquilla de gas rosca M10x1 EC 11 taladro ø 1.15mm		
Para modelos:	BG94ALC, BG94ALL, BG94ALR, BG94AMC, BG94ARC, BG94ARR, BG94GLC, BG94GLL, BG94GLR, BG94GMC, BG94GRC, BG94GRR, BGY4TLC, BGY4TLL, BGY4TLR, BGY4TMC, BGY4TRC, BGY4TRR, CCG1041, CCG1041P, CCG1042, CCG1042P, CCG1045, CCG1045P, CCG1061, CCG1061P, CCG1062, CCG1062P, CCG10652, CCG10652P, CCG10653, CCG1081, CCG1081P, CCG1082, CCG1082P, CCG1085, CCG1085P, CCG7001, CCG7001P, CCG7020, CCG7020P, CCG7021, CCG7021P, CCG7022, CCG7022P, CCG7040, CCG7040P, CCG7041, CCG7041P... (Otros modelos se puede ver en la tienda web)		

			
1			
código	106296	referencia	0101019 SIO101019 SIR0101019
descripción	boquilla de gas rosca M10x1 EC 11 taladro ø 1.3mm código 130		
Para modelos:	BG92ALC, BG92ALL, BG92ARC, BG92ARR, BG92GLC, BG92GLL, BG92GRC, BG92GRR, BGY2TLC, BGY2TLL, BGY2TRC, BGY2TRR, CCG1041, CCG1041P, CCG1042, CCG1042P, CCG1045, CCG1045P, CCG1061, CCG1061P, CCG1062, CCG1062P, CCG10652, CCG10652P, CCG10653, CCG1081, CCG1081P, CCG1082, CCG1082P, CCG1085, CCG1085P, CCG10852, CCG1085P, CCG9020, CCG9020P, CCG9021, CCG9021P, CCG9022, CCG9022P, CCG9040, CCG9040P, CCG9041, CCG9041P, CCG9042, CCG9042P, CCG9045P, CCG9046, CCG9046P, CCG9060, CCG9060P, CCG9061... (Otros modelos se puede ver en la tienda web)		

			
1			
código	106490	referencia	0109074 SIR0109074
descripción	boquilla de gas rosca M10x1 EC 11 taladro ø 1.25mm		
Para modelos:	BG92ALC, BG92ALL, BG92ARC, BG92ARR, BG92GLC, BG92GLL, BG92GRC, BG92GRR, BG94ALC, BG94ALL, BG94ALR, BG94AMC, BG94ARC, BG94ARR, BG94GLC, BG94GLL, BG94GLR, BG94GMC, BG94GRC, BG94GRR, BGY2TLC, BGY2TLL, BGY2TRC, BGY2TRR, BGY4TLC, BGY4TLL, BGY4TLR, BGY4TMC, BGY4TRC, BGY4TRR, CGG6030, CGG6030C, CGG6030R, CGG9020-0, CGG9020-1, CGG9020-2, CGG9020-3, CGG9021-0, CGG9021-1, CGG9021-2, CGG9021-3, CGG9022-0, CGG9022-1, CGG9022-2, CGG9022-3, CGG9040-0, CGG9040-1, CGG9040-2, CGG9040-3, CGG9040-4... (Otros modelos se puede ver en la tienda web)		

			
1			
código	102774	referencia	0100905 SIO100905 SIR0100905
descripción	boquilla de gas rosca M10x1 EC 11 taladro ø 1.45mm		
Para modelos:	CCG7001, CCG7020, CCG7021, CCG7022, CCG7040, CCG7041, CCG7042, CCG7045, CCG7046, CCG7061, CCG7062, CCG70652, CCG70653, CCG70663, CCG7201, CCG7220, CCG7221, CCG7222, CCG7240, CCG7241, CCG7242, CCG7245, CCG7246, CCG7261, CCG7262, CCG72652, CCG72653, CCG72662, CCG72663, CCG9020, CCG9021, CCG9022, CCG9040, CCG9041, CCG9042, CCG9046, CCG9060, CCG9061, CCG9062, CCG90663, CCG9081, CCG9082, CCG9140, CCG9141, CCG9142, CCG9145, CCG9146, CCG9160, CCG9161, CCG9162... (Otros modelos se puede ver en la tienda web)		

			
1			
código	102706	referencia	0101054 SIR0101054
descripción	boquilla de gas rosca M10x1 EC 11 taladro ø 1.55mm		
Para modelos:	CCG6020, CCG6040, CCG6045, CCG6046		

			
1			
código	102773	referencia	0101046 SIR0101046
descripción	boquilla de gas rosca M10x1 EC 11 taladro ø 1.65mm G20-25		
Para modelos:	CTT652L, CTT653L, CTT7040, CTT7040L, CTT7040R, CTT7041, CTT7041L, CTT7041R, CTT7042, CTT7042L, CTT7042R, CTT7045L, CTT7045R, CTT70652, CTT70652L, CTT70653, CTT70653L, TG74APL, TG74APR, TG74FPL, TG74GPL, TG74GPR, TG74TPL, TG74TPR, TG76FPC		

			
1			
código	106493	referencia	0100932 SIO100932 SIR0100932
descripción	boquilla de gas rosca M10x1 EC 11 taladro ø 1.75mm		
Para modelos:	CCG1041P, CCG1042P, CCG1045P, CCG1061P, CCG1062P, CCG10652P, CCG1081P, CCG1082P, CCG1085P, CCG7001P, CCG7020P, CCG7021P, CCG7022P, CCG7040P, CCG7041P, CCG7042P, CCG7045P, CCG7046P, CCG7061P, CCG7062P, CCG70652P, CCG70662P, CCG9020P, CCG9021P, CCG9022P, CCG9040P, CCG9041P, CCG9042P, CCG9045P, CCG9046P, CCG9060P, CCG9061P, CCG9062P, CCG90652P, CCG90662P, CCG9081P, CCG9082P, CCG9085P, CCG9085-P, CG72APS, CG72GPS, CG72TPS, CG74APS, CG74EPS, CG74FPS, CG74GPS, CG74TPS, CG76APS, CG76EPS, CG76FPS...(Otros modelos se puede ver en la tienda web)		

			
1			
código	106440	referencia	0100906 SIR0100906
descripción	boquilla de gas rosca M10x1 EC 11 taladro ø 1.85mm		
Para modelos:	CCG1041, CCG1042, CCG1045, CCG1061, CCG1062, CCG10652, CCG10653, CCG1081, CCG1082, CCG1085, CCG10852, CCG7001, CCG7020, CCG7021, CCG7022, CCG7040, CCG7041, CCG7042, CCG7045, CCG7046, CCG7061, CCG7062, CCG70652, CCG70653, CCG70663, CCG7201, CCG7220, CCG7221, CCG7222, CCG7240, CCG7241, CCG7242, CCG7245, CCG7246, CCG7261, CCG7262, CCG72652, CCG72653, CCG72662, CCG72663, CCG9020, CCG9021, CCG9022, CCG9040, CCG9041, CCG9042, CCG9046, CCG9060, CCG9061, CCG9062...(Otros modelos se puede ver en la tienda web)		

			
1			
código	102984	referencia	0102012 SIR0102012
descripción	boquilla de gas rosca M10x1 EC 11 taladro ø 1.8mm		
Para modelos:	CCG1041, CCG1041P, CCG1042, CCG1042P, CCG1045, CCG1045P, CCG1061, CCG1061P, CCG1062, CCG1062P, CCG10652, CCG10652P, CCG10653, CCG1081, CCG1081P, CCG1082, CCG1082P, CCG1085, CCG10852, CCG1085P, CCG6045, CCG7001, CCG7001P, CCG7020, CCG7020P, CCG7021, CCG7021P, CCG7022, CCG7022P, CCG7040, CCG7040P, CCG7041, CCG7041P, CCG7042, CCG7042P, CCG7045, CCG7045P, CCG7046, CCG7046P, CCG7061, CCG7061P, CCG7062, CCG7062P, CCG70652, CCG70652P, CCG70653, CCG70662P, CCG70663, CCG7201, CCG7220...(Otros modelos se puede ver en la tienda web)		

			
1			
código	106498	referencia	0109075 SIR0109075
descripción	boquilla de gas rosca M10x1 EC 11 taladro ø 1.95mm		
Para modelos:	BG72GLC, BG72GLL, BG72GRR, BG72TLC, BG72TLL, BG72TRR, BG74GLC, BG74GLL, BG74GLR, BG74GMC, BG74GRR, BG74TLC, BG74TLL, BG74TLR, BG74TMC, BG74TRR, CCG6045, CGE6020, CGE6020R, CCG6020, CCG6020C, CCG6020R, CCG6040, CCG6040C, CCG6040R, CCG7020, CCG7020C, CCG7020R, CCG7021, CCG7021C, CCG7021R, CCG7040, CCG7040C, CCG7040LR, CCG7040LRC, CCG7040R, CCG7041, CCG7041C, CCG7041LR, CCG7041LRC, CCG7041R, CCG7220R, CCG7221, CCG7221C, CCG7240, CCG7240C, CCG7240LR, CCG7240LRC, CCG7240R, CCG7241...(Otros modelos se puede ver en la tienda web)		

			
1			
código	102703	referencia	0102030 SIO102030 SIR0102030
descripción	boquilla de gas rosca M10x1 EC 11 taladro ø 1.9mm		
Para modelos:	BG72GLC, BG72GLL, BG72GRR, BG72TLC, BG72TLL, BG72TRR, BG74GLC, BG74GLL, BG74GLR, BG74GMC, BG74GRR, BG74TLC, BG74TLL, BG74TLR, BG74TMC, BG74TRR, CCG1041P, CCG1042P, CCG1045P, CCG1061P, CCG1062P, CCG10652P, CCG1081P, CCG1082P, CCG1085P, CCG7001P, CCG7020P, CCG7021P, CCG7022P, CCG7040P, CCG7041P, CCG7042P, CCG7045P, CCG7046P, CCG7061P, CCG7062P, CCG70652P, CCG70662P, CCG9020P, CCG9021P, CCG9022P, CCG9040P, CCG9041P, CCG9042P, CCG9045P, CCG9046P, CCG9060P, CCG9061P, CCG9062P, CCG90652P...(Otros modelos se puede ver en la tienda web)		

			
1			
código	106284	referencia	0101012 SIO101012 SIR0101012
descripción	boquilla de gas rosca M10x1 EC 11 taladro ø 2.15mm		
Para modelos:	CCG7045P, CCG70652P, CCG7245, CCG72652, CCG72653, CG74FPS, CG76FPS, CG84FPS, CG86FPS, CG88APS, CG88FPS, CG88GPS, CTT7045, CTT7045L, CTT7045R, CTT70652, CTT70652L, CTT72653, CTT72653L, TG74FPL, TG74FPR, TG74FPS, TG76FPC, TG76FPS, TG84FPS		

			
1			
código	106495	referencia	0101021 SIR0101021
descripción	boquilla de gas rosca M10x1 EC 11 taladro ø 2.25mm		
Para modelos:	BG94ALC, BG94ALL, BG94ALR, BG94AMC, BG94ARC, BG94ARR, BG94GLC, BG94GLL, BG94GLR, BG94GMC, BG94GRC, BG94GRR, BGY4TLC, BGY4TLL, BGY4TLR, BGY4TMC, BGY4TRC, BGY4TRR, CCG6030, CCG6030C, CCG6030R, CCG9040-0, CCG9040-1, CCG9040-2, CCG9040-3, CCG9040-4, CCG9040-5, CCG9041-0, CCG9041-1, CCG9041-2, CCG9041-3, CCG9041-4, CCG9041-5, CCG9042-0, CCG9042-1, CCG9042-2, CCG9042-3, CCG9042-4, CCG9042-5		



			
1			
código	106496	referencia	0102014 SIR0102014
descripción	boquilla de gas rosca M10x1 EC 11 taladro ø 2.2mm		
Para modelos:	CCG1041, CCG1041P, CCG1042, CCG1042P, CCG1045, CCG1045P, CCG1061, CCG1061P, CCG1062, CCG1062P, CCG10652, CCG10652P, CCG10653, CCG1081, CCG1081P, CCG1082, CCG1082P, CCG1085, CCG10852, CCG1085P, CCG7045P, CCG70652P, CCG7245, CCG72652, CCG72653, CCG9020, CCG9020P, CCG9021, CCG9021P, CCG9022, CCG9022P, CCG9040, CCG9040P, CCG9041, CCG9041P, CCG9042, CCG9042P, CCG9045P, CCG9046, CCG9046P, CCG9060, CCG9060P, CCG9061, CCG9061P, CCG9062, CCG9062P, CCG90652P, CCG90662P, CCG90663, CCG9081...(Otros modelos se puede ver en la tienda web)		

			
1			
código	100472	referencia	0100931 522111 MA522111 SIR0100931
descripción	boquilla de gas rosca M10x1 EC 12 taladro ø 1.4mm		
Para modelos:	CCG7001P, CCG7020P, CCG7021P, CCG7022P, CCG7040P, CCG7041P, CCG7042P, CCG7045P, CCG7046P, CCG7061P, CCG7062P, CCG70652P, CCG70662P, CCG7245, CCG72652, CCG72653, CCG9040P, CCG9041P, CCG9042P, CCG9045P, CCG9046P, CCG9060P, CCG9061P, CCG9062P, CCG90652P, CCG90662P, CCG9081P, CCG9082P, CCG9085P, CCG9085-P, CG72APS, CG72GPS, CG72TPS, CG74APS, CG74EPS, CG74FPS, CG74G-PS, CG74TPS, CG76APS, CG76EPS, CG76FPS, CG76GPS, CG76HPS, CG84APS, CG84EPS, CG84FPS, CG84GPS, CG84TPS, CG86APS, CG86F-PS...(Otros modelos se puede ver en la tienda web)		

			
1			
código	100794	referencia	0101036 SIR0101036
descripción	boquilla de gas rosca M10x1 EC 11 taladro ø 2.35mm gas natural presión de gas 20mbar		
Para modelos:	CCG7045P, CCG70652P, CCG7245, CCG72652, CCG72653, CG74F-PS, CG76FPS, CG84FPS, CG86FPS, CG88APS, CG88FPS, CG88GPS, CTT7045, CTT7045L, CTT7045R, CTT70652, CTT70652L, CTT72653, CTT72653L, TG74FPL, TG74FPR, TG74FPS, TG76FPC, TG76FPS, TG84FPS		

			
1			
código	100484	referencia	523411 MA523411
descripción	boquilla de gas rosca M10x1 EC 12 taladro ø 2.05mm		
Para modelos:	CRG6220, CRG6240, EVGV7, GG62TGP, GG64TGP		

			
1			
código	106497	referencia	0109073 SIR0109073
descripción	boquilla de gas rosca M10x1 EC 11 taladro ø 2.4mm		
Para modelos:	CGG6030, CGG6030C, CGG6030R, CNG90140, CNG90140-S, CNG90240, DG92140, DG94240		

			
1			
código	100485	referencia	523711 MA523711
descripción	boquilla de gas rosca M10x1 EC 12 taladro ø 2.2mm		
Para modelos:	CRG6220, CRG6240, EBG7, EBG92AL, EBG92AR, EBG92GL, EBG92GR, EBG92TL, EBG92TR, EBG93AL, EBG93ALR, EBG93GL, EBG93GLR, EBG93TL, EBG93TLR, EBG94AL, EBG94ALR, EBG94AR, EBG94GL, EBG94GLR, EBG94GR, EBG94TL, EBG94TLR, EBG94TR, EVGV7, GG62TGP, GG64TGP		

			
1			
código	100469	referencia	0105133 521611 MA521611 SIR0105133
descripción	boquilla de gas rosca M10x1 EC 12 taladro ø 1.15mm		
Para modelos:	CCG6245-1, CCG62652-1, CG64FPS, CG66FPS, CRG6220, CRG6240, EBG7, EBG92AL, EBG92AR, EBG92GL, EBG92GR, EBG92TL, EBG92TR, EBG93AL, EBG93ALR, EBG93GL, EBG93GLR, EBG93TL, EBG93TLR, EBG94AL, EBG94ALR, EBG94AR, EBG94GL, EBG94GLR, EBG94GR, EBG94TL, EBG94TLR, EBG94TR, ECG7, FG82122, FG84222, FG92122, FG94222, FGY2122, FGY4222, GG62TGP, GG64TGP		

			
1			
código	100489	referencia	CR0586800
descripción	boquilla de gas rosca M10x1 EC 12 taladro ø 2.6mm		
Para modelos:	ECG92A, ECG92G, ECG92T, ECG94A, ECG94E, ECG94F, ECG94G, ECG94T, ECG96A, ECG96E, ECG96F, ECG96G, ECG96H, ECG96T, ECG98A, ECG98F, ECG98G		



código	100483	referencia	523311 MA523311
descripción	boquilla de gas rosca M10x1 EC 12 taladro ø 2mm		
Para modelos:	EBG7, EBG92AL, EBG92AR, EBG92GL, EBG92GR, EBG92TL, EBG92TR, EBG93AL, EBG93ALR, EBG93GL, EBG93GLR, EBG93TL, EBG93TLR, EBG94AL, EBG94ALR, EBG94AR, EBG94GL, EBG94GLR, EBG94GR, EBG94TL, EBG94TLR, EBG94TR		



código	102819	referencia	0102034 SIR0102034
descripción	boquilla de gas rosca M10x1 EC 12 taladro ø 1.1mm		
Para modelos:	CCG6045, CGE6020, CGE6020R, CGG6020, CGG6020C, CGG6020R, CGG6040, CGG6040C, CGG6040R		

boquillas piloto

boquillas piloto POLIDORO



código	100209	referencia	0101048 SIO101048 SIR0101048
descripción	boquilla de quemador piloto POLIDORO gas natural código 40 taladro ø 0.4mm UE 1 pzs		
Para modelos:	CCG1045, CCG1045P, CCG10652, CCG10652P, CCG10653, CCG1085, CCG10852, CCG1085P, CCG7001, CCG7001P, CCG7201, CCG9045P, CCG9046, CCG90652P, CCG90663, CCG9085P, CCG9085-P, CCG9145, CCG9145-1, CCG91652, CCG91652-1, CCG91653, CCG91653-1, CCG9185, CCG9185-1, CCG91852, CCG91852-1, CFS9050, CFS9052, CFS9055, CG76HPS, CG86HPS, CG94FPS, CG96FPS, CG98FPS, CGG9020, CGG9020C, CGG9020R, CGG9020RC, CGG9021, CGG9021C, CGG9021R, CGG9021RC, CGG9040, CGG9040C, CGG9040LR, CGG9040LRC, CGG9040R, CGG9040RC, CGG9041...(Otros modelos se puede ver en la tienda web)		

boquillas piloto SIT

serie 100



código	100245	referencia	0100829 1415100 MA1415100 SIR0100829
descripción	boquilla de quemador piloto gas licuado código 20 taladro ø 0.2mm UE 1 pzs rosca M8x0,75		
Para modelos:	BG92ALC, BG92ALL, BG92ARC, BG92ARR, BG92GLC, BG92GLL, BG92GRC, BG92GRR, BG94ALC, BG94ALL, BG94ALR, BG94AMC, BG94ARC, BG94ARR, BG94GLC, BG94GLL, BG94GLR, BG94GMC, BG94GRC, BG94GRR, BGY2TLC, BGY2TLL, BGY2TRC, BGY2TRR, BGY4TLC, BGY4TLL, BGY4TLR, BGY4TMC, BGY4TRC, BGY4TRR, CBG7050, CBG7050C, CBG9060CP, CBG9060P, CCG1041P, CCG1042P, CCG1045P, CCG1061P, CCG1062P, CCG10652P, CCG1081P, CCG1082P, CCG1085P, CCG6045, CCG7001P, CCG7020P, CCG7021P, CCG7022P, CCG7040P, CCG7041P...(Otros modelos se puede ver en la tienda web)		



código	102972	referencia	0100823 1996200 CR0684580 MA1996200 SIR0100823
descripción	boquilla de quemador piloto gas natural código 40 taladro ø 0.4mm UE 1 pzs		
Para modelos:	BG92ALC, BG92ALL, BG92ARC, BG92ARR, BG92GLC, BG92GLL, BG92GRC, BG92GRR, BG94ALC, BG94ALL, BG94ALR, BG94AMC, BG94ARC, BG94ARR, BG94GLC, BG94GLL, BG94GLR, BG94GMC, BG94GRC, BG94GRR, BGY2TLC, BGY2TLL, BGY2TRC, BGY2TRR, BGY4TLC, BGY4TLL, BGY4TLR, BGY4TMC, BGY4TRC, BGY4TRR, CBG7050, CBG7050C, CBG9060CP, CBG9060P, CCG6045, CCG7045P, CCG70652P, CCG7245, CCG72652, CCG72653, CG74FPS, CG76FPS, CG84FPS, CG86FPS, CG88APS, CG88FPS, CG88GFS, CGG9020-0, CGG9020-1, CGG9020-2...(Otros modelos se puede ver en la tienda web)		



código	107171	referencia	0101153 0105143 1842300 MA1842300 SIR0101153 SIR0105143
descripción	boquilla de quemador piloto SIT gas natural/licuado taladro ø 0.25mm UE 1 pzs		
Para modelos:	CCG1041P, CCG1042P, CCG1045P, CCG1061P, CCG1062P, CCG10652P, CCG1081P, CCG1082P, CCG1085P, CCG7001P, CCG7020P, CCG7021P, CCG7022P, CCG7040P, CCG7041P, CCG7042P, CCG7045P, CCG7046P, CCG7061P, CCG7062P, CCG70652P, CCG70662P, CCG9020P, CCG9021P, CCG9022P, CCG9040P, CCG9041P, CCG9042P, CCG9045P, CCG9046P, CCG9060P, CCG9061P, CCG9062P, CCG90652P, CCG90662P, CCG9081P, CCG9082P, CCG9085P, CCG9085-P, CG72APS, CG72GPS, CG72TPS, CG74APS, CG74EPS, CG74FPS, CG74GPS, CG74TPS, CG76APS, CG76EPS, CG76FPS...(Otros modelos se puede ver en la tienda web)		

serie 140/150



código	100204	referencia	1888000 MA1888000
descripción	boquilla de quemador piloto SIT gas licuado código 14 taladro ø 0,18/0,20mm UE 1 pzs apto para serie 140		
Para modelos:	CRG6220, CRG6240, EBG7, EBG7-CROMO, EBG92AL, EBG92ALC, EBG92AR, EBG92ARC, EBG92GL, EBG92GLC, EBG92GR, EBG92GRC, EBG92TL, EBG92TLC, EBG92TR, EBG92TRC, EBG93AL, EBG93ALC, EBG93ALR, EBG93AMC, EBG93GL, EBG93GLC, EBG93GLR, EBG93GMC, EBG93TL, EBG93TLC, EBG93TLR, EBG93TMC, EBG94AL, EBG94ALC, EBG94ALR, EBG94AMC, EBG94AR, EBG94GL, EBG94GLC, EBG94GLR, EBG94GMC, EBG94GR, EBG94TL, EBG94TLC, EBG94TLR, EBG94TMC, EBG94TR, EDG73142, EGL72, EGL74, ESG74, ESG94CRA, ESG94CRM, ESG94FRA...(Otros modelos se puede ver en la tienda web)		



código	100205	referencia	1033722000 BN822140380 MA1033722000
descripción	boquilla de quemador piloto SIT gas licuado código 19 taladro ø 0.23/0.26mm UE 1 pzs apto para SIT serie 150		
Para modelos:	BG62TLC, BG62TLL, BG62TRR, BG63TLC, BG63TLL, BG63TLR, BG64TLC, BG64TLL, BG64TLR, CGG6220, CGG6220C, CGG6220R, CGG6230, CGG6230C, CGG6230LR, CGG6240, CGG6240C, CGG6240LR		



			
código	100207	referencia	1887800 MA1887800
descripción	boquilla de quemador piloto SIT gas natural código 27 taladro ø 0,40/0,38mm apto para SIT serie 140		
Para modelos:	BG62TLC, BG62TLL, BG62TRR, BG63TLC, BG63TLL, BG63TLR, BG64TLC, BG64TLL, BG64TLR, BG72ALL, BG72ARR, BG72GLL, BG72GRR, BG72TLL, BG72TRR, BG74ALL, BG74ALR, BG74ARC, BG74GLL, BG74GLR, BG74GRR, BG74TLL, BG74TLR, BG74TRR, CGG6220, CGG6220C, CGG6220R, CGG6230, CGG6230C, CGG6230LR, CGG6240, CGG6240C, CGG6240LR, CRG6220, CRG6240, EBG7, EBG7-CROMO, EBG92AL, EBG92ALC, EBG92AR, EBG92ARC, EBG92GL, EBG92GLC, EBG92GR, EBG92GRC, EBG92TL, EBG92TLC, EBG92TR, EBG92TRC, EBG93AL... (Otros modelos se puede ver en la tienda web)		

			
código	107650	referencia	0100802 CR0410100 SIR0100802
descripción	boquilla de quemador piloto SIT gas licuado código 30 UE 1 pzs		
Para modelos:	ECG7, ECG92A, ECG92G, ECG92T, ECG94A, ECG94E, ECG94F, ECG94G, ECG94T, ECG96A, ECG96E, ECG96F, ECG96G, ECG96H, ECG96T, ECG98A, ECG98F, ECG98G, EDG92142, EDG93142, EDG94242, EFG72108, EFG72110, EFG72115, EFG73208T, EFG73210, EFG74215, EFG92115, EFG92115S, EFG92123, EFG92123K, EFG93210, EFG94215, EFG94215S, EFG94223, EFG94223K, EPG9D10, EPG9D10A, EPG9D15, EPG9D15A, EPG9115, EPG9115A, EPG9110A, EPG9110A		

			
código	103288	referencia	1887900 MA1887900
descripción	boquilla de quemador piloto SIT gas natural código 50 taladro ø 0,50mm apto para serie 140		
Para modelos:	CRG6220, CRG6240, EDG73142, EGL72, EGL74, ETG74, ETG74GL-R, ETG94A, ETG94AL, ETG94F, ETG94FL, ETG94G, ETG94GL, ETG94T, ETG94TPL, ETG96F, ETG96FC, ETG96FL, GG62TGP, GG64TGP		

			
código	107174	referencia	0100803 1033719700 MA1033719700 SIR0100803
descripción	boquilla de quemador piloto SIT gas natural código 41 UE 1 pzs		
Para modelos:	CCG6220/1, CCG6230/1, CCG6245-1, CCG62652-1, CG62TPS, CG64FPS, CG64TPS, CG66FPS, ECG7-FG, ECG94F, ECG96F, ECG96H, ECG98F, EC-MAXI-OVEN-GAS, EDG92142, EDG93142, EDG94242, EFG72108, EFG72110, EFG72115, EFG73208T, EFG73210, EFG74215, EFG92115, EFG92115S, EFG92123, EFG92123K, EFG93210, EFG94215, EFG94215S, EFG94223, EFG94223K, EPG7D05, EPG7105, EPG7108, EPG9D10, EPG9D10A, EPG9D15, EPG9D15A, EPG9115, EPG9115A, EPG9110, EPG9110A, EPGD05, ETG94F, ETG94FL, ETG96F, ETG96FC, ETG96FL		

serie 160

			
código	107649	referencia	1033719600 MA1033719600
descripción	boquilla de quemador piloto SIT gas licuado código 20 UE 1 pzs		
Para modelos:	CCG6220/1, CCG6230/1, CCG6245-1, CCG62652-1, CG62TPS, CG64FPS, CG64TPS, CG66FPS, ECG7, ECG7-FG, ECG92A, ECG92G, ECG92T, ECG94A, ECG94E, ECG94F, ECG94G, ECG94T, ECG96A, ECG96E, ECG96F, ECG96G, ECG96H, ECG96T, ECG98A, ECG98F, ECG98G, EPG7D05, EPG7105, EPG7108, EPGD05, ETG94F, ETG94FL, ETG96F, ETG96FC, ETG96FL		

boquillas bypass

<p>boquillas bypass PEL20/21</p> 			
código	100554	referencia	0102059 BN6A023722 SIR0102059
descripción	boquilla bypass tipo PEL20/21 taladro ø 0.45mm rosca M5x0,5		

			
código	107172	referencia	1874700 MA1874700
descripción	boquilla de quemador piloto SIT gas licuado código 25 UE 1 pzs		
Para modelos:	ECG7-FG, ECG94F, ECG96F, ECG96H, ECG98F, EC-MAXI-OVEN-GAS, EDG92142, EDG93142, EDG94242, EFG72108, EFG72110, EFG72115, EFG73208T, EFG73210, EFG74215, EFG92115, EFG92115S, EFG92123, EFG92123K, EFG93210, EFG94215, EFG94215S, EFG94223, EFG94223K, EPG7D05, EPG7105, EPG7108, EPG9D10, EPG9D10A, EPG9D15, EPG9D15A, EPG9115, EPG9115A, EPG9110, EPG9110A, EPGD05, ETG94F, ETG94FL, ETG96F, ETG96FC, ETG96FL		

			
código	100548	referencia	CR0586840
descripción	boquilla bypass tipo PEL20/21 taladro ø 0.65mm rosca M5x0,5		
Para modelos:	ECG7, ECG92A, ECG92G, ECG92T, ECG94A, ECG94E, ECG94F, ECG94G, ECG94T, ECG96A, ECG96E, ECG96F, ECG96G, ECG96H, ECG96T, ECG98A, ECG98F, ECG98G		



código	100551	referencia	0102063 BN41822450520 SIRO102063
descripción	boquilla bypass tipo PEL20/21 taladro ø 0.6mm rosca M5x0,5		
Para modelos:	CCG1041, CCG1041P, CCG1042, CCG1042P, CCG1045, CCG1045P, CCG1061, CCG1061P, CCG1062, CCG1062P, CCG10652, CCG10652P, CCG10653, CCG1081, CCG1081P, CCG1082, CCG1082P, CCG1085, CCG10852, CCG1085P, CCG7001, CCG7001P, CCG7020, CCG7020P, CCG7021, CCG7021P, CCG7022, CCG7022P, CCG7040, CCG7040P, CCG7041, CCG7041P, CCG7042, CCG7042P, CCG7045, CCG7045P, CCG7046, CCG7046P, CCG7061, CCG7061P, CCG7062, CCG7062P, CCG70652, CCG70652P, CCG70653, CCG70662P, CCG70663, CCG7201, CCG7220, CCG7221...(Otros modelos se puede ver en la tienda web)		



código	100552	referencia	0102067 1884200 MA1884200 SIRO102067
descripción	boquilla bypass tipo PEL20/21 taladro ø 0.7mm rosca M5x0,5		
Para modelos:	CCG1041, CCG1041P, CCG1042, CCG1042P, CCG1045, CCG1045P, CCG1061, CCG1061P, CCG1062, CCG1062P, CCG10652, CCG10652P, CCG10653, CCG1081, CCG1081P, CCG1082, CCG1082P, CCG1085, CCG10852, CCG1085P, CCG6245-1, CCG62652-1, CCG7001, CCG7020, CCG7021, CCG7022, CCG7040, CCG7041, CCG7042, CCG7045, CCG7046, CCG7061, CCG7062, CCG70652, CCG70653, CCG70663, CCG7201, CCG7220, CCG7221, CCG7222, CCG7240, CCG7241, CCG7242, CCG7245, CCG7246, CCG7261, CCG7262, CCG72652, CCG72653, CCG72662...(Otros modelos se puede ver en la tienda web)		



código	100528	referencia	1033720200 1889000 MA1033720200 MA1889000
descripción	boquilla bypass tipo PEL20/21 taladro ø 0.9mm rosca M5x0,5		
Para modelos:	CCG6245-1, CCG62652-1, CG64FPS, CG66FPS, CRG6220, CRG6240, ECG7, ECG92A, ECG92G, ECG92T, ECG94A, ECG94E, ECG94F, ECG94G, ECG94T, ECG96A, ECG96E, ECG96F, ECG96G, ECG96H, ECG96T, ECG98A, ECG98F, ECG98G, EGL72, EGL74, GG62TGP, GG64TGP		



código	100530	referencia	0102061 SI0102061 SIRO102061
descripción	boquilla bypass tipo PEL20/21 taladro ø 1.1mm rosca M5x0,5		
Para modelos:	CCG1041, CCG1042, CCG1045, CCG1061, CCG1062, CCG10652, CCG10653, CCG1081, CCG1082, CCG1085, CCG10852, CCG7001, CCG7020, CCG7021, CCG7022, CCG7040, CCG7041, CCG7042, CCG7045, CCG7046, CCG7061, CCG7062, CCG70652, CCG70653, CCG70663, CCG7201, CCG7220, CCG7221, CCG7222, CCG7240, CCG7241, CCG7242, CCG7245, CCG7246, CCG7261, CCG7262, CCG72652, CCG72653, CCG72662, CCG72663, CCG9020, CCG9021, CCG9022, CCG9040, CCG9041, CCG9042, CCG9046, CCG9060, CCG9061, CCG9062...(Otros modelos se puede ver en la tienda web)		



código	100532	referencia	0102065 SIRO102065
descripción	boquilla bypass tipo PEL20/21 taladro ø 1.2mm rosca M5x0,5		
Para modelos:	CCG1041, CCG1042, CCG1045, CCG1061, CCG1062, CCG10652, CCG10653, CCG1081, CCG1082, CCG1085, CCG10852, CCG7001, CCG7020, CCG7021, CCG7022, CCG7040, CCG7041, CCG7042, CCG7045, CCG7046, CCG7061, CCG7062, CCG70652, CCG70653, CCG70663, CCG7201, CCG7220, CCG7221, CCG7222, CCG7240, CCG7241, CCG7242, CCG7245, CCG7246, CCG7261, CCG7262, CCG72652, CCG72653, CCG72662, CCG72663, CCG9020, CCG9021, CCG9022, CCG9040, CCG9041, CCG9042, CCG9046, CCG9060, CCG9061, CCG9062...(Otros modelos se puede ver en la tienda web)		



código	100534	referencia	1883400 MA1883400
descripción	boquilla bypass tipo PEL20/21 taladro ø 1.4mm rosca M5x0,5		
Para modelos:	CRG6220, CRG6240, ETG74GL-R, GG62TGP, GG64TGP		



código	100529	referencia	0102060 1889100 MA1889100 SIRO102060
descripción	boquilla bypass tipo PEL20/21 taladro ø 1mm rosca M5x0,5		
Para modelos:	CCG7001, CCG7020, CCG7021, CCG7022, CCG7040, CCG7041, CCG7042, CCG7045, CCG7046, CCG7061, CCG7062, CCG70652, CCG70653, CCG70663, CCG7201, CCG7220, CCG7221, CCG7222, CCG7240, CCG7241, CCG7242, CCG7245, CCG7246, CCG7261, CCG7262, CCG72652, CCG72653, CCG72662, CCG72663, CCG9020, CCG9021, CCG9022, CCG9040, CCG9041, CCG9042, CCG9046, CCG9060, CCG9061, CCG9062, CCG90663, CCG9081, CCG9082, CCG9140, CCG9141, CCG9142, CCG9145, CCG9146, CCG9160, CCG9161, CCG9162...(Otros modelos se puede ver en la tienda web)		



código	106871	referencia	CR0586570
descripción	boquilla bypass tipo PEL20/21 taladro ø 2.2mm rosca M5x0,5		
Para modelos:	EBG7, EBG92AL, EBG92AR, EBG92GL, EBG92GR, EBG92TL, EBG92TR, EBG93AL, EBG93ALR, EBG93GL, EBG93GLR, EBG93TL, EBG93TLR, EBG94AL, EBG94ALR, EBG94AR, EBG94GL, EBG94GLR, EBG94GR, EBG94TL, EBG94TLR, EBG94TR		

boquillas bypass PEL20



código	100435	referencia	1884100 MA1884100
descripción	boquilla bypass tipo PEL22 taladro ø 1.05mm rosca M6x0,5		
Para modelos:	EGVG92, EGVG94, ETG74, EGVG7		





			
código	106870	referencia	CR0683130
descripción	boquilla bypass tipo PEL22 taladro ø 1.35mm rosca M6x0,5		
Para modelos:	ETG94A, ETG94AL, ETG94F, ETG94FL, ETG94G, ETG94GL, ETG94T, ETG94TPL, ETG96F, ETG96FC, ETG96FL		



boquillas bypass PEL20			
			
código	100265	referencia	1883800 MA1883800
descripción	boquilla bypass tipo PEL23/24 taladro ø 1.8mm rosca M8x0,5		
Para modelos:	EGVG92, EGVG94, ETG74, ETG94A, ETG94AL, ETG94F, ETG94FL, ETG94G, ETG94GL, ETG94T, ETG94TPL, ETG96F, ETG96FC, ETG96FL, EVGV7		



materiales auxiliares de gas

uniones roscadas



anillos cortantes			
			
código	101286	referencia	0100743 0100745 LA62070023 LAR62070023 SIR0100743
descripción	anillo cortante int.ø 6mm UE 1 pzs		
Para modelos:	BG92ALC, BG92ALL, BG92ARC, BG92ARR, BG92GLC, BG92GLL, BG92GRC, BG92GRR, BG94ALC, BG94ALL, BG94ALR, BG94AMC, BG94ARC, BG94ARR, BG94GLC, BG94GLL, BG94GLR, BG94GMC, BG94GRC, BG94GRR, BGY2TLC, BGY2TLL, BGY2TRC, BGY2TRR, BGY4TLC, BGY4TLL, BGY4TLR, BGY4TMC, BGY4TRC, BGY4TRR, CBG7050, CBG7050C, CBG9060CP, CBG9060C-P, CBG9060P, CCG1041P, CCG1042P, CCG1045, CCG1045P, CCG1061P, CCG1062P, CCG10652, CCG10652P, CCG10653, CCG1081P, CCG1082P, CCG1085, CCG10852, CCG1085P, CCG7001...(Otros modelos se puede ver en la tienda web)		
accesorios para	101286		
	código	100909	referencia 0100744 SIR0100744
	tornillo de racor rosca M10x1 para tuboø 6mm UE 1 pzs		
	código	101464	referencia —
	tuerca de racor rosca M12x1 para ø de tubo 6mm		

			
código	101249	referencia	0100780 SIR0100780
descripción	anillo cortante para tuboø 10mm UE 1 pzs		
Para modelos:	DG72128, DG74228, DG82140, DG82142, DG82T42, DG84240, DG84242, DG84T42, DG92142, DG94242, DGY2142, DGY4242, TG84APS, TG84FPS, TG84GPS, TG84TPS		
accesorios para	101249		
	código	101250	referencia 673200 MA673200
	tuerca de racor rosca M20x1.5 para ø de tubo 10mm		

			
código	101278	referencia	0100775 86720 MA86720 SIR0100775
descripción	anillo cortante para tuboø 10mm UE 1 pzs		
Para modelos:	BG62TLC, BG62TLL, BG62TRR, BG63TLC, BG63TLL, BG63TLR, BG64TLC, BG64TLL, BG64TLR, BG72GLC, BG72GLL, BG72GRR, BG72TLC, BG72TLL, BG72TRR, BG74GLC, BG74GLL, BG74GLR, BG74GMC, BG74GRR, BG74TLC, BG74TLL, BG74TLR, BG74TMC, BG74TRR, BG82ALL, BG82ARR, BG82GLC, BG82GLL, BG82GRR, BG82TLC, BG82TLL, BG82TRR, BG84ALC, BG84ALL, BG84ALR, BG84AMC, BG84ARR, BG84GLC, BG84GLL, BG84GLR, BG84GMC, BG84GRR, BG84TLC, BG84TLL, BG84TLR, BG84TMC, BG84TRR, BMG-40, BMG-60...(Otros modelos se puede ver en la tienda web)		
accesorios para	101278		
	código	100943	referencia —
	tuerca de racor rosca M17x1 tubo ø 10mm		
	código	101300	referencia 0100774 SIR0100774
	tuerca de racor rosca M16x1,5 tubo ø 10mm		
	código	101478	referencia —
	tuerca de racor rosca 3/8" para ø de tubo 10mm		

			
código	101248	referencia	673300 MA673300
descripción	anillo cortante para tuboø 12mm UE 1 pzs apto para PEL		
Para modelos:	EDG72128, EDG73142, EDG74228, EDG92142, EDG93142, EDG94242, EGVG92, EGVG94, EPG7D05, EPG7I05, EPG7I08, EPG9D10, EPG9D10A, EPG9D15, EPG9D15A, EPG9I15, EPG9I15A, EPG9I10, EPG9I10A, EPGD05, ESE74, ESG74, ETG74, ETG94A, ETG94AL, ETG94F, ETG94FL, ETG94G, ETG94GL, ETG94T, ETG94TPL, ETG96F, ETG96FC, ETG96FL, EGVG7		
accesorios para	101248		
	código	101251	referencia 673100 MA673100
	tuerca de racor rosca M20x1.5 para ø de tubo 12mm		

			
código	106598	referencia	MA866200
descripción	anillo cortante para tuboø 18mm UE 1 pzs ø ext. 21mm		

			
código	101246	referencia	0100778 673600 MA673600 SIR0100778
descripción	anillo cortante para tuboø 4mm UE 1 pzs		
Para modelos:	BG72GLC, BG72GLL, BG72GRR, BG72TLC, BG72TLL, BG72TRR, BG74GLC, BG74GLL, BG74GLR, BG74GMC, BG74GRR, BG74TLC, BG74TLL, BG74TLR, BG74TMC, BG74TRR, BG82ALL, BG82ARR, BG82GLC, BG82GLL, BG82GRR, BG82TLC, BG82TLL, BG82TRR, BG84ALC, BG84ALL, BG84ALR, BG84AMC, BG84ARR, BG84GLC, BG84GLL, BG84GLR, BG84GMC, BG84GRR, BG84TLC, BG84TLL, BG84TLR, BG84TMC, BG84TRR, CCG6045, CCG6220/1, CCG6230/1, CCG6245-1, CCG62652-1, CCG7045, CCG7045P, CCG70652, CCG70652P, CCG70653, CCG7245... (Otros modelos se puede ver en la tienda web)		
accesorios para	101246		
			
código	100908	referencia	0100777 673500 MA673500 SIR0100777
tornillo de racor rosca M10x1 para tuboø 4mm UE 1 pzs			

			
código	100897	referencia	1888100 MA1888100
descripción	anillo cortante para tuboø 4mm UE 1 pzs para quemador piloto		
Para modelos:	BG62TLC, BG62TLL, BG62TRR, BG63TLC, BG63TLL, BG63TLR, BG64TLC, BG64TLL, BG64TLR, CCG6220, CCG6220C, CCG6220R, CCG6230, CCG6230C, CCG6230LR, CCG6240, CCG6240C, CCG6240LR, EBG7, EBG7-CROMO, EBG92AL, EBG92ALC, EBG92AR, EBG92ARC, EBG92GL, EBG92GLC, EBG92GR, EBG92GRC, EBG92TL, EBG92TLC, EBG92TR, EBG92TRC, EBG93AL, EBG93ALC, EBG93ALR, EBG93AMC, EBG93GL, EBG93GLC, EBG93GLR, EBG93GMC, EBG93TL, EBG93TLC, EBG93TLR, EBG93TMC, EBG94AL, EBG94ALC, EBG94ALR, EBG94AMC, EBG94AR, EBG94GL... (Otros modelos se puede ver en la tienda web)		

			
código	101857	referencia	0100806 SIR0100806
descripción	anillo cortante para tuboø 6mm UE 1 pzs apto para serie 160 para quemador piloto		

tuercas de racor			
			
código	101300	referencia	0100774 SIR0100774
descripción	tuerca de racor rosca M16x1,5 tubo ø 10mm		
Para modelos:	BG74TRR, BG82ALL, BG82ARR, BG82GLC, BG82GLL, BG82GRR, BG82TLC, BG82TLL, BG82TRR, BG84ALC, BG84ALL, BG84ALR, BG84AMC, BG84ARR, BG84GLC, BG84GLL, BG84GLR, BG84GMC, BG84GRR, BG84TLC, BG84TLL, BG84TLR, BG84TMC, BG84TRR, CCG1041, CCG1041P, CCG1042, CCG1042P, CCG1045, CCG1045P, CCG1061, CCG1061P, CCG1062, CCG1062P, CCG10652, CCG10652P, CCG10653, CCG1081, CCG1081P, CCG1082, CCG1082P, CCG1085, CCG10852, CCG1085P, CCG6045, CCG7001, CCG7001P, CCG7020, CCG7020P, CCG7021... (Otros modelos se puede ver en la tienda web)		
accesorios para	101300		
			
código	101278	referencia	0100775 86720 MA86720 SIR0100775
anillo cortante para tuboø 10mm UE 1 pzs			

			
código	101250	referencia	673200 MA673200
descripción	tuerca de racor rosca M20x1.5 para ø de tubo 10mm		
Para modelos:	EGVG92, EGVG94, ETG74, ETG94A, ETG94AL, ETG94F, ETG94FL, ETG94G, ETG94GL, ETG94T, ETG94TPL, ETG96F, ETG96FC, ETG96FL, EVGV7		
accesorios para	101250		
			
código	101249	referencia	0100780 SIR0100780
anillo cortante para tuboø 10mm UE 1 pzs			





			
código	101251	referencia	673100 MA673100
descripción	tuerca de racor rosca M20x1.5 para ø de tubo 12mm		
Para modelos:	EDG72128, EDG73142, EDG74228, EDG92142, EDG93142, EDG94242, EGVG92, EGVG94, EPG7D05, EPG7105, EPG7108, EPG9D10, EPG9D10A, EPG9D15, EPG9D15A, EPG9115, EPG9115A, EPG9110, EPG9110A, EPGD05, ESE74, ESG74, ESG94CRA, ESG94CRM, ESG94FRA, ESG94FRM, ESG96CRA, ESG96FRA, ETG74, ETG94A, ETG94AL, ETG94F, ETG94FL, ETG94G, ETG94GL, ETG94T, ETG94TPL, ETG96F, ETG96FC, ETG96FL, EVGV7		
accesorios para	101251		
			
código	101248	referencia	673300 MA673300
anillo cortante para tuboø 12mm UE 1 pzs apto para PEL			







tornillos de racor

 <p>1</p>			
código	100904	referencia	1394700 MA1394700
descripción	tornillo de apriete M10x1 para tuboø 4mm UE 1 pzs		
Para modelos:	BG62TLC, BG62TLL, BG62TRR, BG63TLC, BG63TLL, BG63TLR, BG64TLC, BG64TLL, BG64TLR, BMG-40, BMG-60, CFG62110, CFG62210, CGG6220, CGG6220C, CGG6220R, CGG6230, CGG6230C, CGG6230LR, CGG6240, CGG6240C, CGG6240LR, EBG7-CROMO, EBG92ALC, EBG92ARC, EBG92GLC, EBG92GRC, EBG92TLC, EBG92TRC, EBG93ALC, EBG93AMC, EBG93GLC, EBG93GMC, EBG93TLC, EBG93TMC, EBG94ALC, EBG94AMC, EBG94GLC, EBG94GMC, EBG94TLC, EBG94TMC, ECG7-FG, ECG94F, ECG96F, ECG96H, ECG98F, EC-MAXI-OVEN-GAS, EFG72108, EFG72110, EFG72115...(Otros modelos se puede ver en la tienda web)		

 <p>1</p>			
código	106597	referencia	MA866000
descripción	tornillo de racor rosca 3/4" para tuboø 18mm L 20mm UE 1 pzs EC 27		

 <p>1</p>			
código	100908	referencia	0100777 673500 MA673500 SIR0100777
descripción	tornillo de racor rosca M10x1 para tuboø 4mm UE 1 pzs		
Para modelos:	BG62TLC, BG62TLL, BG62TRR, BG63TLC, BG63TLL, BG63TLR, BG64TLC, BG64TLL, BG64TLR, BG72GLC, BG72GLL, BG72GRR, BG72TLC, BG72TLL, BG72TRR, BG74GLC, BG74GLL, BG74GLR, BG74GMC, BG74GRR, BG74TLC, BG74TLL, BG74TLR, BG74TMC, BG74TRR, BG82ALL, BG82ARR, BG82GLC, BG82GLL, BG82GRR, BG82TLC, BG82TLL, BG82TRR, BG84ALC, BG84ALL, BG84ALR, BG84AMC, BG84ARR, BG84GLC, BG84GLL, BG84GLR, BG84GMC, BG84GRR, BG84TLC, BG84TLL, BG84TLR, BG84TMC, BG84TRR, CCG6045, CCG6220/1...(Otros modelos se puede ver en la tienda web)		
accesorios para	100908		
	código	100897	referencia 1888100 MA1888100
	anillo cortante para tuboø 4mm UE 1 pzs para quemador piloto		
	código	101246	referencia 0100778 673600 MA673600 SIR0100778
	anillo cortante para tuboø 4mm UE 1 pzs		
	código	101280	referencia
	anillo cortante para tuboø 4mm UE 1 pzs		
	código	101282	referencia
	anillo cortante para tuboø 4mm L 7.4mm UE 1 pzs		

 <p>1</p>			
código	100909	referencia	0100744 SIR0100744
descripción	tornillo de racor rosca M10x1 para tuboø 6mm UE 1 pzs		
Para modelos:	BG92ALC, BG92ALL, BG92ARC, BG92ARR, BG92GLC, BG92GLL, BG92GRC, BG92GRR, BG94ALC, BG94ALL, BG94ALR, BG94AMC, BG94ARC, BG94ARR, BG94GLC, BG94GLL, BG94GLR, BG94GMC, BG94GRC, BG94GRR, BGY2TLC, BGY2TLL, BGY2TRC, BGY2TRR, BGY4TLC, BGY4TLL, BGY4TLR, BGY4TMC, BGY4TRC, BGY4TRR, CBG7050, CBG9060CP, CBG9060C-P, CBG9060P, CCG1041P, CCG1042P, CCG1045, CCG1045P, CCG1061P, CCG1062P, CCG10652, CCG10652P, CCG10653, CCG1081P, CCG1082P, CCG1085, CCG10852, CCG1085P, CCG7001, CCG7001P...(Otros modelos se puede ver en la tienda web)		
accesorios para	100909		
	código	100898	referencia
	anillo cortante para tuboø 6mm UE 1 pzs para quemador piloto		
	código	101286	referencia 0100743 0100745 LA62070023 LAR62070023 SIR0100743
	anillo cortante int.ø 6mm UE 1 pzs		
	código	101287	referencia
	anillo cortante para tuboø 6mm UE 1 pzs		
	código	101288	referencia
	anillo cortante para tuboø 6mm L 6mm aluminio UE 1 pzs ø ext. 8.5mm		

 <p>1</p>			
código	103237	referencia	459500 MA459500
descripción	tornillo de racor rosca M14x1,5 para tuboø 10mm UE 1 pzs		
Para modelos:	BG62TLC, BG62TLL, BG62TRR, BG63TLC, BG63TLL, BG63TLR, BG64TLC, BG64TLL, BG64TLR, BMG-40, BMG-60, CFG62110, CFG62210, CGG6220, CGG6220C, CGG6220R, CGG6230, CGG6230C, CGG6230LR, CGG6240, CGG6240C, CGG6240LR, ECG7, ECG92A, ECG92G, ECG92T, ECG94A, ECG94E, ECG94F, ECG94G, ECG94T, ECG96A, ECG96E, ECG96F, ECG96G, ECG96H, ECG96T, ECG98A, ECG98F, ECG98G, FG62T08, FG64T08		

			
código	100906	referencia	0100807 1888400 MA1888400 SIR0100807
descripción	unión roscada rosca M10x1 para electrodo de encendido latón UE 1 pzs EC 10		
Para modelos:	BG62TLC, BG62TLL, BG62TRR, BG63TLC, BG63TLL, BG63TLR, BG64TLC, BG64TLL, BG64TLR, BG72GLC, BG72GLL, BG72GRR, BG72TLC, BG72TLL, BG72TRR, BG74GLC, BG74GLL, BG74GLR, BG74GMC, BG74GRR, BG74TLC, BG74TLL, BG74TLR, BG74TMC, BG74TRR, BG82ALL, BG82ARR, BG82GLC, BG82GLL, BG82GRR, BG82TLC, BG82TLL, BG82TRR, BG84ALC, BG84ALL, BG84ALR, BG84AMC, BG84ARR, BG84GLC, BG84GLL, BG84GLR, BG84GMC, BG84GRR, BG84TLC, BG84TLL, BG84TLR, BG84TMC, BG84TRR, CG86HPS, CGG6220...(Otros modelos se puede ver en la tienda web)		

			
código	100907	referencia	0100742 0100817 1891700 MA1891700 SIR0100742 SIR0100817
descripción	unión roscada rosca M10x1 UE 1 pzs tipo SEF 1 ømm para termopar		
Para modelos:	BG62TLC, BG62TLL, BG62TRR, BG63TLC, BG63TLL, BG63TLR, BG64TLC, BG64TLL, BG64TLR, BG72GLC, BG72GLL, BG72GRR, BG72TLC, BG72TLL, BG72TRR, BG74GLC, BG74GLL, BG74GLR, BG74GMC, BG74GRR, BG74TLC, BG74TLL, BG74TLR, BG74TMC, BG74TRR, BG82GLC, BG82TLC, BG84ALC, BG84AMC, BG84GLC, BG84GMC, BG84TLC, BG84TMC, CCG1041, CCG1041P, CCG1042, CCG1042P, CCG1045, CCG1045P, CCG1061, CCG1061P, CCG1062, CCG1062P, CCG10652, CCG10652P, CCG10653, CCG1081, CCG1081P, CCG1082, CCG1082P...(Otros modelos se puede ver en la tienda web)		

presostatos

			
código	541051	referencia	0102485 SIR0102485
descripción	presostato ø 45mm margen de presión ajustable 10-50mbar conexión de presión vertical sistemas de gas empalme 1/4" empalme presión ø 1/4"mm		
Para modelos:	CBG9060C-I, CPD90100, CPD90100A, CPD90150, CPD90150A, CPI90100, CPI90100A, CPI90150, CPI90150A		

componentes específicos

para amasadoras

cajinetes brida

			
código	693112	referencia	0100430 SIO100430 SIR0100430
descripción	coinete de brida tipo UCF204 árbol ø 20mm brida 4 orificios dist. del agujero 64mm H 33mm longitud brida 86mm anchura brida 86mm agujero ø 12mm brida F204 rodamiento de bolas UC204G2 altura brida 25.5mm		
Para modelos:	CBE7050, CBE7050C, CBE9060, CBE9060C, CBG7050, CBG9060C-I, CBG9060CP, CBG9060C-P, CBG9060P, SE74CRM, SE74FRM, SE74IRM, SE84CRM, SE84FRM, SE84IRM, SE94CRA, SE94CRM, SE94FRA, SE94FRM, SE94IRA, SE94IRM, SG74CRM, SG74IRM, SG84CRM, SG84IRM, SG94CRA, SG94CRM, SG94FRA, SG94FRM, SG94IRA, SG94IRM		

para planchas grill

cajas y paneles frontales

			
código	691349	referencia	1044314900 MA1044314900
descripción	protección contra salpicaduras L 520mm An 390mm H 75mm		
Para modelos:	BE62TLC, BE62TLL, BE62TRR, BG62TLC, BG62TLL, BG62TRR, CGE6220, CGE6220C, CGE6220R, CGG6220, CGG6220C, CGG6220R		

tapón de salida



código	691330	referencia	1033705600 MA1033705600
descripción	tapón de desagüe para salida de grasa ø 32mm L 50mm int.ø 17.8mm ø ext. 25.5mm		
Para modelos:	BG62TLC, BG62TLL, BG62TRR, BG63TLC, BG63TLL, BG63TLR, BG64TLC, BG64TLL, BG64TLR, CGG6220, CGG6220C, CGG6220R, CGG6230, CGG6230C, CGG6230LR, CGG6240, CGG6240C, CGG6240LR		

para hornos a convección/combinados

tubos



código	520970	referencia	LAR62180022
descripción	tubo de desagüe flexible L 135mm int.ø 18mm ø ext. 27.5mm empalme 3/4" M - 3/4" H inox para horno a vapor combinado		
Para modelos:	GMT06D		

para sartén basculante

recambios y accesorios



código	514229	referencia	CM192101 MACM192101
descripción	casquillo derecho sartén basculante serie 700 marmita serie 900		
Para modelos:	EPE50, EPE7108, EPG50, EPG7108, PE8AI10, PE8AI15, PE8NI10, PE8NI15, PE9AI10, PE9AI15, PE9NI10, PE9NI15, PG8AD10, PG8AD15, PG8AI10, PG8AI15, PG8ND10, PG8ND15, PG8NI10, PG8NI15, PG9AD10, PG9AD15, PG9AI10, PG9AI15, PG9ND10, PG9ND15, PG9NI10, PG9NI15, SE84CRA, SE84CRM, SE84FRA, SE84FRM, SE84IRA, SE84IRM, SE86CRA, SE86FRA, SE86IRA, SE96CRA, SE96FRA, SE96IRA, SG84CRA, SG84CRM, SG84IRA, SG84IRM		



código	514232	referencia	CM051403 MACM051403
descripción	casquillo izquierdo sartén basculante serie 700 marmita serie 900		
Para modelos:	EPE50, EPG50, PE8AI10, PE8AI15, PE8NI10, PE8NI15, PE9AI10, PE9AI15, PE9NI10, PE9NI15, PG8AD10, PG8AD15, PG8AI10, PG8AI15, PG8ND10, PG8ND15, PG8NI10, PG8NI15, PG9AD10, PG9AD15, PG9AI10, PG9AI15, PG9ND10, PG9ND15, PG9NI10, PG9NI15, SE84CRA, SE84CRM, SE84FRA, SE84FRM, SE84IRA, SE84IRM, SE86CRA, SE86FRA, SE86IRA, SE96CRA, SE96FRA, SE96IRA, SG84CRA, SG84CRM, SG84IRA, SG84IRM		



código	514227	referencia	CM051604 MACM051604
descripción	perno de bisagra marmita serie 700/900 sartén basculante		
Para modelos:	EPE50, EPE7108, EPG50, EPG7108, PE8AI10, PE8AI15, PE8NI10, PE8NI15, PE9AI10, PE9AI15, PE9NI10, PE9NI15, PG8AD10, PG8AD15, PG8AI10, PG8AI15, PG8ND10, PG8ND15, PG8NI10, PG8NI15, PG9AD10, PG9AD15, PG9AI10, PG9AI15, PG9ND10, PG9ND15, PG9NI10, PG9NI15, SE84CRA, SE84CRM, SE84FRA, SE84FRM, SE84IRA, SE84IRM, SG84CRA, SG84CRM, SG84IRA, SG84IRM		

tornillos sin fin



código	693129	referencia	0100436 SIR0100436
descripción	barra roscada		



código	693128	referencia	LC335-01 SIRLC335-01
descripción	barra roscada L 350mm		
Para modelos:	CBE7050, CBE7050C, CBE9060, CBE9060C, CBG7050, CBG7050C, CBG9060C-I, CBG9060CP, CBG9060C-P, CBG9060P, SE74CRM, SE74FRM, SE74IRM, SE84CRA, SE84CRM, SE84FRA, SE84FRM, SE84IRA, SE84IRM, SE94CRA, SE94CRM, SE94FRA, SE94FRM, SE94IRA, SE94IRM, SG74CRM, SG74IRM, SG84CRA, SG84CRM, SG84IRA, SG84IRM, SG94CRA, SG94CRM, SG94FRA, SG94FRM, SG94IRA, SG94IRM		



código	693127	referencia	LC333-04 SIRLC333-04
descripción	pieza roscada		
Para modelos:	CBE7050, CBE7050C, CBE9060, CBE9060C, CBG7050, CBG7050C, CBG9060C-I, CBG9060CP, CBG9060C-P, CBG9060P, SE74CRM, SE74FRM, SE74IRM, SE84CRA, SE84CRM, SE84FRA, SE84FRM, SE84IRA, SE84IRM, SE94CRA, SE94CRM, SE94FRA, SE94FRM, SE94IRA, SE94IRM, SG74CRM, SG74IRM, SG84CRA, SG84CRM, SG84IRA, SG84IRM, SG94CRA, SG94CRM, SG94FRA, SG94FRM, SG94IRA, SG94IRM		



otros



código	693130	referencia	9203699 SI9203699 SIR9203699
descripción	árbol		
Para modelos:	CBE9060, CBE9060C, CBG9060C-I, CBG9060CP, CBG9060C-P, CBG9060P, SE94CRA, SE94CRM, SE94FRA, SE94FRM, SE94IRA, SE94IRM, SG94CRA, SG94CRM, SG94FRA, SG94FRM, SG94IRA, SG94IRM		

para marmitas

recambios y accesorios



código	514229	referencia	CM192101 MACM192101
descripción	casquillo derecho sartén basculante serie 700 marmita serie 900		
Para modelos:	EPE50, EPE7108, EPG50, EPG7108, PE8AI10, PE8AI15, PE8NI10, PE8NI15, PE9AI10, PE9AI15, PE9NI10, PE9NI15, PG8AD10, PG8AD15, PG8AI10, PG8AI15, PG8ND10, PG8ND15, PG8NI10, PG8NI15, PG9AD10, PG9AD15, PG9AI10, PG9AI15, PG9ND10, PG9ND15, PG9NI10, PG9NI15, SE84CRA, SE84CRM, SE84FRA, SE84FRM, SE84IRA, SE84IRM, SE86CRA, SE86FRA, SE86IRA, SE96CRA, SE96FRA, SE96IRA, SG84CRA, SG84CRM, SG84IRA, SG84IRM		



código	514232	referencia	CM051403 MACM051403
descripción	casquillo izquierdo sartén basculante serie 700 marmita serie 900		
Para modelos:	EPE50, EPG50, PE8AI10, PE8AI15, PE8NI10, PE8NI15, PE9AI10, PE9AI15, PE9NI10, PE9NI15, PG8AD10, PG8AD15, PG8AI10, PG8AI15, PG8ND10, PG8ND15, PG8NI10, PG8NI15, PG9AD10, PG9AD15, PG9AI10, PG9AI15, PG9ND10, PG9ND15, PG9NI10, PG9NI15, SE84CRA, SE84CRM, SE84FRA, SE84FRM, SE84IRA, SE84IRM, SE86CRA, SE86FRA, SE86IRA, SE96CRA, SE96FRA, SE96IRA, SG84CRA, SG84CRM, SG84IRA, SG84IRM		



código	514227	referencia	CM051604 MACM051604
descripción	perno de bisagra marmita serie 700/900 sartén basculante		
Para modelos:	EPE50, EPE7108, EPG50, EPG7108, PE8AI10, PE8AI15, PE8NI10, PE8NI15, PE9AI10, PE9AI15, PE9NI10, PE9NI15, PG8AD10, PG8AD15, PG8AI10, PG8AI15, PG8ND10, PG8ND15, PG8NI10, PG8NI15, PG9AD10, PG9AD15, PG9AI10, PG9AI15, PG9ND10, PG9ND15, PG9NI10, PG9NI15, SE84CRA, SE84CRM, SE84FRA, SE84FRM, SE84IRA, SE84IRM, SE86CRA, SE86CRM, SE86IRA, SE86IRM		

mirillas de nivel

completo



código	540706	referencia	0100586 0108086 SIR0100586 SIR0108086
descripción	mirilla dist. del agujero 76mm rosca de sujeción M10 L 107mm An 28mm plástico/inox para marmita modelo ELESA HCX-76-BW-SST		
Para modelos:	CPE70150, CPE7-150, PE7NI05		

pomos

pomos personalizados para fabricantes

SILKO



código	110035	referencia	0101211+0101940 SIR0101211+SIR0101940
descripción	pomo grifo de gas con llama piloto ø 65mm eje ø 10x8mm parte plana abajo		

			
1			
código	110729	referencia	0101965+0101940 SIR0101965+SIR0101940
descripción	pomo grifo de gas con llama piloto ø 65mm eje ø 10x8mm parte plana abajo		

			
1			
código	111521	referencia	0101227+0101940 SIR0101227+SIR0101940
descripción	pomo grifo de gas con llama piloto ø 65mm eje ø 10x8mm parte plana arriba		

			
1			
código	111513	referencia	0101954+0101940 SIR0101954+SIR0101940
descripción	pomo grifo de gas con llama piloto ø 65mm eje ø 8x6,5mm parte plana abajo		

			
1			
código	110723	referencia	0101234 0101953+0101940 SIR0101234 SIR0101953+SIR0101940
descripción	pomo grifo de gas sin llama piloto ø 65mm eje ø 8x6,5mm parte plana abajo negro		

			
1			
código	110726	referencia	0101208 0101959+0101940 SIR0101208 SIR0101959+SIR0101940
descripción	pomo interruptor 0-1-0-1 ø 65mm eje ø 6x4,6mm parte plana abajo negro		
Para modelos:	CFE60110-5, CFE60110-9, CFE60210-5, CFE60210-9		

			
1			
código	110720	referencia	0101210 0101957+0101940 SIR0101210 SIR0101957+SIR0101940
descripción	pomo interruptor 7 posiciones ø 65mm eje ø 6x4,6mm parte plana abajo		
Para modelos:	CCT6020, CCT6040, CCT6046, CRE6-20, CRE6-30		

			
1			
código	110730	referencia	0101967+0101940 SIR0101967+SIR0101940
descripción	pomo termostato de gas 1-7 ø 65mm eje ø 10x8mm parte plana arriba		



			
1			
código	111529	referencia	0101964+0101940 SIR0101964+SIR0101940
descripción	pomo termostato T máx 100°C margen de trabajo 0-100°C ø 64mm eje ø 6x4,6mm parte plana abajo		

			
1			
código	110727	referencia	0101963+0101940 SIR0101963+SIR0101940
descripción	pomo termostato T máx 295°C margen de trabajo 45-295°C ø 65mm eje ø 6x4,6mm parte plana abajo ángulo de rotación 270° negro		



			
1			
código	110724	referencia	0101806 0101962+0101940 SIR0101806 SIR0101962+SIR0101940
descripción	pomo termostato T máx 90°C margen de trabajo 30-90°C ø 65mm eje ø 6x4,6mm parte plana abajo		

				
código	111185	referencia	0101954 SIR0101954	
descripción	pomo grifo de gas con llama piloto ø 65mm eje ø 8x6,5mm parte plana abajo negro			
Para modelos:	BG82ALL, BG82ARR, BG82GLL, BG82GRR, BG82TLL, BG82TRR, BG84ALL, BG84ALR, BG84ARR, BG84GLL, BG84GLR, BG84GRR, BG84TLR, BG84TLR, CCG7020P, CCG7021P, CCG7022P, CCG9020P, CCG9021P, CCG9022P, CCG9040P, CCG9041P, CCG9042P, CCG9045P, CCG9046P, CCG9060P, CCG9061P, CCG9062P, CCG90652P, CCG90662P, CCG9081P, CCG9082P, CCG9085P, CCG9085-P, CG72APS, CG72GPS, CG72TPS, CG82APS, CG82GPS, CG82TPS, CG86APS, CG86FPS, CG86GPS, CG86HPS, CG86TPS, CG88APS, CG88FPS, CG88GPS, CG92APS... (Otros modelos se puede ver en la tienda web)			
accesorios para	111185			
		código	111964	referencia 0101940 1036609200 MA1036609200 SIR0101940
	símbolo para pomo T máx°C margen de trabajo°C			

				
código	111182	referencia	0101211 0101965 SIO101965 SIR0101211 SIR0101965	
descripción	pomo grifo de gas con llama piloto T máx°C margen de trabajo°C ø 65mm eje ø 10x8mm parte plana abajo negro			
Para modelos:	BG92ALL, BG92ARR, BG92GLL, BG92GRR, BG94ALL, BG94ALR, BG94ARR, BG94GLL, BG94GLR, BG94GRR, BGY2TLL, BGY2TRR, BGY4TLL, BGY4TLR, BGY4TRR, CGG9020-0, CGG9020-2, CGG9021-0, CGG9021-2, CGG9022-0, CGG9022-2, CGG9040-0, CGG9040-2, CGG9040-4, CGG9041-0, CGG9041-2, CGG9041-4, CGG9042-0, CGG9042-2, CGG9042-4, CNG50150, CNG50160, CNG70160, CNG72160, CNG90160, CNG90160S, CNG90160-S, CPD70150, CPD90100AP, CPD90100A-P, CPD90100P, CPD90150AP, CPD90150A-P, CPD90150P, CPI70150, CPI90100AP, CPI90100A-P, CPI90100P, CPI90100-P, CPI90150AP... (Otros modelos se puede ver en la tienda web)			
accesorios para	111182			
		código	111964	referencia 0101940 1036609200 MA1036609200 SIR0101940
	símbolo para pomo T máx°C margen de trabajo°C			
		código	112051	referencia 0101968 1036609400 MA1036609400 SIR0101968
	tapa amarillo			

				
código	111178	referencia	0101204 0101953 SIR0101204 SIR0101953	
descripción	pomo grifo de gas sin llama piloto ø 65mm eje ø 8x6,5mm parte plana abajo negro			
Para modelos:	CCG1041, CCG1042, CCG1045, CCG1061, CCG1062, CCG10652, CCG10653, CCG1081, CCG1082, CCG1085, CCG10852, CCG6020, CCG6040, CCG6045, CCG6046, CCG7001, CCG7020, CCG7021, CCG7022, CCG7040, CCG7041, CCG7042, CCG7045, CCG7046, CCG7061, CCG7062, CCG70652, CCG70653, CCG70663, CCG7201, CCG7220, CCG7221, CCG7240, CCG7241, CCG7242, CCG7245, CCG7246, CCG7261, CCG7262, CCG72652, CCG72653, CCG72662, CCG72663, CCG9020, CCG9021, CCG9022, CCG9040, CCG9041, CCG9042, CCG9046... (Otros modelos se puede ver en la tienda web)			
accesorios para	111178			
		código	111964	referencia 0101940 1036609200 MA1036609200 SIR0101940
	símbolo para pomo T máx°C margen de trabajo°C			

				
código	111176	referencia	0101223 0101957 SIR0101223 SIR0101957	
descripción	pomo interruptor 7 posiciones ø 65mm eje ø 6x4,6mm parte plana abajo negro			
Para modelos:	BER12, BER14, BER16, BER18, BER20, CCQ7020, CCQ7021, CCQ7022, CCQ7040, CCQ7041, CCQ7042, CCQ7046, CCQ7061, CCQ7062, CCQ70663, CCQ7220, CCQ7221, CCQ7222, CCQ7240, CCQ7241, CCQ7242, CCQ7246, CCQ7261, CCQ7262, CCQ9020, CCQ9021, CCQ9022, CCQ9040, CCQ9041, CCQ9042, CCQ9046, CCQ9060, CCQ9061, CCQ9062, CCQ90663, CCT6020, CCT6040, CCT6046, CCT7020, CCT7021, CCT7022, CCT7040, CCT7041, CCT7042, CCT7046, CCT7061, CCT7062, CCT70663, CCT7220, CCT7221... (Otros modelos se puede ver en la tienda web)			
accesorios para	111176			
		código	111964	referencia 0101940 1036609200 MA1036609200 SIR0101940
	símbolo para pomo T máx°C margen de trabajo°C			

			
1			
código	111183	referencia	0101802 0101967 SIR0101802 SIR0101967
descripción	pomo termostato de gas 1-7 ø 65mm eje ø 10x8mm parte plana arriba		
Para modelos:	CBG9060C-P, CBG9060P, CCG1045, CCG1045P, CCG10652, CCG10652P, CCG10653, CCG1085, CCG10852, CCG1085P, CCG9045P, CCG9046, CCG90652P, CCG90663, CCG9085P, CCG9085-P, CCG9145, CCG9145-1, CCG91652, CCG91652-1, CCG91653, CCG91653-1, CCG9185, CCG9185-1, CCG91852, CCG91852-1, CFS9050, CFS9052, CFS9055, CG94FPS, CG96FPS, CG98FPS, CGG9020, CGG9020C, CGG9020R, CGG9020RC, CGG9021, CGG9021C, CGG9021R, CGG9021RC, CGG9040, CGG9040C, CGG9040LR, CGG9040LRC, CGG9040R, CGG9040RC, CGG9041, CGG9041C, CGG9041LR, CGG9041LRC...(Otros modelos se puede ver en la tienda web)		
accesorios para	111183		
			
código	111964	referencia	0101940 1036609200 MA1036609200 SIR0101940
símbolo para pomo T máx°C margen de trabajo°C			

			
1			
código	112050	referencia	0101966 SIR0101966
descripción	pomo termostato de gas 1-7 T máx°C margen de trabajo°C ø 65mm eje ø 10x8mm parte plana arriba negro		

			
1			
código	111195	referencia	0101964 SIR0101964
descripción	pomo termostato T máx 100°C margen de trabajo 30-100°C ø 64mm eje ø 6x4,6mm parte plana abajo ángulo de rotación 270° negro		
Para modelos:	CPE90100, CPE90100A, CPE90150, CPE90150A, CPI90100, CPI90100A, CPI90150, CPI90150A, PE9AI10, PE9AI15, PE9NI10, PE9NI15		
accesorios para	111195		
			
código	111964	referencia	0101940 1036609200 MA1036609200 SIR0101940
símbolo para pomo T máx°C margen de trabajo°C			

			
1			
código	111197	referencia	0101206 0101958 SIR0101206 SIR0101958
descripción	pomo termostato T máx 110°C margen de trabajo 30-110°C ø 65mm eje ø 6x4,6mm parte plana abajo negro		
Para modelos:	CCW6020, CME6020, CME6030, CME6040, CNE70130, CNE72130, CNE90130, CNE90130-S, CNE90140, CNE90140-S, CNE90160, CNE90160S, CNE90160-S, CNE90230, CNE90240, CSP6020, DE72125, DE92140, DE94170, DE94240, DEY4160		
accesorios para	111197		
			
código	111964	referencia	0101940 1036609200 MA1036609200 SIR0101940
símbolo para pomo T máx°C margen de trabajo°C			

			
1			
código	111188	referencia	0101956 SIR0101956
descripción	pomo termostato T máx 310°C margen de trabajo 50-310°C ø 65mm eje ø 6x4,6mm parte plana abajo negro		
Para modelos:	BE72ALC, BE72ALL, BE72ARR, BE72GLC, BE72GLL, BE72GRR, BE72TLC, BE72TLL, BE72TRR, BE74ALC, BE74ALL, BE74ALR, BE74ARC, BE74ARR, BE74GLC, BE74GLL, BE74GLR, BE74GMC, BE74GRR, BE74TLC, BE74TLL, BE74TLR, BE74TMC, BE74TRR, CBE6030, CCG60652, CCG60653, CCG7046, CCG7046P, CCG70662P, CCG70663, CCG7246, CCG72662, CCG72663, CCG9046P, CCG90662P, CCG9146, CCG9146-1, CCG91662, CCG91662-1, CCG91663, CCG91663-1, CCQ7046, CCQ70663, CCQ9020, CCQ9020V, CCQ9020-V, CCQ9021, CCQ9021-V, CCQ9022...(Otros modelos se puede ver en la tienda web)		
accesorios para	111188		
			
código	111964	referencia	0101940 1036609200 MA1036609200 SIR0101940
símbolo para pomo T máx°C margen de trabajo°C			

			
1			
código	111179	referencia	0101962 SIR0101962
descripción	pomo termostato T máx 90°C margen de trabajo 30-90°C ø 65mm eje ø 6x4,6mm parte plana abajo ángulo de rotación 270°		
Para modelos:	BAC100, BAC100-A, BAC102, BAC120, BAC120-A, BAC122, BAC140, BAC140-A, BAC142, BAC160, BAC160-A, BAC162, BAC180, BAC180-A, BAC182, BAC200, BAC200-A, BAC202, BAM16D, BAM16S, BAM18D, BAM18S, BAM20D, BAM20S, CCG1045, CCG10652, CCG10653, CCG1085, CCG10852, CCG6045, CCG60652, CCG60653, CCG7045, CCG7046, CCG70652, CCG70653, CCG70663, CCG72653, CCG72663, CCG9046, CCG90663, CCG91653, CCG91653-1, CCG91663, CCG91663-1, CCG9046, CCG70663, CCG9046, CCG90663, CCT7046...(Otros modelos se puede ver en la tienda web)		
accesorios para	111179		
	código	111964	referencia 0101940 1036609200 MA1036609200 SIR0101940
símbolo para pomo T máx°C margen de trabajo°C			

			
1			
código	111964	referencia	0101940 1036609200 MA1036609200 SIR0101940
descripción	símbolo para pomo T máx°C margen de trabajo°C		
Para modelos:	BE62TLC, BE62TLL, BE62TRR, BE63TLC, BE63TLL, BE63TLR, BE65TLC, BE65TLL, BE65TLR, CBE6220, CCG6220/1, CCG6230/1, CCG6245-1, CCG62652-1, CCT6220, CCT6220V, CCT6230, CCT6230V, CCW6220, CE62TPT, CE64TPT, CFE62110/1, CFE62210/1, CG62TPS, CG64FPS, CG64TPS, CG66FPS, CGE6220, CGE6220C, CGE6220R, CGE6230, CGE6230C, CGE6230LR, CGE6250, CGE6250LR, CGE6250LRC, CME6220, CME6230, CME6240, CNE6230, CSP6220, CV62TPS, CV64TPS, CW62TPS, DE63128, FE62T10, FE64T10, ME62TPS, ME63TPS, ME64TPS...(Otros modelos se puede ver en la tienda web)		

			
1			
código	112051	referencia	0101968 1036609400 MA1036609400 SIR0101968
descripción	tapa amarillo		
Para modelos:	BE62TLC, BE62TLL, BE62TRR, BE63TLC, BE63TLL, BE63TLR, BE65TLC, BE65TLL, BE65TLR, CBE6220, CCG6220/1, CCG6230/1, CCG6245-1, CCG62652-1, CCT6220, CCT6220V, CCT6230, CCT6230V, CCW6220, CE62TPT, CE64TPT, CFE62110/1, CFE62210/1, CG62TPS, CG64FPS, CG64TPS, CG66FPS, CGE6220, CGE6220C, CGE6220R, CGE6230, CGE6230C, CGE6230LR, CGE6250, CGE6250LR, CGE6250LRC, CME6220, CME6230, CME6240, CNE6230, CSP6220, CV62TPS, CV64TPS, CW62TPS, DE63128, FE62T10, FE64T10, ME62TPS, ME63TPS, ME64TPS...(Otros modelos se puede ver en la tienda web)		

			
1			
código	111524	referencia	0101794+0101795 SIR0101794+SIR0101795
descripción	pomo		

			
1			
código	111515	referencia	0101787+0101795 SIR0101787+SIR0101795
descripción	pomo grifo de gas con llama piloto ø 73mm eje ø 10x8mm parte plana abajo		

			
1			
código	111514	referencia	0101798+0101795 SIR0101798+SIR0101795
descripción	pomo grifo de gas con llama piloto ø 73mm eje ø 8x6,5mm parte plana abajo		

			
1			
código	111512	referencia	0101786+0101795 SIR0101786+SIR0101795
descripción	pomo grifo de gas sin llama piloto ø 50mm eje ø 8x6,5mm parte plana arriba negro		

			
1			
código	111359	referencia	0101792 SI0101792 SIR0101792
descripción	pomo interruptor 0-1-0-1 ø 73mm eje ø 6x4,6mm parte plana arriba negro		
Para modelos:	CFE60110-5, CFE60110-9, CFE60210-5, CFE60210-9, CFE70115, CFE70115-2, CFE70115-M, CFE70210-M, CFE70215, CFE70215-2, CFE70215-M, CFE72215, CFE90120, CFE90120-2, CFE90210, CFE90210-2, CFE90220, CFE90220-2, CM72APS, CM82APS, FE92210, SE84CRA, SE84FRA, SE84IRA, SG84CRA, SG84IRA, SG94CRA, SG94FRA, SG94IRA		

 <p>1</p>			
código	111527	referencia	0101792+0101795 SIR0101792+SIR0101795
descripción	pomo interruptor 0-1-0-1 ø 73mm eje ø 6x4,6mm parte plana arriba negro		

 <p>1</p>			
código	111525	referencia	0101791+0101795 SIR0101791+SIR0101795
descripción	pomo termostato T máx 110°C margen de trabajo 0-110°C ø 73mm eje ø 6x4,6mm parte plana abajo		

 <p>1</p>			
código	111519	referencia	0101788+0101795 SIR0101788+SIR0101795
descripción	pomo interruptor 4 posiciones ø 73mm eje ø 6x4,6mm parte plana arriba		

 <p>1</p>			
código	111517	referencia	0101789+0101795 SIR0101789+SIR0101795
descripción	pomo termostato T máx 310°C margen de trabajo 0-310°C ø 73mm eje ø 6x4,6mm parte plana abajo termostato		

 <p>1</p>			
código	111523	referencia	0101802+0101795 SIR0101802+SIR0101795
descripción	pomo termostato de gas 1-7 ø 73mm eje ø 10x8mm parte plana arriba negro		

 <p>1</p>			
código	111520	referencia	0101797+0101795 SIR0101797+SIR0101795
descripción	pomo termostato T máx 90°C margen de trabajo 30-90°C ø 73mm eje ø 6x4,6mm parte plana abajo		

 <p>1</p>			
código	111522	referencia	0101785+0101795 SIR0101785+SIR0101795
descripción	pomo termostato de gas ø 73mm eje ø 10x8mm parte plana arriba		

 <p>1</p>			
código	111187	referencia	0101787 SIR0101787
descripción	pomo grifo de gas con llama piloto ø 73mm eje ø 10x8mm parte plana abajo negro		

 <p>1</p>			
código	111530	referencia	0102497+0101795 SIR0102497+SIR0101795
descripción	pomo termostato T máx 100°C margen de trabajo 0-100°C ø 73mm eje ø 6x4,6mm parte plana abajo		

Para modelos:	BG92ALL, BG92ARR, BG92GLL, BG92GRR, BG94ALL, BG94ALR, BG94ARR, BG94GLL, BG94GLR, BG94GRR, BGY2TLL, BGY2TRR, BGY4TLL, BGY4TLR, BGY4TRR, CGG9020-0, CGG9020-2, CGG9021-0, CGG9021-2, CGG9022-0, CGG9022-2, CGG9040-0, CGG9040-2, CGG9040-4, CGG9041-0, CGG9041-2, CGG9041-4, CGG9042-0, CGG9042-2, CGG9042-4, CNG50150, CNG50160, CNG72160, CNG90160, CNG90160S, CNG90160-S, CPD70150, CPD90100AP, CPD90100A-P, CPD90100P, CPD90150AP, CPD90150A-P, CPD9015-P, CPI70150, CPI90100AP, CPI90100A-P, CPI90100P, CPI90100-P, CPI90150AP, CPI90150A-P...(Otros modelos se puede ver en la tienda web)		
accesorios para	111187		
	código	111965	referencia 0101795 1039122300 MA1039122300 SIR0101795
símbolo para pomo T máx°C margen de trabajo°C			



1

código	111186	referencia	0101798 SIR0101798
descripción	pomo grifo de gas con llama piloto ø 73mm eje ø 8x6,5mm parte plana abajo negro		
Para modelos:	BG82ALL, BG82ARR, BG82GLL, BG82GRR, BG82TLL, BG82TRR, BG84ALL, BG84ALR, BG84ARR, BG84GLL, BG84GLR, BG84GRR, BG84TLR, BG84TRR, CCG1041P, CCG1042P, CCG1045P, CCG1061P, CCG1062P, CCG10652P, CCG1081P, CCG1082P, CCG1085P, CCG7001P, CCG7020P, CCG7021P, CCG7022P, CCG7040P, CCG7041P, CCG7042P, CCG7045P, CCG7046P, CCG7061P, CCG7062P, CCG70652P, CCG70662P, CCG9020P, CCG9021P, CCG9022P, CCG9040P, CCG9041P, CCG9042P, CCG9045P, CCG9046P, CCG9060P, CCG9061P, CCG9062P, CCG90652P, CCG90662P...(Otros modelos se puede ver en la tienda web)		
accesorios para	111186		
	código	111965	referencia 0101795 1039122300 MA1039122300 SIR0101795
símbolo para pomo T máx°C margen de trabajo°C			



1

código	111184	referencia	0101786 SIO101786 SIR0101786
descripción	pomo grifo de gas sin llama piloto T máx°C margen de trabajo°C ø 73mm eje ø 8x6,5mm parte plana abajo negro forma S		
Para modelos:	CCG1041, CCG1042, CCG1045, CCG1061, CCG1062, CCG10652, CCG10653, CCG1081, CCG1082, CCG1085, CCG10852, CCG6020, CCG6040, CCG6045, CCG6046, CCG7001, CCG7020, CCG7021, CCG7022, CCG7040, CCG7041, CCG7042, CCG7045, CCG7046, CCG7061, CCG7062, CCG70652, CCG70653, CCG70663, CCG7201, CCG7220, CCG7221, CCG7240, CCG7241, CCG7242, CCG7245, CCG7246, CCG7261, CCG7262, CCG72652, CCG72653, CCG72662, CCG72663, CCG9020, CCG9021, CCG9022, CCG9040, CCG9041, CCG9042, CCG9046...(Otros modelos se puede ver en la tienda web)		
accesorios para	111184		
	código	111965	referencia 0101795 1039122300 MA1039122300 SIR0101795
símbolo para pomo T máx°C margen de trabajo°C			



1

código	112532	referencia	0101946 SIR0101946
descripción	pomo interruptor 0-1-2 ø 73mm eje ø 6x4,6mm parte plana abajo negro		
Para modelos:	CTE9141, CTE9142, CTE9142S, CTE9146, TE94APS, TE94EPS, TE94GPS, TEY4APS		



1

código	111189	referencia	0101788 SIR0101788
descripción	pomo interruptor 4 posiciones ø 73mm eje ø 6x4,6mm parte plana arriba negro		
Para modelos:	CCG60652, CCG60653, CCG7046, CCG7046P, CCG70662P, CCG70663, CCG7246, CCG72662, CCG72663, CCG9046P, CCG90662P, CCG9146, CCG9146-1, CCG91662, CCG91662-1, CCG91663, CCG91663-1, CCG7046, CCG70663, CCG9046, CCG9046V, CCG90663, CCT6046, CCT7046, CCT70663, CCT7246V, CE84EPQ, CE94EPQ, CFS9060, CFS9062, CFS9066, CG74EPS, CG76EPS, CG84EPS, CG94EPS, CG96EPS, CTT9046, CTT90663R, CV74EPS, CV94EPS, HE94EPS, HEY4EPS, TG94EPS		
accesorios para	111189		
	código	111965	referencia 0101795 1039122300 MA1039122300 SIR0101795
símbolo para pomo T máx°C margen de trabajo°C			



1

código	110423	referencia	0101790 SIR0101790
descripción	pomo interruptor 7 posiciones T máx°C margen de trabajo°C ø 73mm eje ø 6x4,6mm parte plana abajo		
Para modelos:	BER12, BER14, BER16, BER18, BER20, CCQ7020, CCQ7021, CCQ7022, CCQ7040, CCQ7041, CCQ7042, CCQ7046, CCQ7061, CCQ7062, CCQ70663, CCQ7220, CCQ7221, CCQ7222, CCQ7240, CCQ7241, CCQ7242, CCQ7246, CCQ7261, CCQ7262, CCQ9020, CCQ9021, CCQ9022, CCQ9040, CCQ9041, CCQ9042, CCQ9046, CCQ9060, CCQ9061, CCQ9062, CCQ90663, CCT6020, CCT6040, CCT6046, CCT7020, CCT7021, CCT7022, CCT7040, CCT7041, CCT7042, CCT7046, CCT7061, CCT7062, CCT70663, CCT7220, CCT7221...(Otros modelos se puede ver en la tienda web)		



1

código	112531	referencia	0101949 SIR0101949
descripción	pomo regulador de energía 1-9 ø 73mm eje ø 6x4,6mm parte plana abajo negro		
Para modelos:	CTE9141, CTE9142, CTE9142S, CTE9146, TE94APS, TE94EPS, TE94GPS, TEY4APS		

1

código	111196	referencia	0102497 SIR0102497
descripción	pomo termostato T máx 100°C margen de trabajo 0-100°C ø 73mm eje ø 6x4,6mm parte plana abajo ángulo de rotación 270° negro		
Para modelos:	CPE90100, CPE90100A, CPE90150, CPE90150A, CPI90100, CPI90100A, CPI90150, CPI90150A, PE7NI05, PE8AI10, PE8AI15, PE8NI10, PE8NI15, PE9AI10, PE9AI15, PE9NI10, PE9NI15		
accesorios para	111196		
	código	111965	referencia 0101795 1039122300 MA1039122300 SIR0101795
símbolo para pomos T máx°C margen de trabajo°C			



1

código	111208	referencia	0101789 SIR0101789
descripción	pomo termostato T máx 310°C margen de trabajo 0-310°C ø 73mm eje ø 6x4,6mm parte plana abajo		
Para modelos:	BE72ALC, BE72ALL, BE72ARR, BE72GLC, BE72GLL, BE72GRR, BE72TLC, BE72TLL, BE72TRR, BE74ALC, BE74ALL, BE74ALR, BE74ARC, BE74ARR, BE74GLC, BE74GLL, BE74GLR, BE74GMC, BE74GRR, BE74TLC, BE74TLL, BE74TLR, BE74TMC, BE74TRR, CBE6030, CCG60652, CCG60653, CCG7046, CCG7046P, CCG70662P, CCG70663, CCG7246, CCG72662, CCG72663, CCG9046P, CCG90662P, CCG9146, CCG9146-1, CCG91662, CCG91662-1, CCG91663, CCG91663-1, CCG91663-1, CCG91663, CCG91663-1, CCG9020, CCG9020V, CCG9020-V, CCG9021, CCG9021-V, CCG9022... (Otros modelos se puede ver en la tienda web)		



1

código	111193	referencia	0101791 SIR0101791
descripción	pomo termostato T máx 110°C margen de trabajo 0-110°C ø 73mm eje ø 6x4,6mm parte plana abajo ángulo de rotación 270° negro		
Para modelos:	CNE70130, CNE72130, CNE90130, CNE90130-S, CNE90140, CNE90140-S, CNE90160, CNE90160S, CNE90160-S, CNE90230, CNE90240, DE72125, DE72128, DE74228, DE92140, DE92142, DE94170, DE94240, DE94242, DEY2142, DEY4160, DEY4242		
accesorios para	111193		
	código	111965	referencia 0101795 1039122300 MA1039122300 SIR0101795
símbolo para pomos T máx°C margen de trabajo°C			



1

código	111190	referencia	0101797 SIR0101797
descripción	pomo termostato T máx 90°C margen de trabajo 30-90°C ø 73mm eje ø 6x4,6mm parte plana abajo ángulo de rotación 270° negro		
Para modelos:	BAC100, BAC100-A, BAC102, BAC120, BAC120-A, BAC122, BAC140, BAC140-A, BAC142, BAC160, BAC160-A, BAC162, BAC180, BAC180-A, BAC182, BAC200, BAC200-A, BAC202, BAM16D, BAM16S, BAM18D, BAM18S, BAM20D, BAM20S, CCG1045, CCG10652, CCG10653, CCG1085, CCG10852, CCG6045, CCG60652, CCG60653, CCG7045, CCG7046, CCG70652, CCG70653, CCG70663, CCG72653, CCG72663, CCG9046, CCG90663, CCG91653, CCG91653-1, CCG91663, CCG91663-1, CCG9046, CCG70663, CCG9046, CCG90663, CCT7046...(Otros modelos se puede ver en la tienda web)		
accesorios para	111190		
	código	111965	referencia 0101795 1039122300 MA1039122300 SIR0101795
símbolo para pomos T máx°C margen de trabajo°C			



1

código	111528	referencia	0101799 SIR0101799
descripción	pomo termostato T máx 295°C margen de trabajo 0-295°C ø 73mm eje ø 6x4,6mm parte plana abajo ángulo de rotación 270° negro		
Para modelos:	BE72ALC, BE72ALL, BE72ARR, BE72GLC, BE72GLL, BE72GRR, BE72TLC, BE72TLL, BE72TRR, BE74ALC, BE74ALL, BE74ALR, BE74ARC, BE74ARR, BE74GLC, BE74GLL, BE74GLR, BE74GMC, BE74GRR, BE74TLC, BE74TLL, BE74TLR, BE74TMC, BE74TRR, BE82ALC, BE82ALL, BE82ARR, BE82GLC, BE82GLL, BE82GRR, BE82TLC, BE82TLL, BE82TRR, BE84ALC, BE84ALL, BE84ALR, BE84AMC, BE84ARR, BE84GLC, BE84GLL, BE84GLR, BE84GMC, BE84GRR, BE84TLC, BE84TLL, BE84TLR, BE84TMC, BE84TRR, BE92ALC, BE92ALL...(Otros modelos se puede ver en la tienda web)		







1



código	111965	referencia	0101795 1039122300 MA1039122300 SIR0101795
descripción	símbolo para pomos T máx°C margen de trabajo°C		
Para modelos:	BE62TLC, BE62TLL, BE62TRR, BE63TLC, BE63TLL, BE63TLR, BE65TLC, BE65TLL, BE65TLR, CBE6220, CCG6220/1, CCG6230/1, CCG6245-1, CCG62652-1, CCT6220, CCT6220V, CCT6230, CCT6230V, CCG6220, CE62TPT, CE64TPT, CFE62110/1, CFE62210/1, CG62TPS, CG64FPS, CG64TPS, CG66FPS, CGE6220, CGE6220C, CGE6220R, CGE6230, CGE6230C, CGE6230LR, CGE6250, CGE6250LR, CGE6250LRC, CME6220, CME6230, CME6240, CNE6230, CSP6220, CV62TPS, CV64TPS, CW62TPS, DE63128, FE62T10, FE64T10, ME62TPS, ME63TPS, ME64TPS...(Otros modelos se puede ver en la tienda web)		

			
1			
código	110060	referencia	0101213 SIR0101213
descripción	pomo interruptor 0-1-0-1 ø 60mm eje ø 6x4,6mm parte plana arriba negro		

			
1			
código	110058	referencia	0101219 SIR0101219
descripción	pomo termostato T máx 110°C margen de trabajo 30-110°C ø 60mm eje ø 6x4,6mm parte plana horizontal		

			
1			
código	112527	referencia	1036712600 MA1036712600
descripción	pomo grifo de gas con llama piloto T máx°C margen de trabajo°C ø 45mm eje ø 6x4,6mm parte plana abajo negro		
Para modelos:	CRG6220, CRG6240, GG62TGP, GG64TGP		
accesorios para	112527		
	código	112709	referencia
			1036609900 MA1036609900
	tapa T máx°C gris para pomo		



			
1			
código	112709	referencia	1036609900 MA1036609900
descripción	tapa T máx°C gris para pomo		
Para modelos:	CRE6220, CRE6230, CRG6220, CRG6240, GE62TPS, GE63TPS, GG62TGP, GG64TGP		
accesorios para	112709		
	código	112527	referencia
			1036712600 MA1036712600
	pomo grifo de gas con llama piloto T máx°C margen de trabajo°C ø 45mm eje ø 6x4,6mm parte plana abajo negro		

			
1			
código	580137	referencia	CR0585220
descripción	pomo interruptor marca cero eje ø 6x4,6mm parte plana arriba negro		
accesorios para	580137		
	código	550132	referencia
			—
	muelle de pomo ø 6x4,6mm UE 10 pzs		

			
1			
código	580140	referencia	CR0585250 TAB_M
descripción	pomo interruptor marca cero ø 76mm eje ø 10x8mm negro		
Para modelos:	EBE92AL, EBE92ALC, EBE92AR, EBE92ARC, EBE92GL, EBE92GLC, EBE92GR, EBE92GRC, EBE92TL, EBE92TLC, EBE92TR, EBE92TRC, EBE93AL, EBE93ALC, EBE93ALR, EBE93AMC, EBE93GL, EBE93GLC, EBE93GLR, EBE93GMC, EBE93TL, EBE93TLC, EBE93TLR, EBE93TMC, EBE94AL, EBE94ALC, EBE94ALR, EBE94AMC, EBE94AR, EBE94GL, EBE94GLC, EBE94GLR, EBE94GMC, EBE94GR, EBE94TL, EBE94TLC, EBE94TLR, EBE94TMC, EBE94TR, EBG92AL, EBG92AR, EBG92GL, EBG92GR, EBG92TL, EBG92TR, EBG93AL, EBG93ALR, EBG93GL, EBG93GLR, EBG93TL...(Otros modelos se puede ver en la tienda web)		

			
1			
código	111221	referencia	0101232 SIR0101232
descripción	pomo ø 61mm grifo de gas con llama piloto		

otros

			
1			
código	111191	referencia	0101785 SIR0101785
descripción	pomo		
accesorios para	111191		
	código	111965	referencia
			0101795 1039122300 MA1039122300 SIR0101795
	símbolo para pomo T máx°C margen de trabajo°C		

accesorios

paneles



código	111422	referencia	CR0680110
descripción	panel de mando termostato de gas T máx 300°C 100-300°C ø 94mm		

manillas y volantes

volantes

volantes



código	693113	referencia	LC336-00 SIRLC336-00
descripción	volante ø 150mm D1 ø 38mm taladro ø 14mm rosca ancho de ranura 5mm L1 38mm L2 40mm longitud de asidero 65mm con asidero abatible		
Para modelos:	CBE7050, CBE7050C, CBG7050, CBG7050C, SE74CRM, SE74FRM, SE74IRM, SG74CRM, SG74IRM		

repuestos para	693113	código	514255	referencia	—
	mango abatible ø 26mm longitud total 85mm soporte ø 20mm árbol ø 8mm rosca M6 con pasador L 85mm				

accesorios para	693113	código	690968	referencia	—
	pasador elástico ø 5mm L 20mm				



código	690854	referencia	0100480 SIR0100480
descripción	volante ø 200mm D1 ø 40mm taladro ø 6mm profundidad de taladro 30mm rosca M10x1,5 ancho de ranura L1 25mm L2 55mm longitud de asidero mm sin asidero		

accesorios para	690854	código	690856	referencia	0100481 SIO100481 SIR0100481
	mango abatible ø 28mm longitud total 105mm soporte ø 21mm árbol ø 8mm rosca M6 con árbol y pasador L 105mm				



código	692430	referencia	9203665 SI9203665 SIR9203665
descripción	volante ø 200mm D1 ø 50mm taladro ø 20mm rosca ancho de ranura 6mm profundidad de ranura 13mm distancia de sujeción 30mm L1 47mm L2 50mm longitud de asidero 90mm con asidero abatible		
Para modelos:	CBE9060, CBE9060C, CBG9060C-I, CBG9060CP, CBG9060C-P, CBG9060P, SE84CRM, SE84FRM, SE84IRM, SE94CRM, SE94FRM, SE94IRM, SG84CRM, SG84IRM, SG94CRM, SG94FRM, SG94IRM		

recambios y accesorios



código	690855	referencia	0100483 SIR0100483
descripción	mango abatible ø 25mm soporte ø 19mm árbol ø 8mm rosca M6 con árbol y pasador L 82mm		



código	690856	referencia	0100481 SIO100481 SIR0100481
descripción	mango abatible ø 28mm longitud total 105mm soporte ø 21mm árbol ø 8mm rosca M6 con árbol y pasador L 105mm		



asas de arco

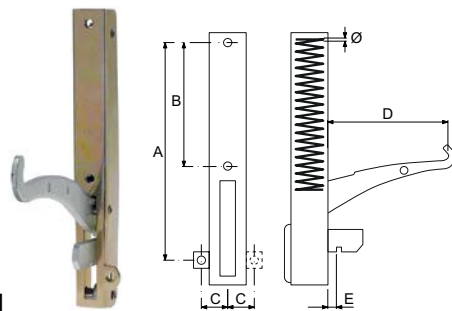

código	691327	referencia	0101243 CM073100 MACM073100 SIR0101243
descripción	asa de arco L 119mm H 37mm distancia de sujeción 105mm manilla M6		
Para modelos:	CEN6220, CEN6220C, CEN6230, CEN6230C, CFE90120, CFE90120-2, CFE90210, CFE90210-2, CFE90220, CFE90220-2, CFG70115, CFG70215, CFG72215, CFG90120, CFG90210, CFG90210S, CFG90220, CNE70130, CNE70160, CNE72130, CNE72160, CNE90130, CNE90130-S, CNE90140, CNE90140-S, CNE90160, CNE90160S, CNE90160-S, CNE90230, CNE90240, CNG50150, CNG50160, CNG90130, CNG90130-S, CNG90140, CNG90140-S, CNG90160, CNG90160S, CNG90160-S, CNG90230, CNG90240, DE72125, DE74170, DE92140, DE94170, DE94240, DEY4160, DG92140, DG94160, DG94240...(Otros modelos se puede ver en la tienda web)		

bisagras para hornos



código	700007	referencia	0100345 BN6A035920 SIR0100345	
descripción	bisagra para horno distancia de sujeción 173mm distancia de sujeción 2 105mm orejas de fijación 14mm longitud de palanca 120mm distancia de ranura 11mm espesor de resorte 3.5mm posición fijación derecho longitud muelle 112mm An 25mm			
Para modelos:	CCG1041, CCG1042, CCG1045, CCG1045P, CCG1061, CCG1062, CCG10652, CCG10652P, CCG10653, CCG1081, CCG1082, CCG1085, CCG10852, CCG1085P, CCG6020, CCG6040, CCG6045, CCG6046, CCG7020, CCG7021, CCG7022, CCG7040, CCG7041, CCG7042, CCG7045, CCG7045P, CCG7046, CCG7046P, CCG7061, CCG7062, CCG70652, CCG70652P, CCG70653, CCG70662P, CCG70663, CCG7245, CCG7246, CCG72652, CCG72653, CCG72662, CCG72663, CCG9020, CCG9021, CCG9022, CCG9040, CCG9041, CCG9042, CCG9045P, CCG9046, CCG9046P...(Otros modelos se puede ver en la tienda web)			
accesorios para	700007			
	código	700001	referencia	0100343 1304500 MA1304500 SIR0100343
	contrasopORTE L 118mm An 17mm distancia de sujeción 94mm			
	código	700006	referencia	0100346 SIR0100346
	bisagra para horno distancia de sujeción 173mm distancia de sujeción 2 105mm orejas de fijación 14mm longitud de palanca 120mm distancia de ranura 11mm espesor de resorte 3.5mm posición fijación izquierdo longitud muelle 112mm An 25mm			

bisagras

bisagras de resorte

universal



CAFF/FERMOD

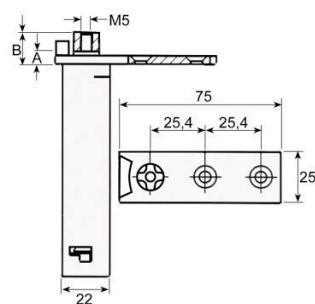

grupo 2



código	690494	referencia	4837000 MA4837000
descripción	bisagra a resorte serie 175 pos. de montaje izquierdo/derecho torx L 75mm An 25.6mm H 100mm A 4mm B 11mm medida de montaje 22x22mm soporte torx aparatos de refrigeración distancia de sujeción 25mm		



			
código	700006	referencia	0100346 SIR0100346
descripción	bisagra para horno distancia de sujeción 173mm distancia de sujeción 2 105mm orejas de fijación 14mm longitud de palanca 120mm distancia de ranura 11mm espesor de resorte 3.5mm posición fijación izquierdo longitud muelle 112mm An 25mm		
Para modelos:	CCG1041, CCG1042, CCG1045, CCG1045P, CCG1061, CCG1062, CCG10652, CCG10652P, CCG10653, CCG1081, CCG1082, CCG1085, CCG10852, CCG1085P, CCG6020, CCG6040, CCG6045, CCG6046, CCG7020, CCG7021, CCG7022, CCG7040, CCG7041, CCG7042, CCG7045, CCG7045P, CCG7046, CCG7046P, CCG7061, CCG7062, CCG70652, CCG70652P, CCG70653, CCG70662P, CCG70663, CCG7245, CCG7246, CCG72652, CCG72653, CCG72662, CCG72663, CCG9020, CCG9021, CCG9022, CCG9040, CCG9041, CCG9042, CCG9045P, CCG9046, CCG9046P...(Otros modelos se puede ver en la tienda web)		
accesorios para	700006		
			
código	700001	referencia	0100343 1304500 MA1304500 SIR0100343
descripción	contrasoporte L 118mm An 17mm distancia de sujeción 94mm		
			
código	700007	referencia	0100345 BN6A035920 SIR0100345
descripción	bisagra para horno distancia de sujeción 173mm distancia de sujeción 2 105mm orejas de fijación 14mm longitud de palanca 120mm distancia de ranura 11mm espesor de resorte 3.5mm posición fijación derecho longitud muelle 112mm An 25mm		

 			
código	700001	referencia	0100343 1304500 MA1304500 SIR0100343
descripción	contrasoporte L 118mm An 17mm distancia de sujeción 94mm		
Para modelos:	CCG1041, CCG1042, CCG1045, CCG1045P, CCG1061, CCG1062, CCG10652, CCG10652P, CCG10653, CCG1081, CCG1082, CCG1085, CCG10852, CCG1085P, CCG6020, CCG6040, CCG6045, CCG6046, CCG6245-1, CCG62652-1, CCG7001, CCG7001P, CCG7020, CCG7021, CCG7022, CCG7040, CCG7041, CCG7042, CCG7045, CCG7045P, CCG7046, CCG7046P, CCG7061, CCG7062, CCG70652, CCG70652P, CCG70653, CCG70662P, CCG70663, CCG7201, CCG7245, CCG7246, CCG72652, CCG72653, CCG72662, CCG72663, CCG9020, CCG9021, CCG9022, CCG9040...(Otros modelos se puede ver en la tienda web)		

otros

			
código	700716	referencia	0100344 SIR0100344
descripción	bisagra para marmita		

accesorios

otros

			
código	694495	referencia	CM219300 MACM219300
descripción	casquillo separador para bisagra de tapa para sartén basculante int.ø 18.2mm ø ext. 20mm L 20mm acero inoxidable		
Para modelos:	SE84CRA, SE84CRM, SE84FRA, SE84FRM, SE84IRA, SE84IRM, SE86CRA, SE86FRA, SE86IRA, SE96CRA, SE96FRA, SE96IRA, SG84CRA, SG84CRM, SG84IRA, SG84IRM		

			
código	514231	referencia	CM051503 MACM051503
descripción	pasador de bisagra sartén basculante marmita serie 700/900		
Para modelos:	EPE50, EPE7108, EPG50, EPG7108, PE8AI10, PE8AI15, PE8NI10, PE8NI15, PE9AI10, PE9AI15, PE9NI10, PE9NI15, PG8AD10, PG8AD15, PG8AI10, PG8AI15, PG8ND10, PG8ND15, PG8NI10, PG8NI15, PG9AD10, PG9AD15, PG9AI10, PG9AI15, PG9ND10, PG9ND15, PG9NI10, PG9NI15, SE84CRA, SE84CRM, SE84FRA, SE84FRM, SE84IRA, SE84IRM, SE86CRA, SE86FRA, SE86IRA, SE96CRA, SE96FRA, SE96IRA, SG84CRA, SG84CRM, SG84IRA, SG84IRM		

grifería para cocinas industriales
aireadores y purgadores

			
código	540827	referencia	0100573 BN6A021600 SIR0100573
descripción	aireador/purgador rosca 3/4" M cromado L 45mm ø 36mm		

			
1			
código	540824	referencia	0100568 SIR0100568
descripción	válvula de compensación de presión rosca 1/4" M EC 19 cromado L 18mm		
Para modelos:	CPE70150, CPE7-150, PE7NI05		

bisagras de tapa

otros



piezas de repuesto

			
1			
código	691659	referencia	CM192301 MACM192301
descripción	extensión para bisagra de tapa ø 18mm L 209mm desde 2003		
Para modelos:	SE84CRA, SE84CRM, SE84FRA, SE84FRM, SE84IRA, SE84IRM, SG84CRA, SG84CRM, SG84IRA, SG84IRM		

grifos de vaciado

latón

grifos de vaciado

			
1			
código	540131	referencia	0100541 MA1677800 SIR0100541
descripción	grifo de vaciado 1 1/4" F latón cromado		
repuestos para	540131		
	código	540213	referencia —
	manilla int.ø 5mm L 117mm		
	código	540461	referencia —
	arandela distanciadora para grifo de vaciado		
	código	540464	referencia —
	tuerca para grifo de vaciado rosca 1 1/2"		

			
1			
código	540275	referencia	0100531 BN6A021000 CM128900 MACM128900 SIR0100531
descripción	grifo de vaciado 2" H con tuerca de racor A 90mm B 151mm B1 80mm latón cromado		
Para modelos:	CPD90100, CPD90100A, CPD90100AP, CPD90100A-P, CPD90100P, CPD90150, CPD90150A, CPD90150AP, CPD90150A-P, CPD90150P, CPE90100, CPE90100A, CPE90150, CPE90150A, CPI90100, CPI90100A, CPI90100AP, CPI90100A-P, CPI90100P, CPI90150, CPI90150A, CPI90150AP, CPI90150A-P, CPI90150P, PE8AI10, PE8AI15, PE8NI10, PE8NI15, PE9AI10, PE9AI15, PE9NI10, PE9NI15, PG8AD10, PG8AD15, PG8AI10, PG8AI15, PG8ND10, PG8ND15, PG8NI10, PG8NI15, PG9AD10, PG9AD15, PG9AI10, PG9AI15, PG9ND10, PG9ND15, PG9NI10, PG9NI15		
repuestos para	540275		
	código	540214	referencia —
	manilla int.ø 6mm L 145mm		
accesorios para	540275		
	código	529484	referencia —
	junta plana fibra ø ext. 58mm int.ø 50mm espesor 2mm UE 1 pzs		
	código	542448	referencia —
	junta silicona 60x49x2 para grifo de vaciado 2"		

			
1			
código	540276	referencia	0100532 SIR0100532
descripción	grifo de vaciado empalme con tuerca de racor rosca 1 1/2"		
Para modelos:	CPD70150, CPE70150, CPE7-150, CPI70150, PE7NI05, PG7ND05, PG7NI05		
repuestos para	540276		
	código	532374	referencia —
	junta tórica silicona espesor 5.34mm int.ø 43.82mm UE 10 pzs		
accesorios para	540276		
	código	514251	referencia —
	junta fibra ø ext. 46mm int.ø 38mm espesor 2mm UE 1 pzs		



accesorios



1			
código	699248	referencia	77121900 MA77121900
descripción	juego de juntas tóricas silicona 2" para grifo de vaciado UE 3 pzs		
Para modelos:	EPE9D10, EPE9D15, EPE9I10, EPE9I10A, EPE9I15, EPE9I15A, EPG9D10, EPG9D10A, EPG9D15, EPG9D15A, EPG9I15, EPG9I15A, EPG9I10, EPG9I10A		

grifos de seguridad

accesorios



1			
código	540816	referencia	0100571 SIR0100571
descripción	soporte para grifería rosca 1 1/4"		
Para modelos:	CPE70150, CPE7-150, PE7NI05		



1			
código	540821	referencia	0100578 SIR0100578
descripción	soporte para grifería rosca 1 1/4"		



1			
código	540860	referencia	0100580 SIR0100580
descripción	soporte para grifería rosca 3/4" M apto para manómetro		



1			
código	540836	referencia	0100575 BN6A021700 SIR0100575
descripción	tolva de llenado rosca 1/2" con válvula de cierre		
Para modelos:	CPE70150, CPE7-150, PE7NI05		



1			
código	540830	referencia	0100577 SIR0100577
descripción	grifo de manómetro H 1/4" M 1/4"		



1			
código	540829	referencia	0100579 SIR0100579
descripción	sifón manómetro rosca 1/2"		
Para modelos:	CPE70150, CPE7-150, PE7NI05		

válvulas de seguridad



1			
código	540721	referencia	0100587 0100589 BN6A021510 SIR0100587 SIR0100589
descripción	válvula de seguridad presión de intervención 0.5bar M88 rosca 1 1/4"		
Para modelos:	CPE70150, CPE7-150, PE7NI05		

accesorios para	540721		
	código	541501	referencia
			—
	reducción para grifo de seguridad H 1 1/4" M 3/4"		

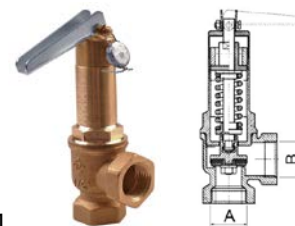

1			
código	540909	referencia	0102494 327900 MA327900 SIR0102494
descripción	válvula de seguridad G1: 1/2" G2: 1/2" presión de intervención 0.5bar		
Para modelos:	CPD90100A, CPD90100AP, CPD90100A-P, CPD90150A, CPD90150AP, CPD90150A-P, CPE90100A, CPE90150A, CPI90100A, CPI90100AP, CPI90150A, CPI90150AP, EPE9D10, EPE9D15, EPE9I10, EPE9I10A, EPE9I15, EPE9I15A, EPG9D10, EPG9D10A, EPG9D15, EPG9D15A, EPG9I15, EPG9I15A, EPG9I10, EPG9I10A, PE8A110, PE8A115, PE8NI10, PE8NI15, PE9A110, PE9A115, PG8AD10, PG8AD15, PG8A110, PG8A115, PG8ND10, PG8ND15, PG8NI10, PG8NI15, PG9AD10, PG9AD15, PG9A110, PG9A115, PG9ND10, PG9ND15, PG9NI10, PG9NI15		

pies para aparatos y tapas terminales

pies roscados



1

código	514009	referencia	1036021600 1036021613 MA1036021600 MA1036021613
descripción	pie de aparato L 50mm An 29mm H 25mm taladro ø 10mm distancia de sujeción 40mm UE 1 pzs		
Para modelos:	BG62TLC, BG62TLL, BG62TRR, BG63TLC, BG63TLL, BG63TLR, BG64TLC, BG64TLL, BG64TLR, BMG-40, BMG-60, CBE6220, CCT6220V, CCT6230V, CCW6220, CEN6220, CEN6220C, CEN6230, CEN6230C, CFG62110, CFG62210, CGG6220, CGG6220C, CGG6220R, CGG6230, CGG6230C, CGG6230LR, CGG6240, CGG6240C, CGG6240LR, CLA6230, CME6220, CME6230, CME6240, CNE6230, CRE6220, CRE6230, CRG6220, CRG6240, CSP6220, CV62TPS, CV64TPS, CW62TPS, DE63128, EL63TPS, EN62T1C, EN62TPS, EN63T1C, EN63TPS, FG62T08...(Otros modelos se puede ver en la tienda web)		

cestos

cestos para freidoras

SILKO



1

código	970920	referencia	CR0686180
descripción	cesto de freidora B1 225mm L1 360mm H1 120mm L2 630mm H2 220mm acero cromado		
Para modelos:	EFE72115, EFE74215, EFE92115, EFE94215, EFG72110, EFG72115, EFG73210, EFG74215, EFG92115, EFG92115S, EFG93210, EFG94215, EFG94215S		



1

código	970451	referencia	0109091 SIR0109091
descripción	cesto de freidora L1 280mm B1 100mm H1 100mm acero cromado		
Para modelos:	CFE60110, CFE60210, CFE70110-0, CFE72110-0, FE72T10		



1

código	970215	referencia	0109089 SIR0109089
descripción	cesto de freidora L1 280mm B1 200mm H1 100mm acero cromado		
Para modelos:	CFE60110, CFE60210, CFE70110-0, CFE72110-0, FE72T10		



1

código	970138	referencia	0101100 0101114 SIR0101100 SIR0101114
descripción	cesto de freidora L1 290mm B1 135mm H1 120mm L2 490mm H2 175mm H3 220mm acero cromado		
Para modelos:	CFE70110, CFE70110-2, CFE70210, CFE70210-2, CFE70210-M, CFE72210, CFE90210, CFE90210-2, CFG90210, CFG90210S, FE72210, FE92210, FG92210, FGY2210		



1

código	970357	referencia	0101098 SIR0101098
descripción	cesto de freidora L1 290mm B1 165mm H1 120mm acero cromado		



1

código	970367	referencia	0101116 SIR0101116
descripción	cesto de freidora L1 290mm B1 230mm H1 120mm		



1

código	970356	referencia	0101099 SIR0101099
descripción	cesto de freidora L1 290mm B1 230mm H1 120mm acero cromado		
Para modelos:	CFE70115, CFE70115-2, CFE70115-M, CFE70215, CFE70215-2, CFE70215-M, CFE72215, CFG70115, CFG70215, CFG72215		



1

código	970352	referencia	0105040 CM030200 MACM030200 SIR0105040
descripción	cesto de freidora L1 360mm B1 160mm H1 120mm acero cromado		
Para modelos:	FE82118, FE84218, FE92118, FE94218, FEY2118, FEY4218, FG82122, FG84222, FG92122, FG94222, FGY2122, FGY4222		



1

código	970358	referencia	0101102 SI0101102 SIR0101102
descripción	cesto de freidora L1 290mm B1 330mm H1 120mm L2 507mm H2 175mm H3 220mm acero cromado		
Para modelos:	CFE90120, CFE90120-2, CFE90220, CFE90220-2, CFG90120, CFG90220		



1

imagen no disponible

código	970137	referencia	0109090 SIR0109090
descripción	cesto de freidora L1 295mm B1 200mm H1 105mm		
Para modelos:	CFE60110, CFE60210, CFE70110-0, CFE72110-0, FE72T10		



1

código	970217	referencia	0109005 SIR0109005
descripción	cesto de freidora L1 300mm B1 230mm H1 105mm		
Para modelos:	CFE60110-5, CFE60110-9, CFE60210-5, CFE60210-9, CFG60110, CFG60210		

cestas para pasta

SILKO



1

código	970205	referencia	0101125 SIR0101125
descripción	cesta para pasta L1 165mm B1 300mm H1 230mm H3 415mm acero inoxidable		
Para modelos:	CNE90140, CNE90140-S, CNG90140, CNG90140-S, DE92140, DG92140		



1

código	970204	referencia	0101122 SI0101122 SIR0101122
descripción	cesta para pasta L1 300mm B1 150mm H1 215mm		
Para modelos:	CNE70130, CNE70160, CNE72130, CNE72160, CNE90130, CNE90130-S, CNE90140, CNE90140-S, CNE90160, CNE90160S, CNE90160-S, CNE90230, CNE90240, CNG70130, CNG70160, CNG70230, CNG72160, CNG72230, CNG90130, CNG90130-S, CNG90140, CNG90140-S, CNG90160, CNG90160S, CNG90160-S, CNG90230, CNG90240, DE72125, DE74170, DE92140, DE94170, DE94240, DEY4160, DG72125, DG74155, DG74225, DG92140, DG94160, DG94240, DGY4160		

tamices para empanar



código	970222	referencia	0109092 SIR0109092
descripción	tamiz para empanar L 303mm An 212mm apto para freidora		
Para modelos:	CFE60110, CFE60210, CFE70110-0, CFE72110-0, FE72T10		

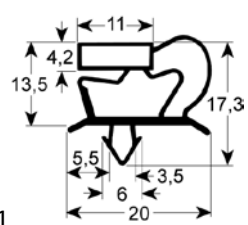

código	901777	referencia	0102466 SIR0102466
descripción	junta para frigorífico perfil 9048 An 310mm L 410mm medida inserción		

rejillas y rieles guía

parrillas

universal

con reborde



código	970626	referencia	1440065530 BN1440065530
descripción	parrilla An 650mm P 530mm GN 2/1 acero plastificado con tope traviesas 2 gris apto para refrigerador		

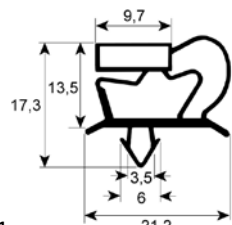

código	901415	referencia	SIR227017971
descripción	junta para frigorífico perfil 9048 An 350mm L 675mm medida inserción		

juntas

juntas para frigoríficos

juntas insertables

perfil 9048

Fabricamos burletes personalizables de este perfil

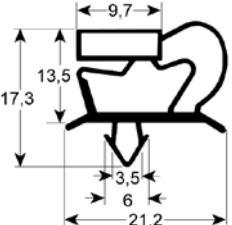

código	901704	referencia	RA190101 SIRRA190101
descripción	junta para frigorífico perfil 9048 An 280mm L 400mm medida inserción		

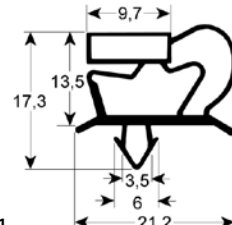

código	901700	referencia	RA 190100 RA190010 SIRA190010 SIRRA 190100
descripción	junta para frigorífico perfil 9048 An 400mm L 597mm medida inserción		

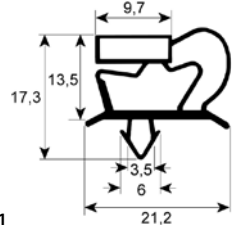

código	901214	referencia	FR995948old
descripción	junta para frigorífico perfil 9048 An 435mm L 695mm medida inserción		

código	901212	referencia	FR995950old
descripción	junta para frigorífico perfil 9048 An 695mm L 1210mm medida inserción		

perfil 9783

Fabricamos burlletes personalizables de este perfil

código	902306	referencia	N/A
descripción	junta para frigorífico perfil 9783 Anmm L 2500mm		

juntas térmicas

juntas para puertas

código	900727	referencia	LB848-00 SIR0103245 SIRLB848-00
descripción	junta de puerta perfil 2930 UE al metro		
Para modelos:	CCG6020, CCG6040, CCG6045, CCG6046, CCG7001, CCG7001P, CCG7201, CCG7245, CCG7246, CCG72652, CCG72653, CCG72662, CCG72663, CCQ7046, CCQ70663, CCT6046, CCT7046, CCT70663, CCT7246V, CG76HPS, CG86HPS, CV74EPS		

juntas tóricas

EPDM

código	532118	referencia	0108056 SIR0108056
descripción	junta tórica EPDM espesor 3.53mm int.ø 55.56mm UE 10 pzs		
Para modelos:	CFE70110, CFE70110-2, CFE70115, CFE70115-2, CFE70115-M, CFE70210, CFE70210-2, CFE70210-M, CFE70215, CFE70215-2, CFE70215-M, CFE72210, CFE72215, CFE90120, CFE90120-2, CFE90210, CFE90210-2, CFE90220, CFE90220-2, FE72210, FE92210		

silicona

código	514017	referencia	0105169 0105246 1814400 MA1814400 SIR0105169 SIR0105246
descripción	junta tórica silicona espesor 3.53mm int.ø 32.93mm UE 1 pzs		
Para modelos:	CNE6230, DE63128, DE72128, DE74228, DE82140, DE82142, DE82T42, DE84240, DE84242, DE84T42, DE92142, DE94242, DEY2142, DEY4242		

Viton

código	528687	referencia	0105034 CM097900 MACM097900 SIR0105034
descripción	junta tórica Viton espesor 1.78mm int.ø 3.69mm UE 1 pzs		
Para modelos:	CFE62110/1, CFE62210/1, EFE72110, EFE72115, EFE73210, EFE74215, EFE92115, EFE92122, EFE92122K, EFE93210, EFE94215, EFE94222, EFE94222K, EFG72108, EFG72110, EFG72115, EFG73208T, EFG73210, EFG74215, EFG92115, EFG92115S, EFG92123, EFG92123K, EFG93210, EFG94215, EFG94215S, EFG94223, EFG94223K, FE62T10, FE64T10, FE72112, FE72206, FE72T10, FE74212, FE74T10, FE82118, FE82206, FE82T18, FE84218, FE84T18, FE92118, FE92206, FE94218, FEY2118, FEY2206, FEY4218, FG72115, FG72206, FG74215, FG82122...(Otros modelos se puede ver en la tienda web)		

código	550496	referencia	0105021 CM099200 MACM099200 SIR0105021
descripción	junta tórica Viton espesor 3.53mm int.ø 50.39mm UE 1 pzs		
Para modelos:	CFE62110/1, CFE62210/1, EDE72128, EDE73142, EDE74228, EDE92142, EDE93142, EDE94242, EFE72110, EFE72115, EFE73210, EFE74215, EFE92115, EFE92122, EFE92122K, EFE93210, EFE94215, EFE94222, EFE94222K, FE62T10, FE64T10, FE72112, FE72206, FE72T10, FE74212, FE74T10, FE82118, FE82206, FE82T18, FE84218, FE84T18, FE92118, FE92206, FE94218, FEY2118, FEY2206, FEY4218		



código	510245	referencia	0108055 SIR0108055
descripción	junta tórica Viton espesor 3.53mm int.ø 50.8mm UE 1 pzs		
Para modelos:	CFE70110, CFE70110-2, CFE70115, CFE70115-2, CFE70115-M, CFE70210, CFE70210-2, CFE70210-M, CFE70215, CFE70215-2, CFE70215-M, CFE72210, CFE72215, CFE90120, CFE90120-2, CFE90210, CFE90210-2, CFE90220, CFE90220-2, FE72210, FE92210		

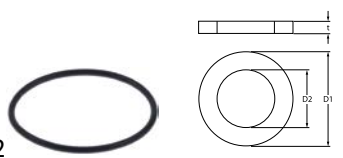

código	532681	referencia	CR0582140
descripción	junta tórica Viton espesor 3.53mm int.ø 66.27mm UE 1 pzs		
Para modelos:	EDE72128, EDE73142, EDE74228, EDE92142, EDE93142, EDE94242, EFE72115, EFE74215, EFE92115, EFE92122, EFE92122K, EFE94215, EFE94222, EFE94222K		

anillos de junta

juntas de fibra



código	510404	referencia	CR0682770
descripción	junta plana fibra ø ext. 44mm int.ø 34mm espesor 2mm UE 1 pzs		

juntas de PTFE



código	514016	referencia	0105170 MA1814500 SIR0105170
descripción	junta plana PTFE ø ext. 45mm int.ø 40mm espesor 4mm UE 1 pzs núm. Ref. 1036500400/1814500 para MARENO		
Para modelos:	DE72128, DE74228, DE82140, DE84240, DE92142, DE94242, DEY2142, DEY4242		

juntas de silicona



código	691332	referencia	2993700 MA2993700
descripción	junta plana silicona ø ext. 13.8mm int.ø 6mm espesor 1.5mm UE 1 pzs		
Para modelos:	CBE6220, CCT6220V, CCT6230V, CCW6220, CFE62110/1, CFE62210/1, CM72APS, CM82APS, CME6220, CME6230, CME6240, CNE6230, CRE6220, CRE6230, CSP6220, CV62TPS, CV64TPS, CW62TPS, DE63128, ERP72, FE62T10, FE64T10, FE72206, FE82206, FE92206, FEY2206, GE62TPS, GE63TPS, ME62TPS, ME63TPS, ME64TPS, RP62TPS, SE62TPS, SG86CRA, SG86FRA, SG86IRA, SG96CRA, SG96FRA, SG96IRA		

técnica de accionamiento y rodamientos de bolas

rodamientos de bolas

cajinetes brida



código	693112	referencia	0100430 SI0100430 SIR0100430
descripción	coinete de brida tipo UCF204 árbol ø 20mm brida 4 orificios dist. del agujero 64mm H 33mm longitud brida 86mm anchura brida 86mm agujero ø 12mm brida F204 rodamiento de bolas UC204G2 altura brida 25.5mm		
Para modelos:	CBE7050, CBE7050C, CBE9060, CBE9060C, CBG7050, CBG9060C-I, CBG9060CP, CBG9060C-P, CBG9060P, SE74CRM, SE74FRM, SE74IRM, SE84CRM, SE84FRM, SE84IRM, SE94CRA, SE94CRM, SE94FRA, SE94FRM, SE94IRA, SE94IRM, SG74CRM, SG74IRM, SG84CRM, SG84IRM, SG94CRA, SG94CRM, SG94FRA, SG94FRM, SG94IRA, SG94IRM		

muelles

muelles de torsión





código	514226	referencia	139732 MA139732
descripción	resorte de torsión ø 32.3mm L2 192mm espesor de hilo 5.9mm L1 14mm marmita serie 700 serie 900		
Para modelos:	EPE50, EPG50, PE8AI10, PE8AI15, PE8NI10, PE8NI15, PE9AI10, PE9AI15, PE9NI10, PE9NI15, PG8AD10, PG8AD15, PG8AI10, PG8AI15, PG8ND10, PG8ND15, PG8NI10, PG8NI15, PG9AD10, PG9AD15, PG9AI10, PG9AI15, PG9ND10, PG9ND15, PG9NI10, PG9NI15, SE84CRA, SE84CRM, SE84FRA, SE84FRM, SE84IRA, SE84IRM, SE86CRA, SE86FRA, SE86IRA, SE96CRA, SE96FRA, SE96IRA, SG84CRA, SG84CRM, SG84IRA, SG84IRM		

manómetros



código	541334	referencia	0102491 41853310148 BN41853310148 SIR0102491
descripción	manómetro ø 60mm margen de presión 0 a 1bar rosca 1/8" marca 0.5 marmita empalme lado posterior		
Para modelos:	CPE90100, CPE90100A, CPE90150, CPE90150A, CPI70150, CPI90100, CPI90100A, CPI90100AP, CPI90100A-P, CPI90100P, CPI90100-P, CPI90150, CPI90150A, CPI90150AP, CPI90150A-P, CPI90150P, CPI90150-P, PE7NI05, PE8AI10, PE8AI15, PE8NI10, PE8NI15, PE9AI10, PE9AI15, PE9NI10, PE9NI15, PG7ND05, PG7NI05, PG8AD10, PG8AD15, PG8AI10, PG8AI15, PG8ND10, PG8ND15, PG8NI10, PG8NI15, PG9AD10, PG9AD15, PG9AI10, PG9AI15, PG9ND10, PG9ND15, PG9NI10, PG9NI15		



 <p>1</p>			
código	541062	referencia	0100576 BN6A021900 SIR0100576
descripción	manómetro ø 63mm margen de presión 0 a 1bar empalme marca ajustable marmita rosca 1/4"		
Para modelos:	CPE70150, CPE7-150, PE7NI05		
repuestos para	541062		
	código	541130	referencia
		vidrio ø 58mm espesor 2mm	

grifería

piezas de repuesto

no para webshop

piezas de repuesto

grifos

 <p>1</p>			
código	540907	referencia	0102747 SI0102747 SIR0102747
descripción	grifo mezclador de 1 orificio altura salida con cañomm		
Para modelos:	PE8AI10, PE8AI15, PE8NI10, PE8NI15, PG8AD10, PG8AD15, PG8AI10, PG8AI15, PG8ND10, PG8ND15, PG8NI10, PG8NI15		



dosificadores

bombas de membrana

autoaspirantes

LARGO

accesorios

 <p>1</p>			
código	101286	referencia	0100743 0100745 LA62070023 LAR62070023 SIR0100743
descripción	anillo cortante int.ø 6mm UE 1 pzs		
Para modelos:	BG92ALC, BG92ALL, BG92ARC, BG92ARR, BG92GLC, BG92GLL, BG92GRC, BG92GRR, BG94ALC, BG94ALL, BG94ALR, BG94AMC, BG94ARC, BG94ARR, BG94GLC, BG94GLL, BG94GLR, BG94GMC, BG94GRC, BG94GRR, BGY2TLC, BGY2TLL, BGY2TRC, BGY2TRR, BGY4TLC, BGY4TLL, BGY4TLR, BGY4TMC, BGY4TRC, BGY4TRR, CBG7050, CBG7050C, CBG9060CP, CBG9060C-P, CBG9060P, CCG1041P, CCG1042P, CCG1045, CCG1045P, CCG1061P, CCG1062P, CCG10652, CCG10652P, CCG10653, CCG1081P, CCG1082P, CCG1085, CCG10852, CCG1085P, CCG7001...(Otros modelos se puede ver en la tienda web)		
accesorios para	101286		
	código	100909	referencia
		0100744 SIR0100744	
	tornillo de racor rosca M10x1 para tuboø 6mm UE 1 pzs		
	código	101464	referencia
		—	
	tuerca de racor rosca M12x1 para ø de tubo 6mm		

guarniciones, empalmes para mangueras y tubos

empalmes de tubo

plástico

 <p>1</p>			
código	362011	referencia	LA62090538 LAR62090538
descripción	empalme de tubo plástico recto rosca 1/4" tubo ø 8x6mm UE 1 pzs		



racores para tubería

JOHN GUEST



1

código	440019	referencia	LA62090548 LAR62090548
descripción	racor para tubería John Guest recto empalme de tubo ø6mm boquilla ø 10mm		
Para modelos:	EMT06P		
accesorios para	440019		
	código	520971	referencia —
	tubo flexible grosor de la pared 1mm LLDPE azul int.ø 4mm ø ext. 6mm presión de trabajo a 20°C 16bar		



1

código	514325	referencia	0108002 MA1950700 SIRO108002
descripción	válvula de bola empalme 1" H - 1" H DN25 longitud 83mm con manilla de palanca		



1

código	540758	referencia	0100605 BN6A023010 SIRO100605
descripción	válvula de bola empalme 1" H - 1" M DN25 longitud 90mm con manilla de palanca longitud de asidero 95mm		
Para modelos:	CNE90130, CNE90130-S, CNE90140, CNE90140-S, CNE90160, CNE90160S, CNE90160-S, CNE90230, CNE90240, CNG50150, CNG50160, CNG70130, CNG70160, CNG70230, CNG72160, CNG72230, CNG90130, CNG90130-S, CNG90140, CNG90140-S, CNG90160, CNG90160S, CNG90160-S, CNG90230, CNG90240, DE92140, DE94170, DE94240, DEY4160, DG72125, DG74155, DG74225, DG92140, DG94160, DG94240, DGP4150, DGPT160, DGY4160		

válvulas y caños de pared

válvulas de bola

universal

válvulas de bola con maneta de mariposa



1

código	540658	referencia	0100593 SIRO100593
descripción	válvula de bola empalme 3/4" H - 3/4" H DN20 longitud 69mm		
Para modelos:	BAM16D, BAM16S, BAM18D, BAM18S, BAM20D, BAM20S, CME7021, CME7022, CME7041, CME7042, CME7221, CME7222, CME7241, CME7242, CME9020, CME9040, ME72APS, ME72GPS, ME74APS, ME74GPS, ME82GPS, ME84GPS, MEY2TPS, MEY4TPS		

válvulas de bola con manilla de palanca



1

código	520282	referencia	0100590 0108062 SIRO100590 SIRO108062
descripción	válvula de bola empalme 1" H - 1" H DN25 longitud 67mm con manilla de palanca		
Para modelos:	CFE70110, CFE70110-2, CFE70115, CFE70115-2, CFE70115-M, CFE70210, CFE70210-2, CFE70210-M, CFE70215, CFE70215-2, CFE70215-M, CFE72210, CFE72215, CFE90120, CFE90120-2, CFE90210, CFE90210-2, CFE90220, CFE90220-2, CFG70115, CFG70215, CFG72215, CFG90120, CFG90210, CFG90210S, CFG90220, CNE70130, CNE70160, CNE72130, CNE72160, DE72125, DE72128, DE74170, DE74228, DE82140, DE82142, DE82T42, DE84240, DE84242, DE84T42, DE92142, DE94242, DEY2142, DEY4242, DG72128, DG74228, DG82140, DG82142, DG82T42, DG84240...(Otros modelos se puede ver en la tienda web)		



válvulas de cierre

específico del fabricante

SILKO



código	540656	referencia	0100540 0102613 SI0102613 SIR0100540 SIR0102613
descripción	válvula de cierre empalme 1/2" recto longitud 54mm rosca de roseta G2 26x19G L1 34mm L2 27mm		
Para modelos:	CBE7050, CBE7050C, CBG7050, CBG7050C, CBG9060CP, CBG9060C-P, CBG9060P, CME1021, CME1022, CME9020, CME9021, CME9022, CME9040, CME9041, CME9042, CMG7041, CMG7042, CMG9021, CMG9022, CMG9041, CMG9042, CNE6030, CNE70130, CNE70160, CNE72130, CNE72160, CNE90130, CNE90130-S, CNE90140, CNE90140-S, CNE90160, CNE90160S, CNE90160-S, CNE90230, CNE90240, CNG50150, CNG50160, CNG70130, CNG70160, CNG70230, CNG72160, CNG72230, CNG90130, CNG90130-S, CNG90140, CNG90140-S, CNG90160, CNG90160S, CNG90160-S, CNG90230... (Otros modelos se puede ver en la tienda web)		
repuestos para	540656		
	código	514085	referencia —
	roseta empalme 26x19G cromado longitudmm pos. de montaje		
	código	514086	referencia —
	tuerca hexagonal empalme 26x19G latón longitudmm pos. de montaje H 6mm EC 34 UE 1 pzs		

sistemas de desagüe y lavabos

piletas de desagüe

universal



código	515041	referencia	0100555 1138600 MA1138600 SIR0100555
descripción	pileta de desagüe medida 3/4" altura útilmm altura total 30mm ø ext. 38mm latón cromado		
Para modelos:	BAM16D, BAM16S, BAM18D, BAM18S, BAM20D, BAM20S, CME1021, CME1022, CME7021, CME7022, CME7041, CME7042, CME7221, CME7222, CME7241, CME7242, CME9020, CME9021, CME9022, CME9040, CME9041, CME9042, CMG7041, CMG7042, CMG9021, CMG9022, CMG9041, CMG9042, ME72APS, ME72GPS, ME74APS, ME74GPS, ME82GPS, ME84GPS, ME92APS, ME92GPS, ME94APS, ME94GPS, MEP2APS, MEP2GPS, MEY2TPS, MEY4TPS, MG92APS, MG92GPS, MG94APS, MG94GPS		
accesorios para	515041		
	código	515047	referencia —
	tubo vertical medida 3/4" altura útil 28mm altura total 54mm ø ext. 20mm latón cromado con junta tórica		
	código	515048	referencia —
	tubo vertical medida 3/4" altura útil 48mm altura total 74mm ø ext. 20mm latón cromado con junta tórica		
	código	515049	referencia —
	tubo vertical medida 3/4" altura útil 68mm altura total 94mm ø ext. 20mm latón cromado con junta tórica		
	código	515050	referencia —
	tubo vertical medida 3/4" altura útil 98mm altura total 124mm ø ext. 20mm latón cromado con junta tórica		



tubos verticales

3/4"



código	515041	referencia	0100555 1138600 MA1138600 SIR0100555
descripción	pileta de desagüe medida 3/4" altura útilmm altura total 30mm ø ext. 38mm latón cromado		
Para modelos:	BAM16D, BAM16S, BAM18D, BAM18S, BAM20D, BAM20S, CME1021, CME1022, CME7021, CME7022, CME7041, CME7042, CME7221, CME7222, CME7241, CME7242, CME9020, CME9021, CME9022, CME9040, CME9041, CME9042, CMG7041, CMG7042, CMG9021, CMG9022, CMG9041, CMG9042, ME72APS, ME72GPS, ME74APS, ME74GPS, ME82GPS, ME84GPS, ME92APS, ME92GPS, ME94APS, ME94GPS, MEP2APS, MEP2GPS, MEY2TPS, MEY4TPS, MG92APS, MG92GPS, MG94APS, MG94GPS		
accesorios para	515041		
	código	515047	referencia —
	tubo vertical medida 3/4" altura útil 28mm altura total 54mm ø ext. 20mm latón cromado con junta tórica		

Continúa en la página siguiente

accesorios para	515041		
	código	515048	referencia —
	tubo vertical medida 3/4" altura útil 48mm altura total 74mm ø ext. 20mm latón cromado con junta tórica		
	código	515049	referencia —
	tubo vertical medida 3/4" altura útil 68mm altura total 94mm ø ext. 20mm latón cromado con junta tórica		
	código	515050	referencia —
	tubo vertical medida 3/4" altura útil 98mm altura total 124mm ø ext. 20mm latón cromado con junta tórica		

material auxiliar

abrazaderas

abrazaderas de tubo

DIN 3017 - W2



código	520112	referencia	LAR61630011
descripción	abrazadera de tubo ø 12-20mm ancho 9mm UE 10 pzs DIN 3017		
Para modelos:	EMT06P, GMT06D, GVT10D		

herramientas

herramientas de limpieza

rasquetas



código	705008	referencia	2510513 BN2510513
descripción	rasqueta para plancha grill		
repuestos para	705008		
	código	705021	referencia —
	cuchillas de recambio para rasqueta UE 10 pzs		

código	705009	referencia	1030000600 2510513 (old version) BN2510513 (old version) MA1030000600
descripción	rasqueta para plancha grill An 80mm		
Para modelos:	BG62TLC, BG62TLL, BG62TRR, BG63TLC, BG63TLL, BG63TLR, BG64TLC, BG64TLL, BG64TLR, CGG6220, CGG6220C, CGG6220R, CGG6230, CGG6230C, CGG6230LR, CGG6240, CGG6240C, CGG6240LR, CM72APS, CM82APS, EBE7, EBG7, EBG7-CROMO, ECM73		

material de sujeción

sujeciones

abrazaderas

abrazaderas de tubo

DIN 3017 - W2



código	520112	referencia	LAR61630011
descripción	abrazadera de tubo ø 12-20mm ancho 9mm UE 10 pzs DIN 3017		
Para modelos:	EMT06P, GMT06D, GVT10D		

consumibles

fusibles

fusibles térmicos



código	358095	referencia	CR0841170
descripción	fusible térmico temp. desconexión 110°C nominal 10A UE 1 pzs		
Para modelos:	ETE74		

A			
abrazaderas	132, 132	juntas para frigoríficos	126
abrazaderas de tubo	132, 132	juntas para puertas	127
accesorios eléctricos	47	juntas térmicas	127
anillos de junta	128	juntas tóricas	127
aparatos de mando y aviso	35		
B		L	
bisagras de resorte	120	lámparas	36
bisagras para hornos	120	lámparas de descarga	36, 37
boquillas de gas	95	lámparas de señalización	36
		lámparas de señalización completas	36
C		M	
cables	47	material de sujeción	132
cables de calefacción	14	microinterruptores	31
cables de encendido	75	motores	47
clips para bulbo	29		
conmutadores de levas	32	P	
conmutadores giratorios	34	parrillas	126
consumibles	132	pasacables	47
contactores	37	piletas de desagüe	131
controladores electrónicos	40	pilotos de encendido	62
		placas de cocción	18
		presostatos	44, 108
D		Q	
dosificadores	129	quemadores de cocina	80
		quemadores de gas	80
E		quemadores para placas radiantes	95
electródos	44	quemadores tubulares	92, 94
empalmes de tubo	129		
encendedores piezoeléctricos	76	R	
F		racores para cables	47
fusibles	47, 132	racores para tubería	130
fusibles térmicos	132	radiadores cerámicos	14
		reguladores de energía	19
G		rejillas y rieles guía	126
grifería	129	relés	39
grifos de gas	48	resistencias	3
		resistencias circulación de aire	16
H		resistencias de descongelación	10
herramientas	132	resistencias de inmersión	15
herramientas de limpieza	132	resistencias fry top	13
		resistencias para baño maría	3
I		resistencias para calentadores de patatas fritas	4
interruptores de encendido	78	resistencias para calentadores de platos	14
interruptores posicionales	31	resistencias para cuecepasta	11
interruptores pulsantes y pulsadores	30	resistencias para freidora	5
interruptores y pulsadores	30	resistencias para hornos	3
interruptores/pulsadores basculantes	30	resistencias para placas de cocina grandes	10
		resistencias para plancha grills	8
J		resistencias para refrigeración	10
juntas insertables	126	resistencias para sartenes	4
		resistencias para sartenes basculantes	10

resistencias radiantes	16
resortes de fijación	29
S	
señalizadores de alarma	37
sensores	41
sensores universales	41
sistemas de desagüe y lavabos	131
sondas al corazón	41
sondas de temperatura	41
sujeciones	132
T	
terminales	47
termopares	78
termostatos	20
termostatos de regulación	20
termostatos de seguridad	24
termostatos para gas	54
transformadores	40
tubos verticales	131
U	
unidades de encendido	77
V	
válvulas de bola	130
válvulas de cierre	131
válvulas de control de gas	59
válvulas magnéticas	43
válvulas y caños de pared	130
ventilador axial	45
ventiladores	45
ventiladores de aire caliente	46
ventiladores de refrigeración	45
ventiladores para frigoríficos	45
ventiladores tangenciales	46