



COMPONENTI PER GAS



COMPONENTI ELETTRICI



COMPONENTI PER ACQUA



COMPONENTI MECCANICI



UTENSILI

Ricambi adatti a

STAFF ICE SYSTEM

Per la gamma completa sempre aggiornata visitate il nostro internet shop



Catalogo dei produttori

Per ciascun produttore, le parti di ricambio e gli accessori sono elencati in modo chiaro

- ✓ Assortimento completo e tutti i dati degli apparecchi sempre aggiornati nel Internetshop GEV
- ✓ Indice alfabetico alla fine del catalogo

Internetshop GEV Fast ricambi

www.fastricambi.it



- 🔍 Segna articolo come preferito
- 🔍 Procedi al log-in inserendo l'indirizzo mail e la password
- 🔍 Ordine Comfort – carica nel carrello una lista di articoli
- 🔍 Cerca ricambi in Cercafacile senza bisogno del log-in



resistenze

accessori

anelli di tenuta

O.R.

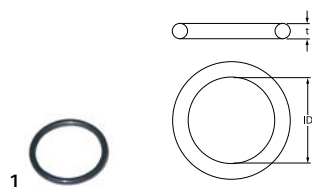

codice	510072	cod. costr.	RICG20141
descrizione	O.R. EPDM spessore 3.53mm int. ø 32.93mm conf. 1 pz		

termostati

termostati per frigoriferi

RANCO

serie K50

RANCO



codice	390849	cod. costr.	SL300350467 SL37AAL3231
descrizione	termostato RANCO tipo K50-L3231/002 bulbo ø 1.9mm bulbo Lmm lungh. capillare 1200mm		

serie K61

RANCO



codice	390206	cod. costr.	4007015000
descrizione	termostato RANCO tipo K61L1501 bulbo ømm bulbo Lmm lungh. capillare 1800mm		

interruttori e pulsanti

microinterruttori

azionamento a leva



codice	347674	cod. costr.	3010314000 3010319000 3010320000 3010321000
descrizione	microinterruttore 250V 3A 1CO attacco Faston maschio 6,3mm L 58mm temperatura ambiente max. 85°C interasse di fissaggio 22mm tipo D42X forza di azionamento: 6g lunghezza leva 44mm		



codice	345368	cod. costr.	90/82010000
descrizione	microinterruttore con leva 250V 10A 1CO attacco Faston maschio temperatura ambiente max. 85°C		

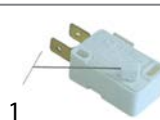

codice	345367	cod. costr.	30/10320000
descrizione	microinterruttore con leva 250V 6A 1CO attacco Faston maschio 6,3mm L 113mm temperatura ambiente max. 85°C interasse di fissaggio 22mm forza di azionamento: 40g		

interruttori a galleggiante



codice	379653	cod. costr.	3010024000 3010024500 9090611000
descrizione	interruttore a galleggiante 1CO L 90mm incasso ømm 250V 3A Faston maschio 6,3mm lunghezza del cavom tipo D42X temperatura ambiente max. 85°C con galleggiante per MP		



1

codice	347248	cod. costr.	90/90611000
descrizione	microinterruttore 1CO 250V 3A attacco Faston maschio 6,3mm con galleggiante tipo D42X temperatura ambiente max. 85°C lunghezza leva 90mm per MP		



1

codice	348026	cod. costr.	3010024500 (alt) 90/90612000
descrizione	interruttore a galleggiante kit 1CO ø 25mm L 73mm incasso ø 12mm 250V 10A Faston maschio 6,3mm lunghezza del cavo 1380mm		
ricambi per	348026		
	codice	380812	cod. costr. —
	relè di potenza FINDER 230VAC 30A 2CO attacco F6,3 fissabile con viti codice costr. 66.82.8.230.0000		

galleggianti



1

codice	348191	cod. costr.	4063018500
descrizione	galleggiante senza magneti ø 56mm L 135mm lar. 56mm H 95mm		



1

codice	348025	cod. costr.	90/20364000
descrizione	galleggiante senza magneti ø 84mm L 84mm lar. 30mm H 25mm PVC		

relè



relè di potenza

con contatti maschi

contatto a spina 2,0mm



1

codice	380494	cod. costr.	—
descrizione	relè di potenza FINDER 230VAC 7A 4CO attacco F2 a spina codice costr. 55.34.8.230.0054 94.74/ZMD4 250V attacco 2mm		
accessori per	380494		
	codice	380341	cod. costr. —
	zoccolo di relè 4 poli contatti 12 300V tensione AC 6A Italiana Relè codice costr. ZMD4		
	codice	380399	cod. costr. —
	zoccolo di relè 4 poli dimensioni 76,2x27x86,1mm 250V tensione AC 1A FINDER codice costr. 94.94.3		

elettronica

schede elettroniche



1

codice	403468	cod. costr.	30/50048000
descrizione	scheda di servizio produttore di ghiaccio MG14 L 49mm lar. 25mm adattabile a STAFF ICE lunghezza del cavo 1400mm conf. 1 pz		

elettrovalvole

elettrovalvole per acqua

ELBI

ricambi e accessori

riduzioni

uscita











1

codice	371262	cod. costr.	4012008000
descrizione	riduzione ELBI tipo EATON (INVENSYS) quota portata 2.5l/min campo di pressione da 0 a 10bar tolleranza ±15/25% arancione		

			
1			
codice	371260	cod. costr.	40/12005000
descrizione	riduzione tipo ELBI quota portata 0.5l/min campo di pressione da 0 a 10bar tolleranza ±15/25% rosso		

RPE			
			
1			
codice	374021	cod. costr.	4012022000
descrizione	elettrovalvola doppio dritta 230VAC entrata 3/4" uscita 10mm DN10 RPE		

TP			
			
1			
codice	370017	cod. costr.	4012012000
descrizione	elettrovalvola singolo dritta 230VAC entrata 3/4" uscita 11,5mm DN10 TP p max 10bar		
ricambi per	370017		
	codice	371013	cod. costr. —
	bobina magnetica TP 230VAC 50/60Hz		
accessori per	370017		
	codice	371220	cod. costr. —
	riduzione TP quota portata 3l/min rosso tolleranza ±15%		
	codice	371221	cod. costr. —
	riduzione TP quota portata 5.5l/min giallo tolleranza ±15%		
	codice	371222	cod. costr. —
	riduzione TP quota portata 6l/min grigio tolleranza ±15%		
	codice	371223	cod. costr. —
	riduzione TP quota portata 10l/min bianco tolleranza ±15%		
	codice	371224	cod. costr. —
	riduzione TP quota portata 12l/min bronzo tolleranza ±15%		
	codice	371225	cod. costr. —
	riduzione TP quota portata 16l/min marrone chiaro tolleranza ±15%		
	codice	371226	cod. costr. —
	riduzione TP quota portata 20l/min rosso tolleranza ±15%		

accessori per	370017		
	codice	371230	cod. costr. —
	riduzione TP quota portata 0.25l/min rosso tolleranza ±25%		
	codice	371231	cod. costr. —
	riduzione TP quota portata 0.35l/min viola tolleranza ±25%		
	codice	371232	cod. costr. —
	riduzione TP quota portata 0.5l/min arancione tolleranza ±25%		
	codice	371233	cod. costr. —
	riduzione TP quota portata 0.8l/min bianco tolleranza ±25%		
	codice	371234	cod. costr. —
	riduzione TP quota portata 1l/min celeste tolleranza ±25%		
	codice	371235	cod. costr. 4012006000
	riduzione TP quota portata 1.2l/min marrone tolleranza ±25%		
	codice	371236	cod. costr. —
	riduzione TP quota portata 1.5l/min marrone chiaro tolleranza ±25%		
	codice	371237	cod. costr. —
	riduzione TP quota portata 2.5l/min giallo tolleranza ±25%		
	codice	371238	cod. costr. —
	riduzione TP quota portata 3.4l/min verde scuro tolleranza ±25%		
	codice	371239	cod. costr. —
	riduzione TP quota portata 5l/min nero tolleranza ±25%		
	codice	371240	cod. costr. —
	riduzione TP quota portata 8l/min blu tolleranza ±20%		

ricambi e accessori
riduzioni
uscita

			
1			
codice	371235	cod. costr.	4012006000
descrizione	riduzione TP quota portata 1.2l/min marrone tolleranza ±25%		



in metallo

CEME

accessori



1

codice	371154	cod. costr.	951342 SL300951342
descrizione	bobina magnetica attacco Faston maschio 6,3mm CEME 50Hz 230V H 30mm alloggiamento ø 10mm tensione AC		

elettrovalvole per la refrigerazione

varie

corpi valvola



1

codice	381437	cod. costr.	4011020000
descrizione	corpo elettrovalvola singolo tipo CLS 2,5 p maxbar campo di pressionebar attacco 6mm		

pressostati

per refrigerazione

SAGI NO MIYA



1

codice	541479	cod. costr.	4006013000
descrizione	pressostato HD reset automatico refrigerazione tipo HTB-X114 attacco 2,4mm		

ventilatori

ventilatori per aria fredda

motori per raffreddamento universali

accessori

ventole

alluminio



1

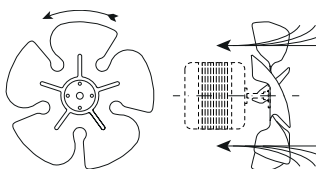

codice	601387	cod. costr.	000233
descrizione	ventola aspirante ø 254mm fissaggio ventola 25.4mm inclinazione delle pale 34° lar. 50mm alluminio		

motori

motoriduttori

per produttori di ghiaccio

per palette



1

codice	501451	cod. costr.	90/82011000 908201100
descrizione	motore FIBER tipo G025JAMAF00 3.9W 230V 50/60Hz 40rpm albero ø 12mm per produttore di ghiaccio tipo di motore M51BJ0R0000		
accessori per	501451		



codice	500418	cod. costr.	90/20372000
descrizione	supporto per motoriduttore		

1

codice	500416	cod. costr.	90/82013000
descrizione	motoriduttore		



1

codice	501550	cod. costr.	9082013500
descrizione	motoriduttore MECHTEX tipo GB5F 12X 3.9W 230V 50Hz 50rpm albero ø 12mm per produttore di ghiaccio		



1

codice	500415	cod. costr.	90/82014000
descrizione	motoriduttore FIBER tipo G0251AMAKOO 12V 50/60Hz 30rpm albero ø 12mm L 76mm lar. 52mm H 37mm tipo di motore M51B10R0000		



1

codice	501549	cod. costr.	9082010500
descrizione	motoriduttore MECHTEX tipo GB5F 15 230V 50Hz 40rpm albero ø 12mm senso di rotazione in senso orario		



1

codice	500991	cod. costr.	3004010000
descrizione	motoriduttore FIBER tipo GE15JAMAD00 3.9W 230V 50/60Hz 50rpm albero ø 12mm per produttore di ghiaccio tipo di motore M51B-J0R0000		
accessori per	500991		
	codice	cod. costr.	90/20372000
	supporto per motoriduttore		

per vasche



1

codice	500402	cod. costr.	90/82020000
descrizione	motoriduttore KENTA tipo IC9113065 69W 230V 50Hz 2rpm albero ø 14mm lar. 60mm H 150mm L 150mm		



1

codice	500420	cod. costr.	90/82012000
descrizione	motoriduttore FIBER tipo W0100ALAD00 230V 50Hz 5rpm albero ø 12mm L 52mm lar. 76mm H 52mm tipo di motore M353		

altri



1

codice	500403	cod. costr.	90/82016000
descrizione	motoriduttore AUTOM 230V 50Hz albero ø 8mm L 240mm lar. 130mm H 60mm		



per distributori di bevande



1

codice	499305	cod. costr.	950212 SL300950212
descrizione	motoriduttore ELCO 70/60W 230V tensione AC 50/60Hz 32/38rpm albero ø 6x12mm L 225mm lar. 75mm H 100mm per distributore bevande		

pompe

pompe per produttori di ghiaccio a cubet-



1

codice	501465	cod. costr.	30/02021000 9082101000
descrizione	pompa FIR tipo 4262/48 110W 230V 50/60Hz entrata ø 17mm uscita ø 17mm L 210mm condensatore 5µF		

ricambi per apparecchiature speci-
fiche

per produttori di ghiaccio

riduttori di giri

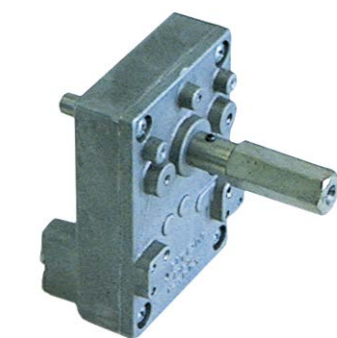

1

codice	500404	cod. costr.	30/05900000
descrizione	riduttore di giri		

porte

porte



1

codice	694708	cod. costr.	90/90852700
descrizione	porta per produttore di ghiaccio lar. 275mm H 223mm spessore 29mm nero		

meccanica per vaschette

ricambi e accessori



1

codice	694707	cod. costr.	90/20317000
descrizione	leva per vaschetta L 235mm lar. 40mm H 74mm adattabile a STAFF ICE		



1

codice	695001	cod. costr.	90/70331500
descrizione	palette con albero		



1

codice	695002	cod. costr.	90/70331700
descrizione	palette con albero		





1

codice	695003	cod. costr.	70331800
descrizione	palette con albero		





meccanica per evaporatori			
varie			
			
1			
codice	696722	cod. costr.	951752 SL300951752
descrizione	boccola per evaporatore		

tubi			
attacchi per tubi			
con filettatura			
			
1			
codice	695052	cod. costr.	40/41319000
descrizione	attacco per tubo		
ricambi per	695052		
	codice	516026	cod. costr. —
	O.R. EPDM spessore 2.62mm int. ø 17.86mm conf. 1 pz		
	codice	516109	cod. costr. —
	pilletta di scarico int. ø 23mm		
	codice	516110	cod. costr. —
	attacco per tubo tubo ø 23mm		

galleggianti			
contenitori galleggianti			
			
1			
codice	695073	cod. costr.	90/87016000
descrizione	contenitore galleggianti		
ricambi per	695073		
	codice	346872	cod. costr. —
	microinterruttore con leva 250V 0.1A 1CO attacco Faston maschio 6,3mm L 50mm temperatura ambiente max. 85°C interasse di fissaggio 22mm tipo D41X forza di azionamento: 6g lunghezza leva 36mm		

varie			
			
1			
codice	695043	cod. costr.	90/20319000 90/78054000
descrizione	leva		

			
1			
codice	694709	cod. costr.	90/20352000
descrizione	supporto per produttore di ghiaccio lar. 18mm H 27mm fori ø 8mm		

per distributori di bevande			
bussole			
			
1			
codice	650245	cod. costr.	SL340001653
descrizione	boccola per evaporatore H 30mm ø 35.5mm D2 ø 21mm		

guarnizioni			
			
1			
codice	650220	cod. costr.	SL300951857 SL320001630
descrizione	guarnizione per coclea D1 ø 34.5mm D2 ø 26mm int. ø 20mm H 19mm gomma		

			
1			
codice	650164	cod. costr.	950070 SL3GS36007B
descrizione	guarnizione per evaporatore D1 ø 170mm int. ø 160mm H 13mm silicone		

			
1			
codice	650163	cod. costr.	SL300950258 SL3GS12044A SL3GS24044A
descrizione	guarnizione per rubinetto scarico D1 ø 25mm D2 ø 16mm H 21mm silicone		

per lavastoviglie

meccanica per porte

chiusure



1

codice	507011	cod. costr.	20/62150000
descrizione	chiusura completo scrochetto porta		

cerniere

cuscinetto porte



1

codice	701167	cod. costr.	9016047900
descrizione	supporto rotazione L 67mm lar. 22mm H 8.5mm pos. di montaggio inferiore dx spessore 1mm		

guarnizioni

O.R.

EPDM



1

codice	510072	cod. costr.	RICG20141
descrizione	O.R. EPDM spessore 3.53mm int. ø 32.93mm conf. 1 pz		

silicone



1

codice	532250	cod. costr.	950194 SL300950194
descrizione	O.R. silicone spessore 2.62mm int. ø 17.13mm conf. 10 pz		

organi di trasmissione e cuscinetti

cuscinetti

varie



Nessuna immagine disponibile

1

codice	691226	cod. costr.	20/08105000
descrizione	cuscinetto a sfere		



Nessuna immagine disponibile

1

codice	691227	cod. costr.	20/08110000
descrizione	cuscinetto a sfere		

cinghie di trasmissione

cinghie trapezoidali

profilo Z/10



1

codice	697686	cod. costr.	20/05010000
descrizione	cinghia trapezoidale larghezza cinghia 10mm L 520mm H 6mm CODE Z20 1/2 profilo Z/10		



1

codice	691224	cod. costr.	20/05011000
descrizione	cinghia trapezoidale larghezza cinghia 10mm L 635mm H 6mm CODE Z25 profilo Z/10		



1

codice	691225	cod. costr.	20/05012000
descrizione	cinghia trapezoidale larghezza cinghia 10mm L 710mm H 6mm CODE Z28 profilo Z/10		



componenti di fissaggio

fissaggi			
seeger			
DIN 471			
1			
codice	523107	cod. costr.	SL300950254
descrizione	seeger albero ø 11mm spessore 1mm inox DIN 471		

C	
componenti di fissaggio	11
E	
elettrovalvole	4
F	
fissaggi	11
I	
interruttori a galleggiante	3
interruttori e pulsanti	3
M	
microinterruttori	3
motori	6
motori per raffreddamento universali	6
O	
O.R.	10
P	
pompe	8
pompe per produttori di ghiaccio a cubetti	8
pressostati	6
R	
relè	4
resistenze	3
S	
seeger	11
T	
termostati	3
termostati per frigoriferi	3
V	
ventilatori	6
ventilatori per aria fredda	6